

# vtech®

Innovation Beyond Technology™

## User's manual

[www.vtechphones.com](http://www.vtechphones.com)

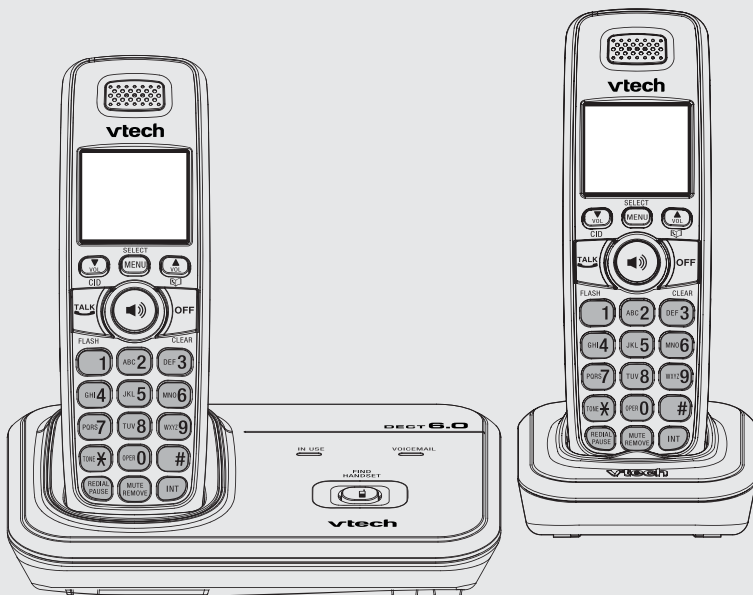

Models:  
CS6319/CS6319-2

**DECT 6.0**

# Congratulations

on purchasing your new VTech product. Before using this telephone, please read the **Important safety instructions** on page xx of this manual.

This manual has all the feature operations and troubleshooting necessary to install and operate your new VTech telephone. Please review this manual thoroughly to ensure proper installation and operation of this innovative and feature rich VTech product. For support, shopping, and everything new at VTech, visit our website at [www.vtechphones.com](http://www.vtechphones.com). In Canada, please visit [www.vtechcanada.com](http://www.vtechcanada.com).



The ENERGY STAR<sup>®</sup> program ([www.energystar.gov](http://www.energystar.gov)) recognizes and encourages the use of products that save energy and help protect our environment. We are proud to mark this product with the ENERGY STAR<sup>®</sup> label indicating it meets the latest energy efficiency guidelines.



Telephones identified with this logo have reduced noise and interference when used with most T-coil equipped hearing aids and cochlear implants. The TIA-1083 Compliant Logo is a trademark of the Telecommunications Industry Association. Used under license.

# Table of contents

<b>Getting started</b> .....	1	Find handset.....	14
Parts checklist.....	1	Chain dialing.....	15
Telephone base and charger installation.....	2	Multiple handset use .....	16
Battery installation and charging .....	3	Intercom .....	16
Installation options .....	4	Answer an incoming call during an intercom call.....	16
Table top to wall mount installation .....	4	Share an outside call.....	17
Wall mount to table top installation.....	5	Directory.....	18
Handset layout .....	6	Store a directory entry.....	19
Telephone base layout .....	7	Character chart .....	20
<b>Telephone settings</b> .....	8	Search the directory.....	21
Ringer volume (handset).....	8	Alphabetical search.....	21
Ringer tone.....	8	Dial a directory entry .....	21
Key tone .....	8	Edit a directory entry .....	22
LCD language .....	9	Delete from the directory.....	22
Set date/time .....	9	About caller ID.....	23
Clear voicemail.....	10	Call log .....	24
Home area code.....	10	Missed calls indicator .....	24
<b>Answering system settings</b> ....	11	Review the call log .....	25
Answering system set up .....	11	Make a call log entry ready to dial .....	25
Number of rings.....	11	Dial a call log entry .....	26
Remote code .....	11	Save a call log entry to the directory .....	26
Message alert tone.....	11	Delete from the call log .....	26
Announcement .....	12	Call log display screen messages.....	27
Play your announcement .....	12	Redial list.....	27
Record your own announcement .....	12	Dial a redial entry .....	27
Delete your announcement .....	12	Delete from redial.....	27
<b>Telephone operation</b> .....	13	<b>Answering system operation</b> ...28	
Make a call .....	13	Answering system and voicemail.....	28
Redial a call.....	13	Message capacity .....	28
Answer a call.....	13	Turn the answering system on or off.....	29
End a call.....	13	Call screening .....	29
Speakerphone .....	13	Call intercept .....	29
Volume .....	13	Telephone base ringer volume...29	
Mute .....	14	New message indication .....	30
Ringer mute.....	14	Message playback .....	30
Call waiting.....	14	Delete all messages.....	31

## Table of contents

Record and play memos .....	31
Record a memo.....	31
Message window displays.....	32
Remote access .....	33
<b>Appendix.....</b>	<b>34</b>
Handset display screen messages.....	34
Handset and telephone base indicators .....	36
Battery.....	37
Expand your telephone system...	38
Add and register a handset (optional).....	38
Replace a handset .....	39
Troubleshooting.....	40
Important safety instructions.....	46
Operating range .....	47
Maintenance.....	47
About cordless telephones.....	48
The RBRC® seal.....	48
Warranty .....	49
FCC, ACTA and IC regulations ...	51
Technical specifications .....	53
<b>Index.....</b>	<b>54</b>

# Getting started

## Parts checklist

Your telephone contains the following items. Save your sales receipt and original packaging in the event warranty service is necessary.

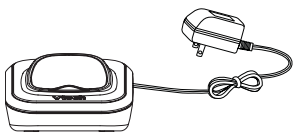

Charger and charger adapter  
(1 for CS6319-2)



Handset  
(1 for CS6319 and  
2 for CS6319-2)

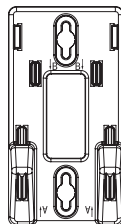

Wall bracket

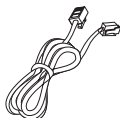

Telephone line cord

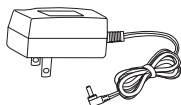

Telephone base  
power adapter

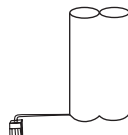

Battery  
(1 for CS6319 and  
2 for CS6319-2)



Battery compartment  
cover  
(1 for CS6319 and  
2 for CS6319-2)

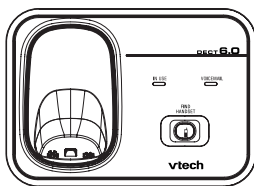

Telephone base

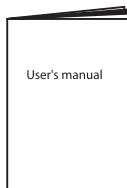

User's manual

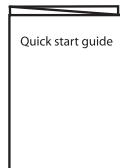

Quick start guide

### note

To purchase replacement batteries or power adapters, visit our website at [www.vtechphones.com](http://www.vtechphones.com) or call 1 (800) 595-9511. In Canada, go to [www.vtechcanada.com](http://www.vtechcanada.com) or call 1 (800) 267-7377.

# Getting started

## Telephone base and charger installation

Install the telephone base and charger(s) as shown below.

Make sure that the electrical outlet is not controlled by a wall switch.

If you subscribe to digital subscriber line (DSL) high-speed Internet service through your telephone line, you must install a DSL filter between the telephone line cord and the telephone wall jack. The filter prevents noise and caller ID problems caused by DSL interference. Contact your DSL service provider for more information about DSL filters.

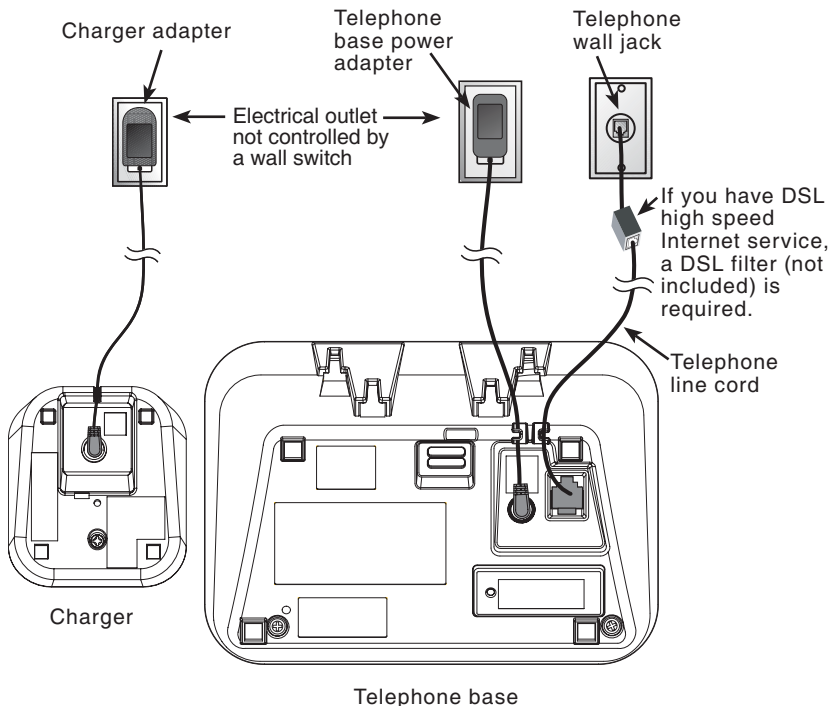

### note

- Use only the power adapters supplied with this product. To order a replacement, visit our website at [www.vtechphones.com](http://www.vtechphones.com) or call 1 (800) 595-9511. In Canada, go to [www.vtechcanada.com](http://www.vtechcanada.com) or call 1 (800) 267-7377.
- The power adapters are intended to be correctly oriented in a vertical or floor mount position. The prongs are not designed to hold the plug in place if it is plugged into a ceiling or an under-the-table/cabinet outlet.

# Getting started

## Battery installation

Install the battery as shown below.

1. If the battery compartment cover is on the handset, press on the indentation and slide the cover to remove.
2. Plug the battery connector securely into the socket inside the handset battery compartment, matching the color-coded label.
3. Place the battery with the label **THIS SIDE UP** facing up and the wires inside the battery compartment.
4. Align the cover flat against the battery compartment, then slide it towards the center of the handset until it clicks into place.
5. Charge the handset by placing it in the telephone base or charger. The **CHARGE** light is on when the handset charges.

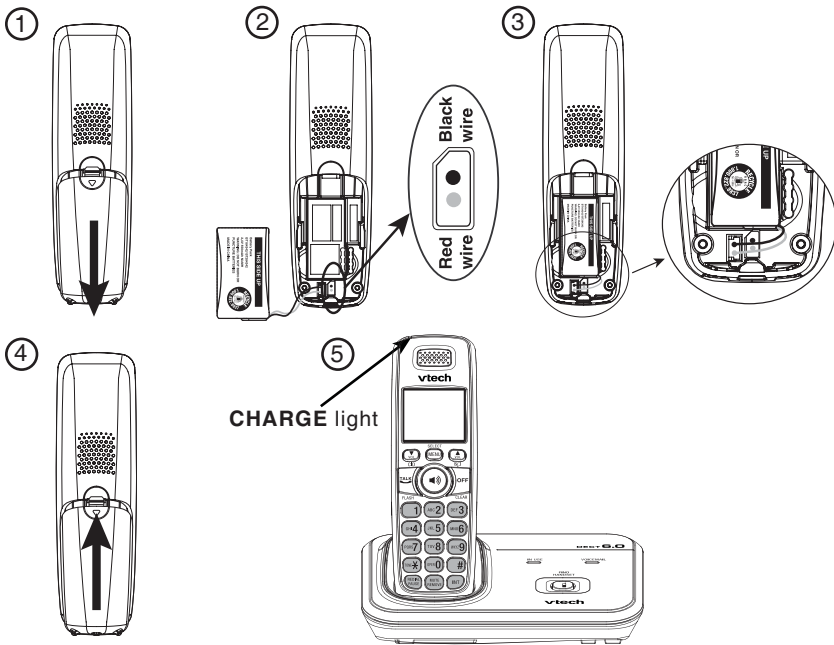

### note

- If the handset will not be used for a long time, disconnect and remove the battery to prevent possible leakage.
- To purchase replacement batteries, visit our website at [www.vtechphones.com](http://www.vtechphones.com) or call 1 (800) 595-9511. In Canada, go to [www.vtechcanada.com](http://www.vtechcanada.com) or call 1 (800) 267-7377.



# Getting started

## Battery charging

Once you have installed the battery, the screen indicates the battery status (see the table below). If necessary, place the handset in the telephone base or charger to charge the battery. For best performance, keep the handset in the telephone base or charger when not in use. The battery is fully charged after 16 hours of continuous charging. See the table on page 40 for battery operating times.

If the screen is blank, you need to charge the handset without interruption for at least 10 minutes to give the handset enough charge to use the telephone for a short time. The handset beeps and shows **LOW BATTERY**. If you are on a call in low battery mode, the handset beeps every minute.

The following table summarizes the battery charge indicators and actions to take.

Battery indicators	Battery status	Action
The screen is blank.	Battery has no charge and the handset cannot be used.	Charge without interruption until the screen shows <b>LOW BATTERY</b> (at least 10 minutes).
The screen shows <b>PLACE IN CHARGER</b> and  flashes.	Battery has very little charge and the handset cannot be used.	Charge without interruption until the screen shows <b>LOW BATTERY</b> (at least four minutes).
The screen shows <b>LOW BATTERY</b> ,  flashes, and the handset beeps.	Battery has enough charge to be used for a short time.	Charge without interruption until the screen shows <b>HANDSET X</b> (about one hour).
The screen shows <b>HANDSET X</b> .	Battery is charged.	To keep the battery charged, place it in the telephone base or charger when not in use.



# Getting started

## Installation options

Your telephone base is ready for table top use. **If you want to mount your telephone on a wall, use the provided wall bracket to connect with a standard dual-stud telephone wall mounting plate.** If you do not have this mounting plate, you can purchase one from many hardware or consumer electronics retailers. You might need a professional to install the mounting plate.

### Table top to wall mount installation

1. Position the telephone base as shown below. Insert the extended tabs (marked **B**) of the wall bracket into the slots on the back of the telephone base (marked **B**). Push the telephone base down until it is securely in place.
2. If you are using a DSL filter, plug the line cord into the filter now. Route the telephone line cord (or DSL filter) through the wall bracket hole. Route the power cord out of the bottom of the telephone.
3. Plug the telephone line cord (or DSL filter) into the wall jack. Plug the power adapter into a power outlet not controlled by a wall switch.
4. Align the holes on the bracket with the standard wall plate and slide the bracket down until it locks securely. Bundle the telephone line cord and power adapter cord neatly with a twist tie.

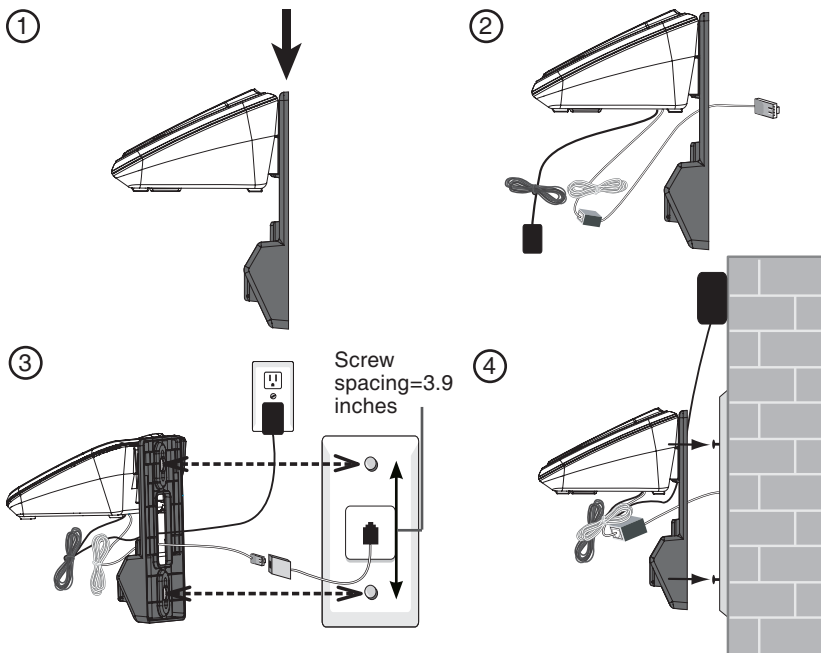

## Getting started

### Wall mount to table top installation

1. If the telephone line cord and power adapter cord are bundled, untie them first.
2. Lift the telephone base up to detach it from the black plastic wall bracket. Unplug the telephone line cord (or DSL filter) from the wall. Unplug the power adapter from the power outlet.
3. See **Telephone base and charger installation** on page 2.

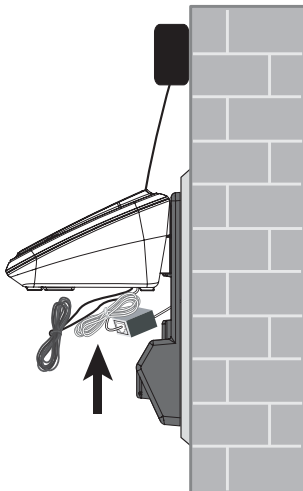

# Getting started

## Handset layout

### CHARGE light

On when the handset is charging in the telephone base or charger (page xx).

### ▲ VOL/ (volume/directory)

Press to enter the directory when the telephone is not in use (page xx).

While in a menu, press to scroll up.

During a call, press to raise the listening volume (page xx).

### (speakerphone)

Press to switch between speakerphone and handset (page xx).

### TALK/FLASH

Press to make or answer a call (page xx).

During a call, press to receive an incoming call when you receive a call waiting alert (page xx).

### 1

While reviewing a call log entry, press repeatedly to add or remove 1 in front of the telephone number before dialing or saving it in the directory (page xx).

### REDIAL/PAUSE

Press to review the redial list (page 30).

While dialing or entering numbers into the directory, press and hold to insert a dialing pause (page 21).

### ▼ VOL/CID (caller ID/volume)

Press to review the call log when the telephone is not in use (page 28).

While in a menu, press to scroll down.

During a call, press to lower the listening volume (page 15).

### MENU/SELECT

Press to show the menu.

While in a menu, press to select an item, or save an entry or setting.

### OFF/CLEAR

During a call, press to hang up (page 15).

While the handset is ringing, press to silence the ringer temporarily (page 16).

Press and hold while the telephone is not in use to erase the missed calls indicator (page 27).

During programming, press to exit without making changes.

### #

Press repeatedly to show other dialing options when reviewing a call log entry (page 28).

### INT (intercom)

Press to initiate an intercom conversation or transfer a call (page 18).

### MUTE/REMOVE

While on a call, press to mute the microphone (page 16).

While reviewing the call log, directory or redial list, press to delete an individual entry (page 29, page 25 and page 30, respectively).

Press to delete digits when predialing (page 15).

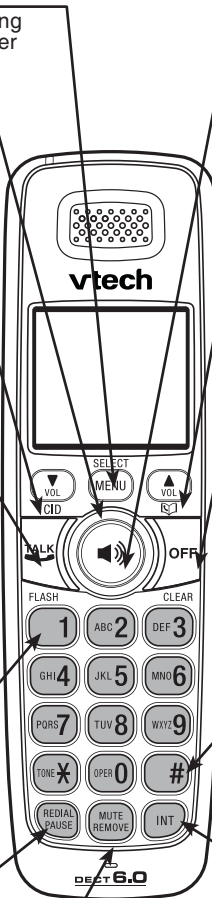

# Getting started

## Telephone base layout

### **IN USE** light

Flashes when there is an incoming call, or another telephone sharing the same line is in use.

On when the handset is in use.

### **VOICEMAIL** light

Flashes when you have new voicemail. Voicemail service is offered by your local telephone company, and is different from answering system messages (page 11).

### **FIND HANDSET**

Press to page all system handsets.

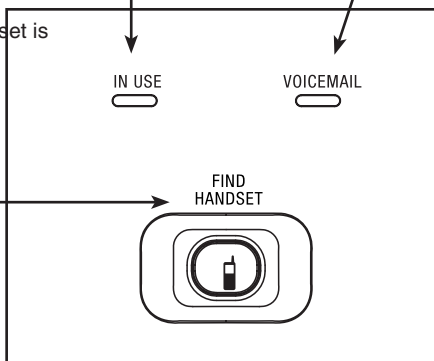

# Telephone settings

## Ringer volume (handset)

You can set the ringer volume or turn the ringer off.

1. Press **MENU/SELECT** to show the menu when the handset is not in use.
2. Press **▲** or **▼** to select **>Ringers**, then press **MENU/SELECT**.
3. Press **▲** or **▼** to select **>Ringer volume**, then press **MENU/SELECT**.
4. Press **▲** or **▼** to adjust the volume. A sample of each ringer volume plays as you scroll through the choices.
5. Press **MENU/SELECT** to confirm your selection.



### note

- Setting the volume to the lowest level turns off the ringer. A ringer off icon  appears.
- See page xx to set the telephone base ringer volume.
- The setting also determine the ringer volume of the intercom call and paging tone. However, paging volume ranges between level 4 to 5 only, therefore, if the ringer volume is set to below level 4, the paging volume will be set to level 4 automatically.

## Ringer tone

You can choose from different ringer tones or melodies.

1. Press **MENU/SELECT** to show the menu when the handset is not in use.
2. Press **▲** or **▼** to select **>Ringers**, then press **MENU/SELECT**.
3. Press **▲** or **▼** to select **>Ringer tone**, then press **MENU/SELECT**.
4. Press **▲** or **▼** to select the desired ringer tone or melody. A sample of each ringer tone or melody plays as you scroll through the choices.
5. Press **MENU/SELECT** to confirm your selection.

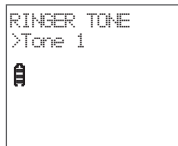

### note

If you turn off the ringer volume, you will not hear ringer tone samples.

# Telephone settings

## Key tone

You can turn the key tone on or off.

1. Press **MENU/SELECT** to show the menu when the handset is not in use.
2. Press **▲** or **▼** to select **>Settings**, then press **MENU/SELECT**.
3. Press **▲** or **▼** to select **>Key tone**, then press **MENU/SELECT**.
4. Press **▲** or **▼** to choose **On** or **Off**.
5. Press **MENU/SELECT** to confirm your selection.

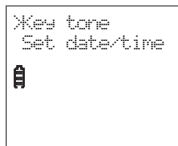

## LCD language

You can select **English**, **Français** or **Español** to be used in all screen displays.

1. Press **MENU/SELECT** to show the menu when the handset is not in use.
2. Press **▲** or **▼** to select **>Settings**, then press **MENU/SELECT**.
3. Press **▲** or **▼** to select **>LCD language**, then press **MENU/SELECT**.
4. Press **▲** or **▼** to scroll through the choices.
5. Press **MENU/SELECT** to confirm your selection.

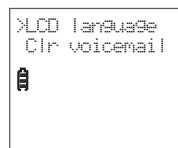

## Set date/time

The answering system announces the day and time of the message prior to playing it. Before using the answering system, set the date and time as follows. If you subscribe to caller ID service, the day, month and time are set automatically with each incoming call. However, the year must be correct so that the day of the week can be calculated from the caller ID information.

1. Press **MENU/SELECT** to show the menu when the handset is not in use.
2. Press **▲** or **▼** to select **>Settings**, then press **MENU/SELECT**.
3. Press **▲** or **▼** to select **>Set date/time**, then press **MENU/SELECT**.
4. Press the dialing keys (**0-9**) to enter a two-digit number or press **▼** or **▲** until the screen displays the correct value. Press **MENU/SELECT** to advance.
5. Repeat step 3 until the date and time are set.

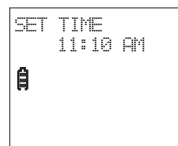
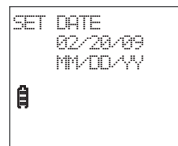
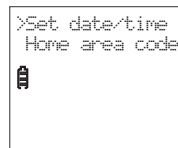

## Telephone settings

### note

If the date and time are not set, the system announces, “*Time and day not set,*” before each message plays.

### Clear voicemail

If you subscribe to voicemail service offered by your telephone company, **NEW VOICEMAIL** and  appear on the handset when you have new voicemail messages. Contact your local telephone company for more information and assistance about using your voicemail service.

After you have listened to all new voicemail messages, the indicators on the handset turn off automatically.

Use the clear voicemail feature when the telephone indicates that there is new voicemail but there is none (for example, when you have accessed your voicemail while away from home). Clearing the voicemail waiting indicator only turns off the indicators; it does not delete your voicemail messages. As long as you have new voicemail messages, your local telephone company continues to send the signal to turn on the indicators.

To manually turn off these indicators:

1. Press **MENU/SELECT** to show the menu when the handset is not in use.
2. Press **▲** or **▼** to select **>Settings**, then press **MENU/SELECT**.
3. Press **▲** or **▼** to select **>Clr voicemail**, then press **MENU/SELECT**. The screen shows **Turn off indicator?**  
Press **MENU/SELECT** to confirm your selection.

### note

- Your telephone service provider might alert you to new messages with a stutter (broken) dial tone. Contact your service provider for details.
- Voicemail is different from answering system messages recorded in your answering system. For more information about the difference, see page 31.

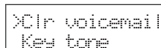

>Clr voicemail  
Key tone

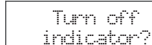

Turn off  
indicator?



# Telephone settings

## Home area code

If you dial your local calls using only seven digits (area code not required), you can program your home area code so that when you receive a call within your local area, the telephone number is automatically stored without the area code in the call log.

1. Press **MENU/SELECT** to show the menu when the handset is not in use.
2. Press **▲** or **▼** to select **>Settings**, then press **MENU/SELECT**.
3. Press **▲** or **▼** to select **>Home area code**, then press **MENU/SELECT**.
4. Use the dialing keys to enter the desired home area code.
  - Press **MUTE/REMOVE** to delete a digit.
  - Press and hold **MUTE/REMOVE** to delete the entire entry.
4. Press **MENU/SELECT** to confirm.

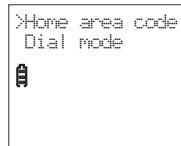

### note

If, in the future, your telephone company requires you to dial the area code when making a local call, or, if you move to a location that requires it, delete the home area code you have already programmed, following the steps above. After you have deleted the home area code, \_ \_ \_ will appear in the display.

## Dial mode

You can choose between tone or pulse dialing mode.

1. Press **MENU/SELECT** to show the menu when the handset is not in use.
2. Press **▲** or **▼** to select **>Settings**, then press **MENU/SELECT**.
3. Press **▲** or **▼** to select **>Dial mode**, then press **MENU/SELECT**.
4. Press **▲** or **▼** to choose **Tone** or **Pulse**.
5. Press **MENU/SELECT** to confirm your selection.

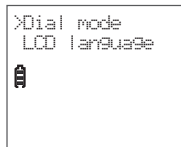



# Answering system settings

## Answering system set up

Use a system handset to change your answering system settings.

### Number of rings

You can choose from two, four, or six rings; or toll saver. With toll saver selected, the answering system answers after two rings when you have new messages, and after four rings when you have no new messages. This enables you to check for new messages and avoid paying unnecessary long distance charges if you are calling from out of your local area.

1. Press **MENU/SELECT** to show the menu when the handset is not in use.
2. Press **MENU/SELECT** to select **>Answering Sys.**
3. Press **▲** or **▼** to select **>Ans sys setup**, then press **MENU/SELECT**.
4. Press **▲** or **▼** to select **># of rings**, then press **MENU/SELECT**.
5. Press **▲** or **▼** to choose from **2, 4, 6** or **TOLL SAVER**, then press **MENU/SELECT** to confirm your selection.

### Remote code

A two-digit security code is required to access the answering system remotely from any touch tone telephone. The preset code is **19**. You can set the code from **10** to **99**.

1. Press **MENU/SELECT** to show the menu when the handset is not in use.
2. Press **MENU/SELECT** to select **>Answering Sys.**
3. Press **▲** or **▼** to select **>Ans sys setup**, then press **MENU/SELECT**.
4. Press **▲** or **▼** to select **>Remote code**, then press **MENU/SELECT**.
5. Press **▲** or **▼** to select from **10** to **99**, then press **MENU/SELECT** to confirm.

### Message alert tone

This telephone can beep every 10 seconds to alert you of new messages. The tone stops when all new messages have been reviewed.

1. Press **MENU/SELECT** to show the menu when the handset is not in use.
2. Press **MENU/SELECT** to select **>Answering Sys.**
3. Press **▲** or **▼** to select **>Ans sys setup**, then press **MENU/SELECT**.
4. Press **▲** or **▼** to select **>Msg alert tone**, then press **MENU/SELECT**.
5. Press **▲** or **▼** to select from **On** or **Off**, then press **MENU/SELECT** to confirm your selection.

#### note

- The answering system must be turned on for the message alert tone to function.
- Press any key on the telephone base (except **FIND HANDSET**) to temporarily silence the message alert tone.

# Answering system settings

## Announcement

The telephone is preset with a greeting that answers calls with *“Hello, please leave a message after the tone.”* You can use this preset announcement, or replace it with your own.

## Play your announcement

1. Press **MENU/SELECT** to show the menu when the handset is not in use.
2. Press **MENU/SELECT** to select **>Answering Sys.**
3. Press **▲** or **▼** to select **>Announcement**, then press **MENU/SELECT**.
4. The handset announces, *“To play, press 2. To record, press 7.”* Press **2** to play.

## Record your own announcement

1. Press **MENU/SELECT** to show the menu when the handset is not in use.
2. Press **MENU/SELECT** to select **>Answering Sys.**
3. Press **▲** or **▼** to select **>Announcement**, then press **MENU/SELECT**.
4. The handset announces, *“To play, press 2. To record, press 7.”* Press **7** to record.
5. The handset announces, *“Record after the tone. Press 5 when you are done.”*
6. After the tone, speak towards the microphone of the handset.
7. Press **5** when finished.
8. The answering system automatically plays back the newly recorded announcement. Press **5** to stop the playback at anytime; **2** to replay the recorded announcement; or **7** to record again if desired.

### note

- Your announcement can be up to 90 seconds in length.
- Announcements shorter than two seconds will not be recorded.

## Delete your announcement

1. Press **MENU/SELECT** to show the menu when the handset is not in use.
2. Press **MENU/SELECT** to select **>Answering Sys.**
3. Press **▲** or **▼** to select **>Announcement**, then press **MENU/SELECT**.
4. The handset announces, *“To play, press 2. To record, press 7.”* Press **3** to delete your own recorded announcement.

### note

When your announcement is deleted, calls are answered with the preset announcement.

# Telephone operation

## Make a call

1. Press **TALK/FLASH** or **📞**. You hear a dial tone.
2. Dial the number.

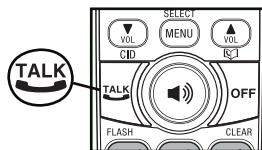

## Predial a call

1. Dial the number.
2. Press **TALK/FLASH** or **📞**.

## Answer a call

Press **TALK/FLASH**, **📞** or any of the dialing keys (**0-9, #, \***).

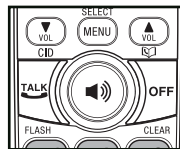

### note

- The screen shows the elapsed time as you talk (in hours, minutes and seconds).
- When predialing (preview numbers before dialing), press **MUTE/REMOVE** or **OFF/CLEAR** to backspace and delete; press and hold REDIAL/PAUSE to insert a dialing pause (a **p** appears).

## End a call

Press **OFF/CLEAR** or put the handset in the telephone base or charger.

## Speakerphone

During a call, press **📞** to switch between speakerphone and normal handset use. When the speakerphone is active, the handset screen shows **SPEAKER**.

## Volume

During a call, press **VOL▲** or **▼VOL** to adjust the listening volume.

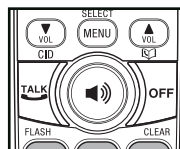

## Telephone operation

### Voice language (Canada only)

You can select **English** or **Français** for the voice prompts used in the answering system.

To change the setting:

1. Press **MENU/SELECT** to display the menu when the handset is not in use.
2. Press **MENU/SELECT** to select **>Answering Sys.**
3. Press **▲** or **▼** to select **>Ans sys setup**, then press **MENU/SELECT**.
4. Press **▲** or **▼** to select **>Voice language**, then press **MENU/SELECT**.
5. Press **▲** or **▼** to choose from **English** or **Français**, then press **MENU/SELECT** to confirm your selection.

### Chain dialing

Use this feature to initiate a dialing sequence from numbers stored in the directory, call log or redial while you are on a call.

Chain dialing can be useful if you wish to access other numbers (such as bank account information or access codes) from the directory, call log or redial list.

#### To access a number in the directory while on a call:

1. Press **MENU/SELECT** twice to select **>Directory**.
2. Scroll to the desired entry by pressing **▲** or **▼**.
3. Press **MENU/SELECT** to dial the displayed number.

#### To access a number in the call log while on a call:

1. Press **MENU/SELECT** and then press **▲** or **▼** to highlight **>Call log**.
2. Press **MENU/SELECT** to select.
3. Scroll to the desired entry by pressing **▲** or **▼**.
4. Press **MENU/SELECT** to dial the displayed number.

#### To access the last number on the redial list while on a call:

Press **REDIAL/PAUSE** to dial. Press **REDIAL/PAUSE** again within two seconds to cancel the chain dialing.

#### note

- You cannot edit a directory entry while on a call. For more details about the directory, see page 20.
- You cannot copy a call log entry into the directory while on a call. For more details about call log, see page 27.
- If you press **REDIAL/PAUSE** while on a call, you can only view the most recent call, and you cannot erase the entry. For more details about the redial memory, see page 30.
- Press and hold **OFF/CLEAR** to exit redial, directory or call log when you are on a call.

# Telephone operation

## Multiple handset use

You can use up to two system handsets at a time on an outside call. If a handset is already on a call and you would like to join the call, press **TALK/FLASH** or **Ⓜ** on another handset to join the call.

To end the call, press **OFF/CLEAR** or place the handset in the telephone base or charger. The call will not be terminated until all handsets hang up.

You can buy additional expansion handsets (model **CS6309**) for this telephone base. You can register up to five handsets to the telephone base.

## Intercom

Use the intercom feature for conversation between two system handsets.

1. Press **INT** on your handset when not in use.

- If you have a two-handset system, your handset screen shows **Calling other handset**.
- If you have more than two handsets, your screen shows **Intercom to:**. Use the dialing keys to select the other handset. Your handset screen shows **Calling handset X**.

The other handset rings and its screen shows either **Other handset is calling** or **Handset X is calling**.

2. To answer the intercom call, press **TALK/FLASH**, **Ⓜ**, **INT**, or any dialing keys (**0-9**, **#**, **\***) on the other handset. Both handsets now show **INTERCOM**.

3. To end an intercom call, press **INT**, **OFF/CLEAR**, or place the handset back in the telephone base or charger.

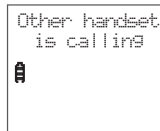
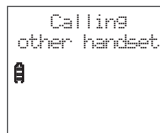

### note

- You can cancel the intercom call before it is answered by pressing **OFF/CLEAR** or **INT** on your originating handset.
- If the other handset does not answer the intercom call within 60 seconds, is in the directory or call log, or is out of range, your originating handset screen shows **Unable to call try again** and returns to idle mode.
- Press **OFF/CLEAR** or **MUTE/REMOVE** on the other handset to temporarily silence the intercom ringer.
- You can use a maximum of four handsets at a time. When two handsets are used on an intercom call, use two other system handsets for an outside call.

## Answer an incoming call during an intercom call

If you receive an incoming outside call during an intercom call, there will be an alert tone.

- To answer the call, press **TALK/FLASH**. The intercom call ends automatically.
- To end the intercom call without answering the incoming call, press **OFF/CLEAR**.

# Telephone operation

## Share an outside call

You can call another system handset to join an outside call. That call continues even if you hang up.

1. Press **MENU/SELECT** while on a call and then press **▲** or **▼** to highlight **>Transfer**.
2. Press **MENU/SELECT** to select. The outside call is put on hold.
  - If you have a two-handset system, your handset screen shows **Calling other handset**. The other handset rings and its screen shows **Other handset is calling**.
  - If you have more than two handsets, your screen shows **Transfer to:**. Use the dialing keys to select the other handset. Your screen then shows **Calling handset X**. The other handset rings and its screen shows **Handset X is calling**.
3. To answer the call on the other handset, press **TALK/FLASH**, **INT**, or any dialing keys (**0-9**, **#**, **\***). The outside call is still on hold and both handsets now show **INTERCOM**. You can now have a private conversation between the system handsets.



### note

- If you want to cancel an intercom call and reconnect to the outside call before the other handset answers, press **TALK/FLASH**, **OFF/CLEAR** or **INT** on your originating handset.
  - If the other handset does not answer the intercom call within 60 seconds, is in the directory or call log, or is out of range, your originating handset screen shows **Unable to call try again** and reconnects to the outside call automatically.
4. From this intercom call, you have the following options:
    - You can let the other handset join you on the outside call in a three-way conversation. Press and hold **INT** on your originating handset.
    - You can transfer the call. Press **OFF/CLEAR**, or place your handset back in the telephone base or charger. Your screen shows **Call transferred**. The other handset is automatically connected to the outside call.
    - You can alternate between the outside call (**OUTSIDE CALL** appears on the screen) and the intercom call (**INTERCOM** appears on the screen). Press **INT** repeatedly on your originating handset.
    - The other person can leave the intercom call by pressing **OFF/CLEAR**, or placing the other handset back in the telephone base or charger. The outside call continues with the original system handset.

# Telephone operation

## Directory

The directory can store up to 100 entries with up to 30 digits for each phone number and 15 characters for each name.

- Directory entries are shared by all system handsets. Any additions, deletions or edits made on one handset affect the directory on all handsets.
- When there are no records in the directory, the screen shows **Directory empty**.
- When the directory is full and you try to save an entry, the screen shows **Directory full**.
- If you try to save a number already stored in the directory, the screen shows **Already saved**.
- If the telephone number in the directory exceeds 15 digits, <\* appears in front of the telephone number. Press \* to move towards the end of the telephone number or press # to move towards the beginning of the telephone number.
- Only one handset can review the directory at a time. If a handset tries to enter the directory while another handset is already in it, **Not available at this time** appears.

Directory empty



Directory full



Already saved



ELIZABETH JONES  
<\*180012345678



ELIZABETH JONES  
<\* 800123456 #>



ELIZABETH JONES  
123456789012 #>



# Telephone operation

## Store a directory entry

Use the following steps to store an entry in the directory.

1. Enter the number when the handset is not in use and press **MENU/SELECT**.  
Go to step 4.

**-OR-**

1. Press **MENU/SELECT** when the handset is not in use.
2. Press **▲** or **▼** to select **>Directory** and then press **MENU/SELECT**.
3. Press **▲** or **▼** to select **>Add contact**, then press **MENU/SELECT**. The screen shows **ENTER NUMBER**.
4. Use the dialing keys to enter or modify the number.
  - Press **MUTE/REMOVE** to backspace and erase a digit.
  - Press and hold **MUTE/REMOVE** to erase the entire entry.
  - Press **▼** to move the cursor to the left or **▲** to the right.
  - Press and hold **REDIAL/PAUSE** to insert a dialing pause (a **p** appears).

**- OR-**

Copy a number from the redial list by pressing **REDIAL/PAUSE** and then **▲**, **▼** or **REDIAL/PAUSE** to select a number. Press **MENU/SELECT** to copy the number.

5. Press **MENU/SELECT** to move to the name. The screen shows **ENTER NAME**.
6. Use the dialing keys (see page 22) to enter the name.
  - Press **MUTE/REMOVE** to backspace and erase a character.
  - Press and hold **MUTE/REMOVE** to erase the entire entry.
  - Press **▼** to move the cursor to the left or **▲** to the right.
7. Press **MENU/SELECT** to confirm. The screen shows **Set Speed dial?**
  - To exit, press **OFF/CLEAR**.
  - To set speed dial, press **MENU/SELECT**. The first available slot displays or the first speed dial entry displays when there is no empty slot.
8. Press **▲** or **▼** to choose the desired slot or entry and press **MENU/SELECT** to confirm.
  - If it is not an empty slot, the screen shows **Replace?** Press **MENU/SELECT** to replace the entry or press **OFF/CLEAR** to exit speed dial setting.

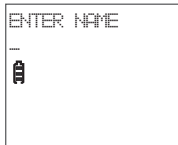
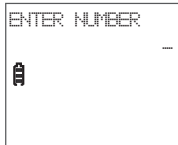



# Telephone operation

## Character chart

Use the dial pad and the chart below to enter a name (up to 15 characters). Each press of a particular key causes the characters to be displayed in the following order:

Number key	Characters by number of key presses										
	1	2	3	4	5	6	7	8	9	10	11
1	.	-	'	(	)	*	#	&	/	,	1
2	A	B	C	a	b	c	2				
3	D	E	F	d	e	f	3				
4	G	H	I	g	h	i	4				
5	J	K	L	j	k	l	5				
6	M	N	O	m	n	o	6				
7	P	Q	R	S	p	q	r	s	7		
8	T	U	V	t	u	v	8				
9	W	X	Y	Z	w	x	y	z	9		
0	0										
*	*										
#	space										

**note**

When entering a name in the directory, the first letter of each word is automatically capitalized.

# Telephone operation

## Search the directory

Entries are sorted alphabetically. To search the directory:

1. Press  ▲ when the handset is not in use.

**-OR-**

Press **MENU/SELECT** when the handset is not in use.

Press ▲ or ▼ to select **>Directory** and then press **MENU/SELECT** twice.

2. Press ▲ or ▼ to browse.



>Review  
Add contact



## Alphabetical search

To start an alphabetical search:

1. Press  ▲ when the handset is not in use.

**-OR-**

Press **MENU/SELECT** when the handset is not in use. Press ▲ or ▼ to select **>Directory** and then press **MENU/SELECT** twice.

2. Use the dialing keys to enter the letters associated with the name. For example, if you have name entries Jenny, Kristen and Linda in your directory, press **5** (JKL) once to find Jenny, twice to find Kristen, or three times to find Linda. If there is no name entry matching your search, the next closest match in alphabetical order appears. If necessary, press ▲ or ▼ to browse.



Mike Smith  
800-595-9511





## Dial a directory entry

1. Press  ▲ when the handset is not in use.

**-OR-**

Press **MENU/SELECT** when the handset is not in use. Press ▲ or ▼ to select **>Directory** and then press **MENU/SELECT** twice.

2. Press ▲ or ▼, or use the alphabetical search to browse.
3. Press /FLASH or .

# Telephone operation

## Edit a directory entry

Use the following steps to edit an entry in the directory.

1. Press **▲** when the handset is not in use.

**-OR-**

Press **MENU/SELECT** when the handset is not in use. Press **▲** or **▼** to select **>Directory** and then press **MENU/SELECT** twice.

2. Press **▲** or **▼**, or use the alphabetical search to browse (see page 23).

3. Press **MENU/SELECT** to select an entry. The screen shows **EDIT CONTACT**.



4. Press **▲** or **▼** to choose **Name**, **Number** or **Speed dial** to edit. Press **MENU/SELECT** to select the desired option.

- If you have not assigned a speed dial for the entry and choose to edit speed dial, follows the steps 7 and 8 on page 21.

5. While the screen shows **EDIT NAME**, use the dialing keys (see page 22) to edit the name. Press **MENU/SELECT** to save the setting.



- Press **MUTE/REMOVE** to backspace and erase a character.

- Press and hold **MUTE/REMOVE** to erase the entire entry.
- Press **▼** to move the cursor to the left or **▲** to the right.



**-OR-**

While the screen shows **EDIT NUMBER**, use the dialing keys to edit the number. Press **MENU/SELECT** to save the setting.

- Press **MUTE/REMOVE** to backspace and erase a digit.
- Press and hold **MUTE/REMOVE** to erase the entire entry.
- Press **▼** to move the cursor to the left or **▲** to the right.
- Press and hold **REDIAL/PAUSE** to insert a dialing pause (a **p** appears).



**-OR-**

While the screen shows **ASSIGN AS** and the current speed dial location displays, press **▲** or **▼** to choose the desired speed dial slot and press **MENU/SELECT** to save the setting.

- If the desired slot is not an empty slot, the screen shows **Replace?** Press **MENU/SELECT** to replace the entry or press **OFF/CLEAR** to exit speed dial setting.

6. After the setting is saved, press **MENU/SELECT** again to edit the other setting. Repeat steps 4 and 6 until all the settings are correct.

## Telephone operation

### Delete from the directory

1. Press  ▲ when the handset is not in use.

**-OR-**

Press **MENU/SELECT** when the handset is not in use. Press ▲ or ▼ to select >**Directory** and then press **MENU/SELECT** twice.

2. Press ▲ or ▼, or use the alphabetical search to browse.

3. Press **MUTE/REMOVE** to remove the selected entry and the screen shows **Delete contact?** Press **MENU/SELECT** to confirm and **Contact deleted** displays.

# Telephone operation

## About caller ID

This product supports caller ID services provide by most local telephone service companies. Depending on your service subscription, you may see the caller's number, or the caller's name and number that are sent by the telephone company after the first or second ring. Caller ID allows you to see the name, number, date and time of calls.

Caller ID with call waiting lets you see the name and telephone number of the caller before answering the telephone, even while on another call.

It may be necessary to change your telephone service to use this feature. Contact your telephone company if:

- You have both caller ID and call waiting, but as separate services ( you may need to combine these services).
- You have only caller ID service, or only call waiting service.
- You do not subscribe to caller ID or call waiting services.

There are fees for caller ID services. In addition, services may not be available in all areas.

This product can provide information only if both you and the caller are in areas offering caller ID service and if both telephone companies use compatible equipment. The time and date are sent by the telephone company along with the call information.

You can use this product with regular caller ID service, or you can use this product's other features without subscribing to either caller ID or combined caller ID with call waiting service.

# Telephone operation

## Call log

If you subscribe to caller ID service, information about each caller will appear after the first or second ring. If you answer a call before the caller information appears on the screen, it will not be saved in the call log.

- The call log stores up to 50 entries. Each entry has up to 24 digits for the phone number and 15 characters for the name. If the phone number has more than 15 digits, only the last 15 digits appear. If the name has more than 15 characters, only the first 15 characters are shown and saved in the call log.
- You can review, redial, and copy an entry into the directory.
- Entries appear in reverse chronological order.
- When the call log is full, the oldest entry is deleted to make room for new incoming call information.
- **XX MISSED CALL(S)** shows when there are new call log entries (including missed and unreviewed calls).
- **CALL LOG EMPTY** shows when there are no records in the call log.
- Only one handset can review the call log at a time. If a handset tries to enter the call log while another handset is already in it, **Not available at this time** appears.



### note

- The caller ID information may not be available for every incoming call. The callers may intentionally block their names and/or telephone numbers.
- For call log entries with numbers between 16 and 24 digits, in order to view the entire number, you must save the entry to the directory (see page 29).
- If the phone number has more than 24 digits, it will not be saved or shown in the call log.

## Missed calls indicator

When there are unreviewed calls in the call log, the handset shows **XX MISSED CALL(S)**.

Each time you review a call log entry marked **NEW**, the number of missed calls decreases by one.

When you have reviewed all the missed calls, the missed calls indicator no longer shows.

If you do not want to review the missed calls one by one, press and hold **OFF/CLEAR** to erase the missed calls indicator. All the entries are then considered old and kept in the call log.



# Telephone operation

## Review the call log

1. Press **CID** ▼ when the handset is not in use.
2. Press ▲ or ▼ to browse through the call log.

**-OR-**

1. Press **MENU/SELECT** when the handset is not in use.
2. Press ▲ or ▼ to select >**Call log**, then press **MENU/SELECT**.
3. Press ▲ or ▼ to select >**REVIEW**, then press **MENU/SELECT**.
4. Press ▲ or ▼ to browse through the call log.
  - The name (if available), telephone number, date and time of all incoming calls are shown on the screen.
  - You hear a double beep when the list reaches the beginning or end of the call log.



## Make a call log entry ready to dial

Although the call log entries received have 10 digits (the area code plus the seven-digit number), in some areas, you might need to dial only the seven digits, or **1** plus the seven digits, or **1** plus the area code plus the seven digits. You can change the number of digits that you dial from the call log and store to the directory.

While reviewing the call log, press **#** repeatedly to show different dialing options for local and long distance numbers before dialing or saving the telephone number in the directory.

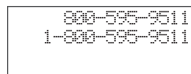
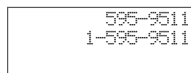
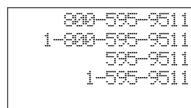

Press **1** repeatedly if you need to add or remove **1** in front of the telephone number before dialing or saving it in the directory.

When the number is shown in the correct format for dialing, press **TALK FLASH** or **Ⓜ** to call the number.



# Telephone operation

## Dial a call log entry

1. When in the call log, press ▲ or ▼ to browse.
2. Press  or  to dial the entry.

## Save a call log entry to the directory

1. When in the call log, press ▲ or ▼ to browse.
2. Press **MENU/SELECT** to select an entry. The screen displays **EDIT NUMBER**.
3. Use the dialing keys to edit the number.
  - Press **MUTE/REMOVE** to backspace and erase a digit.
  - Press and hold **MUTE/REMOVE** to erase the entire entry.
  - Press ▼ to move the cursor to the left or ▲ to the right.
  - Press and hold **REDIAL/PAUSE** to insert a dialing pause (a **p** appears).
4. Press **MENU/SELECT** to move to the name. The screen displays **EDIT NAME**.
5. Use the dialing keys (see page 22) to edit the name.
  - Press **MUTE/REMOVE** to backspace and erase a character.
  - Press and hold **MUTE/REMOVE** to erase the entire entry.
  - Press ▼ to move the cursor to the left or ▲ to the right.
6. Press **MENU/SELECT** to save.
  - If the entry is already saved in the directory, the handset shows **Already saved**.
  - If there is no caller ID information, the handset shows **UNABLE TO SAVE**.

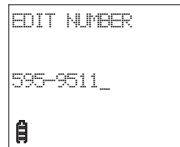

## Delete from the call log

To delete one entry:

1. When in the call log, press ▲ or ▼ to browse.
2. Press **MUTE/REMOVE** to delete the selected entry.

To delete all entries:

1. Press **MENU/SELECT** when the handset is not in use.
2. Press ▲ or ▼ to select **>Call log**, then press **MENU/SELECT**.
3. Press ▲ or ▼ to select **>DEL ALL CALLS**, then press **MENU/SELECT**.
4. The screen shows **DELETE ALL CALLS? PRESS SELECT TO CONFIRM**. Press **MENU/SELECT** to confirm.





# Telephone operation

## Call log display screen messages

Displays	When
PRIVATE NAME	The caller is blocking the name.
PRIVATE NUMBER	The caller is blocking the telephone number.
PRIVATE CALLER	The caller is blocking the name and number.
UNKNOWN NAME	This caller's name is unavailable.
UNKNOWN NUMBER	This caller's number is unavailable.
UNKNOWN CALLER	No information is available about this caller.
LONG DISTANCE OR L (before the caller's number)	It is a long distance call.

## Redial list

The telephone stores the five most recently dialed numbers.

- When there are already five entries, the oldest entry is deleted to make room for the new entry.
- Entries are shown in reverse chronological order.
- Press **REDIAL/PAUSE** to browse the redial list.

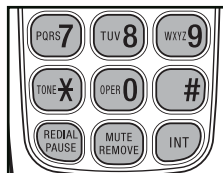

## Dial a redial entry

1. Press **REDIAL/PAUSE**, then ▲, ▼ or **REDIAL/PAUSE** to browse. You hear a double beep when it reaches the beginning or end of the redial list.
2. Press **TALK/FLASH** or **|||** to dial the number.

## Delete from redial

1. Press **REDIAL/PAUSE**, then ▲, ▼ or **REDIAL/PAUSE** to browse.
2. Press **MUTE/REMOVE** to delete the selected entry.

## Appendix

### Handset display screen messages

NO LINE	There is no telephone line connected.
NO SIGNAL, CALL ENDED	Communication between handset and telephone base is lost during a call.
NOT AVAILABLE AT THIS TIME	One handset is already viewing the call log or directory and another handset attempts to review it.
OUTSIDE CALL	Connected to the external call during call transfer.
**PAGING**	The cordless handset locator is activated.
PHONE	The handset is on a call.
PLACE IN CHARGER	The battery is very low. Place the handset in the telephone base or charger for recharging.
RINGER MUTE	The ringer is muted temporarily during an incoming call.
SAVED	Your selection has been saved.
SPEAKER	The handset speakerphone is in use.
UNABLE TO CALL TRY AGAIN	You have attempted to make an intercom call, but the handset you are calling is in the directory, in the call log, out of range or on an outside call.
UNABLE TO SAVE	You are attempting to save a caller ID entry with no name or number.
XX MISSED CALLS	There are unreviewed calls in your call log.

# Appendix

## Handset and telephone base indicators





### Handset lights

	On when the handset speakerphone is in use.
<b>CHARGE</b>	On when the handset is charging in the telephone base or charger.

### Telephone base lights

<b>IN USE</b>	Flashes when there is an incoming call or another telephone sharing the same line is in use. On when the handset is in use.
<b>VOICEMAIL</b>	Flashes when you have new voicemail from your telephone company.
<b>ANS ON/OFF</b>	On when the answering system is on.

### Handset icons

<b>ANS ON</b>	Answering system is turned on.
<b>MUTE</b>	Microphone is muted.
	Handset ringer off.
<b>OO</b>	New answering system messages.
MSG# [ 1/13 ]	Message number currently playing and total number of messages recorded.
<b>NEW</b>	New call log entries.
NEW VOICEMAIL 	New voicemail received from the telephone company.
SPEAKER 	Speakerphone is in use.
  <b>(Battery indicator)</b>	Cycles (low, medium, and full) when the handset battery is charging. Flashes when the battery is low and needs charging. Solid when the battery is fully charged.

# Appendix

## Battery

It takes up to 16 hours for the battery to be fully charged. When it is fully charged, you can expect the following performance:

Operation	Operating time
While in handset use (talking*)	Up to seven hours
While in speakerphone mode (talking*)	Up to five hours
While not in use (standby**)	Up to seven days

\*Operating times vary depending on your actual use and the age of the battery.

\*\*Handset is not charging or in use.

The battery needs charging when:

- A new battery is installed in the handset.
- The handset beeps.
- A battery is properly installed and the screen is blank.
- **LOW BATTERY** or **PLACE IN CHARGER** shows on the handset screen.

### CAUTION:

To reduce the risk of fire or injury, read and follow these instructions:

- Use only the battery(ies) provided or equivalent. To order a replacement, visit our website at [www.vtechphones.com](http://www.vtechphones.com) or call 1 (800) 595-9511. In Canada, go to [www.vtechcanada.com](http://www.vtechcanada.com) or call 1 (800) 267-7377.
- Do not dispose of the battery(ies) in a fire. Check with local waste management codes for special disposal instructions.
- Do not open or mutilate the battery(ies). Released electrolyte is corrosive and may cause burns or injury to the eyes or skin. The electrolyte may be toxic if swallowed.
- Exercise care in handling batteries in order not to create a short circuit with conductive materials.
- Charge the battery(ies) provided with or identified for use with this product only in accordance with the instructions and limitations specified in this manual.
- Observe proper polarity orientation between the battery and metallic contacts.
- To prevent fire or shock hazard, do not expose this product to water or any type of moisture.

## Appendix

### Expand your telephone system

The handsets provided with your telephone system are pre-registered. Each handset is assigned a number that shows on the handset display. Additional handsets registered to the telephone system are assigned in sequential order. For instance, if the telephone system already has **HANDSET 1** and **HANDSET 2**, the new registered handset is assigned **HANDSET 3**. This telephone system accommodates up to 12 handsets.

### Add and register a handset (optional)

You can add new handsets (**CS6309**, purchased separately) to your telephone system, but each handset must be registered with the telephone base before use. When first purchased, each expansion handset shows **NOT REGISTERED**. You may need to charge the handset before registering to the telephone base. For more details on battery charging, see the table on page 4.

To register a handset:

1. Place the unregistered handset in the telephone base or charger. If **PRESS FIND HS 4 SEC ON BASE** does not appear on the handset screen after a few seconds, remove the handset and place it in the telephone base or charger again.
2. On the telephone base, press and hold **FIND HANDSET** for about four seconds (until the red **IN USE** light on the telephone base turns on) and then release the button. The handset shows **PLEASE WAIT...** and it takes about 10 seconds to complete the registration. The handset shows **HANDSET X REGISTERED** (**X** represents the handset number assigned) and you hear a beep when the registration completes.

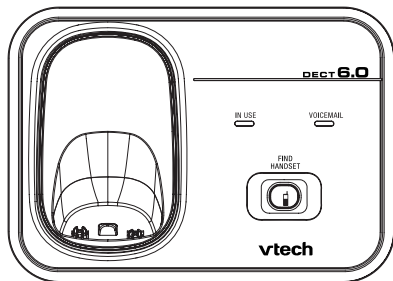

#### note

- If the registration fails, the handset shows **NOT REGISTERED**. To reset the handset, remove the handset from the telephone base and place it back in. Try the registration process again.
- You cannot register a handset if any other system handset is in use.

## Appendix

### Replace a handset

If you want to replace a handset or re-assign the designated handset number of a registered handset, you must de-register all the handsets and then individually register each handset.

To make de-registration easier, read all of the instructions on this page before you begin. To de-register all handsets:

1. Press and hold **FIND HANDSET** on the telephone base for about 10 seconds (until the **IN USE** light on the telephone base turns on and starts to flash), then release **FIND HANDSET**.
2. Press and release **FIND HANDSET** again. You must press **FIND HANDSET** while the **IN USE** light is still flashing. The **IN USE** light flashes for approximately seven seconds.
3. All system handsets show **CONNECTING...** The de-registration process takes about 10 seconds to complete. All handsets show **NOT REGISTERED** when the de-registration completes.

If de-registration fails, you might need to reset the telephone and try again.

To reset:

1. Pick up the registered handset and then press .
2. Press **OFF/CLEAR** and place the handset back in the telephone base.

**-OR-**

1. Unplug the power from the telephone base, then plug it back in.

**note**

You cannot de-register a handset if any system handset is in use.

# Appendix

## Troubleshooting

If you have difficulty with your telephone, please try the suggestions below. For Customer Service, visit our website at [www.vtechphones.com](http://www.vtechphones.com), or call 1 (800) 595-9511; in Canada, call 1 (800) 267-7377.

### My telephone does not work at all.

- Make sure the battery is installed and charged correctly (page 4). For optimum daily performance, return the handset to the telephone base or charger after use.
- Make sure the power adapter is securely plugged into an outlet not controlled by a wall switch.
- Make sure the telephone line cord is plugged firmly into the telephone base and the telephone wall jack.
- Unplug the electrical power to the telephone base. Wait for approximately 15 seconds, then plug it back in. Allow up to one minute for the cordless handset and telephone base to synchronize.
- Charge the battery in the handset for up to 16 hours.
- If the battery is completely depleted, it can take up to 10 minutes to charge the handset before **LOW BATTERY** appears on the screen (page 4).
- Remove and re-insert the battery. If that still does not work, it might be necessary to purchase a new battery.
- Disconnect the telephone base from the telephone wall jack and plug in a working telephone. If the other telephone does not work, the problem is probably in the wiring or the local service. Call the local telephone company.

### LOW BATTERY shows on screen.

- Place the handset in the telephone base or charger for recharging.
- Remove and re-install the battery and use it until fully depleted, then recharge the handset in the telephone base or charger for up to 16 hours.
- If the above measures do not correct the problem, replace the battery.

### The battery does not charge in the handset or the handset battery does not accept charge.

- Make sure the handset is placed in the telephone base or charger correctly. The **CHARGE** light on the handset should be on.
- Remove and reinstall the battery, then charge for up to 16 hours.
- If the handset is in the telephone base or charger but the **CHARGE** light on the handset is not on, refer to **The CHARGE light is off** in this section.
- If the battery is completely depleted, it can take up to 10 minutes to charge the handset before **LOW BATTERY** appears on the screen (page 4).
- Purchase a new battery. Refer to the **Battery** section (page 40).

# Appendix

## Troubleshooting

### **The CHARGE light is off.**

- Clean the charging contacts on the handset and telephone base each month with a pencil eraser or a dry non-abrasive fabric.
- Make sure the power adapter and telephone line cord are plugged in correctly and securely.
- Unplug the power adapter. Wait for 15 seconds before plugging it back in. Allow up to one minute for the handset and telephone base to reset.

### **There is no dial tone.**

- First, try all the above suggestions.
- Move the handset closer to the telephone base. It might be out of range.
- The telephone line cord might be malfunctioning. Install a new telephone line cord.
- Disconnect the telephone base from the telephone wall jack and connect a different telephone. If there is no dial tone on this telephone either, the problem is in your wiring or local service. Contact your local telephone company.

### **The telephone does not ring when there is an incoming call.**

- Make sure the handset ringer volume is not set to the lowest level (page 9) and the telephone base ringer volume is not set to zero (page 32).
- Make sure the telephone line cord and power adapter are plugged in properly (page 2).
- The handset might be too far from the telephone base. Move it closer to the telephone base.
- There might be too many extension phones on the telephone line to allow all of them to ring simultaneously. Unplug some of them.
- If the other telephones in your home are having the same problem, the problem is in the wiring or local service. Contact the local telephone company (charges may apply).
- Other electronic products can cause interference to your cordless telephone. Install your telephone as far away as possible from electronic devices such as: wireless routers, radios, cellular telephones, digital telephones, intercoms, room monitors, televisions, VCRs, personal computers, kitchen appliances, and other cordless telephones.
- Test a working telephone at the telephone wall jack. If another telephone has the same problem, the problem is in the telephone wall jack. Contact your local telephone company (charges may apply).
- The telephone line cord might be malfunctioning. Install a new telephone line cord.
- Re-install the battery and place the handset in the telephone base or charger.
- Wait for the handset to synchronize with the telephone base. Allow up to one minute for this to take place.



# Appendix

## Troubleshooting

### I cannot dial out.

- First, try all the above suggestions.
- Make sure there is a dial tone before dialing. It is normal if the handset takes a second or two to synchronize with the telephone before producing a dial tone. Wait an extra second before dialing.
- If the other telephones in your home are having the same problem, the problem is in the wiring or local service. Contact your local telephone company (charges may apply).
- Eliminate any background noise. Mute the cordless handset before dialing, or dial from another room in your home with less background noise.

### My handset beeps and is not performing normally.

- Make sure the power cord is securely plugged into the telephone base. Plug the telephone base into a different working electrical outlet not controlled by a wall switch.
- Move the handset closer to the telephone base. It might be out of range.
- Reset the telephone base by unplugging the electrical power to the base. Wait for 15 seconds and plug it back in again. Allow up to one minute for the cordless handset and the telephone base to synchronize.
- Other electronic products can cause interference to your cordless telephone. Install your telephone as far away from these electronic devices as possible: wireless routers, radios, radio towers, pager towers, cellular telephones, intercoms, room monitors, televisions, personal computers, kitchen appliances and other cordless telephones.

### There is interference during a telephone conversation.

#### My calls fade out when I am using the cordless handset.

- The handset might be out of range. Move it closer to the telephone base.
- If you subscribe to high-speed Internet service (digital subscriber line - DSL) through your telephone lines, you must install a DSL filter between the telephone base and the telephone wall jack. The filter prevents noise and caller ID problems caused by DSL interference. Contact your DSL service provider for more information about DSL filters.
- Appliances or other cordless telephones plugged into the same circuit as the telephone base can cause interference. Try moving the appliance or telephone base to another outlet.
- Other electronic products can cause interference to your cordless telephone. Install your telephone as far away as possible from the following electronic devices: wireless routers, radios, radio towers, pager towers, cellular telephones, digital telephones, intercoms, room monitors, televisions, VCRs, personal computers, kitchen appliances, and other cordless telephones.
- If your telephone is plugged in with a modem or a surge protector, plug the telephone (or modem/surge protector) into a different location. If this doesn't solve the problem, re-locate your telephone or modem farther apart from each other, or use a different surge protector.

# Appendix

## Troubleshooting

- The location of your telephone base can impact the performance of your cordless phone. For better reception, install the telephone base in a centralized location within your home or office, away from walls or other obstructions. In many environments, elevating the telephone base improves overall performance.
- Disconnect the telephone base from the telephone wall jack and plug in a corded telephone. If calls are still not clear, the problem is probably in the wiring or local service. Contact your local service company (charges may apply).
- If the other telephones in your home are having the same problem, the problem is in the wiring or local service. Contact the local telephone company (charges may apply).

### **I hear other calls when using the telephone.**

- Disconnect the telephone base from the telephone wall jack. Plug in a different telephone. If you still hear other calls, the problem is probably in the wiring or local service. Call your local telephone company.

### **I hear noise on the cordless handset and the keys do not work.**

- Make sure the telephone line cord is plugged in securely.

### **My caller ID features are not working properly.**

- Caller ID is a subscription service. You must subscribe to this service from your local telephone company for this feature to work on your telephone.
- The caller might not be calling from an area which supports caller ID.
- Both you and the caller's telephone companies must use equipment compatible with the caller ID service.
- The caller ID information shows after the first or second ring.
- If you subscribe to high-speed Internet service (digital subscriber line - DSL) through your telephone lines, you must install a DSL filter between the telephone base and the telephone wall jack. The filter prevents noise and caller ID problems caused by DSL interference. Contact your DSL service provider for more information about DSL filters.

### **The telephone does not receive caller ID or the telephone does not show caller ID during call waiting.**

- Make sure you subscribe to caller ID with call waiting features provided by the local telephone company.
- The caller might not be calling from an area which supports caller ID.
- Both you and the caller's telephone companies must use equipment compatible with caller ID service.
- If you subscribe to high-speed Internet service (digital subscriber line - DSL) through your telephone lines, you must install a DSL filter between the telephone base and the telephone wall jack. The filter prevents noise and caller ID problems caused by DSL interference. Contact your DSL service provider for more information about DSL filters.

# Appendix

## Troubleshooting

### Caller ID entries do not match the numbers I need to dial.

- Caller ID service delivers 10 digits (the area code plus the seven-digits number). If you need to dial something other 10 digits, see page 28 for instructions on changing the number.
- If you dial seven digits for local calls you might want to use the **Home area code** feature (PB).

### CONNECTING... shows in the handset screen.

- The handset might be out of range. Move it closer to the telephone base.
- Make sure the power cord is securely plugged into the telephone base. Use a working electrical outlet not controlled by a wall switch.
- Reset your telephone by unplugging the power adapter from the telephone base. Disconnect the battery from the cordless handset. Wait for 15 seconds, then plug in the power adapter and re-install the battery. Place the handset in the telephone base and allow up to one minute for the handset and telephone base to synchronize.
- Other electronic products might prevent your handset and telephone base from communicating with each other. Install your telephone base as far away from these electronic devices as possible: wireless routers, radios, cellular telephones, intercoms, room monitors, televisions, personal computers, kitchen appliances and other cordless telephones.

### The answering system does not answer after the number of rings that I programmed it.

- Make sure the answering system is on. When the answering system is on, the **ANS ON/OFF** light on the telephone base should be lit and **ANS ON** should show on the handset.
- If toll saver is selected, the number of rings changes to two when there are new messages waiting (page 13).
- If the memory is full or if the answering system is off, the answering system answers after 10 rings.
- In some cases, the answering system is affected by the ringing system used by the local telephone company.

### The outgoing announcement is not clear.

- When recording the announcement, make sure you speak in a normal tone of voice towards the microphone of the handset.
- Make sure there is no background noise when recording.

# Appendix

## Troubleshooting

### **The messages on the answering system are very difficult to hear.**

- Press **VOL ▲** on the telephone base or handset to increase the speaker volume.

### **The answering system does not record messages.**

- Make sure the answering system is on.
- When the answering machine memory is full, it does not record new messages until some old messages are deleted.

### **The messages on the answering system are incomplete.**

- If a caller leaves a very long message, part of it might be lost when the answering system disconnects the call after four minutes.
- If the memory on the answering system becomes full during a message, the answering system stops recording and disconnects the call.
- If the caller's voice is very soft, the answering system might stop recording and disconnect the call.

### **The answering system does not respond to remote commands.**

- Make sure your remote code is correct (page 11).
- Make sure you are calling from a touch-tone telephone. When dialing a number, there should be tones. If there are clicks, then it is not a touch-tone telephone and cannot activate the answering system.
- The answering system might not detect the remote access code when your announcement is playing. Wait until the announcement is over before entering the code.
- There might be interference on the telephone line you are using. Press the dial pad keys firmly when dialing.

### **Common cures for electronic equipment.**

- If the telephone is not responding normally, put the cordless handset in the telephone base. If it does not respond, try the following (in the order listed):
- Disconnect the power to the telephone base.
- Disconnect the battery on the cordless handset.
- Wait a few minutes before connecting power to the telephone base.
- Re-install the battery and place the cordless handset in the telephone base or charger.
- Wait for the cordless handset to synchronize with the telephone base. Allow up to one minute for this to take place.

# Appendix

## Important safety instructions

When using your telephone equipment, basic safety precautions should always be followed to reduce the risk of fire, electric shock and injury, including the following:

1. Read and understand all instructions.
2. Follow all warnings and instructions marked on the product.
3. Unplug this product from the wall outlet before cleaning. Do not use liquid or aerosol cleaners. Use a damp cloth for cleaning.
4. Do not use this product near water.
5. Do not place this product on an unstable table, shelf, stand or other unstable surfaces.
6. Slots and openings in the back or bottom of the telephone base and handset are provided for ventilation. To protect them from overheating, these openings must not be blocked by placing the product on a soft surface such as a bed, sofa or rug. This product should never be placed near or over a radiator or heat register. This product should not be placed in any area where proper ventilation is not provided.
7. This product should be operated only from the type of power source indicated on the marking label. If you are not sure of the type of power supply in your home, consult your dealer or local power company.
8. Do not allow anything to rest on the power cord. Do not install this product where the cord may be walked on.
9. Never push objects of any kind into this product through the slots in the telephone base or handset because they may touch dangerous voltage points or create a short circuit. Never spill liquid of any kind on the product.
10. To reduce the risk of electric shock, do not disassemble this product, but take it to an authorized service facility. Opening or removing parts of the telephone base or handset other than specified access doors may expose you to dangerous voltages or other risks. Incorrect reassembling can cause electric shock when the product is subsequently used.
11. Do not overload wall outlets and extension cords.
12. Unplug this product from the wall outlet and refer servicing to an authorized service facility under the following conditions:
  - A. When the power supply cord or plug is damaged or frayed.
  - B. If liquid has been spilled onto the product.
  - C. If the product has been exposed to rain or water.
  - D. If the product does not operate normally by following the operating instructions. Adjust only those controls that are covered by the operation instructions. Improper adjustment of other controls may result in damage and often requires extensive work by an authorized technician to restore the product to normal operation.
  - E. If the product has been dropped and the telephone base and/or handset has been damaged.
  - F. If the product exhibits a distinct change in performance.
13. Avoid using a telephone (other than cordless) during an electrical storm. There is a remote risk of electric shock from lightning.
14. Do not use the telephone to report a gas leak in the vicinity of the leak.
15. Only put the handset of your telephone next to your ear when it is in normal talk mode.
16. The power adapters are intended to be correctly oriented in a vertical or floor mount position. The prongs are not designed to hold the plug in place if it is plugged into a ceiling or an under-the-table/cabinet outlet.



**SAVE THESE INSTRUCTIONS**

# Appendix

## Operating range

This cordless telephone operates with the maximum power allowed by the Federal Communications Commission (FCC). Even so, this handset and telephone base can communicate over only a certain distance - which can vary with the locations of the telephone base and handset, the weather, and the layout of your home or office.

When the handset is out of range, the handset displays **CONNECTING...**

If there is a call while the handset is out of range, it might not ring, or if it does ring, the call might not connect well when you press . Move closer to the telephone base, then press  to answer the call.

If the handset moves out of range during a telephone conversation, there might be interference.

To improve reception, move closer to the telephone base.

## Maintenance

### Taking care of your telephone

Your cordless telephone contains sophisticated electronic parts, so it must be treated with care.

### Avoid rough treatment

Place the handset down gently. Save the original packing materials to protect your telephone if you ever need to ship it.

### Avoid water

Your telephone can be damaged if it gets wet. Do not use the handset outdoors in the rain, or handle it with wet hands. Do not install the telephone base near a sink, bathtub or shower.

### Electrical storms

Electrical storms can sometimes cause power surges harmful to electronic equipment. For your own safety, take caution when using electrical appliances during storms.

### Cleaning your telephone

Your telephone has a durable plastic casing that should retain its luster for many years. Clean it only with a soft cloth slightly dampened with water or a mild soap. Do not use excess water or cleaning solvents of any kind.

Remember that electrical appliances can cause serious injury if used when you are wet or standing in the water. If the telephone base should fall into the water, **DO NOT RETRIEVE IT UNTIL YOU UNPLUG THE POWER CORD AND TELEPHONE LINE CORD FROM THE WALL.** Then remove the telephone by the unplugged cords.

# Appendix

## About cordless telephones

- **Privacy:** The same features that make a cordless telephone convenient create some limitations. Telephone calls are transmitted between the telephone base and the cordless handset by radio waves, so there is a possibility that the cordless telephone conversations could be intercepted by radio receiving equipment within range of the cordless handset. For this reason, you should not think of cordless telephone conversations as being as private as those on corded telephones.
- **Electrical power:** The telephone base of this cordless telephone must be connected to a working electrical outlet. The electrical outlet should not be controlled by a wall switch. Calls cannot be made from the cordless handset if the telephone base is unplugged or switched off, or if the electrical power is interrupted.
- **Potential TV interference:** Some cordless telephones operate at frequencies that may cause interference to televisions and VCRs. To minimize or prevent such interference, do not place the telephone base of the cordless telephone near or on top of a TV or VCR. If interference is experienced, moving the cordless telephone farther away from the TV or VCR often reduces or eliminates the interference.
- **Rechargeable batteries:** Exercise care in handling batteries in order not to create a short circuit with conducting material such as rings, bracelets, and keys. The battery or conductor may overheat and cause harm. Observe proper polarity between the battery and the battery charger.
- **Nickel-metal hydride rechargeable batteries:** Dispose of these batteries in a safe manner. Do not burn or puncture the battery. Like other batteries of this type, if burned or punctured, they could release caustic material which could cause injury.

## The RBRC® seal

The RBRC® seal on the nickel-metal hydride battery indicates that VTech Communications, Inc. is voluntarily participating in an industry program to collect and recycle these batteries at the end of their useful lives, when taken out of service within the United States and Canada.

The RBRC® program provides a convenient alternative to placing used nickel-metal hydride batteries into the trash or municipal waste, which may be illegal in your area.

VTech's participation in RBRC® makes it easy for you to drop off the spent battery at local retailers participating in the RBRC® program or at authorized VTech product service centers. Please call **1-800-8-BATTERY™** for information on Ni-MH battery recycling and disposal bans/restrictions in your area. VTech's involvement in this program is part of its commitment to protecting our environment and conserving natural resources.

**RBRC® is a registered trademark of Rechargeable Battery Recycling Corporation.**



# Appendix

## Warranty

### What does this limited warranty cover?

The manufacturer of this VTech Product warrants to the holder of a valid proof of purchase (“Consumer” or “you”) that the Product and all accessories provided in the sales package (“Product”) are free from defects in material and workmanship, pursuant to the following terms and conditions, when installed and used normally and in accordance with the Product operating instructions. This limited warranty extends only to the Consumer for Products purchased and used in the United States of America and Canada.

### What will VTech do if the Product is not free from defects in materials and workmanship during the limited warranty period (“Materially Defective Product”)?

During the limited warranty period, VTech’s authorized service representative will repair or replace at VTech’s option, without charge, a Materially Defective Product. If we repair the Product, we may use new or refurbished replacement parts. If we choose to replace the Product, we may replace it with a new or refurbished Product of the same or similar design. We will retain defective parts, modules, or equipment. Repair or replacement of the Product, at VTech’s option, is your exclusive remedy. VTech will return the repaired or replacement Products to you in working condition. You should expect the repair or replacement to take approximately 30 days.

### How long is the limited warranty period?

The limited warranty period for the Product extends for ONE (1) YEAR from the date of purchase. If VTech repairs or replaces a Materially Defective Product under the terms of this limited warranty, this limited warranty also applies to the repaired or replacement Product for a period of either (a) 90 days from the date the repaired or replacement Product is shipped to you or (b) the time remaining on the original one-year warranty; whichever is longer.

### What is not covered by this limited warranty?

This limited warranty does not cover:

1. Product that has been subjected to misuse, accident, shipping or other physical damage, improper installation, abnormal operation or handling, neglect, inundation, fire, water or other liquid intrusion; or
2. Product that has been damaged due to repair, alteration or modification by anyone other than an authorized service representative of VTech; or
3. Product to the extent that the problem experienced is caused by signal conditions, network reliability, or cable or antenna systems; or
4. Product to the extent that the problem is caused by use with non-VTech accessories; or
5. Product whose warranty/quality stickers, product serial number plates or electronic serial numbers have been removed, altered or rendered illegible; or
6. Product purchased, used, serviced, or shipped for repair from outside the United States of America or Canada, or used for commercial or institutional purposes (including but not limited to Products used for rental purposes); or
7. Product returned without a valid proof of purchase (see item 2 below); or
8. Charges for installation or set up, adjustment of customer controls, and installation or repair of systems outside the unit.



# Appendix

## How do you get warranty service?

To obtain warranty service in the United States of America, please call 1 (800) 595-9511. In Canada, please call 1 (800) 267-7377. NOTE: Before calling for service, please review the user's manual - a check of the Product's controls and features may save you a service call.

Except as provided by applicable law, you assume the risk of loss or damage during transit and transportation and are responsible for delivery or handling charges incurred in the transport of the Product(s) to the service location. VTech will return repaired or replaced Product under this limited warranty. Transportation, delivery or handling charges are prepaid. VTech assumes no risk for damage or loss of the Product in transit. If the Product failure is not covered by this limited warranty, or proof of purchase does not meet the terms of this limited warranty, VTech will notify you and will request that you authorize the cost of repair prior to any further repair activity. You must pay for the cost of repair and return shipping costs for the repair of Products that are not covered by this limited warranty.

## What must you return with the Product to get warranty service?

1. Return the entire original package and contents including the Product to the VTech service location along with a description of the malfunction or difficulty; and
2. Include a "valid proof of purchase" (sales receipt) identifying the Product purchased (Product model) and the date of purchase or receipt; and
3. Provide your name, complete and correct mailing address, and telephone number.

## Other Limitations

This warranty is the complete and exclusive agreement between you and VTech. It supersedes all other written or oral communications related to this Product. VTech provides no other warranties for this Product. The warranty exclusively describes all of VTech's responsibilities regarding the Product. There are no other express warranties. No one is authorized to make modifications to this limited warranty and you should not rely on any such modification.

State/Provincial Law Rights: This warranty gives you specific legal rights, and you may also have other rights, which vary from state to state or province to province.

Limitations: Implied warranties, including those of fitness for a particular purpose and merchantability (an unwritten warranty that the Product is fit for ordinary use) are limited to one year from the date of purchase. Some states/provinces do not allow limitations on how long an implied warranty lasts, so the above limitation may not apply to you. In no event shall VTech be liable for any indirect, special, incidental, consequential, or similar damages (including, but not limited to lost profits or revenue, inability to use the Product or other associated equipment, the cost of substitute equipment, and claims by third parties) resulting from the use of this Product. Some states/provinces do not allow the exclusion or limitation of incidental or consequential damages, so the above limitation or exclusion may not apply to you.

**Please retain your original sales receipt as proof of purchase.**

# Appendix

## FCC, ACTA and IC regulations

### FCC Part 15

This equipment has been tested and found to comply with the requirements for a Class B digital device under Part 15 of the Federal Communications Commission (FCC) rules. These requirements are intended to provide reasonable protection against harmful interference in a residential installation. This equipment generates, uses and can radiate radio frequency energy and, if not installed and used in accordance with the instructions, may cause harmful interference to radio communications. However, there is no guarantee that interference will not occur in a particular installation. If this equipment does cause harmful interference to radio or television reception, which can be determined by turning the equipment off and on, the user is encouraged to try to correct the interference by one or more of the following measures:

- Reorient or relocate the receiving antenna.
- Increase the separation between the equipment and receiver.
- Connect the equipment into an outlet on a circuit different from that to which the receiver is connected.
- Consult the dealer or an experienced radio/TV technician for help.

Changes or modifications to this equipment not expressly approved by the party responsible for compliance could void the user's authority to operate the equipment.

This device complies with Part 15 of the FCC rules. Operation is subject to the following two conditions: (1) this device may not cause harmful interference, and (2) this device must accept any interference received, including interference that may cause undesired operation. Privacy of communications may not be ensured when using this telephone.

To ensure safety of users, the FCC has established criteria for the amount of radio frequency energy that can be safely absorbed by a user or bystander according to the intended usage of the product. This product has been tested and found to comply with the FCC criteria. The handset may be safely held against the ear of the user. The telephone base shall be installed and used such that parts of the user's body other than the hands are maintained at a distance of approximately 20 cm (8 inches) or more.

This Class B digital apparatus complies with Canadian ICES-003.

### FCC Part 68 and ACTA

This equipment complies with Part 68 of the FCC rules and with technical requirements adopted by the Administrative Council for Terminal Attachments (ACTA). The label on the back or bottom of this equipment contains, among other things, a product identifier in the format US:AAAEQ##TXXXX. This identifier must be provided to your local telephone company upon request.

The plug and jack used to connect this equipment to premises wiring and the telephone network must comply with applicable Part 68 rules and technical requirements adopted by ACTA. A compatible telephone cord and modular plug is provided with this product. It is designed to be connected to a compatible modular jack that is also compliant. An RJ11 jack should normally be used for connecting to a single line and an RJ14 jack for two lines. See Installation Instructions in the user's manual.

The Ringer Equivalence Number (REN) is used to determine how many devices you may connect to your telephone line and still have them ring when you are called. The REN for this product is encoded as the 6th and 7th characters following the US: in the product identifier (e.g., if ## is 03, the REN is 0.3). In most, but not all areas, the sum of all RENs should be five (5.0) or less. For more information, please contact your local telephone company.

This equipment may not be used with Party Lines. If you have specially wired alarm dialing equipment connected to your telephone line, ensure the connection of this equipment does not disable your alarm equipment. If you have questions about what will disable alarm equipment, consult your telephone company or a qualified installer.

If this equipment is malfunctioning, it must be unplugged from the modular jack until the problem has been corrected. Repairs to this telephone equipment can only be made by the manufacturer or its authorized agents. For repair procedures, follow the instructions outlined under the Limited Warranty.

## Appendix

If this equipment is causing harm to the telephone network, the telephone company may temporarily discontinue your telephone service. The telephone company is required to notify you before interrupting service. If advance notice is not practical, you will be notified as soon as possible. You will be given the opportunity to correct the problem and the telephone company is required to inform you of your right to file a complaint with the FCC. Your telephone company may make changes in its facilities, equipment, operation, or procedures that could affect the proper functioning of this product. The telephone company is required to notify you if such changes are planned.

If this product is equipped with a corded or cordless handset, it is hearing aid compatible.

If this product has memory dialing locations, you may choose to store emergency telephone numbers (e.g., police, fire, medical) in these locations. If you do store or test emergency numbers, please:

Remain on the line and briefly explain the reason for the call before hanging up.

Perform such activities in off-peak hours, such as early morning or late evening.

### Industry Canada

Operation is subject to the following two conditions: (1) this device may not cause harmful interference, and (2) this device must accept any interference, including interference that may cause undesired operation.

The term "IC:" before the certification/registration number only signifies that the Industry Canada technical specifications were met.

The Ringer Equivalence Number (REN) for this terminal equipment is 0.1. The REN is an indication of the maximum number of devices allowed to be connected to a telephone interface. The termination on an interface may consist of any combination of devices subject only to the requirement that the sum of the RENs of all the devices does not exceed five.

This product meets the applicable Industry Canada technical specifications.

# Appendix

## Technical specifications

Transmit frequency	Handset: 1921.536-1928.448 MHz Telephone base: 1921.536-1928.448 MHz
Channels	5
Nominal effective range	Maximum power allowed by FCC and IC. Actual operating range might vary according to environmental conditions at the time of use.
Size	Handset: 6.37 X 1.85 X 1.14 in (161.85 X 47.00 X 28.9 mm) Telephone base: 6.05 X 4.31 X 2.28 in (153.7 X 109.45 X 57.8 mm) Charger: 2.96 X 3.33 X 1.80 in (75.3 X 84.6 X 45.8 mm)
Weight	Handset: 4.47oz (126.7g) (including battery) Telephone base: 5.35oz (151.7g) Charger: 1.81oz (51.3g)
Power requirements	Handset: 2.4V 500mAh Ni-MH battery Telephone base: 6V AC @ 300mA Charger: 6V AC @ 300mA
Memory	Handset directory: 100 memory locations (including 10 speed dial entries); up to 30 digits and 15 characters Handset call log: 50 memory locations; up to 24 digits and 15 characters

# Index

## A

- Add a handset 38
- Alphabetical search 21
- Announcement 12
- Answer a call 13
- Answer an incoming call during an intercom call 16
- Answering system 28

## B

- Battery 3, 37

## C

- Caller ID 23
- Call intercept 29
- Call log 24
- Call log display screen messages 27
- Call screening 29
- Call waiting 14
- Chain dialing 15
- Character chart 20
- Charging 3
- Clear voicemail 10

## D

- Date and time 9
- Delete announcement 12
- Delete answering system messages 31
- Delete from redial 27
- Delete from the call log 26
- Delete from the directory 22
- Dial a call log entry 26
- Dial a directory entry 21
- Dial a redial entry 27
- Dialing pause 19, 22, 26
- Directory 18
- DSL filter 2

## E

- Edit a directory entry 22
- End a call 13
- Expand your telephone system 38

## F

- Find handset 14

## H

- Handset display screen messages 34
- Handset icons 36
- Handset layout 6
- Handset lights 36
- Home area code 10

## I

- Important safety instructions 46
- Intercom 16

## K

- Key tone 8

## L

- Language 9

## M

- Maintenance 47
- Make a call 13
- Make a call log entry ready to dial 25
- Message alert tone 11
- Message capacity 28
- Message playback 30
- Message window displays 32
- Missed calls indicator 24
- Multiple handset use 16
- Mute 14

## N

- New message indication 30
- Number of rings 11

## O

- Operating range 47

## P

- Parts checklist 1
- Phonebook 18
- Play announcement 12
- Predial a call 13

# Index

## R

- Record and play memos 31
- Record announcement 12
- Redial list 27
- Register a handset 38
- Remote access 33
- Remote code 11
- Replace a handset 39
- Review the call log 25
- Ringer mute 14
- Ringer tone 8
- Ringer volume 8

## S

- Save a call log entry to the directory 26
- Search the directory 21
- Share an outside call 17
- Speakerphone 13
- Store a directory entry 19
- Store from redial 19

## T

- Technical specifications 53
- Telephone base installation 2
- Telephone base layout 7
- Telephone base lights 36
- Telephone base ringer volume 29
- Troubleshooting 40
- Turn the answering system on or off 29

## V

- Voicemail 10
- Volume 8, 13, 29

## W

- Wall mounting 4
- Warranty 49

VTECH TELECOMMUNICATIONS LTD.  
A member of THE VTECH GROUP OF COMPANIES.

Distributed in the U.S.A. by VTech Communications, Inc. Beaverton, Oregon 97008

Distributed in Canada by VTech Technologies Canada, Ltd., Richmond, B.C. V6W 1L5

Copyright © 2009 for VTECH TELECOMMUNICATIONS LTD.

Printed in China.

91-002292-020-100

# vtech®

Innovation Beyond Technology™

## User's manual

[www.vtechphones.com](http://www.vtechphones.com)



Models:  
CS6329/CS6329-2/  
CS6329-3/CS6329-4/  
CS6329-5

**DECT 6.0**



# Congratulations

on purchasing your new VTech product. Before using this telephone, please read the **Important safety instructions** on page xx of this manual.

This manual has all the feature operations and troubleshooting necessary to install and operate your new VTech telephone. Please review this manual thoroughly to ensure proper installation and operation of this innovative and feature rich VTech product. For support, shopping, and everything new at VTech, visit our website at [www.vtechphones.com](http://www.vtechphones.com). In Canada, please visit [www.vtechcanada.com](http://www.vtechcanada.com).



The ENERGY STAR<sup>®</sup> program ([www.energystar.gov](http://www.energystar.gov)) recognizes and encourages the use of products that save energy and help protect our environment. We are proud to mark this product with the ENERGY STAR<sup>®</sup> label indicating it meets the latest energy efficiency guidelines.



Telephones identified with this logo have reduced noise and interference when used with most T-coil equipped hearing aids and cochlear implants. The TIA-1083 Compliant Logo is a trademark of the Telecommunications Industry Association. Used under license.

# Table of contents

<b>Getting started</b> .....	1	Find handset.....	14
Parts checklist.....	1	Chain dialing.....	15
Telephone base and charger installation.....	2	Multiple handset use .....	16
Battery installation and charging .....	3	Intercom .....	16
Installation options .....	4	Answer an incoming call during an intercom call.....	16
Table top to wall mount installation .....	4	Share an outside call.....	17
Wall mount to table top installation.....	5	Directory.....	18
Handset layout .....	6	Store a directory entry.....	19
Telephone base layout .....	7	Character chart .....	20
<b>Telephone settings</b> .....	8	Search the directory.....	21
Ringer volume (handset).....	8	Alphabetical search.....	21
Ringer tone.....	8	Dial a directory entry .....	21
Key tone .....	8	Edit a directory entry .....	22
LCD language .....	9	Delete from the directory.....	22
Set date/time .....	9	About caller ID.....	23
Clear voicemail.....	10	Call log .....	24
Home area code.....	10	Missed calls indicator .....	24
<b>Answering system settings</b> ....	11	Review the call log .....	25
Answering system set up .....	11	Make a call log entry ready to dial .....	25
Number of rings.....	11	Dial a call log entry .....	26
Remote code .....	11	Save a call log entry to the directory .....	26
Message alert tone.....	11	Delete from the call log .....	26
Announcement .....	12	Call log display screen messages.....	27
Play your announcement .....	12	Redial list.....	27
Record your own announcement .....	12	Dial a redial entry .....	27
Delete your announcement .....	12	Delete from redial.....	27
<b>Telephone operation</b> .....	13	<b>Answering system operation</b> ...28	
Make a call .....	13	Answering system and voicemail.....	28
Redial a call.....	13	Message capacity .....	28
Answer a call.....	13	Turn the answering system on or off.....	29
End a call.....	13	Call screening .....	29
Speakerphone .....	13	Call intercept .....	29
Volume .....	13	Telephone base ringer volume...29	
Mute .....	14	New message indication .....	30
Ringer mute.....	14	Message playback .....	30
Call waiting.....	14	Delete all messages.....	31

## Table of contents

Record and play memos .....	31
Record a memo.....	31
Message window displays.....	32
Remote access .....	33
<b>Appendix.....</b>	<b>34</b>
Handset display screen messages.....	34
Handset and telephone base indicators .....	36
Battery.....	37
Expand your telephone system...	38
Add and register a handset (optional).....	38
Replace a handset .....	39
Troubleshooting.....	40
Important safety instructions.....	46
Operating range .....	47
Maintenance.....	47
About cordless telephones.....	48
The RBRC® seal.....	48
Warranty .....	49
FCC, ACTA and IC regulations ...	51
Technical specifications .....	53
<b>Index.....</b>	<b>54</b>

# Getting started

## Parts checklist

Your telephone contains the following items. Save your sales receipt and original packaging in the event warranty service is necessary.

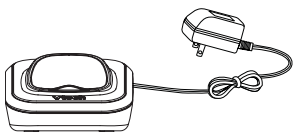

**Charger and charger adapter**

(1 for CS6329-2, 2 for CS6329-3, 3 for CS6329-4, and 4 for CS6329-5)



**Handset**

(1 for CS6329, 2 for CS6329-2, 3 for CS6329-3, 4 for CS6329-4, and 5 for CS6329-5)

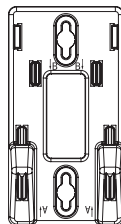

**Wall bracket**

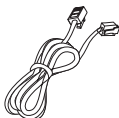

**Telephone line cord**

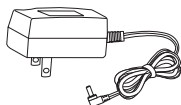

**Telephone base power adapter**

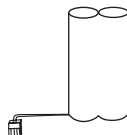

**Battery**

(1 for CS6329, 2 for CS6329-2, 3 for CS6329-3, 4 for CS6329-4, and 5 for CS6329-5)



**Battery compartment cover**

(1 for CS6329, 2 for CS6329-2, 3 for CS6329-3, 4 for CS6329-4, and 5 for CS6329-5)

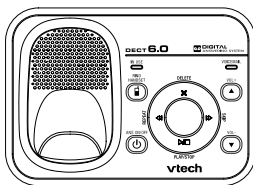

**Telephone base**

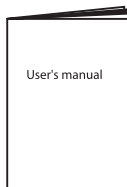

**User's manual**

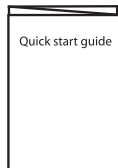

**Quick start guide**

**note**

To purchase replacement batteries or power adapters, visit our website at [www.vtechphones.com](http://www.vtechphones.com) or call 1 (800) 595-9511. In Canada, go to [www.vtechcanada.com](http://www.vtechcanada.com) or call 1 (800) 267-7377.

# Getting started

## Telephone base and charger installation

Install the telephone base and charger(s) as shown below.

Make sure that the electrical outlet is not controlled by a wall switch.

If you subscribe to digital subscriber line (DSL) high-speed Internet service through your telephone line, you must install a DSL filter between the telephone line cord and the telephone wall jack. The filter prevents noise and caller ID problems caused by DSL interference. Contact your DSL service provider for more information about DSL filters.

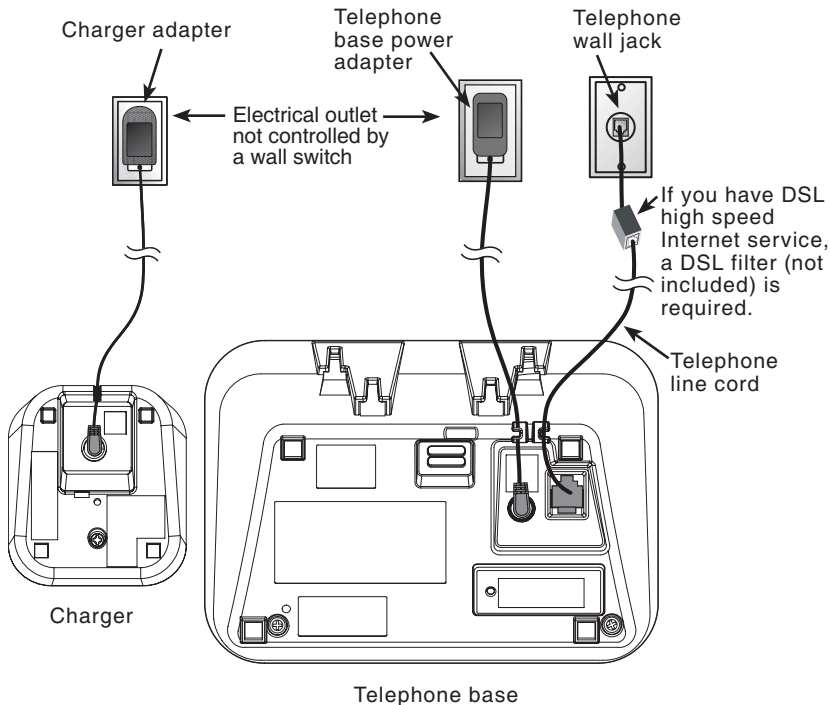

### note

- Use only the power adapters supplied with this product. To order a replacement, visit our website at [www.vtechphones.com](http://www.vtechphones.com) or call 1 (800) 595-9511. In Canada, go to [www.vtechcanada.com](http://www.vtechcanada.com) or call 1 (800) 267-7377.
- The power adapters are intended to be correctly oriented in a vertical or floor mount position. The prongs are not designed to hold the plug in place if it is plugged into a ceiling or an under-the-table/cabinet outlet.

# Getting started

## Battery installation

Install the battery as shown below.

1. If the battery compartment cover is on the handset, press on the indentation and slide the cover to remove.
2. Plug the battery connector securely into the socket inside the handset battery compartment, matching the color-coded label.
3. Place the battery with the label **THIS SIDE UP** facing up and the wires inside the battery compartment.
4. Align the cover flat against the battery compartment, then slide it towards the center of the handset until it clicks into place.
5. Charge the handset by placing it in the telephone base or charger. The **CHARGE** light is on when the handset charges.

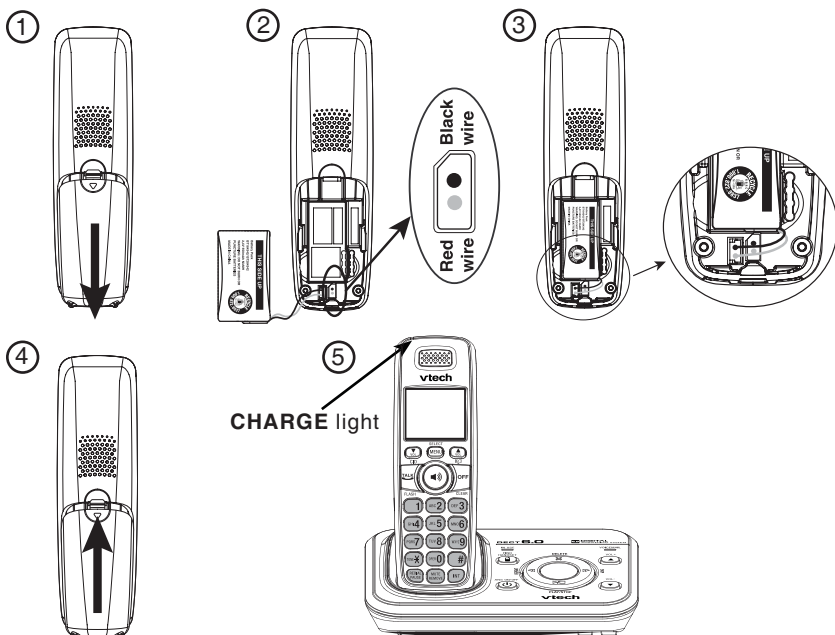

### note

- If the handset will not be used for a long time, disconnect and remove the battery to prevent possible leakage.
- To purchase replacement batteries, visit our website at [www.vtechphones.com](http://www.vtechphones.com) or call 1 (800) 595-9511. In Canada, go to [www.vtechcanada.com](http://www.vtechcanada.com) or call 1 (800) 267-7377.



# Getting started

## Battery charging

Once you have installed the battery, the screen indicates the battery status (see the table below). If necessary, place the handset in the telephone base or charger to charge the battery. For best performance, keep the handset in the telephone base or charger when not in use. The battery is fully charged after 16 hours of continuous charging. See the table on page 40 for battery operating times.

If the screen is blank, you need to charge the handset without interruption for at least 10 minutes to give the handset enough charge to use the telephone for a short time. The handset beeps and shows **LOW BATTERY**. If you are on a call in low battery mode, the handset beeps every minute.

The following table summarizes the battery charge indicators and actions to take.

Battery indicators	Battery status	Action
The screen is blank.	Battery has no charge and the handset cannot be used.	Charge without interruption until the screen shows <b>LOW BATTERY</b> (at least 10 minutes).
The screen shows <b>PLACE IN CHARGER</b> and  flashes.	Battery has very little charge and the handset cannot be used.	Charge without interruption until the screen shows <b>LOW BATTERY</b> (at least four minutes).
The screen shows <b>LOW BATTERY</b> ,  flashes, and the handset beeps.	Battery has enough charge to be used for a short time.	Charge without interruption until the screen shows <b>HANDSET X</b> (about one hour).
The screen shows <b>HANDSET X</b> .	Battery is charged.	To keep the battery charged, place it in the telephone base or charger when not in use.

# Getting started

## Installation options

Your telephone base is ready for table top use. **If you want to mount your telephone on a wall, use the provided wall bracket to connect with a standard dual-stud telephone wall mounting plate.** If you do not have this mounting plate, you can purchase one from many hardware or consumer electronics retailers. You might need a professional to install the mounting plate.

### Table top to wall mount installation

1. Position the telephone base as shown below. Insert the extended tabs (marked **B**) of the wall bracket into the slots on the back of the telephone base (marked **B**). Push the telephone base down until it is securely in place.
2. If you are using a DSL filter, plug the line cord into the filter now. Route the telephone line cord (or DSL filter) through the wall bracket hole. Route the power cord out of the bottom of the telephone.
3. Plug the telephone line cord (or DSL filter) into the wall jack. Plug the power adapter into a power outlet not controlled by a wall switch.
4. Align the holes on the bracket with the standard wall plate and slide the bracket down until it locks securely. Bundle the telephone line cord and power adapter cord neatly with a twist tie.

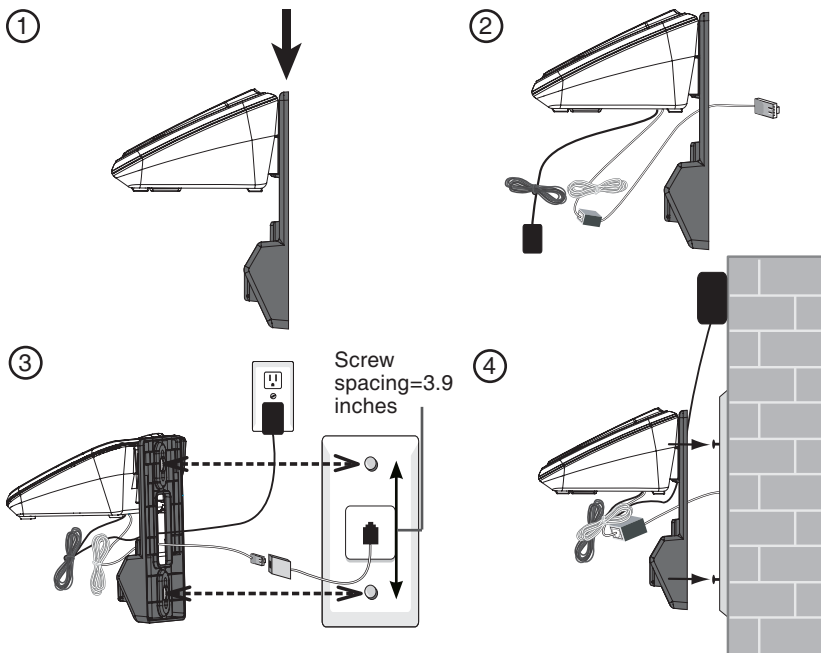



## Getting started

### Wall mount to table top installation

1. If the telephone line cord and power adapter cord are bundled, untie them first.
2. Lift the telephone base up to detach it from the black plastic wall bracket. Unplug the telephone line cord (or DSL filter) from the wall. Unplug the power adapter from the power outlet.
3. See **Telephone base and charger installation** on page 2.

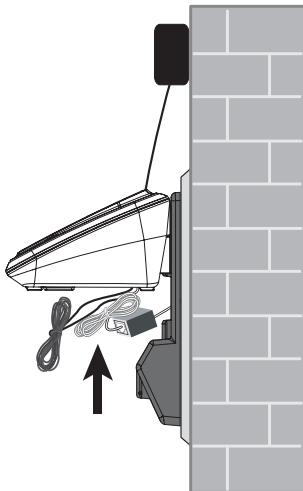

# Getting started

## Handset layout

### CHARGE light

On when the handset is charging in the telephone base or charger (page xx).

### ▲ VOL/ (volume/directory)

Press to enter the directory when the telephone is not in use (page xx).

While in a menu, press to scroll up.

During a call, press to raise the listening volume (page xx).

### (speakerphone)

Press to switch between speakerphone and handset (page xx).

### TALK/FLASH

Press to make or answer a call (page xx).

During a call, press to receive an incoming call when you receive a call waiting alert (page xx).

### 1

While reviewing a call log entry, press repeatedly to add or remove 1 in front of the telephone number before dialing or saving it in the directory (page xx).

### REDIAL/PAUSE

Press to review the redial list (page 30).

While dialing or entering numbers into the directory, **press and hold** to insert a dialing pause (page 21).

### ▼ VOL/CID (caller ID/volume)

Press to review the call log when the telephone is not in use (page 28).

While in a menu, press to scroll down.

During a call, press to lower the listening volume (page 15).

### MENU/SELECT

Press to show the menu.

While in a menu, press to select an item, or save an entry or setting.

### OFF/CLEAR

During a call, press to hang up (page 15).

While the handset is ringing, press to silence the ringer temporarily (page 16).

**Press and hold** while the telephone is not in use to erase the missed calls indicator (page 27).

During programming, press to exit without making changes.

### #

Press repeatedly to show other dialing options when reviewing a call log entry (page 28).

### INT (intercom)

Press to initiate an intercom conversation or transfer a call (page 18).

### MUTE/REMOVE

While on a call, press to mute the microphone (page 16).

While reviewing the call log, directory or redial list, press to delete an individual entry (page 29, page 25 and page 30, respectively).

Press to delete digits when predialing (page 15).

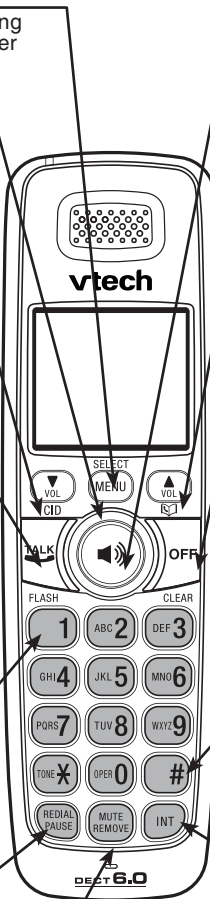

# Getting started

## Telephone base layout

### Message window

Shows the number of messages and other answering system information (page 35).

### IN USE light

Flashes when there is an incoming call, or another telephone sharing the same line is in use.

On when the handset is in use.

### FIND HANDSET

Press to page all system handsets.

### ANS ON/OFF

Press to turn the answering system on or off (page 32).

### ◀/REPEAT

Press to repeat a message or press twice to play previous message (page 33).

### X/DELETE

Press to delete the message currently playing (page 33).

When the phone is not in use, press twice to delete all previously reviewed messages (page 34).

### ▶/SKIP

Press to skip to the next message (page 33).

### ▶/■/PLAY/STOP

Press to play messages (page 33).

Press to stop message playback (page 33).

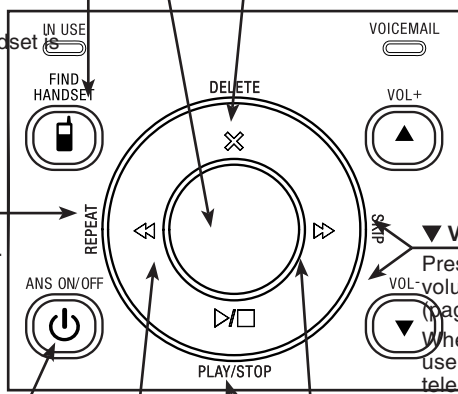

# Telephone settings

## Ringer volume (handset)

You can set the ringer volume or turn the ringer off.

1. Press **MENU/SELECT** to show the menu when the handset is not in use.
2. Press **▲** or **▼** to select **>Ringers**, then press **MENU/SELECT**.
3. Press **▲** or **▼** to select **>Ringer volume**, then press **MENU/SELECT**.
4. Press **▲** or **▼** to adjust the volume. A sample of each ringer volume plays as you scroll through the choices.
5. Press **MENU/SELECT** to confirm your selection.



### note

- Setting the volume to the lowest level turns off the ringer. A ringer off icon  appears.
- See page xx to set the telephone base ringer volume.
- The setting also determine the ringer volume of the intercom call and paging tone. However, paging volume ranges between level 4 to 5 only, therefore, if the ringer volume is set to below level 4, the paging volume will be set to level 4 automatically.

## Ringer tone

You can choose from different ringer tones or melodies.

1. Press **MENU/SELECT** to show the menu when the handset is not in use.
2. Press **▲** or **▼** to select **>Ringers**, then press **MENU/SELECT**.
3. Press **▲** or **▼** to select **>Ringer tone**, then press **MENU/SELECT**.
4. Press **▲** or **▼** to select the desired ringer tone or melody. A sample of each ringer tone or melody plays as you scroll through the choices.
5. Press **MENU/SELECT** to confirm your selection.

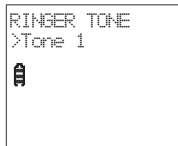

### note

If you turn off the ringer volume, you will not hear ringer tone samples.

# Telephone settings

## Key tone

You can turn the key tone on or off.

1. Press **MENU/SELECT** to show the menu when the handset is not in use.
2. Press **▲** or **▼** to select **>Settings**, then press **MENU/SELECT**.
3. Press **▲** or **▼** to select **>Key tone**, then press **MENU/SELECT**.
4. Press **▲** or **▼** to choose **On** or **Off**.
5. Press **MENU/SELECT** to confirm your selection.



## LCD language

You can select **English**, **Français** or **Español** to be used in all screen displays.

1. Press **MENU/SELECT** to show the menu when the handset is not in use.
2. Press **▲** or **▼** to select **>Settings**, then press **MENU/SELECT**.
3. Press **▲** or **▼** to select **>LCD language**, then press **MENU/SELECT**.
4. Press **▲** or **▼** to scroll through the choices.
5. Press **MENU/SELECT** to confirm your selection.

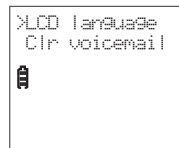

## Set date/time

The answering system announces the day and time of the message prior to playing it. Before using the answering system, set the date and time as follows. If you subscribe to caller ID service, the day, month and time are set automatically with each incoming call. However, the year must be correct so that the day of the week can be calculated from the caller ID information.

1. Press **MENU/SELECT** to show the menu when the handset is not in use.
2. Press **▲** or **▼** to select **>Settings**, then press **MENU/SELECT**.
3. Press **▲** or **▼** to select **>Set date/time**, then press **MENU/SELECT**.
4. Press the dialing keys **(0-9)** to enter a two-digit number or press **▼** or **▲** until the screen displays the correct value. Press **MENU/SELECT** to advance.
5. Repeat step 3 until the date and time are set.

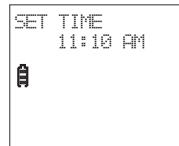
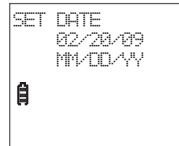

## Telephone settings

### note

If the date and time are not set, the system announces, “*Time and day not set,*” before each message plays.

### Clear voicemail

If you subscribe to voicemail service offered by your telephone company, **NEW VOICEMAIL** and  appear on the handset when you have new voicemail messages. Contact your local telephone company for more information and assistance about using your voicemail service.

After you have listened to all new voicemail messages, the indicators on the handset turn off automatically.

Use the clear voicemail feature when the telephone indicates that there is new voicemail but there is none (for example, when you have accessed your voicemail while away from home). Clearing the voicemail waiting indicator only turns off the indicators; it does not delete your voicemail messages. As long as you have new voicemail messages, your local telephone company continues to send the signal to turn on the indicators.

To manually turn off these indicators:

1. Press **MENU/SELECT** to show the menu when the handset is not in use.
2. Press **▲** or **▼** to select **>Settings**, then press **MENU/SELECT**.
3. Press **▲** or **▼** to select **>Clr voicemail**, then press **MENU/SELECT**. The screen shows **Turn off indicator?**  
Press **MENU/SELECT** to confirm your selection.

### note

- Your telephone service provider might alert you to new messages with a stutter (broken) dial tone. Contact your service provider for details.
- Voicemail is different from answering system messages recorded in your answering system. For more information about the difference, see page 31.



# Telephone settings

## Home area code

If you dial your local calls using only seven digits (area code not required), you can program your home area code so that when you receive a call within your local area, the telephone number is automatically stored without the area code in the call log.

1. Press **MENU/SELECT** to show the menu when the handset is not in use.
2. Press **▲** or **▼** to select **>Settings**, then press **MENU/SELECT**.
3. Press **▲** or **▼** to select **>Home area code**, then press **MENU/SELECT**.
4. Use the dialing keys to enter the desired home area code.
  - Press **MUTE/REMOVE** to delete a digit.
  - Press and hold **MUTE/REMOVE** to delete the entire entry.
4. Press **MENU/SELECT** to confirm.

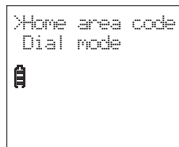

### note

If, in the future, your telephone company requires you to dial the area code when making a local call, or, if you move to a location that requires it, delete the home area code you have already programmed, following the steps above. After you have deleted the home area code, \_ \_ \_ will appear in the display.

## Dial mode

You can choose between tone or pulse dialing mode.

1. Press **MENU/SELECT** to show the menu when the handset is not in use.
2. Press **▲** or **▼** to select **>Settings**, then press **MENU/SELECT**.
3. Press **▲** or **▼** to select **>Dial mode**, then press **MENU/SELECT**.
4. Press **▲** or **▼** to choose **Tone** or **Pulse**.
5. Press **MENU/SELECT** to confirm your selection.



# Answering system settings

## Answering system set up

Use a system handset to change your answering system settings.

### Number of rings

You can choose from two, four, or six rings; or toll saver. With toll saver selected, the answering system answers after two rings when you have new messages, and after four rings when you have no new messages. This enables you to check for new messages and avoid paying unnecessary long distance charges if you are calling from out of your local area.

1. Press **MENU/SELECT** to show the menu when the handset is not in use.
2. Press **MENU/SELECT** to select **>Answering Sys.**
3. Press **▲** or **▼** to select **>Ans sys setup**, then press **MENU/SELECT**.
4. Press **▲** or **▼** to select **># of rings**, then press **MENU/SELECT**.
5. Press **▲** or **▼** to choose from **2, 4, 6** or **TOLL SAVER**, then press **MENU/SELECT** to confirm your selection.

### Remote code

A two-digit security code is required to access the answering system remotely from any touch tone telephone. The preset code is **19**. You can set the code from **10** to **99**.

1. Press **MENU/SELECT** to show the menu when the handset is not in use.
2. Press **MENU/SELECT** to select **>Answering Sys.**
3. Press **▲** or **▼** to select **>Ans sys setup**, then press **MENU/SELECT**.
4. Press **▲** or **▼** to select **>Remote code**, then press **MENU/SELECT**.
5. Press **▲** or **▼** to select from **10** to **99**, then press **MENU/SELECT** to confirm.

### Message alert tone

This telephone can beep every 10 seconds to alert you of new messages. The tone stops when all new messages have been reviewed.

1. Press **MENU/SELECT** to show the menu when the handset is not in use.
2. Press **MENU/SELECT** to select **>Answering Sys.**
3. Press **▲** or **▼** to select **>Ans sys setup**, then press **MENU/SELECT**.
4. Press **▲** or **▼** to select **>Msg alert tone**, then press **MENU/SELECT**.
5. Press **▲** or **▼** to select from **On** or **Off**, then press **MENU/SELECT** to confirm your selection.

#### note

- The answering system must be turned on for the message alert tone to function.
- Press any key on the telephone base (except **FIND HANDSET**) to temporarily silence the message alert tone.



# Answering system settings

## Announcement

The telephone is preset with a greeting that answers calls with *“Hello, please leave a message after the tone.”* You can use this preset announcement, or replace it with your own.

## Play your announcement

1. Press **MENU/SELECT** to show the menu when the handset is not in use.
2. Press **MENU/SELECT** to select **>Answering Sys.**
3. Press **▲** or **▼** to select **>Announcement**, then press **MENU/SELECT**.
4. The handset announces, *“To play, press 2. To record, press 7.”* Press **2** to play.

## Record your own announcement

1. Press **MENU/SELECT** to show the menu when the handset is not in use.
2. Press **MENU/SELECT** to select **>Answering Sys.**
3. Press **▲** or **▼** to select **>Announcement**, then press **MENU/SELECT**.
4. The handset announces, *“To play, press 2. To record, press 7.”* Press **7** to record.
5. The handset announces, *“Record after the tone. Press 5 when you are done.”*
6. After the tone, speak towards the microphone of the handset.
7. Press **5** when finished.
8. The answering system automatically plays back the newly recorded announcement. Press **5** to stop the playback at anytime; **2** to replay the recorded announcement; or **7** to record again if desired.

### note

- Your announcement can be up to 90 seconds in length.
- Announcements shorter than two seconds will not be recorded.

## Delete your announcement

1. Press **MENU/SELECT** to show the menu when the handset is not in use.
2. Press **MENU/SELECT** to select **>Answering Sys.**
3. Press **▲** or **▼** to select **>Announcement**, then press **MENU/SELECT**.
4. The handset announces, *“To play, press 2. To record, press 7.”* Press **3** to delete your own recorded announcement.

### note

When your announcement is deleted, calls are answered with the preset announcement.

# Telephone operation

## Make a call

1. Press **TALK/FLASH** or **☎**. You hear a dial tone.
2. Dial the number.

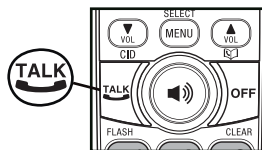

## Predial a call

1. Dial the number.
2. Press **TALK/FLASH** or **☎**.

## Answer a call

Press **TALK/FLASH**, **☎** or any of the dialing keys (**0-9**, **#**, **\***).

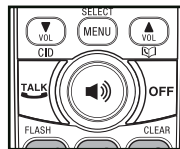

### note

- The screen shows the elapsed time as you talk (in hours, minutes and seconds).
- When predialing (preview numbers before dialing), press **MUTE/REMOVE** or **OFF/CLEAR** to backspace and delete; press and hold REDIAL/PAUSE to insert a dialing pause (a **p** appears).

## End a call

Press **OFF/CLEAR** or put the handset in the telephone base or charger.

## Speakerphone

During a call, press **☎** to switch between speakerphone and normal handset use. When the speakerphone is active, the handset screen shows **SPEAKER**.

## Volume

During a call, press **VOL▲** or **▼VOL** to adjust the listening volume.

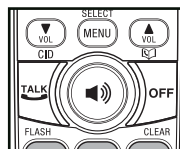

## Telephone operation

### Mute

The mute function allows you to hear the other party but the other party cannot hear you.

1. During a call, press **MUTE/REMOVE** on the handset. The handset screen shows **MUTED** for a few seconds and **MUTE** appears until the mute function is turned off.
2. Press **MUTE/REMOVE** again to resume the conversation. The handset screen temporarily shows **MICROPHONE ON**.

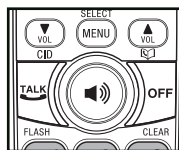

### Ringer mute

When the telephone is ringing, press **OFF/CLEAR** or **MUTE/REMOVE** to temporarily silence the ringer without disconnecting the call. The next call rings normally.



### Call waiting

When you subscribe to call waiting service from your telephone company, you hear an alert tone if there is an incoming call while you are on another call.

Press **TALK/FLASH** to put your current call on hold and take the new call. Press **TALK/FLASH** at any time to switch back and forth between calls.

### Find handset

Use this feature to page all system handsets.

1. Press **FIND HANDSET** on the telephone base. All idle handsets ring and the screens show **\*\* PAGING \*\***.
2. To end paging, press **TALK/FLASH**, **OFF**, any dialing keys (**0-9**, **#**, **\***), or press **FIND HANDSET** on the telephone base.



#### note

Paging rings all the registered handsets even if the ringer volume is set to off.

## Telephone operation

### Voice language (Canada only)

You can select **English** or **Français** for the voice prompts used in the answering system.

To change the setting:

1. Press **MENU/SELECT** to display the menu when the handset is not in use.
2. Press **MENU/SELECT** to select **>Answering Sys.**
3. Press **▲** or **▼** to select **>Ans sys setup**, then press **MENU/SELECT**.
4. Press **▲** or **▼** to select **>Voice language**, then press **MENU/SELECT**.
5. Press **▲** or **▼** to choose from **English** or **Français**, then press **MENU/SELECT** to confirm your selection.

### Chain dialing

Use this feature to initiate a dialing sequence from numbers stored in the directory, call log or redial while you are on a call.

Chain dialing can be useful if you wish to access other numbers (such as bank account information or access codes) from the directory, call log or redial list.

#### To access a number in the directory while on a call:

1. Press **MENU/SELECT** twice to select **>Directory**.
2. Scroll to the desired entry by pressing **▲** or **▼**.
3. Press **MENU/SELECT** to dial the displayed number.

#### To access a number in the call log while on a call:

1. Press **MENU/SELECT** and then press **▲** or **▼** to highlight **>Call log**.
2. Press **MENU/SELECT** to select.
3. Scroll to the desired entry by pressing **▲** or **▼**.
4. Press **MENU/SELECT** to dial the displayed number.

#### To access the last number on the redial list while on a call:

Press **REDIAL/PAUSE** to dial. Press **REDIAL/PAUSE** again within two seconds to cancel the chain dialing.

#### note

- You cannot edit a directory entry while on a call. For more details about the directory, see page 20.
- You cannot copy a call log entry into the directory while on a call. For more details about call log, see page 27.
- If you press **REDIAL/PAUSE** while on a call, you can only view the most recent call, and you cannot erase the entry. For more details about the redial memory, see page 30.
- Press and hold **OFF/CLEAR** to exit redial, directory or call log when you are on a call.

# Telephone operation

## Multiple handset use

You can use up to two system handsets at a time on an outside call. If a handset is already on a call and you would like to join the call, press **TALK/FLASH** or **Ⓜ** on another handset to join the call.

To end the call, press **OFF/CLEAR** or place the handset in the telephone base or charger. The call will not be terminated until all handsets hang up.

You can buy additional expansion handsets (model **CS6309**) for this telephone base. You can register up to five handsets to the telephone base.

## Intercom

Use the intercom feature for conversation between two system handsets.

1. Press **INT** on your handset when not in use.

- If you have a two-handset system, your handset screen shows **Calling other handset**.
- If you have more than two handsets, your screen shows **Intercom to:**. Use the dialing keys to select the other handset. Your handset screen shows **Calling handset X**.

The other handset rings and its screen shows either **Other handset is calling** or **Handset X is calling**.

2. To answer the intercom call, press **TALK/FLASH**, **Ⓜ**, **INT**, or any dialing keys (**0-9**, **#**, **\***) on the other handset. Both handsets now show **INTERCOM**.

3. To end an intercom call, press **INT**, **OFF/CLEAR**, or place the handset back in the telephone base or charger.

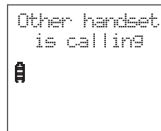
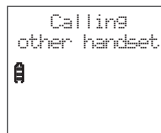

### note

- You can cancel the intercom call before it is answered by pressing **OFF/CLEAR** or **INT** on your originating handset.
- If the other handset does not answer the intercom call within 60 seconds, is in the directory or call log, or is out of range, your originating handset screen shows **Unable to call try again** and returns to idle mode.
- Press **OFF/CLEAR** or **MUTE/REMOVE** on the other handset to temporarily silence the intercom ringer.
- You can use a maximum of four handsets at a time. When two handsets are used on an intercom call, use two other system handsets for an outside call.

## Answer an incoming call during an intercom call

If you receive an incoming outside call during an intercom call, there will be an alert tone.

- To answer the call, press **TALK/FLASH**. The intercom call ends automatically.
- To end the intercom call without answering the incoming call, press **OFF/CLEAR**.

# Telephone operation

## Share an outside call

You can call another system handset to join an outside call. That call continues even if you hang up.

1. Press **MENU/SELECT** while on a call and then press **▲** or **▼** to highlight **>Transfer**.
2. Press **MENU/SELECT** to select. The outside call is put on hold.
  - If you have a two-handset system, your handset screen shows **Calling other handset**. The other handset rings and its screen shows **Other handset is calling**.
  - If you have more than two handsets, your screen shows **Transfer to:**. Use the dialing keys to select the other handset. Your screen then shows **Calling handset X**. The other handset rings and its screen shows **Handset X is calling**.
3. To answer the call on the other handset, press **TALK/FLASH**, **INT**, or any dialing keys (**0-9**, **#**, **\***). The outside call is still on hold and both handsets now show **INTERCOM**. You can now have a private conversation between the system handsets.

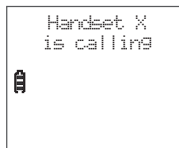
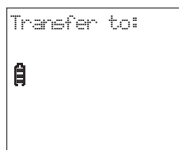

### note

- If you want to cancel an intercom call and reconnect to the outside call before the other handset answers, press **TALK/FLASH**, **OFF/CLEAR** or **INT** on your originating handset.
  - If the other handset does not answer the intercom call within 60 seconds, is in the directory or call log, or is out of range, your originating handset screen shows **Unable to call try again** and reconnects to the outside call automatically.
4. From this intercom call, you have the following options:
    - You can let the other handset join you on the outside call in a three-way conversation. Press and hold **INT** on your originating handset.
    - You can transfer the call. Press **OFF/CLEAR**, or place your handset back in the telephone base or charger. Your screen shows **Call transferred**. The other handset is automatically connected to the outside call.
    - You can alternate between the outside call (**OUTSIDE CALL** appears on the screen) and the intercom call (**INTERCOM** appears on the screen). Press **INT** repeatedly on your originating handset.
    - The other person can leave the intercom call by pressing **OFF/CLEAR**, or placing the other handset back in the telephone base or charger. The outside call continues with the original system handset.

# Telephone operation

## Directory

The directory can store up to 100 entries with up to 30 digits for each phone number and 15 characters for each name.

- Directory entries are shared by all system handsets. Any additions, deletions or edits made on one handset affect the directory on all handsets.
- When there are no records in the directory, the screen shows **Directory empty**.
- When the directory is full and you try to save an entry, the screen shows **Directory full**.
- If you try to save a number already stored in the directory, the screen shows **Already saved**.
- If the telephone number in the directory exceeds 15 digits, <\* appears in front of the telephone number. Press \* to move towards the end of the telephone number or press # to move towards the beginning of the telephone number.
- Only one handset can review the directory at a time. If a handset tries to enter the directory while another handset is already in it, **Not available at this time** appears.

Directory empty



Directory full



Already saved



ELIZABETH JONES  
<\*180012345678



ELIZABETH JONES  
<\* 800123456 #>



ELIZABETH JONES  
123456789012 #>



# Telephone operation

## Store a directory entry

Use the following steps to store an entry in the directory.

1. Enter the number when the handset is not in use and press **MENU/SELECT**.  
Go to step 4.

**-OR-**

1. Press **MENU/SELECT** when the handset is not in use.
2. Press **▲** or **▼** to select **>Directory** and then press **MENU/SELECT**.
3. Press **▲** or **▼** to select **>Add contact**, then press **MENU/SELECT**. The screen shows **ENTER NUMBER**.
4. Use the dialing keys to enter or modify the number.
  - Press **MUTE/REMOVE** to backspace and erase a digit.
  - Press and hold **MUTE/REMOVE** to erase the entire entry.
  - Press **▼** to move the cursor to the left or **▲** to the right.
  - Press and hold **REDIAL/PAUSE** to insert a dialing pause (a **p** appears).

**- OR-**

Copy a number from the redial list by pressing **REDIAL/PAUSE** and then **▲**, **▼** or **REDIAL/PAUSE** to select a number. Press **MENU/SELECT** to copy the number.

5. Press **MENU/SELECT** to move to the name. The screen shows **ENTER NAME**.
6. Use the dialing keys (see page 22) to enter the name.
  - Press **MUTE/REMOVE** to backspace and erase a character.
  - Press and hold **MUTE/REMOVE** to erase the entire entry.
  - Press **▼** to move the cursor to the left or **▲** to the right.
7. Press **MENU/SELECT** to confirm. The screen shows **Set Speed dial?**
  - To exit, press **OFF/CLEAR**.
  - To set speed dial, press **MENU/SELECT**. The first available slot displays or the first speed dial entry displays when there is no empty slot.
8. Press **▲** or **▼** to choose the desired slot or entry and press **MENU/SELECT** to confirm.
  - If it is not an empty slot, the screen shows **Replace?** Press **MENU/SELECT** to replace the entry or press **OFF/CLEAR** to exit speed dial setting.

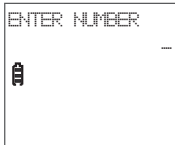



# Telephone operation

## Character chart

Use the dial pad and the chart below to enter a name (up to 15 characters). Each press of a particular key causes the characters to be displayed in the following order:

Number key	Characters by number of key presses										
	1	2	3	4	5	6	7	8	9	10	11
1	.	-	'	(	)	*	#	&	/	,	1
2	A	B	C	a	b	c	2				
3	D	E	F	d	e	f	3				
4	G	H	I	g	h	i	4				
5	J	K	L	j	k	l	5				
6	M	N	O	m	n	o	6				
7	P	Q	R	S	p	q	r	s	7		
8	T	U	V	t	u	v	8				
9	W	X	Y	Z	w	x	y	z	9		
0	0										
*	*										
#	space										

**note**

When entering a name in the directory, the first letter of each word is automatically capitalized.

# Telephone operation

## Search the directory

Entries are sorted alphabetically. To search the directory:

1. Press ▲ when the handset is not in use.

**-OR-**

Press **MENU/SELECT** when the handset is not in use.

Press ▲ or ▼ to select **>Directory** and then press **MENU/SELECT** twice.

2. Press ▲ or ▼ to browse.



```
>Review
Add contact
```



## Alphabetical search

To start an alphabetical search:

1. Press ▲ when the handset is not in use.

**-OR-**

Press **MENU/SELECT** when the handset is not in use. Press ▲ or ▼ to select **>Directory** and then press **MENU/SELECT** twice.

2. Use the dialing keys to enter the letters associated with the name. For example, if you have name entries Jenny, Kristen and Linda in your directory, press **5** (JKL) once to find Jenny, twice to find Kristen, or three times to find Linda. If there is no name entry matching your search, the next closest match in alphabetical order appears. If necessary, press ▲ or ▼ to browse.



```
Mike Smith
800-595-9511
```



## Dial a directory entry

1. Press ▲ when the handset is not in use.

**-OR-**

Press **MENU/SELECT** when the handset is not in use. Press ▲ or ▼ to select **>Directory** and then press **MENU/SELECT** twice.

2. Press ▲ or ▼, or use the alphabetical search to browse.
3. Press or .

# Telephone operation

## Edit a directory entry

Use the following steps to edit an entry in the directory.

1. Press **▲** when the handset is not in use.

**-OR-**

Press **MENU/SELECT** when the handset is not in use. Press **▲** or **▼** to select **>Directory** and then press **MENU/SELECT** twice.

2. Press **▲** or **▼**, or use the alphabetical search to browse (see page 23).

3. Press **MENU/SELECT** to select an entry. The screen shows **EDIT CONTACT**.



4. Press **▲** or **▼** to choose **Name**, **Number** or **Speed dial** to edit. Press **MENU/SELECT** to select the desired option.

- If you have not assigned a speed dial for the entry and choose to edit speed dial, follows the steps 7 and 8 on page 21.

5. While the screen shows **EDIT NAME**, use the dialing keys (see page 22) to edit the name. Press **MENU/SELECT** to save the setting.



- Press **MUTE/REMOVE** to backspace and erase a character.

- Press and hold **MUTE/REMOVE** to erase the entire entry.
- Press **▼** to move the cursor to the left or **▲** to the right.

**-OR-**

While the screen shows **EDIT NUMBER**, use the dialing keys to edit the number. Press **MENU/SELECT** to save the setting.



- Press **MUTE/REMOVE** to backspace and erase a digit.
- Press and hold **MUTE/REMOVE** to erase the entire entry.
- Press **▼** to move the cursor to the left or **▲** to the right.
- Press and hold **REDIAL/PAUSE** to insert a dialing pause (a **p** appears).



**-OR-**

While the screen shows **ASSIGN AS** and the current speed dial location displays, press **▲** or **▼** to choose the desired speed dial slot and press **MENU/SELECT** to save the setting.

- If the desired slot is not an empty slot, the screen shows **Replace?** Press **MENU/SELECT** to replace the entry or press **OFF/CLEAR** to exit speed dial setting.

6. After the setting is saved, press **MENU/SELECT** again to edit the other setting. Repeat steps 4 and 6 until all the settings are correct.

## Telephone operation

### Delete from the directory

1. Press  ▲ when the handset is not in use.

**-OR-**

Press **MENU/SELECT** when the handset is not in use. Press ▲ or ▼ to select >**Directory** and then press **MENU/SELECT** twice.

2. Press ▲ or ▼, or use the alphabetical search to browse.

3. Press **MUTE/REMOVE** to remove the selected entry and the screen shows **Delete contact?** Press **MENU/SELECT** to confirm and **Contact deleted** displays.

# Telephone operation

## About caller ID

This product supports caller ID services provide by most local telephone service companies. Depending on your service subscription, you may see the caller's number, or the caller's name and number that are sent by the telephone company after the first or second ring. Caller ID allows you to see the name, number, date and time of calls.

Caller ID with call waiting lets you see the name and telephone number of the caller before answering the telephone, even while on another call.

It may be necessary to change your telephone service to use this feature. Contact your telephone company if:

- You have both caller ID and call waiting, but as separate services ( you may need to combine these services).
- You have only caller ID service, or only call waiting service.
- You do not subscribe to caller ID or call waiting services.

There are fees for caller ID services. In addition, services may not be available in all areas.

This product can provide information only if both you and the caller are in areas offering caller ID service and if both telephone companies use compatible equipment. The time and date are sent by the telephone company along with the call information.

You can use this product with regular caller ID service, or you can use this product's other features without subscribing to either caller ID or combined caller ID with call waiting service.

# Telephone operation

## Call log

If you subscribe to caller ID service, information about each caller will appear after the first or second ring. If you answer a call before the caller information appears on the screen, it will not be saved in the call log.

- The call log stores up to 50 entries. Each entry has up to 24 digits for the phone number and 15 characters for the name. If the phone number has more than 15 digits, only the last 15 digits appear. If the name has more than 15 characters, only the first 15 characters are shown and saved in the call log.
- You can review, redial, and copy an entry into the directory.
- Entries appear in reverse chronological order.
- When the call log is full, the oldest entry is deleted to make room for new incoming call information.
- **XX MISSED CALL(S)** shows when there are new call log entries (including missed and unreviewed calls).
- **CALL LOG EMPTY** shows when there are no records in the call log.
- Only one handset can review the call log at a time. If a handset tries to enter the call log while another handset is already in it, **Not available at this time** appears.



### note

- The caller ID information may not be available for every incoming call. The callers may intentionally block their names and/or telephone numbers.
- For call log entries with numbers between 16 and 24 digits, in order to view the entire number, you must save the entry to the directory (see page 29).
- If the phone number has more than 24 digits, it will not be saved or shown in the call log.

## Missed calls indicator

When there are unreviewed calls in the call log, the handset shows **XX MISSED CALL(S)**.

Each time you review a call log entry marked **NEW**, the number of missed calls decreases by one.

When you have reviewed all the missed calls, the missed calls indicator no longer shows.

If you do not want to review the missed calls one by one, press and hold **OFF/CLEAR** to erase the missed calls indicator. All the entries are then considered old and kept in the call log.



# Telephone operation

## Review the call log

1. Press **CID** ▼ when the handset is not in use.
2. Press ▲ or ▼ to browse through the call log.

**-OR-**

1. Press **MENU/SELECT** when the handset is not in use.
2. Press ▲ or ▼ to select **>Call log**, then press **MENU/SELECT**.
3. Press ▲ or ▼ to select **>REVIEW**, then press **MENU/SELECT**.
4. Press ▲ or ▼ to browse through the call log.
  - The name (if available), telephone number, date and time of all incoming calls are shown on the screen.
  - You hear a double beep when the list reaches the beginning or end of the call log.



## Make a call log entry ready to dial

Although the call log entries received have 10 digits (the area code plus the seven-digit number), in some areas, you might need to dial only the seven digits, or **1** plus the seven digits, or **1** plus the area code plus the seven digits. You can change the number of digits that you dial from the call log and store to the directory.

While reviewing the call log, press **#** repeatedly to show different dialing options for local and long distance numbers before dialing or saving the telephone number in the directory.

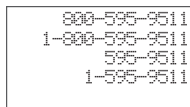

Press **1** repeatedly if you need to add or remove **1** in front of the telephone number before dialing or saving it in the directory.

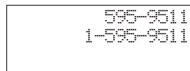

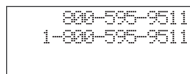

When the number is shown in the correct format for dialing, press **TALK FLASH** or **Ⓜ** to call the number.



# Telephone operation

## Dial a call log entry

1. When in the call log, press ▲ or ▼ to browse.
2. Press  or  to dial the entry.

## Save a call log entry to the directory

1. When in the call log, press ▲ or ▼ to browse.
2. Press **MENU/SELECT** to select an entry. The screen displays **EDIT NUMBER**.
3. Use the dialing keys to edit the number.
  - Press **MUTE/REMOVE** to backspace and erase a digit.
  - Press and hold **MUTE/REMOVE** to erase the entire entry.
  - Press ▼ to move the cursor to the left or ▲ to the right.
  - Press and hold **REDIAL/PAUSE** to insert a dialing pause (a **p** appears).
4. Press **MENU/SELECT** to move to the name. The screen displays **EDIT NAME**.
5. Use the dialing keys (see page 22) to edit the name.
  - Press **MUTE/REMOVE** to backspace and erase a character.
  - Press and hold **MUTE/REMOVE** to erase the entire entry.
  - Press ▼ to move the cursor to the left or ▲ to the right.
6. Press **MENU/SELECT** to save.
  - If the entry is already saved in the directory, the handset shows **Already saved**.
  - If there is no caller ID information, the handset shows **UNABLE TO SAVE**.

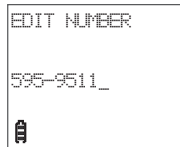

## Delete from the call log

To delete one entry:

1. When in the call log, press ▲ or ▼ to browse.
2. Press **MUTE/REMOVE** to delete the selected entry.

To delete all entries:

1. Press **MENU/SELECT** when the handset is not in use.
2. Press ▲ or ▼ to select **>Call log**, then press **MENU/SELECT**.
3. Press ▲ or ▼ to select **>DEL ALL CALLS**, then press **MENU/SELECT**.
4. The screen shows **DELETE ALL CALLS? PRESS SELECT TO CONFIRM**. Press **MENU/SELECT** to confirm.





# Telephone operation

## Call log display screen messages

Displays	When
PRIVATE NAME	The caller is blocking the name.
PRIVATE NUMBER	The caller is blocking the telephone number.
PRIVATE CALLER	The caller is blocking the name and number.
UNKNOWN NAME	This caller's name is unavailable.
UNKNOWN NUMBER	This caller's number is unavailable.
UNKNOWN CALLER	No information is available about this caller.
LONG DISTANCE OR L (before the caller's number)	It is a long distance call.

## Redial list

The telephone stores the five most recently dialed numbers.

- When there are already five entries, the oldest entry is deleted to make room for the new entry.
- Entries are shown in reverse chronological order.
- Press **REDIAL/PAUSE** to browse the redial list.

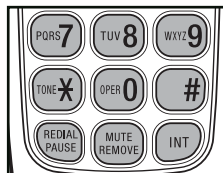

## Dial a redial entry

1. Press **REDIAL/PAUSE**, then ▲, ▼ or **REDIAL/PAUSE** to browse. You hear a double beep when it reaches the beginning or end of the redial list.
2. Press **TALK/FLASH** or **MUTE** to dial the number.

## Delete from redial

1. Press **REDIAL/PAUSE**, then ▲, ▼ or **REDIAL/PAUSE** to browse.
2. Press **MUTE/REMOVE** to delete the selected entry.

## Answering system operation

### Answering system and voicemail

Your telephone has both a digital answering system and voicemail indication. Most telephone companies offer voicemail service (fees may apply). Your telephone's answering system and voicemail indication are independent features, and each alerts you to new messages differently. For more information on the voicemail indicators, see page 11. To listen to your voicemail, follow the instructions provided by your voicemail service provider. To listen to messages recorded on your digital answering system, see page 33.

If you subscribe to a voicemail service through your telephone service provider, you can use your telephone answering system and voicemail together. If you are on a call, or the answering system is busy and you receive another call, the second caller can leave a voicemail message. Set your answering system to answer calls at least two rings earlier than your voicemail is set to answer. For example, set your voicemail to answer calls after six rings and set your answering system to answer after four rings.

**note**

Some telephone companies program the delay before answering calls in seconds instead of rings; in this case, allow six seconds per ring when determining the appropriate setting.

### Message capacity

The answering system can record and store up to 99 messages. Each message can be up to four minutes in length. The total storage capacity for the announcement, messages and memos is approximately 14 minutes. The actual recording time depends on individual message characteristics. Messages remain available for replay until you delete them.

## Answering system operation

### Turn the answering system on or off

The answering system must be turned on to answer and record messages.

When the answering system is turned on, the **ANS ON/OFF** light on the telephone base will be on and **ANS ON** will display on the handset.

#### To turn on or off with the telephone base:

- Press **ANS ON/OFF** to turn the answering system on or off. When the answering system is turned on, it announces, *"Calls will be answered."* When the answering system is turned off, it announces, *"Calls will not be answered."*

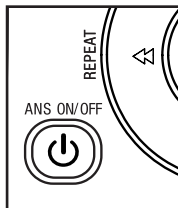

#### To turn on or off with a handset:

1. Press **MENU/SELECT** to show the menu when the handset is not in use.
2. Press **MENU/SELECT** to select **>Answering Sys.**
3. Press **▲** or **▼** to select **>Ans sys setup**, then press **MENU/SELECT**.
4. Press **MENU/SELECT** to select **>ANSWER ON/OFF**.
5. Press **▲** or **▼** to choose **ON** or **OFF**, then press **MENU/SELECT**.

## Call screening

You can listen at the telephone base to a caller leaving a message. If you want to turn off the call screening feature, set the telephone base volume to zero. Remember to raise the volume in order to hear your messages during playback.

## Call intercept

If you want to talk to the person whose message is being recorded, press **TALK FLASH** on the handset.

## Telephone base ringer volume

Press **VOL+▲** or **VOL-▼** on the telephone base to adjust the ringer volume when the telephone is not in use. When you set the ringer volume to zero, the base ringer is off and the system announces, *"Base ringer is off."*

**note**

See page 9 to set the handset ringer volume.

# Answering system operation

## New message indication

The message window on the telephone base flashes and **00** shows on the handset when there are new answering system messages.

If the new message alert tone is turned on, the telephone base beeps every 10 seconds when there are unreviewed messages.

## Message playback

If you have new messages, the telephone plays only the new messages (oldest first). If there are no new messages, the telephone plays back all messages (oldest first).

When playback begins, you hear the total number of messages followed by the day and time of the message. After the last message, the telephone announces, *"End of messages."*

### To play messages with the telephone base:

1. Press **▶/■/PLAY/STOP** to listen to messages.

Options during playback:

- Press **VOL-▼** or **VOL+▲** to adjust the speaker volume.
- Press **▶/SKIP** to skip to the next message.
- Press **◀/REPEAT** to repeat the message currently playing. Press **◀/REPEAT** twice to listen to the previous message.
- Press **X/DELETE** to delete the current message. The system advances to the next message.
- Press **▶/■/PLAY/STOP** to stop.

### To play messages with a handset:

1. Press **MENU/SELECT** to show the menu when the handset is not in use.
2. Press **MENU/SELECT** to select **>Answering Sys.**
3. Press **MENU/SELECT** to select **>PLAY MSGS.**

Options during playback:

- Press **▼ VOL ▲** to adjust the speaker volume.
- Press **6** to skip to the next message.
- Press **4** to repeat the message currently playing. Press **4** twice to listen to the previous message.
- Press **3** to delete the current message. The system advances to the next message.
- Press **5** to stop.

#### note

- When the answering system has less than five minutes of recording time left, the remaining time is announced.
- When **F** and number of messages are flashing in the message window, the memory is full. Delete some messages to make room for more.
- You can only delete old messages, which are messages you have played.

## Answering system operation

### Delete all messages

#### To delete all messages with the telephone base:

Press **X/DELETE** when the phone is not in use. The telephone announces, "To delete all old messages, press **DELETE** again." Press **X/DELETE** again. All previously heard messages are erased and the telephone announces, "All old messages deleted."

#### To delete all messages with a handset:

1. Press **MENU/SELECT** to show the menu when the handset is not in use.
2. Press **MENU/SELECT** to select **>Answering Sys.**
3. Press **▲** or **▼** to select **>DEL ALL OLD**, then press **MENU/SELECT**.
4. The handset shows **DELETE ALL MESSAGES? PRESS SELECT TO CONFIRM**. Press **MENU/SELECT** to confirm your selection.

### Record and play memos

Memos are your own recorded messages used as reminders for yourself or others using the same answering system. You can record your own memos using a system handset. Playback and delete them in the same way as incoming messages.

#### Record a memo

1. Press **MENU/SELECT** to show the menu when the handset is not in use.
2. Press **MENU/SELECT** to select **>Answering Sys.**
3. Press **▲** or **▼** to select **>RECORD MEMO**, then press **MENU/SELECT**.
4. The handset announces, "Record after the tone. Press **5** when you are done." After the tone, speak towards the microphone of the handset.
5. Press **5** when finished recording. The handset announces, "Recorded."

#### note

- "Memory is full," is announced if you record a memo when the memory is full.
- Each memo can be up to four minutes in length.
- Memos shorter than one second are not recorded.

# Answering system operation

## Message window displays

Window display	Description
0	No messages.
1-99	Total number of old messages recorded.
0-99 (flashing)	Total number of messages recorded. The telephone base might have lost and regained power. The clock needs to be set.
1-99 & F (alternating)	Memory is full with total number of messages recorded.
1-99 (flashing)	Current message number during new message playback.
1-99	Current message number during old message playback.
1-8	Telephone base speaker volume level while adjusting.
.....	The system is answering a call, or recording a memo or announcement. Telephone is answering a call or being accessed remotely. The answering system is being programmed.
0-6	Telephone base ringer level while adjusting.

**note**

When the memory is full, the answering system answers incoming calls after 10 rings and announces, *"Memory is full. Enter the remote access code."*

# Answering system operation

## Remote access

A two-digit security code is required to access the answering system remotely from any touch tone telephone. The preset code is **19**; see **Remote code** on page 13 to change it.

1. Dial your telephone number from any touch tone telephone.
2. When the system plays your announcement, enter the two-digit security code.
3. You can also enter one of the following remote commands.

Command	Function
1	Play all messages.
2	Play only new messages.
3	Delete the current message (during playback).
33	Delete all messages.
4	Repeat the current message (during playback).
5	Stop.
*5	Hear a list of remote commands.
6	Skip to the next message (during playback).
*7	Record a new announcement.
8	End the call.
0	Turn the answering system on or off.

4. Hang up or press **8** to end the call.

### note

- If you do not press any keys after you enter the remote access code, all new messages play. If there are no new messages, all old messages play.
- Once the new messages have played, the telephone announces the help menu options. If you do not press any key within 20 seconds, the remote access call automatically disconnects.
- When the answering system is turned off, the telephone answers after 10 rings, and announces, *"Please enter your remote access code."*

# Appendix

## Handset display screen messages

Already saved	The telephone number entered is already stored in the directory.
CALL LOG EMPTY	There are no call log entries.
Calling handset X (for models with three or more handsets) Calling other handset (for models with two handsets)	Calling another handset.
CONNECTING...	The cordless handset is searching for the telephone base.
CHARGING	The handset with low battery is recharging.
Directory empty	There are no directory entries.
ENDED	You have just ended a call.
Handset X is calling (for models with three or more handsets) Other handset is calling (for models with two handsets)	Another system handset is calling.
INCOMING CALL	There is an incoming call.
INT REQUIRES TWO HANDSETS	Two handsets are required for an intercom call.
INTERCOM	The handset is on an intercom call.
INTERCOM ENDED	You have just ended an intercom call.
LINE IN USE	A system handset or another telephone on the same line is in use.
Directory full	The directory is full.
LOW BATTERY	The battery needs to be recharged.
MICROPHONE ON	<b>MUTE</b> is turned off and the person on the other end can hear you.
MUTED	You have turned off the handset microphone. The other party cannot hear you but you can hear the other party.
NEW VOICEMAIL	There are new voicemail messages from your telephone company.



## Appendix

### Handset display screen messages

NO LINE	There is no telephone line connected.
NO SIGNAL, CALL ENDED	Communication between handset and telephone base is lost during a call.
NOT AVAILABLE AT THIS TIME	One handset is already viewing the call log or directory and another handset attempts to review it.
OUTSIDE CALL	Connected to the external call during call transfer.
**PAGING**	The cordless handset locator is activated.
PHONE	The handset is on a call.
PLACE IN CHARGER	The battery is very low. Place the handset in the telephone base or charger for recharging.
RINGER MUTE	The ringer is muted temporarily during an incoming call.
SAVED	Your selection has been saved.
SPEAKER	The handset speakerphone is in use.
UNABLE TO CALL TRY AGAIN	You have attempted to make an intercom call, but the handset you are calling is in the directory, in the call log, out of range or on an outside call.
UNABLE TO SAVE	You are attempting to save a caller ID entry with no name or number.
XX MISSED CALLS	There are unreviewed calls in your call log.

# Appendix

## Handset and telephone base indicators





### Handset lights

	On when the handset speakerphone is in use.
<b>CHARGE</b>	On when the handset is charging in the telephone base or charger.

### Telephone base lights

<b>IN USE</b>	Flashes when there is an incoming call or another telephone sharing the same line is in use. On when the handset is in use.
<b>VOICEMAIL</b>	Flashes when you have new voicemail from your telephone company.
<b>ANS ON/OFF</b>	On when the answering system is on.

### Handset icons

<b>ANS ON</b>	Answering system is turned on.
<b>MUTE</b>	Microphone is muted.
	Handset ringer off.
<b>OO</b>	New answering system messages.
MSG# [ 1/13 ]	Message number currently playing and total number of messages recorded.
<b>NEW</b>	New call log entries.
NEW VOICEMAIL 	New voicemail received from the telephone company.
SPEAKER 	Speakerphone is in use.
  <b>(Battery indicator)</b>	Cycles (low, medium, and full) when the handset battery is charging. Flashes when the battery is low and needs charging. Solid when the battery is fully charged.

# Appendix

## Battery

It takes up to 16 hours for the battery to be fully charged. When it is fully charged, you can expect the following performance:

Operation	Operating time
While in handset use (talking*)	Up to seven hours
While in speakerphone mode (talking*)	Up to five hours
While not in use (standby**)	Up to seven days

\*Operating times vary depending on your actual use and the age of the battery.

\*\*Handset is not charging or in use.

The battery needs charging when:

- A new battery is installed in the handset.
- The handset beeps.
- A battery is properly installed and the screen is blank.
- **LOW BATTERY** or **PLACE IN CHARGER** shows on the handset screen.

### CAUTION:

To reduce the risk of fire or injury, read and follow these instructions:

- Use only the battery(ies) provided or equivalent. To order a replacement, visit our website at [www.vtechphones.com](http://www.vtechphones.com) or call 1 (800) 595-9511. In Canada, go to [www.vtechcanada.com](http://www.vtechcanada.com) or call 1 (800) 267-7377.
- Do not dispose of the battery(ies) in a fire. Check with local waste management codes for special disposal instructions.
- Do not open or mutilate the battery(ies). Released electrolyte is corrosive and may cause burns or injury to the eyes or skin. The electrolyte may be toxic if swallowed.
- Exercise care in handling batteries in order not to create a short circuit with conductive materials.
- Charge the battery(ies) provided with or identified for use with this product only in accordance with the instructions and limitations specified in this manual.
- Observe proper polarity orientation between the battery and metallic contacts.
- To prevent fire or shock hazard, do not expose this product to water or any type of moisture.

## Appendix

### Expand your telephone system

The handsets provided with your telephone system are pre-registered. Each handset is assigned a number that shows on the handset display. Additional handsets registered to the telephone system are assigned in sequential order. For instance, if the telephone system already has **HANDSET 1** and **HANDSET 2**, the new registered handset is assigned **HANDSET 3**. This telephone system accommodates up to 12 handsets.

### Add and register a handset (optional)

You can add new handsets (**CS6309**, purchased separately) to your telephone system, but each handset must be registered with the telephone base before use. When first purchased, each expansion handset shows **NOT REGISTERED**. You may need to charge the handset before registering to the telephone base. For more details on battery charging, see the table on page 4.

To register a handset:

1. Place the unregistered handset in the telephone base or charger. If **PRESS FIND HS 4 SEC ON BASE** does not appear on the handset screen after a few seconds, remove the handset and place it in the telephone base or charger again.
2. On the telephone base, press and hold **FIND HANDSET** for about four seconds (until the red **IN USE** light on the telephone base turns on) and then release the button. The handset shows **PLEASE WAIT...** and it takes about 10 seconds to complete the registration. The handset shows **HANDSET X REGISTERED** (**X** represents the handset number assigned) and you hear a beep when the registration completes.

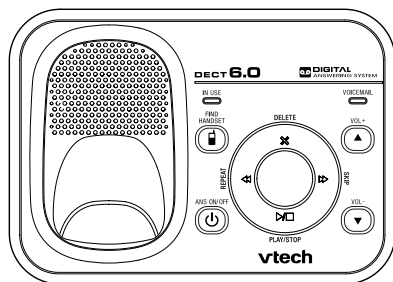

#### note

- If the registration fails, the handset shows **NOT REGISTERED**. To reset the handset, remove the handset from the telephone base and place it back in. Try the registration process again.
- You cannot register a handset if any other system handset is in use.

## Appendix

### Replace a handset

If you want to replace a handset or re-assign the designated handset number of a registered handset, you must de-register all the handsets and then individually register each handset.

To make de-registration easier, read all of the instructions on this page before you begin. To de-register all handsets:

1. Press and hold **FIND HANDSET** on the telephone base for about 10 seconds (until the **IN USE** light on the telephone base turns on and starts to flash), then release **FIND HANDSET**.
2. Press and release **FIND HANDSET** again. You must press **FIND HANDSET** while the **IN USE** light is still flashing. The **IN USE** light flashes for approximately seven seconds.
3. All system handsets show **CONNECTING...** The de-registration process takes about 10 seconds to complete. All handsets show **NOT REGISTERED** when the de-registration completes.

If de-registration fails, you might need to reset the telephone and try again.

To reset:

1. Pick up the registered handset and then press .
2. Press **OFF/CLEAR** and place the handset back in the telephone base.

**-OR-**

1. Unplug the power from the telephone base, then plug it back in.

**note**

You cannot de-register a handset if any system handset is in use.

# Appendix

## Troubleshooting

If you have difficulty with your telephone, please try the suggestions below. For Customer Service, visit our website at [www.vtechphones.com](http://www.vtechphones.com), or call 1 (800) 595-9511; in Canada, call 1 (800) 267-7377.

### My telephone does not work at all.

- Make sure the battery is installed and charged correctly (page 4). For optimum daily performance, return the handset to the telephone base or charger after use.
- Make sure the power adapter is securely plugged into an outlet not controlled by a wall switch.
- Make sure the telephone line cord is plugged firmly into the telephone base and the telephone wall jack.
- Unplug the electrical power to the telephone base. Wait for approximately 15 seconds, then plug it back in. Allow up to one minute for the cordless handset and telephone base to synchronize.
- Charge the battery in the handset for up to 16 hours.
- If the battery is completely depleted, it can take up to 10 minutes to charge the handset before **LOW BATTERY** appears on the screen (page 4).
- Remove and re-insert the battery. If that still does not work, it might be necessary to purchase a new battery.
- Disconnect the telephone base from the telephone wall jack and plug in a working telephone. If the other telephone does not work, the problem is probably in the wiring or the local service. Call the local telephone company.

### LOW BATTERY shows on screen.

- Place the handset in the telephone base or charger for recharging.
- Remove and re-install the battery and use it until fully depleted, then recharge the handset in the telephone base or charger for up to 16 hours.
- If the above measures do not correct the problem, replace the battery.

### The battery does not charge in the handset or the handset battery does not accept charge.

- Make sure the handset is placed in the telephone base or charger correctly. The **CHARGE** light on the handset should be on.
- Remove and reinstall the battery, then charge for up to 16 hours.
- If the handset is in the telephone base or charger but the **CHARGE** light on the handset is not on, refer to **The CHARGE light is off** in this section.
- If the battery is completely depleted, it can take up to 10 minutes to charge the handset before **LOW BATTERY** appears on the screen (page 4).
- Purchase a new battery. Refer to the **Battery** section (page 40).

# Appendix

## Troubleshooting

### **The CHARGE light is off.**

- Clean the charging contacts on the handset and telephone base each month with a pencil eraser or a dry non-abrasive fabric.
- Make sure the power adapter and telephone line cord are plugged in correctly and securely.
- Unplug the power adapter. Wait for 15 seconds before plugging it back in. Allow up to one minute for the handset and telephone base to reset.

### **There is no dial tone.**

- First, try all the above suggestions.
- Move the handset closer to the telephone base. It might be out of range.
- The telephone line cord might be malfunctioning. Install a new telephone line cord.
- Disconnect the telephone base from the telephone wall jack and connect a different telephone. If there is no dial tone on this telephone either, the problem is in your wiring or local service. Contact your local telephone company.

### **The telephone does not ring when there is an incoming call.**

- Make sure the handset ringer volume is not set to the lowest level (page 9) and the telephone base ringer volume is not set to zero (page 32).
- Make sure the telephone line cord and power adapter are plugged in properly (page 2).
- The handset might be too far from the telephone base. Move it closer to the telephone base.
- There might be too many extension phones on the telephone line to allow all of them to ring simultaneously. Unplug some of them.
- If the other telephones in your home are having the same problem, the problem is in the wiring or local service. Contact the local telephone company (charges may apply).
- Other electronic products can cause interference to your cordless telephone. Install your telephone as far away as possible from electronic devices such as: wireless routers, radios, cellular telephones, digital telephones, intercoms, room monitors, televisions, VCRs, personal computers, kitchen appliances, and other cordless telephones.
- Test a working telephone at the telephone wall jack. If another telephone has the same problem, the problem is in the telephone wall jack. Contact your local telephone company (charges may apply).
- The telephone line cord might be malfunctioning. Install a new telephone line cord.
- Re-install the battery and place the handset in the telephone base or charger.
- Wait for the handset to synchronize with the telephone base. Allow up to one minute for this to take place.

# Appendix

## Troubleshooting

### I cannot dial out.

- First, try all the above suggestions.
- Make sure there is a dial tone before dialing. It is normal if the handset takes a second or two to synchronize with the telephone before producing a dial tone. Wait an extra second before dialing.
- If the other telephones in your home are having the same problem, the problem is in the wiring or local service. Contact your local telephone company (charges may apply).
- Eliminate any background noise. Mute the cordless handset before dialing, or dial from another room in your home with less background noise.

### My handset beeps and is not performing normally.

- Make sure the power cord is securely plugged into the telephone base. Plug the telephone base into a different working electrical outlet not controlled by a wall switch.
- Move the handset closer to the telephone base. It might be out of range.
- Reset the telephone base by unplugging the electrical power to the base. Wait for 15 seconds and plug it back in again. Allow up to one minute for the cordless handset and the telephone base to synchronize.
- Other electronic products can cause interference to your cordless telephone. Install your telephone as far away from these electronic devices as possible: wireless routers, radios, radio towers, pager towers, cellular telephones, intercoms, room monitors, televisions, personal computers, kitchen appliances and other cordless telephones.

### There is interference during a telephone conversation.

#### My calls fade out when I am using the cordless handset.

- The handset might be out of range. Move it closer to the telephone base.
- If you subscribe to high-speed Internet service (digital subscriber line - DSL) through your telephone lines, you must install a DSL filter between the telephone base and the telephone wall jack. The filter prevents noise and caller ID problems caused by DSL interference. Contact your DSL service provider for more information about DSL filters.
- Appliances or other cordless telephones plugged into the same circuit as the telephone base can cause interference. Try moving the appliance or telephone base to another outlet.
- Other electronic products can cause interference to your cordless telephone. Install your telephone as far away as possible from the following electronic devices: wireless routers, radios, radio towers, pager towers, cellular telephones, digital telephones, intercoms, room monitors, televisions, VCRs, personal computers, kitchen appliances, and other cordless telephones.
- If your telephone is plugged in with a modem or a surge protector, plug the telephone (or modem/surge protector) into a different location. If this doesn't solve the problem, re-locate your telephone or modem farther apart from each other, or use a different surge protector.



# Appendix

## Troubleshooting

- The location of your telephone base can impact the performance of your cordless phone. For better reception, install the telephone base in a centralized location within your home or office, away from walls or other obstructions. In many environments, elevating the telephone base improves overall performance.
- Disconnect the telephone base from the telephone wall jack and plug in a corded telephone. If calls are still not clear, the problem is probably in the wiring or local service. Contact your local service company (charges may apply).
- If the other telephones in your home are having the same problem, the problem is in the wiring or local service. Contact the local telephone company (charges may apply).

### **I hear other calls when using the telephone.**

- Disconnect the telephone base from the telephone wall jack. Plug in a different telephone. If you still hear other calls, the problem is probably in the wiring or local service. Call your local telephone company.

### **I hear noise on the cordless handset and the keys do not work.**

- Make sure the telephone line cord is plugged in securely.

### **My caller ID features are not working properly.**

- Caller ID is a subscription service. You must subscribe to this service from your local telephone company for this feature to work on your telephone.
- The caller might not be calling from an area which supports caller ID.
- Both you and the caller's telephone companies must use equipment compatible with the caller ID service.
- The caller ID information shows after the first or second ring.
- If you subscribe to high-speed Internet service (digital subscriber line - DSL) through your telephone lines, you must install a DSL filter between the telephone base and the telephone wall jack. The filter prevents noise and caller ID problems caused by DSL interference. Contact your DSL service provider for more information about DSL filters.

### **The telephone does not receive caller ID or the telephone does not show caller ID during call waiting.**

- Make sure you subscribe to caller ID with call waiting features provided by the local telephone company.
- The caller might not be calling from an area which supports caller ID.
- Both you and the caller's telephone companies must use equipment compatible with caller ID service.
- If you subscribe to high-speed Internet service (digital subscriber line - DSL) through your telephone lines, you must install a DSL filter between the telephone base and the telephone wall jack. The filter prevents noise and caller ID problems caused by DSL interference. Contact your DSL service provider for more information about DSL filters.

# Appendix

## Troubleshooting

### Caller ID entries do not match the numbers I need to dial.

- Caller ID service delivers 10 digits (the area code plus the seven-digits number). If you need to dial something other 10 digits, see page 28 for instructions on changing the number.
- If you dial seven digits for local calls you might want to use the **Home area code** feature (PB).

### CONNECTING... shows in the handset screen.

- The handset might be out of range. Move it closer to the telephone base.
- Make sure the power cord is securely plugged into the telephone base. Use a working electrical outlet not controlled by a wall switch.
- Reset your telephone by unplugging the power adapter from the telephone base. Disconnect the battery from the cordless handset. Wait for 15 seconds, then plug in the power adapter and re-install the battery. Place the handset in the telephone base and allow up to one minute for the handset and telephone base to synchronize.
- Other electronic products might prevent your handset and telephone base from communicating with each other. Install your telephone base as far away from these electronic devices as possible: wireless routers, radios, cellular telephones, intercoms, room monitors, televisions, personal computers, kitchen appliances and other cordless telephones.

### The answering system does not answer after the number of rings that I programmed it.

- Make sure the answering system is on. When the answering system is on, the **ANS ON/OFF** light on the telephone base should be lit and **ANS ON** should show on the handset.
- If toll saver is selected, the number of rings changes to two when there are new messages waiting (page 13).
- If the memory is full or if the answering system is off, the answering system answers after 10 rings.
- In some cases, the answering system is affected by the ringing system used by the local telephone company.

### The outgoing announcement is not clear.

- When recording the announcement, make sure you speak in a normal tone of voice towards the microphone of the handset.
- Make sure there is no background noise when recording.

# Appendix

## Troubleshooting

### **The messages on the answering system are very difficult to hear.**

- Press **VOL ▲** on the telephone base or handset to increase the speaker volume.

### **The answering system does not record messages.**

- Make sure the answering system is on.
- When the answering machine memory is full, it does not record new messages until some old messages are deleted.

### **The messages on the answering system are incomplete.**

- If a caller leaves a very long message, part of it might be lost when the answering system disconnects the call after four minutes.
- If the memory on the answering system becomes full during a message, the answering system stops recording and disconnects the call.
- If the caller's voice is very soft, the answering system might stop recording and disconnect the call.

### **The answering system does not respond to remote commands.**

- Make sure your remote code is correct (page 11).
- Make sure you are calling from a touch-tone telephone. When dialing a number, there should be tones. If there are clicks, then it is not a touch-tone telephone and cannot activate the answering system.
- The answering system might not detect the remote access code when your announcement is playing. Wait until the announcement is over before entering the code.
- There might be interference on the telephone line you are using. Press the dial pad keys firmly when dialing.

### **Common cures for electronic equipment.**

- If the telephone is not responding normally, put the cordless handset in the telephone base. If it does not respond, try the following (in the order listed):
- Disconnect the power to the telephone base.
- Disconnect the battery on the cordless handset.
- Wait a few minutes before connecting power to the telephone base.
- Re-install the battery and place the cordless handset in the telephone base or charger.
- Wait for the cordless handset to synchronize with the telephone base. Allow up to one minute for this to take place.

# Appendix

## Important safety instructions

When using your telephone equipment, basic safety precautions should always be followed to reduce the risk of fire, electric shock and injury, including the following:

1. Read and understand all instructions.
2. Follow all warnings and instructions marked on the product.
3. Unplug this product from the wall outlet before cleaning. Do not use liquid or aerosol cleaners. Use a damp cloth for cleaning.
4. Do not use this product near water.
5. Do not place this product on an unstable table, shelf, stand or other unstable surfaces.
6. Slots and openings in the back or bottom of the telephone base and handset are provided for ventilation. To protect them from overheating, these openings must not be blocked by placing the product on a soft surface such as a bed, sofa or rug. This product should never be placed near or over a radiator or heat register. This product should not be placed in any area where proper ventilation is not provided.
7. This product should be operated only from the type of power source indicated on the marking label. If you are not sure of the type of power supply in your home, consult your dealer or local power company.
8. Do not allow anything to rest on the power cord. Do not install this product where the cord may be walked on.
9. Never push objects of any kind into this product through the slots in the telephone base or handset because they may touch dangerous voltage points or create a short circuit. Never spill liquid of any kind on the product.
10. To reduce the risk of electric shock, do not disassemble this product, but take it to an authorized service facility. Opening or removing parts of the telephone base or handset other than specified access doors may expose you to dangerous voltages or other risks. Incorrect reassembling can cause electric shock when the product is subsequently used.
11. Do not overload wall outlets and extension cords.
12. Unplug this product from the wall outlet and refer servicing to an authorized service facility under the following conditions:
  - A. When the power supply cord or plug is damaged or frayed.
  - B. If liquid has been spilled onto the product.
  - C. If the product has been exposed to rain or water.
  - D. If the product does not operate normally by following the operating instructions. Adjust only those controls that are covered by the operation instructions. Improper adjustment of other controls may result in damage and often requires extensive work by an authorized technician to restore the product to normal operation.
  - E. If the product has been dropped and the telephone base and/or handset has been damaged.
  - F. If the product exhibits a distinct change in performance.
13. Avoid using a telephone (other than cordless) during an electrical storm. There is a remote risk of electric shock from lightning.
14. Do not use the telephone to report a gas leak in the vicinity of the leak.
15. Only put the handset of your telephone next to your ear when it is in normal talk mode.
16. The power adapters are intended to be correctly oriented in a vertical or floor mount position. The prongs are not designed to hold the plug in place if it is plugged into a ceiling or an under-the-table/cabinet outlet.



**SAVE THESE INSTRUCTIONS**

# Appendix

## Operating range

This cordless telephone operates with the maximum power allowed by the Federal Communications Commission (FCC). Even so, this handset and telephone base can communicate over only a certain distance - which can vary with the locations of the telephone base and handset, the weather, and the layout of your home or office.

When the handset is out of range, the handset displays **CONNECTING...**

If there is a call while the handset is out of range, it might not ring, or if it does ring, the call might not connect well when you press . Move closer to the telephone base, then press  to answer the call.

If the handset moves out of range during a telephone conversation, there might be interference.

To improve reception, move closer to the telephone base.

## Maintenance

### Taking care of your telephone

Your cordless telephone contains sophisticated electronic parts, so it must be treated with care.

### Avoid rough treatment

Place the handset down gently. Save the original packing materials to protect your telephone if you ever need to ship it.

### Avoid water

Your telephone can be damaged if it gets wet. Do not use the handset outdoors in the rain, or handle it with wet hands. Do not install the telephone base near a sink, bathtub or shower.

### Electrical storms

Electrical storms can sometimes cause power surges harmful to electronic equipment. For your own safety, take caution when using electrical appliances during storms.

### Cleaning your telephone

Your telephone has a durable plastic casing that should retain its luster for many years. Clean it only with a soft cloth slightly dampened with water or a mild soap. Do not use excess water or cleaning solvents of any kind.

Remember that electrical appliances can cause serious injury if used when you are wet or standing in the water. If the telephone base should fall into the water, **DO NOT RETRIEVE IT UNTIL YOU UNPLUG THE POWER CORD AND TELEPHONE LINE CORD FROM THE WALL.** Then remove the telephone by the unplugged cords.

# Appendix

## About cordless telephones

- **Privacy:** The same features that make a cordless telephone convenient create some limitations. Telephone calls are transmitted between the telephone base and the cordless handset by radio waves, so there is a possibility that the cordless telephone conversations could be intercepted by radio receiving equipment within range of the cordless handset. For this reason, you should not think of cordless telephone conversations as being as private as those on corded telephones.
- **Electrical power:** The telephone base of this cordless telephone must be connected to a working electrical outlet. The electrical outlet should not be controlled by a wall switch. Calls cannot be made from the cordless handset if the telephone base is unplugged or switched off, or if the electrical power is interrupted.
- **Potential TV interference:** Some cordless telephones operate at frequencies that may cause interference to televisions and VCRs. To minimize or prevent such interference, do not place the telephone base of the cordless telephone near or on top of a TV or VCR. If interference is experienced, moving the cordless telephone farther away from the TV or VCR often reduces or eliminates the interference.
- **Rechargeable batteries:** Exercise care in handling batteries in order not to create a short circuit with conducting material such as rings, bracelets, and keys. The battery or conductor may overheat and cause harm. Observe proper polarity between the battery and the battery charger.
- **Nickel-metal hydride rechargeable batteries:** Dispose of these batteries in a safe manner. Do not burn or puncture the battery. Like other batteries of this type, if burned or punctured, they could release caustic material which could cause injury.

## The RBRC® seal

The RBRC® seal on the nickel-metal hydride battery indicates that VTech Communications, Inc. is voluntarily participating in an industry program to collect and recycle these batteries at the end of their useful lives, when taken out of service within the United States and Canada.

The RBRC® program provides a convenient alternative to placing used nickel-metal hydride batteries into the trash or municipal waste, which may be illegal in your area.

VTech's participation in RBRC® makes it easy for you to drop off the spent battery at local retailers participating in the RBRC® program or at authorized VTech product service centers. Please call **1-800-8-BATTERY™** for information on Ni-MH battery recycling and disposal bans/restrictions in your area. VTech's involvement in this program is part of its commitment to protecting our environment and conserving natural resources.

**RBRC® is a registered trademark of Rechargeable Battery Recycling Corporation.**



# Appendix

## Warranty

### What does this limited warranty cover?

The manufacturer of this VTech Product warrants to the holder of a valid proof of purchase (“Consumer” or “you”) that the Product and all accessories provided in the sales package (“Product”) are free from defects in material and workmanship, pursuant to the following terms and conditions, when installed and used normally and in accordance with the Product operating instructions. This limited warranty extends only to the Consumer for Products purchased and used in the United States of America and Canada.

### What will VTech do if the Product is not free from defects in materials and workmanship during the limited warranty period (“Materially Defective Product”)?

During the limited warranty period, VTech’s authorized service representative will repair or replace at VTech’s option, without charge, a Materially Defective Product. If we repair the Product, we may use new or refurbished replacement parts. If we choose to replace the Product, we may replace it with a new or refurbished Product of the same or similar design. We will retain defective parts, modules, or equipment. Repair or replacement of the Product, at VTech’s option, is your exclusive remedy. VTech will return the repaired or replacement Products to you in working condition. You should expect the repair or replacement to take approximately 30 days.

### How long is the limited warranty period?

The limited warranty period for the Product extends for ONE (1) YEAR from the date of purchase. If VTech repairs or replaces a Materially Defective Product under the terms of this limited warranty, this limited warranty also applies to the repaired or replacement Product for a period of either (a) 90 days from the date the repaired or replacement Product is shipped to you or (b) the time remaining on the original one-year warranty; whichever is longer.

### What is not covered by this limited warranty?

This limited warranty does not cover:

1. Product that has been subjected to misuse, accident, shipping or other physical damage, improper installation, abnormal operation or handling, neglect, inundation, fire, water or other liquid intrusion; or
2. Product that has been damaged due to repair, alteration or modification by anyone other than an authorized service representative of VTech; or
3. Product to the extent that the problem experienced is caused by signal conditions, network reliability, or cable or antenna systems; or
4. Product to the extent that the problem is caused by use with non-VTech accessories; or
5. Product whose warranty/quality stickers, product serial number plates or electronic serial numbers have been removed, altered or rendered illegible; or
6. Product purchased, used, serviced, or shipped for repair from outside the United States of America or Canada, or used for commercial or institutional purposes (including but not limited to Products used for rental purposes); or
7. Product returned without a valid proof of purchase (see item 2 below); or
8. Charges for installation or set up, adjustment of customer controls, and installation or repair of systems outside the unit.

# Appendix

## How do you get warranty service?

To obtain warranty service in the United States of America, please call 1 (800) 595-9511. In Canada, please call 1 (800) 267-7377. NOTE: Before calling for service, please review the user's manual - a check of the Product's controls and features may save you a service call.

Except as provided by applicable law, you assume the risk of loss or damage during transit and transportation and are responsible for delivery or handling charges incurred in the transport of the Product(s) to the service location. VTech will return repaired or replaced Product under this limited warranty. Transportation, delivery or handling charges are prepaid. VTech assumes no risk for damage or loss of the Product in transit. If the Product failure is not covered by this limited warranty, or proof of purchase does not meet the terms of this limited warranty, VTech will notify you and will request that you authorize the cost of repair prior to any further repair activity. You must pay for the cost of repair and return shipping costs for the repair of Products that are not covered by this limited warranty.

## What must you return with the Product to get warranty service?

1. Return the entire original package and contents including the Product to the VTech service location along with a description of the malfunction or difficulty; and
2. Include a "valid proof of purchase" (sales receipt) identifying the Product purchased (Product model) and the date of purchase or receipt; and
3. Provide your name, complete and correct mailing address, and telephone number.

## Other Limitations

This warranty is the complete and exclusive agreement between you and VTech. It supersedes all other written or oral communications related to this Product. VTech provides no other warranties for this Product. The warranty exclusively describes all of VTech's responsibilities regarding the Product. There are no other express warranties. No one is authorized to make modifications to this limited warranty and you should not rely on any such modification.

State/Provincial Law Rights: This warranty gives you specific legal rights, and you may also have other rights, which vary from state to state or province to province.

Limitations: Implied warranties, including those of fitness for a particular purpose and merchantability (an unwritten warranty that the Product is fit for ordinary use) are limited to one year from the date of purchase. Some states/provinces do not allow limitations on how long an implied warranty lasts, so the above limitation may not apply to you. In no event shall VTech be liable for any indirect, special, incidental, consequential, or similar damages (including, but not limited to lost profits or revenue, inability to use the Product or other associated equipment, the cost of substitute equipment, and claims by third parties) resulting from the use of this Product. Some states/provinces do not allow the exclusion or limitation of incidental or consequential damages, so the above limitation or exclusion may not apply to you.

**Please retain your original sales receipt as proof of purchase.**



# Appendix

## FCC, ACTA and IC regulations

### FCC Part 15

This equipment has been tested and found to comply with the requirements for a Class B digital device under Part 15 of the Federal Communications Commission (FCC) rules. These requirements are intended to provide reasonable protection against harmful interference in a residential installation. This equipment generates, uses and can radiate radio frequency energy and, if not installed and used in accordance with the instructions, may cause harmful interference to radio communications. However, there is no guarantee that interference will not occur in a particular installation. If this equipment does cause harmful interference to radio or television reception, which can be determined by turning the equipment off and on, the user is encouraged to try to correct the interference by one or more of the following measures:

- Reorient or relocate the receiving antenna.
- Increase the separation between the equipment and receiver.
- Connect the equipment into an outlet on a circuit different from that to which the receiver is connected.
- Consult the dealer or an experienced radio/TV technician for help.

Changes or modifications to this equipment not expressly approved by the party responsible for compliance could void the user's authority to operate the equipment.

This device complies with Part 15 of the FCC rules. Operation is subject to the following two conditions: (1) this device may not cause harmful interference, and (2) this device must accept any interference received, including interference that may cause undesired operation. Privacy of communications may not be ensured when using this telephone.

To ensure safety of users, the FCC has established criteria for the amount of radio frequency energy that can be safely absorbed by a user or bystander according to the intended usage of the product. This product has been tested and found to comply with the FCC criteria. The handset may be safely held against the ear of the user. The telephone base shall be installed and used such that parts of the user's body other than the hands are maintained at a distance of approximately 20 cm (8 inches) or more.

This Class B digital apparatus complies with Canadian ICES-003.

### FCC Part 68 and ACTA

This equipment complies with Part 68 of the FCC rules and with technical requirements adopted by the Administrative Council for Terminal Attachments (ACTA). The label on the back or bottom of this equipment contains, among other things, a product identifier in the format US:AAEQ##TXXXX. This identifier must be provided to your local telephone company upon request.

The plug and jack used to connect this equipment to premises wiring and the telephone network must comply with applicable Part 68 rules and technical requirements adopted by ACTA. A compatible telephone cord and modular plug is provided with this product. It is designed to be connected to a compatible modular jack that is also compliant. An RJ11 jack should normally be used for connecting to a single line and an RJ14 jack for two lines. See Installation Instructions in the user's manual.

The Ringer Equivalence Number (REN) is used to determine how many devices you may connect to your telephone line and still have them ring when you are called. The REN for this product is encoded as the 6th and 7th characters following the US: in the product identifier (e.g., if ## is 03, the REN is 0.3). In most, but not all areas, the sum of all RENs should be five (5.0) or less. For more information, please contact your local telephone company.

This equipment may not be used with Party Lines. If you have specially wired alarm dialing equipment connected to your telephone line, ensure the connection of this equipment does not disable your alarm equipment. If you have questions about what will disable alarm equipment, consult your telephone company or a qualified installer.

If this equipment is malfunctioning, it must be unplugged from the modular jack until the problem has been corrected. Repairs to this telephone equipment can only be made by the manufacturer or its authorized agents. For repair procedures, follow the instructions outlined under the Limited Warranty.

## Appendix

If this equipment is causing harm to the telephone network, the telephone company may temporarily discontinue your telephone service. The telephone company is required to notify you before interrupting service. If advance notice is not practical, you will be notified as soon as possible. You will be given the opportunity to correct the problem and the telephone company is required to inform you of your right to file a complaint with the FCC. Your telephone company may make changes in its facilities, equipment, operation, or procedures that could affect the proper functioning of this product. The telephone company is required to notify you if such changes are planned.

If this product is equipped with a corded or cordless handset, it is hearing aid compatible.

If this product has memory dialing locations, you may choose to store emergency telephone numbers (e.g., police, fire, medical) in these locations. If you do store or test emergency numbers, please:

Remain on the line and briefly explain the reason for the call before hanging up.

Perform such activities in off-peak hours, such as early morning or late evening.

### Industry Canada

Operation is subject to the following two conditions: (1) this device may not cause harmful interference, and (2) this device must accept any interference, including interference that may cause undesired operation.

The term "IC:" before the certification/registration number only signifies that the Industry Canada technical specifications were met.

The Ringer Equivalence Number (REN) for this terminal equipment is 0.1. The REN is an indication of the maximum number of devices allowed to be connected to a telephone interface. The termination on an interface may consist of any combination of devices subject only to the requirement that the sum of the RENs of all the devices does not exceed five.

This product meets the applicable Industry Canada technical specifications.

# Appendix

## Technical specifications

Transmit frequency	Handset: 1921.536-1928.448 MHz Telephone base: 1921.536-1928.448 MHz
Channels	5
Nominal effective range	Maximum power allowed by FCC and IC. Actual operating range might vary according to environmental conditions at the time of use.
Size	Handset: 6.37 X 1.85 X 1.14 in (161.85 X 47.00 X 28.9 mm) Telephone base: 6.05 X 4.31 X 2.28 in (153.7 X 109.45 X 57.8 mm) Charger: 2.96 X 3.33 X 1.80 in (75.3 X 84.6 X 45.8 mm)
Weight	Handset: 4.47oz (126.7g) (including battery) Telephone base: 6.64oz (188.3g) Charger: 1.81oz (51.3g)
Power requirements	Handset: 2.4V 500mAh Ni-MH battery Telephone base: 6V DC @ 400mA Charger: 6V AC @ 300mA
Memory	Handset directory: 100 memory locations (including 10 speed dial entries); up to 30 digits and 15 characters Handset call log: 50 memory locations; up to 24 digits and 15 characters

# Index

## A

- Add a handset 38
- Alphabetical search 21
- Announcement 12
- Answer a call 13
- Answer an incoming call during an intercom call 16
- Answering system 28

## B

- Battery 3, 37

## C

- Caller ID 23
- Call intercept 29
- Call log 24
- Call log display screen messages 27
- Call screening 29
- Call waiting 14
- Chain dialing 15
- Character chart 20
- Charging 3
- Clear voicemail 10

## D

- Date and time 9
- Delete announcement 12
- Delete answering system messages 31
- Delete from redial 27
- Delete from the call log 26
- Delete from the directory 22
- Dial a call log entry 26
- Dial a directory entry 21
- Dial a redial entry 27
- Dialing pause 19, 22, 26
- Directory 18
- DSL filter 2

## E

- Edit a directory entry 22
- End a call 13
- Expand your telephone system 38

## F

- Find handset 14

## H

- Handset display screen messages 34
- Handset icons 36
- Handset layout 6
- Handset lights 36
- Home area code 10

## I

- Important safety instructions 46
- Intercom 16

## K

- Key tone 8

## L

- Language 9

## M

- Maintenance 47
- Make a call 13
- Make a call log entry ready to dial 25
- Message alert tone 11
- Message capacity 28
- Message playback 30
- Message window displays 32
- Missed calls indicator 24
- Multiple handset use 16
- Mute 14

## N

- New message indication 30
- Number of rings 11

## O

- Operating range 47

## P

- Parts checklist 1
- Phonebook 18
- Play announcement 12
- Predial a call 13

# Index

## R

- Record and play memos 31
- Record announcement 12
- Redial list 27
- Register a handset 38
- Remote access 33
- Remote code 11
- Replace a handset 39
- Review the call log 25
- Ringer mute 14
- Ringer tone 8
- Ringer volume 8

## S

- Save a call log entry to the directory 26
- Search the directory 21
- Share an outside call 17
- Speakerphone 13
- Store a directory entry 19
- Store from redial 19

## T

- Technical specifications 53
- Telephone base installation 2
- Telephone base layout 7
- Telephone base lights 36
- Telephone base ringer volume 29
- Troubleshooting 40
- Turn the answering system on or off 29

## V

- Voicemail 10
- Volume 8, 13, 29

## W

- Wall mounting 4
- Warranty 49

VTECH TELECOMMUNICATIONS LTD.  
A member of THE VTECH GROUP OF COMPANIES.

Distributed in the U.S.A. by VTech Communications, Inc. Beaverton, Oregon 97008

Distributed in Canada by VTech Technologies Canada, Ltd., Richmond, B.C. V6W 1L5

Copyright © 2009 for VTECH TELECOMMUNICATIONS LTD.

Printed in China.

91-002292-020-100