



Proud Sponsor

User's manual

TL86109

DECT 6.0 2-line

**corded/cordless telephone/
answering system with**

BLUETOOTH® wireless technology



Congratulations

on purchasing your new AT&T product. Before using this AT&T product, please read the **Important safety information** on pages 136-137 of this user's manual. Please thoroughly read the user's manual for all the feature operations and troubleshooting information you need to install and operate your new AT&T product. You can also visit our website at **www.telephones.att.com** or call **1 (800) 222-3111**. In Canada, dial **1 (866) 288-4268**.

Model #: TL86109 (one handset)
Type: DECT 6.0 2-line corded/cordless telephone/
answering system with Bluetooth wireless technology
Serial #: _____
Purchase date: _____
Place of purchase: _____

Both the model and serial number of your AT&T product can be found on the bottom of the telephone base.



Telephones identified with this logo have reduced noise and interference when used with most T-coil equipped hearing aids and cochlear implants. The TIA-1083 Compliant Logo is a trademark of the Telecommunications Industry Association. Used under license.



The ENERGY STAR® program (www.energystar.gov) recognizes and encourages the use of products that save energy and help protect our environment. We are proud to mark this product with the ENERGY STAR® label indicating it meets the latest energy efficiency guidelines.

The *Bluetooth*® word mark and logos are owned by Bluetooth SIG, Inc. and any use of such marks by Advanced American Telephones and its parent, VTech Holdings Limited, is under license. VTech Holdings Limited is a member of Bluetooth SIG, Inc. Other trademarks and trade names are those of their respective owners.

© 2010 Advanced American Telephones. All Rights Reserved. AT&T and the AT&T logo are trademarks of AT&T Intellectual Property licensed to Advanced American Telephones, San Antonio, TX 78219. Printed in China.

Parts checklist

Your telephone package contains the following items. Save your sales receipt and original packaging in the event warranty service is necessary.



User's manual



Quick start guide



Cordless handset



Telephone base



Corded handset with coiled handset cord attached



Charger for cordless handset with power adapter installed



Belt clip for cordless handset



Battery for cordless handset



Battery compartment cover



Power adapter for telephone base

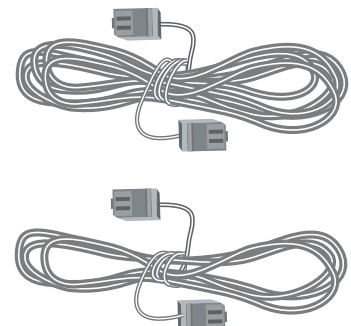

Telephone line cord

User's manual

TL86109

DECT 6.0 2-line corded/cordless telephone/ answering system with BLUETOOTH® wireless technology



Table of contents

Getting started

Quick reference guide - handset.....	1
Quick reference guide - telephone base.....	2
Quick reference guide - telephone base.....	3
Handset main menu.....	5
Installation.....	7
Telephone base installation.....	8
Charger installation.....	9
Battery installation and charging.....	10
Battery charging.....	11
Belt clip & optional headset.....	12

Bluetooth

Introducing Bluetooth.....	13
Glossary of terms.....	14
Bluetooth setup.....	15
Pairing a cell phone.....	15
Auto connection.....	16
Pair a headset.....	17
Paired devices.....	19
Rename a paired device.....	19
Remove a paired device.....	20
View information of an active device.....	20
Active devices.....	21
Review the active devices list.....	21
Connect/disconnect an active device.....	21
Replace an active device.....	23
Add an active device.....	24
Remove an active device.....	25
View information of an active device.....	25

Change PIN.....	26
Download directory.....	27
Interruption to directory download.....	29
View the directory download information.....	29

Telephone settings

Handset settings.....	30
Ringer volume.....	30
Ringer tone.....	31
LCD language.....	32
Line preference.....	32
Display alerts.....	32
Key tone.....	33
Set date/time.....	34
Use caller ID to automatically set date and time.....	35
Dial mode.....	35
Website.....	35
Home area code.....	36
Cell area code.....	37
Telephone base settings.....	38
Ringer volume.....	38
Ringer tone.....	39
LCD language.....	39
Clear voicemail.....	40
Key tone.....	41
Set date/time.....	42
Use caller ID to automatically set date and time.....	43
Dial mode.....	43
Website.....	43
Home area code.....	44
Cell area code.....	45

Table of contents

Answering system settings.....	46	Save a redial entry to the directory.....	72
Announcement	46	Delete a redial entry.....	73
Recording time.....	50	Multiple handset use	
Answer ON/OFF.....	51	Handset locator.....	74
Delete your announcement.....	53	Join a call in progress.....	74
Call screening.....	54	Intercom.....	75
Number of rings.....	55	To initiate an intercom call.....	75
Remote access code.....	56	Intercom.....	76
Message alert tone.....	57	Answer an incoming call during an intercom call.....	77
Telephone operation		Call transfer using intercom.....	78
Making, answering and ending a call.....	58	Directory	
Using a handset.....	58	About the directory.....	81
Using the telephone base.....	58	Create and review entries.....	82
Using a Bluetooth headset for home calls.....	59	Create a new entry in the home directory.....	82
Call waiting on the home line.....	60	To add a predialed telephone number to the directory.....	85
Make, answer or end a cell call.....	60	Review the directory.....	86
Call waiting on the cell line.....	61	3-character alphabetical search.....	87
Answer a cell call while on a home call.....	62	Store a speed dial directory entry.....	88
Answer a home call while on a cell call.....	62	Review the speed dial directory.....	89
Conference calls.....	63	Dial a directory entry.....	89
Share an outside call.....	63	Dial a speed dial entry.....	89
Conference line 1 and line 2 calls.....	63	Edit a directory entry.....	90
Answer an incoming call during a conference call.....	64	Dial, edit or delete a directory.....	91
Conference home and cell calls.....	65	Reassign a speed dial entry.....	91
Speakerphone.....	66	Edit the type of a directory entry.....	92
Volume control.....	66	Delete a directory entry.....	92
Silencing the ringer.....	66	Delete a speed dial entry.....	93
Mute.....	67	Remove a downloaded directory.....	94
Temporary tone dialing.....	67	Caller ID	
Hold.....	68	About caller ID.....	95
Equalizer.....	68	Information about caller ID with call waiting.....	95
Chain dialing.....	69	Caller ID operation.....	96
Redial.....	71	How the caller ID history (call log)	
Review the redial list.....	71		
Dial a redial entry.....	71		

Table of contents

works	96	lights	116
Missed calls indicator	96	Screen messages.....	117
Display alerts settings.....	97	Display screen messages.....	117
Memory match.....	98	Expand your telephone system.....	120
To review the call log.....	98	Add and register a handset	
View dialing options.....	100	(optional).....	120
Dial a call log entry.....	100	Replace a handset.....	121
Save a call log entry to the		Troubleshooting	122
directory.....	101	Maintenance.....	135
To delete a single entry	103	Important safety information	136
To delete all entries	103	Safety information.....	136
Reasons for missing caller ID		Especially about corded	
information	104	telephones.....	136
Answering system		Precautions for users of implanted	
About the answering system.....	105	cardiac pacemakers.....	137
Answering system and		Pacemaker patients.....	137
voicemail.....	105	Especially about telephone	
Answering system new message		answering systems.....	137
indication.....	106	FCC Part 68 and ACTA.....	138
Message capacity	106	FCC Part 15.....	139
Voice prompts	106	Limited warranty.....	140
Call screening at the telephone		Technical specifications	142
base.....	107	DECT 6.0 digital technology.....	142
Call intercept.....	107	Telephone operating range	142
Telephone base ringer		Extended range and clarity	142
volume	107	Index	143
Temporarily turning off the			
message alert tone.....	107		
Message playback.....	108		
Delete all old messages.....	109		
Record memos.....	110		
To play a memo	111		
Remote access.....	112		
To remotely access the			
answering system.....	112		
Remote commands.....	112		
Appendix			
Handset screen icons.....	113		
Telephone base screen icons.....	114		
Alert tones and lights	115		
Handset alert tones.....	115		
Telephone base alert tones.....	115		
Handset indicator lights.....	115		
Telephone base indicator			

Quick reference guide - handset

Softkeys (2)

Press to select a menu item displayed above the key.

CHARGE light (blue ring around **DIR/▲VOLUME▼/CID**)

On when the handset is charging in the telephone base or charger.

DIR/▲VOLUME

Press to scroll up while in menus.

Press to increase the volume level during a call (page 66).

Press to show directory entries when the telephone is not in use (page 86).

While entering names or numbers in the directory, press to move the cursor to the right (page 82).

CELL

Press to make or answer a cell call (page 60).

During a cell call, press to answer an incoming call when you hear a call waiting alert (page 62).

Flashes quickly when there is an incoming cell call.

Flashes slowly when a cell call is on hold.

1

While reviewing a caller ID history entry, press repeatedly to add or remove **1** in front of the telephone number before dialing or saving it in the directory (page).

-tone ✕

Press to switch to tone dialing temporarily during a call if you have pulse service (page 35).

)/SPEAKER

Press to turn on the handset speakerphone. Press again to resume normal handset use (page 66).

HOLD

Press to put a home or cell call on hold (page 68).

OFF/CLEAR

While using menus, press to cancel an operation, back up to the previous menu, or exit the menu display (page 5).

During a call, press to hang up (page 58).

CID/VOLUME▼

Press to scroll down while in menus.

Press to decrease the volume level during a call (page 66).

Press to show the caller ID history when the telephone is not in use (page 98).

While entering names or numbers in the directory, press to move the cursor to the left (page 82).

1 LINE/FLASH/ 2 LINE/FLASH

Press **LINE 1/FLASH** to make or answer a call on line 1 (page 58). During a call, press to receive an incoming call on line 1 when you receive a call waiting alert (page 60).

Press **LINE 2/FLASH** to make or answer a call on line 2 (page 58). During a call, press to receive an incoming call on line 2 when you receive a call waiting alert (page 60).

#

Press repeatedly to display other dialing options when reviewing a caller ID history entry (page 100).

PAUSE/REDIAL

Press repeatedly to view the last 20 numbers dialed (page 71).

While entering numbers, press and hold to insert a dialing pause (page 82).

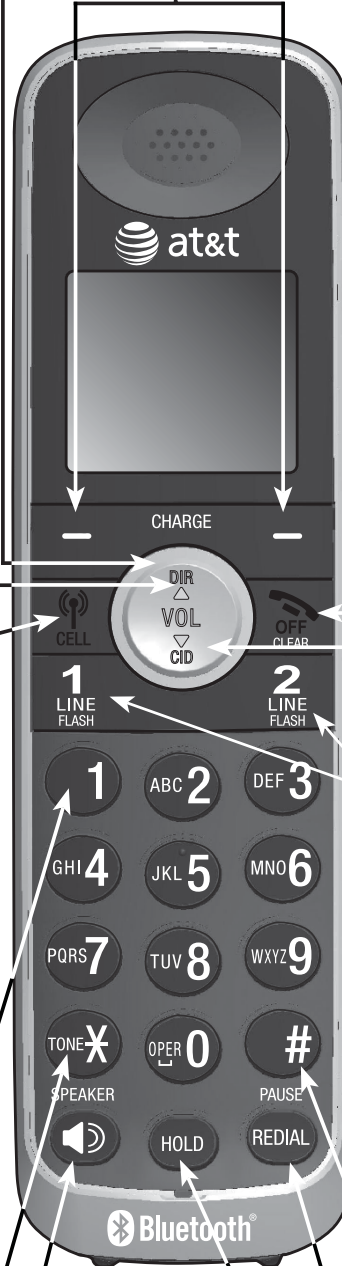

Getting started

Quick reference guide - telephone base



CID▼

While in a menu, press to scroll down.
Press to review the call log when the telephone is not in use (page 99).
While entering names or numbers, press to move the cursor to the left.

▲DIR

Press to scroll up while in menus.
Press to show directory entries when the telephone is not in use (page 86).
While entering names or numbers, press to move the cursor to the right.

CANCEL

While in a menu, press to exit without making changes or press and hold to return to idle mode.

DEVICE A/DEVICE B lights

On when the telephone base is paired and connected with a Bluetooth device.
Flash alternately while pairing a Bluetooth device.

REDIAL

Press to review the redial list (page 71).

Softkeys (2)

Press to select a menu item displayed above the key.

Quick reference guide - telephone base

◀/REPEAT

Press to repeat a message or press twice to play the previous message (page 108).

TONE ✕

Press to switch to tone dialing temporarily during a call if you have pulse service (page 35).

HOLD

Press to put a call on hold (page 68).

▼ VOLUME ▲

Press to adjust the volume during playback (page 100).

Press to adjust the volume during a call (page 66).

When the phone is not in use, press to adjust the telephone base ringer volume (page 38).

FLASH

During a call, press to receive an incoming home or cell call if you subscribe to call waiting (page 60).

SPEAKER 📢

Press to switch between speakerphone and corded handset (page 66).

Press to switch from corded handset or Bluetooth headset to speakerphone.

Press to switch the base speakerphone on or off.

HEADSET

Press to transfer an incoming call to the headset.

Press to use a Bluetooth headset during an incoming or existing call.

Press to end a call on the Bluetooth headset if the corded handset is in the telephone base.

▲/DELETE

Press to delete the message currently playing (page 108).

When the phone is not in use, press twice to delete all previously reviewed messages (page 109).

🔌/ON/OFF LINE 1/ 🔌/ON/OFF LINE 2

Press to turn the answering system or line 1 or line 2 on or off (page 49).

▶/SKIP

Press to skip to the next message (page 108).

▼/REC

Press to record a memo (page 110) or announcement (page 49).

▶■/MAILBOX LINE 1/ ▶■/MAILBOX LINE 2

Press to start or stop message playback in the mailbox line 1 or line 2 (page 108).

1 LINE/2 LINE

Press to make or answer a call on line 1 or line 2 (page 58).

CELLULAR 📶

Press to make or answer a cell call (page 61).

Flashes quickly when there is an incoming cell call.

Flashes slowly when a cell call is on hold.



Quick reference guide - handset



EQ 

During an outside call, intercom call, message or announcement playback, press to change the quality of the audio to best suit your hearing (page 68).



Press the **MENU** softkey to enter the main menu which includes the following:

- Play messages (page 103)
- Answering sys (page 100)
- Directory (page 86)
- Call log (page 91)
- Intercom (page 75)
- Ringers (page 32)
- Settings (page 33)
- Website (page 36)



Handset main menu

To enter the main menu

1. Press the **MENU** softkey in idle mode to enter the main menu.
2. Press **CID**▼ or **▲DIR** to select a handset feature menu, then press the **SELECT** softkey to enter that menu.

Press **OFF/CLEAR** to cancel an operation, back up to the previous menu or exit the menu display.

To return to idle mode, Press and hold **OFF/CLEAR** to return to idle mode.

i NOTE: If no key is pressed, the handset automatically returns to idle mode after 30 seconds.

PLAY MESSAGES - play messages stored in **Mailbox 1** or **Mailbox 2**.



ANSWERING SYS - play, record, delete your announcement and memos and change your answering system settings.

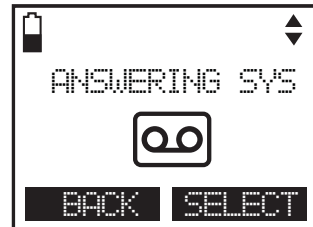

DIRECTORY - store and search for names and numbers.



CALL LOG - review the caller ID history or delete all call log entries.



INTERCOM - intercom call with the telephone base or a system handset.

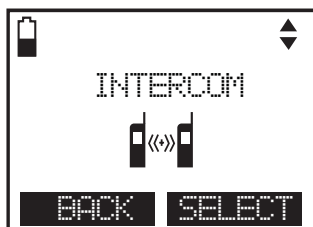

RINGERS - set up ringers for the home and cell line.

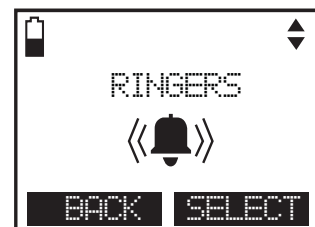

SETTINGS - change your handset settings.



WEBSITE - view the AT&T website address.



Telephone base main menu

To enter the main menu

1. Press the **MENU** softkey in idle mode to enter the main menu.
2. Press **▼CID** or **▲DIR** to scroll through menu items.
3. Press the **SELECT** softkey to select the highlighted item.

Press **CANCEL** to cancel an operation, back up to the previous menu or exit the menu display.

To return to idle mode, press and hold **CANCEL** to return to idle mode.

i **NOTE:** If no key is pressed, the handset automatically returns to idle mode after 30 seconds.

Play messages - play messages stored in **Mailbox 1** or **Mailbox 2**.

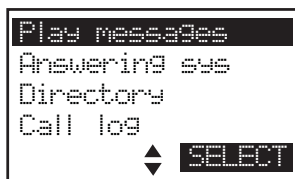

Answering sys - play, record, delete your announcement and memos and change your answering system settings.

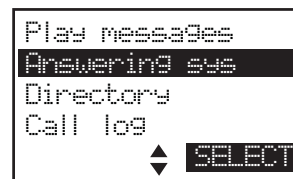

Directory - store and search for names and numbers.



CALL LOG - review the caller ID history or delete all call log entries.

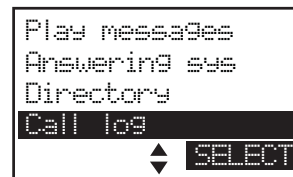

Bluetooth - setup and manage your Bluetooth devices.



Page all handsets - page the system handset(s).



Intercom - intercom call with the telephone base or a system handset.



Ringers - set up ringers for the home and cell line.



Settings - change your handset settings.



Website - view the AT&T website address.



You must install and charge the handset battery before using the cordless handset.



See pages 10-11 for easy instructions.

Install the telephone base close to a telephone jack and a power outlet not controlled by a wall switch. The telephone base should be placed on a flat surface. For optimum range and better reception, place the telephone base in a central and open location.

You may hear interference if your cellular phone is too close to the telephone base during a **CELLULAR** call. Make sure that your Bluetooth enabled cellular phone is within 15 feet of the telephone base in order to maintain a clear and consistent connection between your Bluetooth cell phone, telephone base and cell tower.

If you subscribe to high-speed Internet service (digital subscriber line - DSL) through your telephone line, you must install a DSL filter between the telephone line cord and the telephone wall jack (page 8). The filter prevents noise and caller ID problems caused by DSL interference. Please contact your DSL service provider for more information about DSL filters.

Your product may be shipped with a protective sticker covering the handset or telephone base display - remove it before use.

For customer service or product information, visit our website at **www.telephones.att.com** or call **1 (800) 222-3111**. In Canada, dial **1 (866) 288-4268**.

Avoid placing the telephone base too close to:

- Communication devices such as: television sets, VCRs, or other cordless telephones.
- Excessive heat sources.
- Noise sources such as a window with traffic outside, motors, microwave ovens, refrigerators, or fluorescent lighting.
- Excessive dust sources such as a workshop or garage.
- Excessive moisture.
- Extremely low temperature.
- Mechanical vibration or shock such as on top of the washing machine or work bench.

Telephone base installation

If you subscribe to high-speed Internet service (digital subscriber line - DSL) through your telephone line, you must install a DSL filter between the telephone line cord and the telephone wall jack. The filter prevents noise and caller ID problems caused by DSL interference. Please contact your DSL service provider for more information about DSL filters.

Follow the steps below to install the telephone.

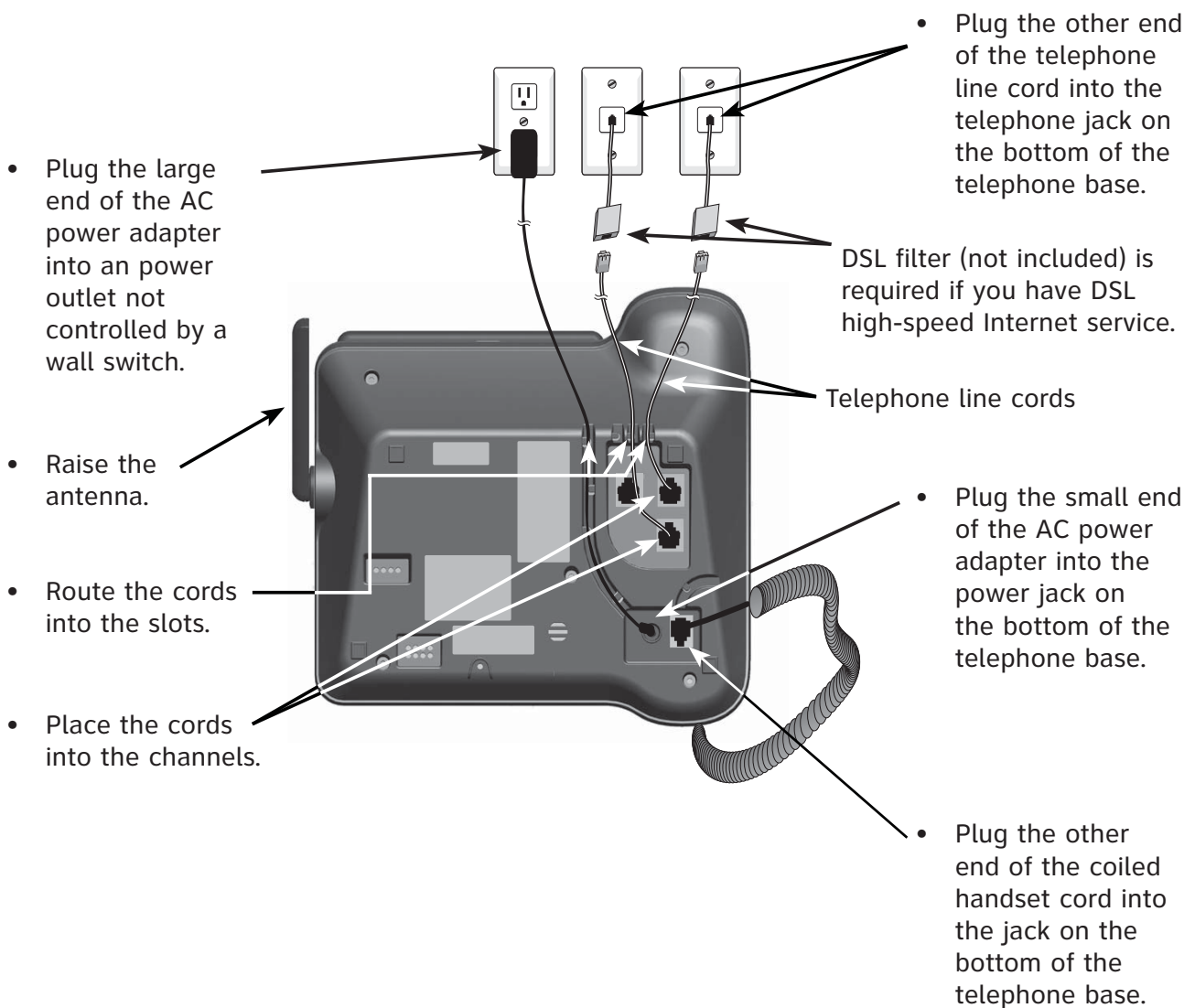

Getting started
Charger installation

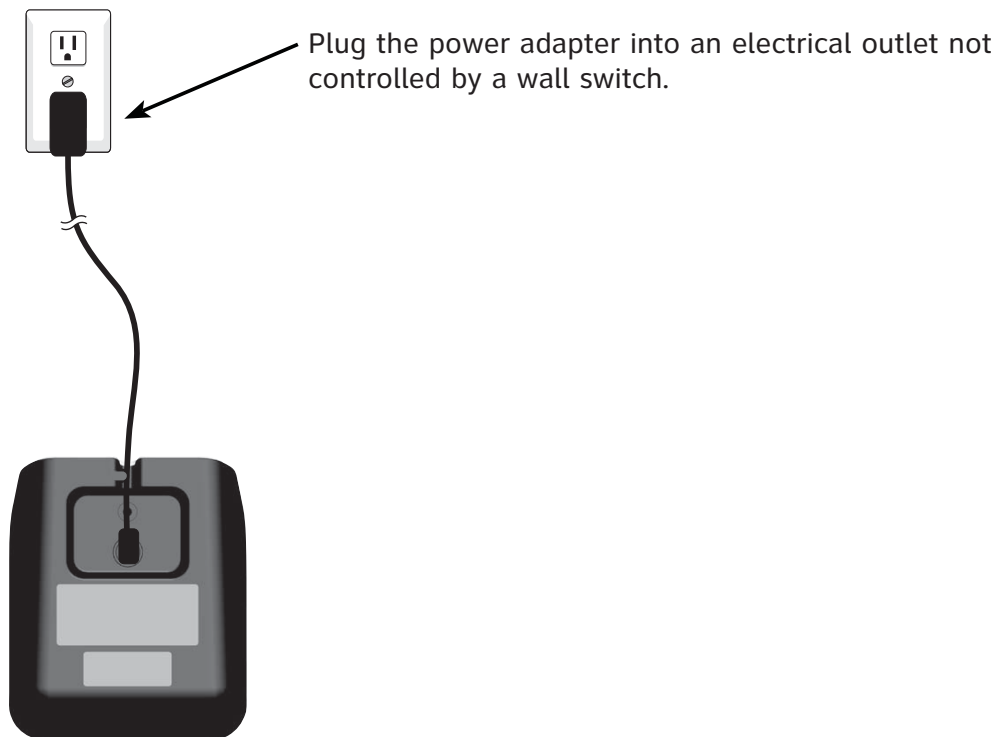

IMPORTANT INFORMATION:

1. Use only the power adapter(s) provided with this product. To obtain a replacement, visit our website at **www.telephones.att.com** or call **1 (800) 222-3111**. In Canada, dial **1 (866) 288-4268**.
2. The power adapters are intended to be correctly oriented in a vertical or floor mount position. The prongs are not designed to hold the plug in place if it is plugged into a ceiling, under-the-table or cabinet outlet.

Battery installation and charging

Install the battery as shown below.



Step 1

Plug the battery connector securely into the socket inside the handset battery compartment, matching the color-coded label. Insert the supplied battery with the label **THIS SIDE UP** facing up as indicated.



Step 2

Align the cover flat against the battery compartment, then slide it upwards until it clicks into place.

CHARGE light Step 3



Charge the handset by placing it face up in the charger. The **CHARGE** light is on when charging.

After you install your telephone or power returns following a power outage, the handset will prompt you to set the date and time. For instructions, see **Set date/time** on page 34. To skip setting the date and time, press **OFF/CLEAR**.

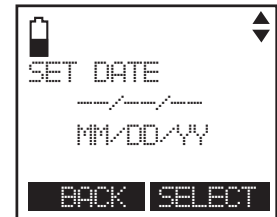

To replace the battery, press the tab and slide the battery compartment cover downwards. Lift out the old battery and disconnect it from the handset. Follow the instructions above to install and charge the new battery.



IMPORTANT INFORMATION:

1. Use only the supplied rechargeable battery or replacement battery (model BT166342). To order, visit our website at **www.telephones.att.com** or call **1 (800) 222-3111**. In Canada, dial **1 (866) 288-4268**.
2. If you do not use the handset for a long time, disconnect and remove the battery to prevent possible leakage.

Battery charging

Once you have installed the battery, the screen indicates the battery status (see table below). If necessary, place the handset in the telephone base or charger to charge the battery. For best performance, keep the handset in the telephone base or charger when not in use. The battery is fully charged after 16 hours of continuous charging. See the table on page 142 for battery operating times.

If the screen shows **Low battery**, you need to charge the battery without interruption for at least 30 minutes to give the handset enough charge to use the telephone for a short time. The following table summarizes the battery charge indicators and actions to take.

Battery indicators	Battery status	Action
The screen is blank or shows Place in charger .	The battery has no charge or very little charge. The handset cannot be used.	Charge without interruption until the screen shows Low battery or Handset X (at least 30 minutes).
The screen shows Low battery and  flashes.	Battery has enough charge to be used for a short time.	Charge without interruption until the screen shows HANDSET X (at least 30 minutes).
The screen shows HANDSET X .	Battery is charged.	To keep the battery charged, place it in the telephone base or charger when not in use.

 **NOTE:** If you are on a phone call in low battery mode, you hear four short beeps every minute.

Belt clip & optional headset

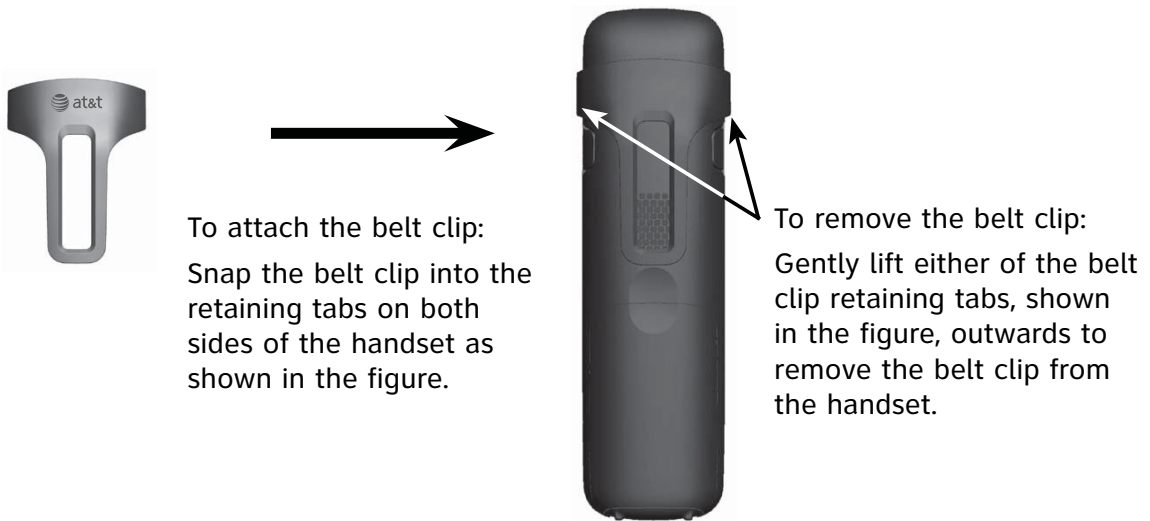

For handsfree telephone conversations, you can use any industry standard 2.5 mm headset (purchased separately). For best result, use an AT&T 2.5 mm headset. To purchase a headset, visit our website

www.telephones.att.com or call **1 (800) 222-3111**. In Canada, dial **1 (866) 288-4268**.

Plug a 2.5 mm headset into the jack on the side of handset (beneath the small rubber flap).

Lift the rubber flap here.

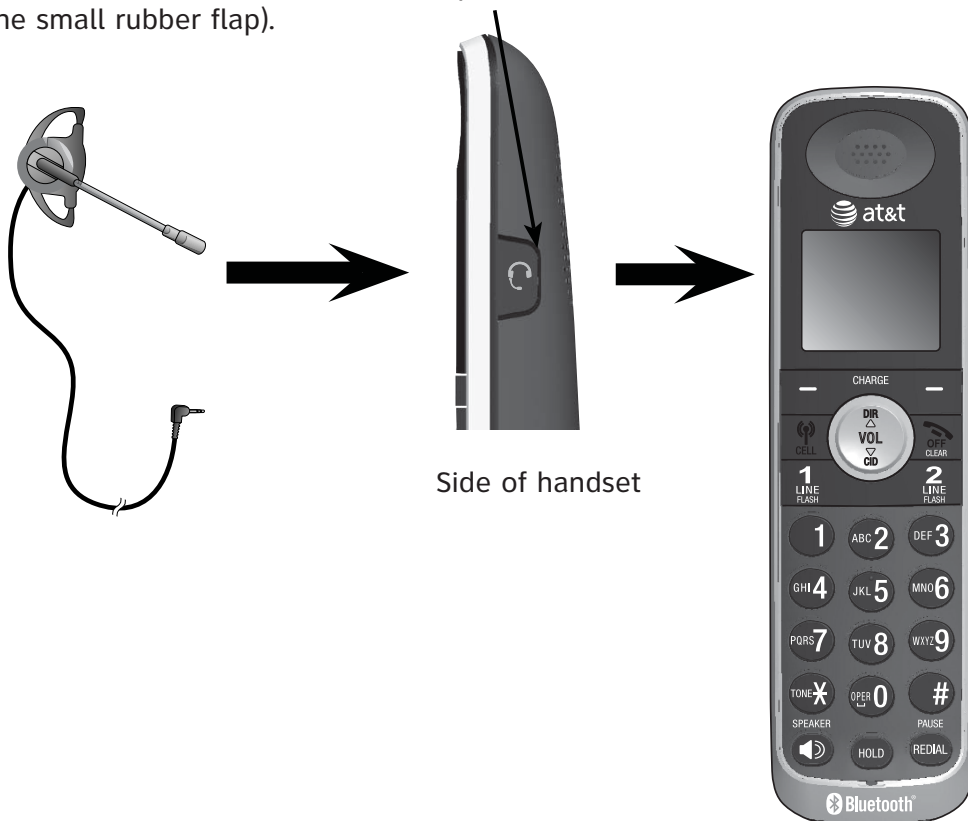

Introducing Bluetooth

Your new AT&T **TL86109** telephone system with Bluetooth wireless technology has the following features:

- Pair up to four Bluetooth enabled devices (cell phones or headsets) with the telephone base.
- Connect a maximum of two cell phones to make and receive cell calls. Only one cell phone can be active on a call at a time.
- Connect a Bluetooth enabled headset for making and receiving home calls.
- Conference cell and home calls.
- Make and receive calls using your cell phone plan with your cordless system handsets.

IMPORTANT INFORMATION

- After plugging in the telephone base, wait at least 20 seconds before connecting a Bluetooth device. The screen shows **Bluetooth system busy** if you try to connect too soon.
- Refer to the user's manual of your Bluetooth enabled cell phone or headset for more information about how that device uses Bluetooth connectivity.
- Bluetooth wireless technology operates within a short range (up to 30 feet) from the telephone base. Keep connected cell phones and headset within this range.
- If your cell phone has poor reception in your home, the **TL86109** cannot improve the reception. However, if you have a location in your house with better reception, you can leave your cell phone in that location while you use the **TL86109** cell line. In order for this to work, the cell phone must be within 15 feet of the telephone base for optimal performance.
- Charge your cell phone while it is connected to the telephone base. Your cell phone's battery discharges faster while it is connected to the telephone base via Bluetooth wireless technology.
- Monitor your cell phone's usage, because minutes may be deducted from your cellular plan for the duration of all cell calls, depending on the terms of your plan.

Refer to the **Bluetooth setup** section (pages 15-29) to learn how to set up your Bluetooth device. Refer to the **Telephone operation** section (page 58) on how to operate your Bluetooth devices with your new **TL86109** AT&T telephone system with Bluetooth wireless technology. Refer to the **Troubleshooting** section (pages 122-134) if you experience difficulty when using the telephone system.

Glossary of terms

Below are some terms used in this user's manual to help you become familiar with using your Bluetooth devices and your new AT&T telephone system.

Active devices - a Bluetooth enabled device, paired and connected to the telephone base. A maximum of two paired devices (two cell phones, or one cell phone and one headset) can be connected to the telephone base, but only one can be on a call at a time.

Bluetooth cell phone - refers to a mobile Bluetooth enabled cellular telephone.

CELLULAR line - the telephone line associated with your cell phone service. On your **TL86109** handset, press  **CELLULAR** to use the cell line.

Connected - a Bluetooth enabled device (cell phone or headset) can only be used when it is connected to the telephone base. When a Bluetooth enabled device is connected to the telephone base and listed on the active devices list, it is ready for use.

Disconnected - a diagonal line appears across devices A and/or B when the corresponding Bluetooth enabled device is disconnected from the telephone base.

Discoverable mode - before a Bluetooth enabled device can be paired, it must be set to this mode. When pairing your cell phone, the telephone base is in this mode. Depending on the manufacturer, this mode is sometimes referred to as **Find Me or Visibility**.

HOME line - your conventional telephone land line. On your **TL86109** handset, press  **HOME/FLASH** to use the home line.

Paired devices - Bluetooth enabled devices (cell phone or headset) that have shared registration information with the telephone base. A total of four Bluetooth enabled devices can be paired with the telephone base; however, only two paired devices can be connected to the base at a time.

Pairing - sometimes refers to as **bonding**. The process of sharing registration information between two Bluetooth enabled devices. Your Bluetooth enabled cell phone or headset must first be paired to the telephone base in order to use it with this cordless phone system.

PIN - by default, the PIN is **0000** for the telephone base and for most Bluetooth devices. PIN information must be exchanged between Bluetooth devices before they can be used. This is also known as a **Passkey** or **Passcode**.

Bluetooth setup



To use a Bluetooth enabled cellular phone with your telephone, you must first pair and connect your Bluetooth cellular phone with the telephone base. The **TL86109** handset can be used to make or answer on the cell phone line.

Bluetooth wireless technology operates within a short range (up to 30 feet). When you pair a Bluetooth cell phone or Bluetooth headset to the telephone base, keep the device within 15 feet of the telephone base for optimal performance.

Pairing a cell phone

Before you begin, make sure that you have cellular coverage and your Bluetooth enabled cell phone is not connected to any other Bluetooth device. Refer to your cell phone user's manual to learn how to search for or add new Bluetooth devices.

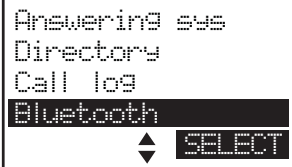
To pair and connect a cell phone:

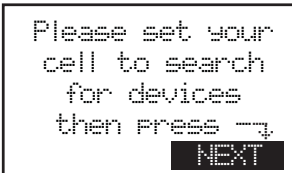
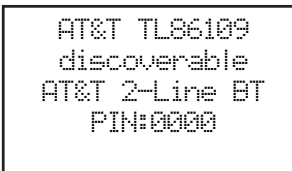
1. Press the **MENU** softkey on the telephone base in idle mode to enter the main menu.
- 
2. Press **▼CID** or **▲DIR** to highlight **Bluetooth**, then press the **SELECT** softkey.
- 
3. Press **▼CID** or **▲DIR** to highlight **Add cellular**, then press the **SELECT** softkey. The screen displays **Please set your cell to search for devices**. Press the **NEXT** softkey.
 - If there are already four devices on the paired devices list, the screen displays **Device list is full. Replace paired device?** Press the **YES** softkey to confirm and you are prompted to replace an existing paired device (page 23).
 - If a device is already connected to the telephone base, the screen displays **Connected devices will be temporarily disconnected**. Press the **OK** softkey to temporarily disconnect all the connected devices and continue the pairing process.
- 
- 
4. Turn on the Bluetooth feature of your cell phone and search for or add new devices.
 5. Once your cell phone find **AT&T 2-Line BT**, press the select key on the cell phone to continue the pairing process.
 6. Enter the PIN of the telephone base (the default PIN is **0000**) into your cell phone.
 7. When a device is successfully paired, the telephone base displays **Pairing complete**.

Bluetooth setup

8. The telephone base then displays **Connect cell to base?** Press the **YES** softkey to connect your cell phone to the telephone base. The telephone base displays **Device connected to the base**. The corresponding status icon (Ⓜ **A** or Ⓜ **B**) displays. The corresponding device light on the telephone base (**DEVICE A** or **DEVICE B**) turns on.

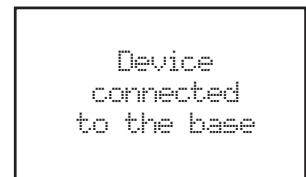

- If you already have two devices on the active devices list, the telephone base screen displays **Max. connectable devices is two** and you are prompted to replace an existing device on the active devices list (page 23).

i **NOTE:** The pairing process may take up to one minute. If the pairing process fails, try again.

Auto connection

When a cell phone is successfully paired with the telephone base but fails to connect to the telephone base, the telephone base displays **Connection failed** and then **Enable auto-connect?**



- You can press the **YES** softkey to confirm, the telephone base displays **Auto-connect function enabled**.

-OR-

- Press the **NO** softkey to exit.

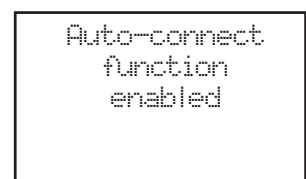

You can also connect a device manually (page 20).

Bluetooth setup

Pair a headset

Before you begin, make sure that your Bluetooth enabled headset is not connected to any other Bluetooth device. Refer to your headset user's manual to learn how to search for or add new Bluetooth devices.

To pair and connect a headset:

1. Press the **MENU** softkey on the telephone base in idle mode to enter the main menu.
2. Press **▼CID** or **▲DIR** to highlight **Bluetooth**, then press the **SELECT** softkey.
3. Press **▼CID** or **▲DIR** to highlight **Add headset**, then press the **SELECT** softkey. The screen displays **Pls set your headset to discoverable mode**.
 - If there are already four devices on the paired devices list, the screen displays **Device list is full. Replace paired device?** Press the **YES** softkey and you are prompted to replace an existing paired device (page 23).
 - If a device is already connected to the telephone base, the screen displays **Connected device will be temporarily disconnected**. Press the **OK** softkey to temporarily disconnect the device and continue the pairing process.
4. Set your headset to discoverable mode.
5. Press the **NEXT** softkey to set your telephone base to discoverable mode and search for your headset.
6. Once the telephone base finds your headset, press the **SELECT** softkey.
7. Enter the PIN of your headset (the PIN for most Bluetooth devices is **0000**), then press the **NEXT** softkey.
8. If the PIN is correctly entered, the telephone base displays **Headset setup complete**.

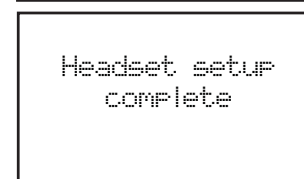
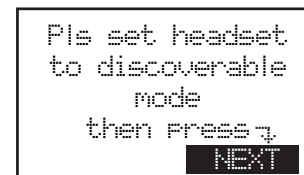

Bluetooth setup

9. The telephone base displays **Connect headset to base?** Press the **YES** softkey to confirm. The telephone base displays **Device connected to the base** and the corresponding status icon (📶 **A** or 📶 **B**) display when the headset is successfully connected. The corresponding light on the telephone base (**DEVICE A** or **DEVICE B**) turns on.
- When you already have two devices on the active devices list, the screen displays **Max. connectable devices is two** and you are prompted to replace an existing device on the active devices list (page 23).
 - When you already have one headset on the active devices list, the handset shows **Only 1 headset can be connected**. You are prompted to replace the headset on the active devices list. The screen displays **Replace currently active headset?** Press the **YES** softkey to replace the existing headset on the active devices list.

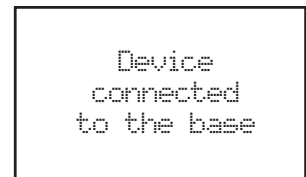
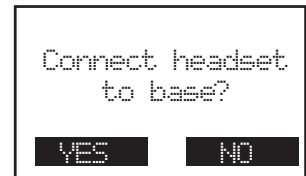

i **NOTE:** The pairing process may take up to one minute. If the pairing process fails, try again.

Bluetooth setup

Paired devices

All paired devices are stored on the **Paired devices** list. Up to four devices (cell phones and headsets) can be paired with the telephone base.

To use a paired device, it must be in the active list (page 21) and connected.

Once you have paired a device with the telephone base, you do not need to repeat the pairing procedure again unless you delete the device from the paired devices list.

i **NOTE:** Only the first 15 characters of the device name are shown on the paired devices list.

Rename a paired device

You can change the name of a paired device on the paired devices list.

1. Press the **MENU** softkey on the telephone base in idle mode.
2. Press **▼CID** or **▲DIR** to highlight **Bluetooth**, then press the **SELECT** softkey.
3. Press **▼CID** or **▲DIR** to highlight **Paired devices**, then press the **SELECT** softkey.
4. Press **▼CID** or **▲DIR** to highlight a device when necessary, then press the **OPTION** softkey.
5. Press **▼CID** or **▲DIR** to highlight **Rename**, then press the **SELECT** softkey. The screen displays **ENTER NEW NAME**.
6. Use the dialing keys to edit the name (page 84).
 - Press **CANCEL** to erase a character.
 - Press **▼CID** to move the cursor to the left or **▲DIR** to the right.
7. Press the **SELECT** softkey to confirm. The handset displays **Device renamed**.

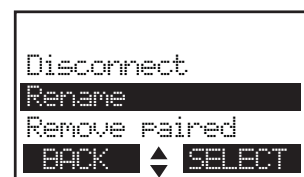

Bluetooth setup

Remove a paired device

If you want to add another Bluetooth device and you already have the maximum of four devices on the paired devices list, you must first delete a device from the paired devices list.

To remove a paired device:

1. Press the **MENU** softkey on the telephone base in idle mode to enter the main menu.
2. Press **▼CID** or **▲DIR** to highlight **Bluetooth**, then press the **SELECT** softkey.
3. Press **▼CID** or **▲DIR** to highlight **Paired devices**, then press the **SELECT** softkey.
4. Press **▼CID** or **▲DIR** to highlight a selected device when necessary, then press the **OPTION** softkey.
5. Press **▼CID** or **▲DIR** to highlight **Remove paired**, then press the **SELECT** softkey. The handset displays **Remove device from paired list?**
6. Press the **SELECT** softkey to confirm. The handset displays **Device removed from paired list**. Press the **YES** softkey to confirm.
7. The screen displays **Device removed from paired list** and you hear a confirmation tone.

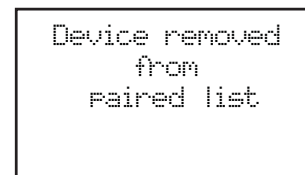

View information of an active device

To view the information of an active device:

1. Press the **MENU** softkey on the telephone base in idle mode to enter the main menu.
2. Press **▼CID** or **▲DIR** to highlight **Bluetooth**, then press the **SELECT** softkey.
3. Press **▼CID** or **▲DIR** to highlight **Paired devices**, then press the **SELECT** softkey.
4. Press **▼CID** or **▲DIR** to highlight a selected device, then press the **INFO** softkey.
5. The screen displays the information of the device. Press the **OK** softkey to return to the **Paired devices** list.

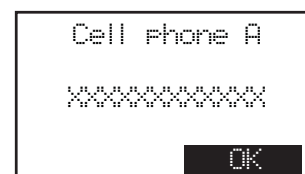
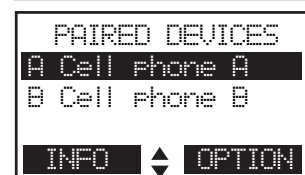
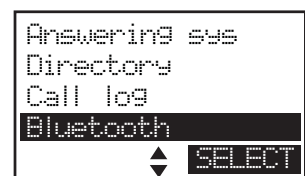

Bluetooth setup

Active devices

Only devices on the active devices list can establish a Bluetooth connection with the telephone base. Although two active devices can be connected to the telephone base, only one Bluetooth cell phone or a headset can be on a call at a time.

i NOTE: When adding, removing, or replacing a Bluetooth device on the active devices list, all connected devices are temporarily disconnected until the procedure is complete. It may take up to two minutes to reconnect.

Review the active devices list

1. Press the **MENU** softkey on the telephone base when it is not in use.
2. Press **▼CID** or **▲DIR** to highlight **Bluetooth**, then press the **SELECT** softkey.
3. Press **▼CID** or **▲DIR** to highlight **Active devices**, then press the **SELECT** softkey.

Connect/disconnect an active device

While in the active devices menu, you may connect or disconnect your active device.

1. Press **MENU** softkey on the telephone base in idle mode.
2. Press **▼CID** or **▲DIR** to highlight **Bluetooth**, then press the **SELECT** softkey.
3. Press **▼CID** or **▲DIR** to highlight **Active devices**, then press the **SELECT** softkey.
4. Press **▼CID** or **▲DIR** to highlight a device when necessary, then press the **OPTION** softkey.
5. Press **▼CID** or **▲DIR** to highlight **Connect/Disconnect** (whichever is applicable), then press the **SELECT** softkey to confirm.

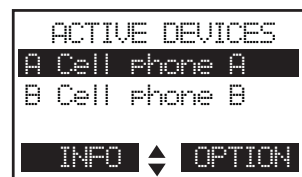

i NOTE: When your active device is connected, you are prompted to select **Disconnect**. When your active device is disconnected, you are prompted to select **Connect**.

Bluetooth setup

While one or more than one active devices are disconnected, the telephone base displays the **CONNECT** softkey. You may also connect a device to the telephone base with the following steps:

1. Press the **CONNECT** softkey on the telephone base in idle mode.
2. If only one device is disconnected, the telephone base displays **Connecting Cell phone 1 to the base...**

-OR-

If more than one devices are disconnected, the telephone base displays **CONNECT DEVICE** list. Press **▼CID** or **▲DIR** to highlight a selected device, then press the **SELECT** softkey. The telephone base displays **Connecting Cell phone 1 to the base...**

3. When the connection is successful, the telephone base displays **Device connected to the base.**

 **NOTE:** If the connection fails, the telephone base displays **Connection failed**. Then it shows **Enable auto-connect?** Press the **Yes** softkey to confirm. The telephone base displays **Auto-connect function enabled**.

Bluetooth setup

Replace an active device

You can replace an active device with a device on the paired devices list even if you already have two devices on the active devices list.

To replace an active device:

1. Press the **MENU** softkey on the telephone base in idle mode to enter the main menu.
2. Press **▼CID** or **▲DIR** to highlight **Bluetooth**, then press the **SELECT** softkey.
3. Press **▼CID** or **▲DIR** to highlight **Paired devices**, then the **SELECT** softkey.
4. Press **▼CID** or **▲DIR** to highlight a device, then press the **SELECT** softkey.
5. Press the **SELECT** softkey again to select **Replace active**.
6. Press the **SELECT** softkey. You are prompted to select a device on the paired devices list.
7. Press **▼CID** or **▲DIR** to highlight the device to be replaced, then press the **SELECT** softkey. The handset displays **Device added to active list Connect now?** Press the **YES** softkey to confirm or the **NO** softkey to exit.

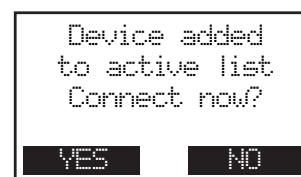
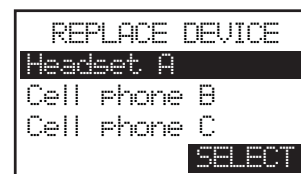
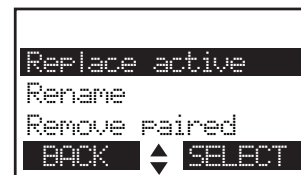
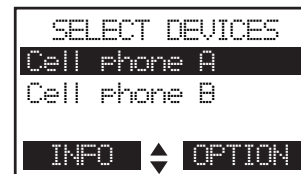

Bluetooth setup

Add an active device

You can have a maximum of two devices on the active devices list.

To add an active device:

1. Press the **MENU** softkey on the telephone base in idle mode to enter the main menu.
2. Press **▼CID** or **▲DIR** to highlight **Bluetooth**, then press the **SELECT** softkey.
3. Press **▼CID** or **▲DIR** to highlight **Active devices**, then press the **SELECT** softkey.
4. Press **▼CID** or **▲DIR** to highlight an empty position, then press the **ADD** softkey.
5. You are prompted to select a device from the **PAIRED DEVICE** list.
6. Press **▼CID** or **▲DIR** to select a paired device, then press the **SELECT** softkey. The telephone base displays **Device added to active list Connect now?** Press the **YES** softkey to confirm or the **NO** softkey to exit.

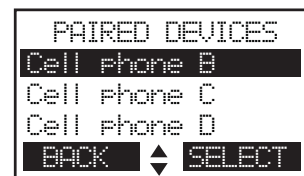

Bluetooth setup

Remove an active device

You can remove an active device from the active devices list.

To remove an active device:

1. Press the **MENU** softkey on the telephone base in idle mode to enter the main menu.
2. Press **▼CID** or **▲DIR** to highlight **Bluetooth**, then press the **SELECT** softkey.
3. Press **▼CID** or **▲DIR** to highlight **Active devices**, then press the **SELECT** softkey.
4. Press **▼CID** or **▲DIR** to highlight a selected device, then press the **OPTION** softkey.
5. Press **▼CID** or **▲DIR** to highlight **Remove active**, then press the **SELECT** softkey. The handset displays **Device removed from active list**.

i NOTE: Even though the active device is removed from the active devices list, it is still on the paired devices list.



View information of an active device

To view the information of an active device:

1. Press the **MENU** softkey on the telephone base in idle mode to enter the main menu.
2. Press **▼CID** or **▲DIR** to highlight **Bluetooth**, then press the **SELECT** softkey.
3. Press **▼CID** or **▲DIR** to highlight **Active devices**, then press the **SELECT** softkey.
4. Press **▼CID** or **▲DIR** to highlight a selected device, then press the **INFO** softkey.
5. The screen displays the information of the device. Press the **OK** softkey to return to the **Active devices** list.

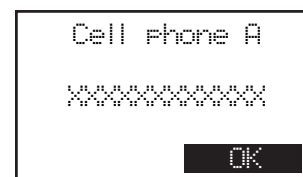
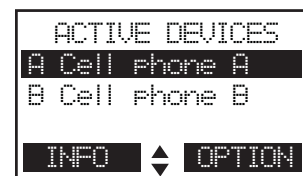
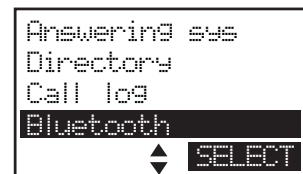

Change PIN

You are required to enter a PIN when establishing a Bluetooth connection. The default PIN of your telephone base is **0000**.

To change the PIN:

1. Press the **MENU** softkey on the telephone base in idle mode to enter the main menu.
2. Press **▼CID** or **▲DIR** to highlight **Bluetooth**, then press the **SELECT** softkey.
3. Press **▼CID** or **▲DIR** to highlight **Change PIN**, then press the **SELECT** softkey. The handset displays **ENTER NEW PIN** and the existing PIN.
4. Use the dialing keys to enter a new four-digit code.
 - Press **CANCEL** to erase a digit.
 - Press **▼CID** to move the cursor to the left or **▲DIR** to the right.
5. Press the **SET** softkey to save.



Bluetooth setup

Download directory

You can download up to four cell phone directories (phonebooks) to your **TL86109** telephone system via Bluetooth wireless technology. Each downloaded directory can store up to 1,500 entries with up to 30 digits for each phone number and 15 characters for each name.

Before downloading the directory, make sure the cell phone is paired to your **TL86109** and on the active devices list.

Place your cell phone next to the telephone base when you download a cell phone directory to your TL86109.

To download a cell phone directory:

1. Press the **MENU** softkey on the telephone base in idle mode.
2. Press **▼CID** or **▲DIR** to highlight **Bluetooth**, then press the **SELECT** softkey.
3. Press the **SELECT** softkey to choose **Download dir.**
 - If there is no cell phone paired to the system, the handset displays **No cellular device paired.** Press the **Add** softkey to pair a device.
4. Press **▼CID** or **▲DIR** to select a desired device, then press the **SELECT** softkey.
 - If the selected device is on the paired devices list but not in the active devices list, the handset displays **No cellular in active devices list.** Press the **Add** softkey to add a device to the active list.
 - If the selected device is on the active devices list but disconnected, the handset displays **Not connected. Place cell near base to connect.** Press the **NEXT** softkey to connect the device.
 - If the selected device's directory has already been downloaded to the **TL86109** before, the handset displays **Cell phone A Last update: mm/dd/yy.** Press the **NEXT** softkey key and the screen displays **Directory Cell phone A will be erased.** If you press the **NEXT** softkey to continue the download process, the directory stored on the **TL86109** for that cell phone is erased and replaced with the current cell phone directory. If you have edited the downloaded entries (page 90), those changes are lost.
 - If you already have four downloaded directories, the handset displays **Memory is full. Replace existing directory?** Press the **YES** softkey and the system prompts you to replace an existing directory before downloading.



Bluetooth setup

5. Press **▼CID** or **▲DIR** to highlight one of the following options:

- **Phone memory** - download all contacts stored in your phone memory.
- **SIM card only** - download all contacts stored in your SIM card.
- **Phone and SIM** - download all contacts stored in both your phone memory and SIM card.

Press the **SELECT** softkey. During the download, the telephone displays the progress. All system handsets display **LINK IN USE**.

6. When the downloading process is complete, the handset displays **Download complete XXXX entries saved**. Press the **OK** softkey to return to the **BLUETOOTH** menu.

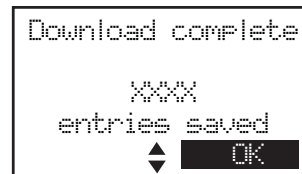
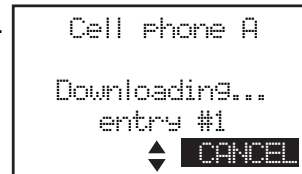

NOTES:

1. Certain cell phones do not support SIM card download. If this is the case, try transferring the contacts from your SIM card to your cell phone memory first, then download from your cell phone memory. For more information on how to transfer contacts from your SIM card to your cell phone memory, see the user's manual of your cell phone.
2. If **Phone memory** is chosen but with no entries saved, the handset displays **No entries found. Try downloading from SIM only?** If **SIM card only** is chosen but with no entries saved, the handset displays **No entries found. Try downloading from phone only?** If **Phone and SIM** are chosen but with no entries saved in either or both directories, the handset display **No entries found. Try downloading from Phone only?**
3. When downloading the directory from your Bluetooth enabled cell phone, some data may not transfer. For example, if you have home, mobile and work numbers for a particular contact, the three categories may not transfer to your **TL86109**.
4. On certain cell phones, you may need to press a key to confirm the directory download.

Interruption to directory download

If you are downloading a directory from a cell phone and the cell phone receives a call, the download process stops. After the call, the telephone base displays **Download fail**. When you try to view the downloaded directory, the telephone base displays **Last download failed: MM/DD/YY**. You need to download the directory again (see page 27).

If you are downloading a directory from a cell phone and then receive a **Line 1** or **Line 2** call, the download process stops. After the call, the telephone base displays **IN USE** and resumes the download process.

When you are downloading a directory from a cell phone and you wish to stop the download process, you may press the **CANCEL** softkey, the telephone base displays **Directory download cancelled** and then shows **Download fail**.

i NOTE: During the download process, do not attempt to make changes to your cell phone directory.

View the directory download information

1. Press the **MENU** softkey on the telephone base in idle mode to enter the main menu.
2. Press **▼CID** or **▲DIR** to highlight **Directory**, then press the **SELECT** softkey.
3. Press **▼CID** or **▲DIR** to choose the desired downloaded directory, then press the **SELECT** softkey.
4. Press **▼CID** or **▲DIR** to highlight **Last update**, then press the **SELECT** softkey. The telephone base displays the last update information of the downloaded directory.

```

Play messages
Answering sys
Directory
Call log
          SELECT
  
```

```

          DIRECTORY
Home
Cell phone A
Cell phone B
          SELECT
  
```

```

          SELECT DEVICE
A Cell phone A
B Cell phone B
          SELECT
  
```

```

          CELL PHONE A
Review
Cell area code
Last update
          SELECT
  
```

```

          CELL PHONE A
Last update
12/25/09
XXXX entries
          OK
  
```

Ringer volume

You can select the ringer volume for the incoming home and cell calls.

To adjust the handset ringer volume:

1. Press the **MENU** softkey on the handset in idle mode to enter the main menu.
2. Press **CID**▼ or **▲DIR** to highlight **RINGERS**, then press the **SELECT** softkey.
3. Press the **SELECT** softkey to choose **Ringer volume**.
4. Press **CID**▼ or **▲DIR** to select **All lines**, **Line 1**, **Line 2**, **Cell A** or **Cell B**, then press the **SELECT** softkey to confirm.
5. Press **CID**▼ or **▲DIR** to adjust the ringer volume. A sample of each ringer volume plays as you scroll through the choices.
6. Press the **SET** softkey to confirm. You hear a confirmation tone.

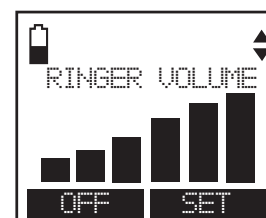
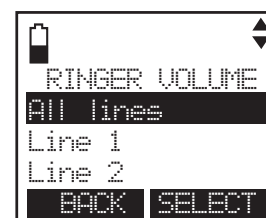
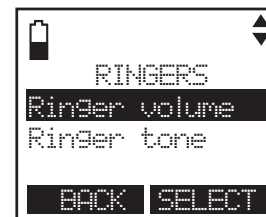

iNOTES:

1. Changing the handset ringer volume does not affect base ringer volume. For more information on base ringer volume, see page 107.
2. When the ringer volume of **Line 1** or **Line 2** is set to off, the handset displays **Ringer off** for the corresponding home line. When the ringer volume of **Cell A** or **Cell B** is set to off, the handset displays **Ringer A off** or **Ringer B off** respectively. When the ringer volume of all cell calls is set to off, the handset displays **Ringers off**.
3. The ringer volume of **Line 1** determines the ringer levels of intercom calls (page 75).

Ringer tone

You can select the ringer tones for the incoming home and cell calls.

To select a ringer tone:

1. Press the **MENU** softkey on the handset in idle mode to enter the main menu.
2. Press **CID**▼ or **▲DIR** to highlight **RINGERS**, then press the **SELECT** softkey.
3. Press **CID**▼ or **▲DIR** to highlight **Ringer tone**, then press the **SELECT** softkey.
4. Press **CID**▼ or **▲DIR** to select **All lines**, **Line 1**, **Line 2**, **Cell A** or **Cell B**, then press the **SELECT** softkey to confirm.
5. Press **CID**▼ or **▲DIR** to select a ringer tone. A sample of each ringer tone plays as you scroll through the choices.
6. Press the **SET** softkey to confirm. You hear a confirmation tone.

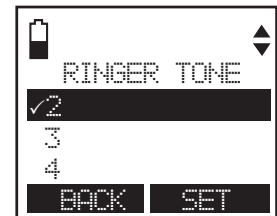
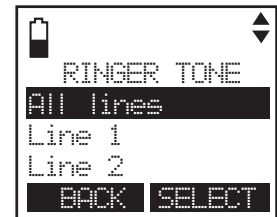
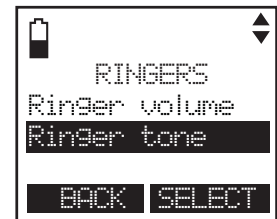

i **NOTE:** If you turn off the ringer volume, you do not hear ringer tone samples.

LCD language

You can select **English**, **Français** or **Español** to be used in all screen displays.

To select a language:

1. Press the **MENU** softkey in idle mode to enter the main menu.
2. Press **CID**▼ or **▲DIR** to highlight **SETTINGS**, then press the **SELECT** softkey.
3. Press the **SELECT** softkey to choose **LCD language**.
4. Press **CID**▼ or **▲DIR** to choose from **English**, **Français** or **Español**, then press the **SET** softkey. You hear a confirmation tone.

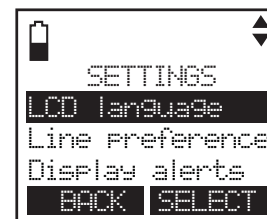

Line preference

You can select **Auto**, **Line 1**, **Line 2** or **Cell**.

To select a line preference:

1. Press the **MENU** softkey in idle mode to enter the main menu.
2. Press **CID**▼ or **▲DIR** to highlight **SETTINGS**, then press the **SELECT** softkey.
3. Press **CID**▼ or **▲DIR** to highlight **Line preference**.
4. Press **CID**▼ or **▲DIR** to choose from **Auto**, **Line 1**, **Line 2** or **Cell**, then press the **SET** softkey. You hear a confirmation tone.

Display alerts

If you subscribe to voicemail service offered by your telephone service provider, **L1>Voicemail** or **L2>Voicemail** and **✉ 1** or **✉ 2** appear on the handset(s) when you have new voicemail messages. Contact your telephone service provider for more information and assistance about using your voicemail service. This feature only works on the voicemail associated with **Line 1** or **Line 2**, not the cell line.

After you have listened to all new voicemail messages, the indicators on the handsets turn off automatically.

Use the clear voicemail feature when the telephone indicates that there is new voicemail but there is none (for example, when you have accessed your voicemail while away from home). Clearing the voicemail waiting indicator only turns off the indicators; it does not delete your voicemail messages. As long as you have new voicemail messages, your telephone service provider continues to send the signal that turns on the indicators.

Handset settings

To manually turn off the new voicemail indicator:

1. Press the **MENU** softkey on the handset in idle mode to enter the main menu.
2. Use **CID**▼ or **▲DIR** to scroll to **Settings**, then press the **SELECT** softkey.
3. Press **CID**▼ or **▲DIR** to scroll to **Display alerts**, then press the **SELECT** softkey.
4. Press **CID**▼ or **▲DIR** to choose from **Line 1**, **Line 2** or **Cell**, then press the **SELECT** softkey.
5. Press **CID**▼ or **▲DIR** to highlight **Voicemail**, then press the **SELECT** softkey.
6. The screen shows **Reset voicemail indication?** Press the **YES** softkey to turn the voicemail indication off. You hear a confirmation tone.

i **NOTES:**

1. Your telephone service provider might alert you to new voicemail messages with a stutter (broken) dial tone. Contact your telephone service provider for more details.
2. For more information about the difference between your answering system and voicemail, see page 68.

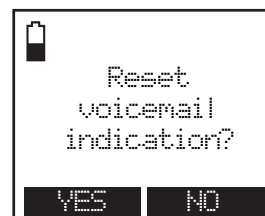
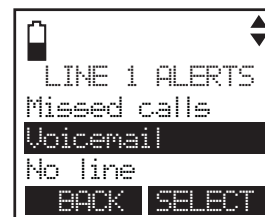
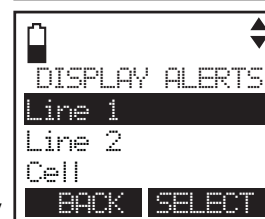

Key tone

The handset is set to beep with each key press. If you turn off the key tone, there are no beeps when you press keys.

To change the setting:

1. Press the **MENU** softkey on the handset in idle mode to enter the main menu.
2. Use **CID**▼ or **▲DIR** to scroll to **SETTINGS**, then press the **SELECT** softkey.
3. Press **CID**▼ or **▲DIR** to scroll to **Key tone**, then press the **SELECT** softkey.
4. Press **CID**▼ or **▲DIR** to select **On** or **Off**, then press the **SET** softkey. You hear a confirmation tone.

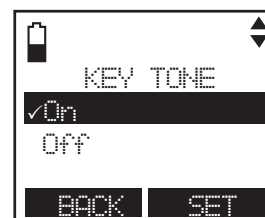
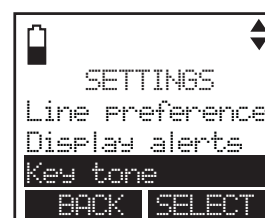

Set date/time

The answering system announces the day and time of each message prior to playing it. If you subscribe to caller ID service, the day, month and time are set automatically with each incoming call. Before using the answering system, set the date and time as follows.

After handset registration or a power failure, the handset will prompt you to set the date and time (see page 10).

To set the date and time:

1. Press the **MENU** softkey on the handset in idle mode to enter the main menu.
2. Press **CID▼** or **▲DIR** to highlight **SETTINGS**, then press the **SELECT** softkey.
3. Press **CID▼** or **▲DIR** to highlight **Set date/time**, then press the **SELECT** softkey.
4. Press the **SELECT** softkey to select **Date/time**.
5. Press **CID▼** or **▲DIR** to select the month and then press the **SET** softkey to confirm, or enter the correct number using the dial pad.
6. Press **CID▼** or **▲DIR** to select the day and then press the **SET** softkey to confirm, or enter the correct number using the dial pad.
7. Press **CID▼** or **▲DIR** to select the year or enter the correct number using the dial pad then press the **SET** softkey.
8. Press **CID▼** or **▲DIR** to select the hour and then press the **SET** softkey to confirm, or enter the correct number using the dial pad.
9. Press **CID▼** or **▲DIR** to select the minute and then press the **SET** softkey to confirm, or enter the correct number using the dial pad.
10. Press **CID▼** or **▲DIR** to choose **AM** or **PM**, then press the **SET** softkey to confirm. You hear a confirmation tone.

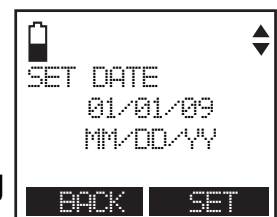
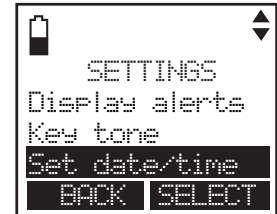

i NOTE: If the clock is not set when a message is recorded, the system announces, "Time and day not set" before the message is played.

Handset settings

Use caller ID to automatically set date and time

You can choose to have the date and time automatically set by incoming caller ID.

1. Press the **MENU** softkey on the handset in idle mode to enter the main menu.
2. Press **CID**▼ or **▲DIR** to highlight **SETTINGS**, then press the **SELECT** softkey.
3. Press **CID**▼ or **▲DIR** to highlight **Set date/time**, then press the **SELECT** softkey.
4. Press **CID**▼ or **▲DIR** to select **CID time sync**, then press the **SELECT** softkey.
5. Press **CID**▼ or **▲DIR** to select **On** or **Off**, then press the **SET** softkey to confirm. You hear a confirmation tone.

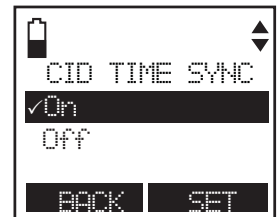
**Dial mode**

The dial mode is preset to tone dialing. If you have pulse (rotary) service, you must change the dial mode to pulse dialing before using the telephone.

To change the setting:

1. Press the **MENU** softkey on the handset in idle mode to enter the main menu.
2. Press **CID**▼ or **▲DIR** to highlight **SETTINGS**, then press the **SELECT** softkey.
3. Press **CID**▼ or **▲DIR** to highlight **Dial mode**, then press the **SELECT** softkey.
4. Press **▼CID** or **▲DIR** to choose **Tone** or **Pulse**, then press the **SET** softkey to confirm. You hear a confirmation tone.

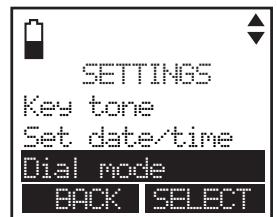

NOTE: When in **Pulse** mode, you can press * to temporarily change to touch tone dialing.

Website

You can use this feature to view the AT&T website address for product support or accessory purchasing.

1. Press the **MENU** softkey on the handset in idle mode to enter the main menu.
2. Use **CID**▼ or **▲DIR** to scroll to **WEBSITE**, then press the **SELECT** softkey. The handset screen shows the AT&T website address.
3. Press the **OK** softkey to exit.

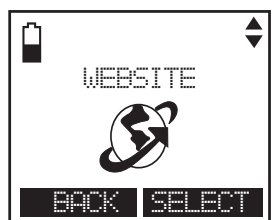

Home area code

If you dial seven digits to make a local call (area code not required), enter your area code into the telephone as the home area code. When you receive a call from within your home area code, the caller ID history only displays the seven digits of the telephone number.

This feature makes it easy for you to place a call from the caller ID log. If you dial 10 digits to make a local phone call, do not use this home area code feature. If you do, you cannot place local calls from your caller ID log, as they will have only seven digits.

To set the home area code:

1. Press the **MENU** softkey on the handset in idle mode to enter the main menu.
2. Press **CID**▼ or **▲DIR** to highlight **DIRECTORY**, then press the **SELECT** softkey.
3. Press the **SELECT** softkey to choose **Home**.
4. Press **CID**▼ or **▲DIR** to highlight **Home area code**, then press the **SELECT** softkey.
5. Use the dialing keys to enter the desired home area code.
 - Press **OFF/CLEAR** to erase a digit.
 - Press **CID**▼ to move the cursor to the left or **▲DIR** to the right.
6. Press the **SET** softkey to confirm. You hear a confirmation tone.

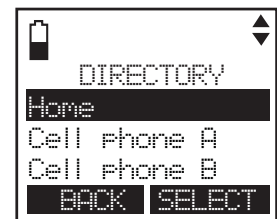

iNOTE: If, in the future, your telephone service provider requires you to dial 10 digits to make a local call (area code + telephone number), or, if you move to a location that requires it, delete your home and cell area codes you have already programmed following the steps above. After you have deleted the home and cell area codes, _ _ _ appears in the display.

Cell area code

Most cell phone entries are stored in a 10-digit format. If all of your cell phone entries are stored this way, you do not need to program your cell area code.

If your cell phone stores entries in a 7-digit format, we recommend that you program your cell area code so that your 7-digit directory entries can be dialed correctly using your home line.

To set the cell area code:

1. Press the **MENU** softkey on the handset in idle mode to enter the main menu.
2. Press **CID**▼ or **▲DIR** to highlight **Directory**, then press the **SELECT** softkey.
3. Press **CID**▼ or **▲DIR** to highlight a desired downloaded directory, then press the **SELECT** softkey.
4. Press **CID**▼ or **▲DIR** to highlight **Cell area code**, then press the **SELECT** softkey.
5. Use the dialing keys to enter the desired cell area code.
 - Press **OFF/CLEAR** to erase a digit.
 - Press **CID**▼ to move the cursor to the left or **▲DIR** to the right.
6. Press the **SET** softkey to confirm. You hear a confirmation tone.

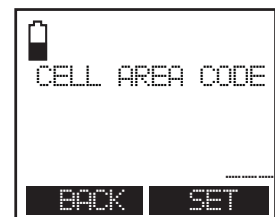
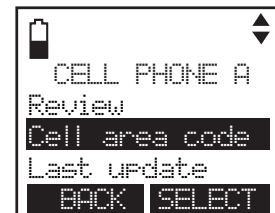

iNOTE: If, in the future, your telephone service provider requires you to dial 10 digits to make a local call (area code + telephone number), or, if you move to a location that requires it, delete your home and cell area codes you have already programmed following the steps above. After you have deleted the home and cell area codes, ___ appears in the display.

Ringer volume

You can select the ringer volume for the incoming home and cell calls.

To adjust the telephone base ringer volume:

1. Press the **MENU** softkey on the telephone base in idle mode to enter the main menu.
2. Press **▼CID** or **▲DIR** to highlight **Ringers**, then press the **SELECT** softkey.
3. Press the **SELECT** softkey to choose **Ringer volume**.
4. Press **▼CID** or **▲DIR** to select **All lines**, **Line 1**, **Line 2**, **Cell A** or **Cell B**, then press the **SELECT** softkey to confirm.
5. Press **▼CID** or **▲DIR** to adjust the ringer volume. A sample of each ringer volume plays as you scroll through the choices.
6. Press the **SET** softkey to confirm. You hear a confirmation tone.

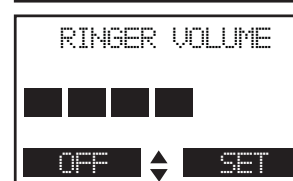
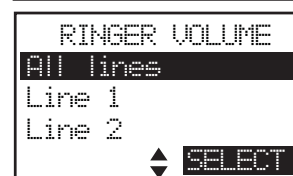

You can also set the ringer volume while the telephone base is in idle mode. The setting will apply to all lines.

1. Press **▼ VOLUME ▲** to adjust the ringer volume and listen to then selected volume
2. Press the **SET** softkey to confirm and you hear a confirmation tone.

-OR-

Press the **OFF** softkey to silence the ringer volume.



iNOTES:

1. Changing the telephone base ringer volume does not affect handset ringer volume. For more information on base ringer volume, see page 75.
2. When the ringer volume of **Line 1** or **Line 2** is set to off, the handset displays **Ringer off** for the corresponding home line. When the ringer volume of **Cell A** or **Cell B** is set to off, the handset displays **Ringer A off** or **Ringer B off** respectively. When the ringer volume of all cell calls is set to off, the handset displays **Ringers off**.

Telephone base settings

Ringer tone

You can select the ringer tones for the incoming **Line 1**, **Line 2** and cell calls.

To select a ringer tone:

1. Press the **MENU** softkey on the telephone base in idle mode to enter the main menu.
2. Press **▼CID** or **▲DIR** to highlight **Ringers**, then press the **SELECT** softkey.
3. Press **▼CID** or **▲DIR** to highlight **Ringer tone**, then press the **SELECT** softkey.
4. Press **▼CID** or **▲DIR** to select **All lines**, **Line 1**, **Line 2**, **Cell A** or **Cell B**, then press the **SELECT** softkey to confirm.
5. Press **▼CID** or **▲DIR** to select a ringer tone. A sample of each ringer tone plays as you scroll through the choices.
6. Press the **SET** softkey to confirm. You hear a confirmation tone.

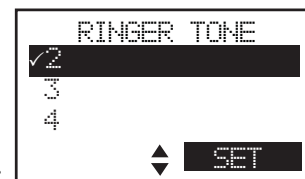
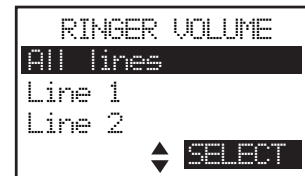

i **NOTE:** If you turn off the ringer volume, you do not hear ringer tone samples.

LCD language

You can select **English**, **Français** or **Español** to be used in all screen displays.

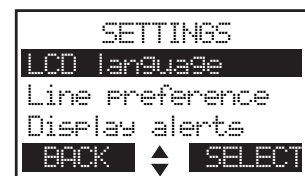

To select a language:

1. Press the **MENU** softkey on the telephone base in idle mode to enter the main menu.
2. Press **▼CID** or **▲DIR** to highlight **Settings**, then press the **SELECT** softkey.
3. Press the **SELECT** softkey to choose **LCD language**.
4. Press **▼CID** or **▲DIR** to choose from **English**, **Français** or **Español**, then press the **SET** softkey. You hear a confirmation tone.



Telephone base settings

Clear voicemail

If you subscribe to voicemail service offered by your telephone service provider, **L1>voicemail** or **L2>voicemail** and **1**  or  **2** appear on the telephone base when you have new voicemail messages. Contact your telephone service provider for more information and assistance about using your voicemail service. This feature only works on the voicemail associated with **Line 1** or **Line 2**, not the cell line.

After you have listened to all new voicemail messages, the indicators on the handset and telephone base turn off automatically.

Use the clear voicemail feature when the telephone indicates that there is new voicemail but there is none (for example, when you have accessed your voicemail while away from home). Clearing the voicemail waiting indicator only turns off the indicators; it does not delete your voicemail messages. As long as you have new voicemail messages, your telephone service provider continues to send the signal that turns on the indicators.

To manually turn off the new voicemail indicator:

1. Press the **MENU** softkey on the telephone base in idle mode to enter the main menu.
2. Use **▼CID** or **▲DIR** to scroll to **Settings**, then press the **SELECT** softkey.
3. Use **▼CID** or **▲DIR** to scroll to **Display alerts**, then press the **SELECT** softkey.
4. Use **▼CID** or **▲DIR** to choose from **Line 1**, **Line 2** or **Cell**, then press the **SELECT** softkey.
5. Use **▼CID** or **▲DIR** to scroll to **Voicemail**, then press the **SELECT** softkey.
6. The screen shows **Reset voicemail indication?** Press the **YES** softkey to turn the voicemail indication off. You hear a confirmation tone.

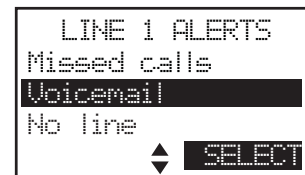
**i** **NOTES:**

1. Your telephone service provider might alert you to new voicemail messages with a stutter (broken) dial tone. Contact your telephone service provider for more details.
2. For more information about the difference between your answering system and voicemail, see page 105.

Telephone base settings

Key tone

The handset is set to beep with each key press. If you turn off the key tone, there are no beeps when you press keys.

To change the setting:

1. Press the **MENU** softkey on the telephone base in idle mode to enter the main menu.
2. Use **▼CID** or **▲DIR** to scroll to **Settings**, then press the **SELECT** softkey.
3. Press **▼CID** or **▲DIR** to scroll to **Key tone**, then press the **SELECT** softkey.
4. Press **▼CID** or **▲DIR** to select **On** or **Off**, then press the **SET** softkey. You hear a confirmation tone.

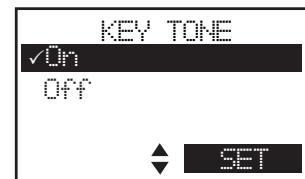
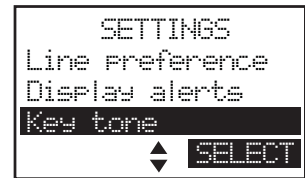

Telephone base settings

Set date/time

The answering system announces the day and time of each message prior to playing it. If the **CID time sync** is set to **On**, the day, month and time are set automatically with each incoming call. Before using the answering system, set the date and time as follows.

To set the date and time:

1. Press the **MENU** softkey on the telephone base in idle mode to enter the main menu.
2. Press **▼CID** or **▲DIR** to highlight **Settings**, then press the **SELECT** softkey.
3. Press **▼CID** or **▲DIR** to highlight **Set date/time**, then press the **SELECT** softkey.
4. Press the **SELECT** softkey to select **Date/time**.
5. Press **▼CID** or **▲DIR** to select the month and then press the **SET** softkey to confirm, or enter the correct number using the dial pad.
6. Press **▼CID** or **▲DIR** to select the day and then press the **SET** softkey to confirm, or enter the correct number using the dial pad.
7. Press **▼CID** or **▲DIR** to select the year or enter the correct number using the dial pad then press the **SET** softkey.
8. Press **▼CID** or **▲DIR** to select the hour and then press the **SET** softkey to confirm, or enter the correct number using the dial pad.
9. Press **▼CID** or **▲DIR** to select the minute and then press the **SET** softkey to confirm, or enter the correct number using the dial pad.
10. Press **CID▼** or **▲DIR** to choose **AM** or **PM**, then press the **SET** softkey to confirm. You hear a confirmation tone.

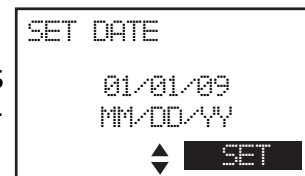

i NOTE: If the clock is not set when a message is recorded, the system announces, "Time and day not set" before the message is played.

Telephone base settings

Use caller ID to automatically set date and time

You can choose to have the date and time automatically set by incoming caller ID.

1. Press the **MENU** softkey on the telephone base in idle mode to enter the main menu.
2. Press **▼CID** or **▲DIR** to highlight **Settings**, then press the **SELECT** softkey.
3. Press **▼CID** or **▲DIR** to highlight **Set date/time**, then press the **SELECT** softkey.
4. Press **▼CID** or **▲DIR** to select **CID time sync**, then press the **SELECT** softkey.
5. Press **▼CID** or **▲DIR** to select **On** or **Off**, then press the **SET** softkey to confirm. You hear a confirmation tone.

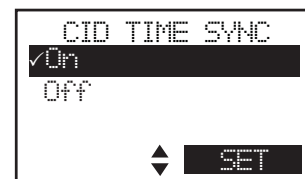

Dial mode

The dial mode is preset to tone dialing. If you have pulse (rotary) service, you must change the dial mode to pulse dialing before using the telephone.

To change the setting:

1. Press the **MENU** softkey on the telephone base in idle mode to enter the main menu.
2. Press **▼CID** or **▲DIR** to highlight **Settings**, then press the **SELECT** softkey.
3. Press **▼CID** or **▲DIR** to highlight **Dial mode**, then press the **SELECT** softkey.
4. Press **▼CID** or **▲DIR** to choose **Tone** or **Pulse**, then press the **SET** softkey to confirm. You hear a confirmation tone.

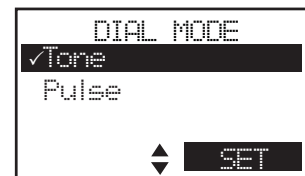
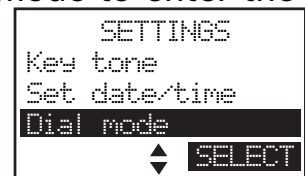

NOTE: When in **Pulse** mode, you can press * to temporarily change to touch tone dialing.

Website

You can use this feature to view the AT&T website address for product support or accessory purchasing.

1. Press the **MENU** softkey on the handset in idle mode to enter the main menu.
2. Use **▼CID** or **▲DIR** to scroll to **Website**, then press the **SELECT** softkey. The handset screen shows the AT&T website address.
3. Press the **OK** softkey to exit.



Telephone base settings

Home area code

If you dial seven digits to make a local call (area code not required), enter your area code into the telephone as the home area code. When you receive a call from within your home area code, the caller ID history only displays the seven digits of the telephone number.

This feature makes it easy for you to place a call from the caller ID log. If you dial 10 digits to make a local phone call, do not use this home area code feature. If you do, you cannot place local calls from your caller ID log, as they will have only seven digits.

To set the home area code:

1. Press the **MENU** softkey on the telephone base in idle mode to enter the main menu.
2. Press **▼CID** or **▲DIR** to highlight **Directory**, then press the **SELECT** softkey.
3. Press the **SELECT** softkey to choose **Home**.
4. Press **▼CID** or **▲DIR** to highlight **Home area code**, then press the **SELECT** softkey.
5. Use the dialing keys to enter the desired home area code.
 - Press **CANCEL** softkey to erase a digit.
 - Press **▼CID** to move the cursor to the left or **▲DIR** to the right.
6. Press the **SET** softkey to confirm. You hear a confirmation tone.



i NOTE: If, in the future, your telephone service provider requires you to dial 10 digits to make a local call (area code + telephone number), or, if you move to a location that requires it, delete your home area code you have already programmed following the step above. After you have delete the home area code, _ _ _ appears in the display.

Telephone base settings

Cell area code

Most cell phone entries are stored in a 10-digit format. If all of your cell phone entries are stored this way, you do not need to program your cell area code.

If your cell phone stores entries in a 7-digit format, we recommend that you program your cell area code so that your 7-digit directory entries can be dialed correctly using your home line.

To set the cell area code:

1. Press the **MENU** softkey on the handset in idle mode to enter the main menu.
2. Press **CID**▼ or **▲DIR** to highlight **Directory**, then press the **SELECT** softkey.
3. Press **CID**▼ or **▲DIR** to highlight a desired downloaded directory, then press the **SELECT** softkey.
4. Press **CID**▼ or **▲DIR** to highlight **Cell area code**, then press the **SELECT** softkey.
5. Use the dialing keys to enter the desired cell area code.
 - Press **CANCEL** to erase a digit.
 - Press **CID**▼ to move the cursor to the left or **▲DIR** to the right.
6. Press the **SET** softkey to confirm. You hear a confirmation tone.

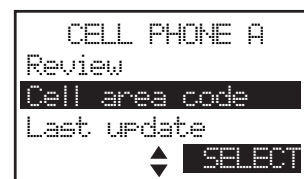

iNOTE: If, in the future, your telephone service provider requires you to dial 10 digits to make a local call (area code + telephone number), or, if you move to a location that requires it, delete your home area code you have already programmed following the step above. After you have delete the home area code, _ _ _ appears in the display.

Answering system settings

Announcement

An announcement is the greeting callers hear when calls are answered by the answering system.

The telephone is preset with a greeting that answers calls with *"Hello, please leave a message after the tone."* You can use this preset announcement, or replace it with your own.

Line 1 and **Line 2** each have two separate announcements, **Annc A** and **Annc B** stored in the answering system which can be scheduled by time. The default settings for **Annc A** is 9:00 AM and **Annc B** is 6:00 PM.

Use the telephone base to set the announcement mode:

1. Press the **MENU** softkey on the telephone base in idle mode to enter the main menu.
2. Press **▼CID** or **▲DIR** to scroll to **Answering sys**, then press the **SELECT** softkey.
3. Press **▼CID** or **▲DIR** to choose **Mailbox 1** or **Mailbox 2**, then press the **SELECT** softkey.
4. Press the **SELECT** softkey again to choose **Announcement**.
5. Press **▼CID** or **▲DIR** to highlight **Annc mode** and then press the **SELECT** softkey.
6. Press **▼CID** or **▲DIR** to scroll to **Annc A only**, **Annc B only** or **A & B schedule**, then press the **SET** softkey to confirm.

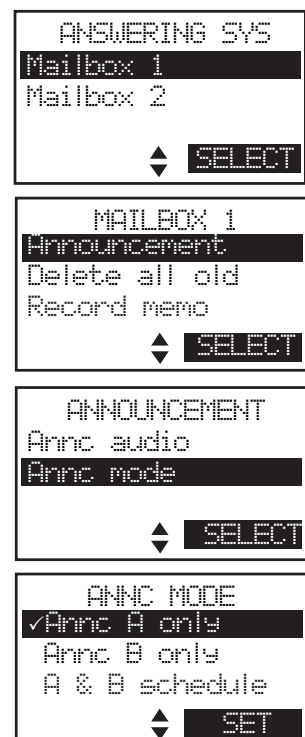

Answering system settings

Use the telephone base to set the announcement:

1. Press the **MENU** softkey on the telephone base in idle mode to enter the main menu.
2. Press **▼CID** or **▲DIR** to scroll to **Answering sys**, then press the **SELECT** softkey.
3. Press **▼CID** or **▲DIR** to choose **Mailbox 1** or **Mailbox 2**, then press the **SELECT** softkey.
4. Press the **SELECT** softkey again to choose **Announcement**.
5. Press **▼CID** or **▲DIR** to highlight **Annc mode** and then press the **SELECT** softkey.
6. Press **▼CID** or **▲DIR** to scroll to **A & B schedule**, then press the **TIMES** softkey.
7. The handset displays **ANNC A BEGINS**. Press **CID▼** or **▲DIR** or the dial keypad to set the time for **Annc A**. Press the **NEXT** softkey to confirm.
8. The handset displays **ANNC B BEGINS**. Press **CID▼** or **▲DIR** or the dial keypad to set the time for **Annc B**. Press the **SET** softkey to confirm.

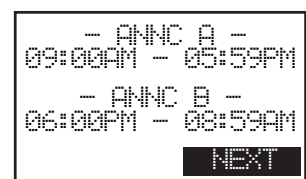
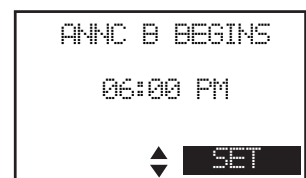
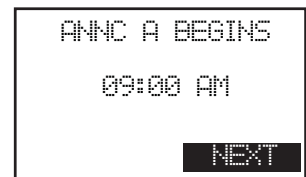
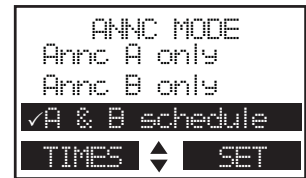

NOTES:

1. If the clock is not set, the handset or telephone base displays **To use A & B schedule, system clock must be set**. Set the time and date (pages 34 and 42) before you set the announcement mode.
2. If the answering system is off when you attempts to record an outgoing announcement, the system will automatically turns on. If the memory is full, the answering system announces, *"Memory is full. Calls will not be answered."*

Answering system settings

Use the telephone base to play your announcement:

1. Press the **MENU** softkey on the telephone base in idle mode to enter the main menu.
2. Press **▼CID** or **▲DIR** to scroll to **Answering sys**, then press the **SELECT** softkey.
3. Press **▼CID** or **▲DIR** to choose **Mailbox 1** or **Mailbox 2**, then press the **SELECT** softkey.
4. Press the **SELECT** softkey again to choose **Annc audio**.
5. Press **▼CID** or **▲DIR** to choose from **Annc A** or **Annc B**, then press the **PLAY** softkey.
6. When the handset plays the announcement, you may press the **STOP** softkey to stop the announcement playback or **DELETE** to delete the recorded announcement.



Use the telephone base to record your own announcement:

1. Press the **MENU** softkey on the telephone base in idle mode to enter the main menu.
2. Press **▼CID** or **▲DIR** to scroll to **Answering sys**, then press the **SELECT** softkey.
3. Press **▼CID** or **▲DIR** to choose **Mailbox 1** or **Mailbox 2**, then press the **SELECT** softkey.
4. Press the **SELECT** softkey again to choose **Annc audio**.
5. Press **▼CID** or **▲DIR** to choose from **Annc A** or **Annc B**, then press the **RECORD** softkey.
6. The handset announces, "Record after the tone. Press Stop when you are done." After the tone, speak towards the microphone of the telephone base.
7. Press the **STOP** softkey when you finish recording.

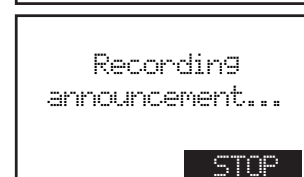
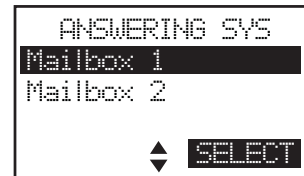

iNOTES:

1. Your announcement can be up to 90 seconds in length.
2. Announcements shorter than two seconds are not recorded.

Answering system settings

You may also use the telephone base to record an announcement while in idle mode.

1. Press **REC** on the telephone base in idle mode.
2. Press **▼CID** or **▲DIR** to highlight Announcement and then press the **SELECT** softkey.
3. Press **▼CID** or **▲DIR** to highlight **Mailbox 1** or **Mailbox 2**, then press the **SELECT** softkey.
4. If the announcement mode is set to **Annc A only**, the telephone base displays **Current mode is Annc A only. Please select audio to record**. Press the **Annc A** softkey or the **Annc B** softkey to record an announcement.

-or-

If the announcement mode is set to **Annc B only**, the telephone base displays **Current mode is Annc B only. Please select audio to record**. Press the **Annc A** softkey or the **Annc B** softkey to record an announcement.

-or-

If the announcement mode is set to **A & B schedule**, the telephone base displays **Current mode is A & B schedule. Please select audio to record**. Press the **Annc A** softkey or the **Annc B** softkey to record an announcement.

4. The telephone base announces, "Record after the tone. Press Stop when you are done." After the tone, speak towards the microphone of the telephone base. Press the **STOP** softkey when you finish recording.
5. After finishing recording, the telephone base plays the recorded announcement and announces "**Announcement playback**". Press the **STOP** softkey to stop the playback or press the **RETRY** softkey to record the announcement again.

iNOTES:

1. Your announcement can be up to 90 seconds in length.
2. Announcements shorter than two seconds are not recorded.
3. If announcement you select does not match with the current announcement mode, the telephone base displays **Selected audio does not match current mode. Proceed?** Press the **YES** softkey to continue.



Answering system settings

Recording time

You can set the recording time for each incoming message.

Using a handset:

1. Press the **MENU** softkey on the handset in idle mode to enter the main menu.
2. Press **CID**▼ or **▲DIR** to scroll to **ANSWERING SYS**, then press the **SELECT** softkey.
3. Press **CID**▼ or **▲DIR** to choose **Mailbox 1** or **Mailbox 2**, then press the **SELECT** softkey.
4. Press **CID**▼ or **▲DIR** to scroll to **Ans sys setup**, then press the **SELECT** softkey.
5. Press **CID**▼ or **▲DIR** to scroll to **Recording time**, then press the **SELECT** softkey.
6. Press **CID**▼ or **▲DIR** to choose from **3 minutes**, **2 minutes** or **1 minute**, then press **SET** softkey to confirm. You hear a confirmation tone.

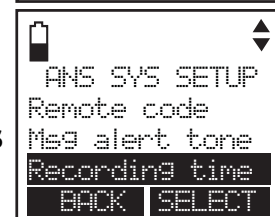
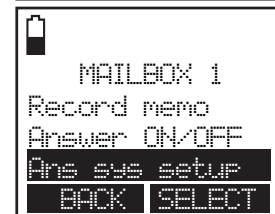
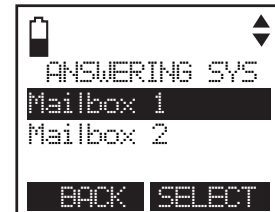

Using the telephone base:

1. Press the **MENU** softkey on the telephone base in idle mode to enter the main menu.
2. Press **▼CID** or **▲DIR** to scroll to **Answering sys**, then press the **SELECT** softkey.
3. Press **▼CID** or **▲DIR** to choose **Mailbox 1** or **Mailbox 2**, then press the **SELECT** softkey.
4. Press **▼CID** or **▲DIR** to scroll to **Ans sys setup**, then press the **SELECT** softkey.
5. Press **▼CID** or **▲DIR** to scroll to **Recording time**, then press the **SELECT** softkey.
6. Press **▼CID** or **▲DIR** to choose from **3 minutes**, **2 minutes** or **1 minute**, then press **SELECT** softkey to confirm. You hear a confirmation tone.

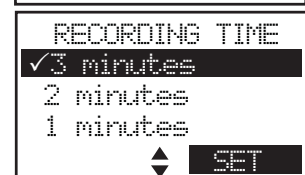
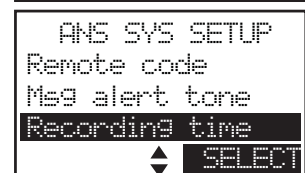
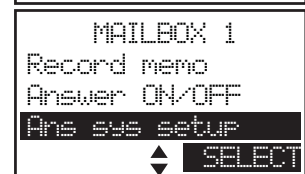
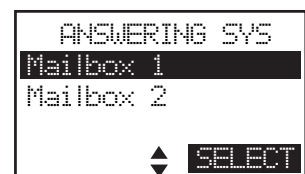

Answering system settings

Answer ON/OFF

If you turn the answering system on, it answers calls and records messages only on the home line. If your paired cell phone has voicemail, callers can leave messages with that voicemail service.

When the answering system of **Line 1** or **Line 2** is turned on, the **ON/OFF LINE 1/☎** or **ON/OFF LINE 2/☎** light on the telephone base is on respectively.

To turn the answering system on or off:

Using a handset:

1. Press the **MENU** softkey on the handset in idle mode to enter the main menu.
2. Press **CID▼** or **▲DIR** to scroll to **ANSWERING SYS**, then press the **SELECT** softkey.
3. Press **CID▼** or **▲DIR** to choose **Mailbox 1** or **Mailbox 2**, then press the **SELECT** softkey.
4. Press **CID▼** or **▲DIR** to scroll to **Answer ON/OFF**, then press the **SELECT** softkey.
5. Press **CID▼** or **▲DIR** to choose **On** or **Off**, then press the **SET** to confirm. You hear a confirmation tone.

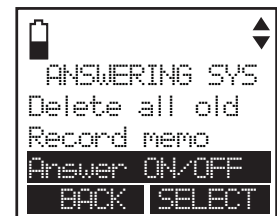
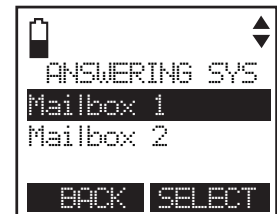

Using the telephone base:

1. Press the **MENU** softkey on the telephone base in idle mode to enter the main menu.
2. Press **▼CID** or **▲DIR** to scroll to **Answering sys**, then press the **SELECT** softkey.
3. Press **▼CID** or **▲DIR** to choose **Mailbox 1** or **Mailbox 2**, then press the **SELECT** softkey.
4. Press **▼CID** or **▲DIR** to scroll to **Answer ON/OFF**, then press the **SELECT** softkey.
5. Press **▼CID** or **▲DIR** to choose **On** or **Off**, then press the **SET** softkey to confirm. You hear a confirmation tone.

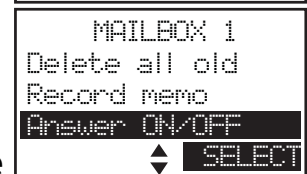

Answering system settings

You can also turn the answering system on or off according to the following steps:

1. Press **🔌/ON/OFF LINE 1** or **🔌/ON/OFF LINE 2** to turn on the corresponding answering system(s). The telephone base announces, *"Calls will be answered."* The **🔌/ON/OFF LINE 1** light and/or **🔌/ON/OFF LINE 2** light will be on respectively.
2. Press **🔌/ON/OFF LINE 1** or **🔌/ON/OFF LINE 2** to turn off the corresponding answering system(s). The telephone base announces, *"Calls will not be answered."* The **🔌/ON/OFF LINE 1** light and/or **🔌/ON/OFF LINE 2** light will be off respectively.



iNOTES:

1. If there is no remaining recording time, the answering system announces *"Memory is full"* and will be turned off.
2. If the total recording time is less than three minutes, the answering system announces *"Less than three minutes to record."* and your handsets display **Ans sys low**.
3. If the answering system is off, you may press **🔌/ON/OFF LINE 1** or **🔌/ON/OFF LINE 2** on the telephone base to turn on the corresponding answering system during an incoming call. The corresponding answering system answers the call immediately.

Answering system settings

Delete your announcement

Use the handset to delete your announcement:

1. Press the **MENU** softkey on the handset in idle mode to enter the main menu.
2. Press **CID**▼ or **▲DIR** to scroll to **ANSWERING SYS**, then press the **SELECT** softkey.
3. Press **CID**▼ or **▲DIR** to choose **Mailbox 1** or **Mailbox 2**, then press the **SELECT** softkey.
4. Press **CID**▼ or **▲DIR** to highlight **Announcement**, then press the **SELECT** softkey.
5. Press the **SELECT** softkey again to enter **Annc audio**.
6. Press **CID**▼ or **▲DIR** to choose **Annc A** or **Annc B**, then press the **PLAY** softkey.
7. Press the **DELETE** softkey while the handset plays the announcement.
8. The handset displays **Reset announcement to default?** Press **YES** softkey to confirm.

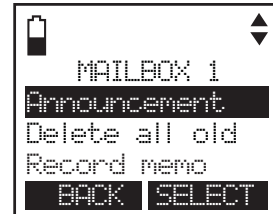
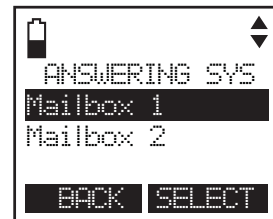

Use the telephone base to delete your announcement:

1. Press the **MENU** softkey on the telephone base in idle mode to enter the main menu.
2. Press ▼**CID** or **▲DIR** to scroll to **Answering sys**, then press the **SELECT** softkey.
3. Press ▼**CID** or **▲DIR** to choose **Mailbox 1** or **Mailbox 2**, then press the **SELECT** softkey.
4. Press ▼**CID** or **▲DIR** to highlight **Announcement**, then press the **SELECT** softkey.
5. Press the **SELECT** softkey again to enter **Annc audio**.
6. Press ▼**CID** or **▲DIR** to choose **Annc A** or **Annc B**, then press the **PLAY** softkey.
7. Press the **DELETE** softkey while the telephone base plays the announcement.
8. The handset displays **Reset announcement to default?** Press **YES** softkey to confirm.



Answering system settings

In the answering system setup menu, you can change the settings for call screening, number of rings, remote access code and message alert tone and recording time.

Call screening

The call screening feature lets you listen to a caller leaving a message at the telephone base. While monitoring an incoming message, you can answer the call by pressing **LINE 1/FLASH**, **LINE 2/FLASH** or **◀)/SPEAKER** on the handset to answer the corresponding incoming call, or pressing **LINE 1** or **LINE 2 SPEAKER▶)** on the telephone base, or using the corded handset to answer the corresponding incoming call.

To change the settings:

1. Press the **MENU** softkey on the telephone base in idle mode to enter the main menu.
2. Press **▼CID** or **▲DIR** to choose **Mailbox 1** or **Mailbox 2**, then press the **SELECT** softkey.
3. Press **▼CID** or **▲DIR** to scroll to **Ans sys setup**, then press the **SELECT** softkey twice to select **Call screening**.
4. Press **▼CID** or **▲DIR** to choose between **On** and **Off**.
5. Press the **SELECT** softkey to confirm your setting. You hear a confirmation tone.

i **NOTE:** For more information on call screening, see page 81.



Answering system settings

Number of rings

When the answering system is turned on, it answers all incoming home calls after the number of rings set. You can choose from two, four, or six rings; or toll saver. With toll saver selected, the answering system answers after two rings when you have new messages, and after four rings when you have no new messages. This enables you to check for new messages and avoid paying unnecessary long distance charges if you are calling from out of your local area.

Use the handset to set the number of rings:

1. Press the **MENU** softkey on the handset in idle mode to enter the main menu.
2. Press **CID**▼ or **▲DIR** to scroll to **ANSWERING SYS**, then press the **SELECT** softkey.
3. Press **CID**▼ or **▲DIR** to choose **Mailbox 1** or **Mailbox 2**, then press the **SELECT** softkey.
4. Press **CID**▼ or **▲DIR** to scroll to **Ans sys setup**, then press the **SELECT** softkey.
5. Press **CID**▼ or **▲DIR** to highlight **# of rings**, then press the **SELECT** softkey.
6. Press **CID**▼ or **▲DIR** to choose from **2**, **4**, **6** or **Toll saver**, then press the **SET** softkey. You hear a confirmation tone.

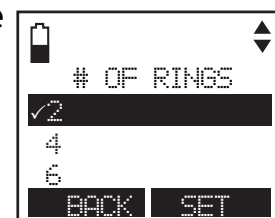
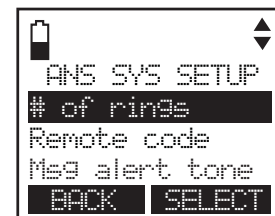
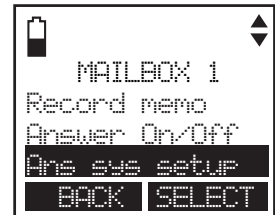
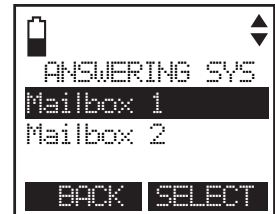

Use the telephone base to set the number of rings:

1. Press the **MENU** softkey on the telephone base in idle mode to enter the main menu.
2. Press **▼CID** or **▲DIR** to scroll to **Answering sys**, then press the **SELECT** softkey.
3. Press **▼CID** or **▲DIR** to choose **Mailbox 1** or **Mailbox 2**, then press the **SELECT** softkey.
4. Press **▼CID** or **▲DIR** to scroll to **Ans sys setup**, then press the **SELECT** softkey.
5. Press **▼CID** or **▲DIR** to scroll to **# of rings**, then press the **SELECT** softkey.
6. Press **▼CID** or **▲DIR** to choose from **2**, **4**, **6** or **Toll saver**, then press the **SET** softkey. You hear a confirmation tone.

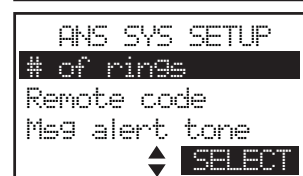
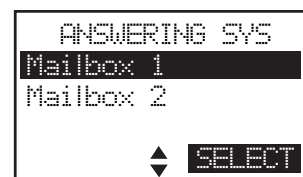

Answering system settings

Remote access code

A two-digit security code is required to access the answering system remotely from any touch-tone telephone. The preset code is **19**. You can change the code to any number from **00** to **99**.

Use a handset to change the remote code:

1. Press the **MENU** softkey on the handset in idle mode to enter the main menu.
2. Press **CID**▼ or **▲DIR** to scroll to **ANSWERING SYS**, then press the **SELECT** softkey.
3. Press **CID**▼ or **▲DIR** to scroll to **Ans sys setup**, then press the **SELECT** softkey.
4. Press **CID**▼ or **▲DIR** to scroll to **Remote code**, then press the **SELECT** softkey.
5. Use the dialing keys (**0-9**) to enter a two-digit number from **00-99**, then press the **SET** softkey to confirm.
 - Press **OFF/CLEAR** to erase a digit.
 - Press **CID**▼ to move the cursor to the left or **▲DIR** to the right.

Use the telephone base to change the remote code:

1. Press the **MENU** softkey on the handset in idle mode to enter the main menu.
2. Press **CID**▼ or **▲DIR** to scroll to **Answering sys**, then press the **SELECT** softkey.
3. Use **CID**▼ or **▲DIR** to scroll to **Ans sys setup**, then press **MENU/SELECT**.
4. Press **CID**▼ or **▲DIR** to scroll to **Remote code**, then press the **SELECT** softkey.
5. Use the dialing keys (**0-9**) to enter a two-digit number from **00-99**, then press the **SET** softkey to confirm.
 - Press **CANCEL** to erase a digit.
 - Press **CID**▼ to move the cursor to the left or **▲DIR** to the right.

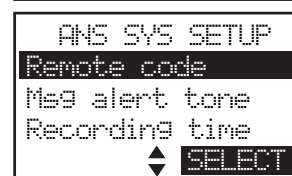
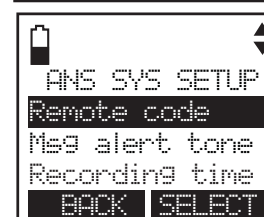
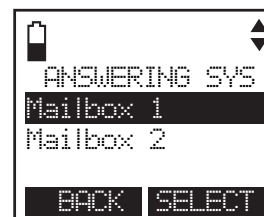

Answering system settings

Message alert tone

When the message alert tone is set to **On**, the telephone base beeps every 10 seconds to alert you of new messages. The tone stops when all new messages have been reviewed. The default message alert setting is off.

Use the handset to set the remote access code:

1. Press the **MENU** softkey on the handset in idle mode to enter the main menu.
2. Press **CID**▼ or **▲DIR** to scroll to **ANSWERING SYS**, then press the **SELECT** softkey.
1. Press **CID**▼ or **▲DIR** to choose **Mailbox 1** or **Mailbox 2**, then press the **SELECT** softkey.
1. Use **CID**▼ or **▲DIR** to scroll to **Ans sys setup**, then press the **SELECT** softkey.
2. Press **CID**▼ or **▲DIR** to scroll to **Msg alert tone**, then press the **SELECT** softkey.
3. Press **CID**▼ or **▲DIR** to choose between **On** and **Off**.
4. Press the **SET** softkey to confirm your setting. You hear a confirmation tone.

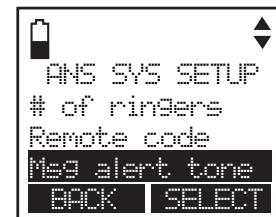
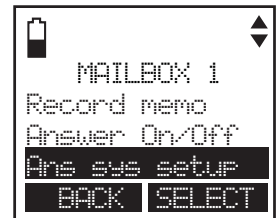
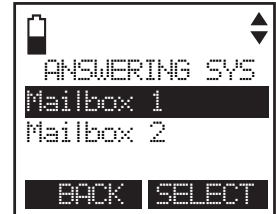

Use the telephone base to set the remote access code:

1. Press the **MENU** softkey on the telephone base in idle mode to enter the main menu.
2. Press ▼**CID** or **▲DIR** to scroll to **Answering sys**, then press the **SELECT** softkey.
3. Press ▼**CID** or **▲DIR** to choose **Mailbox 1** or **Mailbox 2**, then press the **SELECT** softkey.
4. Press ▼**CID** or **▲DIR** to scroll to **Ans sys setup**, then press the **SELECT** softkey.
5. Press ▼**CID** or **▲DIR** to scroll to **Msg alert tone**, then press the **SELECT** softkey.
6. Press ▼**CID** or **▲DIR** to choose between **On** and **Off**.
7. Press the **SET** softkey to confirm your setting. You hear a confirmation tone.

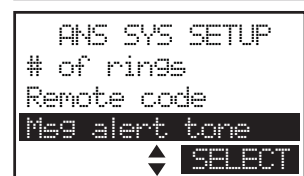
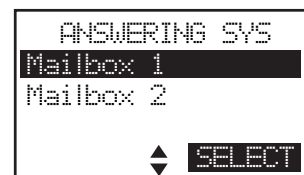

Making, answering and ending a call

Using a handset

To make a home call:

- Press **LINE 1/FLASH**, **LINE 2/FLASH** or **☎/SPEAKER**, then enter the telephone number.

To predial a home call:

- Enter the telephone number, then press **LINE 1/FLASH**, **LINE 2/FLASH** or **☎/SPEAKER**.

To answer a home call:

- Press **LINE 1/FLASH**, **LINE 2/FLASH** or **☎/SPEAKER**.

NOTES:



1. The screen shows the elapsed time as you talk (in hours, minutes and seconds).
2. When predialing (preview numbers before dialing), press **OFF/CLEAR** to backspace and delete; press and hold **PAUSE/REDIAL** to insert a dialing pause (a **p** appears).

To end a home call:

- Press **OFF/CLEAR** or return the handset to the charger to hang up.

Using the telephone base

To make a home call:

Lift the corded handset or press **LINE 1**, **LINE 2**, **HEADSET**  or **SPEAKER**  on the telephone base, then enter the telephone number.

To predial a home call:

- Enter the telephone number, then press **LINE 1**, **LINE 2**, **SPEAKER**  or lift the corded handset.

To answer a home call:

- Lift the corded handset or press **LINE 1**, **LINE 2** or **SPEAKER** .

NOTES:

1. The screen shows the elapsed time as you talk (in hours, minutes and seconds).
2. When predialing (preview numbers before dialing), press **CANCEL** to backspace and delete; press the **PAUSE** softkey to insert a dialing pause (a **p** appears).

To end a home call:

- Return the corded handset to the telephone base or press **LINE 1** or **LINE 2** for the corresponding line or press **SPEAKER**  if you are using speakerphone. If you are using the corded handset, return it to the telephone base. If you are using the speakerphone, press the corresponding **Line 1** or **Line 2** key to end the call.

Making, answering and ending a call

Using a Bluetooth headset for home calls

You can use a Bluetooth headset on home calls. However, you need to keep the device within 15 feet of the telephone base for optimal performance. Please see the user's manual of your Bluetooth headset for more information.

To answer a home call using a Bluetooth headset:

- Press the call key on your headset.

To end a home call you answered from a Bluetooth headset:

- Press the call key on your headset.

If you make or answer a home call on a handset, you can transfer the call to your headset. The handset remains active, but the handset earpiece and microphone are muted. If you hang up the handset, the call ends.

To transfer a call from a handset to a Bluetooth headset:

- Press the **OPTION** softkey. Press the **SELECT** softkey to choose **Use headset**.

If you have two headsets, press **CID**▼ or **▲DIR** to select a headset, then press the **SELECT** softkey. The handset shows **Transferring audio to Headset X**. To cancel the call transfer, press **OFF/CLEAR** on your handset.

To transfer a call from the Bluetooth headset back to the handset:

- Press the **OPTION** softkey. Press the **SELECT** softkey to choose **Use handset**.

To end a call that started at the handset:

- Press **OFF/CLEAR** or put the handset in the charger.

NOTES:

1. If you answer a call using a headset, and you lose the Bluetooth connection or the battery is depleted, the call is lost.
2. If you are using a headset for a call which is transferred from a **TL86109** handset, and you lose the Bluetooth connection or the battery of the headset is depleted, the call is transferred back to the originating handset.
3. **Use headset** only shows if a headset is paired (see pages 17-18).
4. If the transfer fails, the handset screen shows **Unable to call. Headset in use**.
5. If the headset is not connected, the handset screen shows **Bluetooth headset not connected**. Press the **CONNECT** softkey to connect your headset to the telephone system. If the connection still fails, the handset shows **Connection fail**. Refer to the **Pair a headset** section on pages 17-18.

Making, answering and ending a call

Call waiting on the home line

If you subscribe to call waiting service with your telephone service provider, you hear a beep if someone calls while you are already on a call.

- Press **LINE 1/FLASH** or **LINE 2/FLASH** on the handset or **FLASH** on the telephone base to put your current call on hold and take the new call.
- Press **LINE 1/FLASH** or **LINE 2/FLASH** on the handset or **FLASH** on the telephone base on the handset at any time to switch back and forth between calls.

Make, answer or end a cell call

You can connect a maximum of two Bluetooth enabled cell phones to the telephone base, but only one cell phone can be used on a cell call at a time. The **TL86109** handset can be used to make or answer calls on the cell phone line.

Using a handset:

To make a cell call

1. Press  **CELL**, then enter the telephone number
2. Press the **DIAL** softkey.

To predial a cell call

- Enter the telephone number, then press  **CELL**.

If you have only one cell phone connected to the telephone base, it is automatically selected to make cell calls. If you have two cell phones connected to the telephone base, the telephone system prompts you to select a cell phone before you make a cell call.

To answer a cell call

- Press  **CELL**.

NOTES:

1. You can also use your cell phone to answer the call. If you answer with your cell phone, it disconnects from the telephone base.
2. If you do not want to answer the call, press the **REJECT** softkey.

To end a cell call

- Press  **OFF/CLEAR** or put the handset in the charger.

Making, answering and ending a call

Using the telephone base:

To make a cell call

1. Press **CELLULAR** , then enter the telephone number
2. Press the **DIAL** softkey.

To predial a cell call

- Enter the telephone number, then press **CELLULAR** .

If you have only one cell phone connected to the telephone base, it is automatically selected to make cell calls. If you have two cell phones connected to the telephone base, the telephone system prompts you to select a cell phone before you make a cell call.



To answer a cell call:

- Press **CELLULAR** .

NOTES:

1. You can also use your cell phone to answer the call. If you answer with your cell phone, it disconnects from the telephone base.
2. If you do not want to answer the call, press the **REJECT** softkey.

To end a cell call:

- Press **CELLULAR** , **SPEAKER** , or return the corded handset in the telephone base.

Call waiting on the cell line

If you subscribe to call waiting service with your cell phone service provider, you hear a beep if someone calls while you are already on a call.

- Press the **OPTION** softkey and then the **SWAP** softkey on the handset or telephone base.
- Press the **OPTION** softkey and then the **SWAP** softkey to switch back and forth between calls.

Making, answering and ending a call

Answer a cell call while on a home call

If you are on a home call and you receive an incoming cell call, you hear a beep and **(P) 1** or **(P) 2** displays on the handset and telephone base. The telephone base and handset ring.

To answer the incoming cell call:

- Press **(P)CELL** on the handset or **CELLULAR (P)** on the telephone base. The home call is automatically placed on hold and the telephone base and handset display **L1>On hold** or **L2>On hold** and **CL>in use**.

To end the cell call:

- Press **OFF/CLEAR** on the handset or **CELLULAR (P)** on the telephone base. The home line is still on hold. The telephone base and handset display **L1>On hold** or **L2>On hold**.

To resume the home call on hold:

- Press **LINE 1** or **LINE 2** on the handset or **LINE 1** or **LINE 2** on the telephone base for the corresponding incoming call.

i NOTE: If you have voicemail service active on your cell phone, and you do not answer the incoming cell call, the call is answered by your cell phone's voicemail. Contact your cell phone service provider for more information about voicemail service.

Answer a home call while on a cell call

If you are on a cell call and you receive an incoming home call, you hear a beep and **LINE 1 incoming call** or **LINE 2 incoming call** displays on the handset and telephone base you are using. The telephone base and handset ring.

To answer the incoming home call:

- Press **LINE 1** or **LINE 2** on the handset for the corresponding incoming call. The cell call is automatically placed on hold and all other handsets display **CL>On hold** and **L1>In use** or **L2>In use**.

To end the home call:

- Press **OFF/CLEAR** on the handset or **LINE 1** or **LINE 2** on the telephone base. The cell line is still on hold. The telephone base and handset display **CL>On hold**.

To resume the cell call on hold:

- Press **(P)CELL** on the handset or **CELLULAR (P)** on the telephone base.

i NOTE: If you have turned on your answering system and you do not answer the incoming home call, the call is answered by your answering system.

Conference calls

Share an outside call

Another system handset or telephone base can join an outside call. That call continues until all system handset(s) and telephone base hang up.

During a call on line 1, press **LINE 1/FLASH** on the handset; or **LINE 1** on the telephone base to join the call.

During a call on line 2, press **LINE 2/FLASH** on the handset; or **LINE 2** on the telephone base to join the call.

Conference line 1 and line 2 calls

While you are on a call on line 1, and line 2 is on hold or in use, you can conference line 1 and line 2 using a handset or telephone base.

To conference both line 1 and line 2 calls:

1. Press the **OPTION** softkey on the handset or telephone base.
2. Press **CID▼** or **▲DIR** on the handset or **▼CID** or **▲DIR** on the telephone base to select **Conference**.
3. Press the **SELECT** softkey. The conferencing handsets or telephone base show **Lines 1 and 2 in conference**.

To select an option while on a conference call:

1. Press the **OPTION** softkey on the handset or telephone base.
2. Press **CID▼** or **▲DIR** on the handset or **▼CID** or **▲DIR** on the telephone base to select one of the following options:
 - **End Line 1** - external parties originally on line 1 ended
 - **End Line 2** - external parties originally on line 2 ended
 - **End Conference**
 - **Directory**
 - **Call log**
 - **Redial last #**
3. Press the **SELECT** softkey to confirm.

To end a conference call:

- Press **OFF/CLEAR** on the handset or put the handset back in the telephone base.

-OR-

- Press the **OPTION** softkey on the handset or telephone base. Then press **CID▼** or **▲DIR** on the handset or **▼CID** or **▲DIR** on the telephone base to select **End Conference**.

-OR-

- Press **LINE 1** and **LINE 2** on the telephone base.

Conference calls

Answer an incoming call during a conference call

If you subscribe to call waiting service with your telephone service provider, you hear a beep if someone calls on line 1 or line 2 while you are already on a conference call. If you subscribe to caller ID service with your telephone service provider, you see the incoming call information either on line 1 or line 2.

To answer the incoming call while on a conference call:

- On the handset, press **LINE 1/FLASH** or **LINE 2/FLASH** respectively.
-OR-
- On the telephone base, press **FLASH** once to access line 1 in waiting. Press **FLASH** a second time to access line 2 in waiting. Press **FLASH** a third time to return all original parties to the conference call.

NOTES:

1. When you answer the incoming call during a conference call, the new party joins in the conference call and places the line's original party on hold.
2. Contact your telephone service provider for more information about call waiting (page 60), caller ID (page 95) and voicemail service (page 105).

To end the incoming call while on a conference call:

- Press **LINE 1/FLASH** or **LINE 2/FLASH** respectively on the handset. The line's original party joins back in the conference call.
-OR-
- On the telephone base, press **FLASH** to end the incoming call. Press **FLASH** again to reconnect the line's original party to joins back in the conference call.

 **NOTE:** When you end the incoming call during a conference call, the new party exit from the conference call and the line's original party joins back the conference call.

Conference calls

Conference home and cell calls

When you have calls established on the home and cell lines, you can create a 3-way conference.

To conference both home and cell calls:

1. Press the **OPTION** softkey on the handset or telephone base.
2. Press the **SELECT** softkey on the handset or telephone base to enter **Conferencing** and it shows **Lines now in conference** on the handset or telephone base.

To select an option while on a conference call:

1. Press the **OPTION** softkey on the telephone base or handset.
2. Press **CID**▼ or **▲DIR** on the handset or **▼CID** or **▲DIR** on the telephone base to select one of the following options:
 - **End home call**
 - **End cell call**
3. Press the **SELECT** softkey.

To end a conference call:

- Press **OFF/CLEAR** on the handset or put the handset back in the charger, or return the corded handset to the telephone base.

Using the home and cell lines together:

- You can be on two different calls using the cell line and home line at the same time using two handsets.
- You cannot be on a call using the cell line and a Bluetooth headset via the home line at the same time. These are both Bluetooth devices and only one can be used at a time.
- If you are on a call using the cell line, you cannot join the call using your paired cell phone. However, you can join the call using another handset. Your cell phone is being used for the phone call so only features that are normally available during a call can be used.

Options while on calls

Speakerphone

During a call, press **◀)/SPEAKER** on the handset or **SPEAKER ▶)** on the telephone base to switch between speakerphone and normal handset or telephone base use.

Volume control

While on a call, you can adjust the listening volume on the handset or telephone base.

If this is a cell call and the volume is too loud or quiet, try changing the volume on your cell phone. On some cell phones, changing the volume on the cell phone effects your cell call volume on the **TL86109** corded and cordless handset(s).

To adjust the listening volume of the handset:

- Press **▲VOLUME▼** on the handset while on a call.

To adjust the listening volume of the telephone base:

- Press **▼VOLUME▲** on the telephone base while on a call.

 **NOTE:** The handset earpiece volume setting (1-5) and speakerphone volume setting (1-6) are independent.

Silencing the ringer

When the telephone is ringing, you can temporarily silence the ringer of the handset or telephone base without disconnecting the call. The next call rings normally at the preset volume.

To silence the handset ringer:

- Press the **SILENCE** softkey. **Ringer muted** appears.
-OR-
- Press **VOLUME▼** to turn off the ringer volume and then press the **SET** softkey, or press the **OFF** softkey. **Ringer muted** appears.
-OR-
- While pressing **VOLUME▼** to adjust the ringer volume, press the **OFF** softkey. **Ringer muted** appears.

To silence the base ringer:

- Press the **SILENCE** softkey. **Ringer muted** appears.
-OR-
- Press **▼VOLUME** to turn off the ringer volume and then press the **SET** softkey. **Ringer muted** appears.
-OR-

While pressing **▼VOLUME** to adjust the ringer volume, press the **OFF** softkey. **Ringer muted** appears.

Options while on calls

Mute

Use the mute function to turn off the microphone. You can hear the caller, but the caller does not hear you.

To mute the call on a handset or telephone base:

- Press the **MUTE** softkey to turn off the microphone. When mute is on, the handset screen shows **Microphone off** for a few seconds and the **MUTE** icon appears until you turn off the mute function.

To take a handset off mute on the handset or telephone base:

- Press the **UNMUTE** softkey and resume speaking. When mute is off, **Microphone on** appears temporarily on the handset screen.

Mute is automatically canceled when you end the call.

Temporary tone dialing

If you have pulse (rotary) service only, you can switch from pulse to touch-tone dialing temporarily during a call. This is useful if you need to send touch-tone signals to access your telephone banking or long distance services.

During a call:

1. Press **TOGGLE** on the handset or telephone base.
2. Use the dialing keys to enter the relevant number. The telephone sends touch-tone signals.
3. The telephone automatically returns to pulse dialing mode after you end the call.

Options while on calls

Hold

You can place a home or cell call on hold. You hear an alert tone if you have not taken the call off of hold after 14 minutes. You hear another alert tone 30 seconds later. At 15 minutes on hold, the call on hold automatically disconnects.

To place a home call on hold:

- Press **HOLD** on the handset or telephone base.
L1>On hold or **L2>On hold** appears on the handset and telephone base and **LINE 1/FLASH** or **LINE 2/FLASH** on the handset and **LINE 1** or **LINE 2** on the telephone base flash.

To resume a home call on hold:

- Press **LINE 1/FLASH** or **LINE 2/FLASH** on the handset or **LINE 1** or **LINE 2** on the telephone base.

To place a cell call on hold:

- Press **HOLD** on the handset or telephone base. **CL>On hold** appears on the handset and telephone base and **CELL** and **CELLULAR** flash.

To resume a cell call on hold:

- Press **CELL** on the handset or **CELLULAR** on the telephone base.

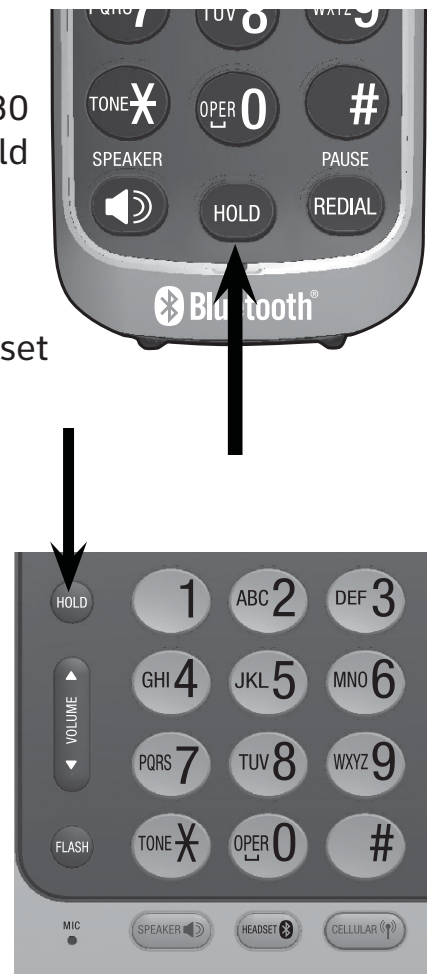

Equalizer

The equalizer feature on the handset enables you to change the quality of the handset audio to best suit your hearing.

While on a call, or listening to a message or announcement, press **EQ** to select the equalizer setting **Treble 1**, **Treble 2**, **Bass** or **Natural** (the default setting) for the handset. The current setting is shown on the handset for two seconds.

iNOTES:

1. The equalizer feature does not apply to the speakerphone on the telephone base or the connected Bluetooth headset.
2. If you switch the call between the handset and speakerphone by pressing **)/SPEAKER**, the audio setting remains unchanged.
3. The current equalizer setting remains unchanged until a new setting is selected.



Options while on calls

Chain dialing

Use this feature to initiate a dialing sequence from numbers stored in the directory, call log or redial while you are on a call.

Chain dialing can be useful if you wish to access other numbers (such as bank account numbers or access codes) from the directory, call log or redial list.

To access a number in the directory while on a call:

Use a handset:

1. Press the **OPTION** softkey.
2. Press **CID▼** or **▲DIR** to highlight **Directory**, then press the **SELECT** softkey.
3. Press **CID▼** or **▲DIR** to highlight the desired directory, then press the **SELECT** softkey.
4. Press **CID▼** or **▲DIR** to scroll to the desired entry or perform an alphabetical search (page 87).
5. Press the **SELECT** softkey to dial the displayed number.

Use the telephone base:

1. Press the **OPTION** softkey.
2. Press **▼CID** or **▲DIR** to highlight **Directory**, then press the **SELECT** softkey.
3. Press **▼CID** or **▲DIR** to highlight the desired directory, then press the **SELECT** softkey.
4. Press the **SELECT** softkey to enter **Review**.
5. Press **▼CID** or **▲DIR** to scroll to the desired entry or perform an alphabetical search (page 87).
6. Press the **DIAL** softkey to dial the displayed number.

To access a number in the call log while on a call:

Use a handset:

1. Press the **OPTION** softkey.
2. Press **CID▼** or **▲DIR** to highlight **Call log**, then press **SELECT** softkey.
3. Press **CID▼** or **▲DIR** to scroll to the desired entry.
4. Press the **DIAL** softkey to dial the displayed number.

Use the telephone base:

1. Press the **OPTION** softkey.
2. Press **▼CID** or **▲DIR** to highlight **Call log**, then press **SELECT** softkey.
3. Press **▼CID** or **▲DIR** to scroll to the desired entry.
4. Press the **DIAL** softkey to dial the displayed number.

Options while on calls

To access the redial list while on a call:

Use a handset:

1. Press **REDIAL/PAUSE**.
2. Press **▲DIR, CID▼** or **REDIAL/PAUSE** until the desired number displays, then press **MENU/SELECT**. If you do not press **MENU/SELECT** within two seconds, the number displayed is dialed automatically.

Use the telephone base:

1. Press **REDIAL/PAUSE**.
2. Press **▲DIR, ▼CID** or **REDIAL/PAUSE** until the desired number displays, then press **MENU/SELECT**. If you do not press **MENU/SELECT** within two seconds, the number displayed is dialed automatically.

NOTES:

1. You can only view the numbers in the directory, call log or redial list while on a call and cannot edit, delete or save entries.
2. Press and hold  **OFF/CLEAR**, or press **CANCEL** on the telephone base to exit redial, directory or call log while on a call.

Redial

The handset stores the 20 numbers (up to 30 digits each) in the redial list.

Review the redial list

Use a handset:

1. Press **PAUSE/REDIAL** in idle mode.
2. Press **CID**▼, **▲DIR** or **PAUSE/REDIAL** to browse the list. The handset beeps twice at the end of the list.

Press **OFF/CLEAR** to exit.

Use the telephone base:

1. Press **REDIAL** in idle mode.
2. Press **CID**▼, **▲DIR** or **REDIAL** to browse the list. The handset beeps twice at the end of the list.

Press **CANCEL** to exit.

Dial a redial entry

Use a handset:

1. Press **LINE 1/FLASH**, **LINE 2/FLASH** or **▶/SPEAKER**, then press **PAUSE/REDIAL** repeatedly to view the redial memory, press the **DIAL** softkey to dial out the number displayed.

-OR-

1. Press **PAUSE/REDIAL** in idle mode.
2. Press **CID**▼, **▲DIR** or **PAUSE/REDIAL** to browse until the desired number displays. The handset beeps twice at the end of the list.
3. Press **LINE 1/FLASH**, **LINE 2/FLASH** or **▶/SPEAKER** to use the home line.

-OR-

Press **CELL** to use the cell line.

Use the telephone base:

1. Lift the corded handset or press **LINE 1**, **LINE 2** or **SPEAKER** ▶, then press **REDIAL** repeatedly to view the redial memory, press the **DIAL** softkey to dial out the number display.

-OR-

1. Press **REDIAL** in idle mode.
2. Press ▼ **CID**, **▲DIR** or **REDIAL** to browse until the desired number displays. The handset beeps twice at the end of the list.
3. Lift the corded handset or press **LINE 1**, **LINE 2** or **SPEAKER** ▶ to use the home line.

-OR-

Press **CELLULAR** (📶) to use the cell line.



Save a redial entry to the directory

Use a handset:

1. Press **PAUSE/REDIAL** in idle mode.
2. Press **CID▼**, **▲DIR** or **PAUSE/REDIAL** to browse until the desired number displays.
3. Press the **SAVE** softkey.
4. The handset displays **ENTER NUMBER**. Use the dialing keys to edit the number, if necessary.
 - Press **OFF/CLEAR** to erase a digit.
 - Press **CID▼** to move the cursor to the left or **▲DIR** to the right.
 - Press and hold **PAUSE/REDIAL** to insert a dialing pause (a **p** appears).
5. Press the **NEXT** softkey.
6. Press **CID▼** or **▲DIR** to select one of the following types:
 - Home
 - Cell
 - Work
 - Other
7. Press the **NEXT** softkey. The handset displays **ENTER NAME**. Use the dialing keys (page 84) to enter a name.
 - Press **OFF/CLEAR** to erase a character.
 - Press **CID▼** to move the cursor to the left or **▲DIR** to the right.
8. Press the **SAVE** softkey to confirm and you hear a confirmation tone.

Redial

Use the telephone base:

1. Press **REDIAL** in idle mode.
2. Press **▼CID**, **▲DIR** or **REDIAL** to browse until the desired number displays.
3. Press the **SAVE** softkey.
4. The handset displays **ENTER NUMBER**. Use the dialing keys to edit the number, if necessary.
 - Press **CANCEL** to erase a digit.
 - Press **▼CID** to move the cursor to the left or **▲DIR** to the right.
 - Press and hold **PAUSE/REDIAL** to insert a dialing pause (a **p** appears).
5. Press the **NEXT** softkey.
6. Press **▼CID** or **▲DIR** to select one of the following types:
 - Home
 - Cell
 - Work
 - Other
7. Press the **NEXT** softkey. The handset displays **ENTER NAME**. Use the dialing keys (page 84) to enter a name.
 - Press **CANCEL** to erase a character.
 - Press **▼CID** to move the cursor to the left or **▲DIR** to the right.
8. Press the **SAVE** softkey to confirm and you hear a confirmation tone.

Delete a redial entry

Use a handset:

1. Press **PAUSE/REDIAL** when the handset is not in use.
2. Press **CID▼**, **▲DIR** or **PAUSE/REDIAL** to browse until the desired number displays.
3. Press the **OFF/CLEAR** softkey to delete the displayed number.

Use the telephone base:

1. Press **REDIAL** when the handset is not in use.
2. Press **▼CID**, **▲DIR** or **REDIAL** to browse until the desired number displays.
3. Press **CANCEL** to delete the displayed number.

Multiple handset use

Handset locator

This feature helps you find a misplaced handset.

To start paging:

1. Press the **MENU** softkey on the telephone base in idle mode.
2. **CID**▼ or **▲DIR** to highlight **Page all handsets**, then press the **SELECT** softkey. The telephone base displays **Paging all handsets** and your handset(s) screen displays ****Paging****.



To end paging:

Press the **STOP** softkey on the telephone base.

-OR-

Press **LINE 1/FLASH** or **LINE 2/FLASH**, **CELL**, **OFF/CLEAR**, **SPEAKER**, **HOLD** or **REDIAL/PAUSE** or any dialing keys (**0-9**, **#**, **TONE X**) on the handset.

NOTES:

1. If the handset ringer volume is set to off, the handset still rings when paged.
2. If there is no response after 60 seconds, paging ends.

Join a call in progress

Another handset can join you on an outside call. That call continues until all people hang up. You can share an outside call with up to four system handsets.

Use a handset:

- Press **LINE 1/FLASH** or **LINE 2/FLASH** or **SPEAKER** on another handset to join the call.
- Press **OFF/CLEAR** or place the handset in the charger to hang up. The call does not terminate until all handsets and the telephone base hang up.

Use the telephone base:

Lift the corded handset or press **LINE 1/FLASH** or **LINE 2/FLASH** or **SPEAKER** on the telephone base.

Place the corded handset in the telephone base or press **LINE 1/FLASH** or **LINE 2/FLASH** or **SPEAKER** to hang up. The call does not terminate until all handsets and the telephone base hang up.

 **NOTE:** You can use a maximum of four cordless system handsets and the telephone base at the same time on an outside call.

Intercom

Use the intercom feature for conversations between two system handsets.

You can buy additional expansion handsets (**TL86009**) for this telephone system. You can register up to 12 handsets to the telephone base.

To initiate an intercom call

Use a handset:

1. Press the **MENU** softkey on the handset in idle mode.
2. Press **CID**▼ or **▲DIR** to highlight **INTERCOM**, then press the **SELECT** softkey.
 - If you have a one-handset system, your handset displays **Calling base**. The telephone base rings and displays **HANDSET is calling**.
 - If you have more than one handset, your handset displays **INTERCOM TO:**. Press the **SELECT** softkey to choose **BASE**. Your handset displays **Calling base**. The telephone base rings and displays **HANDSET X is calling**. Press **CID**▼ or **▲DIR** to choose a destination handset then press the **SELECT** softkey. Your handset displays **Calling HANDSET X** and the destination handset rings and displays **HANDSET X is calling**. You may also press **0** for **BASE**, **1-9** for **HANDSET 1-9**, ***0** for **HANDSET 10**, ***1** for **HANDSET 11** or ***2** for **HANDSET 12**.

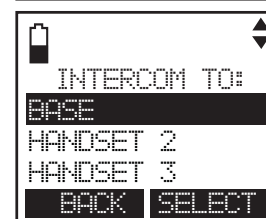
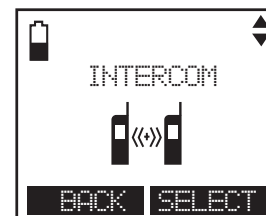

To answer an intercom at the destination handset:

- Press **LINE 1/FLASH**, **LINE 2/FLASH** or **◀)/SPEAKER**. Both screens show **Intercom**.

To answer an intercom at the telephone base:

- Press **LINE 1**, **LINE 2** or **◀)/SPEAKER**, or lift the corded handset to answer the intercom call. Both screens show **Intercom**.

To silence an intercom call:

- Press the **SILENCE** softkey on the destination handset or telephone base. Its screen displays **Ringer muted** for a few seconds.

To mute while on an intercom call:

- Press the **MUTE** softkey on the handset or telephone base. Its screen displays **Microphone off** for a few seconds.

To end an intercom call:

- Press **☎OFF/CLEAR** or place either handset back in the charger, or return the corded handset to the telephone base. Both handsets display **Intercom ended**.

Intercom

NOTES:

1. You can cancel the intercom call before it is answered by pressing  **OFF/CLEAR** on your originating handset.
2. If the destination handset does not answer the intercom call within 100 seconds, is in the directory or call log, or is out of range, the originating handset displays **Unable to call try again** and returns to idle mode.
3. You can use a maximum of five handsets at a time. For example, when four handsets are used on intercom calls, use another handset for an outside call. When two handsets are used on an intercom call, you can use three other handsets for an outside call.

Use a telephone base:

1. Press the **MENU** softkey on the handset in idle mode.

2. Press **▼CID** or **▲DIR** to highlight **Intercom**, then press the **SELECT** softkey.



- If you have a one-handset system, your handset displays **Calling HANDSET**. The telephone base rings and displays **HANDSET is calling**.

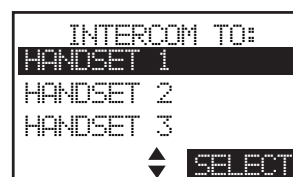

- If you have a more than one handset system, your handset displays **INTERCOM TO:**. Press **CID▼** or **▲DIR** to choose a destination handset then press the **SELECT** softkey. Your handset displays **Calling HANDSET X** and the destination handset rings and displays **HANDSET X is calling**. You may also press **1-9** for **HANDSET 1-9**, ***0** for **HANDSET 10**, ***1** for **HANDSET 11** or ***2** for **HANDSET 12**.

To answer an intercom at the destination handset:

- Press **LINE 1/FLASH**, **LINE 2/FLASH** or **◀)/SPEAKER**. Both screens show **Intercom**.

To silence an intercom call:

- Press the **SILENCE** softkey on the destination handset. Its screen displays **Ringer muted** for a few seconds.

To mute while on an intercom call:

- Press the **MUTE** softkey on the handset or telephone base. Its screen displays **Microphone off** for a few seconds.

To end an intercom call:

- Press **SPEAKER◀)** on the telephone base, or press  **OFF/CLEAR** on the destination handset, or place the handset back in the charger. Both handsets display **Intercom ended**.

Intercom

NOTES:

1. You can cancel the intercom call before it is answered by pressing **CANCEL** on your telephone base.
2. If the destination handset does not answer the intercom call within 100 seconds, is in the directory or call log, or is out of range, the originating handset displays **Unable to call try again** and returns to idle mode.
3. You can use a maximum of five handsets at a time. For example, when four handsets are used on intercom calls, use another handset for an outside call. When two handsets are used on an intercom call, you can use three other handsets for an outside call.

Answer an incoming call during an intercom call

When you receive an incoming home call during an intercom call, there is an alert tone, **LINE 1 incoming call** or **LINE 2 incoming call** appears on screens and **LINE 1/FLASH** or **LINE 2/FLASH** flashes. The telephone base and all other handsets ring.

Use a handset:

- Press **LINE 1/FLASH** or **LINE 2/FLASH** to answer the corresponding home call and the intercom call ends automatically.
- Press  **OFF/CLEAR** to end the intercom call without answering the incoming call. The telephone continues to ring.

When you receive an incoming cell call during an intercom call, there is an alert tone, **Cell incoming call** appears on screens and  **CELL** flashes. The telephone base and all other handsets ring.

- Press  **CELL** to answer the cell call and the intercom call ends automatically.

Press  **OFF/CLEAR** to end the intercom call without answering the incoming call. The telephone continues to ring.

Use the telephone base:

- Press **LINE 1** or **LINE 2**, or lift the corded handset to answer the corresponding home call and the intercom call ends automatically.
- Press  **OFF/CLEAR**, or return the corded handset to the charger to end the intercom call without answering the incoming call. The telephone continues to ring.

When you receive an incoming cell call during an intercom call, there is an alert tone, **Cell Incoming call** appears on screens and **CELLULAR**  flashes. The telephone base and all other handsets ring.

- Press **CELLULAR**  to answer the cell call and the intercom call ends automatically.
- Press **CANCEL** to end the intercom call without answering the incoming call. The telephone continues to ring.

Call transfer using intercom

Use the intercom feature to transfer an outside call to another system handset.

Use a handset:

- When on an outside call, press the **OPTION** softkey.
- Press **CID**▼ or **▲DIR** to highlight **Intercom**, then press the **SELECT** softkey.
 - If you only have one handset, the outside call is put on hold and your handset displays **Calling BASE**. The telephone base rings and displays **HANDSET is calling**.
 - If you have more than one handsets, your handset displays **INTERCOM TO:**. Press the **SELECT** softkey to choose **BASE**. Your handset displays **Calling base**. The telephone base rings and displays **HANDSET X is calling**. Press **CID**▼ or **▲DIR** to choose a destination handset and then press the **SELECT** softkey. You may also press **0** for **BASE**, **1-9** for **HANDSET 1-9**, ***0** for **HANDSET 10**, ***1** for **HANDSET 11** or ***2** for **HANDSET 12**. The outside call is put on hold and your handset screen shows **Calling HANDSET X**. The other handset rings and displays **HANDSET X is calling**.
- To answer the call on the other handset, press **LINE 1/FLASH**, **LINE 2/FLASH** or **◀)/SPEAKER**. To answer the call on the telephone base, press **LINE 1** or **LINE 2**. The outside call is still on hold and both handsets now show **Intercom**. You can now have a private conversation between the system handsets. To answer the call on the telephone base, press **LINE 1** or **LINE 2**. The outside call is still on hold and both the handset and the telephone base now show **Intercom**.

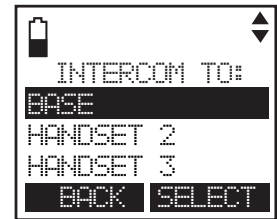
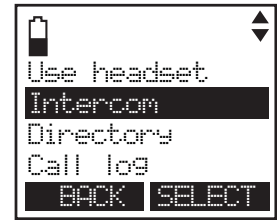

iNOTES:

- To cancel the transfer and return to the external call before the intercom call is answered, press **OFF/CLEAR** or **LINE 1/FLASH** or **LINE 2/FLASH** on your handset.
- If the destination handset or the telephone base do not answer the intercom call within 100 seconds, or if the destination handset or the telephone base is in the directory or call log mode, or is out of range, the calling handset shows **Unable to call try again** and automatically returns to the external call.

Call transfer using intercom

4. From this intercom call, you have the following options:

- You can transfer the call. Press the **OPTION** softkey and then **SELECT** softkey to choose **Transfer** on the calling handset. Your screen shows **Call transferred**. The other handset automatically connects to the outside call.
- You can let the other handset join you on the outside call in a three-way conversation. Press the **OPTION** softkey. Press **CID▼** or **▲DIR** to highlight **Call share** and then press the **SELECT** softkey. Either handset can also press **LINE 1/FLASH** or **LINE 2/FLASH** to create a three-way conversation.
- You can end the intercom call and continue the outside call on the original handset by pressing **OFF/CLEAR** on either handset or putting either handset in the charger, or by pressing **CANCEL**, **LINE 1** or **LINE 2** on the telephone base.

Use the telephone base:

1. When on an outside call, press the **OPTION** softkey.

2. Press **CID▼** or **▲DIR** to highlight **Intercom**, then press the **SELECT** softkey.



- If you only have one handset, the outside call is put on hold and your handset displays **Calling handset**. The telephone base rings and displays **BASE is calling**.
- If you have more than one handsets, your handset displays **INTERCOM TO:**. Press **CID▼** or **▲DIR** to choose a destination handset and then press the **SELECT** softkey. You may also press **1-9** for **HANDSET 1-9**, ***0** for **HANDSET 10**, ***1** for **HANDSET 11** or ***2** for **HANDSET 12**. The outside call is put on hold and your handset screen shows **Calling HANDSET X**. The other handset rings and displays **HANDSET X is calling**.



3. To answer the call on the other handset, press **LINE 1/FLASH**, **LINE 2/FLASH** or **▲)/SPEAKER**. The outside call is still on hold and both the handset and the telephone base now show **Intercom**. You can now have a private conversation between the system handsets.

NOTES:

1. To cancel the transfer and return to the external call before the intercom call is answered, press **CANCEL** or **LINE 1/FLASH** or **LINE 2/FLASH** on your telephone base.
2. If the other handset does not answer the intercom call within 100 seconds, or if the other handset is in the directory or call log mode, or is out of range, the calling handset shows **Unable to call try again** and automatically returns to the external call.

Call transfer using intercom

4. From this intercom call, you have the following options:

- You can transfer the call. Press the **OPTION** softkey and then **SELECT** softkey to choose **Transfer** on the telephone base. Your screen shows **Call transferred**. The other handset automatically connects to the outside call.
- You can let the other handset join you on the outside call in a three-way conversation. Press the **OPTION** softkey. Press **CID▼** or **▲DIR** to highlight **Call share** and then press the **SELECT** softkey. Either handset can also press **LINE 1/FLASH** or **LINE 2/FLASH** to create a three-way conversation.
- You can end the intercom call and continue the outside call on the original handset by pressing **OFF/CLEAR** on either handset or putting either handset in the charger, or by pressing **CANCEL, LINE 1** or **LINE 2** on the telephone base.

About the directory

The home directory stores up to 200 entries with up to 30 digits for each phone number and 15 characters for each name. Each of the downloaded directories stores up to 1,500 entries with up to 30 digits for each phone number and 15 characters for each name.

- Directory entries are stored at the telephone base and shared by all system handsets. Any changes made on one handset apply to all.
- Only one handset can review the directory at a time. If another handset tries to enter the directory, its screen shows **Not available at this time.**
- When there are no records in the directory, the screen shows **Directory empty.**
- When the directory is full and you try to save an entry, the screen shows **List full.**
- When you try to save a number already stored in the directory, the screen shows **Already saved.**

All of the instructions on pages 82-93 for the directories apply to the home directory and all downloaded directories. Creating a new entry on page 82 only applies to the home directory.

You cannot create new entries in your downloaded directories from the **TL86109** handset. Entries must be downloaded from your cell phone (see **Download directory** on pages 27-28).

Create a new entry in the home directory

Use a handset:

1. Press the **MENU** softkey on the handset in idle mode to enter the main menu.
2. Press **CID▼** or **▲DIR** to highlight **Directory**, then press the **MENU** softkey.
3. Press the **MENU** softkey again to select **Home**.
4. Press **CID▼** or **▲DIR** to highlight **Add contact**, then press the **MENU** softkey. The screen displays **ENTER NUMBER**.
5. Use the dialing keys to enter a telephone number.
 - Press **↵OFF/CLEAR** to erase a digit.
 - Press **CID▼** to move the cursor to the left or **▲DIR** to the right.
 - Press and hold **PAUSE/REDIAL** to insert a dialing pause (a **p** appears).

-OR-

Copy a number from the redial list.

1. Press **PAUSE/REDIAL** and then **CID▼**, **▲DIR** or **PAUSE/REDIAL** to browse to select a number.
2. Press the **SELECT** softkey to copy the displayed number.
6. Press the **SELECT** softkey again.
7. Press **CID▼** or **▲DIR** to select one of the following types:
 - Home
 - Cell
 - Work
 - Other
8. Press the **SELECT** softkey. The screen displays **ENTER NAME**.
9. Use the dialing keys (see page 84) to enter the name.
 - Press **↵OFF/CLEAR** to erase a character.
 - Press **CID▼** to move the cursor to the left or **▲DIR** to the right.
10. Press the **SELECT** softkey to confirm and the screen shows **Saved**.

 **NOTE:** You cannot create new entries in your downloaded directories from your **TL86109** handsets. Entries must be downloaded from your cell phone (see **Download directory** on pages 27-28).

Create and review entries

Use the telephone base:

1. Press the **MENU** softkey on the telephone base in idle mode to enter the main menu.
2. Press **▼CID** or **▲DIR** to highlight **Directory**, then press the **MENU** softkey.
3. Press the **MENU** softkey again to select **Home**.
4. Press **▼CID** or **▲DIR** to highlight **Add contact**, then press the **MENU** softkey. The screen displays **ENTER NUMBER**.
5. Use the dialing keys to enter a telephone number.
 - Press **☎OFF/CLEAR** to erase a digit.
 - Press **▼CID** to move the cursor to the left or **▲DIR** to the right.
 - Press and hold **PAUSE/REDIAL** to insert a dialing pause (a **p** appears).

-OR-

Copy a number from the redial list.

1. Press **PAUSE/REDIAL** and then **▼CID**, **▲DIR** or **PAUSE/REDIAL** to browse to select a number.
2. Press the **SELECT** softkey to copy the displayed number.
6. Press the **SELECT** softkey again.
7. Press **▼CID** or **▲DIR** to select one of the following types:
 - Home
 - Cell
 - Work
 - Other
8. Press the **SELECT** softkey. The screen displays **ENTER NAME**.
9. Use the dialing keys (see page 84) to enter the name.
 - Press **☎OFF/CLEAR** to erase a character.
 - Press **▼CID** to move the cursor to the left or **▲DIR** to the right.
10. Press the **SELECT** softkey to confirm and the screen shows **Saved**.

 **NOTE:** You cannot create new entries in your downloaded directories from your **TL86109** handset. Entries must be downloaded from your cell phone (see **Download directory** on pages 27-28).

Create and review entries

Number key	Characters by number of key presses										
	1	2	3	4	5	6	7	8	9	10	11
1	1	.	-	'	()	*	#	&	/	,
2	A	B	C	a	b	c	2				
3	D	E	F	d	e	f	3				
4	G	H	I	g	h	i	4				
5	J	K	L	j	k	l	5				
6	M	N	O	m	n	o	6				
7	P	Q	R	S	p	q	r	s	7		
8	T	U	V	t	u	v	8				
9	W	X	Y	Z	w	x	y	z	9		
0	Space	0									
*											
#											

 **NOTE:** When entering a name in the directory, the first letter of each word is automatically capitalized.

Create and review entries

To add a predialed telephone number to the directory

You can save a predialed telephone number to the directory.

Use a handset:

1. Enter the telephone number in idle mode (see step 5 in **Create a new entry in the home directory** on page 82).
2. Press the **SAVE** softkey to edit the number (see step 3 in **Edit a directory entry** on page 90) and then press the **NEXT** softkey.
3. Press **CID**▼ or **▲DIR** to select one of the following types:
 - Home
 - Cell
 - Work
 - Other
4. Press the **NEXT** softkey. The screen displays **ENTER NAME**.
5. Use the dialing keys (see page 84) to enter the name.
 - Press **OFF/CLEAR** to erase a character.
 - Press **CID**▼ to move the cursor to the left or **▲DIR** to the right.
6. Press the **SAVE** softkey to confirm and the screen shows **Saved**. You hear a confirmation tone.

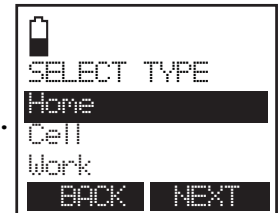
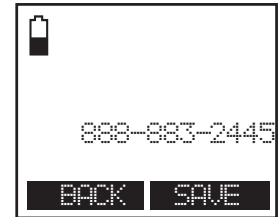

Use the telephone base:

1. Enter the telephone number in idle mode (see step 5 in **Create a new entry in the home directory** on page 82).
2. Press the **SAVE** softkey to edit the number (see step 3 in **Edit a directory entry** on page 90) and then press the **SELECT** softkey.
3. Press **▼CID** or **▲DIR** to select one of the following types:
 - Home
 - Cell
 - Work
 - Other
4. Press the **NEXT** softkey. The screen displays **ENTER NAME**.
5. Use the dialing keys (see page 84) to enter the name.
 - Press **OFF/CLEAR** to erase a character.
 - Press **CID**▼ to move the cursor to the left or **▲DIR** to the right.
6. Press the **SAVE** softkey to confirm and the screen shows **Saved**. You hear a confirmation tone.

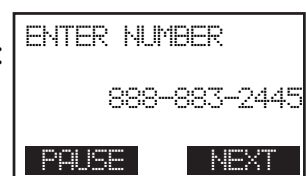

Review the directory

Entries are sorted alphabetically.

Use a handset:

1. Press **▲DIR** in idle mode.
2. Press **CID▼** or **▲DIR** to choose a directory, then press the **SELECT** softkey.
(If you only have one directory with entries, this step is not necessary.)
3. Press **CID▼** or **▲DIR** to browse.

-OR-

1. Press the **MENU** softkey on the handset in idle mode to enter the main menu.
2. Press **CID▼** or **▲DIR** to highlight **Directory**, then press the **SELECT** softkey.
3. Press **CID▼** or **▲DIR** to choose a directory, then press the **SELECT** softkey.
4. Press the **SELECT** softkey again to choose **Review**.
5. Press **CID▼** or **▲DIR** to browse.

Use the telephone base:

1. Press **▲DIR** in idle mode.
2. Press **▼CID** or **▲DIR** to choose a directory, then press the **SELECT** softkey.
(If you only have one directory with entries, this step is not necessary.)
3. Press **▼CID** or **▲DIR** to browse.

-OR-

1. Press the **MENU** softkey on the handset in idle mode to enter the main menu.
2. Press **▼CID** or **▲DIR** to highlight **Directory**, then press the **SELECT** softkey.
3. Press **▼CID** or **▲DIR** to choose a directory, then press the **SELECT** softkey.
4. Press the **SELECT** softkey again to choose **Review**.
5. Press **▼CID** or **▲DIR** to browse.

 **NOTE:** When the desired entry displays, press **#** on the handset or telephone base repeatedly to show different dialing options.

3-character alphabetical search

You can use the enhanced 3-character search to find your contacts quickly and efficiently.

To start the search:

1. Follow the steps in **Review the directory** above to enter the directory.
2. When an entry appears, use the dialing keys to enter the letters associated with the name (see page 84). You can enter up to three letters for the search. The letters will show in the bottom left hand corner of the screen. After you have entered between one to three letters, the system starts searching in the directory. If there is no name matching the letter(s) entered, the next closest match in alphabetical order appears. If necessary, use **CID▼** or **▲DIR** on the handset or **▼CID** or **▲DIR** on the telephone base to browse.

 **NOTE:** The cursor automatically moves to the next position two seconds after you enter a letter. If you do not enter another letter in the coming two seconds, the system starts searching in the directory.

Store a speed dial directory entry

You can store up to 10 directory entries in the speed dial memory locations and all speed dial entries are shared by all system handsets and telephone base.

Use a handset:

1. Press the **MENU** softkey when the handset is not in use.
2. Press **CID▼** or **▲DIR** to select **DIRECTORY** and then press the **SELECT** softkey.
3. Press **CID▼** or **▲DIR** to select **Speed dial**, then press the **SELECT** softkey. The screen shows a list from **1:** to **0:**.
4. Press **CID▼** or **▲DIR** to select the desired speed dial number, then press the **REPLACE** softkey. The screen shows the directory listed in chronological order.
5. Press **CID▼** or **▲DIR** to browse and select the desired entry, then press the **ASSIGN** softkey to confirm your selection.

Use the telephone base:

1. Press the **MENU** softkey when the handset is not in use.
2. Press **▼CID** or **▲DIR** to select **DIRECTORY** and then press the **SELECT** softkey.
3. Press **▼CID** or **▲DIR** to select **Speed dial**, then press the **SELECT** softkey. The screen shows a list from **1:** to **0:**.
4. Press **▼CID** or **▲DIR** to select the desired speed dial number, then press the **REPLACE** softkey. The screen shows the directory listed in chronological order.
5. Press **▼CID** or **▲DIR** to browse and select the desired entry, then press the **ASSIGN** softkey to confirm your selection.

Speed dial directory

Review the speed dial directory

Use a handset:

1. Press the **MENU** softkey when the handset is not in use.
2. Press **CID**▼ or **▲DIR** to select **DIRECTORY** and then press the **SELECT** softkey.
3. Press **CID**▼ or **▲DIR** to select **Speed dial**, then press the **SELECT** softkey.
4. Press **CID**▼ or **▲DIR** to browse the speed dial directory.

Use the telephone base:

1. Press the **MENU** softkey when the handset is not in use.
2. Press ▼**CID** or **▲DIR** to select **Directory** and then press the **SELECT** softkey.
3. Press ▼**CID** or **▲DIR** to select **Speed dial**, then press the **SELECT** softkey.
4. Press ▼**CID** or **▲DIR** to browse the speed dial directory.

Dial a directory entry

You can dial a directory entry on either a home or cell line.

To dial a directory entry:

1. Search for the desired entry in the directory (see **Review the directory or 3-character alphabetical search** on page 87).
2. When the desired entry appears, press **#** repeatedly on the handset or telephone base to show different dialing options.
3. When the displayed number is in the correct format, press **LINE 1/FLASH** or **LINE 1/FLASH** or **◀)/SPEAKER** on the handset or **LINE 1, LINE 2,** to **SPEAKER◀)** or lift the corded handset on the telephone base to use the home line, or **(P)CELL** on the handset, or **CELLULAR(P)** on the telephone base to use the cell line.

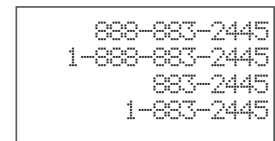

```
888-883-2445
1-888-883-2445
883-2445
1-883-2445
```

Dial a speed dial entry

Use a handset:

1. Press and hold the assigned number of the desired speed dial entry.
2. Press **LINE 1/FLASH** or **LINE 2/FLASH** or **◀)/SPEAKER** to make a home call or **(P)CELL** to make a cell call.

Use the telephone base:

1. Press and hold the assigned number of the desired speed dial entry.
2. Press **LINE 1** or **LINE 2** or **SPEAKER◀)** to make a home call or **CELLULAR(P)** to make a cell call.

Dial, edit or delete a directory

Edit a directory entry

You may edit any directory entry. However, be aware that if you download from a cell phone again, the directory is erased and replaced with the current cell phone directory. If you have edited the downloaded entry on the **TL86109**, those changes are lost. To avoid losing changes made to the downloaded directory, we suggest you edit the number in your cell phone, then download the directory.

Use the handset:

1. Search for the desired entry in the directory (see **Review the directory or 3-character alphabetical search** on page 86).
2. When the desired entry appears, press the **EDIT** softkey. The screen shows **EDIT NUMBER**.
3. Use the dialing keys to edit the number.
 - Press the **ERASE** softkey to erase a digit.
 - Press **CID▼** to move the cursor to the left or **▲DIR** to the right.
 - Press and hold **PAUSE/REDIAL** to insert a dialing pause (a **p** appears).
4. Press the **NEXT** softkey.
5. Press **CID▼** or **▲DIR** to select one of the following types:
 - Home
 - Cell
 - Work
 - Other
6. Press the **NEXT** softkey. The screen displays **EDIT NAME**.
7. Use the dialing keys (see page 84) to enter the name.
 - Press the **ERASE** softkey to erase a character.
 - Press **CID▼** to move the cursor to the left or **▲DIR** to the right.
8. Press the **SAVE** softkey to confirm and the screen shows **Saved**.

Dial, edit or delete a directory

Use the telephone base:

1. Search for the desired entry in the directory (see **Review the directory or 3-character alphabetical search** on page 86).
2. When the desired entry appears, press the **EDIT** softkey. The screen shows **EDIT NUMBER**.
3. Use the dialing keys to edit the number.
 - Press **CANCEL** to erase a digit.
 - Press **▼CID** to move the cursor to the left or **▲DIR** to the right.
 - Press the **PAUSE** softkey to insert a dialing pause (a **p** appears).
4. Press the **NEXT** softkey.
5. Press **▼CID** or **▲DIR** to select one of the following types:
 - Home
 - Cell
 - Work
 - Other
6. Press **MENU/SELECT**. The screen displays **EDIT NAME**.
7. Use the dialing keys (see page 84) to enter the name.
 - Press **CANCEL** to erase a character.
 - Press **CID▼** to move the cursor to the left or **▲DIR** to the right.
8. Press **MENU/SELECT** to confirm and the screen shows **Saved**.

Reassign a speed dial entry

Use a handset:

1. Press and hold the assigned number of the desired speed dial entry.
-OR-
Press the **MENU** softkey to enter the main menu in idle mode.
2. Press **CID▼** or **▲DIR** to highlight **DIRECTORY** and then press the **SELECT** softkey.
3. Press **CID▼** or **▲DIR** to highlight **Speed dial** and then press the **SELECT** softkey.
4. Press **CID▼** or **▲DIR** to highlight a desired directory and then press the **ASSIGN** softkey.
5. Press **CID▼** or **▲DIR** to scroll to a desired directory and then press the **ASSIGN** softkey. The handset displays **Directory A replaces Directory B Accept?**
6. Press the **Yes** softkey to confirm and you hear a confirmation tone.

Dial, edit or delete a directory

Use the telephone base:

1. Press and hold the assigned number of the desired speed dial entry.

-OR-

Press the **MENU** softkey to enter the main menu in idle mode.

2. Press **▼CID** or **▲DIR** to highlight **DIRECTORY** and then press the **SELECT** softkey.
3. Press **▼CID** or **▲DIR** to highlight **Speed dial** and then press the **SELECT** softkey.
4. Press **▼CID** or **▲DIR** to highlight a desired directory and then press the **ASSIGN** softkey.
5. Press **▼CID** or **▲DIR** to scroll to a desired directory and then press the **ASSIGN** softkey. The handset displays **Directory A replaces Directory B Accept?**
6. Press the **Yes** softkey to confirm and you hear a confirmation tone.

Edit the type of a directory entry

If you only want to edit the type of a directory entry:

1. Search for the desired entry in the directory (see **Review the directory or 3-character alphabetical search** on page 84).
2. When the desired entry appears, enter the corresponding shortcut keys on the handset or telephone base shown in the below table. The type you choose will appear on the screen between the name and number.

Type:	Press:
Home	✕ 1
Cell	✕ 2
Work	✕ 3
Other	✕ 4

Delete a directory entry

To delete an entry:

1. Search for the desired entry in the directory (see **Review the directory or 3-character alphabetical search** on page 84).
2. When the desired entry appears, press the **DELETE** softkey on the handset or telephone base. The screen displays **Delete contact?**
3. Press the **YES** softkey on the handset or telephone base. The screen displays **Contact deleted** and then the next alphabetical entry in the directory.

 **NOTE:** Once a directory entry is deleted, it cannot be retrieved.

Delete a speed dial entry

Use a handset:

1. Press and hold the assigned number of the desired speed dial entry.

-OR-

Press the **MENU** softkey to enter the main menu in idle mode.

2. Press **CID▼** or **▲DIR** to highlight **DIRECTORY** and then press the **SELECT** softkey.
3. Press **CID▼** or **▲DIR** to highlight **Speed dial** and then press the **SELECT** softkey.
4. Press **CID▼** or **▲DIR** to highlight a desired directory and then press the **DELETE** softkey.
5. The handset displays **Delete Directory A speed dial assignment?**
6. Press the **Yes** softkey to confirm and you hear a confirmation tone.

Use the telephone base:

1. Press and hold the assigned number of the desired speed dial entry.

-OR-

Press the **MENU** softkey to enter the main menu in idle mode.

2. Press **▼CID** or **▲DIR** to highlight **DIRECTORY** and then press the **SELECT** softkey.
3. Press **▼CID** or **▲DIR** to highlight **Speed dial** and then press the **SELECT** softkey.
4. Press **▼CID** or **▲DIR** to highlight a desired directory and then press the **DELETE** softkey.
5. The handset displays **Delete Directory A speed dial assignment?**
6. Press the **Yes** softkey to confirm and you hear a confirmation tone.

Remove a downloaded directory

(downloaded directories only)

Use a handset:

1. Press the **MENU** softkey in idle mode to enter the main menu.
2. Press **CID▼** or **▲DIR** to highlight **DIRECTORY** and then press the **SELECT** softkey.
3. Press **CID▼** or **▲DIR** to choose the desired downloaded directory, then press the **SELECT** softkey.
4. Press **CID▼** or **▲DIR** to highlight **Remove dir** and then press the **SELECT** softkey.
5. The screen displays **Erase Cell Phone A directory?** Press the **SELECT** softkey and the screen displays **Directory removed**. You hear a confirmation tone.

Use the telephone base:

1. Press the **MENU** softkey in idle mode.
2. Press **▼CID** or **▲DIR** to highlight **Directory** and then press the **SELECT** softkey.
3. Press **▼CID** or **▲DIR** to choose the desired downloaded directory, then press the **SELECT** softkey.
4. Press **▼CID** or **▲DIR** to highlight **Remove dir** and then press the **SELECT** softkey.
5. The screen displays **Erase Cell Phone A directory?** Press the **SELECT** softkey and the screen displays **Directory removed**. You hear a confirmation tone.

About caller ID

This product supports caller ID services provided by most telephone service providers. Caller ID allows you to see the name, number, date and time of calls. The available caller ID information will appear after the first or second ring.

Information about caller ID with call waiting

Caller ID with call waiting lets you see the name and telephone number of the caller before answering the telephone, even while on another call.

It may be necessary to change your telephone service to use this feature. Contact your telephone service provider if:

- You have both caller ID and call waiting, but as separate services (you may need to combine these services).
- You have only caller ID service, or only call waiting service.
- You don't subscribe to caller ID or call waiting services.



There are fees for caller ID services. In addition, services may not be available in all areas.

Caller ID information is available only if both you and the caller are in areas offering caller ID service, and if both telephone service providers use compatible equipment.

The caller ID information may not be available for every incoming call. The callers may intentionally block their names and/or telephone numbers. A call log entry can show a maximum number of 24 digits.

i **NOTE:** You can use this product with regular caller ID service, or you can use this product's other features without subscribing to caller ID or combined caller ID with call waiting service.

Caller ID operation

How the caller ID history (call log) works

The telephone stores caller ID information about the last 50 incoming calls in the telephone base. Entries are stored in reverse chronological order. The system deletes the oldest entry when the log is full to make room for new calls. This information is common to all handset(s) and the telephone base, so changes made using any handset are reflected in all other handsets. If you answer a call before the information appears on the screen, it does not show in the caller ID history.

i NOTE: If the phone number has more than 24 digits, it will not be saved or shown in the call log.

Missed calls indicator

The handset and telephone base display **XX Missed call(s)** when they are in idle mode and have missed or new calls.

All missed or new entries are counted as missed calls. Each time you review a call log entry with the icon **NEW**, the number of missed calls decreases by one.



Display alerts settings

If you do not want to review the missed calls one by one, but you still want to keep them in the caller ID history, you can follow the below steps:

Use a handset

1. Press the **MENU** softkey in idle mode to enter the main menu.
2. Press **CID▼** or **▲DIR** to highlight **SETTINGS** and then press the **SELECT** softkey.
3. Press **CID▼** or **▲DIR** to highlight **Display alerts**, then press the **SELECT** softkey.
4. Press **CID▼** or **▲DIR** to choose from **Line 1**, **Line 2** or **Cell**, then press the **SELECT** softkey.
5. Press the **SELECT** softkey again enter **Missed calls**. The handset displays **Reset missed call indication?** Press the **Yes** softkey to confirm and you hear a confirmation tone.

Use the telephone base:

1. Press the **MENU** softkey in idle mode.
2. Press **▼CID** or **▲DIR** to highlight **Settings** and then press the **SELECT** softkey.
3. Press **▼CID** or **▲DIR** to highlight **Display alerts**, then press the **SELECT** softkey.
4. Press **▼CID** or **▲DIR** to choose from **Line 1**, **Line 2** or **Cell**, then press the **SELECT** softkey.
5. Press the **SELECT** softkey again enter **Missed calls**. The handset displays **Reset missed call indication?** Press the **Yes** softkey to confirm and you hear a confirmation tone.

Caller ID operation

Memory match

If the incoming telephone number matches the last seven digits of a telephone number in your directory, the name that appears on the screen matches the corresponding name in your directory.

For example, if Christine Smith calls, her name appears as **Chris** if this is how you enter it into your directory.

i **NOTE:** The number you see on your caller ID is in the format from the telephone service provider. It usually delivers 10-digit telephone numbers (area code plus telephone number). If the last seven digits of the incoming telephone number do not match a number in your directory, the name appears as it is delivered by the telephone service provider.

To review the call log

Review the caller ID history to find out who called, to easily return a call, or to copy the caller's name and number into your directory. **Call log empty** appears if there are no records in the call log.

Use a handset:

1. Press **CID** on the handset while in idle mode. Press **CID** or **DIR** to choose a desired call log and then press the **SELECT** softkey. Press the **SELECT** softkey again to review the caller ID history in reverse chronological order starting with the most recent call. **-OR-** Press the **MENU** softkey to enter the main menu, then press **CID** or **DIR** to scroll to **Call log**. Press **CID** or **DIR** to choose a desired call log and then press the **SELECT** softkey. Press the **SELECT** softkey again to enter **Review**.
2. Press **CID** or **DIR** to scroll through the list.
3. Press **OFF/CLEAR** to exit the caller ID history.

i **NOTE:** Only one handset can review the caller ID history at time. If another handset or the telephone base tries to enter the directory or caller ID history. It shows **Not available at this time**.



Caller ID operation

Use the telephone base:

1. Press **▼CID** on the telephone base while in idle mode. Press **▼CID** or **▲DIR** to choose a desired call log and then press the **SELECT** softkey to review the caller ID history in reverse chronological order starting with the most recent call.
-OR-
Press the **MENU** softkey to enter the main menu and then press **▼CID** or **▲DIR** to scroll to **Call log**. Press **SELECT** twice to **Review**.
2. Press **▼CID** or **▲DIR** to scroll through the list.
3. Press **CANCEL** to exit the caller ID history.

Handset screen display



Screen display of the telephone base



Caller ID operation

View dialing options

Although the call log entries may contain 10 digits (the area code plus the seven-digit number), in some areas, you may need to dial only the seven digits, or **1** plus the seven digits, or **1** plus the area code plus the seven digits. You can change the number of digits that you dial from the call log or store to the directory.

While reviewing the call log, press **#** repeatedly to show different dialing options for local and long distance numbers before dialing or saving the telephone number in the directory.

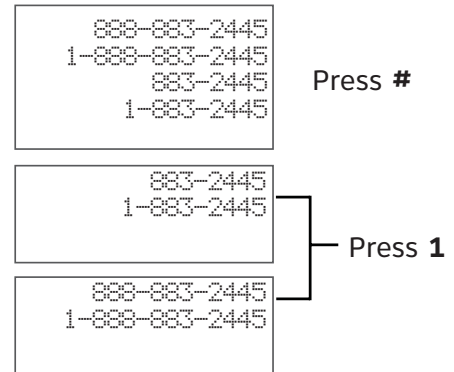

Press **1** repeatedly if you need to add or remove **1** in front of the telephone number before dialing or saving it in the directory.

When the number shows in the correct format for dialing, press **LINE 1/FLASH, LINE 2/FLASH** or **◀)/SPEAKER** on the handset or **LINE 1, LINE 2,** or **SPEAKER◀)** on the telephone base, or lift the corded handset to call the number using the home line.

-OR-

Press **☎)CELL** on the handset or **CELLULAR ☎)** on the telephone base to call the number using the cell line.

Dial a call log entry

Use a handset:

1. Search for the desired entry in the call log (see **To review the call log** on page 98).
2. When the desired entry is displayed and is in the correct format for dialing, press **LINE 1/FLASH, LINE 2/FLASH** or **◀)/SPEAKER** on the handset to use the home line, or **☎)CELL** to use the cell line.

Use the telephone base:

1. Search for the desired entry in the call log (see **To review the call log** on page 98).
2. When the desired entry is displayed and is in the correct format for dialing, press **LINE 1, LINE 2** or **SPEAKER◀)**, or lift the corded handset to use the home line, or **CELLULAR☎)** to use the cell line.

Save a call log entry to the directory

Call log entries can only be saved to the **Home** directory.

Use a handset:

1. Select a desired entry in the call log (see **To review the call log** on page 98).
2. When the desired entry appears, press **#** repeatedly to show different dialing options.
3. When the number is in the correct format, press the **SAVE** softkey. The screen shows **ENTER NUMBER**.
4. Use the dialing keys to edit the number.
 - Press **OFF/CLEAR** to erase a digit.
 - Press **CID▼** to move the cursor to the left or **▲DIR** to the right.
 - Press and hold **PAUSE/REDIAL** to insert a dialing pause (a **p** appears).
5. Press the **NEXT** softkey.
6. Press **CID▼** or **▲DIR** to select one of the following types:
 - Home
 - Cell
 - Work
 - Other
7. Press the **NEXT** softkey. The screen displays **ENTER NAME**.
8. Use the dialing keys (see page 84) to edit the name.
 - Press **OFF/CLEAR** to erase a digit.
 - Press **CID▼** to move the cursor to the left or **▲DIR** to the right.
9. Press the **SELECT** softkey and you hear a confirmation tone.

Caller ID operation

Use the telephone base:

1. Select a desired entry in the call log (see **To review the call log** on page 98).
2. When the desired entry appears, press **#** repeatedly to show different dialing options.
3. When the number is in the correct format, press the **SAVE** softkey. The screen shows **EDIT NUMBER**.
4. Use the dialing keys to edit the number.
 - Press **CANCEL** to erase a digit.
 - Press **▼CID** to move the cursor to the left or **▲DIR** to the right.
 - Press the **PAUSE** softkey to insert a dialing pause (a **p** appears).
5. Press the **NEXT** softkey.
6. Press **▼CID** or **▲DIR** to select one of the following types:
 - Home
 - Cell
 - Work
 - Other
7. Press the **NEXT** softkey. The screen displays **EDIT NAME**.
8. Use the dialing keys (see page 84) to edit the name.
 - Press **↵OFF/CLEAR** to erase a digit.
 - Press **▼CID** to move the cursor to the left or **▲DIR** to the right.
9. Press the **SELECT** softkey and you hear a confirmation tone.

Caller ID operation

To delete a single entry

1. Select a desired entry in the call log (see **To review the call log** on page 98).
2. When the desired entry is displayed, press the **DELETE** softkey on the handset or telephone base. The screen shows the previous call log entry.

To delete all entries

Use a handset:

1. Press the **MENU** softkey on the handset in idle mode to enter the main menu.
2. Press **CID**▼ or **▲DIR** to highlight **Call log**, then press the **SELECT** softkey.
3. Press **CID**▼ or **▲DIR** to highlight a desired call log, then press the **SELECT** softkey.
4. Press **CID**▼ or **▲DIR** to highlight **Del all calls**, then press the **SELECT** softkey.
5. The screen displays **Delete all LINE X calls?** Press the **YES** softkey to clear all entries and you hear a conformation tone.

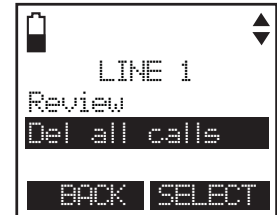

Use the telephone base:

1. Press the **MENU** softkey on the telephone base in idle mode to enter the main menu.
2. Press **▼CID** or **▲DIR** to highlight **Call log**, then press the **SELECT** softkey.
3. Press **▼CID** or **▲DIR** to highlight a desired call log, then press the **SELECT** softkey.
4. Press **▼CID** or **▲DIR** to highlight **Del all calls**, then press the **SELECT** softkey.
5. The screen displays **Delete all LINE X calls?** Press the **YES** softkey to clear all entries and you hear a conformation tone.

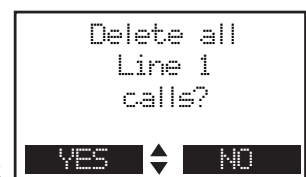

Caller ID operation

Reasons for missing caller ID information



There are occasions when other information or no information shows for various reasons:

On-screen message	Reason
L	It is a long distance call.
Private name	The caller prefers not to show the name.
Private number	The caller prefers not to show the phone number.
Private caller	The caller prefers not to show the phone number and name.
Unknown name	Your telephone service provider cannot determine the caller's name.
Unknown number	Your telephone service provider cannot determine the caller's number.
Unknown caller	No information is available about this caller.

About the answering system

Answering system and voicemail

Your telephone has separate indicators for two different types of voice messages: those recorded on its built-in answering system and those recorded in your service provider's voicemail (fees may apply). Your telephone's built-in answering system messages and voicemail messages are separate. Each alerts you to new messages differently.

If 1 or 2 and **New voicemail** display on the handsets or telephone base, your telephone service provider is indicating that it has new voicemail for you. To listen to your voicemail, you typically dial an access number provided by your telephone service provider, followed by a security code or PIN.

Some service providers bundle or combine multiple services like voicemail and call waiting, so you may not be aware that you have voicemail. To check what services you have and how to access them, contact your telephone service provider.

To use your voicemail service rather than your answering system, turn off your answering system. To use your answering system rather than your voicemail service, contact your telephone service provider to deactivate your voicemail service. You can also use your telephone answering system and voicemail together by setting your built-in answering system to answer before voicemail answers as described below. To learn how to program your voicemail settings, contact your telephone service provider. Then, if you are on a call, or if the answering system is busy recording a message and you receive another call, the second caller can leave a voicemail message.

Set your answering system to answer calls at least two rings earlier than your voicemail is set to answer. For example, if your voicemail answers after six rings, set your answering system to answer after four rings. Some voicemail providers may program the delay before answering calls in seconds instead of rings. In this case, allow six seconds per ring when determining the appropriate setting.

About the answering system

Answering system new message indication

When there are new message(s) on the answering system of line 1, **L1> XX New msgs** and **00** with line 1 indicators display on the screens of the handset and telephone base. **MAILBOX/LINE 1** ►/■ flashes on the telephone base.



When there are new messages on the answering system of line 2, **L2>XX New msgs** and **00** with line 2 indicators display on the screens of the handset and telephone base. **MAILBOX/LINE 2** ►/■ flashes on the telephone base.



When there are new messages on the answering system of both line 1 and line 2, **L1> XX New msgs**, **L2>XX New msgs** and **00** with line 1 and 2 indicators display on the screens of the handset and telephone base. **MAILBOX/LINE 1** ►/■ and **MAILBOX/LINE 2** ►/■ flash on the telephone base.

If the new message alert tone is turned on, the telephone base beeps every 10 seconds when there are new or missed messages.

Message capacity

The answering system of line 1 and line 2 can each record and store up to 99 messages. Each message can be up to four minutes in length. The total storage capacity for the announcement, messages and memos is approximately 14 minutes. The actual recording time depends on individual message characteristics. Messages remain available for replay until you delete them.

If the answering system has less than three minutes, it announces, *"Less than three minutes to record."* The handset screen displays **Less than 3 minutes to record** before message playback.

If the memory is full, the answering system announces, *"Memory is full."* The handset screen displays **Memory full** and the number of messages and **F** are flashing alternately in the message counter. You cannot record new messages until old ones have been deleted.

Voice prompts

The system provides voice prompts to guide you through remote access and recording outgoing announcements.

About the answering system

Call screening at the telephone base

If the answering system and call screening are on, the announcement and the incoming message broadcast at the telephone base when a call arrives.

During message recording, press **MAILBOX/LINE 1** ►/■ or **MAILBOX/LINE 2** ►/■ repeatedly to turn call screening on and off for the corresponding call. Press **▼VOLUME▲** on the telephone base to adjust the message volume. To change the call screening setting for all calls see page 54.

During call screening, press **MAILBOX/LINE 1** ►/■ or **MAILBOX/LINE 2** ►/■ on the telephone base to turn off the call screening for the corresponding call. If the call screening is off and the answering system has answered a call, press **MAILBOX/LINE 1** ►/■ or **MAILBOX/LINE 2** ►/■ or **VOLUME▲** to turn on the call screening.

Call intercept

If you want to talk to the caller who is recording a message on line 1 or line 2, press the corresponding line button **LINE 1/FLASH** or **LINE 2/FLASH** on the handset, or **MAILBOX/LINE 1** ►/■ or **MAILBOX/LINE 2** ►/■ flash on the telephone base.

Telephone base ringer volume

Press **▼VOLUME▲** on the telephone base to adjust the ringer volume when the telephone is not in use. When you set the ringer volume to zero, the base ringer is off and the screen shows **Ringer muted**.

Temporarily turning off the message alert tone

Pressing any telephone base key (except **📞/HANDSET LOCATOR**) temporarily silences the message alert tone.

The message alert tone plays with the next incoming message.

Message playback

If you have new messages, the telephone plays only the new messages (oldest first). If there are no new messages, the telephone plays all messages (oldest first).

When playback begins, the handset screen displays **PLAYING MESSAGES** and you hear the total number of messages followed by the day and time of the message. After the last message, the telephone announces, “*End of messages.*” and the screen displays **End of messages**. If the recording time is less than three minutes, you hear, “*Less than three minutes to record.*” (see **Message capacity** on page 106)

To listen to messages with a handset:

1. Press the **MENU** softkey in idle mode.
2. Press the **SELECT** softkey to select **Play messages**.
3. Press **CID**▼ or **▲DIR** to select **Mailbox 1** or **Mailbox 2**, then press the **SELECT** softkey.
4. If there are new and old messages, press **CID**▼ or **▲DIR** to select **Play new msgs** or **Play old msgs** and then press the **SELECT** softkey.

Options during playback:

- Press **EQ**  button to adjust the message playback audio quality.
- Press **▼VOLUME▲** to adjust the speakerphone volume.
- Press **6** to skip to the next message.
- Press **4** to repeat the message currently playing. Press **4** twice to listen to the previous message.
- Press **3** to delete the current message. The system advances to the next message.
- Press **5** to stop.

To listen to messages with the telephone base:

1. Press **MAILBOX/LINE 1** ►/■ or **MAILBOX/LINE 2** ►/■ to listen to messages on line 1 or line 2 respectively.

Options during playback:

- Press **▼VOLUME▲** to adjust the speaker volume.
- Press **►/SKIP** to skip to the next message.
- Press **◀/REPEAT** to repeat the message currently playing. Press **◀/REPEAT** twice to listen to the previous message.
- Press **▲/DELETE** to delete the current message. The system advances to the next message.
- Press **MAILBOX/LINE 1** ►/■ or **MAILBOX/LINE 2** ►/■ to stop listening to messages on line 1 or line 2 respectively.

Message playback

The system announces the number of messages, then begins playback. The message sequence is shown on the handset screen. If there are no recorded messages, the handset screen shows **No message** with voice prompt “*You have no message.*”

Delete all old messages

Use a handset:

1. Press the **MENU** softkey on the handset in idle mode to enter the main menu.
2. Press **CID**▼ or **▲DIR** to highlight **Answering sys** then press the **SELECT** softkey.
3. Press **CID**▼ or **▲DIR** to highlight **Mailbox 1** or **Mailbox 2**, then press the **SELECT** softkey.
4. Press **CID**▼ or **▲DIR** to highlight to highlight **Delete all old**, then press the **SELECT** softkey.
5. The handset displays **Delete all old messages?** Press the **YES** softkey to confirm. The handset displays **All old messages deleted!** and you hear a confirmation tone.

Use the telephone base:

1. Press **▲DELETE** on the telephone base when the phone is not in use.
2. Press **▼CID** or **▲DIR** to highlight **MAILBOX 1** or **MAILBOX 2**, then press the **SELECT** softkey.
3. The telephone base screen displays **Delete all old messages?** Press the **YES** softkey to confirm. The handset displays **All old messages deleted!** and you hear a confirmation tone.

-OR-

1. Press the **MENU** softkey on the telephone base in idle mode to enter the main menu.
2. Press **▼CID** or **▲DIR** to highlight **Answering sys**, then press the **SELECT** softkey.
3. Press **▼CID** or **▲DIR** to highlight **Mailbox 1** or **Mailbox 2**, then press the **SELECT** softkey.
4. Press **▼CID** or **▲DIR** to highlight to highlight **Delete all old**, then press the **SELECT** softkey.
5. The telephone base screen displays **Delete all old messages?** Press the **YES** softkey to confirm. The handset displays **All old messages deleted!** and you hear a confirmation tone.

 **NOTE:** You can only delete old messages, which are messages you have played.

Message playback

Record memos

Memos are messages you record as reminders for yourself or others using the same answering system. You can record your own memos using a system handset. Playback and delete them the same way as incoming messages.

Use a handset:

1. Press the **MENU** softkey on the handset in idle mode to enter the main menu.
2. Press **CID▼** or **▲DIR** to highlight **Answering sys**, then press the **SELECT** softkey.
3. Press **CID▼** or **▲DIR** to highlight **Mailbox 1** or **Mailbox 2**, then press the **SELECT** softkey.
4. Press **CID▼** or **▲DIR** to highlight **Record memo**, then press the **SELECT** softkey.
5. The system announces, *"Record after the tone. Press STOP when you are done."* After the tone, speak towards the microphone.
6. Press the **STOP** softkey when you finish recording. The handset announces, *"Recorded"* and then returns to the previous menu.

Use the telephone base:

1. Press the **MENU** softkey on the telephone base in idle mode to enter the main menu.
2. Press **CID▼** or **▲DIR** to highlight **Answering sys**, then press the **SELECT** softkey.
3. Press **CID▼** or **▲DIR** to highlight **Mailbox 1** or **Mailbox 2**, then press the **SELECT** softkey.
4. Press **CID▼** or **▲DIR** to highlight **Record memo**, then press the **SELECT** softkey.
5. The system announces, *"Record after the tone. Press stop when you are done."* After the tone, speak towards the microphone.
6. Press the **STOP** softkey when you finish recording. The handset announces, *"Recorded"* and then returns to the previous menu.

Message playback

-OR-

1. Press **▼RECORD** on the telephone base in idle mode to enter the main menu.
2. Press the **SELECT** softkey to enter **MEMO**.
3. Press **CID▼** or **▲DIR** to highlight **Mailbox 1** or **Mailbox 2**, then press the **SELECT** softkey.
4. The system announces, *"Record after the tone. Press stop when you are done."* After the tone, speak towards the microphone.
5. Press the **STOP** softkey when you finish recording. The handset announces, *"Recorded"* and then returns to the previous menu.

NOTES:

1. The system announces *"Memory is full,"* if you attempt to record a memo when the memory is full.
2. Each memo can be up to four minutes in length.
3. Memos shorter than one second are not recorded.

To play a memo

Play memos the same way as messages. See **Message playback** on page 108.

Remote access

You can access the answering system remotely by dialing your home telephone number from any touch-tone telephone.

To remotely access the answering system

1. Dial your telephone number from any touch-tone telephone.
2. When the system plays your announcement, enter the two-digit remote access code (**19** is the preset code, see page 56 to change it).
3. You can also enter the remote commands (see **Remote commands** below).
4. Hang up or press **8** to end the call and save all undeleted messages.

Remote commands





















1	Press to listen to all messages.
2	Press to listen to new messages only.
3	Press to delete the current message (during playback).
3 3	Press twice to delete all old messages.
4	Press to repeat the current message (during playback).
4 4	Press twice to listen to the previous message.
5	Press to stop any operation (including recording).
* 5	Press to listen to a list of remote commands.
6	Press to skip to the next message (during playback).
* 7	Press to record a new announcement in Annc A .
* 8	Press to record a new announcement in Annc B .
* 9	Press to end remote access (the call is terminated).
0	Press to turn the answering system on or off.

NOTES:

1. If you do not press any keys after you enter the remote access code, all new messages play. If there are no new messages, all old messages play.
2. Once the new messages have played, the telephone announces the help menu options. If you do not press any key within 20 seconds, the remote access call automatically disconnects.
3. When the answering system is turned off, the telephone answers after 10 rings, and announces, *"Please enter your remote access code."*
4. When the memory is full, the answering system answers incoming calls after 10 rings and announces, *"Memory is full. Enter the remote access code."*

Appendix
Handset screen icons



	Handset battery is charging (animated displayed). Becomes solid when the battery is fully charged.
	Flashes when the battery is low and needs charging.
	Line 1 is in use.
	Line 2 is in use.
	New voicemail received on line 1 from the telephone service provider.
	New voicemail received on line 2 from the telephone service provider
	New voicemail received on line 1 and line 2 from the telephone service provider
	New answering system message(s) on line 1.
	New answering system message(s) on line 2.
	New answering system message(s) on line 1 and line 2.
	Answering system on line 1 is turned on.
	Answering system on line 2 is turned on.
	Answering system on line 1 and line 2 are turned on.
	There are Bluetooth connected devices on the active device list.
	There are Bluetooth disconnected devices on the active list.
	On steadily when the cell line is in use or there is an incoming call.
	Speakerphone is in use.
	Headset is used during a call
	There are missed and new calls in the call log.
	Microphone is muted.

Telephone base screen icons



	Line 1 is in use.
	Line 2 is in use.
	New voicemail received on line 1 from the telephone service provider.
	New voicemail received on line 2 from the telephone service provider
	New voicemail received on line 1 and line 2 from the telephone service provider
	New answering system message(s) on line 1.
	New answering system message(s) on line 2.
	New answering system message(s) on line 1 and line 2.
	Answering system on line 1 is turned on.
	Answering system on line 2 is turned on.
	Answering system on line 1 and line 2 are turned on.
	There are Bluetooth connected devices on the active device list.
	There are Bluetooth disconnected devices on the active list.
	On when the cell line is in use or there is an incoming call.
	Speakerphone is in use.
	Headset is used during a call
	There are missed and new calls in the call log.
	Microphone is muted.

Alert tones and lights

Handset alert tones

Two short beeps	You are pressing CID or DIR when the volume is already at its highest or lowest setting. -OR- You have reached the end of the caller ID history.
Three short beeps	Out of range while the handset is on a call.
Three short high-pitched beeps	The telephone has completed the command successfully.
Four short beeps	Low battery warning.

Telephone base alert tones

Beeps once every 10 seconds	Message alert.
-----------------------------	----------------

Handset indicator lights



CHARGE light

On when the handset is charging in the telephone base or charger.

Backlight (lighted display and dial pad)

On when the handset is lifted from the telephone base or charger.

On when a key is pressed.

SPEAKER light

On when the speakerphone is in use.

Telephone base indicator lights

DEVICE A/DEVICE B lights

On when the telephone base is paired and connected with a Bluetooth device.
Flash alternately while pairing a Bluetooth device.

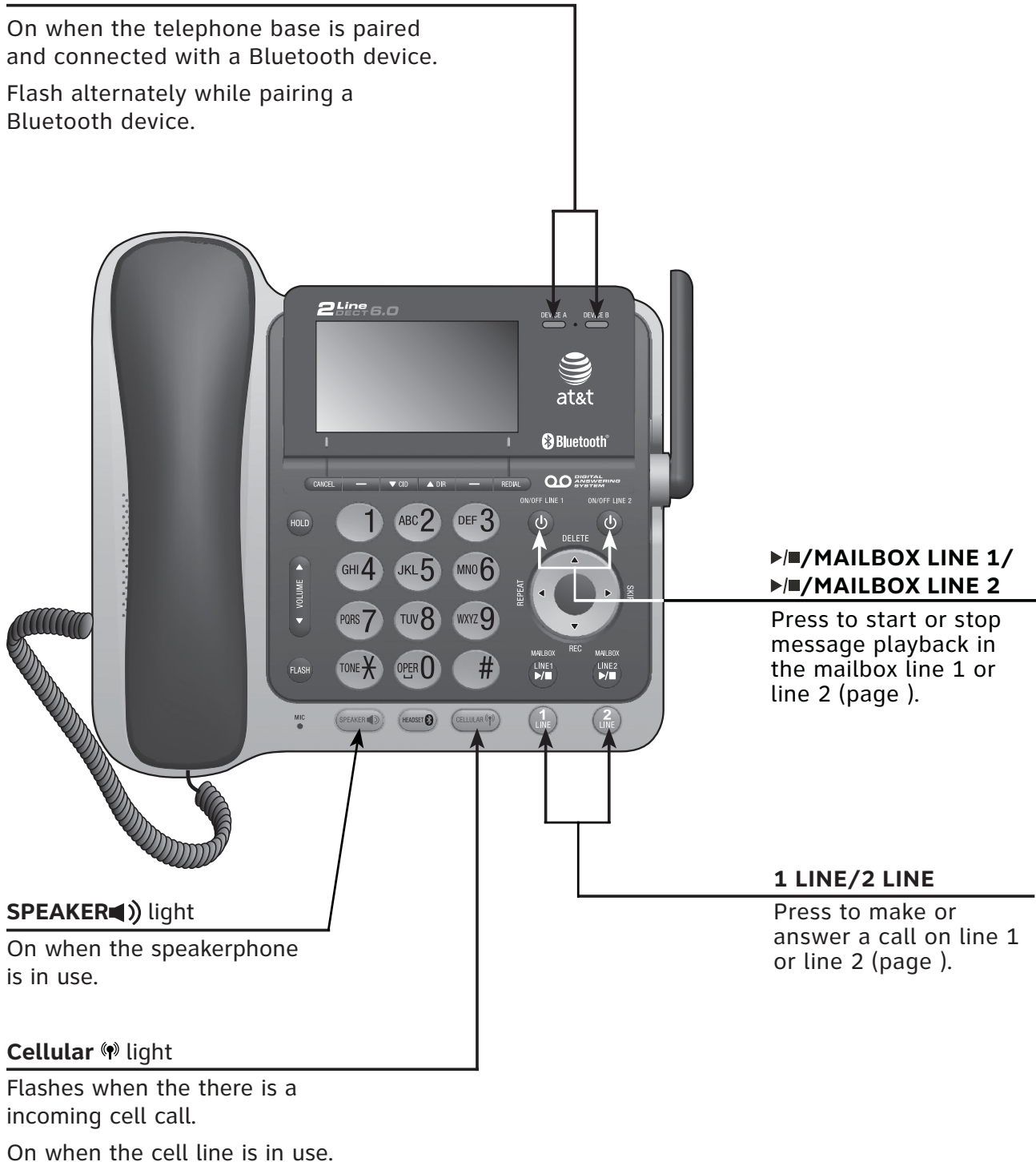

SPEAKER light
On when the speakerphone is in use.

Cellular light
Flashes when there is an incoming cell call.
On when the cell line is in use.

MAILBOX LINE 1/MAILBOX LINE 2

Press to start or stop message playback in the mailbox line 1 or line 2 (page).

1 LINE/2 LINE

Press to make or answer a call on line 1 or line 2 (page).

Screen messages

Display screen messages

Already saved	The telephone number you have entered is already stored in the directory.
Base is calling	The telephone base is calling another handset.
Bluetooth system busy	You are trying to make a cell call or access the Bluetooth menu when the Bluetooth link is already being used.
Call log empty	There are no entries in the caller ID history.
Calling BASE	A system handset is calling the telephone base.
Call transferred	An outside call from one handset is transferred to another handset.
Calling HANDSET X (For models with more than two handsets)	The handset is calling another handset (for intercom calls).
Calling other handset (For models with two handsets only)	The handset is calling the other handset (for intercom calls). The handset is going to transfer an outside call to the other handset.
Cell	The cell line is on a call.
Cell call on hold	A call on the cell line has been put on hold.
Cell line in use	Another system handset is using the cell line.
Charging	The handset with low battery is recharging.
Connecting...	The handset has lost communication with the telephone base.
Directory empty	There are no directory entries.
Directory is full	The directory is full.
Downloading dir	The system is downloading a directory from a cell phone.
Ended	You have just ended a call.
HANDSET X is calling (For models with more than two handsets)	Another system handset is calling.
Home	The home line is on a call.
Home call on hold	A call on the home line has been put on hold.
Home & cell calls on hold	Calls on the home and cell lines have been put on hold.

Screen messages

Home & cell lines in use	Calls on the home and cell lines are being used.
Home line in use	A system handset or another telephone on the same home line is in use.
Incoming call	There is a call coming in.
Intercom	The handset is on an intercom call.
Intercom ended	The intercom call has just ended.
Intercom to: (For models with more than two handsets)	You have started the intercom process, and need to enter the number of the handset you wish to call.
List full	The directory is full. You cannot save any new entries unless you delete some current entries.
Low battery	The battery needs to be charged.
Microphone off	The handset microphone is off. The other party cannot hear you but you can hear the other party.
Microphone on	The handset microphone is on.
No battery	The battery is not properly installed and the handset is in the telephone base or charger.
No entries found. Try downloading from SIM only Press	There are no entries found when you download a cell phone directory from the cell memory.
No entries found. Try downloading from Phone only Press	There are no entries found when you download a cell phone directory from your SIM card. There are no entries found in either the cell or SIM card when you download a cell phone directory from both memories.
No connected cellular phones	There is no cellular phone connected to the base.
No home line	There is no telephone line connected.
No message	There is no message recorded on the answering system.
No signal, call ended	The phone lost the connection with the telephone base or does not have a strong enough signal and the phone call ended.
Not available at this time	Someone else is already using the directory or caller ID history.

Screen messages

Other handset is calling (For models with two handsets only)	The other handset is calling.
Out of range OR No Power at base	The handset has lost communication with the telephone base. There is no power connected to the telephone base.
** Paging **	The telephone base is paging all handsets.
Place in charger	The battery is very low. The handset should be placed in the telephone base or charger.
Rec mem full	The answering system has no recording time left.
Ringer mute	The ringer is muted temporarily during an incoming call.
Rec mem low	The answering system has less than three minutes to record.
Saved	The entry is now in the directory.
Unable to call try again	Failed intercom or conference call.
Unable to complete call. Check cellular.	You are trying to make a cell call when the cell line is already being used.
Unable to save	You are trying to save an entry with no name and number from the caller ID history.
Voicemail	There are new voicemail message(s) from your telephone service provider.
XX Missed call(s)	There are new calls in the caller ID history.
XX New message(s)	There are new messages recorded in the answering system.

Expand your telephone system

The handsets provided with your telephone system are already registered. Additional handsets registered to the telephone system are assigned in sequential order. For instance, if you already have **HANDSET 1** and **HANDSET 2**, the new registered handset is assigned **HANDSET 3**. This telephone system accommodates up to 12 handsets.

Add and register a handset (optional)

You can add new handsets (**TL86009**, purchased separately) to your telephone system, but each handset must be registered with the telephone base before use. When first purchased, each expansion handset shows **Press HOLD key on base for 4 sec, then press # key on handset** after a battery is installed. Each handset should be charged without interruption for at least 30 minutes before registering to the telephone base. For more details on battery charging, see the table on page 11.

To register a handset:

1. Press and hold **HOLD** on the telephone base for about four seconds until the red **IN USE** light turns on.
2. Press **#** on the handset. Its screen shows **Registering...Please wait** and it takes up to 60 seconds to complete the registration. The handset shows **HANDSET X Registered** (X represents the handset number assigned) and you hear a beep when the registration is completed.



i NOTES:

1. If the registration fails, the handset shows **Registration failed** for a few seconds and then **Press HOLD key on base for 4 sec, then press # key on handset**. Try the registration process again.
2. You cannot register a handset if any other system handset is in use.

Replace a handset

If you want to replace a handset or reassign the designated handset number of a registered handset, you must deregister all the handsets and then individually register each handset.

To make deregistration easier, read all of the instructions on this page before you begin.

To deregister all handsets:

1. Press and hold **HOLD** on the telephone base for about 10 seconds until the **IN USE** light flashes, then release **HOLD**.
2. Press **HOLD** again. You must press **HOLD** while the **IN USE** light is still flashing. The **IN USE** light flashes for about seven seconds.
3. All system handsets show **Out of range OR No power at base** for a few seconds and then show **Press HOLD key on base for 4 sec, then press # key on handset** when the deregistration is completed. The deregistration process takes about 10 seconds to complete.

If deregistration fails, you may need to reset the telephone and try again.

To reset:

- Press and hold  **OFF/CLEAR** or place the handset back in the charger.
- OR-
- Unplug the power from the telephone base, then plug it back in.

After deregistering, register each handset individually. See **Add and register a handset** on page 120.

 **NOTE:** You cannot deregister the handsets if any other system handset is in use.

Troubleshooting

If you have difficulty with your telephone, please try the suggestions below. For Customer Service, or to purchase accessories or replacement parts, visit our website at **www.telephones.att.com**, or call **1 (800) 222-3111**. In Canada, dial **1 (866) 288-4268**. Have the serial number, found on the underside of your telephone, available when contacting customer service.

I cannot pair my cell phone to the telephone base.

- Make sure you have cellular coverage.
- Make sure the Bluetooth function of your cell phone is turned on. See the user's manual of your cell phone for more information.
- Make sure that you set your cell phone to search for devices.
- If the **TL86109** is in your cell phone device history list, delete it and try pairing again.
- Carefully follow the pairing instructions on page 15 and make sure that your cell phone is not connected to any other Bluetooth device.
- Turn off your cell phone, then turn it on again.
- Reset the telephone base. Unplug the unit's electrical power. Wait for approximately 15 seconds, then plug it back in. Repeat the above suggestions.

I cannot pair my headset to the telephone base.

- Make sure that your Bluetooth headset is in discoverable mode when pairing with the telephone base. See the user's manual of your headset for more information on how to set your headset to discoverable mode.
- Carefully follow the pairing instructions on page 17 and make sure that your headset is not connected to any other Bluetooth device.
- Reset the telephone base. Unplug the unit's electrical power. Wait for approximately 15 seconds, then plug it back in. Repeat the above suggestions.

I cannot connect my cell phone with the telephone base.

- Make sure that the Bluetooth function of your cell phone is turned on. See the user's manual of your cell phone for more information.
- Make sure that your Bluetooth cell phone is not connected to any other Bluetooth device.
- Turn off your cell phone, then turn it on again.
- Make sure that your cell phone is on the paired devices list.
- For some cell phones, you must authorize **TL86109** device in your cell phone's Bluetooth feature. See the user's manual of your cell phone for more information.

Troubleshooting

- Manually connect your cell phone to the **TL86109**. Refer to the user's manual of your cell phone for more information.

I cannot connect my headset with the telephone base.

- Make sure that your Bluetooth headset is not connected to any other Bluetooth device.
- Make sure that your headset is on the paired devices list.

I cannot put my headset in discoverable mode.

- Refer to the user's manual of your headset for information on how to set your headset to discoverable mode.
- Make sure that the headset is not connected to any other Bluetooth device in order to successfully pair and connect to the telephone base.
- Carefully follow the pairing process on page 16.
- Reset the telephone base. Unplug the unit's electrical power. Wait for approximately 15 seconds, then plug it back in. Repeat the above suggestions.

I don't know how to search for or add new devices on my cell phone.

- Most cell phones have the Bluetooth feature in the connection or setup menus. Please refer to the user's manual of your cell phone.
- In general, press the menu key on your cell phone, then look for the Bluetooth menu in the settings or connection menu. In the Bluetooth menu, select the option to search for or add new devices.

My cell phone disconnects with the telephone base.

- Turn off your cell phone, then turn it on again.
- Make sure that you are not using your cell phone when on a cell call.

My cell phone is connected to the telephone base, but I cannot make a cell call.

- Make sure that your cell phone is not in use when you are trying to make a cell call.
- For some smartphones, make sure that the cellular function is turned on.

Bluetooth system busy appears on the display.

- Make sure that your cell phone is not in use when connected and on the active devices list.
- Make sure that your cell phone or headset is not connected to any other Bluetooth device.
- **TL86109** can only use one Bluetooth device at a time.

Troubleshooting

The PIN on the telephone base does not work.

- The default PIN is **0000**.
- If you have changed the PIN, it will appear on the handset in the pairing process.

I cannot hear any audio on my telephone system when on a cell call.

- Reset the telephone base. Unplug the unit's electrical power. Wait for approximately 15 seconds, then plug it back in.
- Turn off your cell phone, then turn it on again.

I cannot download contacts from my cell phone to my TL86109.

- Make sure that your cell phone is paired and connected to the base.
- Make sure you place your cell phone next to the base while downloading.

I see duplicate entries in my downloaded directory

- If you see duplicate directory entries, you can delete them manually. Another option is to download again either your SIM card or phone memory, but not both.

Some of my cell phone contacts were not imported to my TL86109.

- Make sure to try copying the contacts from your SIM card to your cell phone memory first, then download from your phone memory. If that doesn't work, try copying the contacts from your cell phone memory to your SIM card, then download from your SIM card. For more information on how to transfer contacts between your SIM card and your phone memory, refer to the user's manual of your cell phone.

Can the TL86109 help the poor cell phone reception in my house?

- If your cell phone has poor reception in your home, the **TL86109** cannot improve the reception. However, if you have a location in your house with better reception, you can leave your cell phone in that location while you use **TL86109** cell line. In order for this to work, the cell phone must be within 15 feet of the telephone base for optimal performance.

Troubleshooting

The listening volume of my cell call is too loud or quiet.

- During a cell call, if the listening volume is too loud or quiet, try changing the volume on your cell phone. On some cell phones, changing the volume on the cell phone affects your cell call volume on the **TL86109** handset.

My phone doesn't work at all.

- Make sure the power cord is securely plugged in.
- Make sure that the battery connector is securely plugged into the cordless handset.
- Make sure the telephone line cord is securely and firmly plugged into the telephone cord line and the telephone wall jack.
- Charge the battery in the cordless handset for at least 16 hours. For optimum daily performance, return the cordless handset to the telephone base or charger when not in use.
- If the battery is depleted, it may take approximately ten minutes to charge the handset before it shows **Low battery**, refer to page 11 for details.
- Reset the telephone base. Unplug the electrical power. Wait for approximately 15 seconds, then plug it back in. Allow up to one minute for the cordless handset and telephone base to reset.
- You may need to purchase a new battery. Please refer to **Battery installation and charging** (pages 10-11) in this user's manual.

I cannot get a dial tone.

- First try all the suggestions above.
- Move the cordless handset closer to the telephone base. You might have moved out of range.
- If the previous suggestions don't work, disconnect the telephone base from the telephone jack and connect to a different phone. If there is no dial tone on that phone either, the problem is in your wiring or local service. Contact your telephone service provider.
- Your line cord might be malfunctioning. Try installing a new line cord.

Troubleshooting

I cannot dial out.

- First try all the suggestions in **I cannot get a dial tone** above.
- Make sure you have a dial tone before dialing. The cordless handset may take a second or two to find the telephone base and produce a dial tone. This is normal. Wait an extra second before dialing.
- Eliminate any background noise. Noise from a television, radio or other appliances may cause the phone to not dial out properly. If you cannot eliminate the background noise, first try muting the cordless handset before dialing, or dialing from another room in your home with less background noise.
- If the other phones in your home are having the same problem, the problem is in your wiring or local service. Contact your telephone service provider (charges may apply).

My cordless handset isn't performing normally.

- Make sure the power cord is securely plugged into the telephone base. Plug the power adapter into a different, working electrical outlet not controlled by a wall switch.
- Move the cordless handset closer to the telephone base. You might have moved out of range.
- Reset the telephone base. Unplug the electrical power. Wait for 15 seconds then plug it back in. Allow up to one minute for the cordless handset and telephone base to reset.
- Other electronic products can cause interference to your cordless phone. Try installing your phone as far away from these types of electronic devices as possible: television sets, VCRs, or other cordless telephones.

The handset registration is unsuccessful.

Follow the steps below to re-register the handset.

1. Make sure the handset is out of the telephone base or charger and shows **NOT REGISTERED** before you begin registration.
2. Press **HOLD** for about four seconds (until the red **IN USE** light on the telephone base is on) and then release the button.
3. Place the unregistered handset into telephone base or charger.

Refer to the **Add and register a handset** section on page 120 for details.

Troubleshooting

Out of range OR No power at base appears on my cordless handset.

- Ensure that the telephone base is powered up.
- Place the cordless handset in the telephone base for one minute to allow the cordless handset and base to synchronize.
- Move the cordless handset closer to the telephone base. You might have moved out of range.
- Reset the telephone base. Unplug the electrical power. Wait for 15 seconds then plug it back in. Allow up to one minute for the cordless handset and telephone base to reset.
- Other electronic products can cause interference with your cordless phone. Try installing your phone as far away from these types of electronic devices as possible: television sets, VCRs, or other cordless telephones.

The batteries do not hold a charge.

- If the cordless handset is in the telephone base or charger and the charge light does not come on, refer to **The charge light is off** (page 130) in this **Troubleshooting** guide.
- Charge the battery in the cordless handset for at least 16 hours. For optimum daily performance, return the cordless handset to the telephone base or charger when not in use.
- If the battery is depleted, it may take approximately ten minutes to charge the handset before it shows **Low battery**, refer to page 11 for details.
- You may need to purchase a new battery. Please refer to **Battery installation and charging** (pages 10-11) in this user's manual.

I get noise, static, or a weak signal even when I'm near the telephone base.

- If you subscribe to high-speed Internet service (digital subscriber line - DSL) through your telephone lines, you must install a DSL filter between the telephone line cord and the telephone wall jack (see page 6). The filter prevents noise and caller ID problems caused by DSL interference. Please contact your DSL service provider for more information about DSL filters.
- You may be able to improve the performance of your cordless phone by installing your new telephone base as far as possible from any other existing cordless telephone system that may already be installed.
- Other electronic products can cause interference to your cordless phone. Try installing your phone as far away from the following electronic devices as possible: television sets, VCRs, or other cordless telephones.
- Do not install this phone near a microwave oven or on the same electrical outlet. You may experience decreased performance while the microwave oven is operating.

Troubleshooting

- If your phone is plugged in with a modem or a surge protector, plug the phone (or modem/surge protector) into a different location. If this doesn't solve the problem, relocate your phone or modem farther apart from one another, or use a different surge protector.
- Relocate your phone to a higher location. The phone may have better reception when installed in a high area.
- If the other phones in your home are having the same problem, the problem is in your wiring or local service. Contact your telephone service provider (charges may apply).

I experience poor sound quality when using the speakerphone.

- For increased sound quality while using the speakerphone, place the handset on a flat surface with the dial pad facing up.
- When using a speakerphone, controlling background noise in your environment is essential. While you are listening to your party, press the **MUTE** softkey to temporarily turn your microphone off. When it is your turn to speak, remember to press **DELETE/MUTE** again to turn the microphone on.
- Excessive background noise will cause a speakerphone to fade in and out. Try controlling the background noise by turning off any audio devices near the speakerphone. Also, try to avoid interrupting the person at the other end of the conversation while they are speaking. If background noise cannot be controlled, you should terminate speakerphone operation and return to normal handset mode.

I hear other calls while using my phone.

- Disconnect the telephone base from the telephone jack, and plug in a different telephone. If you still hear other calls, the problem is probably in your wiring or local service. Call your telephone service provider.

While on a call or playing messages, there is too much noise, or the voice sounds tinny, shrill or flat.

- While on a call or playing messages, press the **EQ**  button on the side of the handset until you find the settings that sounds best (page 68).

Troubleshooting

My cordless handset does not ring when I receive a call.

- Make sure that the ringer is not turned off. Refer to **Ringer volume** on page 30 in this user's manual.
- Make sure the telephone line cord is plugged securely into the telephone base and the telephone jack. Make sure the power cord is securely plugged in.
- The cordless handset may be too far from the telephone base.
- Charge the battery in the cordless handset for at least 16 hours. For optimum daily performance, return the cordless handset to the telephone base or charger when not in use.
- You may have too many extension phones on your telephone line to allow all of them to ring simultaneously. Try unplugging some of the other phones.
- The layout of your home or office might be limiting the operating range. Try moving the telephone base to another location, preferably to a higher location.
- If the other phones in your home are having the same problem, the problem is in your wiring or local service. Contact your telephone service provider (charges may apply).
- Test a working phone at the phone jack. If another phone has the same problem, the problem is the phone jack. Contact your telephone service provider (charges may apply).
- Other electronic products can cause interference with your cordless phone. Try installing your phone as far away as possible from electronic devices such as wireless routers, or other cordless telephones.
- Re-install the battery, and place the cordless handset in the telephone base. Wait for the cordless handset to reestablish its connection with the telephone base. Allow up to one minute for this to take place.
- Your line cord might be malfunctioning. Try installing a new line cord.

Troubleshooting

My calls cut in and out while I'm using my cordless handset.

- Other electronic products can cause interference with your cordless phone. Try installing your phone as far away as possible from electronic devices such as wireless routers, or other cordless telephones.
- Do not install this phone near a microwave oven or on the same electrical outlet. You may experience decreased performance while the microwave oven is operating.
- If you plug your phone in with a modem or surge protector, plug the phone (or modem/surge protector) into a different location. If this doesn't solve the problem, relocate your phone or modem farther apart from one another, or use a different surge protector.
- Relocate your telephone base to a higher location. The phone may have better reception when installed in a high area.
- If the other phones in your home are having the same problem, the problem is in your wiring or local service. Contact your telephone service provider (charges may apply).
- Excessive background noise will cause a speakerphone to fade in and out. Try controlling the background noise by turning off any audio devices near the speakerphone. Also, try to avoid interrupting the person at the other end of the conversation while they are speaking. If background noise cannot be controlled, you should stop speakerphone operation and return to normal handset mode.
- When using a speakerphone, controlling background noise in your environment is essential. While you are listening to your party press the **MUTE** softkey to temporarily turn your microphone off. When it is your turn to speak, remember to press the **MUTE** softkey to turn the microphone on.

The charge light is off.

- Make sure the power and line cords are plugged in correctly and securely.
- Unplug the electrical power. Wait for 15 seconds, then plug it back in. Allow up to one minute for the cordless handset and telephone base to reset.
- Clean the cordless handset and telephone base charging contacts each month using a pencil eraser or cloth.

Troubleshooting

My caller ID isn't working.

- Caller ID is a subscription service. You must subscribe to this service from your telephone service provider for this feature to work on your phone.
- The caller must be calling from an area that supports caller ID.
- Both your and your caller's telephone service providers must use caller ID compatible equipment.
- If you subscribe to high-speed Internet service (digital subscriber line - DSL) through your telephone lines, you must install a DSL filter between the telephone line cord and the telephone wall jack (see page 8). The filter prevents noise and caller ID problems caused by DSL interference. Please contact your DSL service provider for more information about DSL filters.

System does not receive caller ID when on a call.

- Make sure you subscribe to caller ID with call waiting features provided by your telephone service provider. Caller ID features work only if both you and the caller are in areas offering caller ID service, and if both telephone companies use compatible equipment.

An icon and New voicemail show on the display and I don't know why.

- Your telephone has voicemail indication that is separate from the built-in answering system. If  appears on the display, then your telephone has received a signal from your telephone service provider that you have a voicemail message waiting for you to retrieve from your telephone service provider. Contact your telephone service provider for more information on how to access your voicemail.

I cannot retrieve voicemail messages.

- Your telephone has both a built-in answering system and voicemail indication. They are independent features and each alerts you to new messages differently (page 105). If you subscribe to voicemail service from your telephone service provider (charges may apply), contact your telephone service provider for more information on how to access your voicemail.

I am receiving incomplete messages.

- If a caller leaves a very long message, part of it may be lost when the system disconnects the call after four minutes.
- If the caller pauses for longer than seven seconds, the system stops recording and disconnects the call.
- If the system's memory becomes full during a message, the system stops recording and disconnects the call.
- If the caller's voice is very soft, the system may stop recording and disconnects the call.

Troubleshooting

I am having difficulty hearing messages.

- Press **VOLUME▲** to increase speaker volume on the telephone base.
- Press **VOLUME▲** to increase the listening volume on a handset.

System does not answer after correct number of rings.

- Make sure the answering system is on. When the answering system is on, **ANS ON** should show on the handset and the **ON/OFF LINE 1** or **ON/OFF LINE 2** light is lit on the telephone base (page 51).
- If toll saver is selected, the number of rings changes to two when there are new messages waiting (page 55).
- If the memory is full or the system is off, the system answers after 10 rings.
- In some cases, the answering system is affected by the ringing system used by the telephone service provider.
- If you subscribe to voicemail service, change the number of rings so that your answering system answers before your voicemail answers (page 105). To determine how many rings activate your voicemail, please contact your telephone service provider.
- If there is a fax machine connected to the same telephone line, try disconnecting the fax machine. If that solves the problem, consult your fax machine documentation for information on compatibility with answering systems.

The answering system announces “Time and day not set.”

- You need to set the date and time (page 34).

System does not respond to remote commands.

- Make sure to enter your remote access code correctly (page 112).
- Make sure you are calling from a touch-tone phone. When you dial a number, you should hear tones. If you hear clicks, the phone is not a touch-tone telephone and cannot activate the answering system.
- The answering system may not detect the remote access code while your announcement is playing. Try waiting until the announcement is over before entering the code.
- There may be interference on the phone line you are using. Press the dial pad keys firmly.

Troubleshooting

The answering system does not record messages.

- Make sure the answering system is on (page 51).
- Make sure the memory of the answering system is not full. When the answering machine memory is full, it does not record new messages until some old messages are deleted.
- If you subscribe to voicemail service, change the number of rings so that your answering system answers before your voicemail answers (page 105). To determine how many rings activate your voicemail, please contact your telephone service provider.
- If there is a fax machine connected to the same telephone line, try disconnecting the fax machine. If that solves the problem, consult your fax machine documentation for information on compatibility with answering systems.

The outgoing announcement is not clear.

- When you record your announcement, make sure you speak in a normal tone of voice, about nine inches from the telephone base.
- Make sure there is no background noise (TV, music, etc.) while recording.

I subscribe to a nontraditional telephone service that uses my computer to establish connections, and my telephone doesn't work.

- Make sure your computer is powered on.
- Make sure your Internet connection is working properly.
- Make sure that the software is installed and running for your nontraditional telephone service.
- Make sure to plug your USB telephone adapter into a dedicated USB port on your computer. Do not plug into a multiple port USB hub (USB splitter) that is not powered.
- In a few rare instances, the USB port on your computer may not have enough power. In these instances, try using a USB hub with its own external power supply.
- If you are using a firewall, it may prevent access to your nontraditional telephone service provider. Contact your service provider for more information.

Troubleshooting

Common cure for electronic equipment:

If the telephone is not responding normally, try resetting the telephone. Do the following in the order listed:

1. Disconnect the power to the telephone base.
2. Disconnect the cordless handset battery, and spare battery, if applicable.
3. Wait a few minutes.
4. Connect power to the telephone base.
5. Re-install the battery, and place the cordless handset into the telephone base.
6. Wait for the cordless handset to reestablish its connection with the telephone base. Allow up to one minute for this to take place.

Maintenance

Taking care of your telephone

- Your cordless telephone contains sophisticated electronic parts, so it must be treated with care.
- Avoid rough treatment.
- Place the handset down gently.
- Save the original packing materials to protect your telephone if you ever need to ship it.

Avoid water

- Your telephone can be damaged if it gets wet. Do not use the handset in the rain, or handle it with wet hands. Do not install the telephone base near a sink, bathtub or shower.

Electrical storms

- Electrical storms can sometimes cause power surges harmful to electronic equipment. For your own safety, take caution when using electric appliances during storms.

Cleaning your telephone

- Your telephone has a durable plastic casing that should retain its luster for many years. Clean it only with a soft cloth slightly dampened with water or a mild soap.
- Do not use excess water or cleaning solvents of any kind.

Remember that electrical appliances can cause serious injury if used when you are wet or standing in water. If the telephone base should fall into water, DO NOT RETRIEVE IT UNTIL YOU UNPLUG THE POWER CORD AND TELEPHONE LINE CORDS FROM THE WALL. Then pull the telephone out by the unplugged cords.

Important safety information



This symbol is to alert you to important operating or servicing instructions that may appear in this user's manual. Always follow basic safety precautions when using this product to reduce the risk of injury, fire, or electric shock.

Safety information

- Read and understand all instructions in the user's manual. Observe all markings on the product.
- Avoid using a telephone during a thunderstorm. There might be a slight chance of electric shock from lightning.
- Do not use a telephone in the vicinity of a gas leak. If you suspect a gas leak, report it immediately, but use a telephone away from the area where gas is leaking. If this product is a cordless model, make sure the base is also away from the area.
- Do not use this product near water, or when you are wet. For example, do not use it in a wet basement or shower, or next to a swimming pool, bathtub, kitchen sink, or laundry tub. Do not use liquids or aerosol sprays for cleaning. If the product comes in contact with any liquids, unplug any line or power cord immediately. Do not plug the product back in until it has dried thoroughly.
- Install this product in a protected location where no one can trip over any line or power cords. Protect cords from damage or abrasion.
- If this product does not operate normally, read the **Troubleshooting** section on pages 122-134 of this user's manual. If you cannot solve the problem, or if the product is damaged, refer to the **Limited warranty** section on pages 140-141. Do not open this product except as may be directed in your user's manual. Opening the product or reassembling it incorrectly may expose you to hazardous voltages or other risks.
- Replace batteries only as described in your user's manual (pages 10-11). Do not burn or puncture batteries — they contain caustic chemicals.
- This power adapter is intended to be correctly oriented in a vertical or floor mount position. The prongs are not designed to hold the plug in place if it is plugged into a ceiling or an under-the-table/cabinet outlet.



CAUTION: Use only the power adapter provided with this product. To obtain a replacement, visit our website at **www.telephones.att.com**, or call **1 (800) 222-3111**.

In Canada, dial **1 (866) 288-4268**.

Especially about corded telephones

- Privacy: The same features that make a cordless telephone convenient create some limitations. Telephone calls are transmitted between the telephone base and the handset by radio waves, so there is a possibility that your cordless telephone conversations could be intercepted by radio receiving equipment within range of the cordless handset. For this reason, you should not think of cordless telephone conversations as being as private as those on corded telephones.
- Electrical power: The telephone base of this cordless telephone must be connected to a working electrical outlet which is not controlled by a wall switch. Calls cannot be made from the handset if the telephone base is unplugged, switched off or if the electrical power is interrupted.

Important safety information

- **Potential TV interference:** Some cordless telephones operate at frequencies that may cause interference to TVs and VCRs. To minimize or prevent such interference, do not place the telephone base of the cordless telephone near or on top of a TV or VCR. If interference is experienced, moving the cordless telephone farther away from the TV or VCR will often reduce or eliminate the interference.
- **Rechargeable batteries:** This product contains nickel-metal hydride rechargeable batteries. Exercise care in handling batteries in order not to create a short circuit with conductive material such as rings, bracelets, and keys. The battery or conductor may overheat and cause harm. Observe proper polarity between the battery and the battery charger.
- **Nickel-metal hydride rechargeable batteries:** Dispose of these batteries in a safe manner. Do not burn or puncture. Like other batteries of this type, if burned or punctured, they could release caustic material which could cause injury.



The RBRC™ Seal means that the manufacturer is voluntarily participating in an industry program to collect and recycle nickel-metal hydride rechargeable batteries when taken out of service within the United States. These batteries may be taken to a participating local retailer of replacement batteries or recycling center. Or you may call 1 (800) 8-BATTERY for locations accepting spent Ni-MH batteries.

Precautions for users of implanted cardiac pacemakers

Cardiac pacemakers (applies only to digital cordless telephones): Wireless Technology Research, LLC (WTR), an independent research entity, led a multidisciplinary evaluation of the interference between portable wireless telephones and implanted cardiac pacemakers. Supported by the U.S. Food and Drug Administration, WTR recommends to physicians that:

Pacemaker patients

- Should keep wireless telephones at least six inches from the pacemaker.
- Should NOT place wireless telephones directly over the pacemaker, such as in a breast pocket, when it is turned ON.
- Should use the wireless telephone at the ear opposite the pacemaker.

WTR's evaluation did not identify any risk to bystanders with pacemakers from other persons using wireless telephones.

Especially about telephone answering systems

Two-way recording: This unit does not sound warning beeps to inform the other party that the call is being recorded. To ensure that you are in compliance with any federal or state regulations regarding recording a telephone call, you should start the recording process and then inform the other party that you are recording the conversation.

SAVE THESE INSTRUCTIONS

FCC Part 68 and ACTA

This equipment complies with Part 68 of the FCC rules and with technical requirements adopted by the Administrative Council for Terminal Attachments (ACTA). The label on the back or bottom of this equipment contains, among other things, a product identifier in the format US:AAAEQ##TXXXX. This identifier must be provided to your telephone service provider upon request.

The plug and jack used to connect this equipment to premises wiring and the telephone network must comply with the applicable Part 68 rules and technical requirements adopted by ACTA. A compliant telephone cord and modular plug is provided with this product. It is designed to be connected to a compatible modular jack that is also compliant. An RJ11 jack should normally be used for connecting to a single line and an RJ14 jack for two lines. See Installation Instructions in the user's manual.

The Ringer Equivalence Number (REN) is used to determine how many devices you may connect to your telephone line and still have them ring when you are called. The REN for this product is encoded as the 6th and 7th characters following the US: in the product identifier (e.g., if ## is 03, the REN is 0.3). In most, but not all areas, the sum of all RENs should be five (5.0) or less. For more information, please contact your telephone service provider.

This equipment may not be used with Party Lines. If you have specially wired alarm dialing equipment connected to your telephone line, ensure the connection of this equipment does not disable your alarm equipment. If you have questions about what will disable the alarm equipment, consult your telephone service provider or a qualified installer.

If this equipment is malfunctioning, it must be unplugged from the modular jack until the problem has been corrected. Repairs to this telephone equipment can only be made by the manufacturer or its authorized agents. For repair procedures, follow the instructions outlined under the Limited Warranty.

If this equipment is causing harm to the telephone network, the telephone service provider may temporarily discontinue your telephone service. The telephone service provider is required to notify you before interrupting service. If advance notice is not practical, you will be notified as soon as possible. You will be given the opportunity to correct the problem and the telephone service provider is required to inform you of your right to file a complaint with the FCC. Your telephone service provider may make changes in its facilities, equipment, operation, or procedures that could affect the proper functioning of this product. The telephone service provider is required to notify you if such changes are planned.

If this product is equipped with a corded or cordless handset, it is hearing aid compatible.

If this product has memory dialing locations, you may choose to store emergency telephone numbers (e.g., police, fire, medical) in these locations. If you do store or test emergency numbers, please:

- Remain on the line and briefly explain the reason for the call before hanging up.
- Perform such activities in off-peak hours, such as early morning or late evening.

Industry Canada

Operation is subject to the following two conditions: (1) this device may not cause harmful interference, and (2) this device must accept any interference, including interference that may cause undesired operation.

The term "IC:" before the certification/registration number only signifies that the Industry Canada technical specifications were met.

The Ringer Equivalence Number (REN) for this terminal equipment is 0.7. The REN is an indication of the maximum number of devices allowed to be connected to a telephone interface. The termination on an interface may consist of any combination of devices subject only to the requirement that the sum of the RENs of all the devices does not exceed five.

This product meets the applicable Industry Canada technical specifications.

Appendix FCC Part 15

This equipment has been tested and found to comply with the requirements for a Class B digital device under Part 15 of the Federal Communications Commission (FCC) rules.

These requirements are intended to provide reasonable protection against harmful interference in a residential installation. This equipment generates, uses and can radiate radio frequency energy and, if not installed and used in accordance with the instructions, may cause harmful interference to radio communications. However, there is no guarantee that interference will not occur in a particular installation.

If this equipment does cause harmful interference to radio or television reception, which can be determined by turning the equipment off and on, the user is encouraged to try to correct the interference by one or more of the following measures:

- Reorient or relocate the receiving antenna.
- Increase the separation between the equipment and receiver.
- Connect the equipment into an outlet on a circuit different from that to which the receiver is connected.
- Consult the dealer or an experienced radio/TV technician for help.

Changes or modifications to this equipment not expressly approved by the party responsible for compliance could void the user's authority to operate the equipment.

This device complies with Part 15 of the FCC rules. Operation is subject to the following two conditions: (1) this device may not cause harmful interference, and (2) this device must accept any interference received, including interference that may cause undesired operation. Privacy of communications may not be ensured when using this telephone.

To ensure safety of users, the FCC has established criteria for the amount of radio frequency energy that can be safely absorbed by a user or bystander according to the intended usage of the product. This product has been tested and found to comply with the FCC criteria. The handset may be safely held against the ear of the user. The telephone base shall be installed and used such that parts of the user's body other than the hands are maintained at a distance of approximately 20cm (8 inches) or more.

This Class B digital apparatus complies with Canadian ICES-003.

For body worn operation, this handset has been tested and meets FCC RF exposure guidelines when used with an accessory that contains no metal and that positions the handset a minimum of (0mm) from the body.

Use of other accessories may not ensure compliance with FCC RF exposure guidelines.

Limited warranty

The AT&T brand is used under license - any repair, replacement or warranty service, and all questions about this product should be directed to: In the United States of America, call

1 (800) 222-3111 or visit **www.telephones.att.com**; in Canada, call **1 (866) 288-4268**.

1. What does this limited warranty cover?

The manufacturer of this AT&T-branded product warrants to the holder of a valid proof of purchase ("CONSUMER" or "you") that the product and all accessories provided in the sales package ("PRODUCT") are free from defects in material and workmanship, pursuant to the following terms and conditions, when installed and used normally and in accordance with the PRODUCT operating instructions. This limited warranty extends only to the CONSUMER for products purchased and used in the United States of America and Canada.

2. What will be done if the PRODUCT is not free from defects in materials and workmanship during the limited warranty period ("materially defective PRODUCT")?

During the limited warranty period, the manufacturer's authorized service representative repairs or replaces at the manufacturer's option, without charge, a materially defective PRODUCT. If the manufacturer repairs the PRODUCT, they may use new or refurbished replacement parts. If the manufacturer chooses to replace the PRODUCT, they may replace it with a new or refurbished PRODUCT of the same or similar design. The manufacturer retains the defective parts, modules, or equipment. Repair or replacement of the PRODUCT, at the manufacturer's option, is your exclusive remedy. The manufacturer returns the repaired or replacement products to you in working condition. You should expect the repair or replacement to take approximately 30 days.

3. How long is the limited warranty period?

The limited warranty period for the PRODUCT extends for ONE (1) YEAR from the date of purchase. If the manufacturer repairs or replaces a materially defective PRODUCT under the terms of this limited warranty, this limited warranty also applies to repaired or replacement PRODUCT for a period of either (a) 90 days from the date the repaired or replacement PRODUCT is shipped to you or (b) the time remaining on the original one-year limited warranty; whichever is longer.

4. What is not covered by this limited warranty?

This limited warranty does not cover:

- PRODUCT that has been subjected to misuse, accident, shipping or other physical damage, improper installation, abnormal operation or handling, neglect, inundation, fire, water, or other liquid intrusion; or
- PRODUCT that has been damaged due to repair, alteration, or modification by anyone other than an authorized service representative of the manufacturer; or
- PRODUCT to the extent that the problem experienced is caused by signal conditions, network reliability or cable or antenna systems; or
- PRODUCT to the extent that the problem is caused by use with non-AT&T accessories; or
- PRODUCT whose warranty/quality stickers, PRODUCT serial number plates or electronic serial numbers have been removed, altered or rendered illegible; or
- PRODUCT purchased, used, serviced, or shipped for repair from outside the United States of America or Canada, or used for commercial or institutional purposes (including but not limited to products used for rental purposes); or
- PRODUCT returned without a valid proof of purchase (see item 6 below); or
- Charges for installation or setup, adjustment of customer controls, and installation or repair of systems outside the unit.

Limited warranty

5. How do you get warranty service?

To obtain warranty service in the United States of America, visit

www.telephones.att.com or call **1 (800) 222-3111**; in Canada, please

dial **1 (866) 288-4268**. NOTE: Before calling for service, please review the user's manual. A check of the PRODUCT's controls and features might save you a service call.

Except as provided by applicable law, you assume the risk of loss or damage during transit and transportation and are responsible for delivery or handling charges incurred in the transport of the PRODUCT(s) to the service location. The manufacturer will return repaired or replaced PRODUCT under this limited warranty. Transportation, delivery or handling charges are prepaid. The manufacturer assumes no risk for damage or loss of the PRODUCT in transit. If the PRODUCT failure is not covered by this limited warranty, or proof of purchase does not meet the terms of this limited warranty, the manufacturer notifies you and requests that you authorize the cost of repair prior to any further repair activity. You must pay for the cost of repair and return shipping costs for the repair of products that are not covered by this limited warranty.

6. What must you return with the PRODUCT to get warranty service?

You must:

- a. Return the entire original package and contents including the PRODUCT to the service location along with a description of the malfunction or difficulty; and
- b. Include "valid proof of purchase" (sales receipt) identifying the PRODUCT purchased (PRODUCT model) and the date of purchase or receipt; and
- c. Provide your name, complete and correct mailing address, and telephone number.

7. Other limitations

This warranty is the complete and exclusive agreement between you and the manufacturer of this AT&T branded PRODUCT. It supersedes all other written or oral communications related to this PRODUCT. The manufacturer provides no other warranties for this PRODUCT. The warranty exclusively describes all of the manufacturer's responsibilities regarding the PRODUCT. There are no other express warranties. No one is authorized to make modifications to this limited warranty and you should not rely on any such modification.

State/Provincial Law Rights: This warranty gives you specific legal rights, and you might also have other rights that vary from state to state or province to province.

Limitations: Implied warranties, including those of fitness for a particular purpose and merchantability (an unwritten warranty that the PRODUCT is fit for ordinary use) are limited to one year from date of purchase. Some states/provinces do not allow limitations on how long an implied warranty lasts, so the above limitation might not apply to you. In no event shall the manufacturer be liable for any indirect, special, incidental, consequential, or similar damages (including, but not limited to lost profits or revenue, inability to use the PRODUCT or other associated equipment, the cost of substitute equipment, and claims by third parties) resulting from the use of this PRODUCT. Some states/provinces do not allow the exclusion or limitation of incidental or consequential damages, so the above limitation or exclusion might not apply to you.

Please retain your original sales receipt as proof of purchase.

Technical specifications

RF frequency band	1921.536MHz — 1928.448MHz
Channels	5
Operating temperature	32°F — 122°F 0°C — 50°C
Telephone base voltage (AC voltage, 60Hz)	96 — 129 Vrms
Telephone base voltage (AC adapter output)	6VDC @600mA
Handset voltage	2.4 — 3.2 VDC
Charger voltage (AC adapter output)	6VAC @300mA
Replacement battery	2.4V 750mAH
Operating time*	Talk time (handset): up to seven hours Talk time (speakerphone): up to five hours Standby: up to seven days

* Operating times varies depending on your actual use and the age of the battery.

DECT 6.0 digital technology

The AT&T DECT 6.0 products offer unsurpassed range performance and sound clarity. This is achieved through a unique antenna design and advances in noise-filtering technology. An independent laboratory has confirmed that AT&T DECT 6.0 products perform up to 45% better in range competitions. Now calls can be taken in the basement, backyard and garage with exceptional sound quality.

Telephone operating range

This cordless telephone operates within the maximum power allowed by the Federal Communications Commission (FCC). Even so, this handset and telephone base can communicate over only a certain distance — which can vary with the locations of the telephone base and handset, the weather, and the construction of your home or office.

Extended range and clarity

This telephone base comes with an antenna which gives much better clarity and covers a longer range than before.

Index

A

Active devices, 21
Add a cell phone, 15
Add a handset, 120, 126
Add a headset, 17
Add an active device, 24
Alert tones, 115, 116
Alphabetical search, 88
Answer a cell call, 61, 62
Answer a cell call while on a home call, 63
Answer a home call, 59
Answer an incoming call during an intercom call, 78
Answering system and voicemail, 105
Answering system settings, 51, 52, 53
Answer on/off, 52
Appendix, 113

B

Battery charging, 10
Battery installation, 10
Bluetooth glossary, 14
Bluetooth operation, 13
Bluetooth setup, 15

C

Caller ID, 96
Caller ID history, 97
Call intercept, 107
Call log, 97
Call log display screen messages, 104
Call screening, 107
Call waiting on the cell line, 62
Call waiting on the home line, 61, 62
Cell area code, 36, 44
Cell call, 61
Cell phone - download directory, 27
Chain dialing, 70
Change PIN (Bluetooth), 25
Charger installation, 9
Charging, 11
Clear voicemail indication, 31, 39

Clock, 10, 33, 41
Conference home and cell calls, 64
Connect an active device, 21
Create a new directory entry, 83

D

Date, 10, 33, 41
Delete a directory entry, 93
Delete all old messages, 109
Delete a message, 108
Delete announcement, 54
Delete a redial entry, 73
Delete from the call log, 103
Deregister handsets, 121
Dial a call log entry, 100
Dial a directory entry, 90, 91
Dial mode, 34, 42
Directory, 27, 82
Disconnect an active device, 21
Download directory, 27
DSL filter, 8

E

Edit a directory entry, 91
Edit the type of a directory entry, 93
End a cell call, 61, 62
End a home call, 59
End mute, 68
Equalizer, 69
Expand your telephone system, 120

F

Find handset, 75

G

Glossary, 14

H

Handset icons, 113, 114
Handset lights, 115
Handset ringer volume, 30, 37
Hold, 69
Home area code, 35, 43
Home directory, 82

Index

I

Icons, 113, 114
Important safety information, 136
Indicators, 115
Installation, 7
Intercom, 76, 77
Interruption to directory
 download, 29

K

Key tone, 32, 40

L

Language, 31, 38
Last number redial, 72
LCD Language, 31, 38
Lights, 115
Limited warranty, 140

M

Maintenance, 135
Make a cell call, 61, 62
Memory match, 98
Memos, 110
Message alert tone, 58
Message capacity, 106
Message playback, 108
Missed calls indicator, 97
Mute, 68

N

New message indicator, 106
Number of rings, 56

O

Operating range, 142

P

Paging, 75
Pair a cell phone, 15
Pair a headset, 17
Paired devices, 19
Phonebook (directory), 82
Predialing, 59

Q

Quick reference guide, 2, 3

R

Record announcement, 47, 48
Redial list, 72
Register a handset, 120, 126
Remote access code, 112
Remove a downloaded directory, 95
Remove an active device, 25
Remove a paired device, 20
Rename a paired device, 19
Repeat messages, 108
Replace a handset, 121
Replace an active device, 23
Review the active devices list, 21
Review the call log, 98
Review the directory, 87, 88
Review the redial list, 72
Ringer mute, 67
Ringer tone, 30, 38
Ringer volume, 30, 37

S

Safety information, 136
Save a call log entry to the
 directory, 101, 102
Save a redial entry to the
 directory, 73
Screen display messages, 117
Search for a contact, 88
Set date/time, 10, 33, 41
Share an outside call, 75
Silence the ringer, 67
Skip messages, 108
Stop messages, 108

T

Technical specifications, 142
Telephone base installation, 8
Telephone base ringer volume, 107
Telephone operating range, 142
Telephone operation, 59

Index

Telephone settings, 37, 38
Temporary tone dialing, 69
Time, 10, 33, 41
Toll saver, 56
Troubleshooting, 122
Turn on or off the answering
system, 52

U

Use a Bluetooth headset, 60
Using the home and cell lines
together, 66

V

View the directory download
information, 29
Voicemail, 31, 39, 105
Volume, 30, 37, 67, 107

W

Warranty, 140
Website, 34, 42

Remote access wallet card

The wallet card below lists the commands needed to control your answering system from any touch-tone telephone.

Cut along dotted line.



Call your telephone number, then enter your two-digit remote access code (preset to **19**).

Action	Remote command
Play all messages	1
Play new messages.....	2
Delete the message.....	3 (during message playback)
Delete all old messages	33
Repeat or go back.....	4
Stop.....	5
Help menu	*5
Skip the message	6
Record announcement	*7
Turn system on or off	0
End remote access call.....	8 (or hang up)

Fold here.

**TL86109 DECT 6.0 2-line cordless telephone/
answering system with BLUETOOTH® wireless technology**



Proud Sponsor

www.telephones.att.com

The *Bluetooth*[®] word mark and logos are owned by Bluetooth SIG, Inc. and any use of such marks by Advanced American Telephones and its parent, VTech Holdings Limited, is under license. VTech Holdings Limited is a member of Bluetooth SIG, Inc. Other trademarks and trade names are those of their respective owners.

© 2010 Advanced American Telephones. All Rights Reserved.
AT&T and the AT&T logo are trademarks of AT&T Intellectual Property licensed to
Advanced American Telephones, San Antonio, TX 78219.
Printed in China. Issue 0 AT&T 02/10.