

FCC PART 15.247



EMI MEASUREMENT AND TEST REPORT

For

VTech Telecommunications Ltd.

23/F Tai Ping Industrial Centre, Block 1, 57 Ting Kok Road, Tai Po, N.T., Hong Kong

FCC ID: EW780-5744-02

This Report Concerns: <input checked="" type="checkbox"/> Original Report	Equipment Type: Cordless Telephone Base Transceiver
Test Engineer: Snell Leong 	
Report No.: R0505252a(B)	
Report Date: 2005-06-08	
Reviewed By: Daniel Deng 	
Prepared By: Bay Area Compliance Laboratory Corporation (BACL) 230 Commercial Street Sunnyvale, CA 94085 Tel: (408) 732-9162 Fax: (408) 732 9164	

Note: The test report is specially limited to the above company and this particular sample only. It may not be duplicated without prior written consent of Bay Area Compliance Laboratory Corporation. This report **must not** be used by the client to claim product certification, approval, or endorsement by NVLAP, NIST or any agency of the US Government.

TABLE OF CONTENTS

GENERAL INFORMATION.....4

 PRODUCT DESCRIPTION FOR EQUIPMENT UNDER TEST (EUT)4

 OBJECTIVE4

 RELATED SUBMITTAL(S)/GRANT(S).....4

 TEST METHODOLOGY4

 TEST FACILITY4

SYSTEM TEST CONFIGURATION.....6

 JUSTIFICATION6

 EUT EXERCISE SOFTWARE6

 SPECIAL ACCESSORIES6

 SCHEMATICS / BLOCK DIAGRAM6

 EQUIPMENT MODIFICATIONS6

 LOCAL SUPPORT EQUIPMENT LIST.....6

 INTERFACE PORT AND CABLING6

 POWER SUPPLY INFORMATION.....6

 CONFIGURATION OF TEST SYSTEM7

 TEST SETUP BLOCK DIAGRAM.....7

§1.1307(B)(1) & §2.1091 - RF EXPOSURE.....8

§15.203 - ANTENNA REQUIREMENT.....9

 STANDARD APPLICABLE9

§15.207(A) - CONDUCTED EMISSIONS.....10

 MEASUREMENT UNCERTAINTY10

 EUT SETUP.....10

 SPECTRUM ANALYZER SETUP10

 TEST EQUIPMENT LIST AND DETAILS.....10

 TEST PROCEDURE10

 SUMMARY OF TEST RESULTS11

 CONDUCTED EMISSIONS TEST DATA11

 PLOT OF CONDUCTED EMISSIONS TEST DATA11

§2.1051 - SPURIOUS EMISSIONS AT ANTENNA TERMINALS.....14

 STANDARD APPLICABLE14

 EQUIPMENT LISTS14

 MEASUREMENT RESULT14

§15.205, §15.209 & §15.247 - SPURIOUS RADIATED EMISSION.....17

 MEASUREMENT UNCERTAINTY17

 EUT SETUP.....18

 SPECTRUM ANALYZER SETUP18

 TEST EQUIPMENT LIST AND DETAILS.....18

 TEST PROCEDURE19

 CORRECTED AMPLITUDE & MARGIN CALCULATION19

 ENVIRONMENTAL CONDITIONS19

 SUMMARY OF TEST RESULTS19

 RADIATED EMISSION TEST DATA @ 3 METERS20

§15.247(A)(2) – 6 DB BANDWIDTH24

 STANDARD APPLICABLE24

 MEASUREMENT PROCEDURE.....24

 EQUIPMENT LISTS24

 MEASUREMENT RESULT24

§15.247(B)(3) - PEAK OUTPUT POWER MEASUREMENT.....27

 STANDARD APPLICABLE27

 MEASUREMENT PROCEDURE.....27

EQUIPMENT LISTS	27
MEASUREMENT RESULT	27
§15.247(D) - 100 KHZ BANDWIDTH OF BAND EDGES	30
STANDARD APPLICABLE	30
MEASUREMENT PROCEDURE.....	30
EQUIPMENT LISTS	30
MEASUREMENT RESULT	30
§15.247(E) - PEAK POWER SPECTRAL DENSITY.....	32
STANDARD APPLICABLE	32
MEASUREMENT PROCEDURE.....	32
EQUIPMENT LISTS	32
MEASUREMENT RESULT	32

GENERAL INFORMATION

Product Description for Equipment Under Test (EUT)

The *VTech Telecommunications Ltd.*'s product, FCC ID: EW7-80-5744-02, or the "EUT" as referred to in this report is the base part of a Cordless Telephone, which measures approximately 150mmL x 120mm W x 70mm H. The EUT operates at the frequency range of 2401 – 2406.8 MHz, with the maximum conducted output power of 2.88dBm (1.94mW).

** The test data gathered are from a production sample, S/N:E2116004 , provided by the manufacturer.*

Objective

This type approval report is prepared on behalf of *VTech Telecommunications Ltd.* in accordance with Part 2, Subpart J, Part 15, Subparts A , B and C of the Federal Communication Commissions rules.

The objective is to determine compliance with FCC rules for Output Power, Antenna Requirements, 6 dB Bandwidth, power spectral density, 100 kHz Bandwidth of Band Edges Measurement, Spurious Emission, Conducted, Spurious Radiated Emission and RF exposure.

Related Submittal(s)/Grant(s)

No Related Submittals.

Test Methodology

All measurements contained in this report were conducted with ANSI C63.4-2003, American National Standard for Methods of Measurement of Radio-Noise Emissions from Low-Voltage Electrical and Electronic Equipment in the range of 9 kHz to 40 GHz.

All radiated and conducted emissions measurement was performed at Bay Area Compliance Laboratory, Corp. The radiated testing was performed at an antenna-to-EUT distance of 3 meters.

Test Facility

The Open Area Test site used by BACL to collect radiated and conducted emission measurement data is located in the back parking lot of the building at 230 Commercial Street, Sunnyvale, California, USA.

Test site at BACL has been fully described in reports submitted to the Federal Communication Commission (FCC) and Voluntary Control Council for Interference (VCCI). The details of these reports has been found to be in compliance with the requirements of Section 2.948 of the FCC Rules on February 11 and December 10, 1997 and Article 8 of the VCCI regulations on December 25, 1997. The facility also complies with the radiated and AC line conducted test site criteria set forth in ANSI C63.4-2003.

The Federal Communications Commission and Voluntary Control Council for Interference has the reports on file and is listed under FCC file 31040/SIT 1300F2 and VCCI Registration No.: C-1298 and R-1234. The test site has been approved by the FCC and VCCI for public use and is listed in the FCC Public Access Link (PAL) database.

Additionally, BACL is a National Institute of Standards and Technology (NIST) accredited laboratory, under the National Voluntary Laboratory Accredited Program (Lab Code 200167-0). The current scope of accreditations can be found at <http://ts.nist.gov/ts/hdocs/210/214/scopes/2001670.htm>

SYSTEM TEST CONFIGURATION

Justification

The host system was configured for testing according to ANSI C63.4-2003.

The EUT was tested in the normal (native) operating mode to represent *worst*-case results during the final qualification test.

EUT Exercise Software

The EUT exercise program used during radiated and conducted testing was designed to exercise the system components.

Once loaded, set the Tx channel to low, mid and high for testing.

Special Accessories

As shown in following test block diagram, all interface cables used for compliance testing are shielded.

Schematics / Block Diagram

Please refer to Appendix A.

Equipment Modifications

No modifications were made to the EUT.

Local Support Equipment List

Manufacturer	Description	Model No.	Serial No.	Calibration Date
Teltone	Line Simulator	TLS-3B-01	80071	80071
Southern Telecom	Phone	N/A	N/A	N/A

Interface Port and Cabling

Manufacturer	Length (M)	From	To
Phone Line	1.0	Line 1 Port / Line Simulator	Phone
Phone Line	1.0	Line 2 Port / Line Simulator	EUT

Power Supply Information

Manufacturer	Description	Model No.	Serial No.	Calibration Date
Component Telephone	AC Adapter	U090030D1201	N/A	N/A

Configuration of Test System

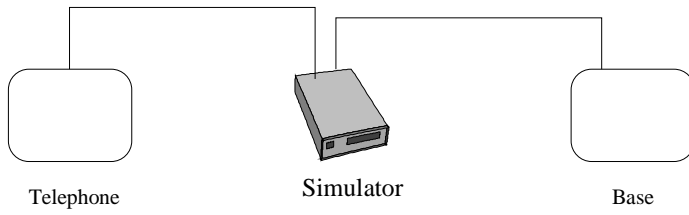

Test Setup Block Diagram

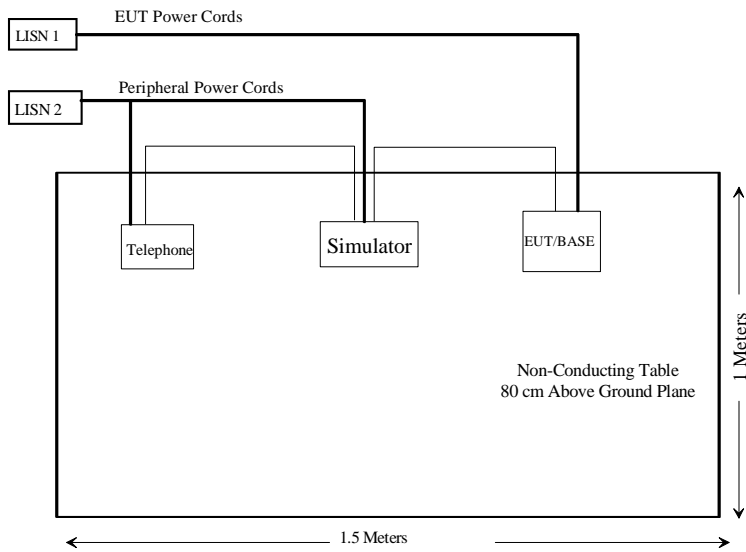

§1.1307(b)(1) & §2.1091 - RF EXPOSURE

According to §15.247(b)(5) and §1.1307(b)(1), systems operating under the provisions of this section shall be operated in a manner that ensures that the public is not exposed to radio frequency energy level in excess of the Commission's guidelines.

According to §1.1310 and §2.1091 RF exposure is calculated.

Limits for General Population/Uncontrolled Exposure

Frequency Range (MHz)	Electric Field Strength (V/m)	Magnetic Field Strength (A/m)	Power Density (mW/cm ²)	Averaging Time (minute)
Limits for General Population/Uncontrolled Exposure				
0.3-1.34	614	1.63	*(100)	30
1.34-30	824/f	2.19/f	*(180/f ²)	30
30-300	27.5	0.073	0.2	30
300-1500	/	/	f/1500	30
1500-100,000	/	/	1.0	30

f = frequency in MHz

* = Plane-wave equivalent power density

MPE Prediction

Predication of MPE limit at a given distance

Equation from page 18 of OET Bulletin 65, Edition 97-01

$$S = PG/4\pi R^2$$

Where: S = power density

P = power input to antenna

G = power gain of the antenna in the direction of interest relative to an isotropic radiator

R = distance to the center of radiation of the antenna

Maximum peak output power at antenna input terminal: 2.88 (dBm)

Maximum peak output power at antenna input terminal: 1.94 (mW)

Prediction distance: 20 (cm)

Predication frequency: 2400 (MHz)

Antenna Gain (typical): -1 (dBi)

antenna gain: 0.79 (numeric)

Power density at predication frequency at 20 cm: 0.0003(mW/cm²)

MPE limit for uncontrolled exposure at prediction frequency: 1.0 (mW/cm²)

Test Result

The EUT is a mobile device. The power density level at 20 cm is 0.0003 mW/cm², which is below the uncontrolled exposure limit of 1.0mW/cm² at 2400 MHz.

§15.203 - ANTENNA REQUIREMENT

Standard Applicable

According to § 15.203, an intentional radiator shall be designed to ensure that no antenna other than that furnished by the responsible party shall be used with the device.

And according to § 15.247 (b) (4), if transmitting antennas of directional gain greater than 6 dBi are used the power shall be reduced by the amount in dB that the directional gain of the antenna exceeds 6 dBi.

The antenna for this device is an integral antenna with gain of -1dBi.

§15.207(a) - CONDUCTED EMISSIONS

Measurement Uncertainty

All measurements involve certain levels of uncertainties. The factors contributing to uncertainties are spectrum analyzer, cable loss, and LISN.

Based on NIS 81, The Treatment of Uncertainty in EMC Measurements, the best estimate of the uncertainty of any conducted emissions measurement at BACL is ± 2.4 dB.

EUT Setup

The measurement was performed in the shield room, using the same setup per ANSI C63.4-2003 measurement procedure. The specification used was FCC 15 Subpart B limits.

The spacing between the peripherals was 10 centimeters.

External I/O cables were draped along the edge of the test table and bundle when necessary.

Spectrum Analyzer Setup

The EMI test receiver was set to investigate the spectrum from 150 kHz to 30MHz.

Test Equipment List and Details

Manufacturer	Description	Model	Serial Number	Cal. Date
Rohde & Schwarz	LISN	ESH2-Z5	871884/039	2004-08-16
Rohde & Schwarz	EMI Test Receiver	ESCS30	100176	2004-09-15
Fluke	Calibrated Voltmeter	189	18485-38	2004-07-18

* **Statement of Traceability:** BACL attests that all calibrations have been performed per the NVLAP requirements, traceable to NIST.

Test Procedure

During the conducted emission test, the power cord of the host system was connected to the mains outlet of the LISN-1.

Maximizing procedure was performed on the six (6) highest emissions of each modes tested to ensure EUT is compliant with all installation combination.

All data was recorded in the peak detection mode. Quasi-peak readings were only performed when an emission was found to be marginal (within -4 dB of specification limits). Quasi-peak readings are distinguished with a "Qp".

Summary of Test Results

According to the recorded data in following table, the EUT complies with the FCC Conducted margin for a Class B device, with the *worst* margin reading of:

-25.8 dB at 0.150 MHz in the Line mode

Environmental Conditions

Temperature:	23° C
Relative Humidity:	56%
ATM Pressure:	1020mbar

The testing was performed by Snell Leong on 2005-05-26.

Conducted Emissions Test Data

LINE CONDUCTED EMISSIONS				FCC PART 15 CLASS B	
Frequency MHz	Amplitude dB μ V	Detector Qp/Ave/Peak	Phase Line/Neutral	Limit dB μ V	Margin dB
0.150	40.2	QP	Line	66.00	-25.8
21.500	23.2	Ave	Neutral	50.00	-26.8
21.500	22.2	Ave	Line	50.00	-27.8
13.300	22.1	Ave	Neutral	50.00	-27.9
0.150	38.0	QP	Neutral	66.00	-28.0
17.900	16.0	Ave	Line	50.00	-34.0
21.500	23.5	QP	Line	60.00	-36.5
21.500	22.3	QP	Neutral	60.00	-37.7
13.300	22.2	QP	Neutral	60.00	-37.8
17.900	16.2	QP	Line	60.00	-43.8
0.150	12.1	Ave	Neutral	56.00	-43.9
0.150	11.7	Ave	Line	56.00	-44.3

Plot of Conducted Emissions Test Data

Plot(s) of Conducted Emissions Test Data is presented hereinafter as reference.

Bay Area Compliance Laboratory Corp Class B

26. May 05 16:58

EUT: 900/2400 MHz Cordless Phone
Manuf: VTech ER116 M/B
Op Cond: Normal
Operator: SNELL
Comment: N
120 V

*76 / May / 05
Snell*

Scan Settings (3 Ranges)

Frequencies			Receiver Settings				
Start	Stop	Step	IF BW	Detector	M-Time	Atten	Preamp
180k	1M	5k	9k	QP+AV	20ms	18dB LN	OFF
1M	5M	10k	9k	QP+AV	1ms	18dB LN	OFF
5M	30M	100k	9k	QP+AV	1ms	18dB LN	OFF

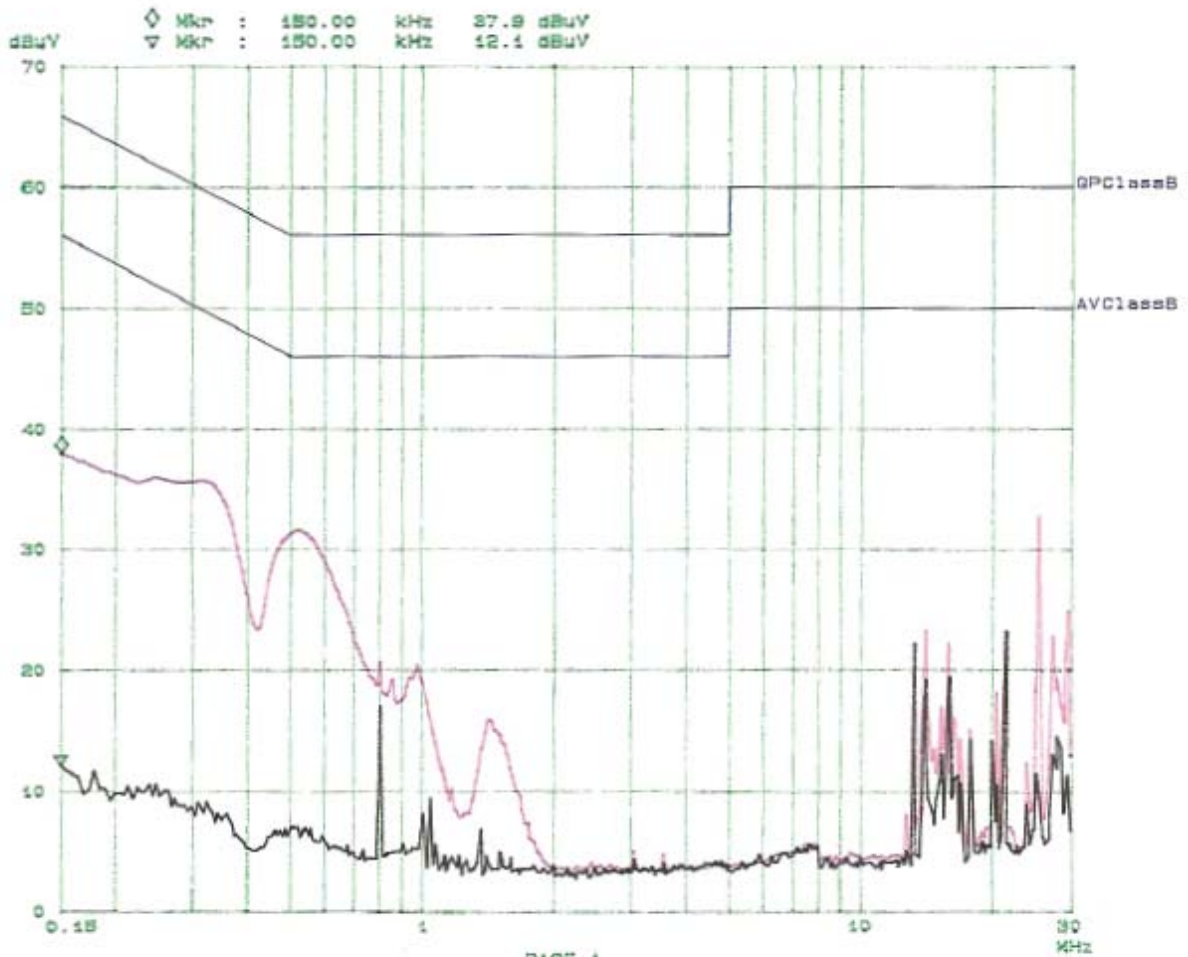

Bay Area Compliance Laboratory Corp Class B

20. May 05 16:38

*761 May 05
Snell*

EUT: 900/2400 MHz Cordless Phone
Manuf: VTech E2116 M/B
Op Cond: Normal
Operator: SNELL
Comment: L
120 V

Scan Settings (3 Ranges)

Frequencies			Receiver Settings					
Start	Stop	Step	IF BW	Detector	M-Time	Atten	Preampl	
150k	1M	5k	9k	QP+AV	20ms	15dB LN	OFF	
1M	5M	10k	9k	QP+AV	1ms	15dB LN	OFF	
5M	30M	100k	9k	QP+AV	1ms	15dB LN	OFF	

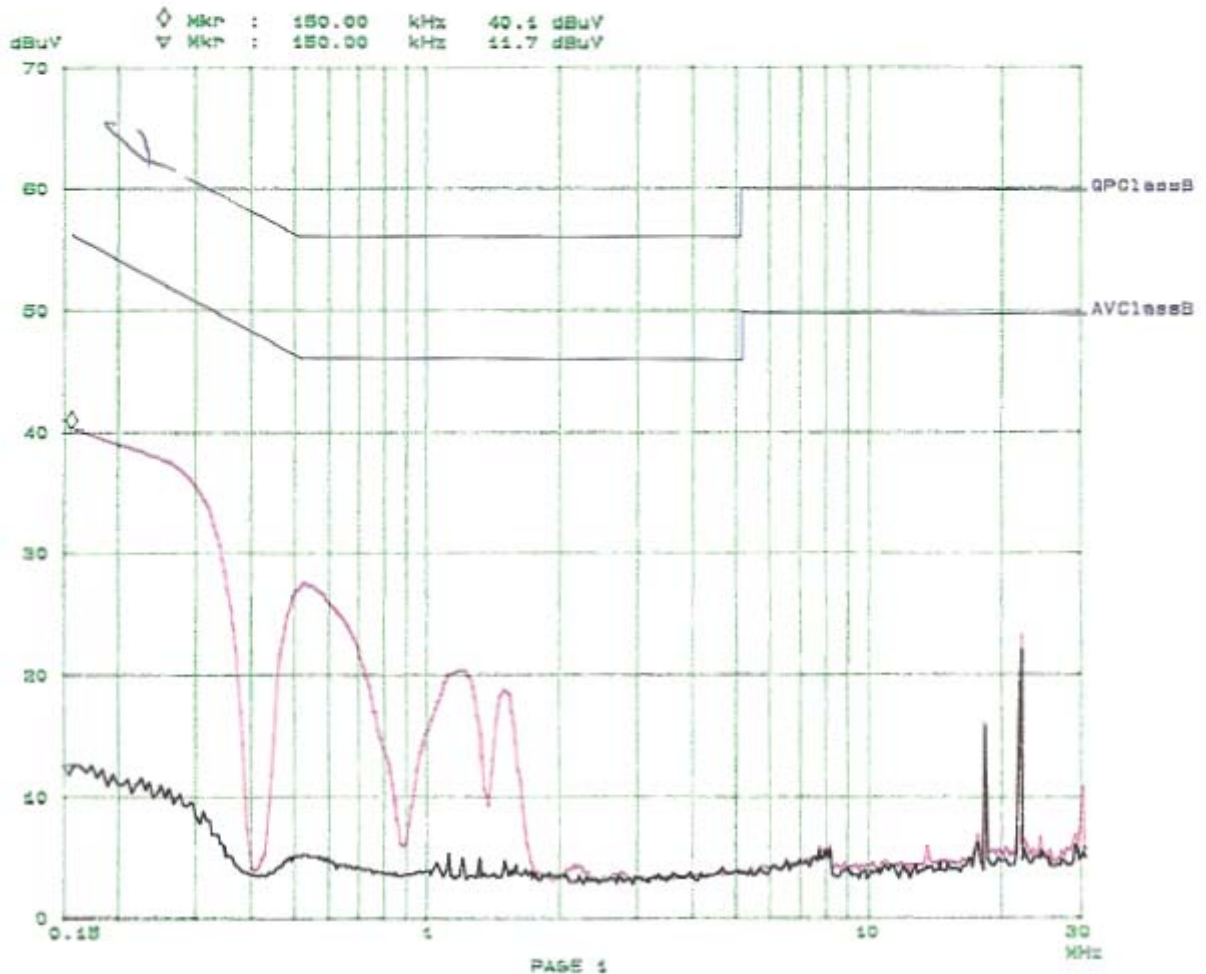

§2.1051 - SPURIOUS EMISSIONS AT ANTENNA TERMINALS

Standard Applicable

Requirements: CFR 47, § 2.1051.

The spectrum was to be investigated to the tenth harmonics of the highest fundamental frequency as specified in § 2.1057.

Measurement Procedure

The RF output of the EUT was connected to a spectrum analyzer through appropriate attenuation. The resolution bandwidth of the spectrum analyzer was set at 100 kHz. Sufficient scans were taken to show any out of band emissions up to 10th harmonic.

Equipment Lists

Manufacturer	Description	Model	Serial Number	Cal. Date
Agilent	Analyzer, Spectrum	E4446A	US44300386	11/10/2004

* **Statement of Traceability: BA CL Corp.** attests that all calibrations have been performed per the NVLAP requirements, traceable to the NIST.

Measurement Result

Please refer to following pages for plots of spurious emission.

Environmental Conditions

Temperature:	25° C
Relative Humidity:	66%
ATM Pressure:	1024 mbar

**The testing was performed by Snell Leong on 2005-05-31.*

Low Channel

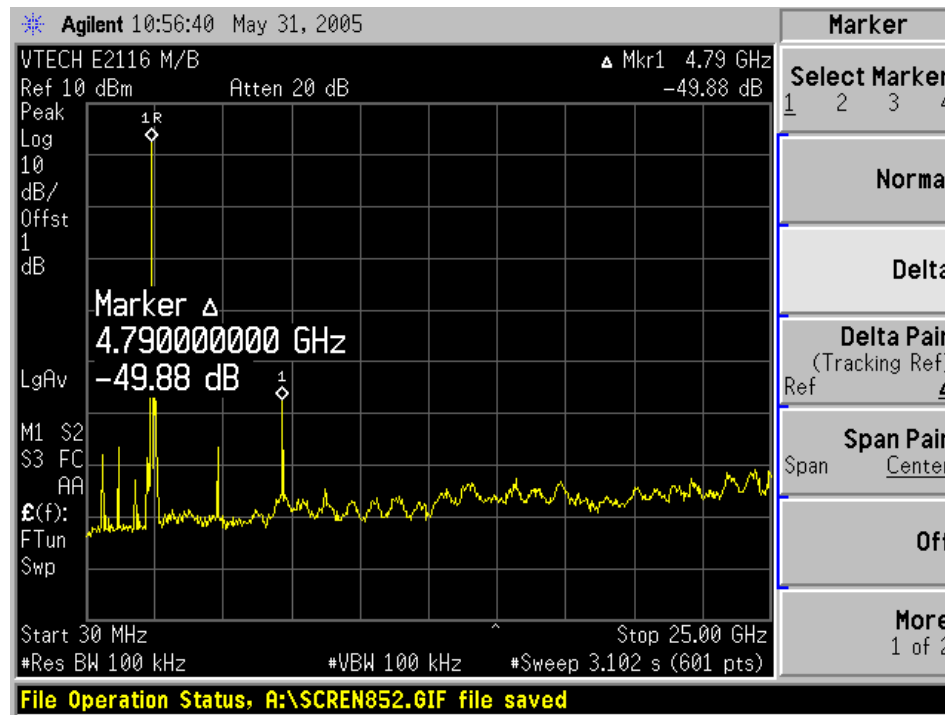

Mid Channel

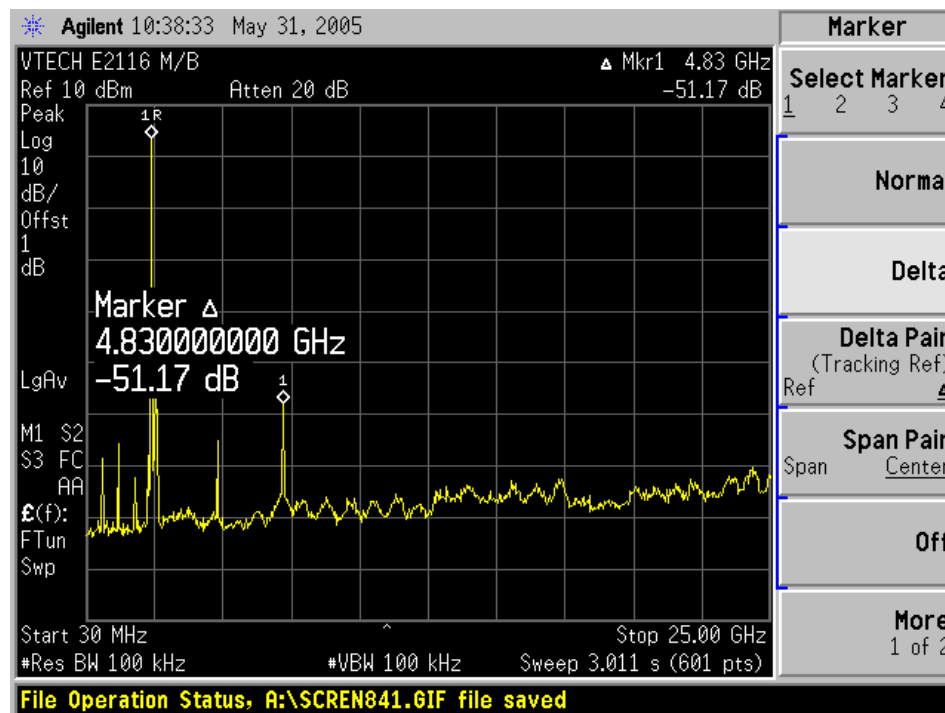

High Channel

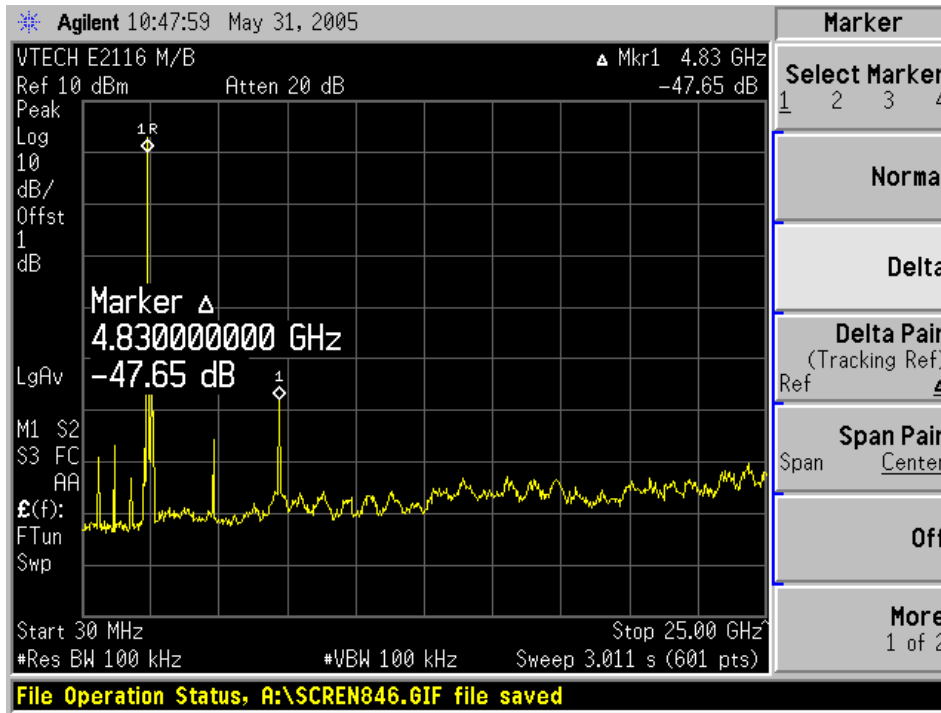

§15.205, §15.209 & §15.247 - SPURIOUS RADIATED EMISSION

Measurement Uncertainty

All measurements involve certain levels of uncertainties. The factors contributing to uncertainties are spectrum analyzer, cable loss, antenna factor calibration, antenna directivity, antenna factor variation with height, antenna phase center variation, antenna factor frequency interpolation, measurement distance variation, site imperfections, mismatch (average), and system repeatability.

Based on NIS 81, The Treatment of Uncertainty in EMC Measurements, the best estimate of the uncertainty of a radiation emissions measurement at BACL is ± 4.0 dB.

According to §15.205, except as shown in paragraph (d) of this section, only spurious emissions are permitted in any of the frequency bands listed below:

MHz	MHz	MHz	GHz
0.090 – 0.110	16.42 – 16.423	399.9 – 410	4.5 – 5.15
¹ 0.495 – 0.505	16.69475 – 16.69525	608 – 614	5.35 – 5.46
2.1735 – 2.1905	16.80425 – 16.80475	960 – 1240	7.25 – 7.75
4.125 – 4.128	25.5 – 25.67	1300 – 1427	8.025 – 8.5
4.17725 – 4.17775	37.5 – 38.25	1435 – 1626.5	9.0 – 9.2
4.20725 – 4.20775	73 – 74.6	1645.5 – 1646.5	9.3 – 9.5
6.215 – 6.218	74.8 – 75.2	1660 – 1710	10.6 – 12.7
6.26775 – 6.26825	108 – 121.94	1718.8 – 1722.2	13.25 – 13.4
6.31175 – 6.31225	123 – 138	2200 – 2300	14.47 – 14.5
8.291 – 8.294	149.9 – 150.05	2310 – 2390	15.35 – 16.2
8.362 – 8.366	156.52475 – 156.52525	2483.5 – 2500	17.7 – 21.4
8.37625 – 8.38675	156.7 – 156.9	2655 – 2900	22.01 – 23.12
8.41425 – 8.41475	162.0125 – 167.17	3260 – 3267	23.6 – 24.0
12.29 – 12.293	167.72 – 173.2	3332 – 3339	31.2 – 31.8
12.51975 – 12.57725	240 – 285	3345.8 – 3358	36.43 – 36.5
13.36 – 13.41	322 – 335.4	3600 – 4400	(²)

¹ Until February 1, 1999, this restricted band shall be 0.490-0.510MHz

² Above 38.6

Except as provided in paragraph (d) and (e), the filed strength of emissions appearing within these frequency bands shall not exceed the limits shown in Section 15.209. At frequencies equal to or less than 1000MHz, compliance with the limits in Section 15.209 shall be demonstrated using measurement instrumentation employing a CISPR quasi-peak detector. Above 1000MHz, compliance with the emission limits in Section 15.209 shall be demonstrated based on the average value of the measured emissions. The provisions in Section 15.35 apply to these measurements.

According to §15.209, the device shall meet radiated emission general requirements.

Except for Class A device, the filed strength of radiated emissions from unintentional radiators at a distance of 3 meters shall not exceed the following values:

Frequency of Emission (MHz)	Field Strength	
	(Microvolts/meter)	(dB μ V/meter)
30 - 88	100	40
88 - 216	150	43.5
216 - 960	200	46
Above 960	500	54

EUT Setup

The radiated emission tests were performed in the open area 3-meter test site, using the setup accordance with the ANSI C63.4-2003. The specification used was the FCC 15.209 limits.

The spacing between the peripherals was 10 centimeters.

External I/O cables were draped along the edge of the test table and bundle when necessary.

The EUT was connected to the power adapter which is connected with 120Vac/60Hz power source.

Spectrum Analyzer Setup

According to FCC Rules, 47 CFR, Section 15.33, the frequency was investigated from 30 to 25000 MHz.

During the radiated emission test, the spectrum analyzer was set with the following configurations:

<i><u>Frequency Range</u></i>	<i><u>RBW</u></i>	<i><u>Video B/W</u></i>
Below 30MHz	10kHz	10kHz
30 – 1000MHz	100kHz	100kHz
Above 1000MHz	1MHz	1MHz

For Average measurement: RBW = 1MHz, VBW = 10Hz (above 1000MHz)

Test Equipment List and Details

Manufacturer	Description	Model	Serial Number	Cal. Date
HP	Amplifier, Pre, microwave	8447D	2944A10198	2004-08-20
HP	Amplifier, Pre,	8449B	3147A00400	2004-06-14
Agilent	Analyzer, Spectrum	E4446A	US44300386	2004-11-10
ETS	Antenna, Biconical	3110B	9603-2315	2004-12-14
A. H. Systems	Antenna, Horn, Std	ARH-2823-02	10555-02	2004-12-13
EMCO	Antenna, logperiodic	3148	4-1155	2004-12-14

* **Statement of Traceability: BACL Corp.** attests that all calibrations have been performed per the NVLAP requirements, traceable to the NIST.

Test Procedure

For the radiated emissions test, the EUT, and all support equipment power cords was connected to the AC floor outlet.

Maximizing procedure was performed on the highest emissions to ensure that the EUT complied with all installation combinations.

All data was recorded in the peak detection mode. Quasi-peak readings performed only when an emission was found to be marginal (within -4 dB of specification limits), and are distinguished with a "Qp" in the data table.

Corrected Amplitude & Margin Calculation

The Corrected Amplitude is calculated by adding the Antenna Factor and Cable Factor, and subtracting the Amplifier Gain from the Amplitude reading. The basic equation is as follows:

$$\text{Corr. Ampl.} = \text{Indicated Reading} + \text{Antenna Factor} + \text{Cable Factor} - \text{Amplifier Gain}$$

The "**Margin**" column of the following data tables indicates the degree of compliance with the applicable limit. For example, a margin of -7dB means the emission is 7dB below the maximum limit for Class B. The equation for margin calculation is as follows:

$$\text{Margin} = \text{Corr. Ampl.} - \text{FCC 15.209 Limit}$$

Environmental Conditions

Temperature:	20° C
Relative Humidity:	50%
ATM Pressure:	1012 mbar

**The testing was performed by Snell Leong on 2005-06-07.*

Summary of Test Results

According to the data hereinafter, the EUT complied with the FCC Title 47, Part 15, Subpart C, section 15.205, 15.207, and 15.247, and had the worst margin of:

- 4.9 dB at 2256.17 MHz in the **Vertical** polarization, Low Channel
- 4.8 dB at 2260.33 MHz in the **Vertical** polarization, Middle Channel
- 2.5 dB at 2263.58 MHz in the **Vertical** polarization, High Channel
- 7.0 dB at 336 MHz in the **Vertical** polarization, Unintentional Emission

Radiated Emission Test Data @ 3 Meters

Frequency MHz	Indicated		Antenna	Antenna		Correction Factor			FCC 15.247		
	Ampl. dB μ V/m	Direction Degree	Height Meter	Polar H/V	Antenna dB	Cable Loss dB	Amp. dB	Corr. Ampl. dB μ V/m	Limit dB μ V/m	Margin dB	Comments
Low Channel											
2401.0000	100.5	90	1.0	v	28.7	2.0	35.8	95.3			Fund/Peak
2401.0000	97.6	0	1.2	h	28.7	2.0	35.8	92.4			Fund/Peak
2401.0000	98.2	180	1.2	v	28.7	2.0	35.8	93.0			Ave
2401.0000	95.1	0	1.2	h	28.7	2.0	35.8	89.9			Ave
2256.1700	54.3	180	2.0	v	28.7	2.0	35.8	49.1	54	-4.9	Ave
2256.1700	51.9	90	2.0	h	28.7	2.0	35.8	46.8	54	-7.2	Ave
2545.5800	44.3	180	2.0	v	28.9	2.4	35.5	40.1	54	-13.9	Ave
4802.0000	38.2	270	2.4	v	32.5	3.1	34.8	39.0	54	-15.0	Ave
7203.0000	30.3	180	2.0	v	36.7	4.3	34.7	36.7	54	-17.3	Ave
7203.0000	30.3	90	2.0	h	36.7	4.3	34.7	36.6	54	-17.4	Ave
4802.0000	35.3	180	2.3	h	32.5	3.1	34.8	36.1	54	-17.9	Ave
2545.5800	40.3	90	2.0	h	28.9	2.4	35.5	36.1	54	-17.9	Ave
2256.1700	58.1	90	2.0	v	28.7	2.0	35.8	52.9	74	-21.1	Peak
1200.7500	43.3	270	2.4	v	23.3	1.3	36.8	31.0	54	-23.0	Ave
2256.1700	55.7	180	2.0	h	28.7	2.0	35.8	50.5	74	-23.5	Peak
1200.7500	41.5	180	2.3	h	23.3	1.3	36.8	29.3	54	-24.7	Ave
7203.0000	42.7	90	2.0	v	36.7	4.3	34.7	49.1	74	-24.9	Peak
7203.0000	41.7	180	2.0	h	36.7	4.3	34.7	48.1	74	-25.9	Peak
4802.0000	47.0	270	2.4	v	32.5	3.1	34.8	47.8	74	-26.2	Peak
4802.0000	45.0	180	2.3	h	32.5	3.1	34.8	45.8	74	-28.2	Peak
2545.5800	49.7	90	2.0	v	28.9	2.4	35.5	45.5	74	-28.5	Peak
2545.5800	46.9	180	2.0	h	28.9	2.4	35.5	42.7	74	-31.3	Peak
1200.7500	52.0	270	2.4	v	23.3	1.3	36.8	39.7	74	-34.3	Peak
1200.7500	50.8	180	2.3	h	23.3	1.3	36.8	38.5	74	-35.5	Peak

Middle Channel												
2404.2000	98.2	270	1.5	v	28.7	2.0	35.8	93.0				Fund/Peak
2404.2000	93.7	90	1.5	h	28.7	2.0	35.8	88.5				Fund/Peak
2404.2000	97.4	0	1.5	v	28.7	2.0	35.8	92.3				Ave
2404.2000	92.1	90	1.6	h	28.7	2.0	35.8	86.9				Ave
2260.3300	54.4	180	2.0	v	28.7	2.0	35.8	49.2	54	-4.8		Ave
2260.3300	49.5	90	2.0	h	28.7	2.0	35.8	44.3	54	-9.7		Ave
4808.4000	40.3	270	2.4	v	32.5	3.1	34.8	41.1	54	-12.9		Ave
3079.5800	43.6	180	2.1	h	29.8	2.5	35.2	40.7	54	-13.3		Ave
7212.6000	31.6	180	2.1	h	36.7	4.3	34.7	38.0	54	-16.0		Ave
2548.4200	40.1	90	2.0	h	28.9	2.4	35.5	36.0	54	-18.0		Ave
7212.6000	29.3	270	2.4	v	36.7	4.3	34.7	35.7	54	-18.3		Ave
3079.5800	38.0	270	2.4	v	29.8	2.5	35.2	35.1	54	-18.9		Ave
4808.4000	33.8	180	2.2	h	32.5	3.1	34.8	34.6	54	-19.4		Ave
2548.4200	38.4	180	2.0	v	28.9	2.4	35.5	34.3	54	-19.7		Ave
2260.3300	56.9	90	2.0	v	28.7	2.0	35.8	51.7	74	-22.3		Peak
7212.6000	43.0	180	2.3	h	36.7	4.3	34.7	49.3	74	-24.7		Peak
4808.4000	46.9	270	2.4	v	32.5	3.1	34.8	47.7	74	-26.3		Peak
2260.3300	52.9	180	2.0	h	28.7	2.0	35.8	47.7	74	-26.3		Peak
3079.5800	50.2	180	2.3	h	29.8	2.5	35.2	47.4	74	-26.6		Peak
7212.6000	40.7	270	2.4	v	36.7	4.3	34.7	47.0	74	-27.0		Peak
3079.5800	47.9	270	2.4	v	29.8	2.5	35.2	45.0	74	-29.0		Peak
2548.4200	48.1	180	2.0	h	28.9	2.4	35.5	43.9	74	-30.1		Peak
4808.4000	42.0	180	2.2	h	32.5	3.1	34.8	42.8	74	-31.2		Peak
2548.4200	46.5	90	2.0	v	28.9	2.4	35.5	42.3	74	-31.7		Peak

High Channel											
2406.8000	97.4	0	2.2	v	28.7	2.0	35.8	92.2			Peak
2406.8000	94.9	0	1.8	h	28.7	2.0	35.8	89.7			Fund/Peak
2406.8000	95.8	90	3.5	v	28.7	2.0	35.8	90.6			Ave
2406.8000	93.7	90	2.6	h	28.7	2.0	35.8	88.6			Ave
2263.5800	56.7	270	2.4	v	28.7	2.0	35.8	51.5	54	-2.5	Ave
2263.5800	50.4	90	2.1	h	28.7	2.0	35.8	45.2	54	-8.8	Ave
2550.0800	47.1	180	2.1	h	28.9	2.4	35.5	42.9	56	-13.1	Ave
2550.0800	44.9	90	2.1	h	28.9	2.4	35.5	40.8	55	-14.2	Ave
7220.4000	30.1	90	2.1	h	36.7	4.3	34.7	36.4	54	-17.6	Ave
7220.4000	29.8	270	2.4	v	36.7	4.3	34.7	36.1	54	-17.9	Ave
2263.5800	59.0	270	2.4	v	28.7	2.0	35.8	53.9	74	-20.1	Peak
4813.6000	32.9	270	2.4	v	32.5	3.1	34.8	33.7	54	-20.3	Ave
2550.0800	41.2	90	2.1	h	28.9	2.4	35.5	37.0	58	-21.0	Ave
1203.3300	43.6	270	2.4	v	23.3	1.3	36.8	31.4	54	-22.6	Ave
2550.0800	37.3	180	2.1	h	28.9	2.4	35.5	33.1	57	-23.9	Ave
4813.6000	29.1	90	2.1	h	32.5	3.1	34.8	29.9	54	-24.1	Ave
2263.5800	53.9	90	2.1	h	28.7	2.0	35.8	48.7	74	-25.3	Peak
7220.4000	41.6	90	2.1	h	36.7	4.3	34.7	48.0	74	-26.0	Peak
7220.4000	39.6	270	2.4	v	36.7	4.3	34.7	45.9	74	-28.1	Peak
1203.3300	37.7	90	2.1	h	23.3	1.3	36.8	25.5	54	-28.5	Ave
4813.6000	43.8	270	2.4	v	32.5	3.1	34.8	44.6	74	-29.4	Peak
4813.6000	38.7	90	2.1	h	32.5	3.1	34.8	39.5	74	-34.5	Peak
1203.3300	50.8	90	2.1	h	23.3	1.3	36.8	38.6	74	-35.4	Peak
1203.3300	49.8	270	2.4	v	23.3	1.3	36.8	37.6	74	-36.4	Peak

FUND: Fundamental

AVG: Average

Unintentional Emission

Frequency MHz	Indicated		Antenna	Antenna		Correction Factor			FCC 15B	
	Ampl. dB μ V/m	Direction Degree	Height Meter	Polar H/V	Antenna dB	Cable Loss dB	Amp. dB	Corr. Ampl. dB μ V/m	Limit dB μ V/m	Margin dB
336.00	48.4	330	1.2	V	14.2	3.9	27.5	39.0	46	-7.0
312.00	47.3	270	3.2	H	13.8	3.8	27.5	37.4	46	-8.6
320.00	45.1	240	3.1	H	14.1	3.8	27.5	35.5	46	-10.5
560.00	39.8	240	3.1	H	18.4	5.1	28.7	34.6	46	-11.4
328.00	44.0	270	2.1	H	14.1	3.8	27.5	34.4	46	-11.6
560.00	38.9	330	1.2	V	18.4	5.1	28.7	33.7	46	-12.3
408.00	40.9	270	3.2	H	15.4	4.6	28.1	32.8	46	-13.2
480.00	39.0	270	2.1	H	17.6	4.8	28.6	32.8	46	-13.2
480.00	38.9	250	1.0	V	17.6	4.8	28.6	32.7	46	-13.3
360.00	41.3	330	3.0	V	14.8	4.1	27.8	32.4	46	-13.6
320.00	40.6	75	1.8	V	14.1	3.8	27.5	31.0	46	-15.0
464.00	36.9	75	1.8	V	17.2	4.7	28.5	30.3	46	-15.7
408.00	38.0	250	1.0	V	15.4	4.6	28.1	29.9	46	-16.1
360.00	38.7	280	2.8	H	14.8	4.1	27.8	29.8	46	-16.2
464.00	35.9	280	2.8	H	17.2	4.7	28.5	29.3	46	-16.7
328.00	36.4	270	1.0	V	14.1	3.8	27.5	26.8	46	-19.2
312.00	36.2	270	1.0	V	13.8	3.8	27.5	26.3	46	-19.7
336.00	33.6	240	3.1	H	14.2	3.9	27.5	24.2	46	-21.8

§15.247(a)(2) – 6 dB BANDWIDTH

Standard Applicable

According to §15.247(a)(2), for digital modulation techniques, the minimum 6dB bandwidth shall be at least 500 kHz.

Measurement Procedure

1. Check the calibration of the measuring instrument using either an internal calibrator or a known signal from an external generator.
2. Position the EUT without connection to measurement instrument. Turn on the EUT and connect it to measurement instrument. Then set it to any one convenient frequency within its operating range. Set a reference level on the measuring instrument equal to the highest peak value.
3. Measure the frequency difference of two frequencies that were attenuated 6 dB from the reference level. Record the frequency difference as the emission bandwidth. (6 dB bandwidth for DTS)
4. Repeat above procedures until all frequencies measured were complete.

Equipment Lists

Manufacturer	Description	Model	Serial Number	Cal. Date
Agilent	Analyzer, Spectrum	E4446A	US44300386	11/10/2004

* **Statement of Traceability:** **BACL Corp.** attests that all calibrations have been performed per the NVLAP requirements, traceable to the NIST.

Measurement Result

Environmental Conditions

Temperature:	25° C
Relative Humidity:	66%
ATM Pressure:	1024 mbar

*The testing was performed by Snell Leong on 2005-05-31.

Test Result

Channel	Frequency (MHz)	Measured (KHz)	Standard (kHz)	Result
Low	2401	573	≥ 500	Pass
Mid	2404.2	581	≥ 500	Pass
High	2406.8	575	≥ 500	Pass

Low Channel

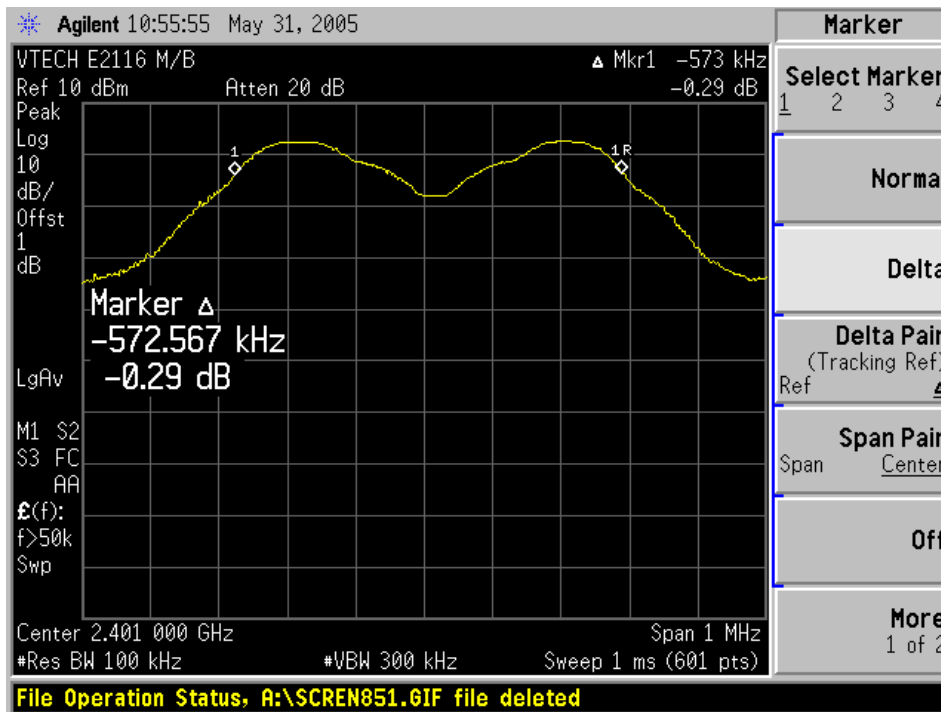

Middle Channel

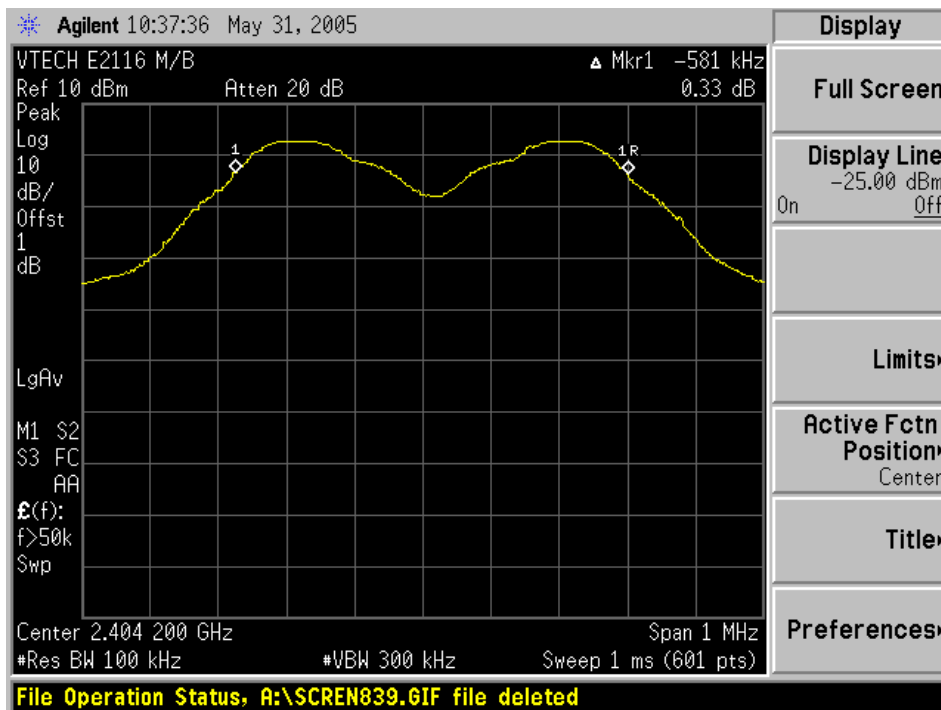

High Channel

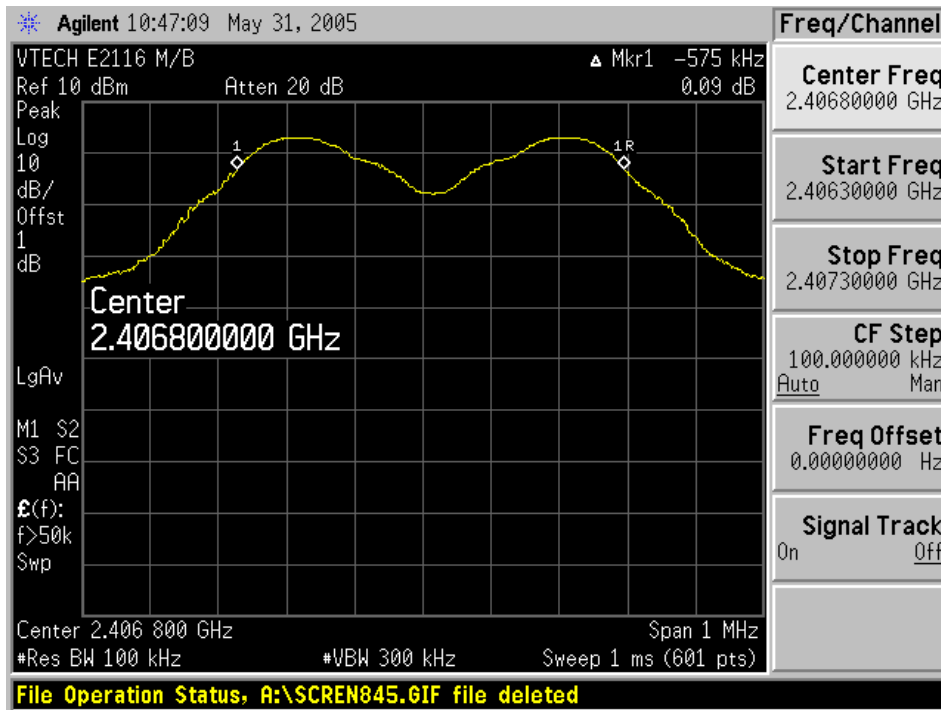

§15.247(b)(3) - PEAK OUTPUT POWER MEASUREMENT

Standard Applicable

According to §15.247(b) (3), for systems using digital modulation in 2400-2483.5 MHz: 1 Watt

Measurement Procedure

1. Place the EUT on a bench and set it in transmitting mode.
2. Remove the antenna from the EUT and then connect a low loss RF cable from the antenna port to a spectrum analyzer.
3. Add a correction factor to the display.

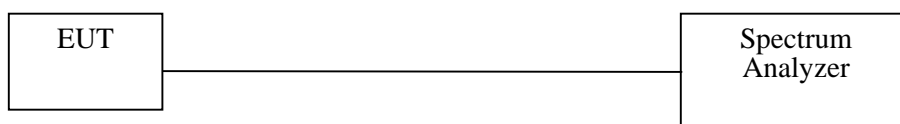

Equipment Lists

Manufacturer	Description	Model	Serial Number	Cal. Date
Agilent	Analyzer, Spectrum	E4446A	US44300386	11/10/2004

* **Statement of Traceability:** **BACL Corp.** attests that all calibrations have been performed per the NVLAP requirements, traceable to the NIST.

Measurement Result

Environmental Conditions

Temperature:	25° C
Relative Humidity:	66%
ATM Pressure:	1024 mbar

*The testing was performed by Snell Leong on 2005-05-31.

Output Power

Channel	Frequency MHz	Max Peak Output Power		Limit (mW)	Result
		(dBm)	(mW)		
Low	2401	2.49	1.77	1000	pass
Mid	2404.2	2.77	1.89	1000	pass
High	2406.8	2.88	1.94	1000	pass

Low Channel

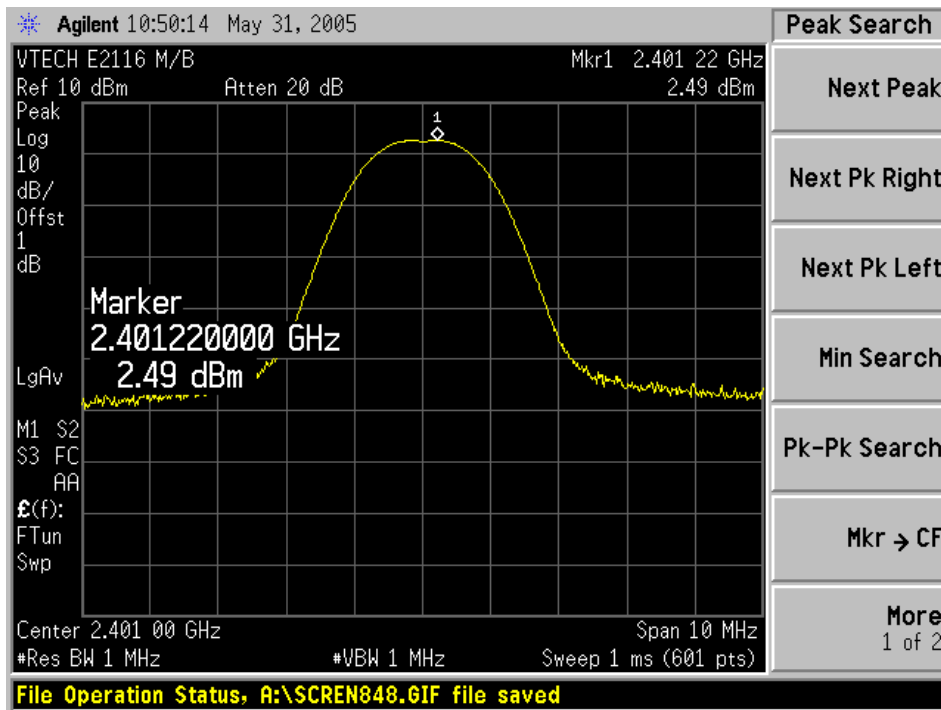

Middle Channel

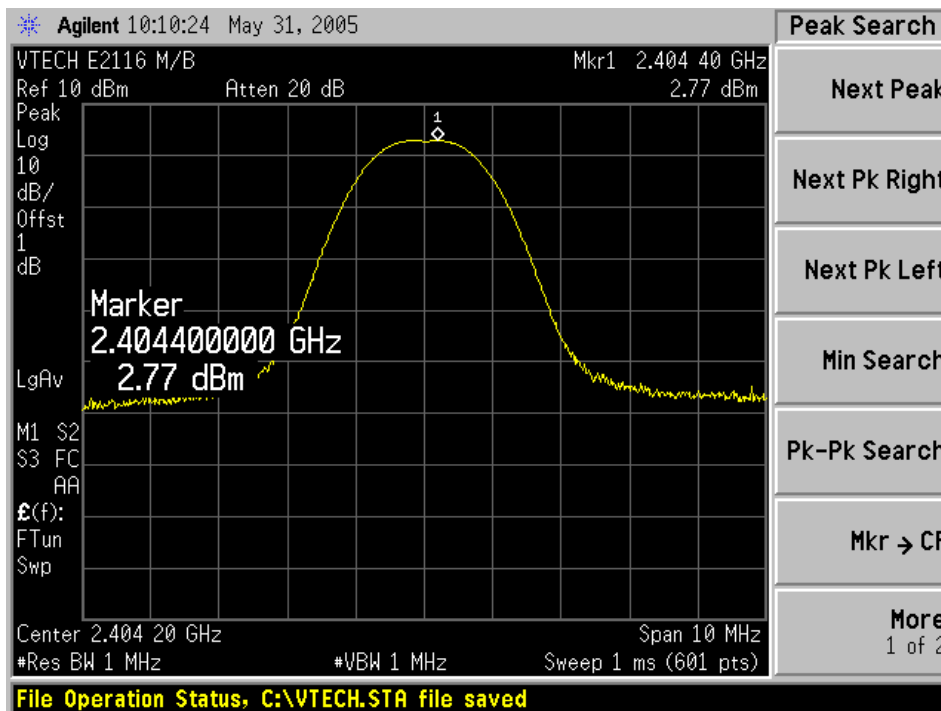

High Channel

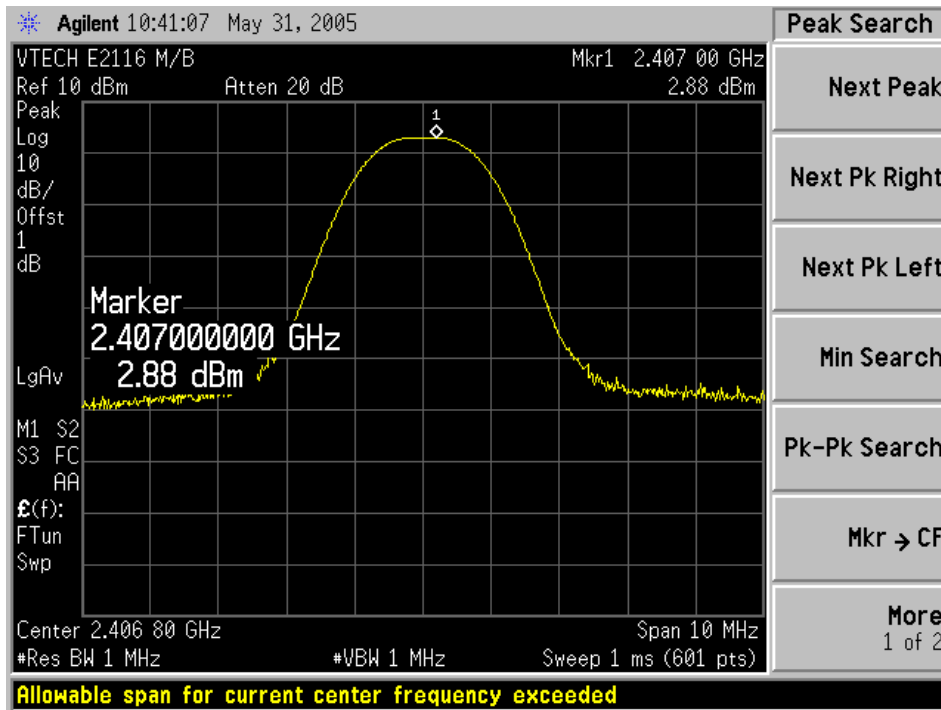

§15.247(d) - 100 KHZ BANDWIDTH OF BAND EDGES

Standard Applicable

According to §15.247(d), in *any* 100 kHz bandwidth outside the frequency bands in which the spread spectrum intentional radiator is operating, the radio frequency power that is produced by the intentional radiator shall be at least 20 dB below that in the 100 kHz bandwidth within the band that contains the highest level of the desired power, based on either an RF conducted or a radiated measurement. In addition, radiated emissions which fall in the restricted bands, as defined in §15.205(a), must also comply with the radiated emission limits specified in §15.209(a) see §15.205(c).

Measurement Procedure

1. Check the calibration of the measuring instrument using either an internal calibrator or a known signal from an external generator.
2. Position the EUT without connection to measurement instrument. Turn on the EUT and connect its antenna terminal to measurement instrument via a low loss cable. Then set it to any one measured frequency within its operating range, and make sure the instrument is operated in its linear range.
3. Set both RBW and VBW of spectrum analyzer to 100 kHz with a convenient frequency span including 100kHz bandwidth from band edge.
4. Measure the highest amplitude appearing on spectral display and set it as a reference level. Plot the graph with marking the highest point and edge frequency.
5. Repeat above procedures until all measured frequencies were complete.

Equipment Lists

Manufacturer	Description	Model	Serial Number	Cal. Date
Agilent	Analyzer, Spectrum	E4446A	US44300386	11/10/2004

* **Statement of Traceability: BACL Corp.** attests that all calibrations have been performed per the NVLAP requirements, traceable to the NIST.

Measurement Result

Environmental Conditions

Temperature:	25° C
Relative Humidity:	66%
ATM Pressure:	1024 mbar

*The testing was performed by Snell Leong on 2005-05-31.

Please refer to following pages for plots of band edge.

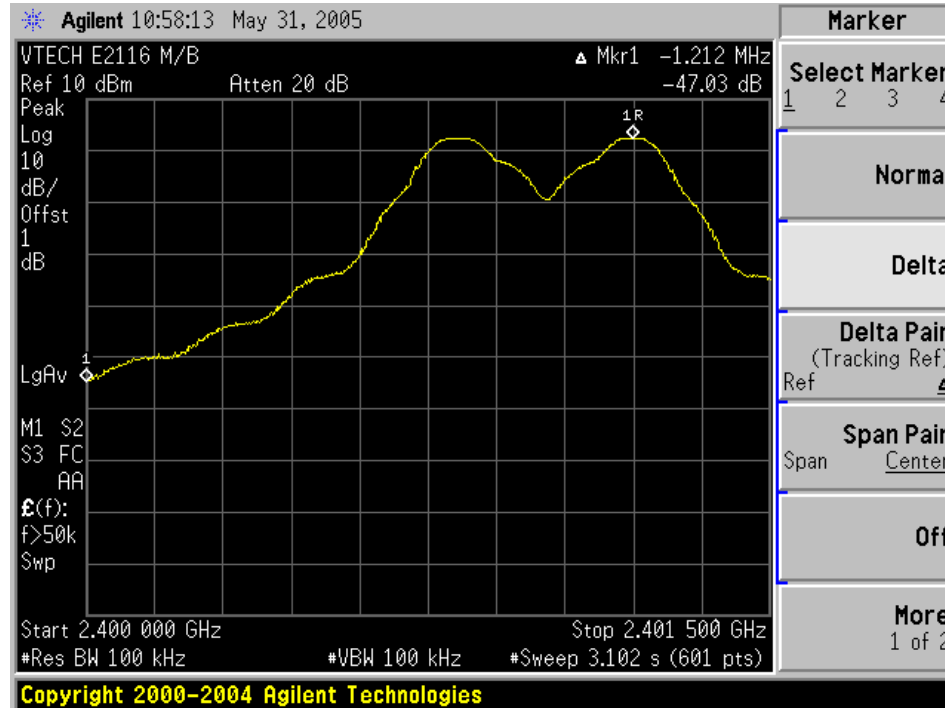
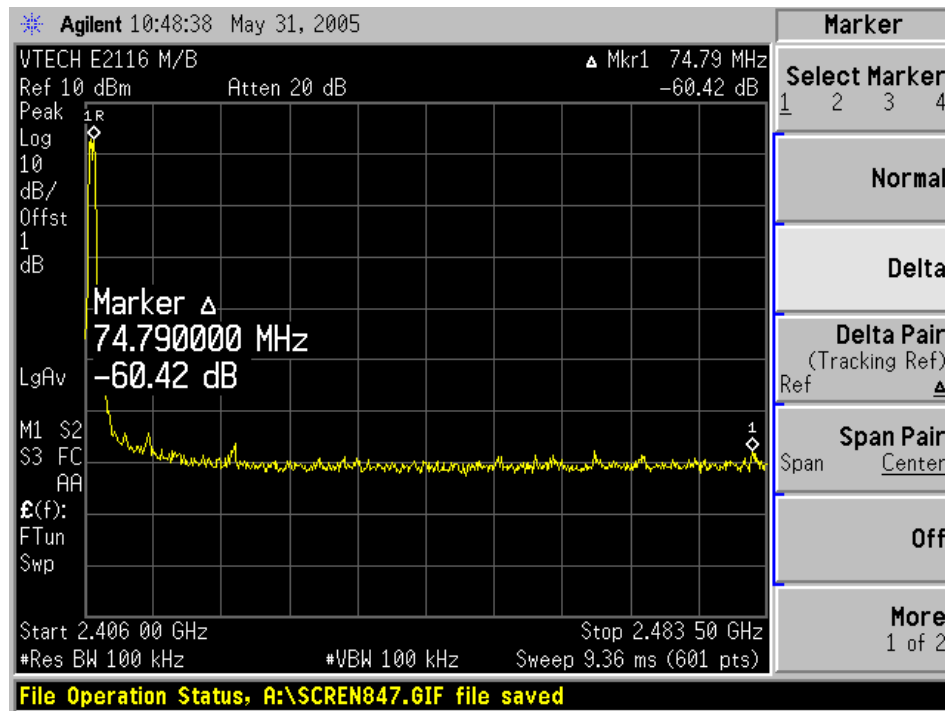

§15.247(e) - PEAK POWER SPECTRAL DENSITY

Standard Applicable

According to §15.247 (e), for direct sequence systems, the peak power spectral density conducted from the intentional radiator to the antenna shall not be greater than 8 dBm in any 3 kHz band during any time interval of continuous transmission.

Measurement Procedure

1. Check the calibration of the measuring instrument using either an internal calibrator or a known signal from an external generator.
2. Position the EUT was set without connection to measurement instrument. Turn on the EUT and connect its antenna terminal to measurement instrument via a low loss cable. Then set it to any one measured frequency within its operating range, and make sure the instrument is operated in its linear range.
3. Adjust the center frequency of SA on any frequency be measured and set SA to 1.5MHz span mode. And then, set RBW and VBW of spectrum analyzer to proper value. (DTS)
4. Repeat above procedures until all frequencies measured were complete.

Equipment Lists

Manufacturer	Description	Model	Serial Number	Cal. Date
Agilent	Analyzer, Spectrum	E4446A	US44300386	11/10/2004

* **Statement of Traceability: BACL Corp.** attests that all calibrations have been performed per the NVLAP requirements, traceable to the NIST.

Measurement Result

Environmental Conditions

Temperature:	25° C
Relative Humidity:	66%
ATM Pressure:	1024 mbar

*The testing was performed by Snell Leong on 2005-05-31.

Test Result

Channel	Frequency (MHz)	Peak Power Spectral Density (dBm)	Standard (dBm)	Result
Low	2401	-3.53	≤ 8	Pass
Mid	2404.2	-2.99	≤ 8	Pass
High	2406.8	-2.83	≤ 8	Pass

Low Channel

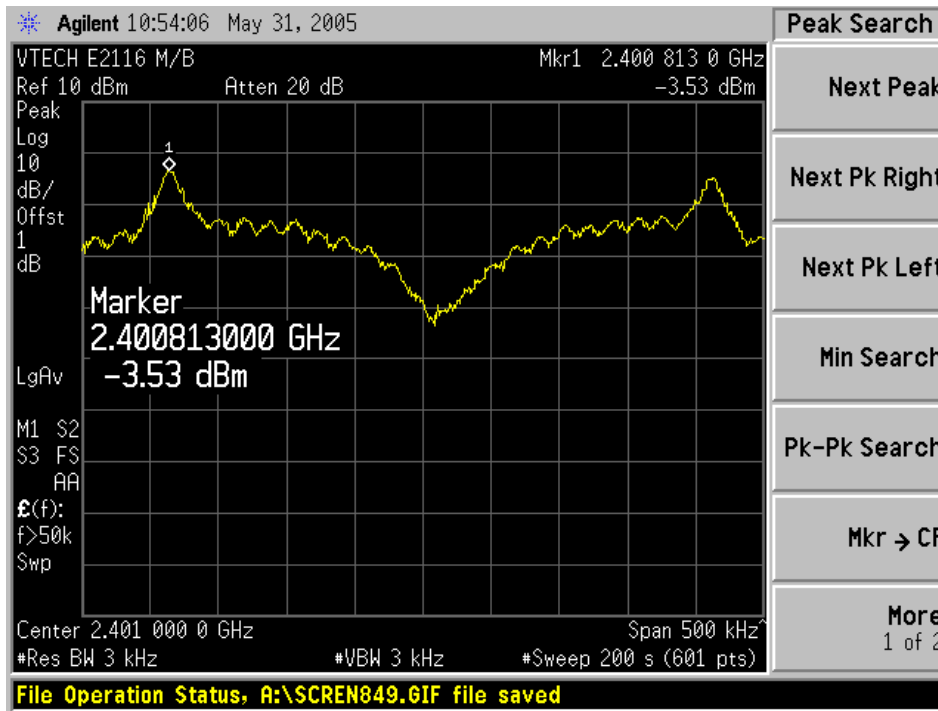

Middle Channel

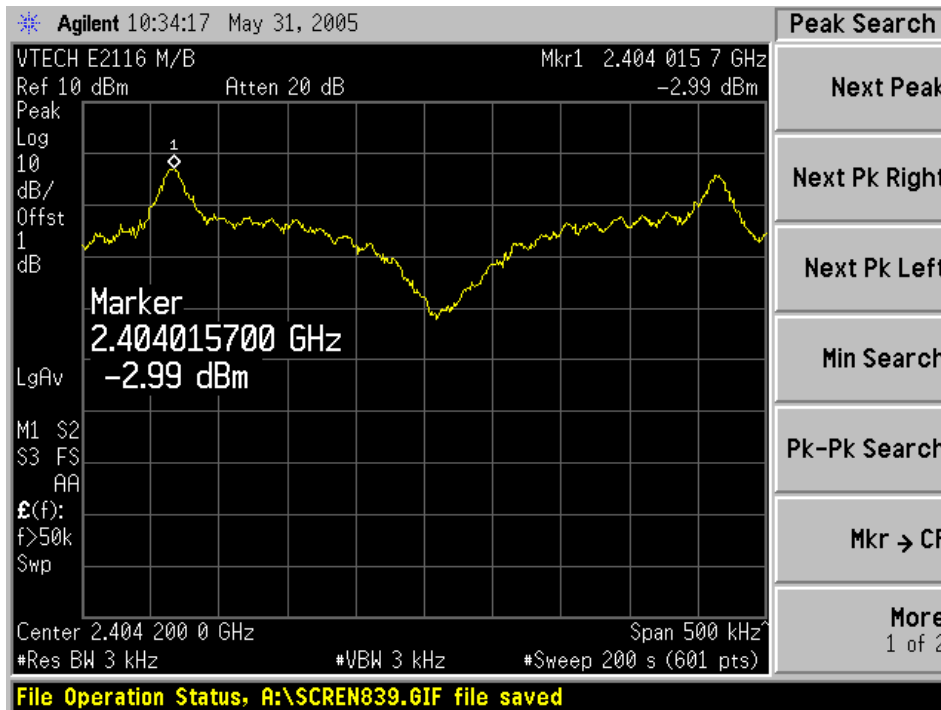

High Channel

