

Important Safety Instructions

When using your telephone equipment, basic safety precautions should always be followed to reduce the risk of fire, electric shock and injury, including the following:

1. Read and understand all instructions.
2. Follow all warnings and instructions marked on the product.
3. Unplug this product from the wall outlet before cleaning. Do not use liquid or aerosol cleaners. Use a damp cloth for cleaning.
4. Do not use this product near water (for example, near a bath tub, kitchen sink or swimming pool).
5. Do not place this product on an unstable surface such as a table, shelf or stand. The product may fall, causing serious damage.
6. Slots and openings in the back or bottom of the Base Unit and Handset are provided for ventilation. To protect them from overheating, these openings must not be blocked by placing the product on a soft surface such as a bed, sofa or rug. This product should never be placed near or over a radiator or heat register. Nor should this product should not be placed in any area where proper ventilation is not provided.
7. This product should be operated only from the type of power source indicated on the packaging. If you are not sure of the type of power supply in your home, consult your dealer or local power company.
8. Do not allow anything to rest on the power cord. Do not install this product where the cord may have anyone walking on it.
9. Never push objects of any kind into this product through slots in the Base or Handset as they may touch dangerous voltage points or short out parts that could result in a risk of fire or electric shock. Avoid spilling liquid of any kind on the product.
10. To reduce the risk of electric shock, do not disassemble this product, but take it to an authorized service facility. Opening or removing parts of the Base or Handset other than specified access doors may expose you to dangerous voltages or other risks. Incorrect reassembling can cause electric shock when the product is subsequently used.
11. Do not overload wall outlets and extension cords as this can result in the risk of fire or electric shock.
12. Unplug this product from the wall outlet and refer servicing to an authorized service facility under the following conditions:
 - A. When the power supply cord or plug is damaged or frayed.
 - B. If liquid has been spilled onto the product.
 - C. If the product has been exposed to rain or water.
 - D. If the product does not operate normally by following the operating instructions. Adjust only those controls that are covered by the operating instructions, as improper adjustment of other controls may result in damage and often requires extensive work by an authorized technician to restore the product to normal operation.
 - E. If the product has been dropped and the Base and/or Handset has been damaged.

Important Safety Instructions

- F. If the product exhibits a distinct change in performance.
- 13. Avoid using a telephone (other than cordless) during an electrical storm. There is a remote risk of electric shock from lightning.
- 14. Do not use the telephone to report a gas leak in the vicinity of the leak.
- 15. Only put the Handset of your telephone next to your ear when it is in normal talk mode.

WARNING: To insure your safety from possible electric shock, only use the enclosed VTech Audio Patch Cable to record custom ring tones. Do NOT leave the Audio Patch Cable attached to the Handset while charging in its cradle.

Introduction

Your **i 5871** is an advanced cordless telephone that operates in the 5.8GHz frequency range. Your **i 5871** is capable of supporting up to a maximum of **8** Handsets. Using additional Handsets, up to 2 people can be conferenced on a call (2 Handsets), or two extensions can be conferenced on a call, while two other extensions can be talking internally, using the Intercom feature.

This manual is designed to familiarize you with the **i 5871** cordless telephone. We strongly recommend you read the manual before using your phone.

To order additional system Handsets (model number **i 5808**), battery cells or headsets, call VTech Communications, Inc. at 1-800-595-9511. In Canada, call 1-800-267-7377.

Parts Check List

- | | |
|------------------------|------------------------------------|
| 1. Base Unit | 7. Battery Pack |
| 2. Handset | 8. USB Cable |
| 3. Telephone Line Cord | 9. Audio Patch Cable |
| 4. Belt Clip | 10. Image Editor Software (CD-ROM) |
| 5. User's Manual | 11. Base AC Power Adapter |
| 6. Quick Start Guide | |

To purchase replacement battery cells, call VTech Communications, Inc. at 1-800-595-9511. In Canada, call VTech Telecommunication Canada Ltd. at 1-800-267-7377.

Note: Use only VTech batteries (part number 80-5461-00-00) or equivalent AA NiMH re-chargeable batteries.

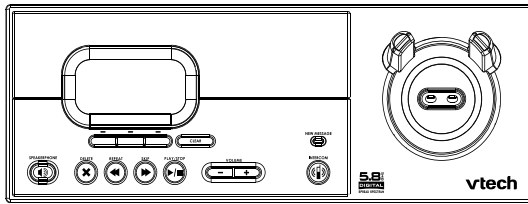

Base Unit

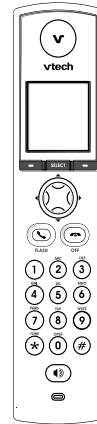

Handset

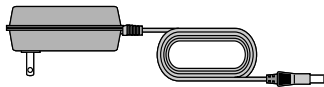

Base AC Power Adapter

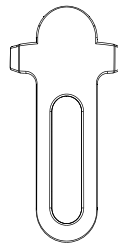

Belt Clip



Quick Start Guide

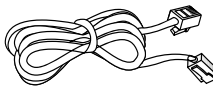

Telephone Line Cord

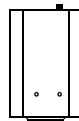

Battery Pack

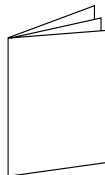

User's Manual

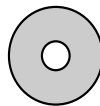
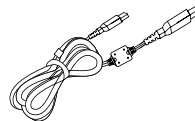

Image Editor Software (CD-ROM)



USB Cable



Audio Patch Cable

The Handset Layout

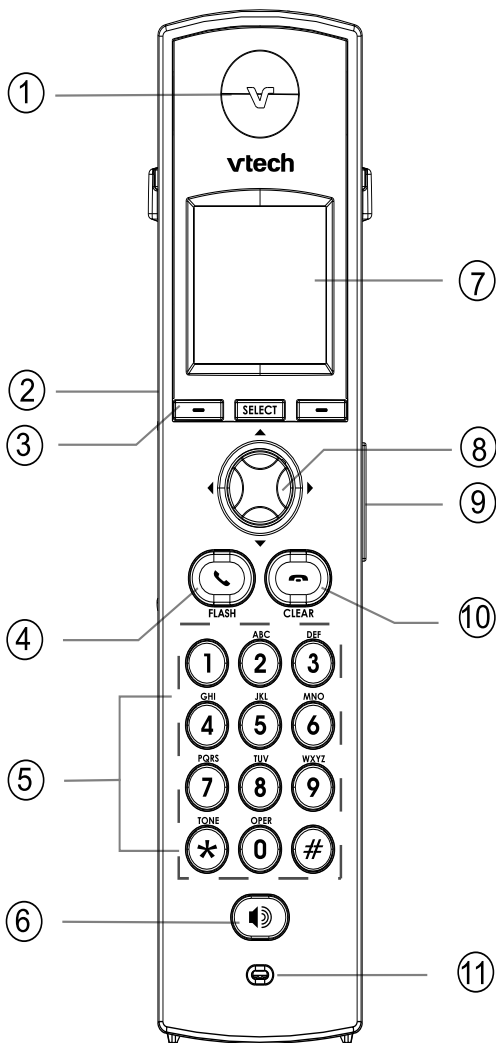

- | | |
|--|---------------------|
| 1. Earpiece | 6. Speakerphone Key |
| 2. Headset Jack and Audio Patch Cable Jack (2.5mm) | 7. LCD Display |
| 3. Soft/Select Key | 8. Navigation Key |
| 4. On/Flash Key | 9. Volume Keys |
| 5. Dialing Keys (0-9, *, #) | 10. Off/Cancel Key |
| | 11. Microphone |

The Base Unit Layout

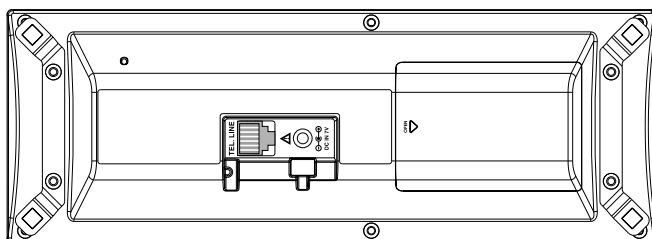
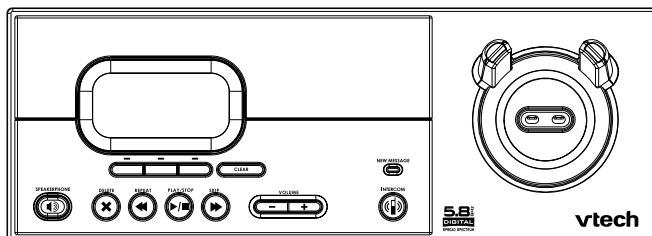

- | | |
|-----------------|----------------------------------|
| 1. Volume Keys | 10. Menu |
| 2. Charging LED | 11. Mailbox Keys (Play/Stop) |
| 3. Repeat/Slow | 12. In Use LED |
| 4. Skip/Quick | 13. Page |
| 5. Delete | 14. On/Off |
| 6. Record | 15. Spare Battery Drawer |
| 7. Change | 16. Spare Battery Release Button |
| 8. Antenna | 17. Telephone Jack |
| 9. Time/Set | 18. DC Connector Jack |

Setup

Connecting Power to Base Unit

Plug the AC power adapter into an electrical outlet, and the DC connector into the bottom of the Base Unit.

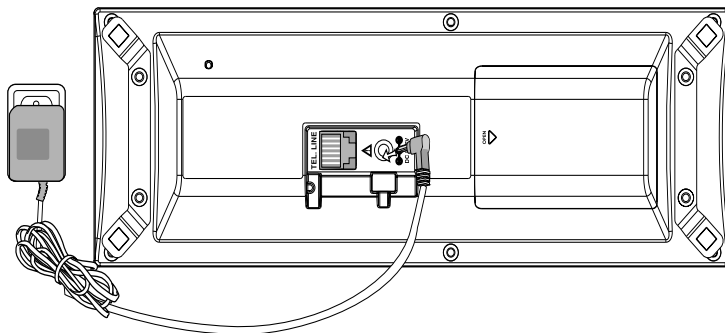

Installation and Charge of Battery Cells in Handset

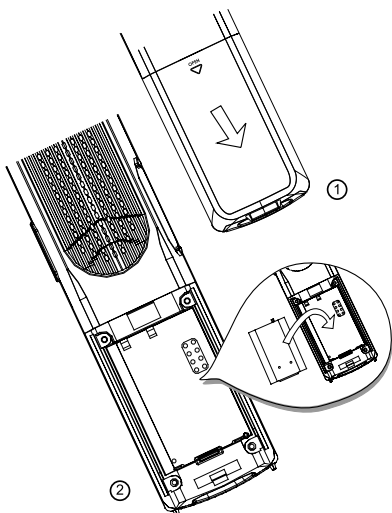

1. Remove the battery cover and place the new battery cells in the Handset with the positive and negative poles aligned in the battery compartment.
2. Replace the battery cover by sliding it upwards.
3. If the new battery cells are not already charged, place the Handset in its Charger or Base Unit, and allow it to charge for at least 12 hours. After initial charge, a maintenance charge of 8 hours should be sufficient.

The original Handset that is shipped with your i 5871 system will be automatically registered to the Base. This Handset is HANDSET 1.

Setup

As you register additional Handsets to the system, they will be assigned extension numbers in the following order: **HANDSET 2, HANDSET 3**, etc.

Whenever charged Handset battery cells are installed, the Handset will automatically begin **Searching for Base...** (if previously registered), or it will prompt you to **Enter Base ID** to register the new Handset.

Charging of the Handset Battery Cells

The Handset of your **i 5871** cordless telephone is powered by rechargeable battery cells which charge automatically whenever the Handset is in its Base Unit or charger. Maximum talk time on fully charged cells is 8 hours, and maximum standby time is 5 days.

You should charge the battery cells for at least 12 hours when you first receive your phone. You'll know the battery cells need charging when:

- The low battery message is displayed:
- The Handset seems completely dead, the LCD is completely clear and does not activate when you press the keys.

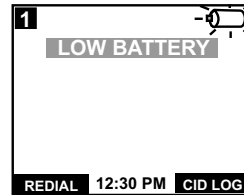

IMPORTANT:

1. Do not dispose of battery cells in a fire, they may explode.
2. Do not open or mutilate the battery cells. Toxic substances may be released, causing harm to the eyes and/or skin.
3. Be careful when handling battery cells in order to prevent an accidental short of the charge contacts, potentially causing the battery cells to overheat.
4. Do not dispose of the battery cells into household garbage.

Connecting to Phone Line

Plug one end of the telephone line cord into the jack on the bottom of the Base Unit. Plug the other end of this cord into the wall jack.

Checking for Dial Tone

After the battery cells are charged press **ON** on the Handset. The phone icon  will appear on the Handset display, and you will hear dial tone. If not, see **In Case of Difficulty**.

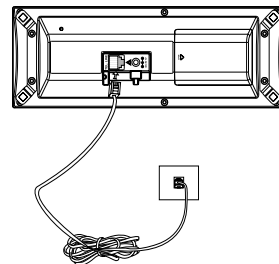

Setup

Tone/Pulse Selection

Your **i 5871** is preset for tone dialing. See **Settings** for tone/pulse options and other details.



CAUTION: Use only the VTech power supply provided with your telephone.

IMPORTANT: FOR MAXIMUM PERFORMANCE OF YOUR CORDLESS TELEPHONE SYSTEM:

1. Choose a central location for your Base Unit.
2. Install your Base Unit and Extension Handsets away from electronic equipment such as personal computers, television sets and microwave ovens.
3. In locations where there are multiple cordless telephones, separate base units as much as possible.
4. Install your telephone equipment away from heat sources and sunlight.
5. Avoid excessive moisture, dust or extreme cold.

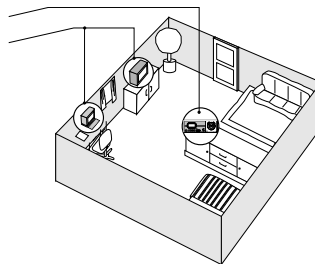

Spare Battery Charger/Power Backup Feature

Power Guard Feature

The **i 5871** uses the spare battery charger in the Base Unit to provide power backup in the event of a power failure or outage. With fully charged battery cells in the spare battery charger, you will be able to place and receive calls from the **Handset only**, for up to **2 1/2** hours during a power outage.

The spare battery cells can also be used to replace drained Handset battery cells, ensuring uninterrupted use. The spare battery cells are optional and can be purchased separately.

NOTE: When using your **i 5871** during Power Backup mode, audio quality may be compromised due to reduced power availability.

Installation

1. Open the spare battery charger by pressing the release button, located on the right-hand side of the Base Unit. A drawer will open to reveal the spare battery compartment.
2. Place the battery cells in the spare battery charger with the positive and negative poles aligned in the battery compartment.
3. Push the drawer closed. The spare battery charger takes 24 hours to fully charge drained battery cells.

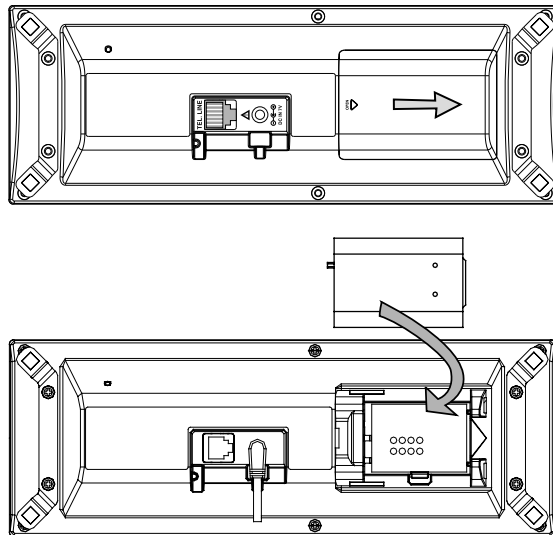

To order battery cells, Headsets and additional Handsets (model i 5808), call VTech Customer Service at 1-800-595-9511. In Canada, call 1-800-267-7377.

Installation/Registration of Accessory Handset

Expand your **i 5871** system by adding accessory Handsets. Bring telephone service to rooms where a phone jack isn't available!

Your VTech **i 5871** system can operate up to 8 Handsets. To order additional Handsets (model number **i 5808**), call VTech Customer Service at **1-800-595-9511**. In Canada, call: **1-800-267-7377**.

The **i 5808** accessory Handset comes with the following:

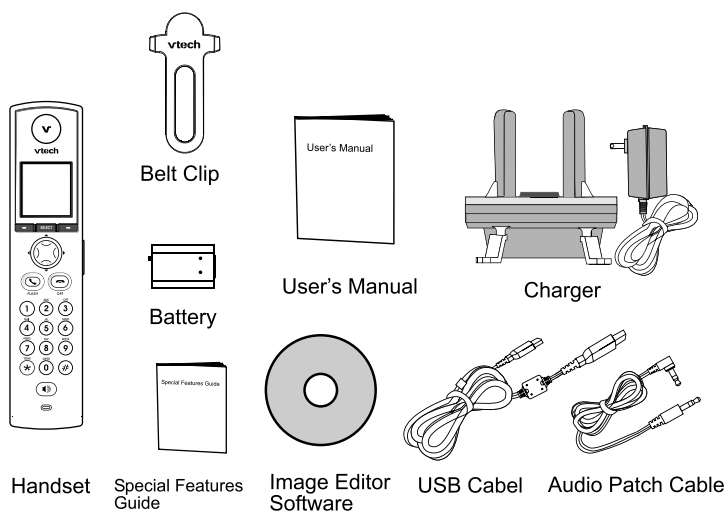

Installation of Accessory Handset

Setup of the i 5808 Accessory Handset

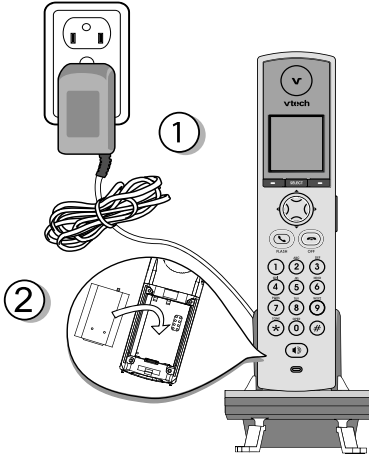

1. Plug the AC power adapter into an electrical outlet.
2. Place the new battery cells in the Handset with the positive and negative poles aligned in the battery compartment.
3. Replace the battery compartment cover by sliding it upward.
4. Place the Handset in the Charger, and allow it to charge for at least 12 hours. After the initial charge, a maintenance charge of 8 hours should be sufficient.

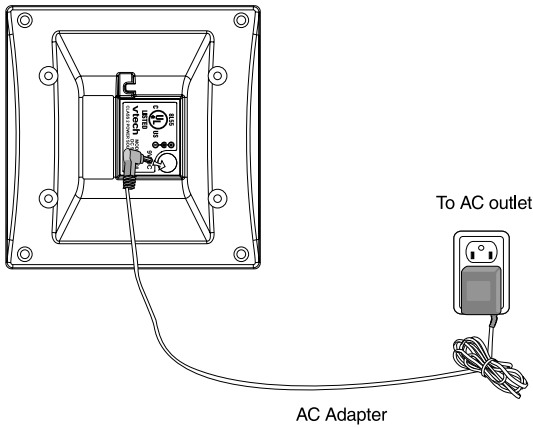

Registration of Accessory Handset

Registration of Accessory Handset

After charging, the screen will display:

- Enter the **BASE ID Code** located on the underside of the Base Unit.
- Press **OK** to complete the registration process.



NOTE: If after charging the Handset displays “Searching for Base...”, press the **NEW** softkey. “Enter Base ID” will now be displayed. Follow the above steps.

Wait approximately 15 - 60 seconds. You will hear confirmation beeps from the Base and Handset. The newly registered Handset will now be assigned the lowest extension number not previously assigned to a different system Handset (1- 8).











If you do not enter the correct digit sequence, you will see **Invalid Base ID!** and hear an **error** tone. Press the left NavKey ◀ to backspace or press the right softkey ▶ to erase a character, and carefully re-enter the **Base ID Code**.

NOTE: The 15-digit BASE ID Code may contain numbers and characters, including 0 through 9, as well as *. Make sure you enter all 15 digits.

Congratulations! You can now enjoy the benefits of your **VTech** Multi-Handset system.

Handset and Base Indicators

Handset Icons

Icon	Description
	<p><u>Line In Use Indicator</u></p> <ul style="list-style-type: none"> On steady with one or more numbers next to it, indicating which extensions are using the line. For example,  12 indicates that Handset 1 and Handset 2 are on an outside call. Indicates when a parallel set is in use. Lit when the answering machine is answering an incoming call.
	<p><u>Handset Number Indicator</u></p> <ul style="list-style-type: none"> Indicates the Handset number. It's permanently displayed at the top left corner after the Handset has found the Base.
	<p><u>Searching for Base Indicator</u></p> <ul style="list-style-type: none"> Indicates that the Handset is searching for the Base.
	<p><u>Intercom Indicator</u></p> <ul style="list-style-type: none"> On steady with the extension numbers currently on an intercom call. For example,  12 indicates that the Handset 1 and Handset 2 are on intercom call.
H	<p><u>Hold Indicator</u></p> <ul style="list-style-type: none"> On steady when a call is on hold.
M	<p><u>Mute Indicator</u></p> <ul style="list-style-type: none"> On steady when the Handset microphone is muted.
	<p><u>Ringer Off Indicator</u></p> <ul style="list-style-type: none">  is displayed when the ringer is turned off.
	<p><u>Battery Indicator</u></p> <ul style="list-style-type: none"> When the Handset is removed from the charger, this lets you know the level of charge in the battery pack, from FULL () to EMPTY () Cycles (Low, Medium, and Full) when Handset battery is charging. Flashes when a low battery condition is detected.

Handset and Base Indicators

Handset LEDs

LED	Description
SPEAKERPHONE	<ul style="list-style-type: none"> • LED is on when in speakerphone mode.
IN USE	<ul style="list-style-type: none"> • Lights when in the handset off-hook mode. • Flashes following by the ring cadence when incoming call.

Base LEDs

LED	Description
 1, 2, 3	<ul style="list-style-type: none"> • Flashes to indicate that you have new messages in that mailbox. • Glows steadily if there are only old messages in that mailbox.
On/Off	<ul style="list-style-type: none"> • Lights when the Answering Machine is ON.
Charging	<ul style="list-style-type: none"> • On when the Handset is in its Base. • Flashes five times when batteries are detected in the spare battery drawer. • Flashes quickly when Alkaline batteries are detected in the spare battery drawer.
IN USE	<ul style="list-style-type: none"> • Lights when the line is being used by a i 5871 system Handset. • Flashes when another telephone on the same line (parallel extension) is in use or when the answering machine is currently answering a call.

Handset Menu

Navigation Keys (NavKeys):

- Press any NavKey to display the Main Menu. Press the NavKeys (left, right, up and down) to maneuver through menus. Press the middle NavKey to select the highlighted menu item.

Menu Shortcuts

- When viewing menu options, pressing the corresponding number on the dialing pad will automatically select that item.
- For example, in the Main Menu screen, pressing the 1 key will automatically take you to the Intercom menu screen, pressing the 6 key will automatically take you to the Settings menu screen, and so on through all 6 menu options.
- Similarly, when viewing a list menu, pressing the corresponding number will automatically select that option (and save it, if necessary). For example, pressing the 2 key when in the Appearance screen will select and save the Green option.

Main Menu

Press any NavKey to display the 6 menu options. Then use the Navkeys to navigate to the desired menu option. You can also press the dialing key assigned for each icon (see information below for the assigned key numbers), to activate that menu option.

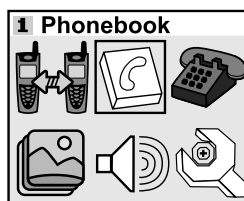



Intercom  (dialing key 1) - Talk between Handsets(s), or use to page the cordless Handset(s).

Phonebook  (dialing key 2) - Enter and retrieve up to 50 names and phone numbers, each can be assigned a distinctive ring and image.

Calls Log  (dialing key 3) - Review Caller ID data; select and dial from the Caller ID data or from the Redial list which contains the last 10 phone numbers dialed.

Pictures  (dialing key 4) - Choose from the many preset images or download new images into the Handset to be used as your idle screen (wall paper) or assign an image to a specific phonebook directory.

Sounds & Alerts  (dialing key 5) - Record custom sound clips, turn ringer and vibrate feature on and off, select main ringer tone, turn tones (low battery, keypad, and out-of-range) on or off.

Settings  (dialing key 6) - Set the time, adjust screen contrast, reset to default settings, change color of the text, register new Handsets, change screen language.

Press the NavKeys to navigate to the desired menu option, then press the middle NavKey to select the highlighted option. You can also press the dialing key assigned to each menu item. The top menu is assigned to dialing key 1 and so forth on down the menu.

NOTE: After 30 seconds of inactivity, your Handset will go into screen saver mode. While in screen saver mode the Handset will display a clock and new calls count (if you have new calls). To illuminate the screen, read the clock and see the new calls count, simply press the volume button on the right side of the Handset.

Handset Menu

Intercom



From Handset to Handset:

- With the **Intercom** icon highlighted, press the middle NavKey or left softkey.
- Press the up or down NavKey to navigate to the desired Handset.
- Press the middle NavKey, left softkey or the assigned dialing key (1-8).
- The ringing Handset can answer by pressing **ON** or any of the number keys.
- To end an intercom call, press **OFF** on either Handset.

NOTE: To access this feature, you must have an additional Handset. To order accessory Handsets, please refer to page 11 for details.

Global Page from Handset:

- With the **Intercom** icon highlighted, press the middle NavKey or press the left softkey.
- Press the up or down NavKey to navigate to **GLOBAL PAGE**. Press the middle NavKey, left softkey or the * key to confirm.
- Any registered Handset can answer the global page, thus entering Intercom mode.
- To end the intercom call, press **OFF** on either Handset.

Phonebook



With this icon highlighted, press the middle NavKey or press the left softkey to reveal the contents of your phonebook. If there are no entries, the screen will display **Phonebook is empty**. The **i 5871** Handset can store up to 50 numbers with names in the phonebook directory, along with a distinctive ring and image for each. Each memory location can hold up to 32 digits and up to 16 characters, including spaces.

1 Intercom Call

Handset 2
Handset 3
GLOBAL PAGE

Calling
Handset 2



1 Intercom Call

Handset 2
Handset 3
GLOBAL PAGE

Performing
global page



Handset Menu

When prompted to **Enter Name**, use the digit keys to spell the name. Each press of a key will cause characters to be displayed as follows:

Number Key	Characters (in order)
1	Space & ' , . 1
2	A B C a b c 2
3	D E F d e f 3
4	G H I g h i 4
5	J K L j k l 5
6	M N O m n o 6
7	P Q R S p q r s 7
8	T U V t u v 8
9	W X Y Z w x y z 9
0	0
*	*
#	#

Adding Phonebook Entries

- From the Handset idle (**OFF**) mode, press any NavKey. The **Phonebook** icon should be highlighted.

Press the middle NavKey or left softkey.



- Press **NEW**.

NOTE: When the phonebook is full and **NEW** is pressed, **Phonebook is full** will display and an error tone will sound.

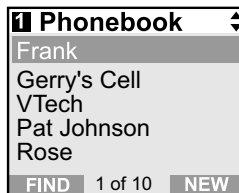

- You will then be prompted to **Enter Name**. Use the digit keys to spell the name. If you make a mistake, press the softkey. To add a space between characters, press the 1 key or the right NavKey twice. When finished, press **OK**.

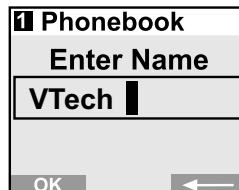



Handset Menu

- Enter the number you want to store in the Phonebook. Press and hold the # key to insert a pause. If you make a mistake, press the  softkey. When finished, press **OK**.



The screen will display:

NOTE: If you do not wish to assign a distinctive ring tone or image to this Phonebook entry, press **SAVE** now. You must subscribe to Caller ID service for the distinctive ring function to work.

- If you wish to be alerted to calls from this phone number, you can assign a unique ring tone to this Phonebook entry. Press the up or down NavKey to scroll to **RINGER** :  **Default** .
 - Press the left or right NavKey to sample the ringer options.
- OR —
- Press the middle NavKey then press the up or down NavKeys to sample the ringer options.
 - Press **OK** to confirm.
 - If you do not wish to assign a distinctive image to this Phonebook entry, press **SAVE** now.

NOTE: There are 8 traditional ring tones and 12 musical ringers. For **Recordable Ringer**, please refer to page 25 for details.

NOTE: You must subscribe to Caller ID service for the distinctive image feature to work.

- If you wish to be visually alerted to calls from this number by changing to a distinctive image, press the up or down NavKey to scroll to **PICTURE** :  **(none)** .
 - Press the left or right NavKey to sample the pictures and images options.
- OR —
- Press the middle NavKey then press the up or down NavKey to sample the picture and image options.
 - Press **OK** to confirm.

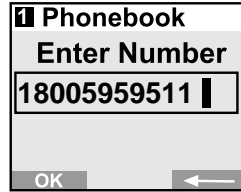

Handset Menu

NOTE: For directions on the **Picture Download Feature**, please refer to page 26.

- Once you've selected a picture, press **SAVE**.

- Your phonebook entry has been saved and the screen will display:

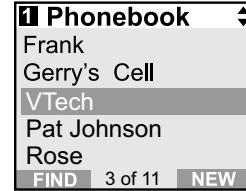
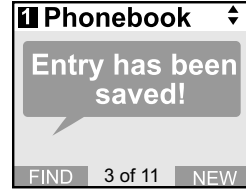

Searching for and Dialing Phonebook Entries

- From the Handset idle (**OFF**) mode, press any NavKey. The Phonebook icon should be highlighted. Press the middle NavKey or the left softkey.
- Press the up or down NavKey to scroll through the contents in alphabetical order.

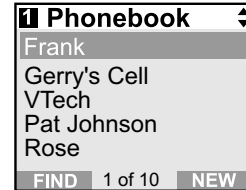

— OR —

You can enter the first characters of the name. The closest match alphabetically will be displayed:

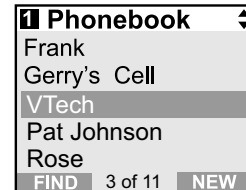

— OR —

You can press the **FIND** softkey, enter the first few characters of the name and then press **OK** to search. If you make a mistake, press the **←** softkey. The closest match alphabetically will be displayed.

- Once you find the entry you want, simply press **ON** or **SPEAKERPHONE** to dial the number.

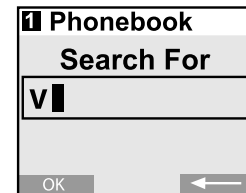

Editing Phonebook Entries

- Following the first 2 steps in **Searching for and Dialing Phonebook Entries**, locate the entry you want to edit.

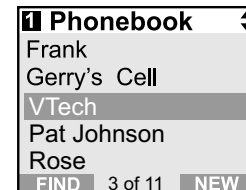

Handset Menu

- Press the middle NavKey. The screen will display:

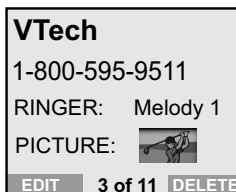

- Press the **EDIT** softkey.

- Press the up or down NavKey to the option you want to edit then enter the corrections as needed. Press the softkey  to delete.



- When finished, press the **SAVE** softkey. The screen will display the edited entry.



Deleting Phonebook Entries

- Following the first 2 steps in **Searching for and Dialing Phonebook Entries**, locate the entry you want to delete.

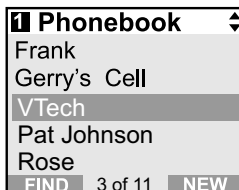

- Press the middle NavKey. The screen will display:

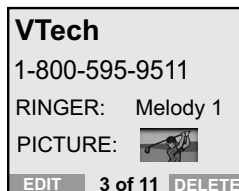

- Press the **DELETE** softkey. The screen will display:

- To confirm deletion, press **YES**. To exit without deleting, press **NO**.

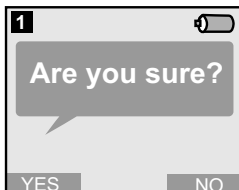

Handset Menu

Calls Log

With this icon highlighted, press the middle NavKey or left softkey to view your Caller ID and Redial options:

Review CID Log
Clear CID Log
Review Redial
Clear Redial

Move the up or down NavKey to highlight the desired option, then press the middle NavKey, left softkey or the dialing key assigned to each menu item. The top menu is assigned to dialing key 1 and so on down the menu options.

NOTE: You can also view your Caller ID and Redial options from the Idle Menu by selecting the **REDIAL** and **CID LOG** using the softkeys.

Review CID Log (dialing key 1) - Allows you to scroll through the 50 most recent Caller ID and Call Waiting records received. With a CID record displayed, you can **SAVE** it in the phonebook, press **ON** or **SPEAKERPHONE** to dial the number, or **DELETE** the entry from the log. Press the middle NavKey while reviewing a CID record to display the dialing options:

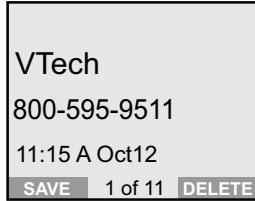

Clear CID Log (dialing key 2) - Choose this option if you want to delete all CID records at once. You will be asked **Are you sure?** Choosing **YES** clears all records. Choosing **NO** returns you to the previous screen.

Review Redial (dialing key 3) - Select this option to display the last 10 numbers dialed. Use the NavKeys to highlight the desired number, press and hold the middle NavKey to view numbers that are longer than 11 digits, then press **ON** or **SPEAKERPHONE** to dial. You can press **SAVE** to save it in the phonebook, or press **DELETE** to erase.

Clear Redial (dialing key 4) - Select this option to delete all phone numbers stored in redial memory. You will be asked **Are you sure?** Choosing **YES** clears all records. Choosing **NO** returns you to the previous screen.

Settings

With this icon highlighted, press the middle NavKey or the left softkey to reveal the following menu:



Appearance (dialing key 1) - This option allows you to change the color of the text at the top and bottom of the Handset screen. Your color choices are:

Blue
Green
Tan
Rose

Handset Menu



Set Time (dialing key 2) - This option allows you to set the time to be displayed on the bottom of the idle screen. If you subscribe to Caller ID, this feature will set and update the clock. Use the number keys to set or change the time.



Contrast (dialing key 3) - This option allows you to adjust the Handset screen contrast.



Phone Setup (dialing key 4) - This option allows you to return the Handset to Enter Base ID and change the **TONE/PULSE** setting.



Language (dialing key 5, preset to English) - This option allows you to change the screen prompts to English, Spanish or French.



Reset Settings (dialing key 6) - This option allows you to return the Handset to factory preset settings. There are four options you can reset:

Clear My Clips

Clear My Pictures

Clear Phonebook

Default Settings

Choose the option you want to reset. You will be asked **Are you sure?** Choose **YES** to reset. Choose **NO** to return to the previous screen.

Press the NavKeys to navigate to the desired option and to make the change, or press the dialing key that is assigned to the icon.

To confirm, press the middle NavKey or press the **SAVE** softkey.

Sounds & Alerts



With this icon highlighted, press the middle NavKey or the left softkey to reveal the following options:



Sound Clips (dialing key 1) - This option allows you to record and access your personal melodies. See **Recordable Ringer** on page 25 for details.



Ringer Control (dialing key 2) - This option allows you to change the Ringer Volume, turn the Ringer **On/Off** and control the Vibrating Ringer.



Ringers (dialing key 3) - This option allows you to assign a new Ring Tone. You can choose one of 8 traditional ringers or 12 musical ringers. Please refer to **Recordable Ringer** on page 25 for details on how to record your own personalized ringer.

Handset Menu



Low Battery Tone (dialing key 4) - This option allows you to turn the Low Battery Tone **On/Off**.



Keypad Tone (dialing key 5) - This option allows you to turn the Keypad Tone **On/Off**.



Range Tone (dialing key 6) - This option allows you to turn the Range Tone **On/Off**.

Press the NavKeys to navigate to the desired option and to make the change, or press the dialing key that is assigned to the icon. To confirm, press the middle NavKey or press the **SAVE** softkey.

Pictures



Your **i 5871** Handset is preset with the following number of images:

Images	--- 18
Emotions	--- 9
My pictures	--- 0
CD ROM	--- 25

You have the ability to assign one image as your background for the idle screen (wallpaper) or assign a specific image to a phonebook directory in the available 50 directories.

Set a Wallpaper image

To set a wallpaper image, select the icon **Pictures**  in the main menu. Then choose an image in one of the three menu options (**My Pictures**, **Images** or **Emotions**). Once you have selected the image, press the  softkey to set the image as your wallpaper. You will receive a message on the screen confirming **Wallpaper Set!** and an audio confirmation.

To assign a personal image into your Handset, see **Picture Download** on page 26 for instructions.

Clear a Wallpaper image

To clear a wallpaper image, select the icon **Pictures**  in the main menu. Select **Clear Wallpaper** using the NavKeys. Then press the middle NavKey or left softkey to clear the wallpaper.

Recordable Ringer



Record a Ringer

You can easily record a unique ringer to be used as either your Default Ringer or for a Distinctive Ringer assigned to a specific phonebook directory. You can record with either the provided Audio Patch Cord (not the USB cord), or with the Handset microphone. You may record up to 9 unique ringers for a maximum of 10 seconds each.

Cued-up music typically produces the best sounding recorded ringer. It is recommended to begin recording your ringer at the beginning of a song, rather than a portion from the middle to produce an audibly pleasing custom ringer.

Note: Your **i 5871** Handset is preset with many musical ringer options (i.e. Jazz, R&B, Reggae, Rock, etc) for you to use as your default ringer or a distinctive ringer. Three of them are protected, you can't replace them. You can replace the other 6 preset ringers with your own. You can also record your own ringers in another 3 blank locations in My Clips. You will find 10 additional sound clips excluding those preset in the Handset on the accompanying CD-ROM.

To record a ringer, follow these steps:

- Select the **Sounds & Alerts** icon  in the Main Menu.
- Select the **Sound Clips** icon .
- If you are using the Audio Patch Cord, insert the 3.5mm plug (the larger end) into the headset jack of your PC or audio source. Insert the 2.5mm plug (the smaller end) into the Headset jack on the side of the **i 5871** Handset.

You can listen to the playing music through your Handset speaker after connecting the Audio Patch Cord and selecting the **Record Preview** menu option. Adjust the recording volume at the audio source. To begin recording, press **RECORD**. If you want to use the Handset microphone to record ringers, select the **Record Clip** menu option. After the beep, and with the Handset microphone facing the audio source, start recording.

NOTE: If the memory is full, the Handset will prompt **Clip memory full!**

- Hit the **STOP** softkey stop the recording.
- After recording, you may **PLAY** or **SAVE** the melody. If you choose **SAVE**, you will be prompted to Enter Clip Name. Enter a name (up to 8 characters) for the recording. If you make a mistake, press the  softkey to backspace. Press **SAVE** to confirm. **Clip has been saved** will display. The melody will be stored in the **My Clips** section. You can listen to all of your recorded musical ringers in **My Clips**. If you want, when in My Clips, you can press **DELETE** then **YES** to erase one of them.

NOTE: When you want to use the Handset microphone to record ringers, do not insert the Audio Patch Cord into the headset jack.

Picture Download

Download Your Own Image

Do you have a favorite image stored in your personal computer that you would like to use as your i 5871 Handset wallpaper or to assign to one of your 50 available phonebook directories? Using the provided Image Editor Software, you can view and convert your image. Once you have selected your file and viewed your image in the software, use the included USB cord to send the converted image directly into the Handset. You'll start by downloading the software into your computer:

One-Time Software Installation

1. Insert the enclosed Image Editor Tool CD into your personal computer.
2. You will see a pop-up window giving you three options:
 - a. Install/Uninstall the Image Editor Software.
 - b. Browse the installation CD.
 - c. Visit Vtech on the web.

To install the software, click on the **Install/Uninstall the Image Editor Software** icon  and follow the download instructions.



3. After the installation process is complete, you will find an **Image Editor Software** icon  on your PC desktop. Click on this icon to run the Image Editor software.

Image Download

Once you have installed the software, follow these steps to view and convert your selected image.

- Click on the **OPEN**  icon. Then the pictures in the accompanied CD-ROM Disc can be found automatically. Or navigate to the directory where your desired image file is stored, and open the file.
- You will see your image displayed in the middle of the screen and inside the telephone display on the right. You can select the following options to edit your image:



-Zoom In and Zoom Out



-Rotate Left and Rotate Right



-Adjust Brightness and Contrast



-Adjust Color

Picture Download

- Before downloading your image, make sure that the provided USB cord is correctly installed into your computer (using the large end of the connector) and Handset (using the small end of the connector). After you have completed the image editing process, press **Send to Phone**  and your image will be downloaded into the Handset. Within a few seconds, you will see the new image displayed on your Handset and it will be saved in your **My Pictures** directory. You have the option to either **SET** (set the picture to be wallpaper) or **DELETE** the downloaded image. You can have a total of 14 images stored in the **My Pictures** directory. You can delete the preset images in this directory to make room for more, if you wish. Additional image samples can be found on the accompanying CD-ROM.

NOTE: Do not leave the USB cord connected to the Handset for an extended period of time as it will drain the battery cells.

NOTE: All preset images in **My Pictures** can be deleted and replaced by new ones. You can store a total of 14 images in **My Pictures**.

Handset Operation

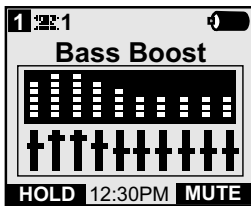
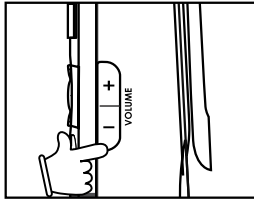
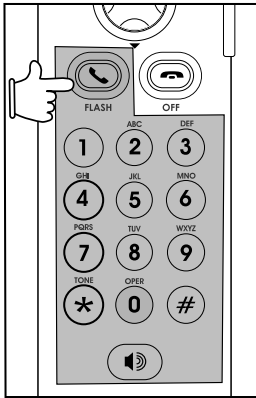
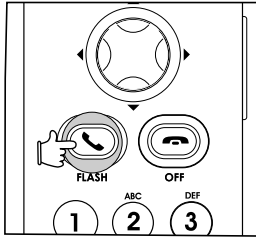

Making Calls



- Press **ON** (or, **SPEAKERPHONE** to use the Handset Speakerphone feature). Dial the phone number.

-OR-

- Dial the phone number first; then press **ON** (or **SPEAKERPHONE**).
- Press **OFF** or place the Handset in the charger cradle to end your call.

Answering Calls

- Press **ON**, **SPEAKERPHONE** or any of number keys.
- Press **OFF** or place the Handset in the charger cradle to end your call.

Adjust the Handset Volume

The volume control is on the right edge of the Handset. During a call, press the ▲ or ▼ key to adjust the listening volume to a comfortable level. The procedure is the same for the Handset earpiece, Headset and Speakerphone.

You can also use the volume control to illuminate the Handset screen to see the clock and new calls count (if you have new calls).

Sound Select

During a call, you can adjust the quality of the sound to best suit your hearing. Pressing **SOUND SELECT** repeatedly will cycle you through four different frequency options:

BASS - Low Frequency sounds enhanced.

Handset Operation

MID - Mid-Range sounds enhanced (This setting is recommended for hearing aid users).

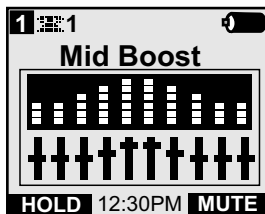

TREBLE - High Frequency sounds enhanced.

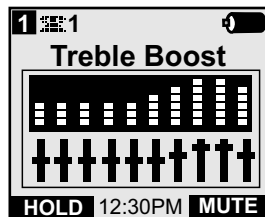

NATURAL - No frequency enhancement (Your Handset is preset to this selection).



The Handset will graphically display these four modes.

NOTE: The Sound Select feature cannot be used when in Speakerphone or Headset talk mode.

Mute Function

During an active call pressing the **MUTE** softkey on the Handset, will disable the microphone. Press **MUTE** again to return to normal two-way conversation.

Hold Function

Press the **HOLD** softkey to place a call on hold. To return to the call, press the **ON** (or **SPEAKER PHONE**) key.

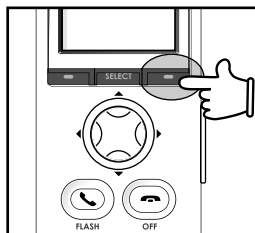

NOTE: The Handset will display **CALL ON HOLD** when a call is placed on hold. If you have new calls in call log, **CALL ON HOLD** will display alternately. An **H** will be displayed to remind you a call is on hold. If a call remains on Hold for 5 minutes, your **i 5871** Handset will ring to remind you the call is being held. The phone will display **Call On Hold Ring Back!** You have 30 seconds to return to the call before it is dropped.

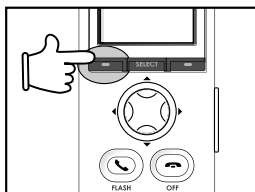

Flash Function

You can use your **i 5871** with services such as Call Waiting. Simply press the **ON/FLASH** key on the Handset to flash the line.

Handset Operation

Handset Locator (from Base):

Press the **PAGE** button from the Base Unit to page all Handsets. Each Handset will beep for 20 seconds to alert you to their locations. To stop the beeping, press **ON** or any dial pad button on the Handset, or **PAGE** on the Base Unit.

Handset Speakerphone Operation

Your **i 5871** Handset has a built-in handsfree speakerphone. This feature allows you to stand the Handset upright on a table or desktop and have handsfree conversations. For more information, refer to **Making Calls** in the **Handset Operation** section.

Line in Use Indication

When the telephone line is currently being used by a **i 5871** system Handset, a status message similar to this will display on idle Handset(s):

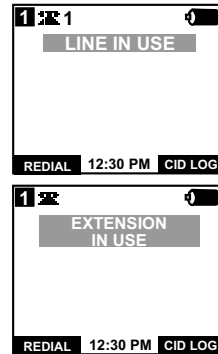

When the telephone line is currently being used another phone (other than an **i 5871** system Handset), the phone icon will remain on steadily, and **EXTENSION IN USE** will be displayed:

Conference Calling

The **i 5871** is capable of supporting conference calls with up to two registered Handsets. To enter a conference call, simply access the line with two extensions by pressing **ON** (or **SPEAKERPHONE**) on the Handset. The phone icon  and two extension numbers will be displayed in the upper left corner of the Handset display.

Transferring Calls

You can transfer calls with the **i 5871** system from Handset to Handset.

Blind Transfer:

You can directly transfer any active call to another **i 5871** extension without notification by following these steps:

- Press the middle NavKey then press the up or down NavKey to the desired location.
- Press the middle NavKey to confirm.
- The ringing Handset can pick up the transferred call like a regular incoming call.

Announced Transfer:

You can perform an announced transfer (call and advise another extension) of an active call by following these steps:

- Press **HOLD** to place your call on hold.
- Press any NavKey then press the left NavKey to select **Intercom**, press the middle NavKey in again to confirm.

-OR-

Press any NavKey then press the **1** key.

- Press the up or down NavKey to the desired location.
- Press the middle NavKey to confirm.
- When the ringing Handset answers, announce that there's an active call on hold.
- Press **OFF** on either handset.
- Press **ON** (on the destination Handset) to pick up the call on hold.

Answering System Operation

Audible Indicators

This system gives you voice prompts for feature operations and voice confirmations when you press a button or complete an operation.

Turn Answering System On/Off

Press **ON/OFF** to manually turn the system on or off. A voice prompt will confirm your selection.

When the answering system is **ON**, the light inside the button will glow steadily. The system will operate using the default settings and pre-recorded announcements set at the factory, until you program the unit.

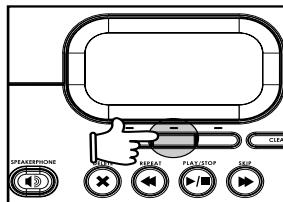

Setting the Clock

1. Make sure the answering system is on.
2. Press **TIME/SET**. The system will announce the current clock setting, then announce "To set date and time, Press **TIME/SET**."
3. Press **TIME/SET**.
4. Press **CHANGE** until the system announces the correct day, then press **TIME/SET**.
5. Press **CHANGE** until the system announces the correct hour, then press **TIME/SET**.
6. Press **CHANGE** until the system announces the correct minutes, then press **TIME/SET**. The system announces the current clock setting.

NOTE: You can press and hold **CHANGE** to advance the minutes in increments of ten.

About Mailboxes

This answering system has three voice mailboxes. Callers using a touch tone phone can select the mailbox in which their messages will be recorded by pressing **1**, **2**, or **3**. All other messages will be recorded in **Mailbox 1**.

About Announcements

- You can record two different announcements - one for normal answering and one for when you've set the system to play the announcement only.
- Use normal answering mode (Announce Only **OFF**) when you want the system to record callers' messages. Use Announce Only mode (set to **ON**) when you want to give information to callers without accepting messages.
- If you choose not to record an announcement, the system answers with a prerecorded announcement which says: "Hello. I'm unable to answer your call right now. Please leave your name, number and a message after the tone." The Announce Only prerecorded announcement says: "Hello, I'm unable to answer your call right now. Please call again. Thank you."
- By setting Announce Only to on or off, you decide which announcement your callers will hear when the system answers a call (the system comes set for normal answering, with Announce Only turned OFF). See **Set Announce Only** on page 33 to change your announcement selection.

Answering System Operation

Record Your Announcement

NOTE: If you have assigned different mailboxes to different people, be sure to tell callers in your announcement to press **1**, **2**, or **3** to leave a message in the appropriate mailbox.

Example of an outgoing announcement using the Mailbox feature:

"We can't come to the phone right now. To leave a message for Bob, press 1 now. To leave a message for Sue, press 2 now. For Elmo, press 3 now. Otherwise, just wait for the beep."

If the caller does not select a Mailbox, their message will be saved in **Mailbox 1**.

1. Press **MENU** until you hear "Set outgoing message".
2. Press **RECORD**. After you hear "Now recording" followed by a beep, speak toward the Base to record an announcement up to 90 seconds long.
3. Press any **PLAY/STOP** button to stop recording. The system plays back your recorded message.

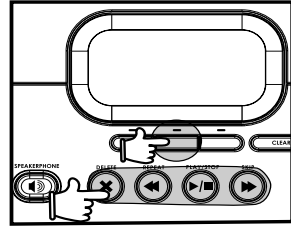

To review your announcement at any time:

1. Press **MENU** until you hear "Set Outgoing Message".
2. Press any **PLAY/STOP** button.

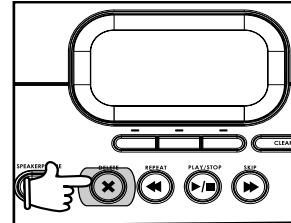

To delete your announcement:

Press **DELETE** during announcement playback. The system will use the pre-recorded announcement until you record a new one.

Answering System Feature Setup

You can set up one feature at a time, or you can set up the first feature and then move on to set up the other features in sequence.

1. Make sure the answering system is on.
2. Press and release **MENU** until you hear the system announce the feature you want to set. Refer to the following **Feature Summary** chart for a description of the features and your choices.
3. Press **CHANGE** to hear the current setting. Continue to press **CHANGE** to adjust the current setting.
4. Press **TIME/SET** to confirm your setting.
5. Press **MENU** to move on to the next feature, or press a **PLAY/STOP** key to exit Feature Setup.

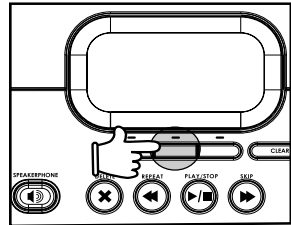

Answering System Operation

FEATURE SUMMARY Default settings indicated by * .

SYSTEM ANNOUNCES:	DESCRIPTION/DIRECTIONS:
<i>“Set Security Code”</i> 50*	Set the remote access code you will use to access features and functions of the answering system from a touch tone phone. The code can be changed to any two-digit number from 40 - 99.
<i>“Set Audible Message Alert”</i> Off*/On	When Message Alert is turned ON, the base beeps once every 10 seconds when new messages have been received.
<i>“Set Announce Only”</i> Off*/On	When you turn Announce Only ON, callers hear your announcement, but cannot leave a message.
<i>“Set Base Ringer”</i> Off/On*	Turn the Base ringer on or off.
<i>“Set Number of Rings”</i> 2 4* 6 Toll Saver	Choose how many times the phone will ring before the system answers a call. With Toll Saver active, the system answers after two rings when you have new messages and after four rings when you have no new messages.

NOTE: You can press and hold **CHANGE** to advance the remote access code in increments of ten.

NOTE: Exit Feature Setup at any time by pressing a **PLAY/STOP** button.

Listen to, Save & Delete Messages

The system automatically saves your messages until you delete them and can store 15 minutes of messages, memos, and announcements (up to a maximum of 99 messages). A message or memo can be up to 4 minutes in length.

Before playing a message, the system announces the day and time it was received. While the message plays, the message window displays the number of the message. After playing the last message in a mailbox, the system announces “*End of messages.*” If the system has less than five minutes of recording time left, it announces the remaining time.

Answering System Operation

Play Messages

Press the desired **MAILBOX** key to play messages in that Mailbox. Press again to stop playback. A Mailbox key will flash if that mailbox contains any unplayed messages. It will glow steadily if it contains only previously heard messages. Press **SKIP/QUICK** to skip to the next message; press and hold **SKIP/QUICK** to speed up playback. Press **REPEAT/SLOW** to repeat a message; press twice to repeat previous message; press and hold **REPEAT/SLOW** to slow down playback.

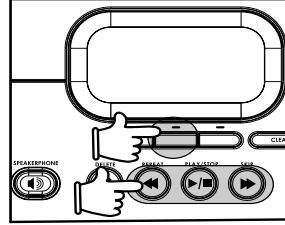

NOTE: If a Mailbox contains a combination of new and old messages, you will only hear unplayed messages, then the system will return to idle mode. Press the **MAILBOX** key again to hear all old messages.

Delete Messages

- Press **DELETE** while a message is playing to delete that message.
- To delete all messages in a mailbox, press **DELETE**, then the appropriate **MAILBOX** button.
- You cannot delete a message until it's been reviewed; deleted messages cannot be recovered.

Adjust Playback Volume

Press **VOL ▲** or **VOL ▼** to adjust the Base speaker volume while playing back messages.

Call Screening/Intercept

1. Make sure the answering system is **ON**. At the Base, set the message playback volume to a level loud enough to hear the caller's message.
2. If you decide to take the call, press **ON** (or **SPEAKERPHONE**) on the Handset. The answering system will return to the idle mode.
3. If you pick up an extension phone during the announcement and the announcement does not stop right away, press and release the telephone switchhook at the extension.

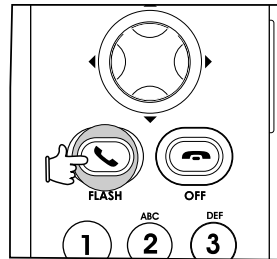

Answering System Operation

Record a Memo

You can record a memo up to four minutes long to store as an incoming message.

1. Press and release **RECORD**.
2. Press a **MAILBOX** button to select a mailbox for the memo. After the beep, speak toward the microphone. The message window displays the length of your memo.
3. To stop recording, press the **PLAY/STOP** button again.

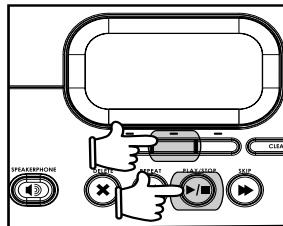

MESSAGE WINDOW DISPLAY

WINDOW DISPLAYS:	WHEN:
0	No messages in any mailbox.
1-99	In idle mode, the total number of messages/memos in all mailboxes. During message playback, the order number of the message being played.
0-99 <-> F	Memory is full, or total number of messages is 99.
Counting 1 to 99	Duration (in seconds) of announcement or memo recording. NOTE: The maximal length of an announcement is 90 seconds.
99 (flashing)	Length of recording is more than 99 seconds.
1-8, steadily for one second	Indicates volume level selected when VOL ▲ or VOL ▼ is pressed.
40-99	Current Remote Access Code (40-99) while setting.
A	Announce Only mode.
ON or OFF	Displayed when Base is turned on or off.
01 <-> normal display	Day and Time need to be set.
... ..	System is answering a call or is in remote operation.
... .. (flashing)	System is in programming mode or initializing.

Answering System Operation

Connect to the Answering System from a Remote Location

You can access many features of this system remotely from a touch tone phone.

1. Dial your telephone number.
2. When the system answers, enter your Remote Access Code (preset to **50**). The system beeps once and then announces the number of new messages.
3. Enter a remote command (see **Remote Access Commands** below).
4. Press ***0** to exit remote operation.

Voice Menu

The system has voice prompts to help you with remote operation. Press ***5** to hear the menu while remotely connected to the answering system.

REMOTE ACCESS COMMANDS

FUNCTION:	COMMAND:
Play messages in a mailbox	Press #, then enter the appropriate mailbox number (1, 2, or 3). The system plays new messages. If there are no new messages, the system plays old messages.
Repeat a message	Press #4 while message is playing; Pressing twice backs up to the previous message.
Skip a message	Press #6 while message is playing; each press advances another message.
Stop	Press #5.
Save messages	Hang up.
Delete a message	Press #9 while message is playing.
Review announcement	Press #7; system plays announcement, then beeps.
Record announcement	Press *7; after beep, record announcement, Press #5 to stop. System plays back announcement.
Record memo	Press *8; then mailbox number where you want memo recorded; speak after beep; press #5 to exit.
End remote access call	Press *0.
Turn system off	Press #0; the system announces, "Answering machine off." Press #0 again to turn the system back on.
Turn system on	When system is off, it answers after 10 rings and announces, "Please enter your security code." Enter your remote access code.

NOTE: If no key is pressed within 10 seconds of entering remote access code, the voice menu will be announced. After the voice menu announcement, if no key is pressed within 20 seconds, the remote access call will automatically end.

Headset Operation

Your **i 5871** Handset is equipped with a 2.5mm Headset Jack for use with an optional accessory Headset for hands-free operation. If you choose to use the Headset option, you must obtain an optional accessory Headset, which is compatible with the **i 5871**. For best results, use a VTech 2.5mm headset.

To purchase a Headset, call VTech Customer Service at 1-800-595-9511.

Once you have a compatible 2.5mm Headset, locate the Headset Jack on the **i 5871** Handset. Connect the plug on the Headset cord to the jack (under a small rubber flag) on the cordless Handset. The plug should fit securely. Do not force the connection.

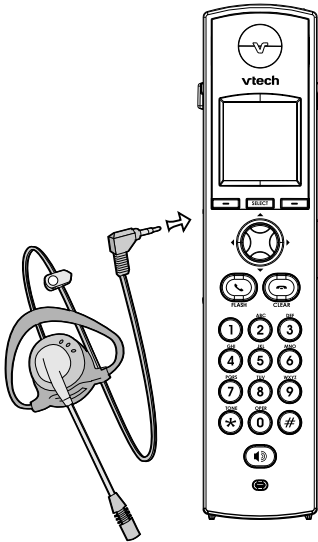

NOTE:

- Whenever a compatible Headset is connected to the cordless Handset, the microphone on the Handset will be muted. This is done to limit the effect of background noise.
- Many compatible Headsets have a reversible, monaural design. This means you can wear your Headset on either ear, leaving one ear free for other conversations.

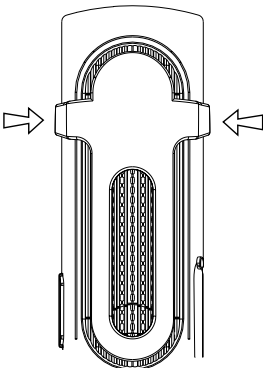

Belt Clip

The **i 5871** is also equipped with a detachable belt clip. Align the pins on the inside edge of the clip with the notches on the sides of the Handset. The belt clip should snap securely into place. Do not force the connection.

In Case Of Difficulty

If you have difficulty operating your phone, the suggestions below should solve the problem. If you still have difficulty after trying these suggestions, call VTech Communications at 1-800-595-9511. In Canada, call VTech Telecommunications Canada Ltd. at 1-800-267-7377.

If the **Check Battery** or **WARNING! Use Rechargeable Batteries Only** warning is displayed on the screen of your Handset or Base Unit:

- Non-rechargeable batteries have been installed. Remove them immediately and replace with rechargeable NiMH batteries (see page 7, 10).
- Rechargeable batteries have been installed but may be old or need to be replaced. Remove them and re-install new rechargeable batteries. Let the new batteries fully charge the Base Unit before you use your phone again. (See page 7, 10, for battery installation).

The phone doesn't work at all:

- Make sure the Power Cord is plugged in.
- Make sure the telephone line cord is plugged firmly into the Base Unit and the telephone wall jack.
- Make sure the batteries are properly charged. If you get a **LOW BATTERY** message or indication, the battery cells need charging.

No dial tone:

- First try all the suggestions above.
- If you still don't hear a dial tone, disconnect the Base Unit from the telephone jack and connect a different phone. If there is no dial tone on that phone either, the problem is in your wiring or local service. Contact your local telephone company.

You get noise, static, or a weak signal even when you're near the Base Unit:

- Household appliances plugged into the same circuit as the Base Unit can sometimes cause interference. Try moving the appliance or the Base Unit to another outlet.

You get noise, static, or a weak signal when you're away from the Base Unit:

- You may be out of range. Either move closer to the Base, or relocate the Base Unit.
- The layout of your home may be limiting the range. Try moving the Base Unit to another position.

The Handset does not ring when you receive a call:

- Make sure you have the ringer activated. Refer to the section(s) on **Sounds & Alerts - Ringer Control** in this User's Manual.
- Make sure the telephone line cord is plugged firmly into the Base Unit and the telephone jack. Make sure the power cord is plugged in.
- You may be too far from the Base Unit.

In Case Of Difficulty

- You may have too many extension phones on your telephone line to allow all of them to ring. Try unplugging some of the other phones.

Your Handset vibrates or shakes when a call comes in:

- It is likely that your Vibrating Handset Ringer option has been set to **ON**. If you'd like to turn it off, see the section on **Sounds & Alerts - Ringer Control** in this User's manual.

You hear other calls while using your phone:

- Disconnect your Base Unit from the telephone jack, and plug in a regular telephone. If you still hear other calls, the problem is probably in your wiring or local service. Call your local telephone company.

You hear noise in the Handset, and none of the keys or buttons work:

- Make sure the power cord is plugged in.

Common cure for electronic equipment:

If the unit does not seem to be responding normally, then try putting the Handset in the cradle. If it does not seem to respond, do the following (in the order listed):

1. Disconnect the power to the Base.
2. Disconnect the Handset battery cells and spare battery compartment's battery cells, if applicable.
3. Wait a few minutes.
4. Connect power to the Base.
5. Re-install the battery cells.
6. Wait for the Handset to re-establish its link with the Base. To be safe, allow up to one minute for this to take place.

Your answering system is not recording messages:

- Make sure system is turned ON (the **ON/OFF** key is illuminated).
- Make sure **Announce Only** feature is set to **OFF**.

You cannot hear recorded messages:

- Using the Base volume control, raise the volume to a comfortable listening level.

CL is flashing in the Base Message Window Display:

- You need to set the day and time. Refer to the section(s) on **Setting the Clock** in this User's Manual.

Maintenance

Taking care of your telephone

Your cordless telephone contains sophisticated electronic parts, so it must be treated with care.

Avoid rough treatment

Place the Handset down gently. Save the original packing materials to protect your telephone if you ever need to ship it.

Avoid water

Your telephone can be damaged if it gets wet. Do not use the Handset outdoors in the rain, or handle it with wet hands. Do not install your Base Unit near a sink, bathtub, or shower.

Electrical storms

Electrical storms can sometimes cause power surges harmful to electronic equipment. For your own safety, use caution when using electric appliances during storms.

Cleaning your telephone

Your telephone has a durable plastic casing that should retain its luster for many years. Clean it only with a soft cloth slightly dampened with water or a mild soap. Do not use excess water or cleaning solvents of any kind.

Remember that electrical appliances can cause serious injury if used when you are wet or standing in water. If your Base Unit should fall into water, **DO NOT RETRIEVE IT UNTIL YOU UNPLUG THE POWER CORD AND TELEPHONE LINE CORDS FROM THE WALL.** Then pull the unit out by the unplugged cords.

Warranty Statement

What does this limited warranty cover?

- The manufacturer of this VTech product, VTech Communications, warrants to the holder of a valid proof of purchase (“Consumer” or “you”) that the product and all accessories provided by VTech in the sales package (“Product”) are free from material defects in material and workmanship, pursuant to the following terms and conditions, when installed and used normally and in accordance with operation instructions. This limited warranty extends only to the Consumer for Products purchased and used in the United States of America.

What will VTech Communications do if the Product is not free from material defects in materials and workmanship during the limited warranty period (“Materially Defective Product”)?

- During the limited warranty period, VTech’s authorized service representative will repair or replace at VTech’s option, without charge, a Materially Defective Product. If we repair this product, we may use new or refurbished replacement parts. If we choose to replace this product, we may replace it with a new or refurbished product of the same or similar design. VTech will return repaired or replacement products to you in working condition. VTech will retain defective parts, modules, or equipment. Repair or replacement of Product, at VTech’s option, is your exclusive remedy. You should expect the repair or replacement to take approximately 30 days.

How long is the limited warranty period?

- The limited warranty period for the product extends for ONE (1) YEAR from the date of purchase if we repair or replace a Materially Defective Product under the terms of this limited warranty. This limited warranty also applies to repaired or replacement Products for a period of either (a) 90 days from the date the repaired or replacement Product is shipped to you or (b) the time remaining on the original one-year warranty; whichever is longer.

What is not covered by this limited warranty?

This limited warranty does not cover:

1. Product that has been subjected to misuse, accident, shipping or other physical damage, improper installation, abnormal operation or handling, neglect, inundation, fire, water or other liquid intrusion; or
2. Product that has been damaged due to repair, alteration or modification by anyone other than an authorized service representative of VTech; or
3. Product to the extent that the problem experienced is caused by signal conditions, network reliability or cable or antenna systems; or
4. Product to the extent that the problem is caused by use with non-VTech electrical accessories; or
5. Product whose warranty/quality stickers, Product serial numbers plates or electronic serial numbers have been removed, altered or rendered illegible; or
6. Product purchased, used, serviced or shipped for repair from outside the United States, or used for commercial or institutional purposes (including but not limited to Products used for rental purposes); or
7. Product returned without valid proof of purchase (see 2 below); or
8. Charges for installation or set up, adjustment of customer controls and installation or repair of systems outside the unit.

Warranty Statement

How do you get warranty service?

- To obtain warranty service in the United States of America, call 1-800-595-9511 for instructions regarding where to return the Product. Before calling for service, please check the user's manual. A check of the Product controls and features may save you a service call.
- Except as provided by applicable law, you assume the risk of loss or damage during transit and transportation and are responsible for delivery or handling charges incurred in the transport of Product(s) to the service location. VTech will return repaired or replaced product under this limited warranty to you, transportation, delivery or handling charges prepaid. VTech assumes no risk for damage or loss of the Product in transit.
- If the Product failure is not covered by this limited warranty, or proof of purchase does not meet the terms of this limited warranty, VTech will notify you and will request that you authorize the cost of repair prior to any further repair activity. You must pay for the cost of repair and return shipping costs for the repair of Products that are not covered by this limited warranty.

What must you return with the Product to get warranty service?

1. Return the entire original package and contents including the Product to the VTech service location along with a description of the malfunction or difficulty;
2. Include "valid proof of purchase" (sales receipt) identifying the Product purchased (Product model) and the date of purchase or receipt; and
3. Provide your name, complete and correct mailing address, and telephone number.

Other Limitations

- This warranty is the complete and exclusive agreement between you and VTech. It supersedes all other written or oral communications related to this Product. VTech provides no other warranties for this product. The warranty exclusively describes all of VTech's responsibilities regarding the product.

There are no other express warranties. No one is authorized to make modifications to this limited warranty and you should not rely on any such modification.

State Law Rights: This warranty gives you specific legal rights, and you may also have other rights which vary from state to state.

Limitations: Implied warranties, including those of fitness for a particular purpose and merchantability (an unwritten warranty that the product is fit for ordinary use) are limited to one year from date of purchase. Some states do not allow limitations on how long an implied warranty lasts, so the above limitation may not apply to you.

- In **no** event shall VTech be liable for any indirect, special, incidental, consequential, or similar damages (including, but not limited to lost profits or revenue, inability to use the product, or other associated equipment, the cost of substitute equipment, and claims by third parties) resulting from the use of this product. Some states do not allow the exclusion or limitation of incidental or consequential damages, so the above limitation or exclusion may not apply to you.

FCC, ACTA and IC Regulations

This equipment complies with Parts 15 of the Federal Communications Commission (FCC) rules for the United States. It also complies with regulations RSS210 and CS-03 of Industry and Science Canada. Operation is subject to the following two conditions: (1) this device may not cause interference, and (2) this device must accept any interference, including interference that may cause undesired operation of the device.

A label is located on the underside of the Base Unit containing either the FCC registration number and Ringer Equivalence Number (REN) or the IC registration number and Load Number. You must, upon request, provide this information to your local telephone company.

This equipment is compatible with inductively coupled hearing aids.

Should you experience trouble with this telephone equipment, please contact: **VTech Communications Inc. CUSTOMER SERVICE at 1-800-595-9511. In Canada, call VTech Telecommunications Canada Ltd. at 1-800-267-7377** for repair/warranty information. The telephone company may ask you to disconnect this equipment from the line network until the problem has been corrected.

FCC Part 15

Warning: Changes or modifications to this unit not expressly approved by the party responsible for compliance could void the user's authority to operate the equipment.

The equipment has been tested and found to comply with part 15 of the FCC rules. These limits are designed to provide reasonable protection against harmful interference in a residential installation. This equipment generates, uses and can radiate radio frequency energy and, if not installed and used in accordance with the instructions, may cause harmful interference to radio communications. However, there is no guarantee that interference will not occur in a particular installation. If this equipment does cause harmful interference to radio or television reception, which can be determined by turning the equipment off and on, the user is encouraged to try and correct the interference by one or more of the following measures:

- Reorient or relocate the receiving antenna.
- Increase the separation between the equipment and receiver.
- Connect the equipment into an outlet or on a circuit different from that to which the receiver is connected.
- Consult the dealer or an experienced radio/TV technician for help.

To ensure safety of users, the FCC has established criteria for the amount of radio frequency energy that can be safely absorbed by a user or bystander according to the intended usage of the product. This product has been tested and found to comply with the FCC criteria. The handset may be safely held against the ear of the user. The base unit shall be installed & used such that parts of the user's body other than the hands should be maintained at a comfortable distance of approximately 20 cm or more.

FCC and ACTA Information

If this equipment was approved for connection to the telephone network prior to July 23, 2001, it complies with Part 68 of the Federal Communications Commission (FCC) rules. If the equipment was approved after that date, it complies with the Part 68 rules and with Technical Requirements for Connection of Equipment to the Telephone Network adopted by the Administrative Council for Terminal Attachments (ACTA). We are required to provide you with the following information.

1. Product identifier and REN information

The label on the back or bottom of this equipment contains, among other things, an identifier indicating product approval and the Ringer Equivalence Number (REN). This information must be provided to your local telephone company upon request. For equipment approved prior to July 23, 2001, the product identifier is preceded by the phrase "FCC Reg No." and the REN is listed separately. For equipment approved after that date, the product identifier

FCC, ACTA and IC Regulations

is preceded by “US” and a colon (:), and the REN is encoded in the product identifier without a decimal point as the sixth and seventh characters following the colon. For example, the product identifier US:AAAEQ03T123XYZ would indicate an REN of 0.3.

The REN is used to determine how many devices you may connect to your telephone line and still have them ring when you are called. In most, but not all areas, the sum of all RENs should be five (5.0) or less. For more information, please contact your local telephone company.

2. Connection and use with the nationwide telephone network

The plug and jack used to connect this equipment to the premises wiring and the telephone network must comply with the applicable Part 68 rules and technical requirements adopted by ACTA. A compliant telephone cord and modular plug is provided with this product. It is designed to be connected to a compatible modular jack that is also compliant. An RJ11 jack should normally be used for connecting to a single line and an RJ14 jack for two lines. See Installation Instructions in this user’s manual. This equipment may not be used with Coin Telephone Lines or with Party Lines. If you have specially wired alarm dialing equipment connected to your telephone line, ensure the connection of this equipment does not disable your alarm equipment. If you have questions about what will disable alarm equipment, consult your telephone company or a qualified installer.

3. Repair instructions

If this equipment is malfunctioning, it must be unplugged from the modular jack until the problem has been corrected. Repairs to this telephone equipment can only be made by the manufacturer or its authorized agents. For repair procedures, follow the instructions outlined under the Limited Warranty.

4. Rights of the telephone company

If this equipment is causing harm to the telephone network, the telephone company may temporarily discontinue your telephone service. The telephone company is required to notify you before interrupting service. If advance notice is not practical, you will be notified as soon as possible. You will be given the opportunity to correct the problem and the telephone company is required to inform you of your right to file a complaint with the FCC. Your telephone company may make changes in its facilities, equipment, operation, or procedures that could affect the proper functioning of this product. The telephone company is required to notify you if such changes are planned.

5. Hearing aid compatibility

If this product is equipped with a corded or cordless handset, it is hearing aid compatible.

6. Programming/testing of emergency numbers

If this product has memory dialing locations, you may choose to store police, fire department and emergency medical service telephone numbers in these locations. If you do, please keep three things in mind:

- a. We recommend that you also write the telephone number on the directory card, so that you can still dial the emergency number manually if the memory dialing feature doesn’t work.
- b. This feature is provided only as a convenience, and the manufacturer assumes no responsibility for customer reliance upon the memory feature.
- c. Testing the emergency telephone numbers you have stored is not recommended.

FCC, ACTA and IC Regulations

However, if you do make a call to an emergency number:

- You must remain on the line and briefly explain the reason for the call before hanging up.
- Programming/testing of emergency numbers should be performed during off-peak hours, such as in the early morning or late evening, when the emergency services tend to be less busy.

IC (Industry Canada)

This telephone is registered for use in Canada.

The term "IC:" before the radio certification number only signifies that Industry Canada technical specifications were met.

Notice: This equipment meets the applicable Industry Canada Terminal Equipment Technical Specifications. This is confirmed by the registration number. The abbreviation, IC, before the registration number signifies that registration was performed based on a Declaration of Conformity indicating that Industry Canada technical specifications were met. It does not imply that Industry Canada approved the equipment.

Notice:

The Ringer Equivalence Number (REN) for this terminal equipment is 0.1. The REN assigned to each terminal equipment provides an indication of the maximum number of terminals allowed to be connected to a telephone interface. The termination on an interface may consist of any combination of devices subject only to the requirement that the sum of the Ringer Equivalence Numbers of all the devices does not exceed five.

Before installing this equipment, users should ensure that it is permissible to be connected to the facilities of the local telecommunications company. The equipment must also be installed using an acceptable method of connection. The customer should be aware that compliance with the above conditions may not prevent degradation of services in some situations.

Repairs to certified equipment should be made by an authorized Canadian maintenance facility designated by the Supplier. Any repairs or alterations made by the user to this equipment, or equipment malfunctions, may give the telecommunications company cause to request the user to disconnect the equipment.

Users should ensure for their own protection that the electrical ground connections of the power utility, telephone lines and internal metallic water pipe system, if present, are connected together. This precaution may be particularly important in rural areas.

Caution:

Users should not attempt to make such connections themselves, but should contact the appropriate electrical inspection authority or electrician as appropriate.

Your Cordless Phone is designed to operate at the maximum power allowed by the FCC and IC. This means your Handset and Base Unit can communicate only over a certain distance - which will depend on the location of the Base Unit and Handset, weather, and the construction and layout of your home or office.

Technical Specifications

FREQUENCY CONTROL

Crystal controlled
PLL synthesizer

TRANSMIT FREQUENCY

Base: 5725-5850 MHz
Handset: 5725-5850 MHz

RECEIVE FREQUENCY

Base: 5725-5850 MHz
Handset: 5725-5850 MHz

CHANNELS

95 Channels

NOMINAL EFFECTIVE RANGE

Maximum power allowed by FCC and IC. Actual operating range may vary according to environmental conditions at the time of use.

SIZE

Handset: 190mm x 42mm x 31mm
Base: 250 mm x 90 mm x 84 mm

WEIGHT

Handset: 145 grams
(excluding Battery Pack)
Base: 463 grams

POWER REQUIREMENTS

Handset: 3 cell AAA 3.6 V 800mAh
NiMH Battery pack
Base: 7 VDC @ 1100mA

MEMORY

Handset:

Phone Book: 100 Memory locations;
up to 32 digits, 16 characters per location

CID: 50 Memory locations

Base:

Phone Book: 100 Memory locations;
up to 32 digits, 16 characters per location

CID: 50 Memory locations

**SPECIFICATIONS ARE TYPICAL
AND MAY CHANGE WITHOUT
NOTICE.**

Table Of Contents

Important Safety Instructions	1
Introduction	3
Parts Check List	4
The Handset Layout	5
The Base Unit Layout	6
Getting Started	7
Setup	7
Connecting Power to Base Unit	7
Installation and Charge of Battery Cells in Handset	7
Charging of the Handset Battery Cells	8
Connecting to Phone Line	8
Checking for Dial Tone	8
Tone/Pulse Selection	9
Spare Battery Charger/ Power Backup Feature	10
Power Guard Feature	10
Installation/Registration of Accessory Handset	11
Installation of Accessory Handset	12
Registration of Accessory Handset	13
Handset and Base Indicators	14
Handset Icons	14
Handset LEDs	15
Base LEDs	15
Basic Operations	16
Handset Menu	16
Menu Shortcuts	16
Main Menu	16
Intercom	17
Phonebook	17
Calls Log	22
Settings	22
Sounds & Alerts	23
Pictures	24
Recordable Ringer	25
Record A Ringer	25
Picture Download	26
Download Your Own Image	26
Image Download	26
Advanced Operations	28
Handset Operation	28
Making Calls	28
Answering Calls	28
Adjust the Handset Volume	28
Sound Select	28
Mute Function	29
Hold Function	29
Flash Function	29
Handset Locator	30
Handset Speakerphone Operation	30
Line in Use Indication	30

Table Of Contents

Conference Calling	30
Transferring Calls	30
Blind Transfer	30
Announced Transfer	30
Answering System Operation	31
Audible Indicators	31
Turn Answering System On/Off	31
Setting the Clock	31
About Mailboxes	31
About Announcements	31
Record Your Announcement	32
Answering System Feature Setup	32
Feature Summary	33
Listen to, Save & Delete Messages	33
Play Messages	34
Delete Messages	34
Adjust Playback Volume	34
Call Screening/Intercept	34
Record a Memo	35
Message Window Display	35
Connect to the Answering System from a Remote Location	36
Voice Menu	36
Remote Access Commands	36
Additional Information	37
Headset Operation	37
Belt Clip	37
In Case of Difficulty	38
Maintenance	40
Warranty Statement	41
FCC, ACTA and IC Regulations	43
Technical Specifications	46

vtech

VTECH TELECOMMUNICATIONS LTD.

vtech A member of THE VTECH GROUP OF COMPANIES.

Distributed in the U.S.A. by VTech Communications, Inc. Beaverton, Oregon, 97008.

Distributed in Canada by VTech Telecommunications Canada Ltd. 200-7671 Alderbridge Way, Richmond, B.C. V6X 1Z9.

Copyright 2004 for VTECH TELECOMMUNICATIONS LTD.

Printed in China

91-00xxxx-010-000
ISSUE 0