

## TEST REPORT

**Report Number: 22070186HKG-001**

Application for Original Grant of 47 CFR Part 15 Certification

New Family of RSS-247 Issue 2 Equipment

**(Baby Unit)**

**FCC ID: EW780-2853-00**

**IC: 1135B-80285300**

**Prepared and Checked by:**

**Approved by:**

Signed On File  
Wong Cheuk Ho, Herbert  
Lead Engineer

---

Lee Shui Tim, Tim  
Assistant Manager  
Date: August 08, 2022

---

Intertek's standard Terms and Conditions can be obtained at our website <http://www.intertek.com/terms/>.

The test report only allows to be revised within the retention period unless further standard or the requirement was noticed.

This report is for the exclusive use of Intertek's Client and is provided pursuant to the agreement between Intertek and its Client. Intertek's responsibility and liability are limited to the terms and conditions of the agreement. Intertek assumes no liability to any party, other than to the Client in accordance with the agreement, for any loss, expense or damage occasioned by the use of this report. Only the Client is authorized to permit copying or distribution of this report and then only in its entirety. Any use of the Intertek name or one of its marks for the sale or advertisement of the tested material, product or service must first be approved in writing by Intertek. The observations and test results in this report are relevant only to the sample tested. This report by itself does not imply that the material, product, or service is or has ever been under an Intertek certification program.

© 2017 Intertek

## TEST REPORT

### GENERAL INFORMATION

|                                    |   |
|------------------------------------|---|
| <b>Applicant Name:</b>             | VTech Telecommunications Ltd.   |
| <b>Applicant Address:</b>          | 23/F., Tai Ping Industrial Centre, Block 1,<br>57 Ting Kok Road, Tai Po,<br>Hong Kong.  |
| <b>FCC Specification Standard:</b> | FCC Part 15, October 1, 2020 Edition  |
| <b>FCC ID:</b>                     | EW780-2853-00   |
| <b>FCC Model(s):</b>               | LF2513 BU, LF2513-2 BU  |
| <b>IC Specification Standard:</b>  | RSS-247 Issue 2, February 2017<br>RSS-Gen Issue 5 Amendment 2, February 2021  |
| <b>IC:</b>                         | 1135B-80285300  |
| <b>HVIN:</b>                       | 35-201972BU   |
| <b>PMN:</b>                        | LF2513 BU, LF2513-2 BU  |
| <b>VTech Model(s):</b>             | LF2513 BU, LF2513-2 BU  |
| <b>Type of EUT:</b>                | Spread Spectrum Transmitter   |
| <b>Description of EUT:</b>         | Video Monitor - Baby Unit   |
| <b>Sample Receipt Date:</b>        | July 06, 2022   |
| <b>Date of Test:</b>               | July 14, 2022   |
| <b>Report Date:</b>                | August 08, 2022   |
| <b>Environmental Conditions:</b>   | Temperature: +10 to 40°C<br>Humidity: 10 to 90%   |
| <b>Conclusion:</b>                 | Test was conducted by client submitted sample. The submitted sample as received complied with the 47 CFR Part 15 / RSS-247 Issue 2 Certification. |

**TEST REPORT**

**TABLE OF CONTENTS**

**1.0 TEST RESULTS SUMMARY & STATEMENT OF COMPLIANCE ..... 4**  
    1.1 Summary of Test Results.....4  
    1.2 Statement of Compliance.....4

**2.0 GENERAL DESCRIPTION ..... 5**  
    2.1 Product Description.....5  
    2.2 Test Methodology .....5  
    2.3 Test Facility .....5

**3.0 SYSTEM TEST CONFIGURATION..... 6**  
    3.1 Justification .....6  
    3.2 EUT Exercising Software.....7  
    3.3 Details of EUT and Description of Accessories.....8  
    3.4 Measurement Uncertainty .....8

**4.0 TEST RESULTS..... 9**  
    4.1 Maximum Conducted Output Power at Antenna Terminals .....9  
    4.2 Maximum 20 dB RF Bandwidth .....12  
    4.3 Minimum Number of Hopping Frequencies.....15  
    4.4 Minimum Hopping Channel Carrier Frequency Separation .....17  
    4.5 Average Channel Occupancy Time .....19  
    4.6 Out of Band Conducted Emissions .....21  
    4.7 Field Strength Calculation.....27  
    4.8 Transmitter Radiated Emissions in Restricted Bands and Spurious Emissions.....28  
    4.8.1 Radiated Emission Configuration Photograph.....29  
    4.8.2 Radiated Emission Data .....29  
    4.8.3 Radiated Emission Test Setup.....30  
    4.9 AC Power Line Conducted Emission .....35  
    4.9.1 AC Power Line Conducted Emission Configuration Photograph.....35  
    4.9.2 AC Power Line Conducted Emission Data .....35  
    4.9.3 AC Line Conducted Emission Test Setup.....38  
    4.10 Occupied Bandwidth .....39

**5.0 EQUIPMENT LIST ..... 40**

## TEST REPORT

### 1.0 TEST RESULTS SUMMARY & STATEMENT OF COMPLIANCE

#### 1.1 Summary of Test Results

| Test Items   | FCC Part 15 Section | RSS-247/<br>RSS-Gen#<br>Section | Results | Details<br>See<br>Section |
|--|---------------------|---------------------------------|---------|---------------------------|
| Antenna Requirement  | 15.203              | 8.3 <sup>#</sup>                | Pass    | 2.1                       |
| Max. Conducted Output Power                                  | 15.247(b)(1) & (4)  | 5.4(2)                          | Pass    | 4.1                       |
| Max. 20dB RF Bandwidth                                       | N/A                 | 5.1(1)                          | Pass    | 4.2                       |
| Min. No. of Hopping Frequencies                              | 15.247(a)(1)(iii)   | 5.1(4)                          | Pass    | 4.3                       |
| Min. Hopping Channel Carrier Frequency Separation            | 15.247(a)(1)        | 5.1(2)                          | Pass    | 4.4                       |
| Average Time of Occupancy                                    | 15.247(a)(1)(iii)   | 5.1(4)                          | Pass    | 4.5                       |
| Out of Band Antenna Conducted Emission                       | 15.247(d)           | 5.5                             | Pass    | 4.6                       |
| Radiated Emission in Restricted Bands and Spurious Emissions | 15.247(d)           | 8.10 <sup>#</sup>               | Pass    | 4.8                       |
| AC Power Line Conducted Emission                             | 15.207 & 15.107     | 8.8 <sup>#</sup>                | Pass    | 4.9                       |

Note: Pursuant to FCC Part 15 Section 15.215(c), the 20dB bandwidth of the emission was contained within the frequency band designated (mentioned as above) which the EUT operated. The effects, if any, from frequency sweeping, frequency hopping, other modulation techniques and frequency stability over expected variations in temperature and supply voltage were considered.

#### 1.2 Statement of Compliance

The equipment under test is found to be complying with the following standards:

FCC Part 15, October 1, 2020 Edition  
RSS-247 Issue 2, February 2017  
RSS-Gen Issue 5 Amendment 2, February 2021

## TEST REPORT

### 2.0 GENERAL DESCRIPTION

#### 2.1 Product Description

The LF2513 BU (35-201972BU) is a Video Monitor - Baby Unit.

The Equipment Under Test (EUT) operates at frequency range of 2405MHz to 2475MHz. There are totally 32 non-overlapping channels with 2MHz channel separation and 16 active channels out of the 32 channels.

The EUT is powered by a AC/DC Adaptor.

The antenna used in the EUT is integral, and the test sample is a prototype.

For FCC, the Model(s): LF2513-2 BU is the same as the Model: LF2513 BU in electronics/electrical designs including software & firmware, PCB layout and construction design/physical design/enclosure as declared by client. The only differences between these models are color and model number to be sold for marketing purpose as declared by client.

The circuit description and frequency hopping algorithm are attached in the Appendix and saved with filename: descri.pdf.

#### 2.2 Test Methodology

Both AC power line-conducted and radiated emission measurements were performed according to the procedures in ANSI C63.4 (2014). Preliminary radiated scans and all radiated measurements were performed in radiated emission test sites. All Radiated tests were performed at an antenna to EUT distance of 3 meters, unless stated otherwise in the "**Justification Section**" of this Application. Antenna port conducted measurements were performed according to ANSI C63.10 (2013). All other measurements were made in accordance with the procedures in 47 CFR Part 2.

#### 2.3 Test Facility

The radiated emission test site, AC power line conducted measurement facility and antenna port conducted measurement facility used to collect the radiated data, AC Power Line conducted data, and conductive data are at Intertek Testing Services Hong Kong Ltd., which is located at Workshop No. 3, G/F., World-Wide Industrial Centre, 43-47 Shan Mei Street, Fo Tan, Sha Tin, N.T., Hong Kong SAR, China. This test facility and site measurement data have been fully placed on file with FCC and Industry Canada No. 2042H, CABID is "HKAP01".

## TEST REPORT

### 3.0 SYSTEM TEST CONFIGURATION

#### 3.1 Justification

For radiated emissions testing, the equipment under test (EUT) was setup to transmit / receive continuously to simplify the measurement methodology. Care was taken to ensure proper power supply voltages during testing. During testing, all cables (if any) were manipulated to produce worst case emissions.

The EUT was powered by 120VAC during test.

For the measurements, the EUT was attached to a plastic stand if necessary and placed on the wooden turntable at 0.8m height from the ground plane for emission testing at or below 1GHz and 1.5m for emission measurements above 1GHz. If the baby unit attached to peripherals, they were connected and operational (as typical as possible). The parent unit was remotely located as far from the antenna and the baby as possible to ensure full power transmission from the parent unit. Else, the base was wired to transmit full power with modulation.

The signal was maximized through rotation and placement in the three orthogonal axes. The antenna height and polarization were varied during the search for maximum signal level. The antenna height was varied from 1 to 4 meters. Radiated emissions were taken at three meters unless the signal level was too low for measurement at that distance. If necessary, a pre-amplifier was used and/or the test was conducted at a closer distance.

For any intentional radiator powered by AC power line, measurements of the radiated signal level of the fundamental frequency component of the emission was performed with the supply voltage varied between 85% and 115% of the nominal rated supply voltage.

For transmitter radiated measurement, the spectrum analyzer resolution bandwidth was 100 kHz for frequencies below 1000 MHz. The resolution bandwidth was 1 MHz for frequencies above 1000 MHz.

Radiated emission measurement for transmitter were performed from the lowest radio frequency signal generated in the device which is greater than 9 kHz to the tenth harmonic of the highest fundamental frequency or to 40 GHz, whichever is lower. Receiver was performed from 30MHz to the fifth harmonic of the highest frequency or 40GHz, whichever is lower.

## TEST REPORT

### 3.1 Justification - Cont'd

Emission that are directly caused by digital circuits in the transmit path and transmitter portion were measured, and the limit are according to FCC Part 15 Section 15.209. Digital circuitry used to control additional functions other than the operation of the transmitter is subject to FCC Part Section 15.109 Limits.

Detector function for radiated emissions was in peak mode. Average readings, when required, were taken by measuring the duty cycle of the equipment under test and subtracting the corresponding amount in dB from the measured peak readings. A detailed description for the calculation of the average factor can be found in section 4.3.4.

Determination of pulse desensitization was made according to *Hewlett Packard Application Note 150-2, Spectrum Analysis... Pulsed RF*. The effective period (Teff) was referred to Exhibit 4.3.4. With the resolution bandwidth 1MHz and spectrum analyzer IF bandwidth 3dB, the pulse desensitization factor was 0dB.

For AC line conducted emission test, the EUT along with its peripherals were placed on a 1.0m(W)x1.5m(L) and 0.8m in height wooden table and the EUT was adjusted to maintain a 0.4 meter space from a vertical reference plane. The EUT was connected to power mains through a line impedance stabilization network (LISN), which provided 50ohm coupling impedance for measuring instrument. The LISN housing, measuring instrument case, reference ground plane, and vertical ground plane were bounded together. The excess power cable between the EUT and the LISN was bundled.

All connecting cables of EUT and peripherals were manipulated to find the maximum emission.

All relevant operation modes have been tested, and the worst-case data is included in this report.

### 3.2 EUT Exercising Software

The EUT exercise program used during radiated and conducted testing was designed to exercise the various system components in a manner similar to a typical use.

## TEST REPORT

### 3.3 Details of EUT and Description of Accessories

#### Details of EUT:

An AC adaptor (provided with the unit) was used to power the device. Their description(s) are listed below.

- (1) An AC adaptor (Model VT05EUS05100; Input 100-240VAC 50/60Hz 0.15A; Output 5VDC 1A 5W)  
(Provided by Applicant)

#### Description of Accessories:

- (1) Parent Unit, Model: LF2153 PU (Provided by Client)

There are no accessories for compliance of this product.

### 3.4 Measurement Uncertainty

Decision Rule for compliance: For FCC/IC standard, the measured value must be within the limits of applicable standard without accounting for the measurement uncertainty. For EN/IEC/HKTA/HKTC standard, conformity rules will be used as per standard directly excepted EN/IEC 61000-3-2, EN/IEC 61000-3-3, HKTA1004, HKCA1008, HKTA1019, HKTA1020, HKTA1041 and HKTA1044. For these excepted or not mentioned standards, Cl 4.2.2 of ILAC-G8:09/2019 decision rules will be reference and guard band will be equal to our measurement uncertainty with 95% confidence level (k=2). In case, the measured value is within guard band region, undetermined decision will be used. The values of the Measurement uncertainty for radiated emission test and RF conducted measurement test are  $\pm 5.3\text{dB}$  and  $\pm 0.99\text{dB}$  respectively. The value of the Measurement uncertainty for conducted emission test is  $\pm 4.2\text{dB}$ .

Uncertainty and Compliance - Unless the standard specifically states that measured values are to be extended by the measurement uncertainty in determining compliance, all compliance determinations are based on the actual measured value.



**TEST REPORT**

**4.0 TEST RESULTS**

RF Conducted measurement Test Setup by a Spectrum Analyzer.

The figure below shows the test setup, which is utilized to make these measurements.

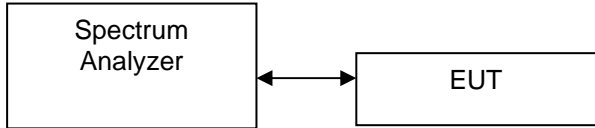

**4.1 Maximum Conducted (peak) Output Power at Antenna Terminals**

- The antenna power of the EUT was connected to the input of a power meter. Power was read directly and cable loss correction was added to the reading to obtain power at the EUT antenna terminals.
- The antenna port of the EUT was connected to the input of a spectrum analyzer. The analyzer was set for RBW>20dB bandwidth and power was read directly in dBm. External attenuation and cable loss were compensated for using the OFFSET function of the analyzer.

(Baby Unit) Antenna Gain = 0 dBi

| Frequency (MHz)      | Output in dBm | Output in mWatt |
|----------------------|---------------|-----------------|
| Low Channel: 2405    | 14.26         | 26.7            |
| Middle Channel: 2439 | 15.70         | 37.2            |
| High Channel: 2475   | 15.36         | 34.4            |

Cable loss: 0.5 dB External Attenuation: 0 dB

Cable loss, external attenuation:  included in OFFSET function  
 added to SA raw reading

dBm max. output level = 15.70 dBm

Limits:

- 0.125W (21dBm) for antennas with gains of 6dBi or less
- 0.25W (24dBm) for antennas with gains of 6dBi or less
- 1W (30dBm) for antennas with gains of 6dBi or less
- \_\_\_ W (\_\_\_ dBm) for antennas with gains more than 6dBi

The plots of conducted output power are saved as below.

**TEST REPORT**

**PLOTS OF CONDUCTED OUTPUT POWER**

Lowest Channel

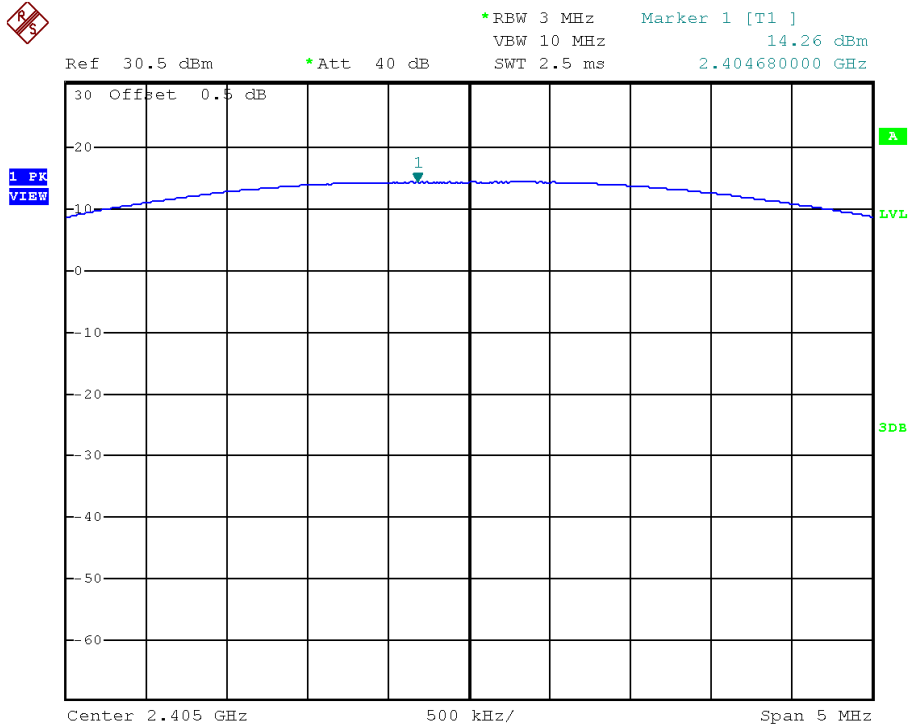

Date: 14.JUL.2022 03:41:56

Middle Channel

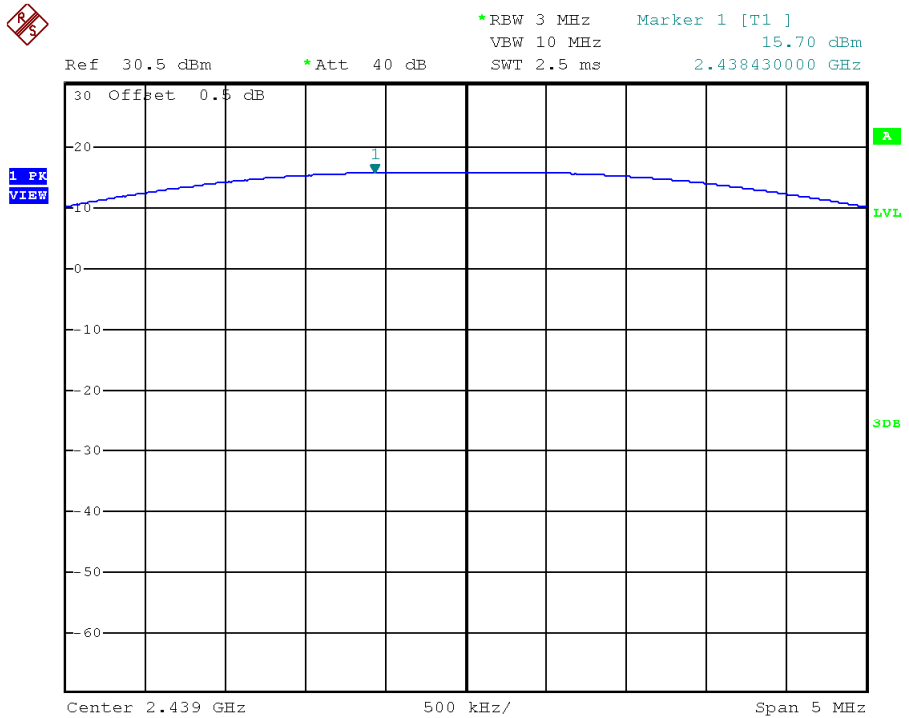

Date: 14.JUL.2022 03:42:42

**TEST REPORT**

**PLOTS OF CONDUCTED OUTPUT POWER**

Highest Channel

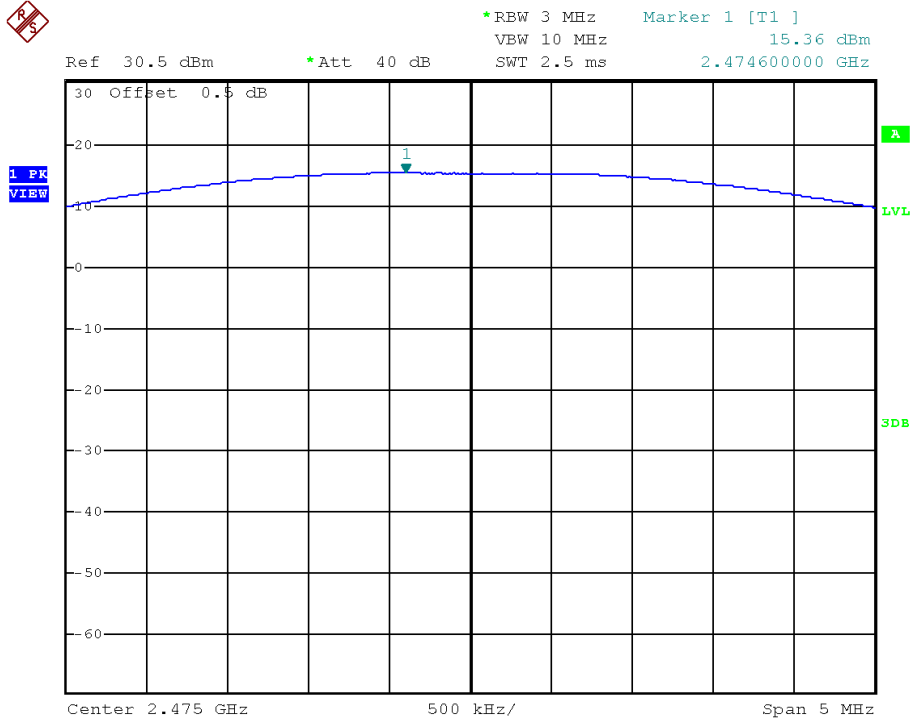

Date: 14.JUL.2022 03:43:28

**TEST REPORT**

4.2 Maximum 20 dB RF Bandwidth

The antenna port of the EUT was connected to the input of a spectrum analyzer. Analyzer RES BW was chosen so that the display was a result of the hopping channel modulation. For each RF output channel investigated, the spectrum analyzer center frequency was set to the channel carrier. A PEAK output reading was taken, a DISPLAY line was drawn 20 dB lower than PEAK level. The 20 dB bandwidth was determined from where the channel output spectrum intersected the display line.

Baby Unit

| Frequency (MHz)      | 20 dB Bandwidth (kHz) |
|----------------------|-----------------------|
| Low Channel: 2405    | 2250                  |
| Middle Channel: 2439 | 2200                  |
| High Channel: 2475   | 2220                  |

Limits

- ≤500kHz for 902-928MHz
- N/A for 2400-2483.5MHz
- ≤1MHz for 5725-5850MHz

The plots of 20dB RF bandwidth are saved as below.

**TEST REPORT**

**PLOTS OF 20dB RF BANDWIDTH**

**Lowest Channel**

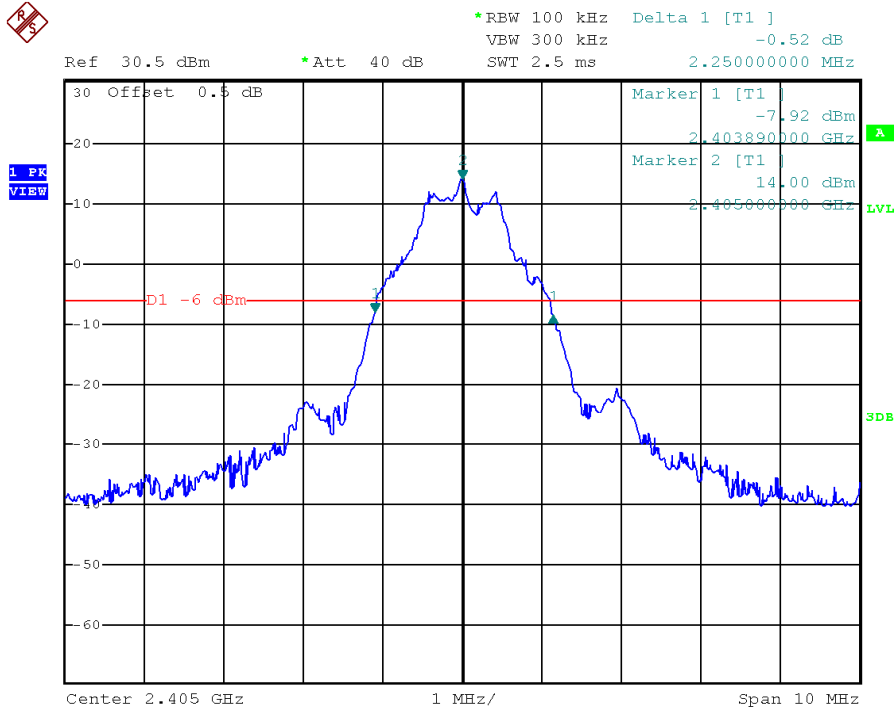

Date: 14.JUL.2022 03:45:55

**Middle Channel**

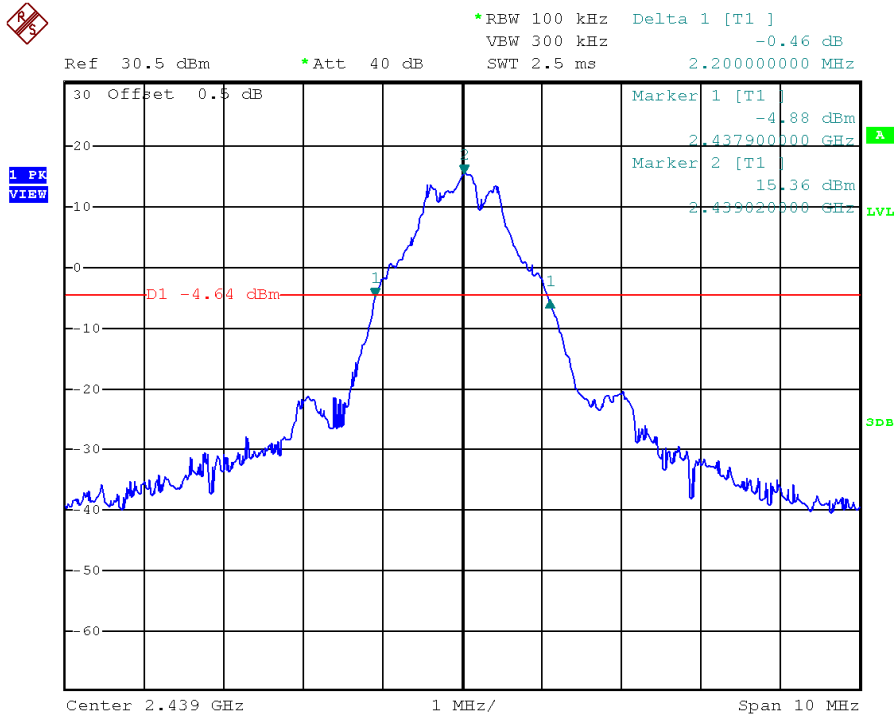

Date: 14.JUL.2022 03:47:27

**TEST REPORT**

**PLOTS OF 20dB RF BANDWIDTH**

Highest Channel

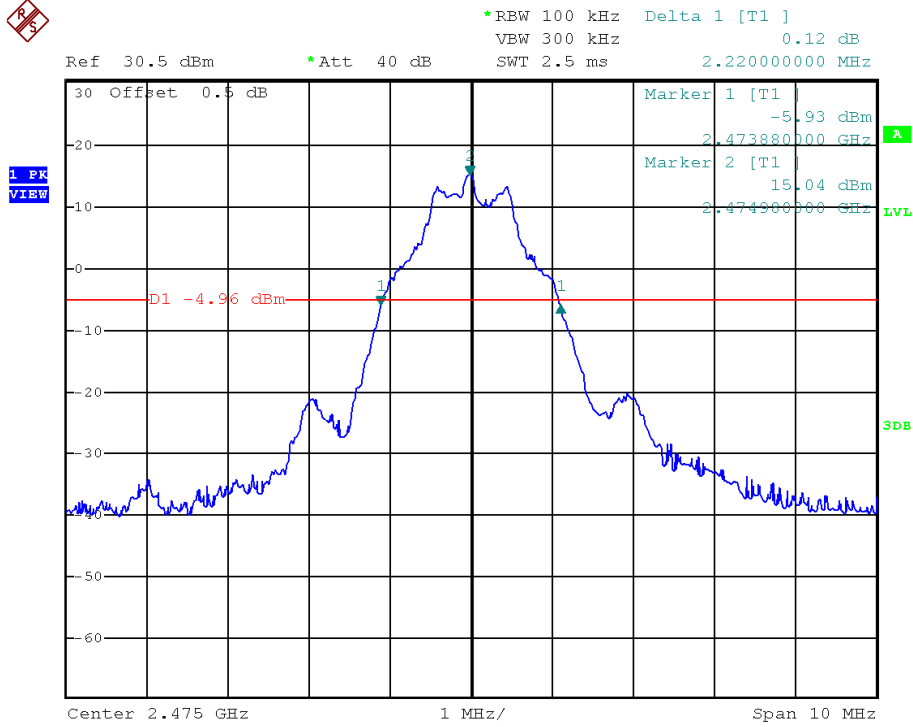

Date: 14.JUL.2022 03:53:00

## TEST REPORT

### 4.3 Minimum Number of Hopping Frequencies

With the analyzer set to MAX HOLD readings were taken for 2-3 minutes in each band. The channel peaks so recorded were added together, and the total number compared to the minimum number of channels required in the regulation.

| Baby Unit               |    |
|-------------------------|----|
| No. of Hopping Channels | 16 |

Minimum Requirements:

- at least 50 hopping channels for 902MHz-928MHz (20 dB bandwidth of hopping channel < 250kHz)
- at least 25 hopping channels for 902MHz-928MHz (20 dB bandwidth of hopping channel ≥ 250kHz)
- at least 15 hopping channels for 2400MHz-2483.5MHz.
- at least 75 hopping channels for 5725MHz-5850MHz.

The plot of number of hopping frequencies is saved as below.

### TEST REPORT

### PLOTS OF NUMBER OF HOPPING FREQUENCIES

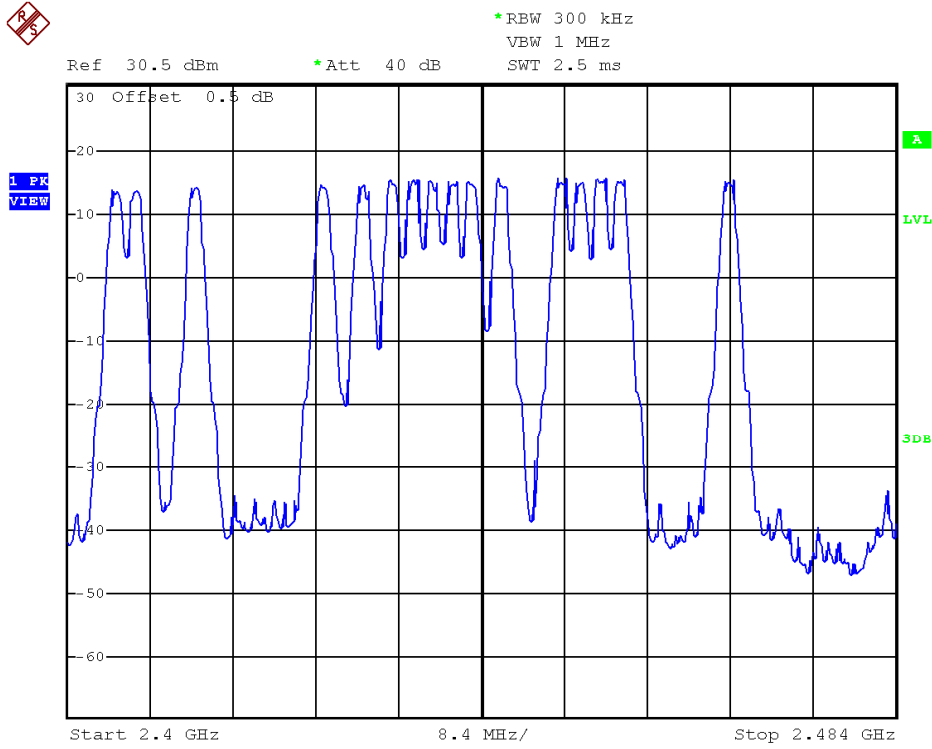

Date: 14.JUL.2022 03:20:37



## TEST REPORT

### 4.4 Minimum Hopping Channel Carrier Frequency Separation

Using the DELTA MARKER function of the analyzer, the frequency separation between two adjacent channels was measured and met the requirement.

|  | Baby Unit |
|--|-----------|
| Channel Separation (Channel 2405MHz and Channel 2407MHz) | 2000kHz   |

**Limits:**

The channel separation must be larger than:

- 25 kHz
- 20 dB bandwidth of hopping channel: \_\_\_ Hz
- 2/3 of 20dB bandwidth of hopping channel: 1500kHz

The plot of hopping channel carrier frequency separation is saved as below.

**TEST REPORT**

**PLOTS OF HOPPING CHANNEL CARRIER FREQUENCY SEPARATION**

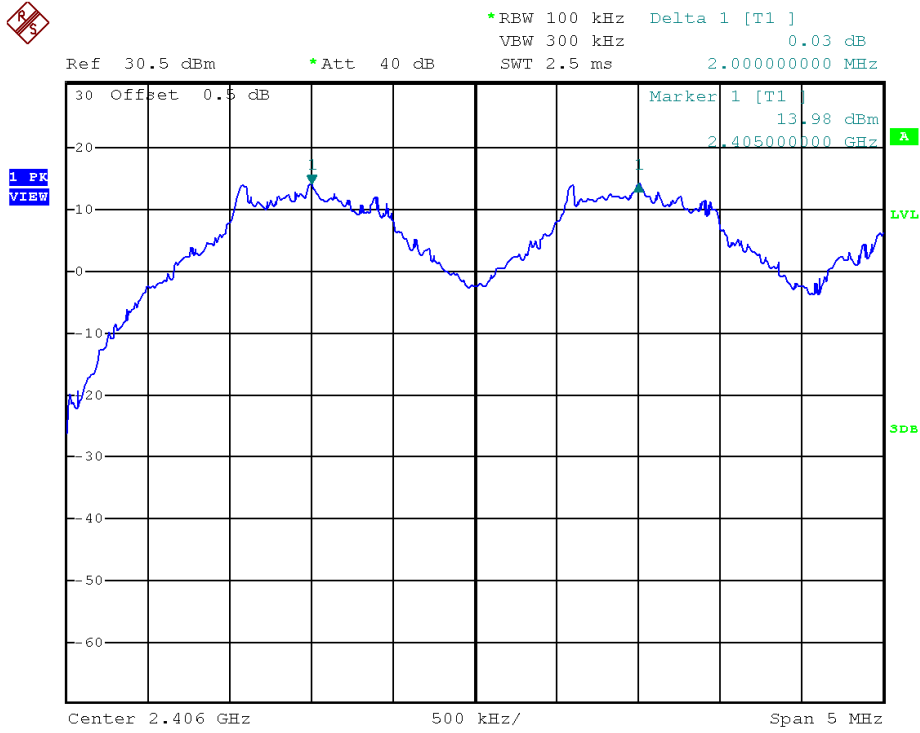

Date: 14.JUL.2022 03:19:18

## TEST REPORT

### 4.5 Average Channel Occupancy Time

The spectrum analyzer center frequency was set to one of the known hopping channels. The SWEEP was set to 1ms, the SPAN was set to ZERO SPAN, and the TRIGGER was set to VIDEO. The time duration of the transmission so captured was measured with the MARKER DELTA function.

The SWEEP was then set to the time required by the regulation (20 seconds for 902-928 MHz devices, if the 20dB bandwidth is less than 250kHz, 10 seconds for 902-928 MHz if the 20dB bandwidth is or greater than 250kHz, "0.4 seconds x Number of hopping channels employed" seconds for 2400-2483.5 MHz, 30 seconds for 5725-5850 MHz). The analyzer was set to SINGLE SWEEP, the total ON time was added and compared against the limit (0.4 seconds).

Baby Unit (worst-case: 1 parent unit operation)

---

|   |                       |
|---|-----------------------|
| Average Occupancy Time<br>(Traffic – in a clear RF environment) = | 7.54ms x 40 = 301.6ms |
|---|-----------------------|

---

Limits:

Average 0.4 seconds maximum occupancy in:

- 6.4 seconds (0.4 sec. x 16) for 2400MHz-2483.5MHz  
(Traffic – in a clear RF environment)
- 20 seconds for 902MHz-928MHz ≥ 50 hopping channels
- 10 seconds for 902MHz-928MHz ≥ 25 hopping channels
- 30 seconds for 5725-5850MHz

The plots of average channel occupancy time are saved as below.

**TEST REPORT**

**PLOTS AVERAGE CHANNEL OCCUPANCY TIME**

Plot A

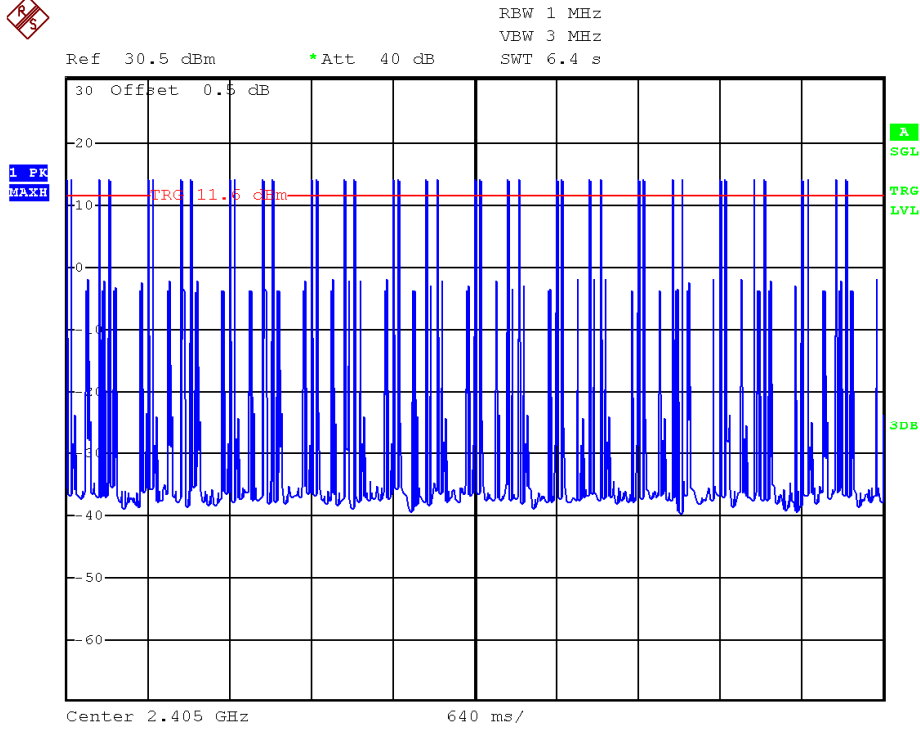

Date: 14.JUL.2022 03:24:43

Plot B

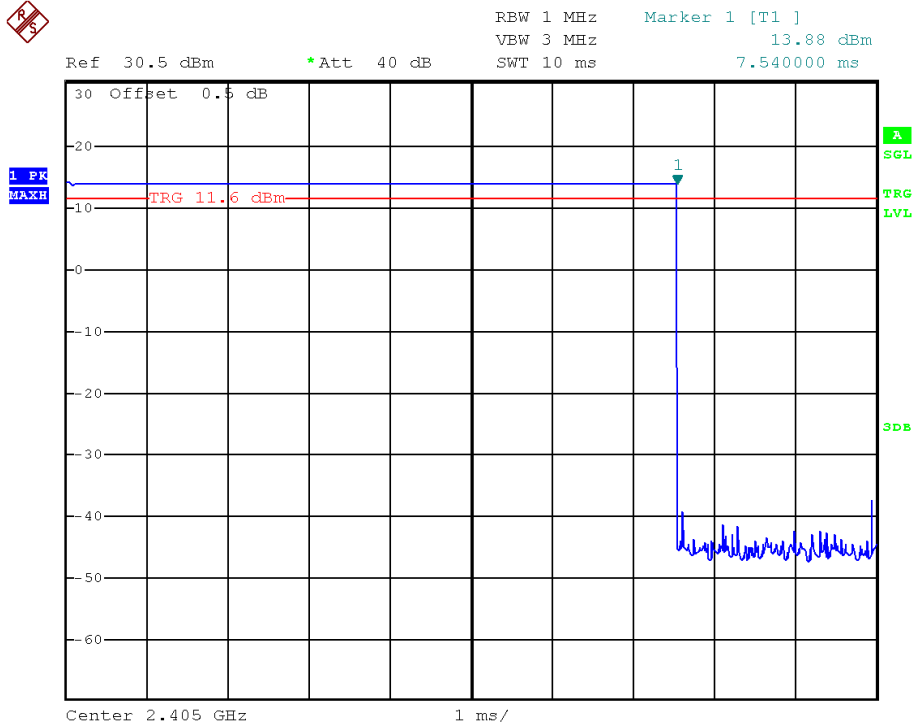

Date: 14.JUL.2022 03:25:21

## TEST REPORT

### 4.6 Out of Band Conducted Emissions

In any 100 kHz bandwidth outside the EUT passband, the RF power produced by the modulation products of the spreading sequence, the information sequence, and the carrier frequency shall be at least 20 dB below that of the maximum in-band 100 kHz emission.

The plot(s) of bandedge compliance is shown the worst-case which has been already considered between enable and disable the hopping function of the EUT.

Furthermore, delta measurement technique for measuring bandedge emissions was incorporated in the test of the edge at 2483.5MHz.

#### Limits:

All spurious emission and up to the tenth harmonic was measured and they were found to be at least 20 dB below the highest level of the desired power in the passband.

The plots of out of band conducted emissions are saved as below.

**TEST REPORT**

**PLOTS OF OUT OF BAND CONDUCTED EMISSIONS**

**Lowest Channel, Plot 1**

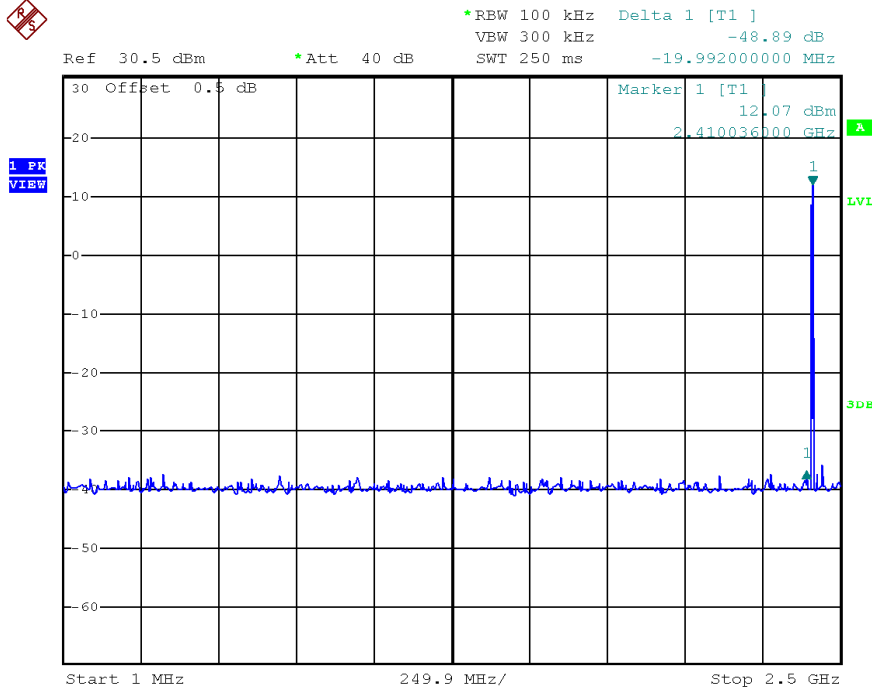

Date: 14.JUL.2022 04:01:42

**Lowest Channel, Plot 2**

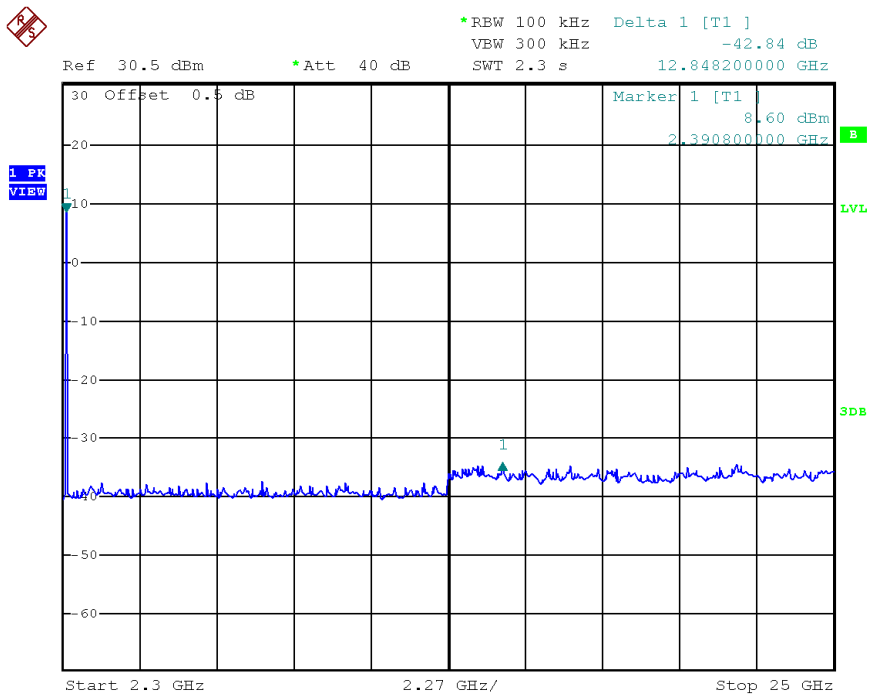

Date: 14.JUL.2022 04:02:30

**TEST REPORT**

**PLOTS OF OUT OF BAND CONDUCTED EMISSIONS**

**Middle Channel, Plot 1**

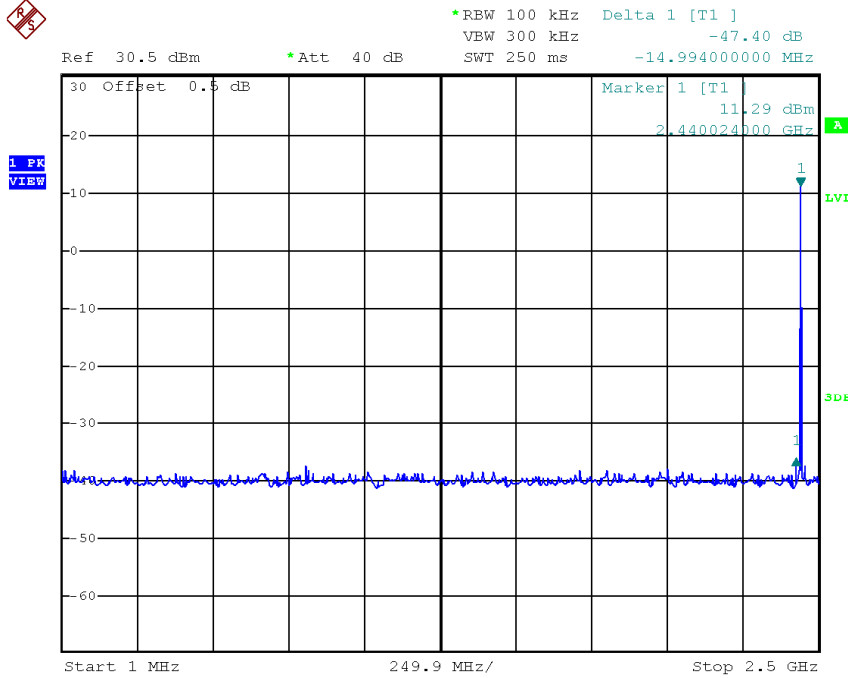

Date: 14.JUL.2022 04:03:17

**Middle Channel, Plot 2**

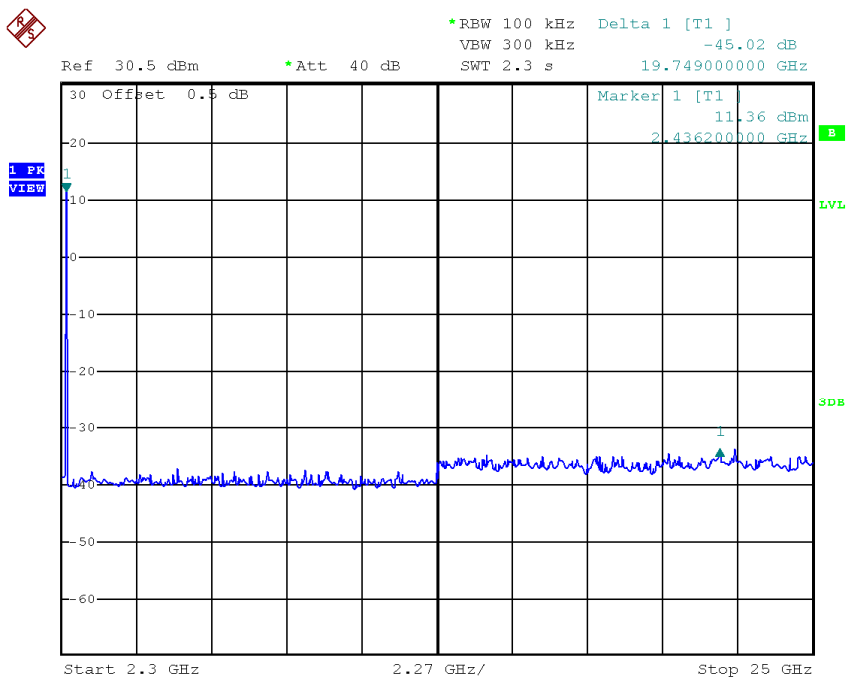

Date: 14.JUL.2022 04:03:48

**TEST REPORT**

**PLOTS OF OUT OF BAND CONDUCTED EMISSIONS**

Highest Channel, Plot 1

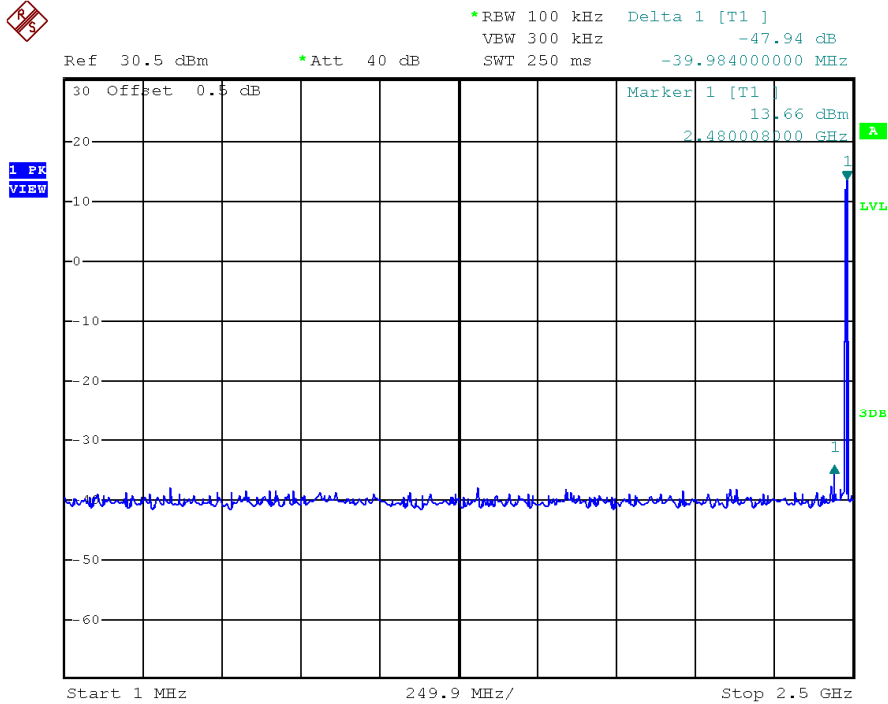

Date: 14.JUL.2022 04:05:03

Highest Channel, Plot 2

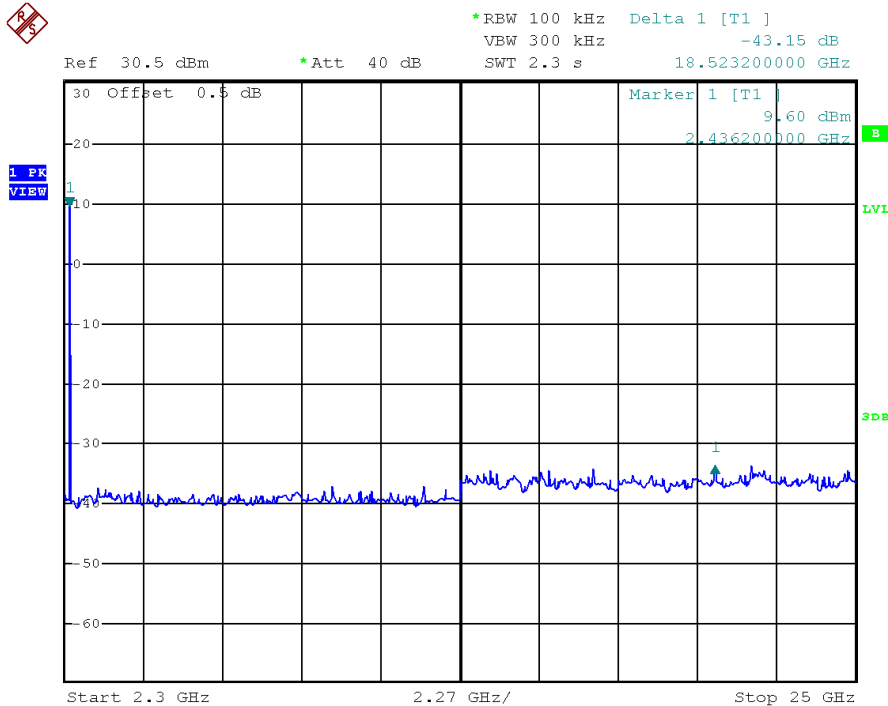

Date: 14.JUL.2022 04:04:33



**TEST REPORT**

**PLOTS OF BANDEGE**

**Lowest Bandedge**

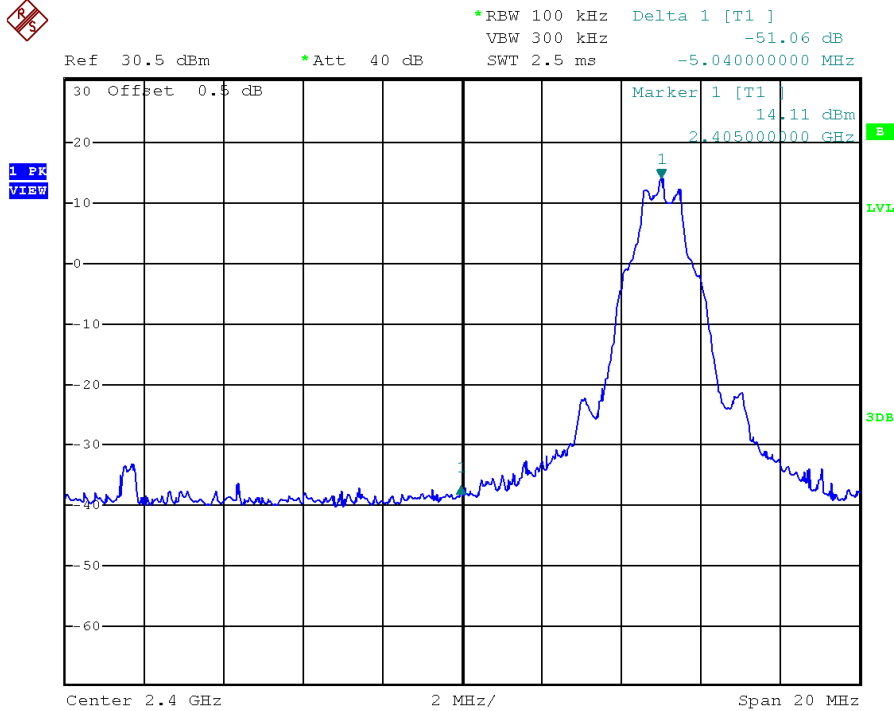

Date: 14.JUL.2022 03:56:32

**Highest Bandedge**

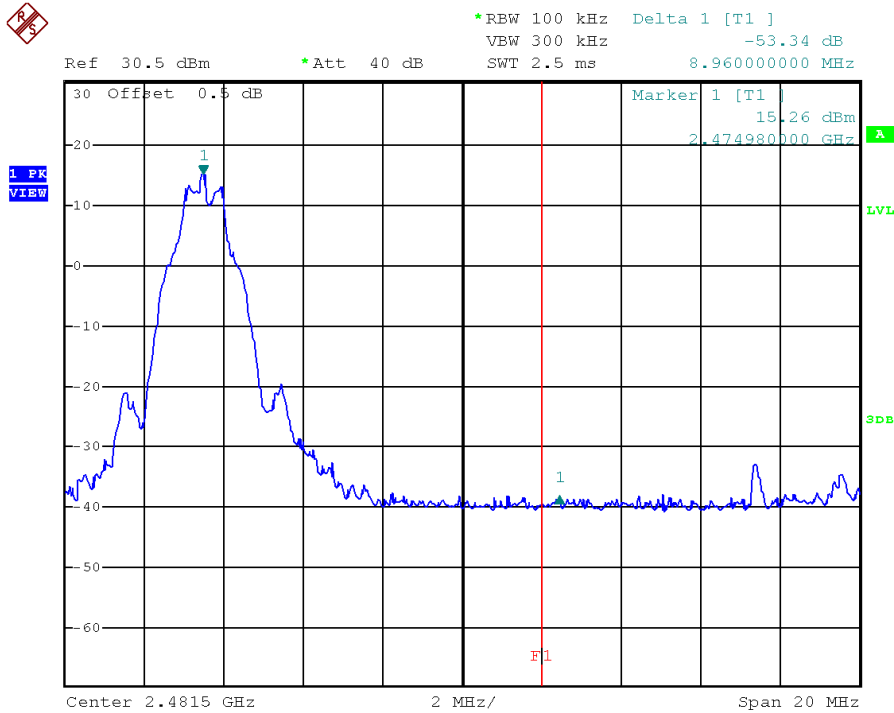

Date: 14.JUL.2022 03:57:54

**TEST REPORT**

**PLOTS OF BANDEGE (HOPPING)**

**Lowest Bandedge**

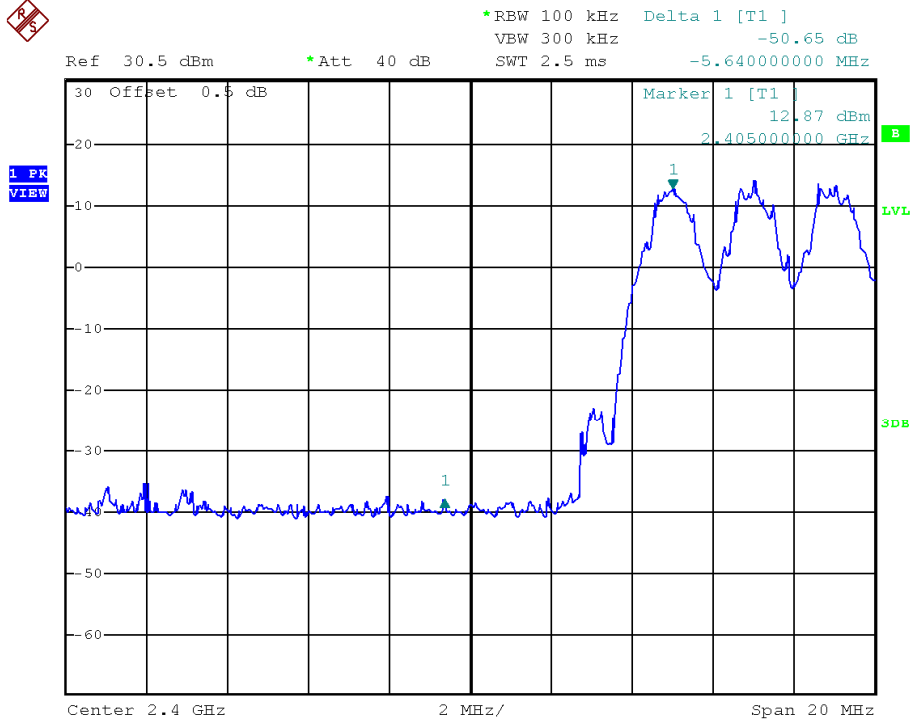

Date: 14.JUL.2022 03:16:43

**Highest Bandedge**

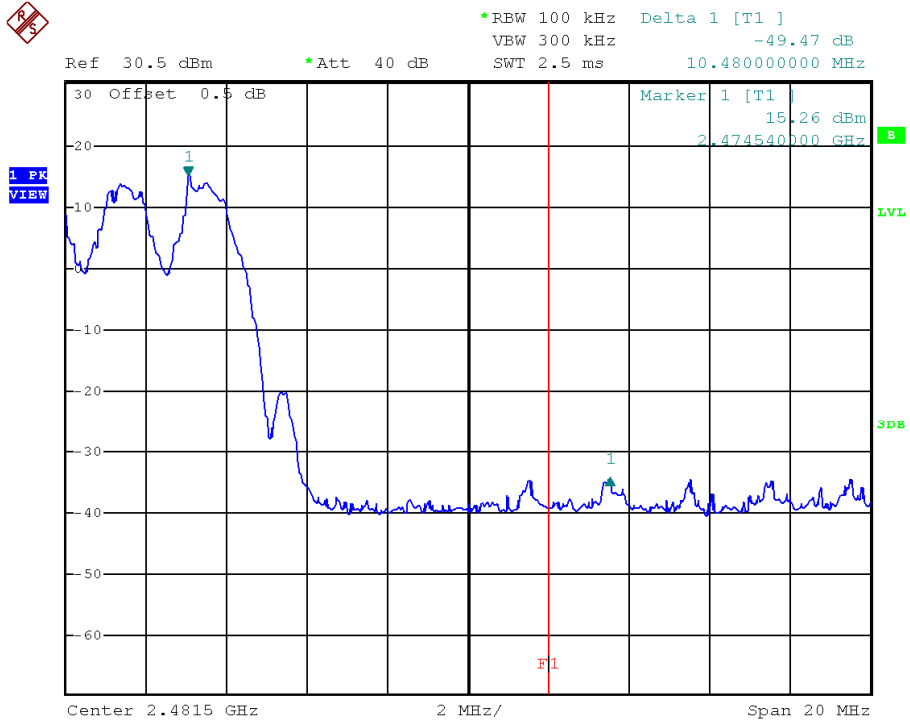

Date: 14.JUL.2022 03:12:23

## TEST REPORT

### 4.7 Field Strength Calculation

The field strength is calculated by adding the reading on the Spectrum Analyzer to the factors associated with preamplifiers (if any), antennas, cables, pulse desensitization and average factors (when specified limit is in average and measurements are made with peak detectors). A sample calculation is included below.

$$FS = RA + AF + CF - AG + PD + AV$$

where

- FS = Field Strength in dB $\mu$ V/m
- RA = Receiver Amplitude (including preamplifier) in dB $\mu$ V
- CF = Cable Attenuation Factor in dB
- AF = Antenna Factor in dB
- AG = Amplifier Gain in dB
- PD = Pulse Desensitization in dB
- AV = Average Factor in -dB

In the radiated emission table which follows, the reading shown on the data table may reflect the preamplifier gain. An example of the calculations, where the reading does not reflect the preamplifier gain, follows:

$$FS = RA + AF + CF - AG + PD + AV$$

#### Example

Assume a receiver reading of 62.0 dB $\mu$ V is obtained. The antenna factor of 7.4 dB and cable factor of 1.6 dB is added. The amplifier gain of 29 dB is subtracted. The pulse desensitization factor of the spectrum analyzer was 0 dB, and the resultant average factor was -10 dB. The net field strength for comparison to the appropriate emission limit is 32 dB $\mu$ V/m. This value in dB $\mu$ V/m was converted to its corresponding level in  $\mu$ V/m.

$$\begin{aligned} RA &= 62.0 \text{ dB}\mu\text{V} \\ AF &= 7.4 \text{ dB} \\ CF &= 1.6 \text{ dB} \\ AG &= 29 \text{ dB} \\ PD &= 0 \text{ dB} \\ AV &= -10 \text{ dB} \\ FS &= 62 + 7.4 + 1.6 - 29 + 0 + (-10) = 32 \text{ dB}\mu\text{V/m} \end{aligned}$$

$$\text{Level in } \mu\text{V/m} = \text{Common Antilogarithm } [(32 \text{ dB}\mu\text{V/m})/20] = 39.8 \mu\text{V/m}$$

## **TEST REPORT**

### **4.8 Transmitter Radiated Emissions in Restricted Bands and Spurious Emissions**

Data is included of the worst-case configuration (the configuration which resulted in the highest emission levels). A sample calculation, configuration photographs and data tables of the emissions are included.

The data on the following pages list the significant emission frequencies, the limit and the margin of compliance.

## TEST REPORT

### 4.8.1 Radiated Emission Configuration Photograph

Worst Case Restricted Band Radiated Emission  
at

Baby Unit: 408.058 MHz

The worst case radiated emission configuration photographs are attached in the Appendix and saved with filename: config photos.pdf

### 4.8.2 Radiated Emission Data

The data in tables 1-4 list the significant emission frequencies, the limit and the margin of compliance.

Judgement -

Baby Unit: Passed by 0.2 dB margin

**TEST REPORT**

4.8.3 Radiated Emission Test Setup

The figure below shows the test setup, which is utilized to make these measurements.

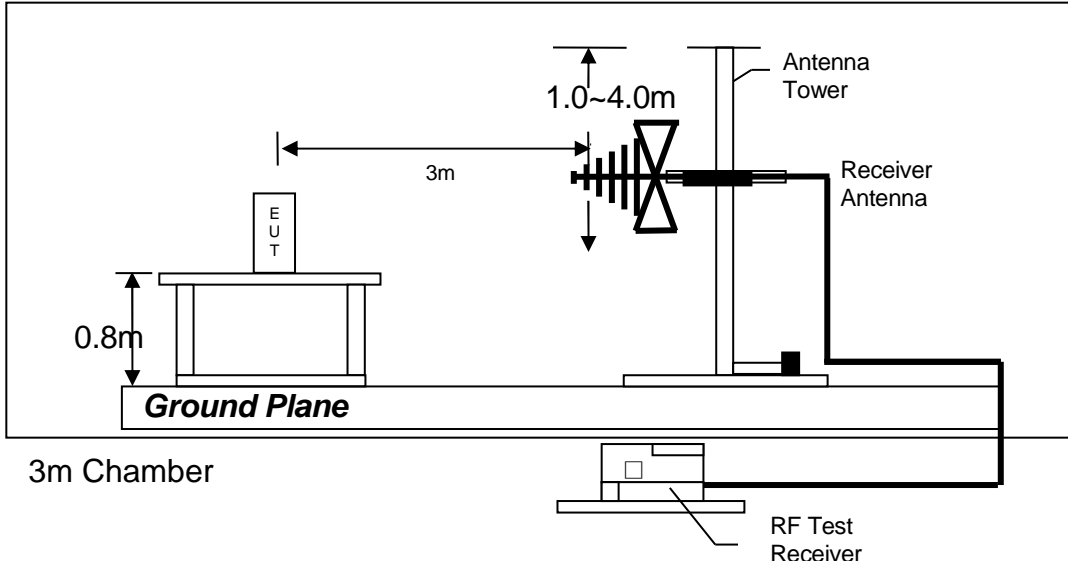

Test setup of radiated emissions up to 1GHz

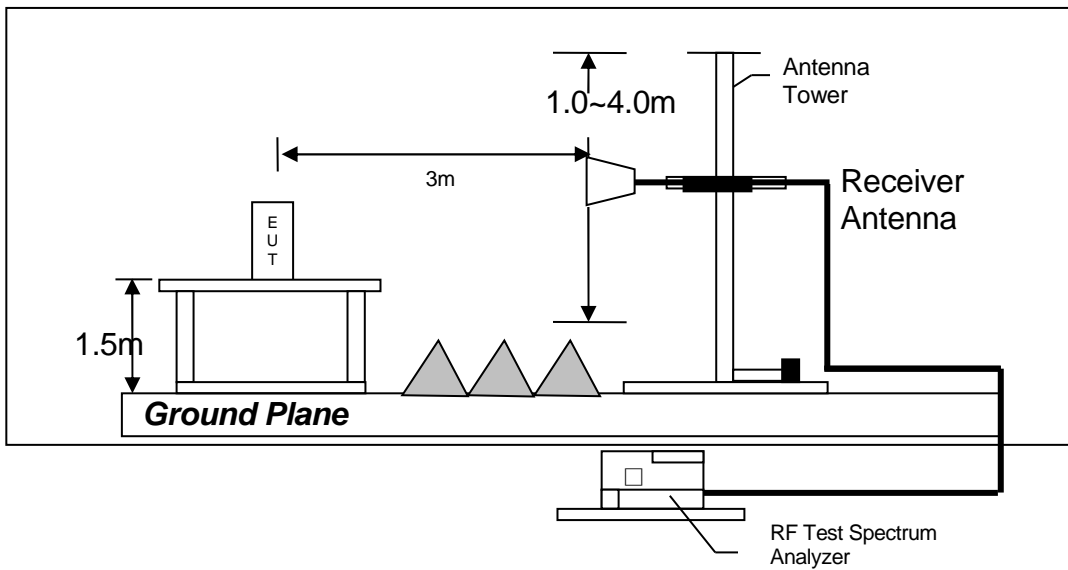

Test setup of radiated emissions above 1GHz

**TEST REPORT**

**RADIATED EMISSION DATA**

Mode: TX-Channel 2405MHz

Table 1, Baby Unit

| Polarization | Frequency (MHz) | Reading (dBµV) | Pre-Amp Gain (dB) | Antenna Factor (dB) | Net at 3m - Average (dBµV/m) | Average Limit at 3m (dBµV/m) | Margin (dB) |
|--------------|-----------------|----------------|-------------------|---------------------|------------------------------|------------------------------|-------------|
| H            | 2390.000        | 57.0           | 33                | 29.4                | 53.4                         | 54.0                         | -0.6        |
| H            | 4810.000        | 31.5           | 33                | 34.9                | 33.4                         | 54.0                         | -20.6       |
| H            | 12025.000       | 26.3           | 33                | 40.5                | 33.8                         | 54.0                         | -20.2       |

| Polarization | Frequency (MHz) | Reading (dBµV) | Pre-Amp Gain (dB) | Antenna Factor (dB) | Net at 3m - Peak (dBµV/m) | Peak Limit at 3m (dBµV/m) | Margin (dB) |
|--------------|-----------------|----------------|-------------------|---------------------|---------------------------|---------------------------|-------------|
| H            | 2390.000        | 70.2           | 33                | 29.4                | 66.6                      | 74.0                      | -7.4        |
| H            | 4810.000        | 54.1           | 33                | 34.9                | 56.0                      | 74.0                      | -18.0       |
| H            | 12025.000       | 40.6           | 33                | 40.5                | 48.1                      | 74.0                      | -25.9       |

- NOTES: 1. Peak detector is used for the emission measurement. Average detector is applied according to ANSI C63.10
2. All measurements were made at 3 meters.
3. Negative value in the margin column shows emission below limit.
4. Horn antenna is used for the emission over 1000MHz.
5. Emissions within the restricted band meets the requirement of FCC Part 15 Section 15.205 / RSS-Gen Section 8.10.

**TEST REPORT**

Mode: TX-Channel 2439MHz

Table 2, Baby Unit

| Polarization | Frequency (MHz) | Reading (dBµV) | Pre-Amp Gain (dB) | Antenna Factor (dB) | Net at 3m - Average (dBµV/m) | Average Limit at 3m (dBµV/m) | Margin (dB) |
|--------------|-----------------|----------------|-------------------|---------------------|------------------------------|------------------------------|-------------|
| H            | 4878.000        | 31.8           | 33                | 34.9                | 33.7                         | 54.0                         | -20.3       |
| H            | 7317.000        | 29.5           | 33                | 37.9                | 34.4                         | 54.0                         | -19.6       |
| H            | 12195.000       | 25.8           | 33                | 40.5                | 33.3                         | 54.0                         | -20.7       |

| Polarization | Frequency (MHz) | Reading (dBµV) | Pre-Amp Gain (dB) | Antenna Factor (dB) | Net at 3m - Peak (dBµV/m) | Peak Limit at 3m (dBµV/m) | Margin (dB) |
|--------------|-----------------|----------------|-------------------|---------------------|---------------------------|---------------------------|-------------|
| H            | 4878.000        | 54.4           | 33                | 34.9                | 56.3                      | 74.0                      | -17.7       |
| H            | 7317.000        | 45.8           | 33                | 37.9                | 50.7                      | 74.0                      | -23.3       |
| H            | 12195.000       | 40.7           | 33                | 40.5                | 48.2                      | 74.0                      | -25.8       |

- NOTES: 1. Peak detector is used for the emission measurement. Average detector is applied according to ANSI C63.10
2. All measurements were made at 3 meters.
3. Negative value in the margin column shows emission below limit.
4. Horn antenna is used for the emission over 1000MHz.
5. Emissions within the restricted band meets the requirement of FCC Part 15 Section 15.205 / RSS-Gen Section 8.10.



**TEST REPORT**

Mode: TX-Channel 2475MHz

Table 3, Baby Unit

| Polarization | Frequency (MHz) | Reading (dBμV) | Pre-Amp Gain (dB) | Antenna Factor (dB) | Net at 3m - Average (dBμV/m) | Average Limit at 3m (dBμV/m) | Margin (dB) |
|--------------|-----------------|----------------|-------------------|---------------------|------------------------------|------------------------------|-------------|
| H            | 2483.500        | 53.1           | 33                | 29.4                | 49.5                         | 54.0                         | -4.5        |
| H            | 4950.000        | 31.3           | 33                | 34.9                | 33.2                         | 54.0                         | -20.8       |
| H            | 7425.000        | 29.2           | 33                | 37.9                | 34.1                         | 54.0                         | -19.9       |
| H            | 12375.000       | 26.2           | 33                | 40.5                | 33.7                         | 54.0                         | -20.3       |

| Polarization | Frequency (MHz) | Reading (dBμV) | Pre-Amp Gain (dB) | Antenna Factor (dB) | Net at 3m - Peak (dBμV/m) | Peak Limit at 3m (dBμV/m) | Margin (dB) |
|--------------|-----------------|----------------|-------------------|---------------------|---------------------------|---------------------------|-------------|
| H            | 2483.500        | 67.3           | 33                | 29.4                | 63.7                      | 74.0                      | -10.3       |
| H            | 4950.000        | 54.3           | 33                | 34.9                | 56.2                      | 74.0                      | -17.8       |
| H            | 7425.000        | 45.7           | 33                | 37.9                | 50.6                      | 74.0                      | -23.4       |
| H            | 12375.000       | 40.8           | 33                | 40.5                | 48.3                      | 74.0                      | -25.7       |

- NOTES: 1. Peak detector is used for the emission measurement. Average detector is applied according to ANSI C63.10
2. All measurements were made at 3 meters.
3. Negative value in the margin column shows emission below limit.
4. Horn antenna is used for the emission over 1000MHz.
5. Emissions within the restricted band meets the requirement of FCC Part 15 Section 15.205 / RSS-Gen Section 8.10.

**TEST REPORT**

Mode: Transmit through Baby Unit

Table 4, Baby Unit

| Polarization | Frequency (MHz) | Reading (dBµV) | Pre-amp (dB) | Antenna Factor (dB) | Net at 3m (dBµV/m) | Limit at 3m (dBµV/m) | Margin (dB) |
|--------------|-----------------|----------------|--------------|---------------------|--------------------|----------------------|-------------|
| V            | 71.952          | 41.4           | 16           | 7.0                 | 32.4               | 40.0                 | -7.6        |
| V            | 119.968         | 32.5           | 16           | 14.0                | 30.5               | 43.5                 | -13.0       |
| V            | 131.972         | 36.5           | 16           | 14.0                | 34.5               | 43.5                 | -9.0        |
| V            | 143.854         | 34.6           | 16           | 14.0                | 32.6               | 43.5                 | -10.9       |
| V            | 155.978         | 33.8           | 16           | 16.0                | 33.8               | 43.5                 | -9.7        |
| V            | 167.982         | 41.2           | 16           | 18.0                | 43.2               | 43.5                 | -0.3        |
| V            | 191.992         | 39.2           | 16           | 16.0                | 39.2               | 43.5                 | -4.3        |
| H            | 312.028         | 33.8           | 16           | 23.0                | 40.8               | 46.0                 | -5.2        |
| H            | 359.922         | 32.8           | 16           | 24.0                | 40.8               | 46.0                 | -5.2        |
| V            | 384.052         | 32.2           | 16           | 24.0                | 40.2               | 46.0                 | -5.8        |
| V            | 400.055         | 31.2           | 16           | 24.0                | 39.2               | 46.0                 | -6.8        |
| V            | 408.058         | 37.8           | 16           | 24.0                | 45.8               | 46.0                 | -0.2        |

- NOTES:
1. Quasi-Peak detector is used for the emission measurement.
  2. All measurements were made at 3 meters.
  3. Negative value in the margin column shows emission below limit.
  4. Emissions within the restricted band meets the requirement of FCC Part 15 Section 15.205 / RSS-Gen Section 8.10.

## TEST REPORT

### 4.9 AC Power Line Conducted Emission

- Not applicable – EUT is only powered by battery for operation.
- EUT connects to AC power line. Emission Data is listed in following pages.

#### 4.9.1 AC Power Line Conducted Emission Configuration Photograph

Worst Case Line-Conducted Configuration  
at

3.11 MHz

The worst-case line conducted configuration photographs are attached in the Appendix and saved with filename: config photos.pdf

#### 4.9.2 AC Power Line Conducted Emission Data

The plot(s) and data in the following pages list the significant emission frequencies, the limit and the margin of compliance.

Passed by 19.6 dB margin

**TEST REPORT**

**AC POWER LINE CONDUCTED EMISSION**

Worst Case: Transmit through Baby Unit



RBW 9 kHz  
MT 1 s

Att 10 dB AUTO PREAMP OFF

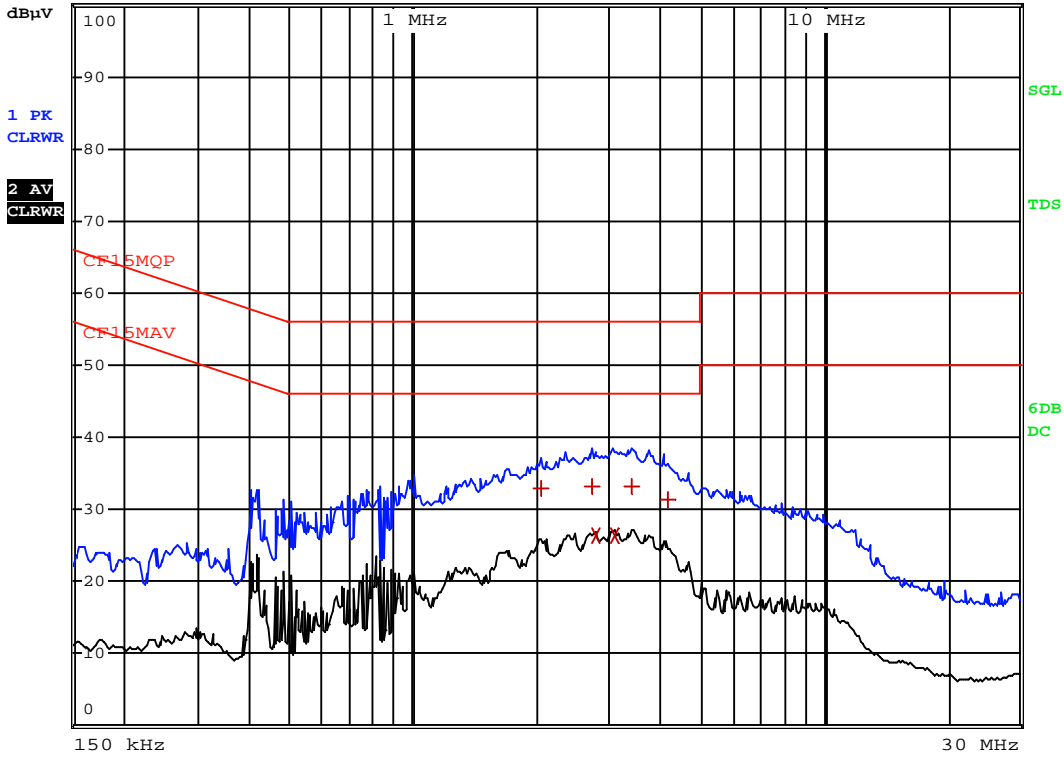

Date: 14.JUL.2022 11:01:45

**TEST REPORT**

Worst Case: Transmit through Baby Unit

| EDIT PEAK LIST (Final Measurement Results) |               |            |                  |    |                |
|--|---------------|------------|------------------|----|----------------|
| TRACE                                      |               | FREQUENCY  | LEVEL dB $\mu$ V |    | DELTA LIMIT dB |
| Trace1:                                    | CF15MQP       |            |                  |    |                |
| Trace2:                                    | CF15MAV       |            |                  |    |                |
| Trace3:                                    | ---           |            |                  |    |                |
| 1  | Quasi Peak    | 2.04 MHz   | 32.86            | L1 | -23.13         |
| 1  | Quasi Peak    | 2.724 MHz  | 33.30            | L1 | -22.69         |
| 2  | CISPR Average | 2.7825 MHz | 26.28            | L1 | -19.71         |
| 2  | CISPR Average | 3.111 MHz  | 26.44            | L1 | -19.56         |
| 1  | Quasi Peak    | 3.4125 MHz | 33.25            | L1 | -22.74         |
| 1  | Quasi Peak    | 4.191 MHz  | 31.46            | L1 | -24.53         |

Date: 14.JUL.2022 11:01:29

## TEST REPORT

### 4.9.3 AC Line Conducted Emission Test Setup

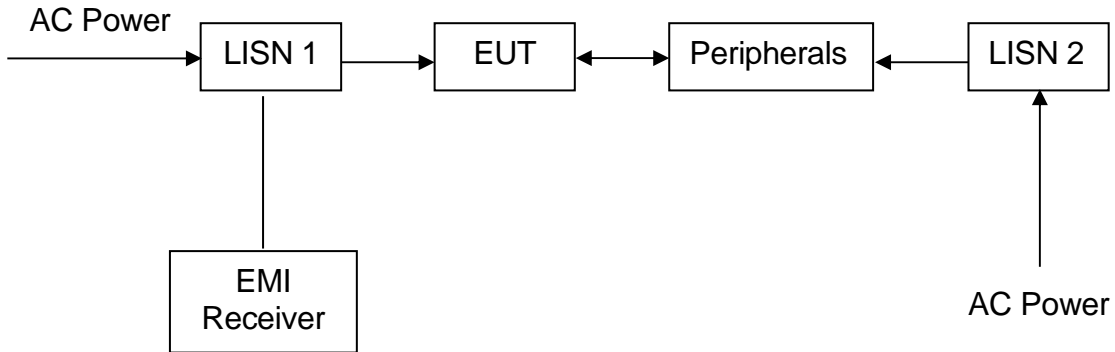

The EUT along with its peripherals were placed on a 1.0m(W)×1.5m(L) and 0.8m in height wooden table and the EUT was adjusted to maintain a 0.4 meter space from a vertical reference plane. The EUT was connected to power mains through a line impedance stabilization network (LISN), which provided 50 ohm coupling impedance for measuring instrument and the chassis ground was bounded to the horizontal ground plane of shielded room. The excess power cable between the EUT and the LISN was bundled.

All connecting cables of EUT and peripherals were moved to find the maximum emission.

**TEST REPORT**

4.10 Occupied Bandwidth

Occupied Bandwidth Results:

| Occupied Bandwidth (kHz) |      |
|--------------------------|------|
| Low Channel: 2405        | 1850 |
| Middle Channel: 2439     | 1780 |
| High Channel: 2475       | 1800 |

The worst case is shown as below

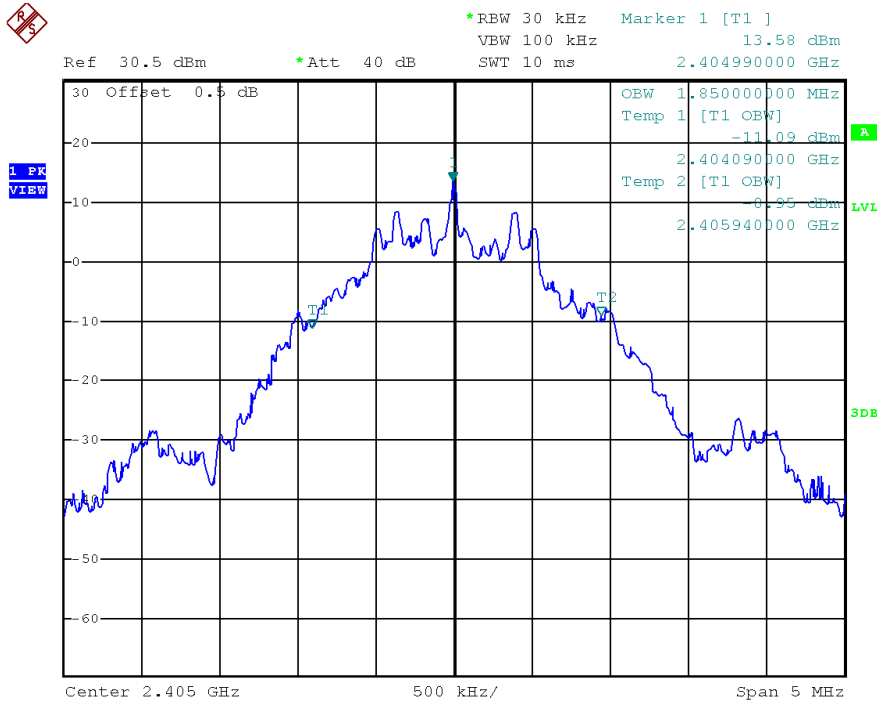

## TEST REPORT

### 5.0 EQUIPMENT LIST

#### 1) Radiated Emissions Test

| Equipment            | EMI Test Receiver<br>7GHz | Spectrum Analyzer | Biconical Antenna<br>(20MHz to 200MHz) |
|----------------------|---------------------------|-------------------|--|
| Registration No.     | EW-3481                   | EW-2466           | EW-2512                                |
| Manufacturer         | ROHDESCHWARZ              | ROHDESCHWARZ      | EMCO                                   |
| Model No.            | ESR7                      | FSP30             | 3104C                                  |
| Calibration Date     | December 21, 2021         | November 18, 2019 | June 03, 2020                          |
| Calibration Due Date | December 21, 2022         | August 18, 2022   | December 03, 2022                      |

| Equipment            | Log Periodic Antenna | Double Ridged Guide<br>Antenna | RF Cable 14m<br>(1GHz to 26.5GHz) |
|----------------------|----------------------|--------------------------------|-----------------------------------|
| Registration No.     | EW-3243              | EW-1015                        | EW-2781                           |
| Manufacturer         | EMCO                 | EMCO                           | GREATBILLION                      |
| Model No.            | 3148B                | 3115                           | SMA m/SHF5MPU<br>/SMA m ra14m,26G |
| Calibration Date     | June 30, 2021        | May 10, 2021                   | November 24, 2020                 |
| Calibration Due Date | December 30, 2022    | November 10, 2022              | November 24, 2022                 |

| Equipment            | RF Preamplifier (9kHz<br>to 6000MHz) | Notch Filter (cutoff<br>frequency 2.4GHz to<br>2.5GHz) 2 pieces | 14m Double Shield RF<br>Cable (20MHz to 6GHz) |
|----------------------|--------------------------------------|---|---|
| Registration No.     | EW-3006b                             | EW-2213   | EW-2074                                       |
| Manufacturer         | SCHWARZBECK                          | MICROWAVE   | RADIALL                                       |
| Model No.            | BBV9718                              | BRM50701-02   | N(m)-RG142-BNC(m)<br>L=14M                    |
| Calibration Date     | February 15, 2022                    | November 12, 2021   | November 14, 2019                             |
| Calibration Due Date | February 15, 2023                    | November 12, 2022   | August 14, 2022                               |

| Equipment            | Pyramidal Horn<br>Antenna | Active Loop H-field<br>(9kHz to 30MHz) |
|----------------------|---------------------------|--|
| Registration No.     | EW-0905                   | EW-3326                                |
| Manufacturer         | EMCO                      | EMCO                                   |
| Model No.            | 3160-09                   | 6502                                   |
| Calibration Date     | July 20, 2021             | December 13, 2021                      |
| Calibration Due Date | January 20, 2023          | June 13, 2023                          |



## TEST REPORT

### 2) Conducted Emissions Test

| Equipment            | RF Cable 240cm (RG142) (9kHz to 30MHz) | Artificial Mains Network | EMI Test Receiver 7GHz |
|----------------------|--|--------------------------|------------------------|
| Registration No.     | EW-2454                                | EW-2501                  | EW-3481                |
| Manufacturer         | RADIALL                                | ROHDESCHWARZ             | ROHDESCHWARZ           |
| Model No.            | Bnc m st / 142 / bnc mra 240cm         | ENV-216                  | ESR7                   |
| Calibration Date     | January 26, 2022                       | September 11, 2021       | December 21, 2021      |
| Calibration Due Date | January 26, 2023                       | September 11, 2022       | December 21, 2022      |

### 3) Conductive Measurement Test

| Equipment            | Spectrum Analyzer | 5m RF Cable (40GHz) |
|----------------------|-------------------|---------------------|
| Registration No.     | EW-2466           | EW-2701             |
| Manufacturer         | ROHDESCHWARZ      | RADIALL             |
| Model No.            | FSP30             | Sma m-m 5m 40G      |
| Calibration Date     | November 18, 2019 | November 24, 2020   |
| Calibration Due Date | August 18, 2022   | November 24, 2022   |

## TEST REPORT

### 4) Control Software for Radiated Emission

#### Software Information

|                  |                     |
|------------------|---------------------|
| Software Name    | EMC32               |
| Manufacturer     | ROHDESCHWARZ        |
| Software version | 10.50.40 & 10.40.10 |

**END OF TEST REPORT**