

TEST REPORT

Report No.: 22080549HKG-001

Application For Original Grant of 47 CFR Part 15 Certification

Single New of RSS-247 Issue 2 Equipment Certification

IP CAM

FCC ID: EW780-2755-00

IC: 1135B-80275500

Prepared and Checked by:

Approved by:

Signed on File
Wong Cheuk Ho, Herbert
Lead Engineer

Wong Kwok Yeung, Kenneth
Assistant Supervisor
Date: September 07, 2022

Intertek's standard Terms and Conditions can be obtained at our website <http://www.intertek.com/terms/>.

The test report only allows to be revised within the retention period unless further standard or the requirement was noticed.

This report is for the exclusive use of Intertek's Client and is provided pursuant to the agreement between Intertek and its Client. Intertek's responsibility and liability are limited to the terms and conditions of the agreement. Intertek assumes no liability to any party, other than to the Client in accordance with the agreement, for any loss, expense or damage occasioned by the use of this report. Only the Client is authorized to permit copying or distribution of this report and then only in its entirety. Any use of the Intertek name or one of its marks for the sale or advertisement of the tested material, product or service must first be approved in writing by Intertek. The observations and test results in this report are relevant only to the sample tested. This report by itself does not imply that the material, product, or service is or has ever been under an Intertek certification program.

© 2017 Intertek

TEST REPORT**GENERAL INFORMATION**

Grantee:	VTech Telecommunications Ltd.
Grantee Address:	23/F., Tai Ping Industrial Centre, Block 1, 57 Ting Kok Road, Tai Po, Hong Kong.
Manufacturer Name:	VTech (Dongguan) Telecommunications Limited
Manufacturer Address:	VTech Science Park, Xia Ling Bei Management Zone, Liaobu, Dongguan, Guangdong, China.
FCC Specification Standard:	FCC Part 15, October 1, 2020 Edition
FCC ID:	EW780-2755-00
FCC Model(s):	LF2911 BU
IC Specification Standard:	RSS-247 Issue 2, February 2017 RSS-Gen Issue 5 Amendment 2, February 2021
IC:	1135B-80275500
HVIN:	35-400432BU
PMN:	LF2911
Type of EUT:	Spread Spectrum Transmitter
Description of EUT:	IP CAM
Serial Number:	N/A
Sample Receipt Date:	August 12, 2022
Date of Test:	August 12, 2022 to August 24, 2022
Report Date:	September 07, 2022
Environmental Conditions:	Temperature: +10 to 40°C Humidity: 10 to 90%
Conclusion:	Test was conducted by client submitted sample. The submitted sample as received complied with the 47 CFR Part 15 / RSS-247 Issue 2 Certification.

TEST REPORT

TABLE OF CONTENTS

EXHIBIT 1	TEST RESULTS SUMMARY & STATEMENT OF COMPLIANCE	4
1.1	Summary of Test Results.....	4
1.2	Statement of Compliance	4
EXHIBIT 2	GENERAL DESCRIPTION	5
2.1	Product Description	5
2.2	Test Methodology	5
2.3	Test Facility.....	5
2.4	Related Submittal(s) Grants.....	5
EXHIBIT 3	SYSTEM TEST CONFIGURATION	6
3.1	Justification	6
3.2	EUT Exercising Software.....	7
3.3	Details of EUT and Description of Accessories	8
3.4	Measurement Uncertainty.....	8
EXHIBIT 4	TEST RESULTS.....	9
4.1	Maximum Conducted (Peak) Output Power at Antenna Terminals.....	9
4.2	Minimum 6dB RF Bandwidth	11
4.3	Minimum Power Spectral Density	18
4.4	Out of Band Conducted Emissions.....	25
4.5	Field Strength Calculation	41
4.6	Transmitter Radiated Emissions in Restricted Bands and Spurious Emissions	42
4.7	AC Power Line Conducted Emission	55
EXHIBIT 5	EQUIPMENT LIST	59

TEST REPORT

EXHIBIT 1 TEST RESULTS SUMMARY & STATEMENT OF COMPLIANCE

1.1 Summary of Test Results

Test Items	FCC Part 15 Section	RSS-210/ RSS-Gen#	Results	Details See Section
Antenna Requirement	15.203	7.1.2#	Pass	2.1
Max. Conducted Output Power (Peak)	15.247(b)(3)&(4)	5.4(4)	Pass	4.1
Min. 6dB RF Bandwidth	15.247(a)(2)	5.2(1)	Pass	4.2
Max. Power Density (Average)	15.247(e)	5.2(2)	Pass	4.3
Out of Band Antenna Conducted Emission	15.247(d)	5.5	Pass	4.4
Radiated Emission in Restricted Bands and Spurious Emissions	15.247(d), 15.209 & 15.109	5.5	Pass	4.6
AC Power Line Conducted Emission	15.207 & 15.107	7.2.4#	Pass	4.7

Note: Pursuant to FCC Part 15 Section 15.215(c), the 20dB bandwidth of the emission was contained within the frequency band designated (mentioned as above) which the EUT operated. The effects, if any, from frequency sweeping, frequency hopping, other modulation techniques and frequency stability over expected variations in temperature and supply voltage were considered.

1.2 Statement of Compliance

The equipment under test is found to be complying with the following standards:

FCC Part 15, October 1, 2020 Edition
RSS-247 Issue 2, February 2017
RSS-Gen Issue 5 Amendment 2, February 2021

TEST REPORT

EXHIBIT 2 GENERAL DESCRIPTION

2.1 Product Description

The LF2911 BU (35-400432BU) is a IP CAM.

The Equipment Under Test (EUT) operates at frequency range of 2412MHz to 2462MHz with 11 channels.

For IEEE 802.11b mode, it operates at frequency range of 2412.000MHz to 2462.000MHz with 11 channels. It transmits via Direct-sequence spread spectrum (DSSS) modulation. Maximum bit rate can be up to 11Mbps.

For IEEE 802.11g mode, it operates at frequency range of 2412.000MHz to 2462.000MHz with 11 channels. It transmits via Orthogonal Frequency Division Multiplexing (OFDM) modulation. Maximum bit rate can be up to 54Mbps.

For IEEE 802.11n (with 20MHz bandwidth) mode, it operates at frequency range of 2412.000MHz to 2462.000MHz with 11 channels. It transmits via Orthogonal Frequency Division Multiplexing (OFDM) modulation. Maximum bit rate can support up to 65Mbps.

The EUT is power by a AC/DC Adaptor.

(Model: VT05EUS05100; Input: 100-240VAC 50/60Hz 0.15A; Output: 5.0VDC 1.0A 5.0W)

The antenna(s) used in the EUT is integral, PCB Dipole antenna.

Peak antenna gain = 0 dBi

The circuit description is saved with filename: descri.pdf.

2.2 Test Methodology

Both AC power line-conducted and radiated emission measurements were performed according to the procedures in ANSI C63.10 (2013). Preliminary radiated scans and all radiated measurements were performed in radiated emission test sites. All Radiated tests were performed at an antenna to EUT distance of 3 meters, unless stated otherwise in the "**Justification Section**" of this Application. Antenna port conducted measurements were performed according to ANSI C63.10 (2013) and KDB Publication No. 558074 D01 v05r02 (April 02, 2019) All other measurements were made in accordance with the procedures in 47 CFR Part 2 and RSS-Gen Issue 5 Amendment 2, February 2021.

2.3 Test Facility

The radiated emission test site and antenna port conducted measurement facility used to collect the radiated data and conductive data are at Workshop No. 3, G/F., World-Wide Industrial Centre, 43-47 Shan Mei Street, Fo Tan, Sha Tin, N.T., Hong Kong SAR, China. This test facility and site measurement data have been fully placed on file with the FCC and Industry Canada No.: 2042H, CABID is "HKAP01".

2.4 Related Submittal(s) Grants

This is a single application for certification of a transceiver (WiFi portion).

TEST REPORT

EXHIBIT 3 SYSTEM TEST CONFIGURATION

3.1 Justification

For radiated emissions testing, the equipment under test (EUT) was setup to transmit / receive continuously to simplify the measurement methodology. Care was taken to ensure proper power supply voltages during testing. During testing, all cables (if any) were manipulated to produce worst case emissions.

The EUT is power by a AC/DC Adaptor.

(Model: VT05EUS05100; Input: 100-240VAC 50/60Hz 0.15A; Output: 5.0VDC 1.0A 5.0W)

For the measurements, the EUT was attached to a plastic stand if necessary and placed on the wooden turntable. If the base unit attached to peripherals, they were connected and operational (as typical as possible).

The signal was maximized through rotation and placement in the three orthogonal axes. The antenna height and polarization were varied during the search for maximum signal level. The antenna height was varied from 1 to 4 meters. Radiated emissions were taken at three meters unless the signal level was too low for measurement at that distance. If necessary, a pre-amplifier was used and/or the test was conducted at a closer distance.

For any intentional radiator powered by AC power line, measurements of the radiated signal level of the fundamental frequency component of the emission was performed with the supply voltage varied between 85% and 115% of the nominal rated supply voltage.

Radiated emission measurement for transmitter were performed from the lowest radio frequency signal generated in the device which is greater than 9 kHz to the tenth harmonic of the highest fundamental frequency or to 40 GHz, whichever is lower.

Emission that are directly caused by digital circuits in the transmit path and transmitter portion were measured, and the limit are according to FCC Part 15 Section 15.209 / RSS-247 2.5. Digital circuitries used to control additional functions other than the operation of the transmitter are subject to FCC Part 15 Section 15.109 / RSS-247 Section 5.5 Limits.

TEST REPORT

3.1 Justification (Cont'd)

Detector function for radiated emissions was in peak mode. Average readings, when required, were taken by measuring the duty cycle of the equipment under test and subtracting the corresponding amount in dB from the measured peak readings. A detailed description for the calculation of the average factor can be found in section 4.8.3.

Determination of pulse desensitization was made according to *Hewlett Packard Application Note 150-2, Spectrum Analysis... Pulsed RF*. The effective period (Teff) was referred to Exhibit 4.8.3. With the resolution bandwidth 1MHz and spectrum analyzer IF bandwidth 3dB, the pulse desensitization factor was 0dB.

For AC line conducted emission test, the EUT along with its peripherals were placed on a 1.0m(W)x1.5m(L) and 0.8m in height wooden table and the EUT was adjusted to maintain a 0.4 meter space from a vertical reference plane. The EUT was connected to power mains through a line impedance stabilization network (LISN), which provided 50ohm coupling impedance for measuring instrument. The LISN housing, measuring instrument case, reference ground plane, and vertical ground plane were bounded together. The excess power cable between the EUT and the LISN was bundled.

All connecting cables of EUT and peripherals were manipulated to find the maximum emission.

Different data rates have been tested. Worst case is reported only.

All relevant operation modes have been tested, and the worst case data is included in this report.

3.2 EUT Exercising Software

The EUT exercise program used during radiated and conducted testing was designed to exercise the various system components in a manner similar to a typical use.

TEST REPORT

3.3 Details of EUT and Description of Accessories

Details of EUT:

An AC/DC adaptor (provided with the unit) was used to power the device.
The description is listed below.

Model: VT05EUS05100; Input: 100-240VAC 50/60Hz 0.15A; Output: 5.0VDC 1.0A 5.0W

Description of Accessories:

Not Applicable. There are no accessories for compliance of this product.

3.4 Measurement Uncertainty

Decision Rule for compliance: For FCC/IC standard, the measured value must be within the limits of applicable standard without accounting for the measurement uncertainty. For EN/IEC/HKTA/HKTC standard, conformity rules will be used as per standard directly excepted EN/IEC 61000-3-2, EN/IEC 61000-3-3, HKTA1004, HKCA1008, HKTA1019, HKTA1020, HKTA1041 and HKTA1044. For these excepted or not mentioned standards, Cl 4.2.2 of ILAC-G8:09/2019 decision rules will be reference and guard band will be equal to our measurement uncertainty with 95% confidence level (k=2). In case, the measured value is within guard band region, undetermined decision will be used. The values of the Measurement uncertainty for radiated emission test, AC line conducted emission test and RF conducted test, frequency stability and timing jitter are $\pm 5.3\text{dB}$, $\pm 4.2\text{dB}$, $\pm 1\text{dB}$, $\pm 23\text{Hz}$, $0.1\mu\text{s}$ respectively.

Uncertainty and Compliance - Unless the standard specifically states that measured values are to be extended by the measurement uncertainty in determining compliance, all compliance determinations are based on the actual measured value.

TEST REPORT

EXHIBIT 4 TEST RESULTS

4.1 Maximum Conducted (Peak) Output Power at Antenna Terminals

RF Conduct Measurement Test Setup

The figure below shows the test setup, which is utilized to make these measurements.

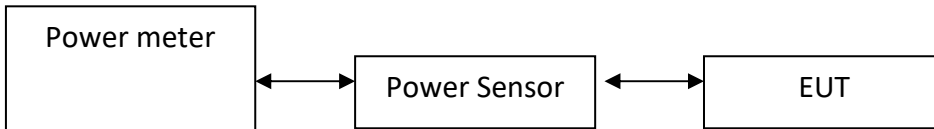

The antenna port of the EUT was connected to the input of a spectrum analyzer.

- The antenna power of the EUT was connected to the input of a power meter. Power was read directly and cable loss correction was added to the reading to obtain power at the EUT antenna terminals. The measurement procedure 9.1.2 was used.
- The EUT should be configured to transmit continuously (at a minimum duty cycle of 98%) at full power over the measurement duration. The measurement procedure AVG1 was used.

IEEE 802.11b (DSSS, 1 Mbps) Antenna Gain = 0 dBi

Frequency (MHz)	Output in dBm	Output in mWatt
Low Channel: 2412	20.55	113.5
Middle Channel: 2437	19.99	99.8
High Channel: 2462	20.64	115.9

IEEE 802.11g (OFDM, 6 Mbps) Antenna Gain = 0 dBi

Frequency (MHz)	Output in dBm	Output in mWatt
Low Channel: 2412	21.22	132.43
Middle Channel: 2437	20.82	120.78
High Channel: 2462	20.06	101.39

IEEE 802.11n (20MHz) (OFDM, MCS0) Antenna Gain = 0 dBi

Frequency (MHz)	Output in dBm	Output in mWatt
Low Channel: 2412	21.01	126.18
Middle Channel: 2437	20.70	117.49
High Channel: 2462	19.92	98.17

TEST REPORT

4.1 Maximum Conducted (Peak) Output Power at Antenna Terminals (Cont'd)

Cable loss: 0.5dB External Attenuation: 0dB

Cable loss, external attenuation: included in OFFSET function
 added to SA raw reading

IEEE 802.11b (DSSS, 1 Mbps)

Max. Conducted (Peak) Output Level = 20.64dBm

IEEE 802.11g (OFDM, 9 Mbps)

Max. Conducted (Peak) Output Level = 21.22dBm

IEEE 802.11n (20MHz) (OFDM, MCS0)

Max. Conducted (Peak) Output Level = 21.01dBm

Limits:

1W (30dBm) for antennas with gains of 6dBi or less.

_____W (_____dBm) for antennas with gains more than 6dBi.

TEST REPORT

4.2 Minimum 6dB RF Bandwidth

The antenna port of the EUT was connected to the input of a spectrum analyzer. The EBW measurement procedure was used. A PEAK output reading was taken, a DISPLAY line was drawn 6dB lower than PEAK level. The 6dB bandwidth was determined from where the channel output spectrum intersected the display line.

IEEE 802.11b (DSSS, 1 Mbps)

Frequency (MHz)	6dB Bandwidth (MHz)
Low Channel: 2412	10.08
Middle Channel: 2437	10.00
High Channel: 2462	9.44

IEEE 802.11g (OFDM, 6 Mbps)

Frequency (MHz)	6dB Bandwidth (MHz)
Low Channel: 2412	16.64
Middle Channel: 2437	16.64
High Channel: 2462	16.64

IEEE 802.11n (20MHz) (OFDM, MCS0)

Frequency (MHz)	6dB Bandwidth (MHz)
Low Channel: 2412	17.76
Middle Channel: 2437	17.84
High Channel: 2462	17.84

Limits:

6dB bandwidth shall be at least 500kHz.

The plots of 6dB RF bandwidth are saved as below.

TEST REPORT

PLOTS OF 6dB RF BANDWIDTH

IEEE 802.11b, Lowest Channel

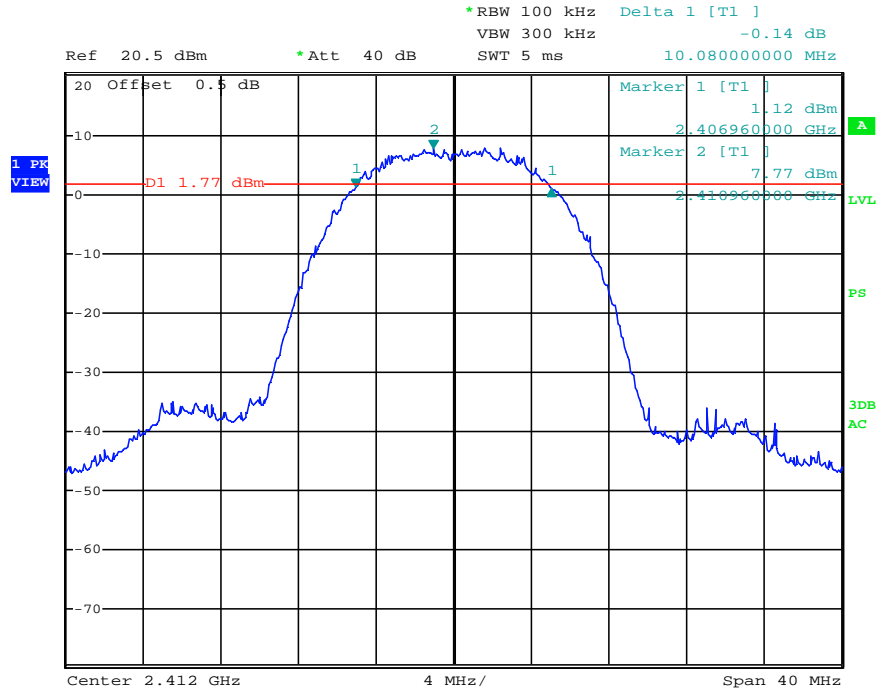

IEEE 802.11b, Middle Channel

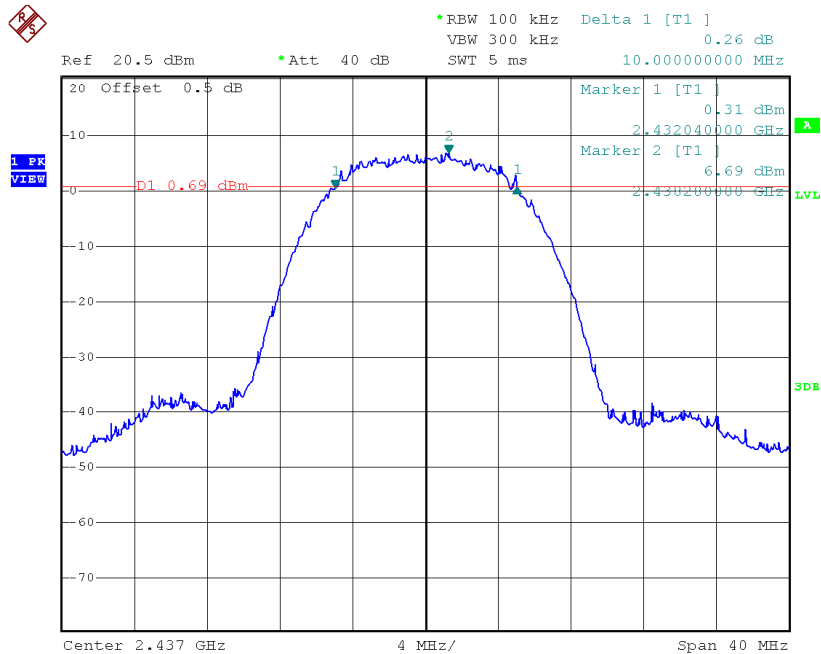

TEST REPORT

PLOTS OF 6dB RF BANDWIDTH

IEEE 802.11b, Highest Channel

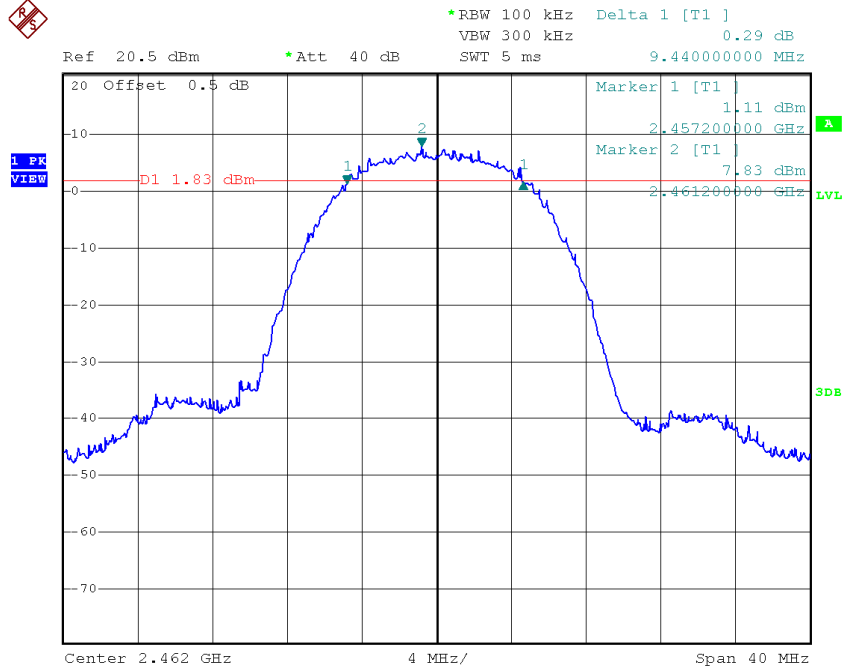

TEST REPORT

PLOTS OF 6dB RF BANDWIDTH

IEEE 802.11g, Lowest Channel

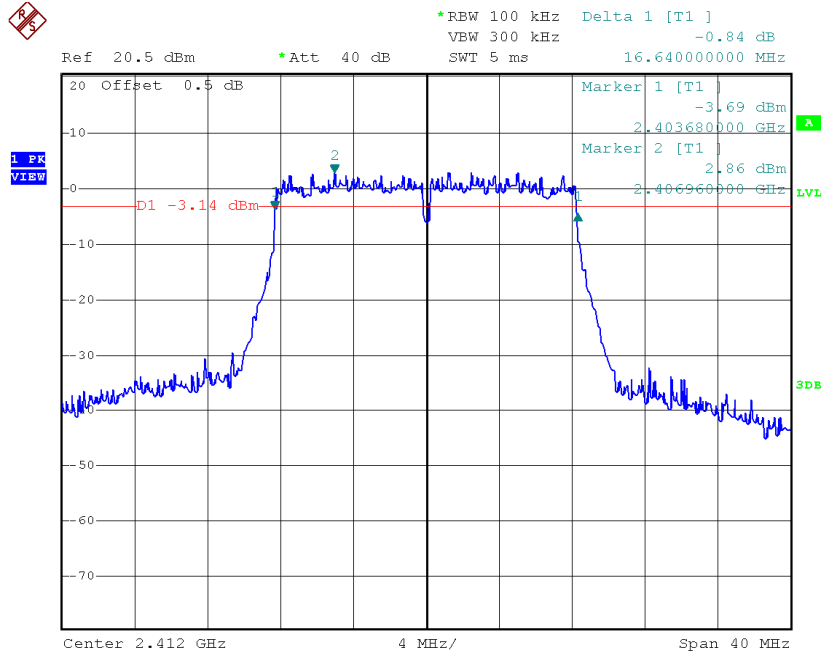

IEEE 802.11g, Middle Channel

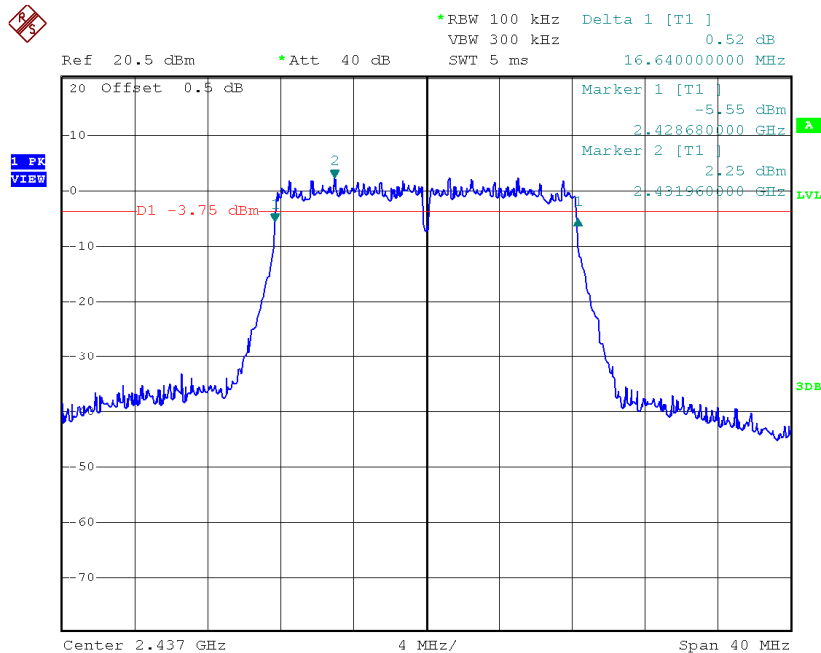

TEST REPORT

PLOTS OF 6dB RF BANDWIDTH

IEEE 802.11g, Highest Channel

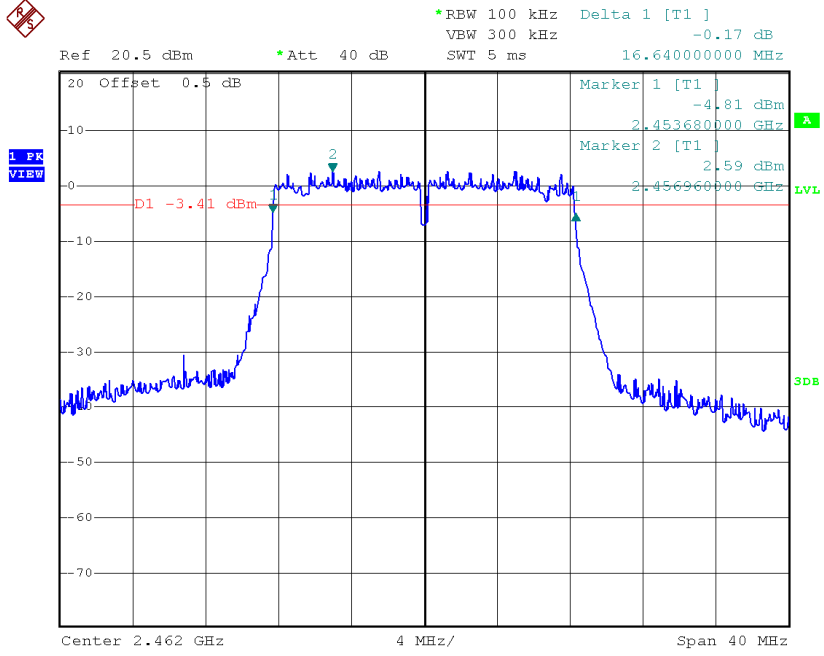

TEST REPORT

PLOTS OF 6dB RF BANDWIDTH

IEEE 802.11n (20MHz), Lowest Channel

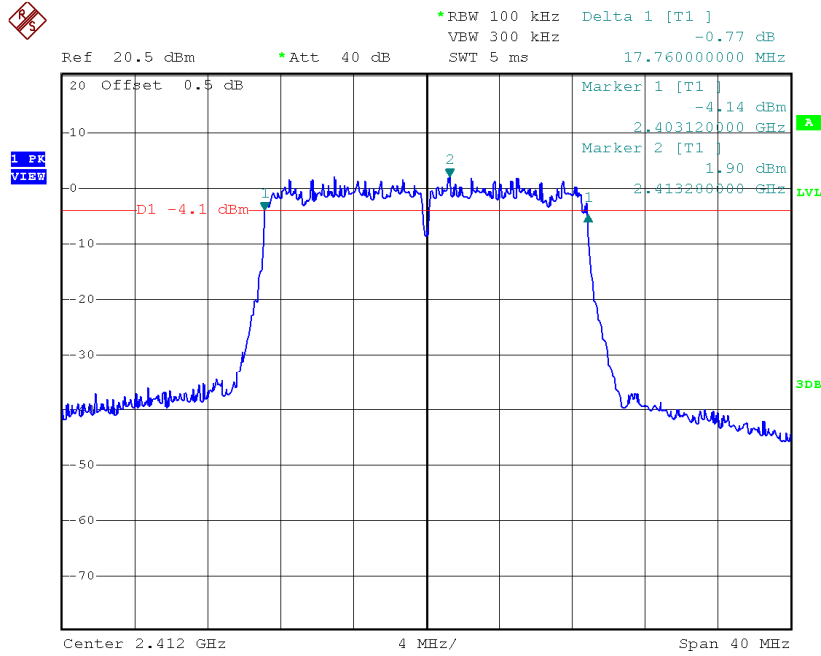

IEEE 802.11n (20MHz), Middle Channel

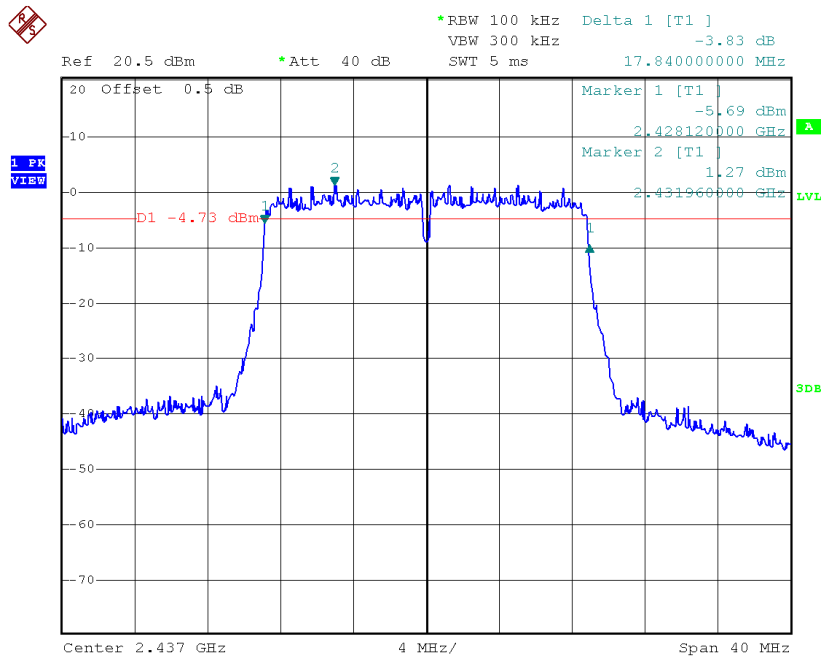

TEST REPORT

PLOTS OF 6dB RF BANDWIDTH

IEEE 802.11n (20MHz), Highest Channel

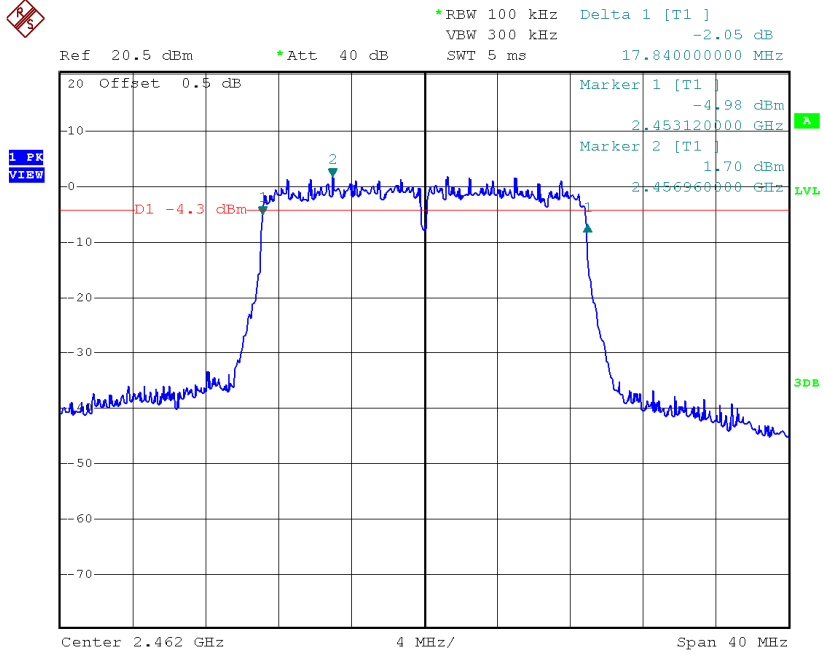

TEST REPORT

4.3 Minimum Power Spectral Density

Antenna output of the EUT was coupled directly to spectrum analyzer. The measurement procedure 10.2 PKPSD was used. If an external attenuator and/or cable was used, these losses are compensated for using the OFFSET function of the analyser.

IEEE 802.11b (DSSS, 1 Mbps)

Frequency (MHz)	PSD in 100kHz (dBm)
Low Channel: 2412	7.61
Middle Channel: 2437	7.58
High Channel: 2462	7.66

IEEE 802.11g (OFDM, 6 Mbps)

Frequency (MHz)	PSD in 100kHz (dBm)
Low Channel: 2412	3.07
Middle Channel: 2437	2.29
High Channel: 2462	2.59

IEEE 802.11n (20MHz) (OFDM, MCS0)

Frequency (MHz)	PSD in 100kHz (dBm)
Low Channel: 2412	1.94
Middle Channel: 2437	1.33
High Channel: 2462	1.74

Cable Loss: 0.5dB

Limit: 8dBm in 3kHz

The plots of power spectral density are as below.

TEST REPORT

PLOTS OF POWER SPECTRAL DENSITY

IEEE 802.11b, Lowest Channel

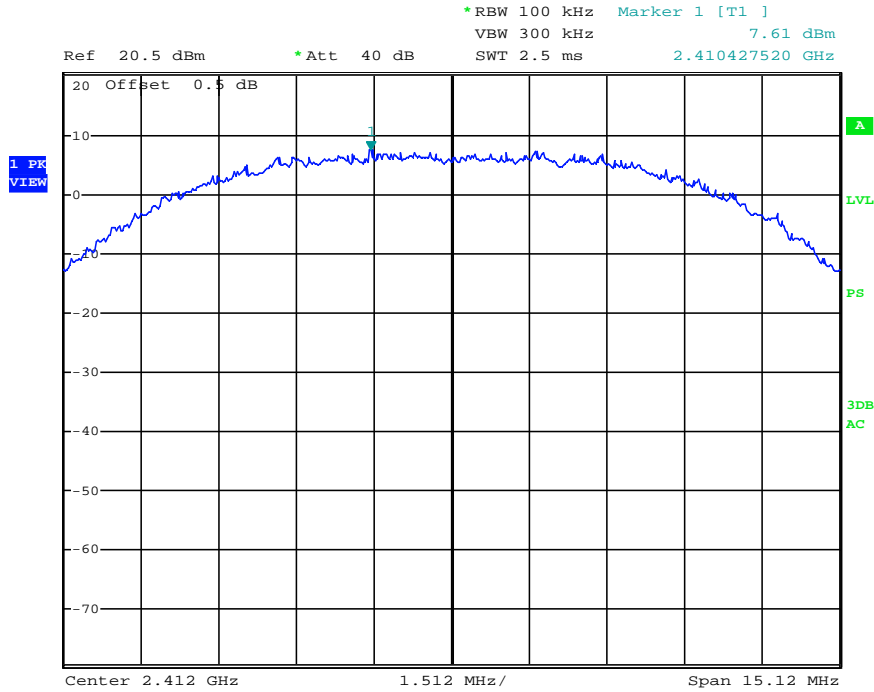

IEEE 802.11b, Middle Channel

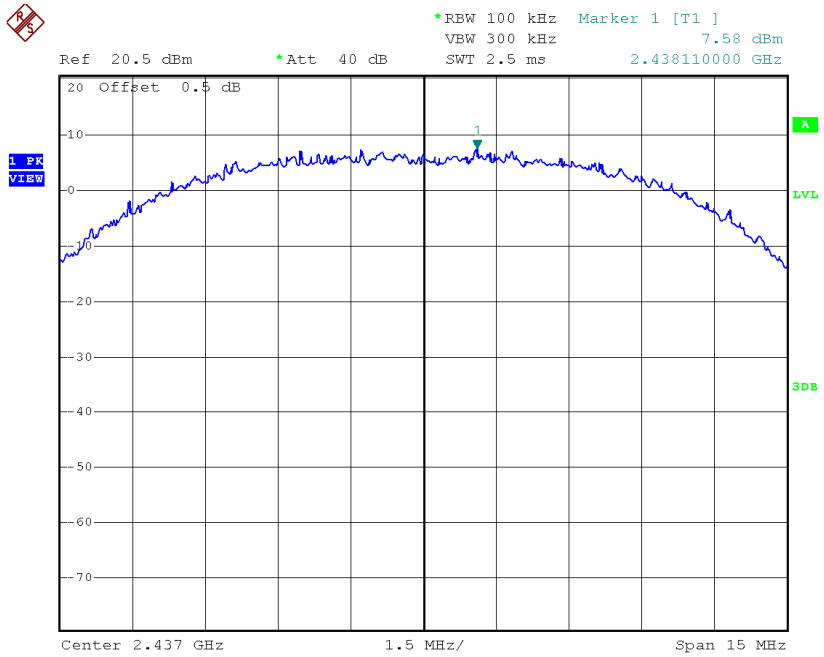

TEST REPORT

PLOTS OF POWER SPECTRAL DENSITY

IEEE 802.11b, Highest Channel

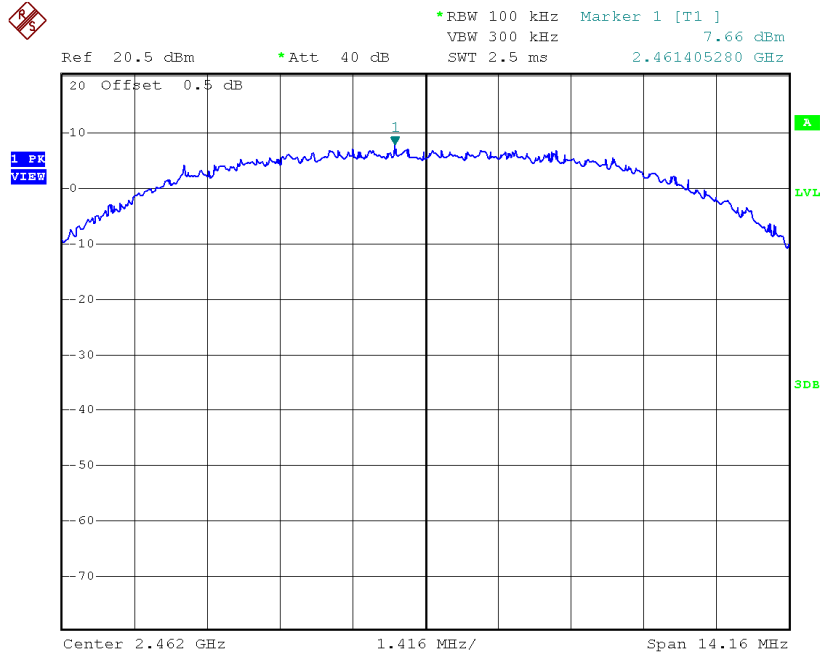

TEST REPORT

PLOTS OF POWER SPECTRAL DENSITY

IEEE 802.11g, Lowest Channel

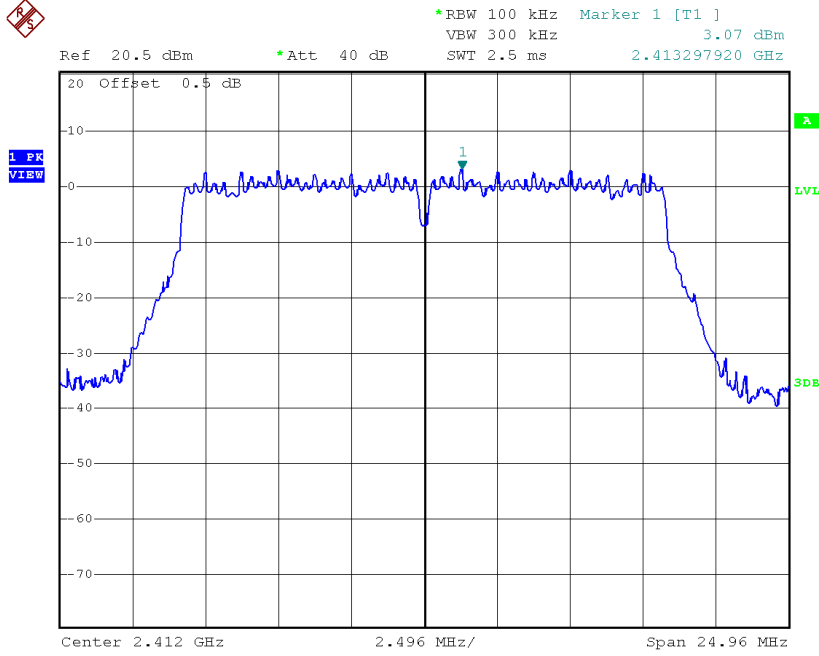

IEEE 802.11g, Middle Channel

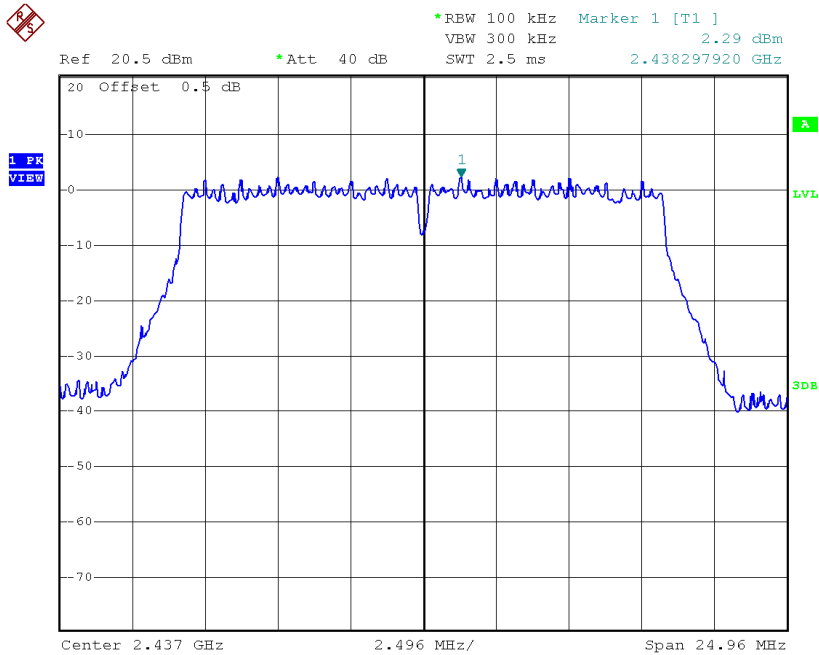

TEST REPORT

PLOTS OF POWER SPECTRAL DENSITY

IEEE 802.11g, Highest Channel

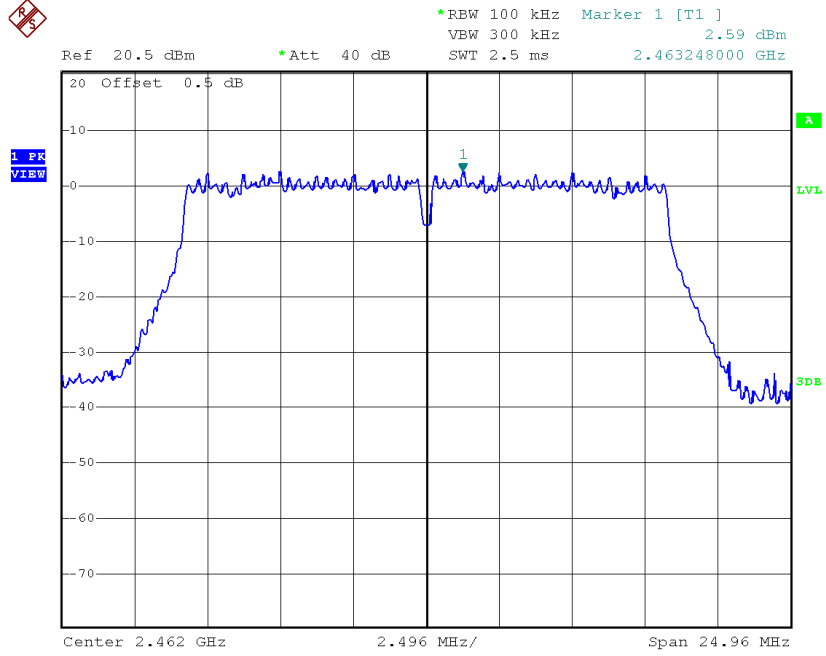

TEST REPORT

PLOTS OF POWER SPECTRAL DENSITY

IEEE 802.11n (20MHz), Lowest Channel

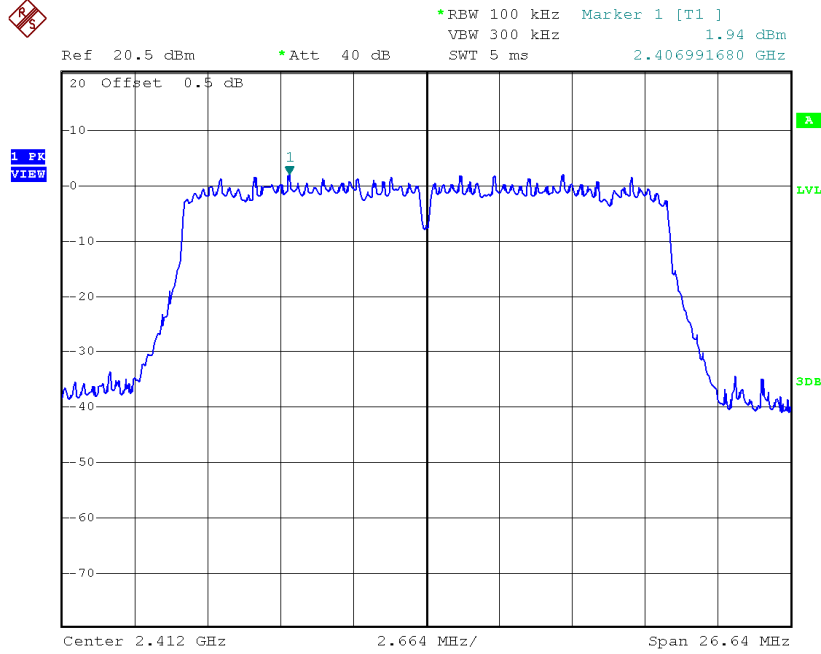

IEEE 802.11n (20MHz), Middle Channel

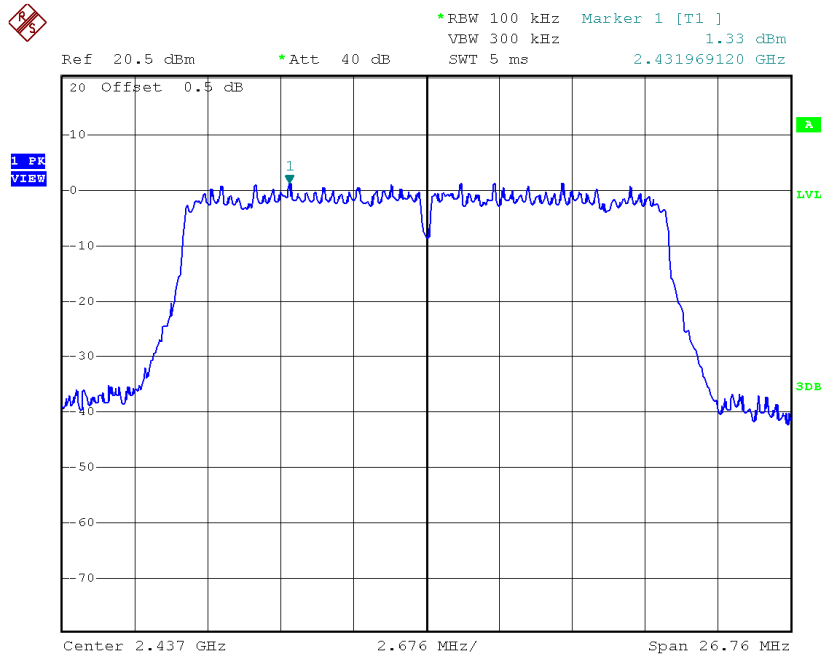

TEST REPORT

PLOTS OF POWER SPECTRAL DENSITY

IEEE 802.11n (20MHz), Highest Channel

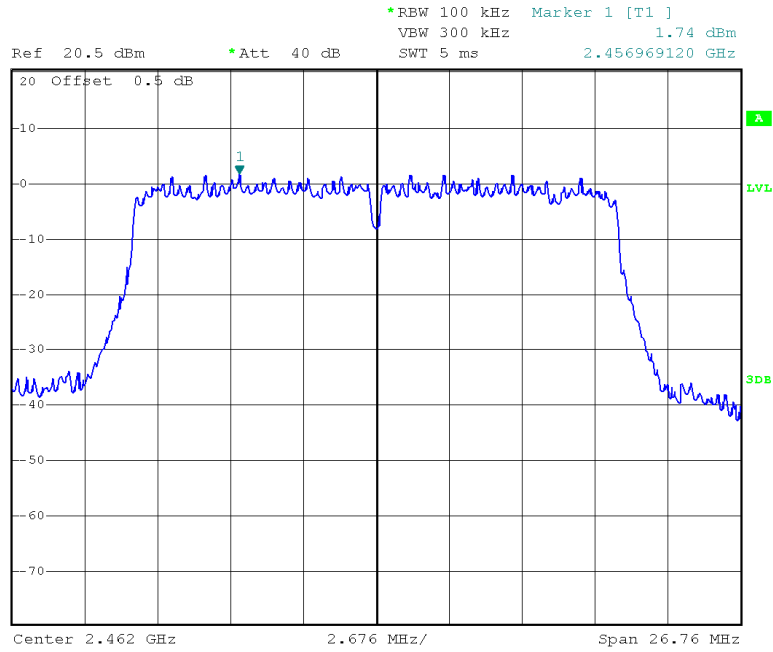

TEST REPORT

4.4 Out of Band Conducted Emissions

For IEEE 802.11b/g/n20MHz, the maximum conducted (peak) output power was used to demonstrate compliance as described in 9.1. Then the display line (in red) shown in the following plots denotes the limit at 20dB below maximum measured in-band peak PSD level in 100 KHz bandwidth for IEEE 802.11b/g/n20MHz.

The measurement procedures under sections 11 of KDB558074 D01 v05r02 (April 2, 2019) were used.

Furthermore, delta measurement technique for measuring bandedge emissions was incorporated in the test of the edge at 2483.5MHz.

Limits:

All spurious emission and up to the tenth harmonic was measured and they were found to be at least for IEEE 802.11b/g/n20MHz below the maximum measured in-band peak PSD level.

The plots of out of band conducted emissions are as below.

TEST REPORT

PLOTS OF OUT OF BAND CONDUCTED EMISSIONS

IEEE 802.11b, Lowest Channel, Plot A

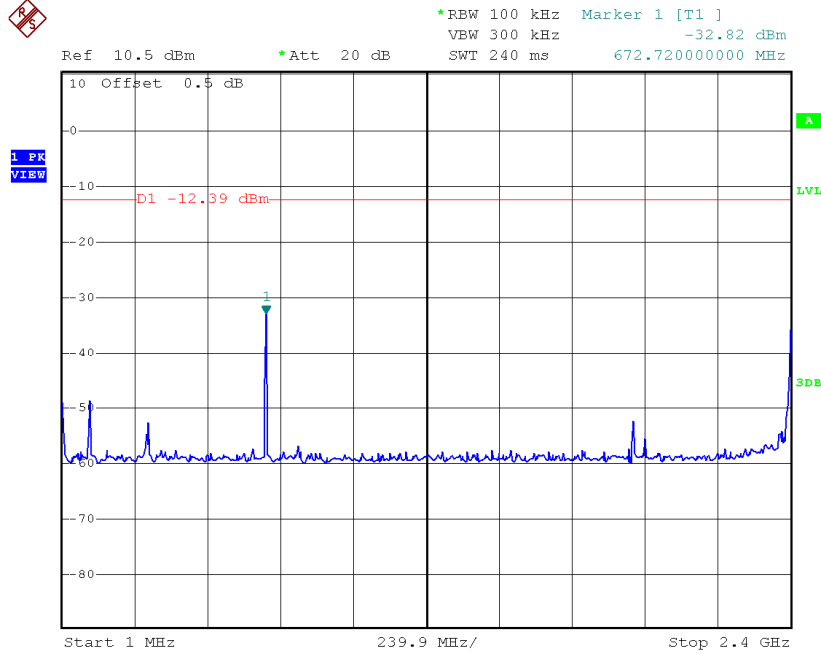

IEEE 802.11b, Lowest Channel, Plot B

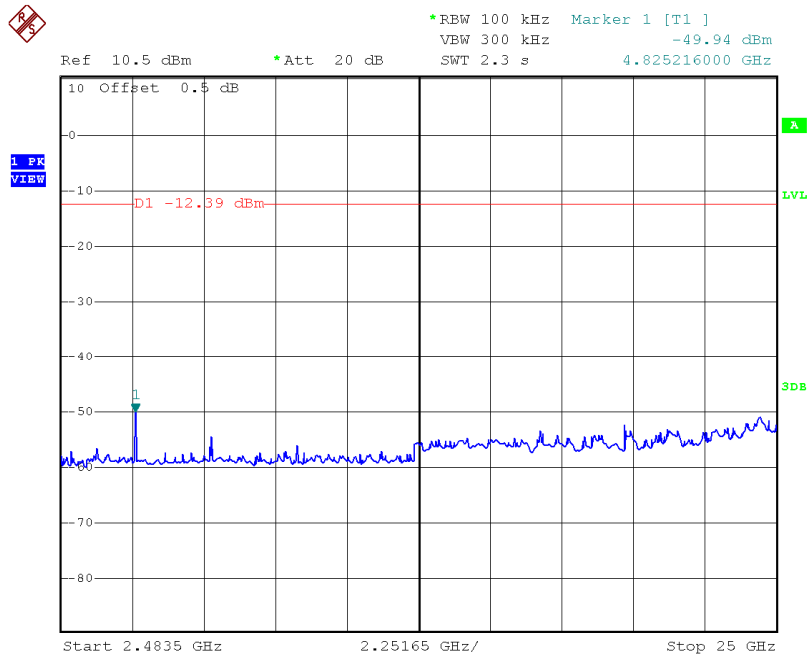

TEST REPORT

PLOTS OF OUT OF BAND CONDUCTED EMISSIONS

IEEE 802.11b, Middle Channel, Plot A

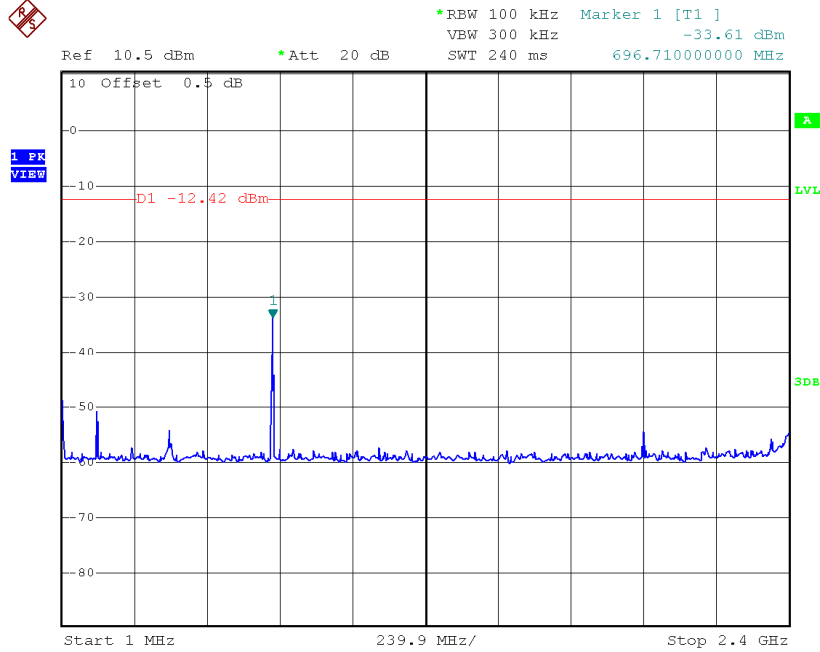

IEEE 802.11b, Middle Channel, Plot B

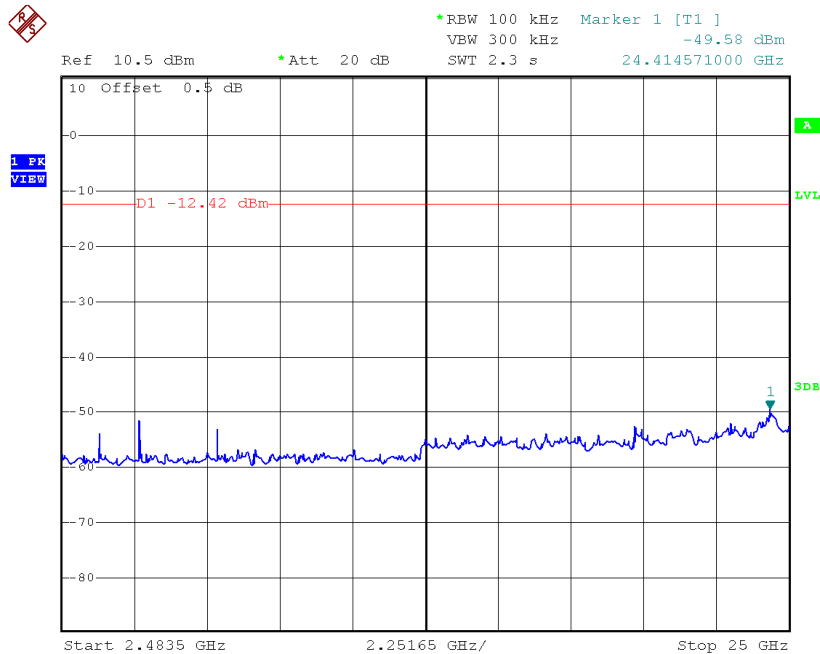

TEST REPORT

PLOTS OF OUT OF BAND CONDUCTED EMISSIONS

IEEE 802.11b, Highest Channel, Plot A

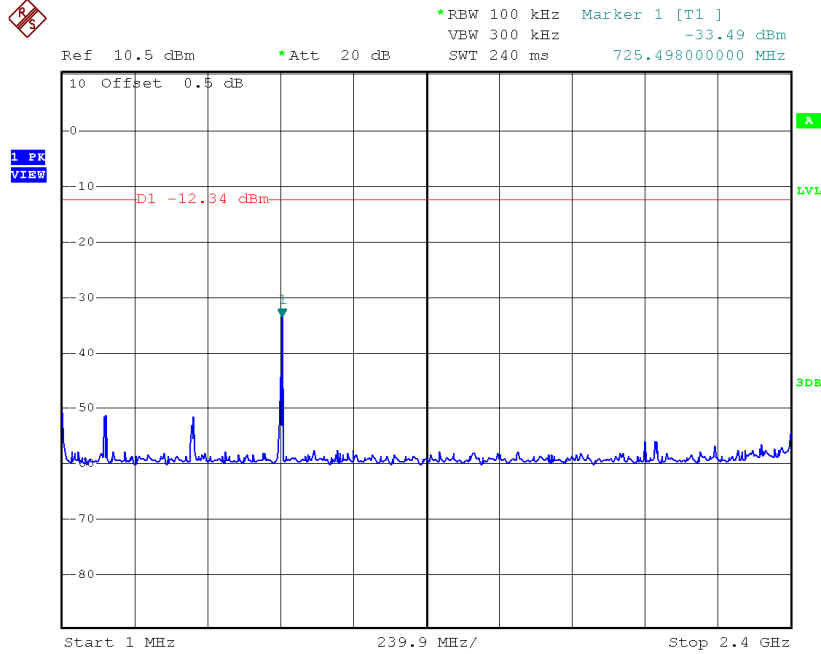

IEEE 802.11b, Highest Channel, Plot B

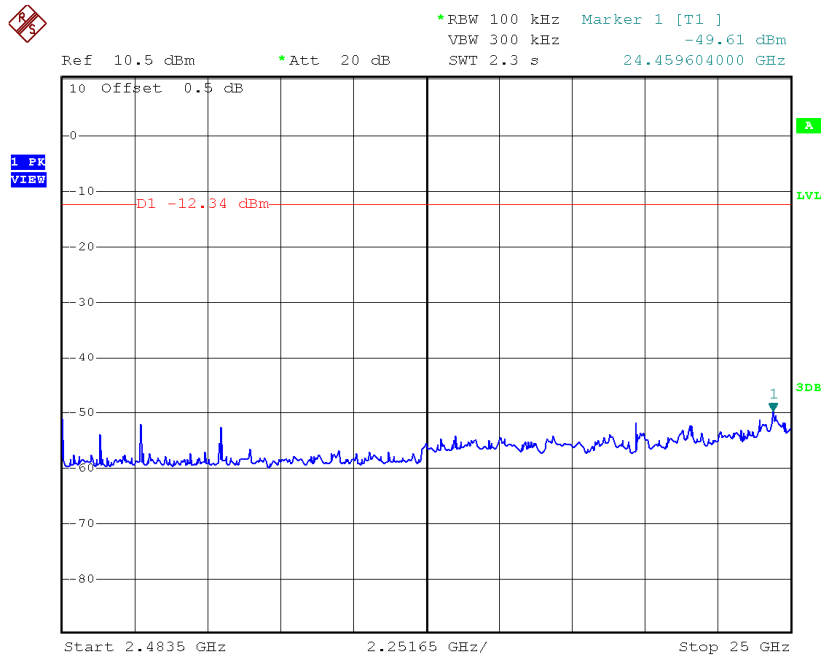

TEST REPORT

PLOTS OF OUT OF BAND CONDUCTED EMISSIONS

IEEE 802.11b, Lowest Channel, Bandedge

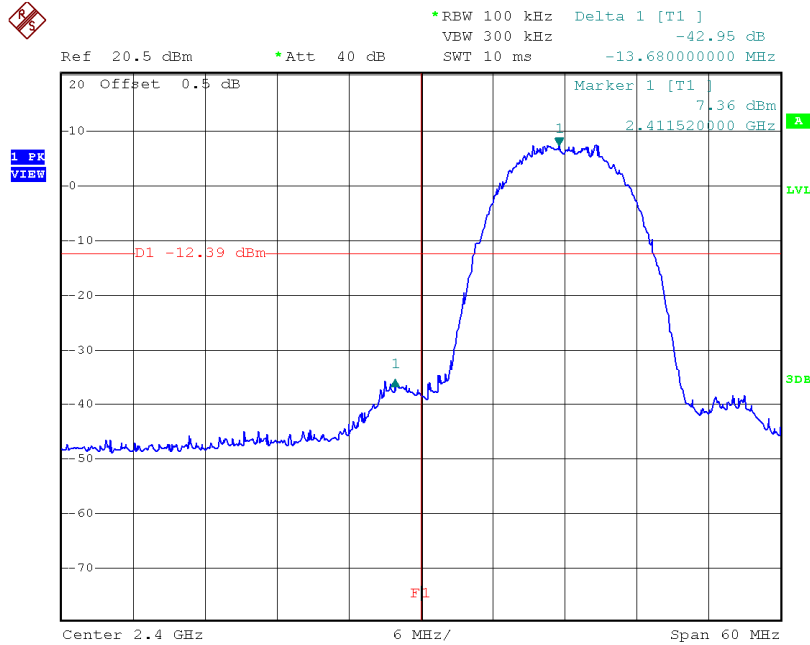

IEEE 802.11b, Highest Channel, Bandedge

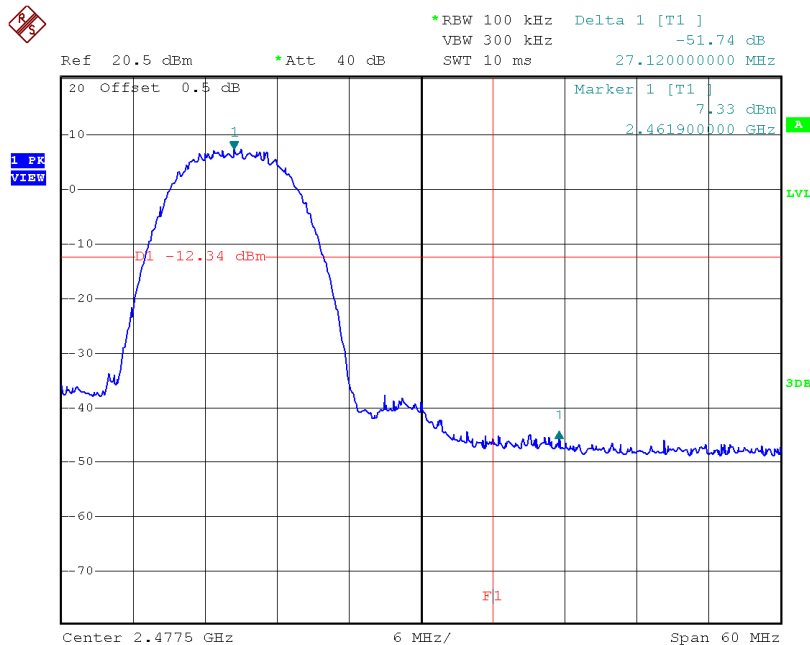

4B

Date: 22.AUG.2022 15:13:06

TEST REPORT

PLOTS OF OUT OF BAND CONDUCTED EMISSIONS

IEEE 802.11g, Lowest Channel, Plot A

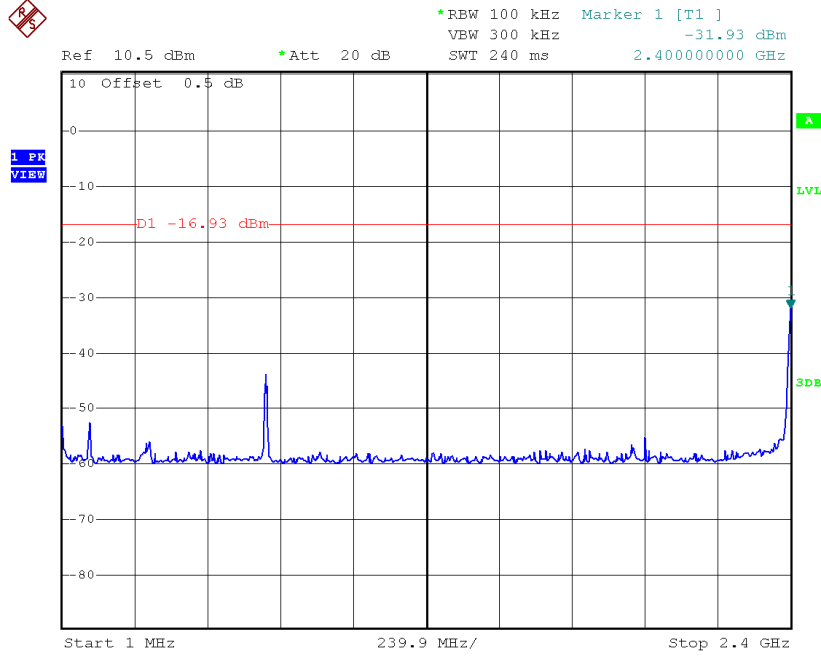

IEEE 802.11g, Lowest Channel, Plot B

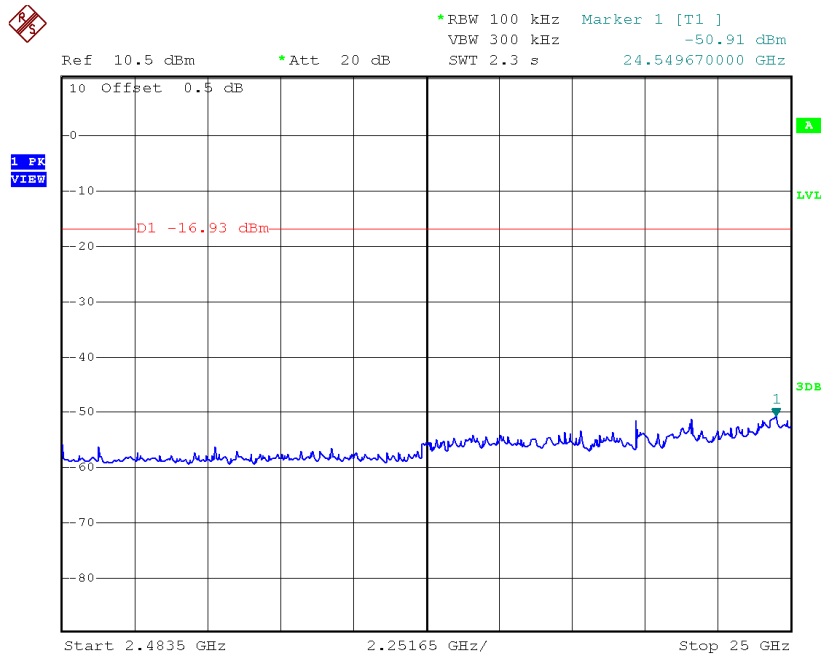

TEST REPORT

PLOTS OF OUT OF BAND CONDUCTED EMISSIONS

IEEE 802.11g, Middle Channel, Plot A

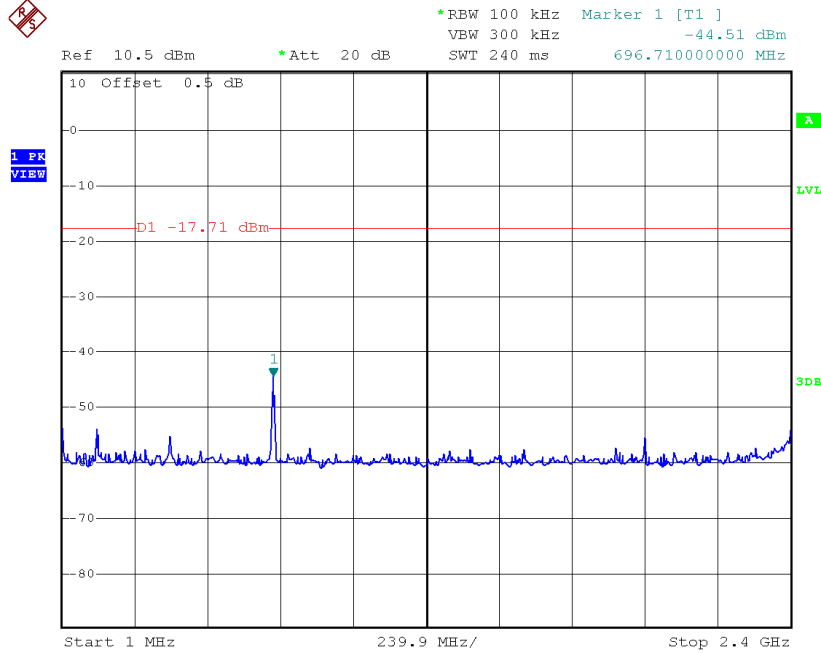

IEEE 802.11g, Middle Channel, Plot B

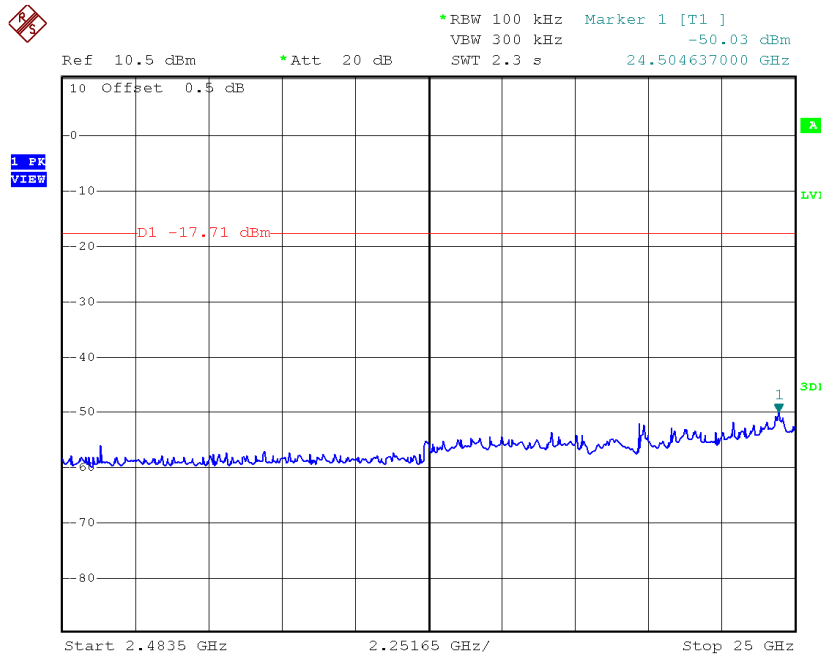

TEST REPORT

PLOTS OF OUT OF BAND CONDUCTED EMISSIONS

IEEE 802.11g, Highest Channel, Plot A

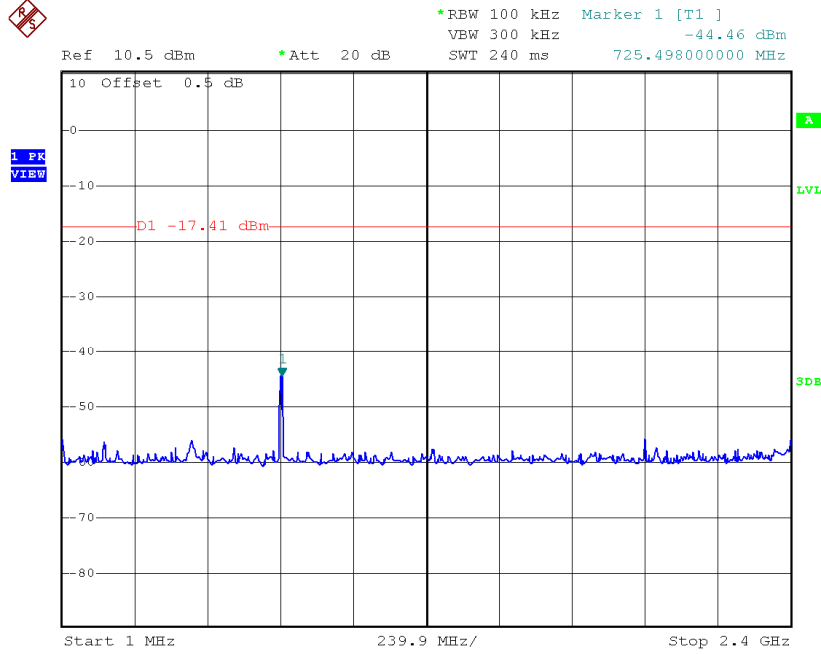

IEEE 802.11g, Highest Channel, Plot B

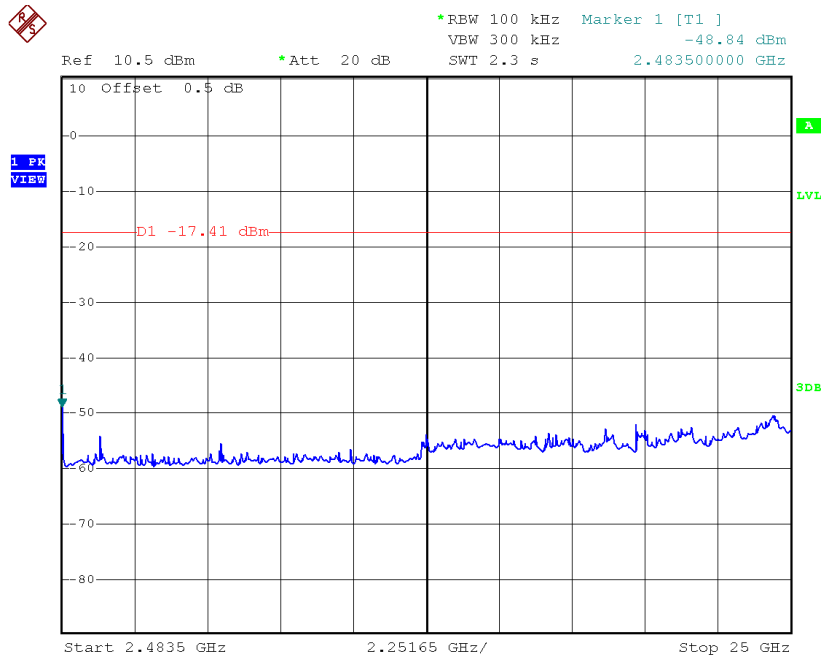

TEST REPORT

PLOTS OF OUT OF BAND CONDUCTED EMISSIONS

IEEE 802.11g, Lowest Channel, Bandedge

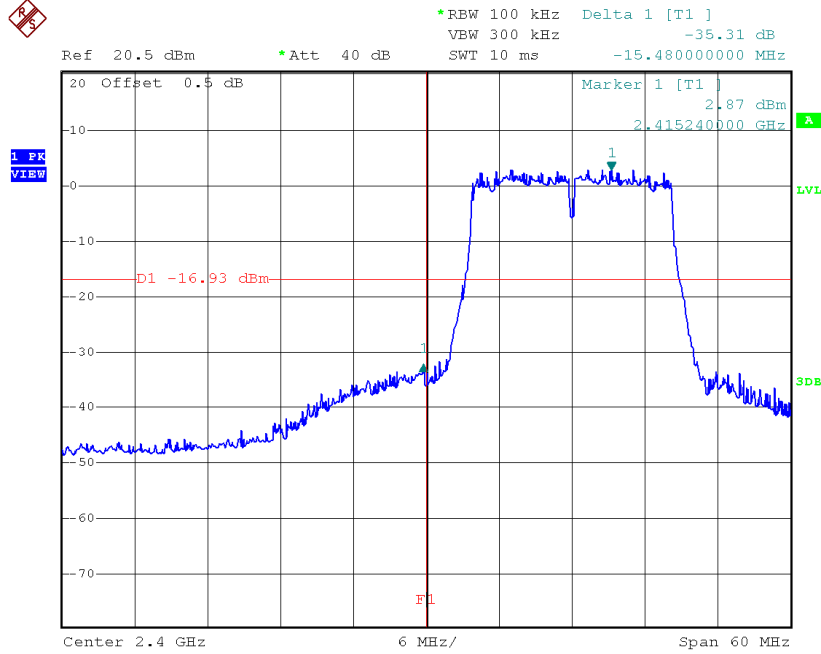

IEEE 802.11g, Highest Channel, Bandedge

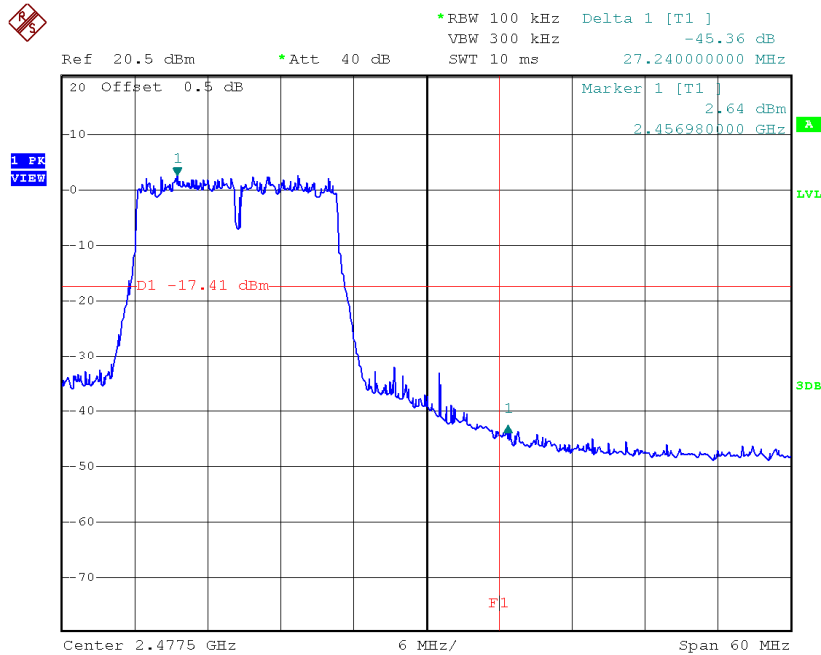

TEST REPORT

PLOTS OF OUT OF BAND CONDUCTED EMISSIONS

IEEE 802.11n (20MHz), Lowest Channel, Plot A

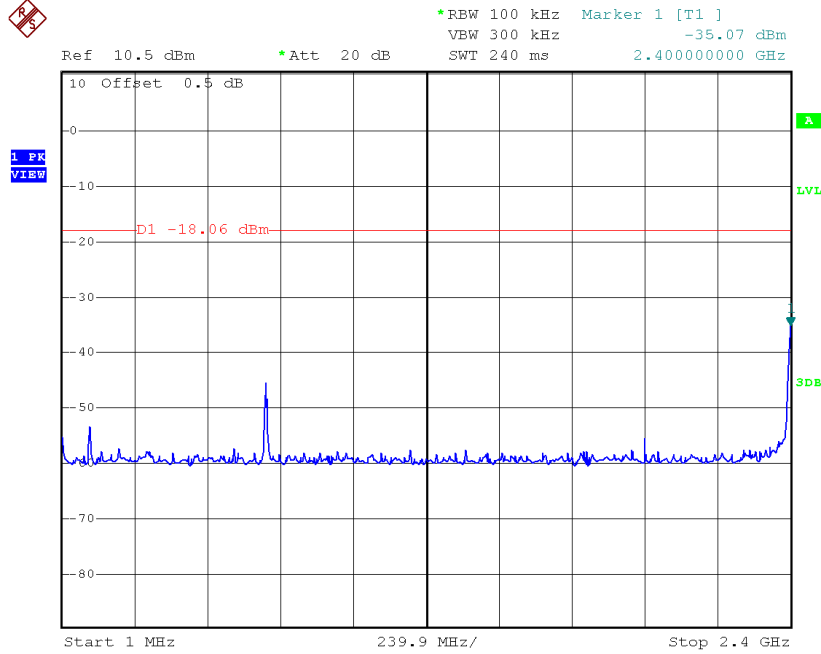

IEEE 802.11n (20MHz), Lowest Channel, Plot B

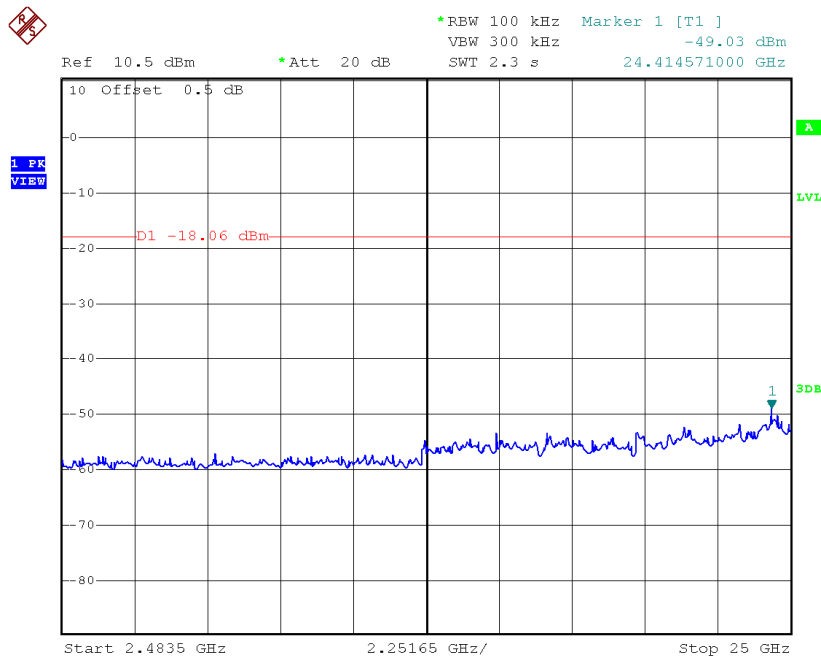

TEST REPORT

PLOTS OF OUT OF BAND CONDUCTED EMISSIONS

IEEE 802.11n (20MHz), Lowest Channel, Plot A

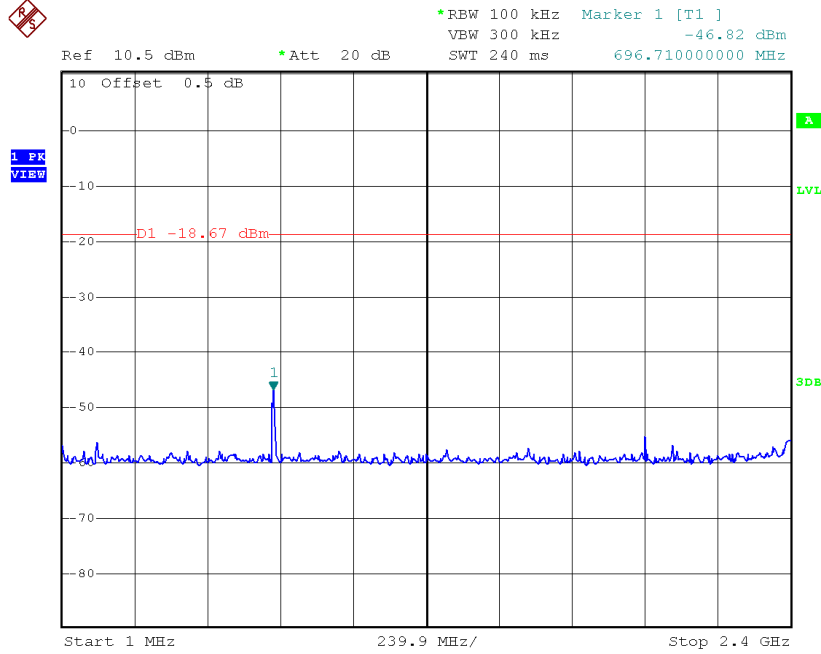

IEEE 802.11n (20MHz), Lowest Channel, Plot B

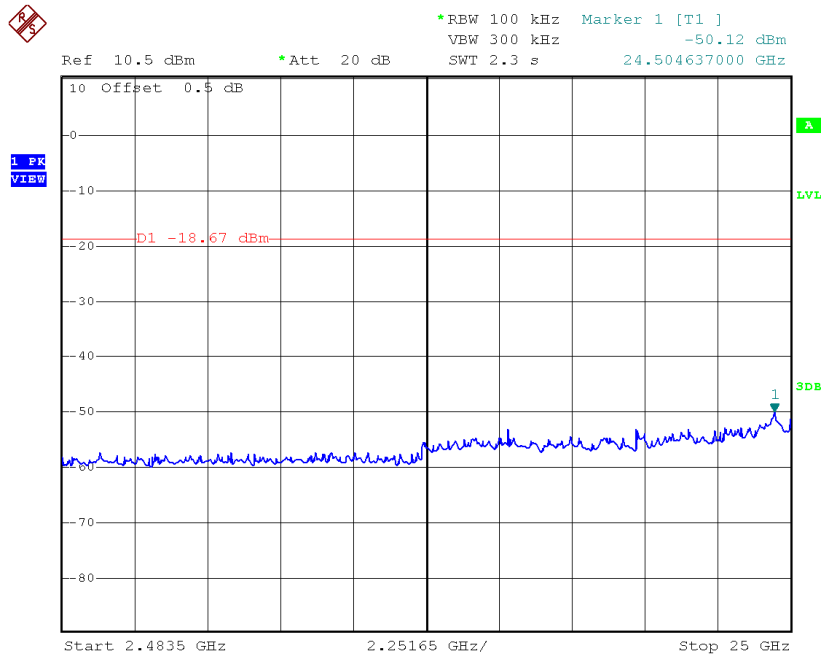

TEST REPORT

PLOTS OF OUT OF BAND CONDUCTED EMISSIONS

IEEE 802.11n (20MHz), Highest Channel, Plot A

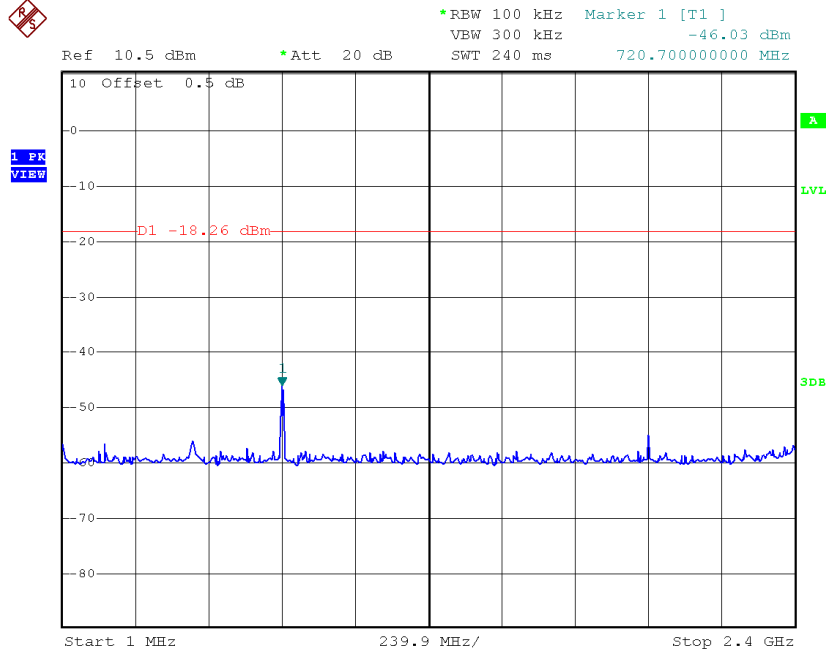

IEEE 802.11n (20MHz), Highest Channel, Plot B

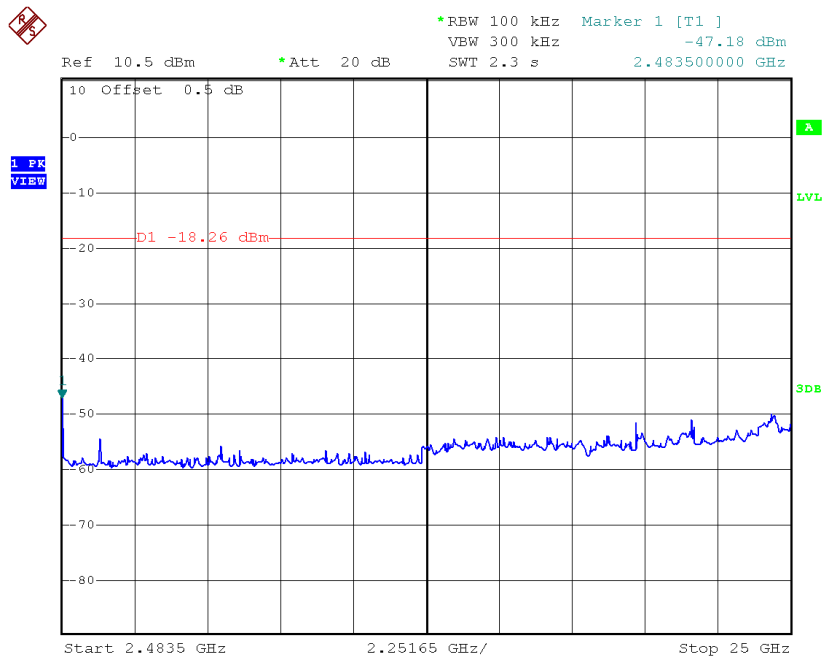

TEST REPORT

PLOTS OF OUT OF BAND CONDUCTED EMISSIONS

IEEE 802.11n (20MHz), Lowest Channel, Bandedge

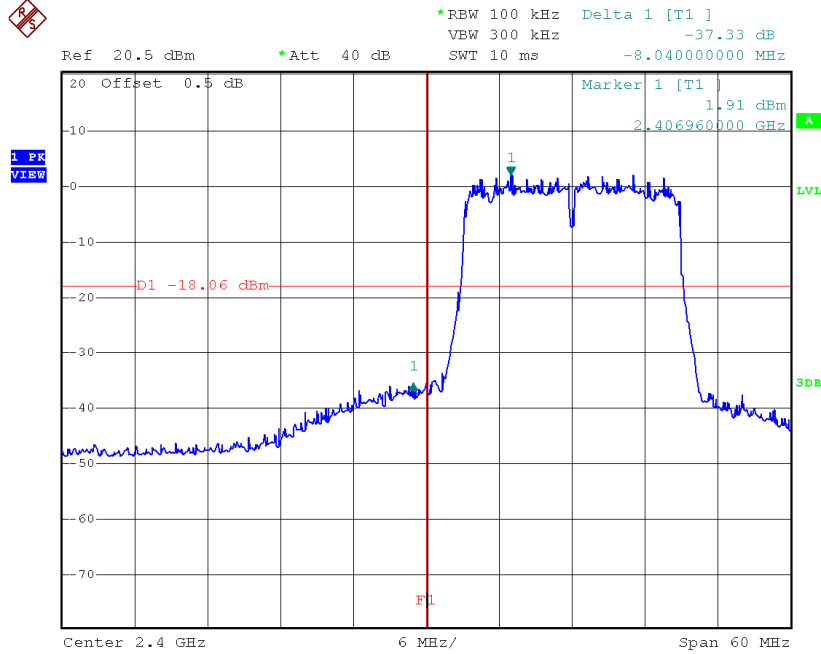

IEEE 802.11n (20MHz), Highest Channel, Bandedge

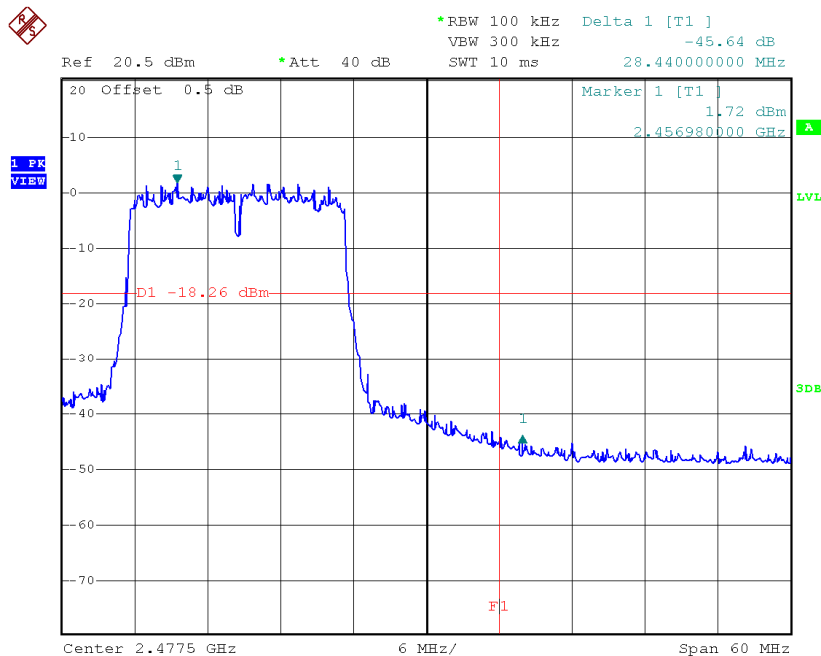

TEST REPORT

Occupied Bandwidth Results: (IEEE 802.11b)

(IEEE 802.11b)	Occupied Bandwidth (MHz)	
Low Channel:	2412	12.88
Middle Channel:	2437	12.96
High Channel:	2462	12.88

The worst case is shown as below:

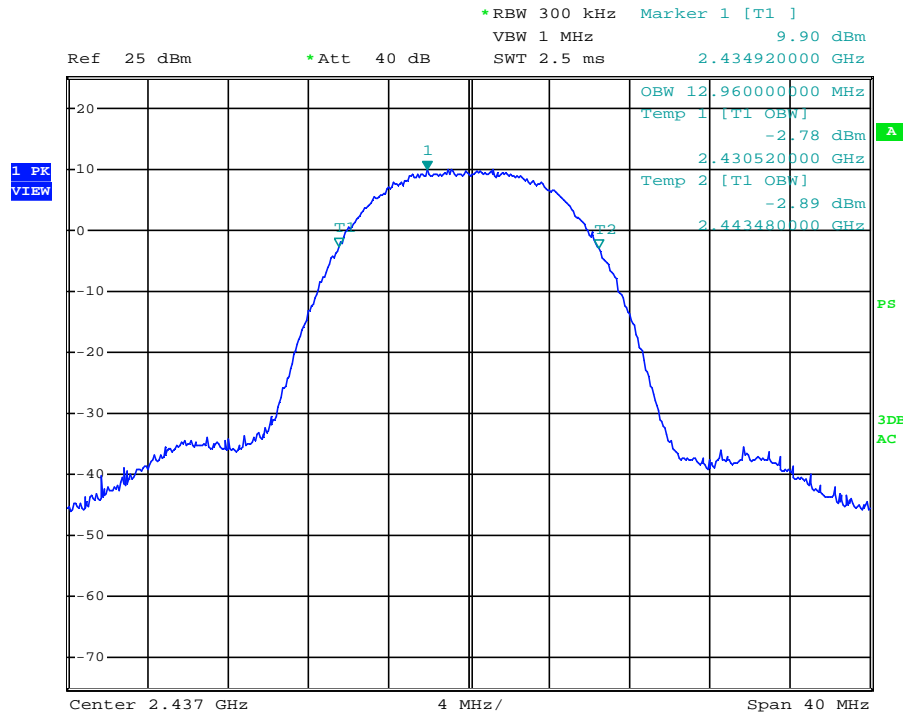

TEST REPORT

Occupied Bandwidth Results: (IEEE 802.11g)

(IEEE 802.11g)	Occupied Bandwidth (MHz)	
Low Channel:	2412	16.88
Middle Channel:	2437	16.72
High Channel:	2462	16.72

The worst case is shown as below:

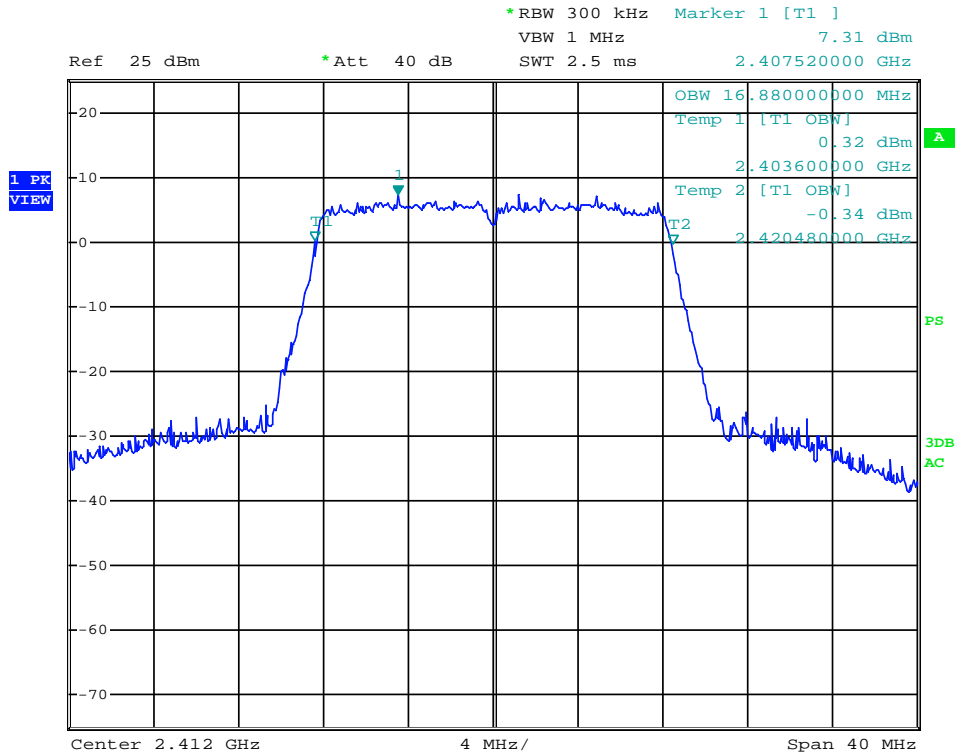

TEST REPORT

Occupied Bandwidth Results: (IEEE 802.11n (20MHz))

(IEEE 802.11n (20MHz))	Occupied Bandwidth (MHz)	
Low Channel:	2412	17.68
Middle Channel:	2437	17.68
High Channel:	2462	17.68

The worst case is shown as below:

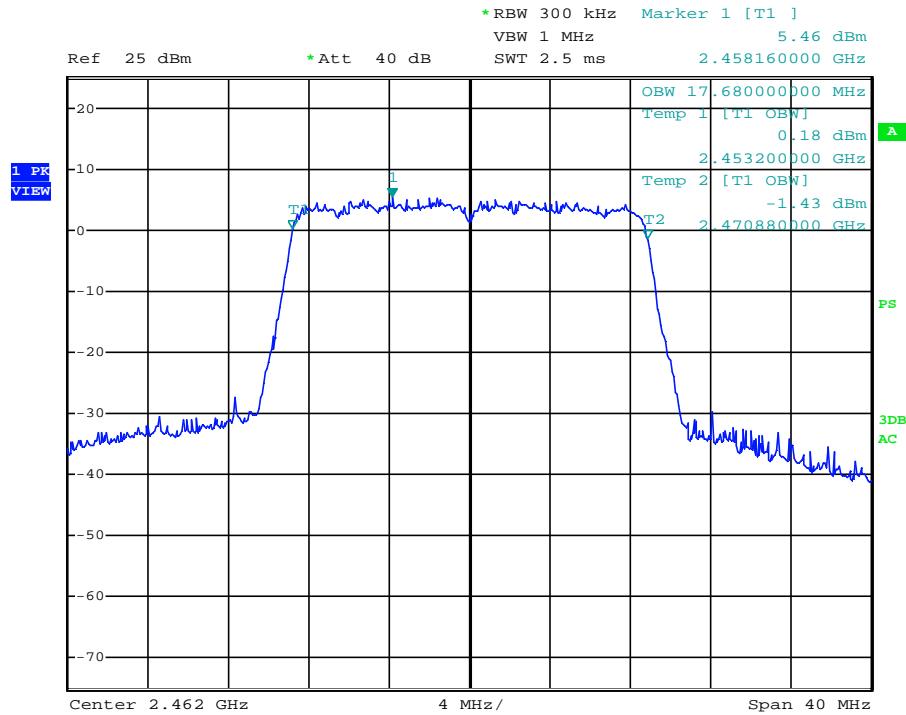

TEST REPORT

4.5 Field Strength Calculation

The field strength is calculated by adding the reading on the Spectrum Analyzer to the factors associated with preamplifiers (if any), antennas, cables, pulse desensitization and average factors (when specified limit is in average and measurements are made with peak detectors). A sample calculation is included below.

$$FS = RA + AF + CF - AG + PD + AV$$

where	FS	=	Field Strength in dB μ V/m
	RA	=	Receiver Amplitude (including preamplifier) in dB μ V
	CF	=	Cable Attenuation Factor in dB
	AF	=	Antenna Factor in dB
	AG	=	Amplifier Gain in dB
	PD	=	Pulse Desensitization in dB
	AV	=	Average Factor in -dB

In the radiated emission table which follows, the reading shown on the data table may reflect the preamplifier gain. An example of the calculations, where the reading does not reflect the preamplifier gain, follows:

$$FS = RA + AF + CF - AG + PD + AV$$

Example:

Assume a receiver reading of 62.0 dB μ V is obtained. The antenna factor of 7.4 dB and cable factor of 1.6 dB is added. The amplifier gain of 29.0 dB is subtracted. The pulse desensitization factor of the spectrum analyzer is 0.0 dB, and the resultant average factor is -10.0 dB. The net field strength for comparison to the appropriate emission limit is 32.0 dB μ V/m. This value in dB μ V/m is converted to its corresponding level in μ V/m.

RA	=	62.0 dB μ V
AF	=	7.4 dB
CF	=	1.6 dB
AG	=	29 dB
PD	=	0.0 dB
AV	=	-10 dB
FS	=	$62.0 + 7.4 + 1.6 - 29.0 + 0.0 + (-10.0) = 32.0$ dB μ V/m

$$\text{Level in } \mu\text{V/m} = \text{Common Antilogarithm } [(32.0 \text{ dB}\mu\text{V/m})/20] = 39.8 \mu\text{V/m}$$

TEST REPORT**4.6 Transmitter Radiated Emissions in Restricted Bands and Spurious Emissions**

Data is included of the worst case configuration (the configuration which resulted in the highest emission levels). A sample calculation, configuration photographs and data tables of the emissions are included.

The data on the following pages list the significant emission frequencies, the limit and the margin of compliance.

4.6.1 Radiated Emission Configuration Photograph**Worst Case Restricted Band Radiated Emission**

at 624.993 MHz

The worst case radiated emission configuration photographs are saved with filename: config photos.pdf

4.6.2 Radiated Emission Data

The data in tables 1-10 list the significant emission frequencies, the limit and the margin of compliance.

Judgement –

Passed by 1.0 dB margin

TEST REPORT

RADIATED EMISSION DATA

Mode: TX-Channel 01

Table 1, IEEE 802.11b DSSS 1Mbps

Polarization	Frequency (MHz)	Reading (dB μ V)	Pre-Amp Gain (dB)	Antenna Factor (dB)	Net at 3m (dB μ V/m)	Average Limit at 3m (dB μ V/m)	Margin (dB)
V	2390.000	45.4	33	29.4	41.8	54.0	-12.2
H	4824.000	42.4	33	34.9	44.3	54.0	-9.7
H	7236.000	32.5	33	37.9	37.4	54.0	-16.6
V	9648.000	25.0	33	40.4	32.4	54.0	-21.6
H	12060.000	24.2	33	40.5	31.7	54.0	-22.3
V	14472.000	30.6	33	40.0	37.6	54.0	-16.4

Polarization	Frequency (MHz)	Reading (dB μ V)	Pre-Amp Gain (dB)	Antenna Factor (dB)	Net at 3m - Peak (dB μ V/m)	Peak Limit at 3m (dB μ V/m)	Margin (dB)
V	2390.000	59.3	33	29.4	55.7	74.0	-18.3
H	4824.000	53.7	33	34.9	55.6	74.0	-18.4
H	7236.000	44.8	33	37.9	49.7	74.0	-24.3
V	9648.000	38.4	33	40.4	45.8	74.0	-28.3
H	12060.000	37.7	33	40.5	45.2	74.0	-28.8
V	14472.000	43.9	33	40.0	50.9	74.0	-23.1

- NOTES:
1. Peak detector is used for the emission measurement.
 2. Average detector is used for the average data of emission measurement.
 3. All measurements were made at 3 meters.
 4. Negative value in the margin column shows emission below limit.
 5. Horn antenna is used for the emission over 1000MHz
 6. Emissions within the restricted band meets the requirement of FCC Part 15 Section 15.205 / RSS-Gen Section 8.10
 7. Measurement Uncertainty is ± 5.3 dB at a level of confidence of 95%.

TEST REPORT

RADIATED EMISSION DATA

Mode: TX-Channel 06

Table 2, IEEE 802.11b DSSS 1Mbps

Polarization	Frequency (MHz)	Reading (dB μ V)	Pre-Amp Gain (dB)	Antenna Factor (dB)	Net at 3m (dB μ V/m)	Average Limit at 3m (dB μ V/m)	Margin (dB)
H	4874.000	40.2	33	34.9	42.1	54.0	-11.9
H	7311.000	30.7	33	37.9	35.6	54.0	-18.4
V	9748.000	28.6	33	40.4	36.0	54.0	-18.0
H	12185.000	26.1	33	40.5	33.6	54.0	-20.4
V	14622.000	30.8	33	38.4	36.2	54.0	-17.8

Polarization	Frequency (MHz)	Reading (dB μ V)	Pre-Amp Gain (dB)	Antenna Factor (dB)	Net at 3m - Peak (dB μ V/m)	Peak Limit at 3m (dB μ V/m)	Margin (dB)
H	4874.000	51.7	33	34.9	53.6	74.0	-20.4
H	7311.000	43.5	33	37.9	48.4	74.0	-25.7
V	9748.000	40.9	33	40.4	48.3	74.0	-25.7
H	12185.000	39.5	33	40.5	47.0	74.0	-27.0
V	14622.000	44.3	33	38.4	49.7	74.0	-24.3

- NOTES:
1. Peak detector is used unless otherwise stated.
 2. Average detector is used for the average data of emission measurement.
 3. All measurements were made at 3 meters.
 4. Negative value in the margin column shows emission below limit.
 5. Horn antenna is used for the emission over 1000MHz
 6. Emissions within the restricted band meets the requirement of FCC Part 15 Section 15.205 / RSS-Gen Section 8.10
 7. Measurement Uncertainty is ± 5.3 dB at a level of confidence of 95%.

TEST REPORT

RADIATED EMISSION DATA

Mode: TX-Channel 11

Table 3, IEEE 802.11b DSSS 1Mbps

Polari- zation	Frequency (MHz)	Reading (dB μ V)	Pre-Amp Gain (dB)	Antenna Factor (dB)	Net at 3m (dB μ V/m)	Average Limit at 3m (dB μ V/m)	Margin (dB)
V	2483.500	44.1	33	29.4	40.5	54.0	-13.5
V	4924.000	43.0	33	34.9	44.9	54.0	-9.1
V	7386.000	28.3	33	37.9	33.2	54.0	-20.8
V	9848.000	26.6	33	40.4	34.0	54.0	-20.0
H	12310.000	25.7	33	40.5	33.2	54.0	-20.8
V	14772.000	30.2	33	38.4	35.6	54.0	-18.4

Polari- zation	Frequency (MHz)	Reading (dB μ V)	Pre-Amp Gain (dB)	Antenna Factor (dB)	Net at 3m - Peak (dB μ V/m)	Peak Limit at 3m (dB μ V/m)	Margin (dB)
V	2483.500	58.4	33	29.4	54.8	74.0	-19.2
V	4924.000	54.0	33	34.9	55.9	74.0	-18.2
V	7386.000	41.2	33	37.9	46.1	74.0	-27.9
V	9848.000	39.5	33	40.4	46.9	74.0	-27.2
H	12310.000	39.3	33	40.5	46.8	74.0	-27.2
V	14772.000	43.7	33	38.4	49.1	74.0	-24.9

- NOTES:
1. Peak detector is used unless otherwise stated.
 2. Average detector is used for the average data of emission measurement.
 3. All measurements were made at 3 meters.
 4. Negative value in the margin column shows emission below limit.
 5. Horn antenna is used for the emission over 1000MHz
 6. Emissions within the restricted band meets the requirement of FCC Part 15 Section 15.205 / RSS-Gen Section 8.10
 7. Measurement Uncertainty is ± 5.3 dB at a level of confidence of 95%.

TEST REPORT

RADIATED EMISSION DATA

Mode: TX-Channel 01

Table 4, IEEE 802.11g OFDM, 6 Mbps

Polari- zation	Frequency (MHz)	Reading (dBμV)	Pre-Amp Gain (dB)	Antenna Factor (dB)	Net at 3m (dBμV/m)	Average Limit at 3m (dBμV/m)	Margin (dB)
V	2390.000	49.9	33	29.4	46.3	54.0	-7.7
H	4824.000	31.6	33	34.9	33.5	54.0	-20.5
V	7236.000	28.1	33	37.9	33.0	54.0	-21.0
V	9648.000	25.0	33	40.4	32.4	54.0	-21.6
H	12060.000	24.3	33	40.5	31.8	54.0	-22.2
V	14472.000	30.7	33	40.0	37.7	54.0	-16.3

Polari- zation	Frequency (MHz)	Reading (dBμV)	Pre-Amp Gain (dB)	Antenna Factor (dB)	Net at 3m - Peak (dBμV/m)	Peak Limit at 3m (dBμV/m)	Margin (dB)
V	2390.000	73.0	33	29.4	69.4	74.0	-4.6
H	4824.000	45.9	33	34.9	47.8	74.0	-26.2
V	7236.000	43.6	33	37.9	48.5	74.0	-25.5
V	9648.000	38.5	33	40.4	45.9	74.0	-28.1
H	12060.000	37.9	33	40.5	45.4	74.0	-28.6
V	14472.000	43.8	33	40.0	50.8	74.0	-23.2

- NOTES:
1. Peak detector is used for the emission measurement.
 2. Average detector is used for the average data of emission measurement.
 3. All measurements were made at 3 meters.
 4. Negative value in the margin column shows emission below limit.
 5. Horn antenna is used for the emission over 1000MHz
 6. Emissions within the restricted band meets the requirement of FCC Part 15 Section 15.205 / RSS-Gen Section 8.10
 7. Measurement Uncertainty is ±5.3dB at a level of confidence of 95%.

TEST REPORT

RADIATED EMISSION DATA

Mode: TX-Channel 06

Table 5, IEEE 802.11g OFDM, 6 Mbps

Polari- zation	Frequency (MHz)	Reading (dB μ V)	Pre-Amp Gain (dB)	Antenna Factor (dB)	Net at 3m (dB μ V/m)	Average Limit at 3m (dB μ V/m)	Margin (dB)
V	4874.000	33.4	33	34.9	35.3	54.0	-18.7
V	7311.000	25.7	33	37.9	30.6	54.0	-23.4
H	9748.000	26.0	33	40.4	33.4	54.0	-20.6
H	12185.000	26.2	33	40.5	33.7	54.0	-20.3
H	14622.000	30.9	33	38.4	36.3	54.0	-17.7

Polari- zation	Frequency (MHz)	Reading (dB μ V)	Pre-Amp Gain (dB)	Antenna Factor (dB)	Net at 3m - Peak (dB μ V/m)	Peak Limit at 3m (dB μ V/m)	Margin (dB)
V	4874.000	48.1	33	34.9	50.0	74.0	-24.0
V	7311.000	39.1	33	37.9	44.0	74.0	-30.0
H	9748.000	39.5	33	40.4	46.9	74.0	-27.1
H	12185.000	39.7	33	40.5	47.2	74.0	-26.8
H	14622.000	44.1	33	38.4	49.5	74.0	-24.5

- NOTES: 1. Peak detector is used unless otherwise stated.
 2. Average detector is used for the average data of emission measurement.
 3. All measurements were made at 3 meters.
 4. Negative value in the margin column shows emission below limit.
 5. Horn antenna is used for the emission over 1000MHz
 6. Emissions within the restricted band meets the requirement of FCC Part 15 Section 15.205 / RSS-Gen Section 8.10
 7. Measurement Uncertainty is ± 5.3 dB at a level of confidence of 95%.

TEST REPORT

RADIATED EMISSION DATA

Mode: TX-Channel 11

Table 6, IEEE 802.11g OFDM, 6 Mbps

Polarization	Frequency (MHz)	Reading (dB μ V)	Pre-Amp Gain (dB)	Antenna Factor (dB)	Net at 3m (dB μ V/m)	Average Limit at 3m (dB μ V/m)	Margin (dB)
V	2483.500	47.0	33	29.4	43.4	54.0	-10.6
V	4924.000	34.8	33	34.9	36.7	54.0	-17.3
V	7386.000	26.0	33	37.9	30.9	54.0	-23.1
V	9848.000	25.0	33	40.4	32.4	54.0	-21.6
H	12310.000	25.7	33	40.5	33.2	54.0	-20.8
V	14772.000	30.4	33	38.4	35.8	54.0	-18.2

Polarization	Frequency (MHz)	Reading (dB μ V)	Pre-Amp Gain (dB)	Antenna Factor (dB)	Net at 3m - Peak (dB μ V/m)	Peak Limit at 3m (dB μ V/m)	Margin (dB)
V	2483.500	69.2	33	29.4	65.6	74.0	-8.4
V	4924.000	49.4	33	34.9	51.3	74.0	-22.7
V	7386.000	40.4	33	37.9	45.3	74.0	-28.7
V	9848.000	38.6	33	40.4	46.0	74.0	-28.0
H	12310.000	39.5	33	40.5	47.0	74.0	-27.0
V	14772.000	43.5	33	38.4	48.9	74.0	-25.1

- NOTES:
1. Peak detector is used unless otherwise stated.
 2. Average detector is used for the average data of emission measurement.
 3. All measurements were made at 3 meters.
 4. Negative value in the margin column shows emission below limit.
 5. Horn antenna is used for the emission over 1000MHz
 6. Emissions within the restricted band meets the requirement of FCC Part 15 Section 15.205 / RSS-Gen Section 8.10
 7. Measurement Uncertainty is ± 5.3 dB at a level of confidence of 95%.

TEST REPORT

RADIATED EMISSION DATA

Mode: TX-Channel 00

Table 7, IEEE 802.11n (20MHz) OFDM, MCS0

Polarization	Frequency (MHz)	Reading (dBμV)	Pre-Amp Gain (dB)	Antenna Factor (dB)	Net at 3m (dBμV/m)	Average Limit at 3m (dBμV/m)	Margin (dB)
V	2390.000	49.8	33	29.4	46.2	54.0	-7.8
H	4824.000	32.9	33	34.9	34.8	54.0	-19.2
H	7236.000	26.8	33	37.9	31.7	54.0	-22.3
V	9648.000	25.1	33	40.4	32.5	54.0	-21.5
V	12060.000	24.2	33	40.5	31.7	54.0	-22.3
V	14472.000	30.5	33	40.0	37.5	54.0	-16.5

Polarization	Frequency (MHz)	Reading (dBμV)	Pre-Amp Gain (dB)	Antenna Factor (dB)	Net at 3m - Peak (dBμV/m)	Peak Limit at 3m (dBμV/m)	Margin (dB)
V	2390.000	71.2	33	29.4	67.6	74.0	-6.4
H	4824.000	47.4	33	34.9	49.3	74.0	-24.7
H	7236.000	40.9	33	37.9	45.8	74.0	-28.2
V	9648.000	38.2	33	40.4	45.6	74.0	-28.4
V	12060.000	37.4	33	40.5	44.9	74.0	-29.1
V	14472.000	43.9	33	40.0	50.9	74.0	-23.1

- NOTES:
1. Peak detector is used for the emission measurement.
 2. Average detector is used for the average data of emission measurement.
 3. All measurements were made at 3 meters.
 4. Negative value in the margin column shows emission below limit.
 5. Horn antenna is used for the emission over 1000MHz
 6. Emissions within the restricted band meets the requirement of FCC Part 15 Section 15.205 / RSS-Gen Section 8.10
 7. Measurement Uncertainty is ±5.3dB at a level of confidence of 95%.

TEST REPORT

RADIATED EMISSION DATA

Mode: TX-Channel 06

Table 8, IEEE 802.11n (20MHz) OFDM, MCS0

Polarization	Frequency (MHz)	Reading (dB μ V)	Pre-Amp Gain (dB)	Antenna Factor (dB)	Net at 3m (dB μ V/m)	Average Limit at 3m (dB μ V/m)	Margin (dB)
H	4874.000	29.9	33	34.9	31.8	54.0	-22.2
H	7311.000	25.9	33	37.9	30.8	54.0	-23.2
V	9748.000	26.0	33	40.4	33.4	54.0	-20.6
V	12185.000	26.1	33	40.5	33.6	54.0	-20.4
V	14622.000	30.9	33	38.4	36.3	54.0	-17.7

Polarization	Frequency (MHz)	Reading (dB μ V)	Pre-Amp Gain (dB)	Antenna Factor (dB)	Net at 3m - Peak (dB μ V/m)	Peak Limit at 3m (dB μ V/m)	Margin (dB)
H	4874.000	44.0	33	34.9	45.9	74.0	-28.2
H	7311.000	40.2	33	37.9	45.1	74.0	-28.9
V	9748.000	39.7	33	40.4	47.1	74.0	-26.9
V	12185.000	39.9	33	40.5	47.4	74.0	-26.6
V	14622.000	44.8	33	38.4	50.2	74.0	-23.8

- NOTES:
1. Peak detector is used unless otherwise stated.
 2. Average detector is used for the average data of emission measurement.
 3. All measurements were made at 3 meters.
 4. Negative value in the margin column shows emission below limit.
 5. Horn antenna is used for the emission over 1000MHz
 6. Emissions within the restricted band meets the requirement of FCC Part 15 Section 15.205 / RSS-Gen Section 8.10
 7. Measurement Uncertainty is ± 5.3 dB at a level of confidence of 95%.

TEST REPORT

RADIATED EMISSION DATA

Mode: TX-Channel 11

Table 9, IEEE 802.11n (20MHz) OFDM, MCS0

Polarization	Frequency (MHz)	Reading (dB μ V)	Pre-Amp Gain (dB)	Antenna Factor (dB)	Net at 3m (dB μ V/m)	Average Limit at 3m (dB μ V/m)	Margin (dB)
V	2483.500	45.3	33	29.4	41.7	54.0	-12.3
H	4924.000	31.3	33	34.9	33.2	54.0	-20.8
H	7386.000	24.4	33	37.9	29.3	54.0	-24.8
V	9848.000	24.9	33	40.4	32.3	54.0	-21.7
V	12310.000	25.8	33	40.5	33.3	54.0	-20.7
V	14772.000	30.2	33	38.4	35.6	54.0	-18.4

Polarization	Frequency (MHz)	Reading (dB μ V)	Pre-Amp Gain (dB)	Antenna Factor (dB)	Net at 3m - Peak (dB μ V/m)	Peak Limit at 3m (dB μ V/m)	Margin (dB)
V	2483.500	61.3	33	29.4	57.7	74.0	-16.3
H	4924.000	45.9	33	34.9	47.8	74.0	-26.2
H	7386.000	37.8	33	37.9	42.7	74.0	-31.3
V	9848.000	38.3	33	40.4	45.7	74.0	-28.3
V	12310.000	39.6	33	40.5	47.1	74.0	-26.9
V	14772.000	43.5	33	38.4	48.9	74.0	-25.1

- NOTES:
1. Peak detector is used unless otherwise stated.
 2. Average detector is used for the average data of emission measurement.
 3. All measurements were made at 3 meters.
 4. Negative value in the margin column shows emission below limit.
 5. Horn antenna is used for the emission over 1000MHz
 6. Emissions within the restricted band meets the requirement of FCC Part 15 Section 15.205 / RSS-Gen Section 8.10
 7. Measurement Uncertainty is ± 5.3 dB at a level of confidence of 95%.

TEST REPORT

RADIATED EMISSION DATA

Mode: Wifi Operating

Table 10

Polarization	Frequency (MHz)	Reading (dB μ V)	Pre-amp (dB)	Antenna Factor (dB)	Net at 3m (dB μ V/m)	Limit at 3m (dB μ V/m)	Margin (dB)
V	59.744	41.2	16	10.0	35.2	40.0	-4.8
V	187.140	35.3	16	16.0	35.3	43.5	-8.2
V	199.993	33.5	16	16.0	33.5	43.5	-10.0
V	624.993	32.0	16	29.0	45.0	46.0	-1.0
V	674.929	24.3	16	29.0	37.3	46.0	-8.7
V	960.230	27.8	16	33.0	44.8	54.0	-9.2

- NOTES:
1. Peak detector is used unless otherwise stated.
 2. All measurements were made at 3 meters.
 3. Negative value in the margin column shows emission below limit.
 4. Emissions within the restricted band meets the requirement of FCC Part 15 Section 15.205 / RSS-Gen Section 8.10
 5. Measurement Uncertainty is ± 5.3 dB at a level of confidence of 95%.

TEST REPORT

4.6.3 Radiated Emission Test Setup

The figure below shows the test setup, which is utilized to make these measurements.

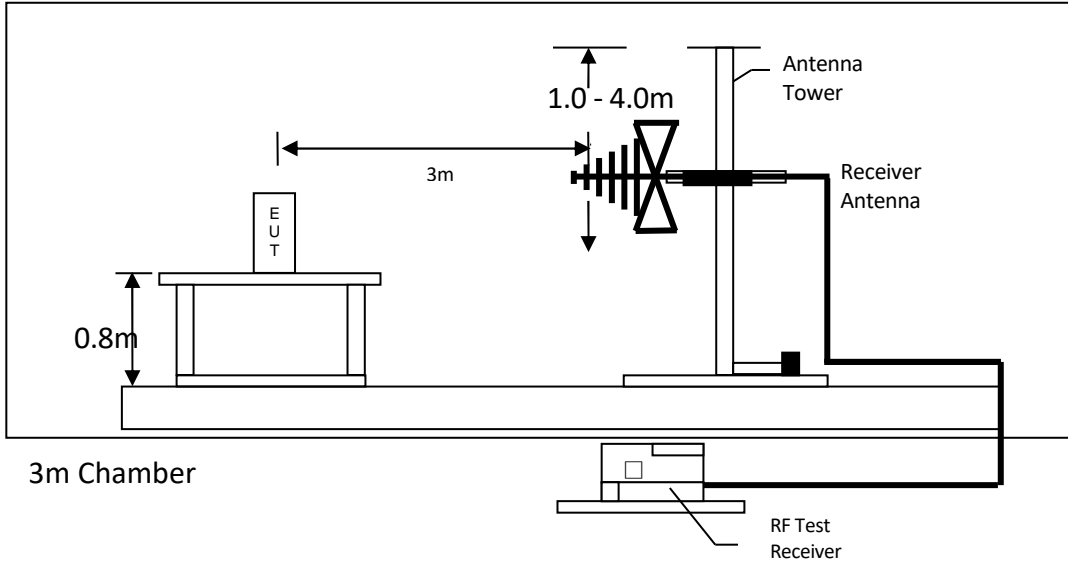

Test setup of radiated emissions up to 1GHz

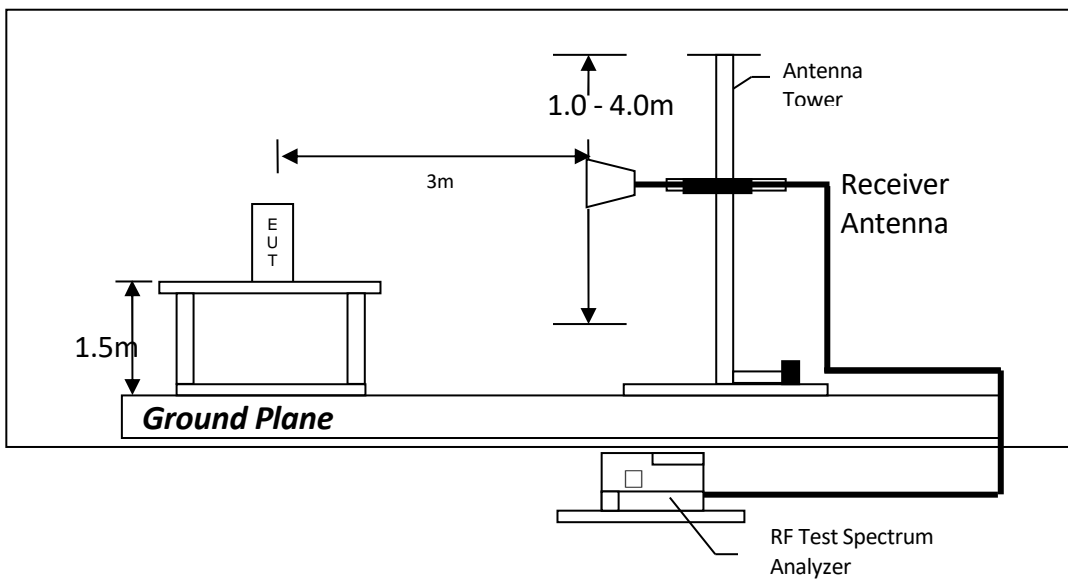

Test setup of radiated emissions above 1GHz

TEST REPORT

4.6.4 Transmitter Duty Cycle Calculation

Not Applicable – No average factor is required

TEST REPORT

4.7 AC Power Line Conducted Emission

- Not Applicable – EUT is only powered by battery for operation.
- EUT connects to AC power line. Emission Data is listed in following pages.
- Base Unit connects to AC power line and has transmission. Handset connects to AC power line but has no transmission. Emission Data of Base Unit is listed in following pages.

4.7.1 AC Power Line Conducted Emission Configuration Photograph

Worst Case Line-Conducted Configuration

at 2.5665 MHz

The worst case line conducted configuration photographs are attached in the Appendix and saved with filename: config photos.pdf.

4.7.2 AC Power Line Conducted Emission Data

The plot(s) and data in the following pages list the significant emission frequencies, the limit and the margin of compliance.

Passed by 20.5 dB margin compare with CISPR Average limit.

TEST REPORT

AC POWER LINE CONDUCTED EMISSION

Worst Case: Wifi Operating

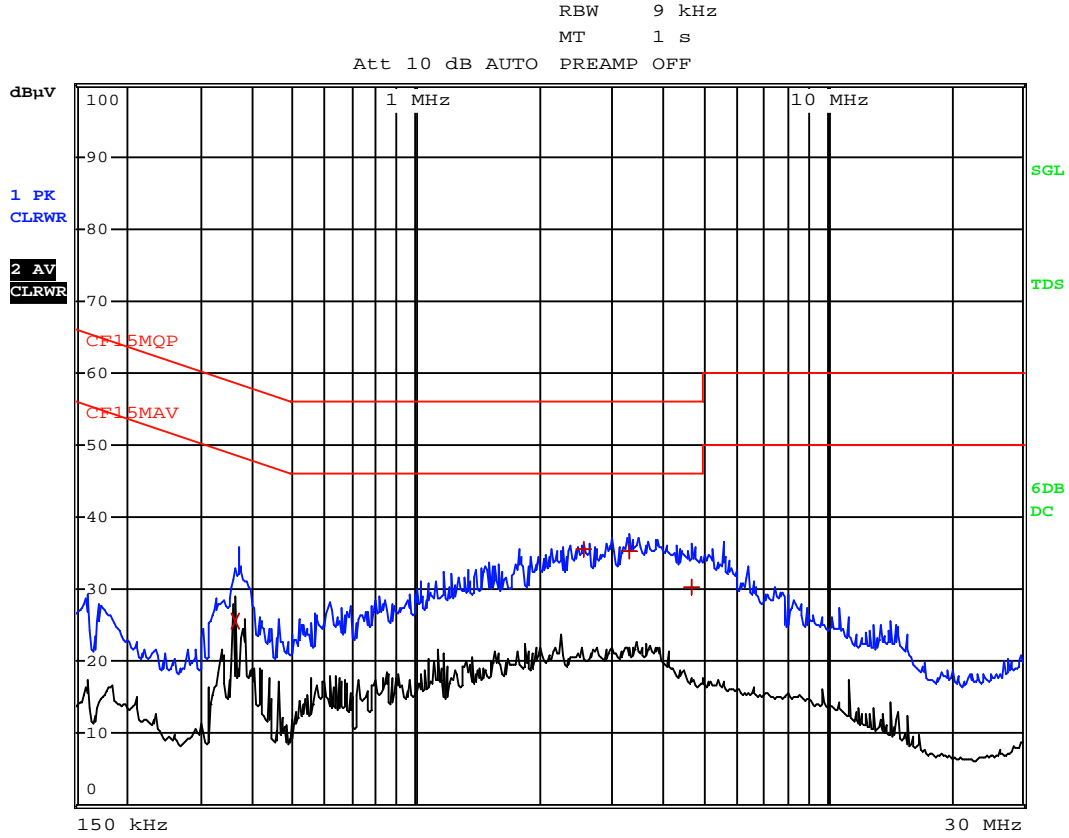

Date: 23.AUG.2022 16:24:50

TEST REPORT

AC POWER LINE CONDUCTED EMISSION

Worst Case: Wifi Operating

EDIT PEAK LIST (Final Measurement Results)				
Trace1:	CF15MQP			
Trace2:	CF15MAV			
Trace3:	---			
TRACE	FREQUENCY	LEVEL dBµV		DELTA LIMIT dB
2 CISPR Average	361.5 kHz	25.63	L1	-23.05
1 Quasi Peak	2.5665 MHz	35.54	N	-20.45
1 Quasi Peak	3.309 MHz	35.22	N	-20.77
1 Quasi Peak	4.6995 MHz	30.36	N	-25.63

Date: 23.AUG.2022 16:25:35

TEST REPORT

4.7.3 Conducted Emission Test Setup

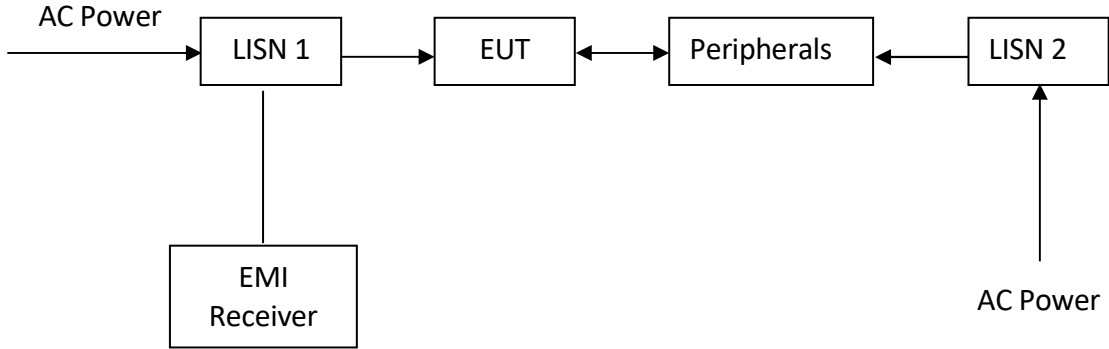

TEST REPORT

EXHIBIT 5 EQUIPMENT LIST

1) Radiated Emissions Test

Equipment	EMI Test Receiver 7GHz	Signal and Spectrum Analyzer (10Hz to 40GHz)	Biconical Antenna
Registration No.	EW-3481	EW-3016	EW-2512
Manufacturer	ROHDESCHWARZ	ROHDESCHWARZ	EMCO
Model No.	ESR7	FSV40	3104C
Calibration Date	December 21, 2021	October 29, 2021	June 03, 2020
Calibration Due Date	December 21, 2022	October 29, 2022	December 03, 2022

Equipment	Log Periodic Antenna	Double Ridged Guide Antenna	RF Cable 14m (1GHz to 26.5GHz)
Registration No.	EW-3243	EW-1133	EW-2781
Manufacturer	EMCO	EMCO	GREATBILLION
Model No.	3148B	3115	SMA m/SHF5MPU /SMA m ra14m,26G
Calibration Date	June 30, 2021	May 26, 2021	November 24, 2020
Calibration Due Date	December 30, 2022	November 26, 2022	November 24, 2022

Equipment	RF Pre-amplifier 3 pcs (9kHz to 40GHz)	Notch Filter (cutoff frequency 2.4GHz to 2.5GHz) 2 pieces	14m Double Shield RF Cable (20MHz to 6GHz)
Registration No.	EW-3006	EW-2213	EW-2074
Manufacturer	SCHWARZBECK	MICROWAVE	RADIALL
Model No.	BBV 9718 BBV9744 BBV 9721	BRM50701-02	N(m)-RG142-BNC(m) L= 14M
Calibration Date	February 15, 2022	November 12, 2021	December 10, 2021
Calibration Due Date	February 15, 2023	November 12, 2022	December 10, 2022

Equipment	Pyramidal Horn Antenna	Active Loop H-field (9kHz to 30MHz)
Registration No.	EW-0905	EW-3326
Manufacturer	EMCO	EMCO
Model No.	3160-09	6502
Calibration Date	July 20, 2021	December 13, 2021
Calibration Due Date	January 20, 2023	June 13, 2023

TEST REPORT

5.0 EQUIPMENT LIST (CONT'D)

2) Conducted Emissions Test

Equipment	RF Cable 240cm (RG142) (9kHz to 30MHz)	Artificial Mains Network	EMI Test Receiver 7GHz
Registration No.	EW-2454	EW-2501	EW-3481
Manufacturer	RADIALL	ROHDESCHWARZ	ROHDESCHWARZ
Model No.	Bnc m st / 142 / bnc mra 240cm	ENV-216	ESR7
Calibration Date	January 26, 2022	September 11, 2021	December 21, 2021
Calibration Due Date	January 26, 2023	September 11, 2022	December 21, 2022

3) Conductive Measurement Test

Equipment	5m RF Cable (40GHz)	RF Power Meter with Power Sensor (N1921A)	Signal and Spectrum Analyzer (10Hz to 40GHz)
Registration No.	EW-2701	EW-3309	EW-3016
Manufacturer	RADIALL	ROHDESCHWARZ	ROHDESCHWARZ
Model No.	Sma m-m 5m 40G	NRP-Z81	FSV40
Calibration Date	November 24, 2020	December 01, 2021	October 29, 2021
Calibration Due Date	November 24, 2022	December 01, 2022	October 29, 2022

4) Bandedge & Bandwidth Measurement

Equipment	Signal and Spectrum Analyzer (10Hz to 40GHz)	5m RF Cable (40GHz)
Registration No.	EW-3016	EW-2701
Manufacturer	ROHDESCHWARZ	RADIALL
Model No.	FSV40	Sma m-m 5m 40G
Calibration Date	October 29, 2021	November 24, 2020
Calibration Due Date	October 29, 2022	November 24, 2022

END OF TEST REPORT