

Go to www.vtechphones.com to register your product for enhanced warranty support and the latest VTech product news.

VM3258 VM3258-2 Video Baby Monitor



For more support information

vttech® Quick start guide

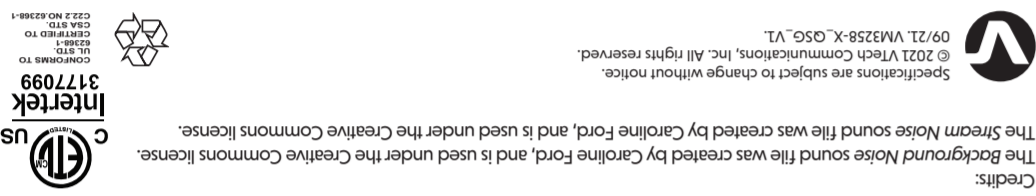

TECHNICAL SPECIFICATIONS	
Frequency control	Crystal controlled PLL synthesizer
Transmit frequency	Baby unit: 2405 - 2475 MHz Parent unit: 2405 - 2475 MHz
Channels	32
LCD	2.8" Color LCD (QVGA 320x240 pixels)
Nominal effective range	Maximum power allowed by FCC and IC. Actual operating range may vary according to environmental conditions at the time of use.
Power requirements	Parent unit: 3.6V, 2600mAh Li-ion, 9.36Wh Li-ion battery Baby unit power adapter: Output: 5V DC @ 600mA Parent unit power adapter: Output: 5V DC @ 1A
Credits: The Background Noise sound file was created by Caroline Ford, and is used under the Creative Commons license. The Stream Noise sound file was created by Caroline Ford, and is used under the Creative Commons license. © 2022 VTech Communications, Inc. All rights reserved. VTech VM3258-K, G50, 1A	

IMPORTANT SAFETY INSTRUCTIONS

- The applied nameplate is located at the bottom of the baby unit's base.
- When using your equipment, basic safety precautions should always be followed to reduce the risk of fire, electric shock and injury, including the following:
- Follow all warnings and instructions marked on the product.
 - Adult setup is required.
 - CAUTION:** Do not install the baby unit at a height above 2 meters.
 - This product is not a substitute for adult supervision of the infant. Supervising the infant is the parent's or caregiver's responsibility. This product could cease operating, and therefore you should not assume it will continue working properly for any given period of time. Further, this is not a medical device and should not be used as such. This product is intended to assist you in supervising your baby. Do not use this product near water. For example, do not use it next to a bath tub, wash bowl, kitchen sink, laundry tub or swimming pool, or in a wet basement or shower.
 - CAUTION:** Use only the battery provided. There may be a risk of explosion if a wrong type of battery is used for the parent unit. The battery cannot be subjected to high or low extreme temperature and low air pressure at high altitude during use, storage or transportation. Disposal of battery into fire or a hot oven, or mechanically crushing or cutting of the battery can result in an explosion. Leaving the battery in an extremely high temperature surrounding environment can result in an explosion or the leakage of flammable liquid of gas. Battery subjected to extremely low air pressure may result in an explosion or the leakage of flammable liquid or gas. Dispose of used battery according to the information in **The RBRC seal**.
 - Use only the adapters included with this product. Incorrect adapter polarity or voltage can seriously damage the product.
 - Power adapter information: Parent unit output: 5V DC 1A VTech Telecommunications Ltd. Model: VT05EU050100
 - Rechargeable battery information: Zhenhai Great Power Energy Co., Ltd. Li-ion battery: 3.6V, 2600mAh, 9.36Wh; Model: LCR18650-2.6Ah-3.6V-151P
 - The power adapters are intended to be correctly oriented in a vertical or floor mount position. The prongs are not designed to hold the plug in place if it is plugged into a ceiling, under-the-table or cabinet outlet.
 - For pluggable equipment, the socket-outlet shall be installed near the equipment and shall be easily accessible.
 - Unplug this product from the wall outlet before cleaning. Do not use liquid or aerosol cleaners. Use a damp cloth for cleaning.
 - Do not cut off the power adapters to replace them with other plugs, as this causes a hazardous situation.
 - Do not allow anything to rest on the power cords. Do not install this product where the cords may be walked on or crimped.
 - This product should be operated only from the type of power source indicated on the marking label. If you are not sure of the type of power supply in your home, consult your dealer or local power company.
 - Do not overload wall outlets or use an extension cord.
 - Do not place this product on an unstable shelf, stand or other unstable surfaces.
 - This product should not be placed in any area where proper ventilation is not provided. Slots and openings in the back or bottom of this product are provided for ventilation. To protect them from overheating, these openings must not be blocked by placing the product on a soft surface such as a bed, sofa or rug. This product should never be placed near or over a radiator or heat register.
 - Never push objects of any kind into this product through the slots because they may touch dangerous voltage points or create a short circuit. Never spill liquid of any kind on the product.
 - To reduce the risk of electric shock, do not disassemble this product, but take it to an authorized service facility. Opening or removing parts of the product other than specified access doors may expose you to dangerous voltages or other risks. Incorrect reassembling can cause electric shock when the product is subsequently used.
 - You should test the sound reception every time you turn on the units or move one of the components.
 - Periodically examine all components for damage.
 - There is a very low risk of privacy loss when using certain electronic devices, such as baby monitors, cordless telephones, etc. To protect your privacy, make sure the product has never been used before purchase, reset the baby monitor periodically by powering off and then powering on the units, and power off the baby monitor if you will not use it for some time.
 - Children should be supervised to ensure that they do not play with the product.
 - The product is not intended for use by persons (including children) with reduced physical, sensory or mental capabilities, or lack of experience and knowledge, unless they have been given supervision or instruction concerning use of the appliance by a person responsible for their safety.
- SAVE THESE INSTRUCTIONS**
- Cautions**
- Use and store the product at a temperature between 32°F and 104°F.
 - Do not expose the product to extreme cold, heat or direct sunlight. Do not put the product close to a heating source.
 - Batteries should not be exposed to excessive heat such as bright sunshine or fire.
- Warning—Strangulation Hazard—Children have STRANGLED in Cars.** Keep this cord out of the reach of children (more than 3 ft (0.9m) away). Do not remove this tag.
- Warning—Strangulation Hazard—Children have STRANGLED in Cords.** Keep this cord out of the reach of children (more than 3 ft (0.9m) away). Do not remove this tag.
- Precautions for users of implanted cardiac pacemakers**
Cardiac pacemakers (applies only to digital cordless devices)
Wireless Technology Research, LLC (WTR), an independent research entity, led a multidisciplinary evaluation of the interference between portable wireless devices and implanted cardiac pacemakers. Supported by the U.S. Food and Drug Administration, WTR recommends to physicians that:
Pacemaker patients
• Should keep wireless devices at least six inches from the pacemaker.
• Should NOT place wireless devices directly over the pacemaker, such as in a breast pocket, when it is turned ON.
WTR's evaluation did not identify any risk to bystanders with pacemakers from other persons using wireless devices.
Electromagnetic fields (EMF)
This VTech product complies with all standards regarding electromagnetic fields (EMF). If handled properly and according to the instructions in this user's manual, the product is safe to be used based on scientific evidence available today.

WHAT'S IN THE BOX

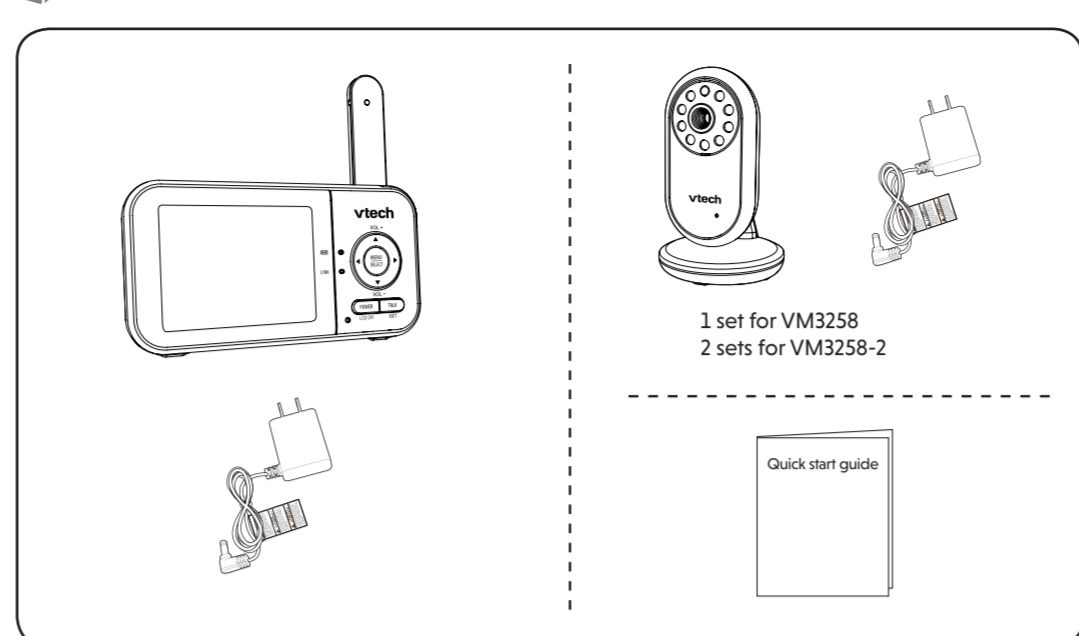

1 CONNECT THE BABY MONITOR

NOTES

- The rechargeable battery in the parent unit is built-in.
- Use only the power adapters supplied with this product.
- Make sure the baby monitor is not connected to a switch-controlled electric outlet.
- Connect the power adapters in a vertical or floor mount position only. The adapters' prongs are not designed to hold the weight of a baby monitor, so do not connect them to any ceiling, under-the-table, or cabinet outlets. Otherwise, the adapters may not properly connect to the outlets.
- Make sure the parent unit, the baby units and the power adapter cords are out of reach of children.

Precautions for users of implanted cardiac pacemakers
Cardiac pacemakers (applies only to digital cordless devices)
Wireless Technology Research, LLC (WTR), an independent research entity, led a multidisciplinary evaluation of the interference between portable wireless devices and implanted cardiac pacemakers. Supported by the U.S. Food and Drug Administration, WTR recommends to physicians that:
Pacemaker patients
• Should keep wireless devices at least six inches from the pacemaker.
• Should NOT place wireless devices directly over the pacemaker, such as in a breast pocket, when it is turned ON.
WTR's evaluation did not identify any risk to bystanders with pacemakers from other persons using wireless devices.
Electromagnetic fields (EMF)
This VTech product complies with all standards regarding electromagnetic fields (EMF). If handled properly and according to the instructions in this user's manual, the product is safe to be used based on scientific evidence available today.

1 CONNECT THE BABY MONITOR (CONT'D)

Charge the parent unit battery
When you have connected and turned on the parent unit, the battery will be charged automatically.

NOTES

- Before using the baby monitor for the first time, charge the parent unit battery for 12 hours. When the parent unit battery is fully charged, the battery icon becomes solid
- It takes longer to charge the battery when the parent unit is turned on. To shorten the charging time, turn the parent unit off while charging.
- The standby time varies depending on the sensitivity level you set, your actual use and the age of the battery.

The battery icon indicates the battery status (see the following table).

BATTERY INDICATORS	BATTERY STATUS	ACTION
The screen displays . The light flashes.	The battery has very little charge and may be used for only a short time.	Charge without interruption (about 30 minutes).
The battery icon becomes solid .	The battery is fully charged.	To keep the battery charged, connect it to AC power when not in use.

2 POWER ON OR OFF THE BABY MONITOR

- Connect the baby unit to a power supply to turn it on. Disconnect the baby unit to turn it off.
- Press and hold **POWER** to power on or off your parent unit.

Power off (Press and hold)

Power on (Press and hold)

3 POSITIONING THE BABY MONITOR

CAUTION

- Keep the baby unit out of the reach of your baby. Never place or mount the baby unit inside the baby's crib or playpen.

- Position the baby unit at least 3ft (1m) away from the baby's crib or playpen.
- Position the baby unit at least 3ft (1m) away from other electronic devices.
- Position the baby unit at least 3ft (1m) away from wireless routers, microwaves, cell phones and computers.
- Turn down the volume of your parent unit.

CAUTION

- The default volume of your parent unit is level 3, and the maximum volume is level 5. If you experience high-pitched screaming noise from your baby monitor while positioning:
 - Make sure your baby unit and parent unit are more than 3 feet (1 meter) apart, OR
 - Turn down the volume of your parent unit.

NOTE

- To avoid interference from other electronic devices, place your baby monitor at least 3 feet (1 meter) away from devices such as wireless routers, microwaves, cell phones and computers.

4 STATUS CHECK

Once you power on both your baby unit and parent unit, your parent unit displays image from the baby unit, and the **LINK** LED light turns on.

The baby unit's **POWER** LED light turns on.

BASIC OPERATION - PARENT UNIT

Use the menu

Press **MENU** to enter the menu, or save a setting. You can use the parent unit for advanced settings or operations, such as to play or stop the baby unit's lullaby, or to adjust the baby unit's sound sensitivity.

While in the menu:

- Press **◀** or **▶** to scroll among the menu options.
- Press **▲** or **▼** to select an item.
- Press **SELECT** to confirm your selection.
- Press **TALK/EXIT** to exit the menu and return to live view.

Talk to your baby unit

Press and hold **TALK** and speak to your parent unit. Your voice is transmitted to the baby unit. Release **TALK** when done talking and hear your baby again.

Turn off the screen

Press **POWER/LCD OFF** to switch off the screen. You can still hear sound from the selected baby unit.

TIP

- Press any key on the parent unit to turn on the screen again.

Adjust parent unit speaker volume

- Press **▲ VOL+ / ▼ VOL-** to adjust your parent unit speaker volume.

Zoom

- Press **MENU** when in idle mode.
- Choose
- Press **▲** or **▼** to choose **2X** (Zoom in) or **1X** (Zoom out), then press **SELECT** to confirm your selection.

OVERVIEW - PARENT UNIT

- Antenna
- Battery LED light
- 3-level sound indicator light
- Arrow keys
- MENU/SELECT
- LINK LED light
- TALK/EXIT
- POWER/LCD OFF
- Microphone
- Power jack
- RESET
- Speaker

The parent unit and baby unit(s) provided are already paired.

OVERVIEW - BABY UNIT

- Light Sensor
- Camera lens
- Infrared LEDs
- POWER LED light
- Night light
- Microphone
- Power jack
- Speaker
- PAIR hole
- Night light ON/OFF
- Slots for wall mounting

NEED HELP?

For operations and guides to help you using your video monitor, and for latest information and supports, go and check the online help topics and online FAQs.

Use your smartphone or mobile device to access our online help.

- Go to <https://help.vtechphones.com/VM3258> or <https://help.vtechphones.com/VM3258-2>; OR
- Scan the QR code on the right. Launch the camera app or QR code scanner app on your smartphone or tablet. Hold the device's camera up to the QR code and frame it. Tap the notification to trigger the redirection of the online help.
- If the QR code is not clearly displayed, adjust your camera's focus by moving your device closer or further away until it is clear.

You can also call our Customer Support at 1 (800) 595-9511 [in US] or 1 (800) 267-7377 [in Canada] for help.

PARENT UNIT ICONS

Status icons

Connection status

- or displays when strong signal strength is detected between the baby unit and the parent unit.
- or displays when moderate or low signal strength is detected between the baby unit and the parent unit.

Patrol mode

- Displays when the parent unit is in **PATROL** mode (For VM3258-2 only).

Current view status

- Displays the baby unit number of the baby unit that is being viewed.

Zoom

- Displays when the current image on the parent unit has zoomed in.

Night vision

- Displays when the baby unit being viewed has activated the night vision feature.

Talkback

- Displays when talking back to the baby units from parent unit.

Lullaby

- Displays when a lullaby is playing.

Night light

- Displays when the baby unit's night light is turned on.

Mute alert

- Displays when the parent unit speaker volume is set to zero.
- Displays when the parent unit is talking to the baby unit.

Real-time temperature

- Displays the real-time temperature detected by the baby unit in Fahrenheit (°F) or Celsius (°C) (e.g. **57°F** or **14°C**).

Battery status

- animates when the battery is charging.
- displays solid when the battery is fully charged.
- displays when the battery is low and needs charging.

Main menu icons

Main menu	Sub-menu	Main menu	Sub-menu
Zoom	1X 2X	Sound Detection	VOX
Settings	Screen off timer OFF 3 min 30 min 60 min	VOX (Voice Activated Alert) Sensitivity	OFF ON
Brightness	Adjust the parent unit's LCD screen brightness level.	Sound-activated screen	OFF ON
Temperature	OFF ON	MIN MAX	°F °C

Zoom

- Zoom in and out of the video displayed from the baby unit.

Patrol mode

- Displays when the parent unit is in **PATROL** mode (For VM3258-2 only).

Current view status

- Displays the baby unit number of the baby unit that is being viewed.

Zoom

- Displays when the current image on the parent unit has zoomed in.

Night vision

- Displays when the baby unit being viewed has activated the night vision feature.

Talkback

- Displays when talking back to the baby units from parent unit.

Lullaby

- Displays when a lullaby is playing.

Night light

- Displays when the baby unit's night light is turned on.

Mute alert

- Displays when the parent unit speaker volume is set to zero.
- Displays when the parent unit is talking to the baby unit.

Real-time temperature

- Displays the real-time temperature detected by the baby unit in Fahrenheit (°F) or Celsius (°C) (e.g. **57°F** or **14°C**).

Battery status

- animates when the battery is charging.
- displays solid when the battery is fully charged.
- displays when the battery is low and needs charging.

Main menu icons

Main menu	Sub-menu	Main menu	Sub-menu
Zoom	1X 2X	Sound Detection	VOX
Settings	Screen off timer OFF 3 min 30 min 60 min	VOX (Voice Activated Alert) Sensitivity	OFF ON
Brightness	Adjust the parent unit's LCD screen brightness level.	Sound-activated screen	OFF ON
Temperature	OFF ON	MIN MAX	°F °C

Zoom

- Zoom in and out of the video displayed from the baby unit.

Patrol mode

- Displays when the parent unit is in **PATROL** mode (For VM3258-2 only).

Current view status

- Displays the baby unit number of the baby unit that is being viewed.

Zoom

- Displays when the current image on the parent unit has zoomed in.

Night vision

- Displays when the baby unit being viewed has activated the night vision feature.

Talkback

- Displays when talking back to the baby units from parent unit.

Lullaby

- Displays when a lullaby is playing.

Night light

- Displays when the baby unit's night light is turned on.

Mute alert

- Displays when the parent unit speaker volume is set to zero.
- Displays when the parent unit is talking to the baby unit.

Real-time temperature

- Displays the real-time temperature detected by the baby unit in Fahrenheit (°F) or Celsius (°C) (e.g. **57°F** or **14°C**).

Battery status

- animates when the battery is charging.
- displays solid when the battery is fully charged.
- displays when the battery is low and needs charging.

VOX (Voice Activated Alert) Sensitivity

- You can choose to hear sounds from the baby unit all the time, or to only hear sounds that exceed a certain level. Adjust the microphone sensitivity of your baby unit, the higher the sensitivity level, the more sensitive the baby unit is in detecting sounds to be transmitted to the parent unit. See **Sound sensitivity and sound activation** section.

Sound-activated screen

- When it is on, and the baby unit detects no sound, the parent unit screen stays off to save power. Once a sound is detected, the parent unit screen and speaker turns on automatically, and you can see and hear your baby. The parent unit will then turn off again after 50 seconds of no sound detection.

NOTE

- When the parent unit screen is off and it receives alerts, for example, link lost between parent unit and baby unit, or battery is low, the parent unit screen and speaker will turn on for 10 seconds.

☑️ PARENT UNIT ICONS (CONT'D)

Main menu icons

Main menu **Sub-menu**

Lullaby



Lullaby volume

- Adjust the baby unit's speaker volume when playing the lullaby.



STOP 1 2 3 4

- Select one of the four melodies to play, or stop a lullaby.

Night Light



OFF ON

- Turn on/off the night light.

Monitoring Mode (For VM3258-2 only)



Patrol mode

- Monitor your baby in **PATROL** mode, where the screen will cycle through display videos streamed from all the linked baby units (For VM3258-2 only).



can't

- View the video from your selected baby unit's camera.

Warning icons and messages



Battery low at Parent Unit

The battery is empty and needs to be recharged.



Operation is in progress.



Temperature too high

The temperature detected by the baby unit is higher than the desired temperature alert range.



Temperature too low

The temperature detected by the baby unit is lower than the desired temperature alert range.



No Link to Camera

The parent unit is searching for baby units or the link between the baby unit and the parent unit is lost.



The parent unit is connected to AC power.

Parent Unit Indication Lights

LINK

- On when the parent unit is linked to the baby unit.
- Flashes when the link to the baby unit being viewed is lost.



LINK

- On when the parent unit is connected to AC power, or the battery is charging.
- Flashes when the parent unit battery is low and needs charging.
- Off when the parent unit is disconnected from AC power.

🔊 SOUND SENSITIVITY AND SOUND ACTIVATION

Adjust the sound sensitivity of the baby unit

You can choose to hear sounds from the baby unit all the time, or to hear sounds that exceed a certain level. You can use the parent unit to adjust the microphone sensitivity of your baby unit. The higher the sensitivity level, the more sensitive the baby unit is in detecting sounds that transmit to the parent unit. The VOX sensitivity level is preset to the highest level.

VOX SENSITIVITY LEVEL	Highest	High	Medium	Low	Lowest
DESCRIPTION	The parent unit speaker is constantly on, and you will hear all sounds (including background noises) from your baby's room.	The parent unit speaker turns on for soft babbling and louder sounds from your baby. It remains quiet when your baby sleeps soundly.	The parent unit speaker turns on for loud babbling and louder sounds from your baby. It remains quiet when your baby makes soft sounds.	The parent unit speaker turns on for crying and louder sounds from your baby. It remains quiet when your baby makes soft sounds.	The parent unit speaker turns on for loud crying or screaming sounds from your baby. It remains quiet when your baby makes soft sounds.

Sound activated screen

When sound activation is on, the parent unit screen stays off to save power when the baby unit detects no sound. Once the baby unit detects sounds that are louder than the chosen sound sensitivity level, the parent unit screen turns on automatically. It will then turn off again after 50 seconds of no sound detection.

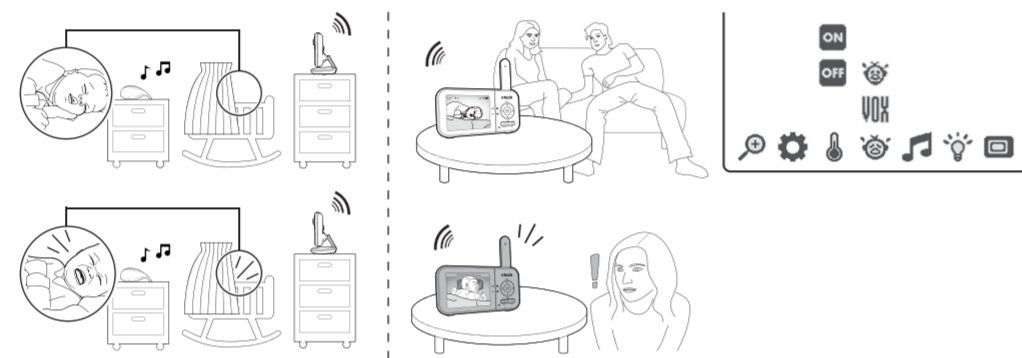

🌙 DIM MODE

The dim mode helps you save parent unit power. Your parent unit display will dim automatically after 10 minutes of inactivity, in which there is neither key pressed nor alert received from the baby unit.

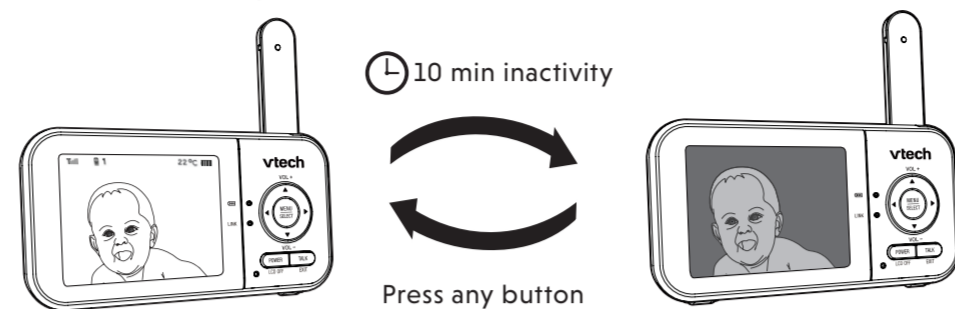

NOTE

- When the screen is dimmed, any keypress or alert message will trigger the screen to return to the preset brightness level. After 10 minutes of inactivity, it will resume to dim mode.

🌙 NIGHT VISION

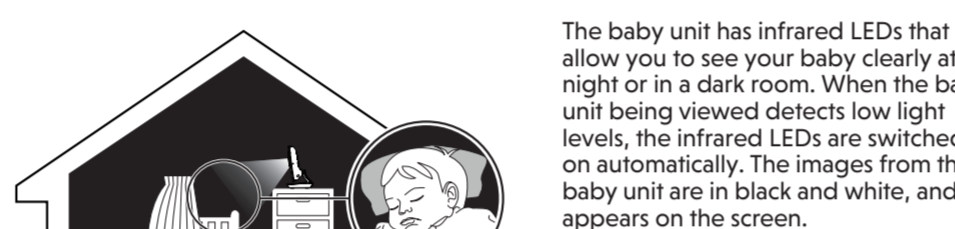

The baby unit has infrared LEDs that allow you to see your baby clearly at night or in a dark room. When the baby unit being viewed detects low light levels, the infrared LEDs are switched on automatically. The images from the baby unit are in black and white, and appears on the screen.

NOTES

- It is normal to see a short white glare on the screen when the baby unit is adapting to the dark environment.
- When the infrared LEDs are on, the images are in black and white. This is normal.

TIP

- Depending on the surroundings and other interfering factors, like lighting, objects, colors and backgrounds, the display resolution may vary. Adjust the baby unit's angle or place the baby unit at a higher elevation to prevent glare and a blurry display.

👁️ FOR VM3258-2 ONLY

Status check - Two baby units

If you are viewing baby unit **1**, the **POWER LED** light of baby unit **1** turns on. As baby unit **2** is not being viewed, its **POWER LED** light flashes.

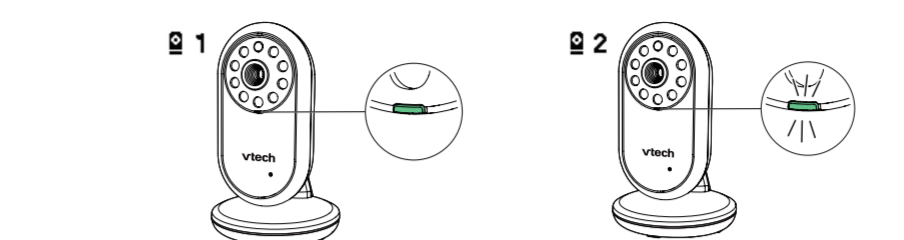

NOTE

- If you power on only one baby unit, your parent unit may display **Y** and the **LINK LED** light will flash.

Change different views - Patrol

- Press **MENU** when the parent unit is idle.
- Press **◀** or **▶** to choose **1**.
- Press **▼** or **▲** to choose **2**, then press **SELECT** to confirm your selection.

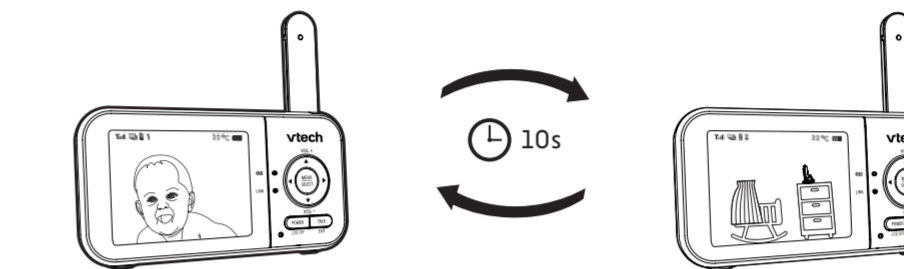

Change different views - Single-cam

- Press **MENU** when the parent unit is idle.
- Press **◀** or **▶** to choose **1**.
- Press **▼** or **▲** to choose between **1** and **2**, then press **SELECT** to confirm the baby unit you would like to view.

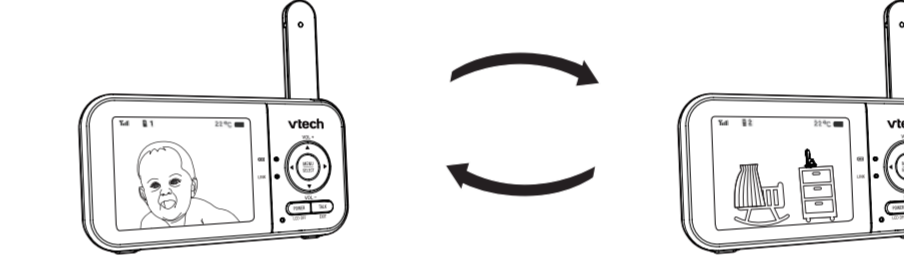

🔍 FREQUENTLY ASKED QUESTIONS

Below are the questions most frequently asked about the baby monitor.

Why is the baby monitor not responding normally?	Try the following (in the order listed) for common cure: 1. Disconnect the power to the baby units and the parent unit. 2. Wait a few seconds before connecting power back to the baby units and the parent unit. 3. Turn on the baby units and the parent unit. 4. Wait for the parent unit to synchronize with the baby units. Allow up to one minute for this to take place.
Why doesn't the power-on light of the baby unit and parent unit go on when I switch on the units?	Perhaps the parent unit is not connected to the power. Insert the appliance plug into the parent unit and put the adapter in a wall socket. Then, press and hold POWER to switch on the parent unit and to establish connection with the baby unit. Perhaps the baby unit is not connected to the power. Insert the appliance plug into the baby unit and put the adapter in a wall socket. The baby unit will switch on and establish a connection with the parent unit.
Why doesn't my parent unit charge while connected to AC power?	Make sure the power is not controlled by a wall switch. You may have used the battery for a long time. See Warranty for repair/replacement.
Why is my screen in black and white?	The screen is in black and white during night-time or in a dark room when the night vision feature is activated. This is normal.
Why do I get glare or a blurry display on my screen when viewing at night?	During night-time or in a dark room, the surroundings and other interfering factors, like lighting, objects, colors and backgrounds may affect the image quality on your parent unit screen. Adjust the baby unit's angle or place the baby unit at a higher elevation to prevent glare and a blurry display.
Why does the baby monitor produce a high-pitched noise?	The parent unit and baby units may be too close to each other. <ul style="list-style-type: none">Move the parent unit away from the baby units until the noise stops; ORTurn down the volume of your parent unit.
Why does the parent unit beep?	The baby units may be out of range. Move the parent unit closer to the baby units (but not less than 3 feet). The parent unit may not have enough power for the parent unit to perform normally. Charge the battery in the parent unit until the battery icon becomes solid 100% . The temperature of your baby's room may be too high or too low.
Why does the parent unit react too quickly to other sounds?	The baby unit also picks up other sounds than those of your baby. Adjust the VOX sensitivity level to a lower level or decrease the parent unit speaker volume.
Why can't I hear sounds/ my baby cry?	The parent unit speaker volume may be too low. See Adjust parent unit speaker volume to increase the volume. You may have set a low VOX sensitivity level. See Adjust the sound sensitivity of the baby unit to set to a higher level.
Why can't I establish a connection? Why is the connection lost every now and then? Why are there sound interruptions?	The baby units may be out of range. Move the parent unit closer to the baby units (but not less than 3 feet). Other electronic products and wireless products may cause interference with your baby monitor. Try installing your baby monitor as far away from these devices as possible. If you power on only one baby unit, your parent unit may display Y , and the LINK LED light will flash.

♻️ THE RBRC SEAL



The RBRC seal on the Li-ion battery indicates that VTech Communications, Inc. is voluntarily participating in an industry program to collect and recycle these batteries at the end of their useful lives, when taken out of service within the United States and Canada. The program provides a convenient alternative to placing used Li-ion batteries in the trash or municipal waste, which may be illegal in your area.

VTech's participation makes it easy for you to drop off the spent battery at local retailers participating in the program or at authorized VTech product service centers. Please call **1 (800) 8 BATTERY** for information on Li-ion battery recycling and disposal bans/restrictions in your area. VTech's involvement in this program is part of its commitment to protecting our environment and conserving natural resources.

The **RBRC Seal** and **1 (800) 8 BATTERY®** are registered trademarks of Call2recycle, Inc.

FCC AND IC REGULATIONS

FCC Part 15

This equipment has been tested and found to comply with the requirements for a Class B digital device under Part 15 of the Federal Communications Commission (FCC) rules. These requirements are intended to provide reasonable protection against harmful interference in a residential installation. This equipment generates, uses and can radiate radio frequency energy and, if not installed and used in accordance with the instructions, may cause harmful interference to radio communications. However, there is no guarantee that interference will not occur in a particular installation. If this equipment does cause harmful interference to radio or television reception, which can be determined by turning the equipment off and on, the user is encouraged to try to correct the interference by one or more of the following measures:

- Increase the separation between the equipment and receiver.
- Connect the equipment into an outlet on a circuit different from that to which the receiver is connected.
- Consult the dealer or an experienced radio/TV technician for help.

WARNING: Changes or modifications to this equipment not expressly approved by the party responsible for compliance could void the user's authority to operate the equipment.

This device complies with Part 15 of the FCC rules. Operation is subject to the following two conditions: (1) this device may not cause harmful interference, and (2) this device must accept any interference received, including interference that may cause undesired operation.

To ensure safety of users, the FCC has established criteria for the amount of radio frequency energy that can be safely absorbed by a user or bystander according to the intended usage of the product. This product has been tested and found to comply with the FCC criteria. The baby unit shall be installed and used such that parts of all persons' body are maintained at a distance of approximately 8 in (20 cm) or more. The transmitter and antenna of the parent unit shall be held at least 1 in (2.5 cm) from your face.

This Class B digital apparatus complies with Canadian regulations:

Industry Canada

This device contains licence-exempt transmitter(s)/receiver(s) that comply with Innovation, Science and Economic Development Canada's licence-exempt RSS(s). Operation is subject to the following two conditions: (1) This device may not cause interference. (2) This device must accept any interference, including interference that may cause undesired operation of the device.

The term "IC:" before the certification/registration number only signifies that the Industry Canada technical specifications were met.

This product meets the applicable Innovation, Science and Economic Development Canada technical specifications.

RF radiation exposure statement

The baby unit complies with FCC RF radiation exposure limits set forth for an uncontrolled environment. The baby unit should be installed and operated with a minimum distance of 8 in (20 cm) between the baby unit and all persons' body. Use of other accessories may not ensure compliance with FCC RF exposure guidelines. This transmitter must not be co-located or operating in conjunction with any other antenna or transmitter. This equipment complies also with Industry Canada RSS-102 with respect to Canada's Health Code 6 for Exposure of Humans to RF Fields.

CALIFORNIA ENERGY COMMISSION CHARACTERISTICS BATTERIES CHARGING TESTING MODE

This baby monitor meets the California Energy Commission (CEC) regulations for energy consumption. Your baby monitor is set up to comply with the energy-conservation standards right out of the box. Follow the instructions to install and charge the battery. The CEC battery charging testing mode is activated while charging. Even if the parent unit is paired to baby units, the CEC battery charging testing mode is activated while it is powered off and charging.

FOR CETL COMPLIANCE ONLY

Mesures de sécurité importantes
La plaque signalétique appliquée est située au bas du socle de l'unité du bébé. Lorsque vous utilisez votre appareil, vous devriez toujours suivre certaines mesures de précaution de base afin de réduire les risques d'incendie, d'électrocution et de blessures corporelles, dont ceux qui suivent:

- Observez toutes les instructions et mises en garde inscrites sur l'appareil.
- L'installation par un adulte est requise.
- MISE EN GARDE:** N'installez pas l'unité du bébé à une hauteur supérieure à 2 mètres.
- Ce produit ne remplace pas la surveillance adulte du nourrisson. La supervision du nourrisson est la responsabilité du parent ou de la personne qui s'occupe de l'enfant. Ce produit pourrait cesser de fonctionner et, par conséquent, vous ne devriez pas présumer qu'il continuera de fonctionner correctement pendant une période de temps donnée. De plus, il ne s'agit pas d'un instrument médical et ne devrait pas être utilisé comme tel. Ce produit est destiné à vous aider à superviser votre bébé.
- N'utilisez pas cet appareil près de l'eau ni de toute autre source d'humidité, par exemple, près d'une baignoire, cuve à lessive, évier de cuisine, dans un sous-sol humide ni près d'une piscine, dans un sous-sol humide ou une douche.
- MISE EN GARDE:** Utilisez uniquement les piles fournies. Il existe un risque d'explosion si un autre type de batterie est utilisé pour l'unité Parents. N'incinerez pas les piles. Celles-ci risquent d'exploser. Jetez les piles usées selon les renseignements suivant le **seau du RBRC**.
- N'utilisez que les adaptateurs inclus avec ce produit. L'utilisation d'un adaptateur dont la polarité ou la tension serait inadéquates risque d'endommager sérieusement le produit et mettre votre sécurité en péril.

Informations sur les adaptateurs électriques :
Adaptateur de l'unité du parent : Sortie : 5V DC 1A Vtech Telecommunications Ltd. Modèle : VT03EU505100
Adaptateur de l'unité du bébé : Sortie : 5V DC 600mA Vtech Telecommunications Ltd. Modèle : VT03EU505060

Informations sur les piles rechargeables :
Zhuhai Great Power Co., Ltd. 3.6V, 2600mAh, 9.36Wh; Modèle : ICR18650-2.6Ah-3.6V-31P
Lorsqu'ils sont branchés dans une prise de courant, les adaptateurs secteur ont été conçus pour être orientés correctement, soit à verticale ou au plancher. Les câbles n'ont pas été conçus pour supporter le poids du bloc d'alimentation et le maintenir en place si celui-ci est branché dans une prise au plafond, sous une table ou dans un meuble.

- NE PAS BRANCHER À UNE PRISE DE COURANT** la prise de courant doit être installée près du produit, afin d'assurer une accessibilité sécuritaire à la prise de courant.
- Débranchez ce produit de la prise de courant avant de procéder au nettoyage. N'utilisez pas de nettoyeurs à aérosols. Utilisez un chiffon humide pour le nettoyer.
- Ne coupez pas les cordons d'alimentation pour remplacer des câbles, car ceci peut présenter un danger potentiel.
- Ne laissez aucun objet reposer ni appuyer sur le cordon d'alimentation. N'installez pas cet appareil dans un endroit où l'on risque d'accrocher le cordon d'alimentation ou de le piétrer.
- Ne faites fonctionner cet appareil qu'avec le type d'alimentation indiqué sur l'étiquette. Si vous ne connaissez pas le type d'alimentation que vous possédez à votre domicile, consultez votre marchand ou votre compagnie locale d'électricité.
- Ne surchargez pas les prises de courant murales ni les rallonges électriques.
- Ne placez pas cet appareil sur un chariot, meuble, trépied, support ou autre objet instable et chancelant.
- Les trous et ouvertures du boîtier, situés à l'arrière de l'appareil ou sous celui-ci, servent à aérer l'appareil. Pour l'empêcher de surchauffer, ne bloquez sous aucun prétexte ces ouvertures et n'empêchez pas l'aération adéquate de l'appareil ni le placement de son fil. Ne touchez ni tenez ou ne placez sur un lit, divan, tapis ou toute autre surface similaire. De même, ne le positionnez pas à proximité ni au-dessus d'une source de chaleur ou d'un calorifère. De plus, ne placez pas l'appareil dans un endroit avant de vous assurer qu'il y ait une bonne circulation d'air.
- N'entourez jamais d'objets à travers les ouvertures de cet appareil, car ils pourraient entrer en contact avec des points de tension dangereux ou causer des courts-circuits qui pourraient déclencher un incendie ou un risque d'électrocution. Ne renversez jamais de liquide dans ces ouvertures.
- Afin de réduire les risques d'électrocution, ne démontez pas cet appareil, mais apportez-le dans un centre de service autorisé. L'ouverture du boîtier ou le retrait de toutes pièces qui contiennent cet appareil, à l'exception de l'accès autorisé à certaines portes ou ouvertures, risque de vous exposer à des points de tension dangereux ou d'autres dangers. Un remontage incorrect peut par la suite présenter des risques d'électrocution.
- Vous devriez tester la réception chaque fois que vous mettez l'appareil en fonction.
- Examinez les composants afin de vérifier si celles-ci ne sont pas endommagées.
- Il existe un très faible risque de perte de confidentialité avec certains appareils électroniques (autres écoute-bébé, téléphones sans fil, etc.). Pour l'éviter, s'assurer que le produit n'a jamais été utilisé avant l'achat, réinitialiser l'unité de façon périodique, éteindre l'écoute-bébé quand il n'est pas en cours d'utilisation.
- Les enfants devraient être supervisés afin de vous assurer qu'ils ne jouent pas avec l'appareil.
- Le produit n'est pas conçu pour être utilisé par des personnes (incluant des enfants) aux capacités physiques, sensorielles ou mentales réduites ou qui manquent d'expérience et de connaissances, à moins qu'on leur ait donné suffisamment de supervision ou d'instructions relativement à l'utilisation de l'appareil par une personne responsable de leur sécurité.

CONSERVEZ CES INSTRUCTIONS

- Utilisez et entreposez le produit à une température entre 0° C (32° F) et 40° C (104° F).
- N'exposez pas cet appareil à des froids ou des chaleurs extrêmes, ainsi qu'à la lumière directe du soleil. Ne l'installez pas près d'une source de chauffage.
- Le bloc-piles ne doit pas être exposé à la chaleur excessive telle que la lumière du soleil ou au feu.
- Avertissement - Risque de strangulation**
Les enfants se sont étranglés dans des appareils. Gardez le cordon hors de portée des enfants (à plus de 0,9 m). Ne l'enlevez pas cette étiquette.
- Ne jamais placer le moniteur à l'intérieur du berceau ou du parc de bébé. Ne jamais couvrir le moniteur ou l'unité (s) portative avec une couverture ou une couverture.
- D'autres équipements électroniques peuvent produire des interférences sur votre moniteur vidéo et audio. Tentez d'installer votre moniteur vidéo ou audio à l'écart des appareils électroniques tels que des radios sans fil, radios, téléphones cellulaires, interphones, moniteurs, téléphones, ordinateurs personnels, électromagnétiques et téléphones sans fil.

Stimulateurs cardiaques implantés dans l'organisme
Les stimulateurs cardiaques (ne s'applique qu'aux dispositifs numériques sans fil): L'organisme Wireless Technology Research, LLC (WTR), une firme de recherche indépendante, a mené une évaluation pluridisciplinaire des interférences entre les téléphones sans fil portatifs et les stimulateurs cardiaques implantés dans l'organisme. Appuyée par l'Administration des aliments et drogues (FDA) des États-Unis, la firme WTR recommande aux médecins:
Avs aux détenteurs de stimulateurs cardiaques

- Vous devriez maintenir les dispositifs sans fil à au moins six pouces du simulateur cardiaque.
- Il ne doit PAS placer le téléphone sans fil directement sur le simulateur cardiaque, tel que dans une poche de chemise, lorsque celui-ci est en marche.

L'étude effectuée par l'organisme WRS n'a pas identifié de risque pour les détenteurs de stimulateurs cardiaques causés par les gens qui utilisent des dispositifs sans fil à proximité de ceux-ci.

Champs électromagnétiques (EMF)
Ce produit de VTech est conforme à toutes les normes se rapportant aux champs électromagnétiques (EMF) standard. Si vous le manipulez correctement en suivant les instructions de ce manuel, son utilisation sera sécuritaire pendant de nombreuses années, selon les meilleures évidences scientifiques dont nous disposons aujourd'hui.

🔧 MOUNT THE BABY UNIT ON DRY WALL (OPTIONAL)

Not Included

You will need to purchase the following items separately to mount your baby unit:

- 2 screws
- 2 anchors

NOTE

- The types of screws and anchors you need depend on the composition of the wall.

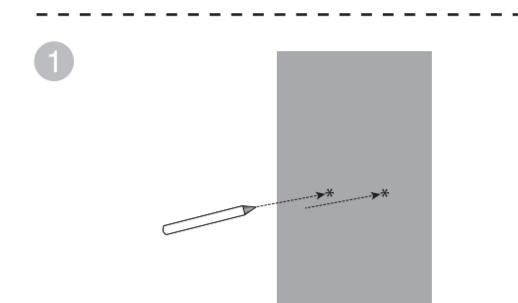

NOTE

- Check for reception strength and camera angle before drilling the holes.

Use a pencil to mark two holes in parallel. Make sure they are the same distance apart as the wall mount holes on the baby unit.

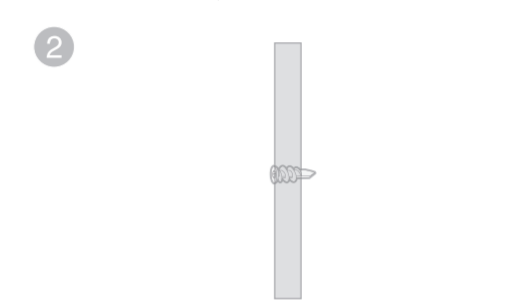

Drill two holes in the wall (7/32 inch drill bit). If you drill the holes into a stud, go to step 3.

-OR-

If you drill the holes into an object other than a stud, insert the wall anchors into the holes. Tap gently on the ends with a hammer until the wall anchors are flush with the wall.

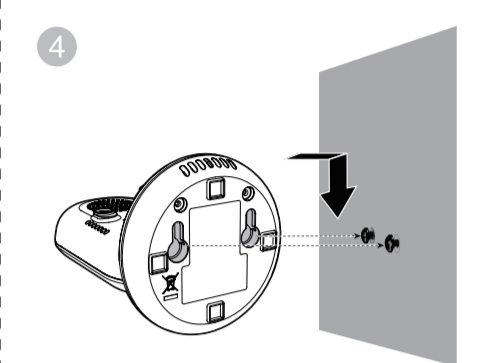
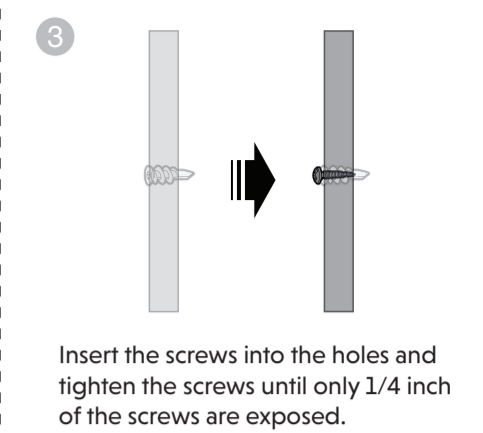

Align the wall mount holes on the baby unit with the screws on the wall. Slide the baby unit down until it locks into place.

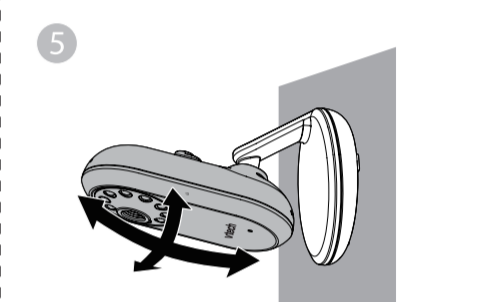

DISCLAIMER AND LIMITATION OF LIABILITY

VTech Communications, Inc. and its suppliers assume no responsibility for any damage or loss resulting from the use of this user's manual. VTech Communications, Inc. and its suppliers assume no responsibility for any loss or claims by third parties that may arise through the use of this product.
Company: VTech Communications, Inc.
Address: 9020 SW Washington Square Road - Ste 555 Tigard, OR 97223, United States
Phone: 1 (800) 595-9511 in the U.S. or 1 (800) 267-7377 in Canada

How do you get warranty service?

To obtain warranty service in the USA, please visit our website at www.vtechphones.com or call 1 (800) 595-9511. In Canada, go to www.vtechcanada.com or call 1 (800) 267-7377.

NOTE: Before calling for service, please review the user's manual - a check of the Product's controls and features may save you a service call.

Except as provided by applicable law, you assume the risk of loss or damage during transit and transportation and are responsible for delivery or handling charges incurred in the transport of the Product(s) to the service location. VTech will return replaced Product under this limited warranty. Transportation, delivery or handling charges are prepaid. VTech assumes no risk for damage or loss of the Product in transit.

What must you return with the Product to get warranty service?

- Return the entire original package and contents including the Product to the VTech service location along with a description of the malfunction or difficulty; and
- Include a "valid proof of purchase" (sales receipt) identifying the Product purchased (Product model) and the date of purchase or receipt; and
- Provide your name, complete and correct mailing address, and telephone number.

Other limitations

This warranty is the complete and exclusive agreement between you and VTech. It supersedes all other written or oral communications related to this Product. VTech provides no other warranties for this Product. The warranty exclusively describes all of VTech's responsibilities regarding the Product. There are no other express warranties. No one is authorized to make modifications to this limited warranty and you should not rely on any such modification. State/Provincial Law Rights: This warranty gives you specific legal rights, and you may also have other rights, which vary from state to state or province to province.

Limitations: Implied warranties, including those of fitness for a particular purpose and merchantability (an unwritten warranty that the Product is fit for ordinary use) are limited to one year from the date of purchase. Some states/provinces do not allow limitations on how long an implied warranty lasts, so the above limitation may not apply to you. In no event shall VTech be liable for any indirect, special, incidental, consequential, or similar damages (including, but not limited to lost profits or revenue, inability to use the Product or other associated equipment, the cost of substitute equipment, and claims by third parties) resulting from the use of this Product. Some states/provinces do not allow the exclusion or limitation of incidental or consequential damages, so the above limitation or exclusion may not apply to you.

Please retain your original sales receipt as proof of purchase.

Product returned without a valid proof of purchase (see item 2 below); or
Charges for installation or set up, adjustment of customer controls, and installation or repair of systems outside the unit.