

TEST THE SOUND LEVEL AND POSITION THE BABY MONITOR

Testing the sound level of the baby monitor

NOTE

- This baby monitor is intended as an aid. It is not a substitute for proper adult supervision, and should not be used as such.

CAUTION

- For hearing protection, make sure the parent unit is more than 10 feet away from the baby unit. If you hear any feedback noise from the parent unit, move the parent unit further until the noise stops. You can also press **VOL -** on the parent unit to lower or mute the noise.

TIP

- Increase the parent unit speaker volume if you cannot hear the sounds transmitted from the baby unit.

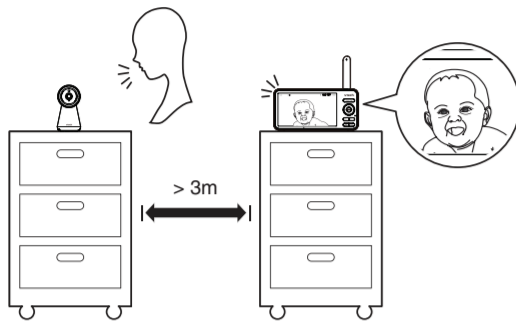

Positioning the baby monitor

CAUTION

- Keep the baby unit out of the reach of your baby. Never place or mount the baby unit inside the baby's crib or playpen.

- Place the baby unit more than 3 feet away from your baby.
- Adjust the angle of the baby unit to aim at your baby.

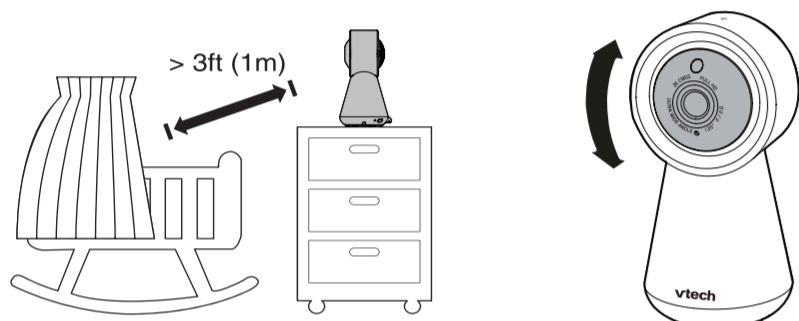

- To avoid causing feedback noise from your baby monitor:

- Make sure your baby unit and parent unit are more than 10 feet apart; OR
- Turn down the volume of your parent unit.

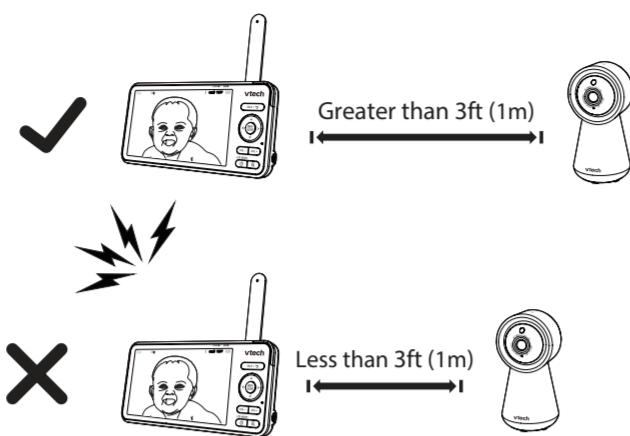

TEST THE LOCATION FOR THE BABY UNIT

If you plan to install your baby unit in a designated location, and use your home Wi-Fi network to connect your video monitor, you need to test which of your selected monitoring areas within the house have good Wi-Fi signal strength. After you have powered on your parent unit, you can use your parent unit's **Wi-Fi signal icon(s)** to assist in checking. Once you have identified the suitable location, you can install your baby unit. Adjust the distance between your baby unit and the Wi-Fi router if needed.

TIP

- Surroundings and obstructing factors, such as large metallic objects, filing cabinets, long distances, electrical appliances, and internal walls, may reduce Wi-Fi signal.

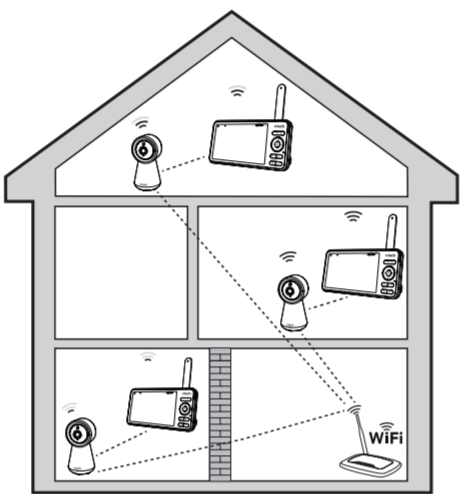

NIGHT VISION

The baby unit has infrared LEDs that allow you to see your baby clearly at night or in a dark room. When the baby unit detects low light levels, the infrared LEDs are switched on automatically. The images from the baby unit are in black and white, and appears on the parent unit screen.

NOTES

- A **click sound** from the baby unit is a normal occurrence that happens when your unit adapts to the environment lighting conditions.
- To achieve accurate and high quality video feeds, your baby unit is equipped with an Infrared cut-off filter lens that optimises colour accuracy in bright, day-time environments. When the environment turns dark at night, this filter lens is withdrawn to enhance night vision quality. The brief **click sound** you hear is from the filter lens activating/deactivating as the unit switches from day to night vision (and vice versa).

TIP

- Depending on the surroundings and other interfering factors, for example, lighting, objects, colours and backgrounds, the image quality may vary. Adjust the baby unit angle or place the baby unit at a higher location to prevent glare and a blurred display.

NEED HELP?

For instructions and guides to make the best use of your baby monitor, and for the latest information and support, check out our online help topics and FAQs. The online help page will also be updated periodically to reflect product system updates.

Use your smartphone or mobile device to access our online help.

- Go to <https://help.vtechphones.com/RM5856HD> or <https://help.vtechphones.com/RM5856-2HD>, OR

- Scan the QR code on the right. Launch the camera app or QR code scanner app on your smartphone or tablet. Hold the device's camera up to the QR code and frame it. Tap the notification to be redirected to the online help page.

- If the QR code is not clearly displayed, adjust your camera's focus by moving your device closer or further away until the image is clear.

If you would like to contact us, visit <https://help.vtechphones.com/cs>.

You can also call our Customer Support at 1-844-848-8324 (1-844-84-VTECH) [in US] or 1-888-211-2005 [in Canada] for help.



RM5856HD



RM5856-2HD

MOUNT THE BABY UNIT (OPTIONAL)

NOTES

- Check the reception strength and baby unit camera angle before drilling any holes:
- The types of screws and anchors you need depend on the composition of the wall. You may need to purchase the screws and anchors separately to mount your baby units.

- Place the wall mount bracket on a wall and then use a pencil to mark two holes in parallel. Remove the wall mount bracket and drill two holes in the wall (7/32 inch drill bit).

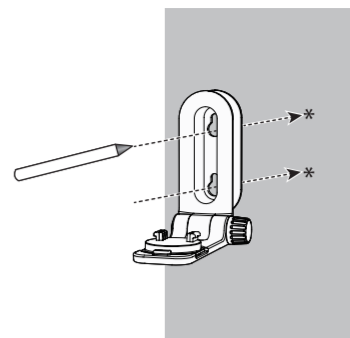

- If you drill the holes into a stud, go to step 3.
- If you drill the holes into an object other than a stud, insert the anchors into the holes. Tap gently on the ends with a hammer until the anchors are flush with the wall.

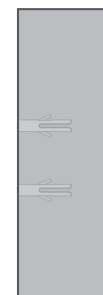

- Align the wall mount bracket and screws with the holes in the wall as shown. Tighten the screw in the middle hole first, so that the wall mount bracket position is fixed. You can tighten the other screw in the top hole.

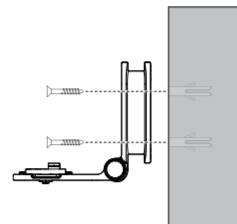

- Place the baby unit on the wall mount bracket, and then slide it forward until it locks into place. Connect the power adapter to the baby unit and a power supply.

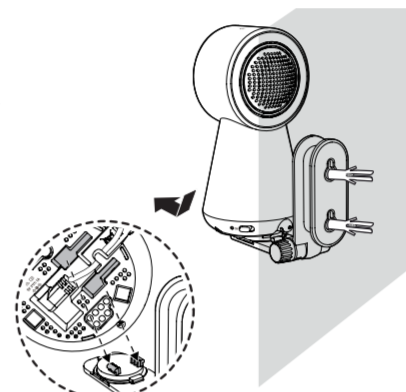

OR

- You can maximize your baby unit's viewing angles by tilting the wall mount bracket. Hold the baby unit, and then rotate the knob in an anticlockwise direction. This will loosen the joint of the wall mount bracket. Tilt your baby unit up or down to adjust to your preferred angle. Then, rotate the knob in a clockwise direction to tighten the joint and secure the angle.

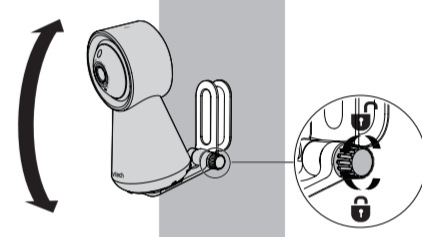

GENERAL PRODUCT CARE

To keep this product working well and looking good, follow these guidelines:

- Avoid placing it near heating appliances and devices that generate electrical noise (for example, motors or fluorescent lamps).
- DO NOT expose it to direct sunlight or moisture.
- Avoid dropping the product or treating it roughly.
- Clean with a soft damp cloth.
- DO NOT immerse the parent unit and the baby unit in water and do not clean them under running water.
- DO NOT use solvents, household cleaning sprays, or liquid cleaners.
- Make sure the parent unit and the baby unit are dry before reconnecting to the mains.

STORAGE

When you are not going to use the video monitor for some time, store the parent unit, the baby unit and the adapters in a cool, dry place.

FREQUENTLY ASKED QUESTIONS

Below are the questions most frequently asked about the video monitor.

Can I turn the parent unit display screen off but keep hearing sounds from the baby unit?	Yes, press LCD ON/OFF on the parent unit to turn off the screen. The parent unit display will also dim automatically after being inactive for some time. In both instances, you will still be able to hear all sounds from the baby unit. Press any key to turn the screen back on.
Why is the baby unit not responding normally?	Try the following (in the order listed) for a common cure: 1. Disconnect the power to the baby unit. 2. Wait a few minutes before connecting power back to the baby unit. 3. Reboot/Reset the parent unit.
Why is my screen in black and white?	The baby unit has a light sensor that measures ambient light. When the ambient light is dim, such as during night time or in a dark room, the baby unit activates its infrared LEDs, and displays the camera images in black and white night vision.
Why does my baby unit show offline? Why is the connection lost every now and then?	The baby unit may have lost connection to the Wi-Fi router. Check your network and router settings. Other electronic products may cause interference with your baby unit. Try installing your baby unit as far away from these electronic devices as possible.
Why can't I hear a sound/Why can't I hear my baby crying?	The parent unit speaker volume may be too low. Press VOL + on the parent unit to increase the volume.

THE RBRC SEAL



The RBRC seal on the lithium-ion battery indicates that VTech Communications, Inc. is voluntarily participating in an industry program to collect and recycle these batteries at the end of their useful lives, when taken out of service within the United States and Canada. The program provides a convenient alternative to placing used lithium-ion batteries into the trash or municipal waste, which may be illegal in your area.

VTech's participation makes it easy for you to drop off the spent product at local retailers participating in the program or at authorized VTech product service centers. Please call 1 (800) 8 BATTERY for information on Li-ion battery recycling and disposal bans/restrictions in your area. VTech's involvement in this program is part of its commitment to protecting our environment and conserving natural resources.

The **RBRC Seal and 1 (800) 8 BATTERY** are registered trademarks of Call2recycle, Inc.

FCC AND IC REGULATIONS

FCC Part 15

NOTE: This equipment has been tested and found to comply with the requirements for a Class B digital device under Part 15 of the Federal Communications Commission (FCC) rules. These requirements are intended to provide reasonable protection against harmful interference in a residential installation. This equipment generates, uses and can radiate radio frequency energy and, if not installed and used in accordance with the instructions, may cause harmful interference to radio communications. However, there is no guarantee that interference will not occur in a particular installation. If this equipment does cause harmful interference to radio or television reception, which can be determined by turning the equipment off and on, the user is encouraged to try to correct the interference by one or more of the following measures:

- Reorient or relocate the receiving antenna.
- Increase the separation between the equipment and receiver.
- Connect the equipment into an outlet on a circuit different from that to which the receiver is connected.
- Consult the dealer or an experienced radio/TV technician for help.

WARNING: Changes or modifications to this equipment not expressly approved by the party responsible for compliance could void the user's authority to operate the equipment.

This device complies with Part 15 of the FCC rules. Operation is subject to the following two conditions: (1) this device may not cause harmful interference, and (2) this device must accept any interference received, including interference that may cause undesired operation.

To ensure safety of users, the FCC has established criteria for the amount of radio frequency energy that can be safely absorbed by a user or bystander according to the intended usage of the product. This product has been tested and found to comply with the FCC criteria. The baby unit shall be installed and used such that parts of all persons' body are maintained at a distance of approximately 8 in (20 cm) or more. The transmitter and antenna of the parent unit shall be held at least 1 in (2.5 cm) from your face.

This Class B digital apparatus complies with Canadian requirement: CAN ICES-3 (B)/NMB-3(B)

Industry Canada

This device contains licence-exempt transmitter(s)/receiver(s) that comply with Innovation, Science and Economic Development Canada's licence-exempt RSS(s). Operation is subject to the following two conditions: (1) This device may not cause interference. (2) This device must accept any interference, including interference that may cause undesired operation of the device. The term "IC" before the certification/registration number only signifies that the Industry Canada technical specifications were met. This product meets the applicable Innovation, Science and Economic Development Canada technical specifications.

RF radiation exposure statement

The product complies with FCC RF radiation exposure limits set forth for an uncontrolled environment. The baby unit should be installed and operated with a minimum distance of 8 in (20 cm) between the baby unit and all persons' body. Use of other accessories may not ensure compliance with FCC RF exposure guidelines. This equipment complies also with Industry Canada RSS-102 with respect to Canada's Health Code 6 for Exposure of Humans to RF Fields.

CALIFORNIA ENERGY COMMISSION BATTERY CHARGING TESTING MODE

This video monitor meets the California Energy Commission (CEC) regulations for energy consumption. Your video monitor is set up to comply with the energy-conserving standards right out of the box. Follow the instructions to install and charge the battery. The CEC battery charging testing mode is activated while it is powered off and charging. Even if the parent unit is paired to camera units, the CEC battery charging testing mode is activated while it is powered off and charging.

FOR CETL COMPLIANCE ONLY

La plaque signalétique appliquée est située au bas du socle de l'unité du bébé. Lorsque vous utilisez votre appareil, vous devez toujours suivre certaines mesures de précaution de base afin de réduire les risques d'incendie, d'électrocution et de blessures corporelles, dont ceux qui suivent:

- Observez toutes les instructions et mises en garde inscrites sur l'appareil.
- L'installation par un adulte est requise.
- MISE EN GARDE:** N'installez pas l'unité du bébé à une hauteur supérieure à 2 mètres.
- Ce produit a été conçu pour être un dispositif d'appoint seulement. Il n'est pas le remplacement d'une supervision responsable et adéquate par un adulte et ne devrait pas être utilisé comme tel.
- Ce produit n'est pas conçu pour être utilisé en tant que monitor médical.
- N'utilisez pas cet appareil près de l'eau ni de toute autre source d'humidité, par exemple, près d'une baignoire, cuve à lessive, évier de cuisine, dans un sous-sol humide ni près d'une piscine, dans un sous-sol humide ou une douche.
- MISE EN GARDE:** N'utilisez que la pile fournie. Il peut y avoir un risque d'explosion si un mauvais type de pile est utilisé pour le dispositif appaant. La pile ne peut pas être soumise à des températures extrêmes élevées ou basses et à une faible pression atmosphérique à long terme. Évitez tout usage non autorisé, son entreposage ou son transport. Le fait de jeter la pile dans un feu ou dans un four chaud, ou d'écraser ou de couper mécaniquement la pile peut entraîner une explosion. Le fait de laisser la pile dans un environnement à température extrêmement élevée peut entraîner une explosion ou une fuite de liquide ou de gaz inflammable. Une pile soumise à une pression d'air extrêmement basse peut provoquer une explosion ou une fuite de liquide ou de gaz inflammable. Mettez au rebut la pile soigneusement conformément aux informations figurant dans la section **Le bébé RBRC**.
- N'utilisez que les adaptateurs inclus avec ce produit. L'utilisation d'un adaptateur dont la polarité ou la tension serait inadéquate risque d'endommager sérieusement le produit et mettre votre sécurité en péril.

- CONSERVEZ CES INSTRUCTIONS**
- Utilisez et entreposez le produit à une température entre 0 ° C (32 ° F) et 40 ° C (104 ° F).
 - Risque de brûlure, risque d'incendie, risque d'explosion associé à une mauvaise manipulation de la batterie.
 - N'exposez pas cet appareil à des froids ou des chaleurs extrêmes, ainsi qu'à la lumière directe du soleil. Ne l'installez pas près d'une source de chauffage.

- ⚠️ Avertissement - Risque de strangulation - Les enfants se sont étranouqués dans des cordons. Gardez ce cordon hors de portée des enfants à (plus de 0,9 m). N'enlevez pas cette étiquette.**
- Ne jamais placer le moniteur à l'intérieur du berceau ou du parc de bébé. Ne jamais couvrir le moniteur ou l'unité (s) portative avec un article tel une serviette ou une couverture.
- D'autres produits électroniques peuvent causer des interférences, ainsi qu'un mauvais câblage. Essayez d'installer votre caméra IP le plus loin possible de ces dispositifs électroniques : routeurs sans fil, radios, téléphones cellulaires, interphones, moniteurs de pièces, téléviseurs, ordinateurs personnels, appareils électroniques de cuisine et téléphones sans fil.

- Stimulateurs cardiaques implantés dans l'organisme**
Les stimulateurs cardiaques (ne s'applique qu'aux dispositifs numériques sans fil).
L'organisme "Wireless Technology Research, LLC (WTR)", une firme de recherche indépendante, a mené une évaluation pluridisciplinaire des interférences entre les téléphones sans fil portatifs et les stimulateurs cardiaques implantés dans l'organisme. Appuyée par l'Administration des aliments et drogues (FDA) des États-Unis, la firme WTR recommande aux médecins:
AVIS aux détenteurs de stimulateurs cardiaques
• Vous devriez maintenir les dispositifs sans fil à au moins six pouces du stimulateur cardiaque.
• Ils ne doivent PAS placer les téléphones sans fil directement sur le stimulateur cardiaque, ni que dans une poche de chemise, lorsque celui-ci est en marche.
• Les études effectuées par l'organisme WTR n'a pas identifié de risque pour les détenteurs de stimulateurs cardiaques causés par les gens qui utilisent des dispositifs sans fil à proximité de ceux-ci.
- Champs électromagnétiques (EMF)**
Ce produit de VTech est conforme à toutes les normes se rapportant aux champs électromagnétiques (EMF) standard. Si vous le manipulez correctement en suivant les instructions de ce guide, son utilisation sera sécuritaire pendant de nombreuses années, selon les meilleures évidences scientifiques dont nous disposons aujourd'hui.