

## TEST REPORT

### SPECIFIC ABSORPTION RATE (SAR) EVALUATION REPORT

For Video Monitor - Parent Unit

Model Number: RM5766HD PU, RM5766-abHD PU

Brand Name: Vtech

FCC ID: EW780-2529-01

Prepared for  
VTech Telecommunications Ltd.  
23/F., Tai Ping Industrial Centre, Block 1,  
57 Ting Kok Road, Tai Po,  
Hong Kong.

**PREPARED AND CHECKED BY:**

**APPROVED BY:**



Kevin Liang  
Assistant Manager  
Shenzhen UnionTrust Quality and  
Technology Co., Ltd.

Siu Yiu Nam, Edwin  
Senior Lead Engineer  
Intertek Testing Services Hong Kong  
Date: October 11, 2021

Intertek's standard Terms and Conditions can be obtained at our website <http://www.intertek.com/terms/>.

The test report only allows to be revised within the retention period unless further standard or the requirement was noticed.

This report is for the exclusive use of Intertek's Client and is provided pursuant to the agreement between Intertek and its Client. Intertek's responsibility and liability are limited to the terms and conditions of the agreement. Intertek assumes no liability to any party, other than to the Client in accordance with the agreement, for any loss, expense or damage occasioned by the use of this report. Only the Client is authorized to permit copying or distribution of this report and then only in its entirety. Any use of the Intertek name or one of its marks for the sale or advertisement of the tested material, product or service must first be approved in writing by Intertek. The observations and test results in this report are relevant only to the sample tested. This report by itself does not imply that the material, product, or service is or has ever been under an Intertek certification program.

© 2017 Intertek

**TEST REPORT**

**TABLE OF CONTENTS**

1 Test Result Summary..... 3

2 General Information..... 4

3 SAR Measurement System Description ..... 8

4 Tissue Verificaiton ..... 15

5 SAR Measurement System Verification ..... 18

6 SAR EVALUATION ..... 20

7 Test Equipment List..... 34

8 Measurement Uncertainty..... 35

9 E-Field Probe and Dipole Antenna Calibration ..... 37

APPENDIX A – System Check Data ..... 38

APPENDIX B – SAR Evaluation Data ..... 39

APPENDIX C – E-Field Probe and Dipole Antenna Calibration ..... 41

APPENDIX D – SAR System Validation..... 42

**TEST REPORT**

**1. TEST RESULT SUMMARY**

<b>Applicant:</b>	VTech Telecommunications Ltd.
<b>Applicant Address:</b>	23/F., Tai Ping Industrial Centre, Block 1, 57 Ting Kok Road, Tai Po, Hong Kong.
<b>Model:</b>	RM5766HD PU, RM5766-abHD PU
<b>Brand Name:</b>	Vtech
<b>Serial Number:</b>	N/A
<b>FCC ID:</b>	EW780-2529-01
<b>Test Device:</b>	Production Unit
<b>EUT Exercising Software</b>	Tera Terms Version 4.57
<b>Exposure Category:</b>	General Population/Uncontrolled Exposure
<b>Date of Test:</b>	September 19, 2021
<b>Test Engineer</b>	Harry Chen
<b>Place of Testing:</b>	Shenzhen UnionTrust Quality and Technology Co., Ltd. Unit D/E of 9/F and 16/F, Block A, Building 6, Baoneng science and technology park, Longhua district, Shenzhen, China
<b>Environmental Conditions:</b>	Temperature: +18 to 25°C Humidity 25 to 75%
<b>Test Specification:</b>	ANSI/IEEE C95.1 IEEE Std 1528:2013 FCC KDB Publication 447498 D01 v06 FCC KDB Publication 865664 D01 v01r04 FCC KDB Publication 865664 D02 v01r02 FCC KDB Publication 248227 D01 V02r02

The maximum spatial peak SAR value for the sample device averaged over 1g was found to be:

Band	Operating Mode	TX Frequency (MHz)	Highest Reported SAR	
			In-front-of mouth	Body
2.4GHz WiFi	Data	2412 – 2462	0.2306 W/kg	1.3140 W/kg

This wireless portable device has been shown to be capable of compliance for localized specific absorption rate (SAR) for uncontrolled environment / general population exposure limits specified in ANSI/IEEE C95.1.

## TEST REPORT

### 2. GENERAL INFORMATION

#### 2.1. Description of Equipment under test (EUT)

<b>Manufacturer:</b>	VTech (Dongguan) Telecommunications Limited.
<b>Manufacturer Address:</b>	VTech Science Park, Xia Ling Bei Management Zone, Liaobu, Dongguan, Guangdong, China.
<b>Device dimension (L x W) :</b>	159 (mm) x 77 (mm)
<b>Device thickness:</b>	24 (mm)
<b>Antenna Gain:</b>	2 dBi
<b>Operating Configuration(s) / mode:</b>	In-front-of mouth (Data) Body (Data)
<b>Tx Frequency (MHz):</b>	2412-2462
<b>Duty Cycle*:</b>	100%
<b>H/W Version:</b>	N/A
<b>S/W Version:</b>	N/A
<b>Battery Type:</b>	3.7VDC (1 x 3.7V 5000mAh 18.5Wh Li-Polymer rechargeable battery)
<b>Body-worn Accessories:</b>	N/A

**\*Note:**

1. Worst case was selected to present by client request. SAR test was tested and present in test mode with 100% to represent the worst case.

**TEST REPORT**

**2.2. EUT Antenna Locations**

**Antenna closed configuration**

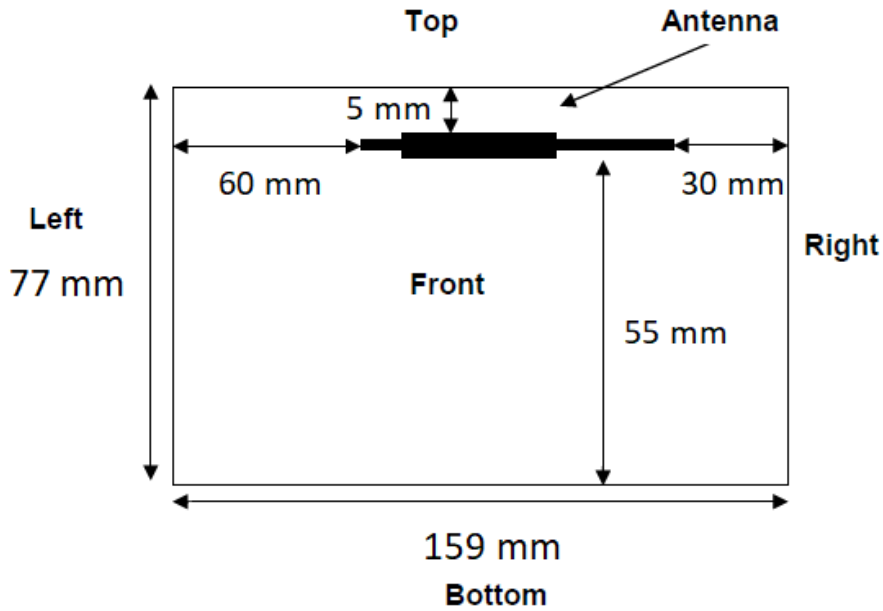

Exposure Position	Separation Distance from the Antenna to the Outer Surface (Antenna Closed)
Front	12
Top	5
Left	60
Right	30
Back	4
Bottom	55

**TEST REPORT**

**2.2 EUT Antenna Locations (Cont'd)**

**Antenna extended configuration**

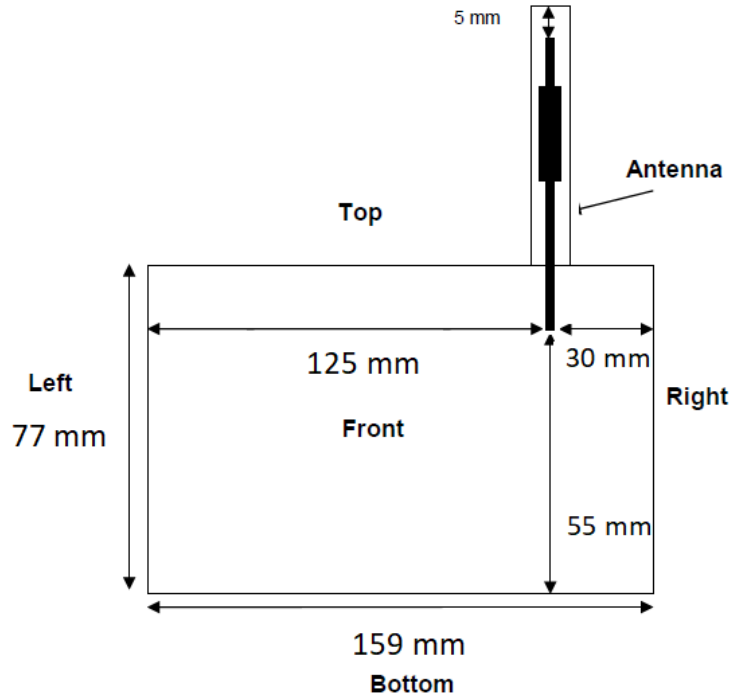

Exposure Position	Separation Distance from the Antenna to the Outer Surface (Antenna Extended)
Front	12
Top	5
Left	125
Right	30
Back	4
Bottom	55

Details of antenna specification are shown in separate antenna dimension document.

**TEST REPORT**

**2.3. Nominal and Maximum Output Power Specifications**

The EUT operates using the following maximum and nominal output power specifications. SAR values were scaled to the maximum allowed power to determine compliance per KDB Publication 447498.

Band	Operating Mode	TX Frequency (MHz)	Output Power	
			Nominal (dBm)	Maximum (dBm)
2.4GHz	802.11b	2412 – 2462	16	18
2.4GHz	802.11g	2412 – 2462	19	21
2.4GHz	802.11n (HT20)	2412 - 2462	19	21

## TEST REPORT

### 3. SAR MEASUREMENT SYSTEM DESCRIPTION

SAR is related to the rate at which energy is absorbed per unit mass in object exposed to a radio field. The SAR distribution in a biological body is complicated and is usually carried out by experimental techniques or numerical modeling. The standard recommends limits for two tiers of groups, occupational/controlled and general population/uncontrolled, based on a person's awareness and ability to exercise control over his or her exposure. In general, occupational/controlled exposure limits are higher than the limits for general population/uncontrolled.

The SAR definition is the time derivative (rate) of the incremental energy (dW) absorbed by (dissipated in) an incremental mass (dm) contained in a volume element (dv) of given mass density ( $\rho$ ). The equation description is as below:

$$SAR = \frac{d}{dt} \left( \frac{dW}{dm} \right) = \frac{d}{dt} \left( \frac{dW}{\rho dV} \right)$$

SAR is expressed in units of Watts per kilogram (W/Kg)

SAR can be obtained using either of the following equations:

$$SAR = \frac{\sigma E^2}{\rho}$$

$$SAR = c_h \left. \frac{dT}{dt} \right|_{t=0}$$

Where

- SAR is the specific absorption rate in watts per kilogram;
- E is the r.m.s. value of the electric field strength in the tissue in volts per meter;
- $\sigma$  is the conductivity of the tissue in siemens per metre;
- $\rho$  is the density of the tissue in kilograms per cubic metre;
- $c_h$  is the heat capacity of the tissue in joules per kilogram and Kelvin;

$\left. \frac{dT}{dt} \right|_{t=0}$  is the initial time derivative of temperature in the tissue in kelvins per second



**TEST REPORT**

DASY system consists of high precision robot, probe alignment sensor, phantom, robot controller, controlled measurement server and near-field probe. The robot includes six axes that can move to the precision position of the DASY5 software defined. The DASY software can define the area that is detected by the probe. The robot is connected to controlled box. Controlled measurement server is connected to the controlled robot box. The DAE includes amplifier, signal multiplexing, AD converter, offset measurement and surface detection. It is connected to the Electro-optical coupler (ECO). The ECO performs the conversion form the optical into digital electric signal of the DAE and transfers data to the PC.

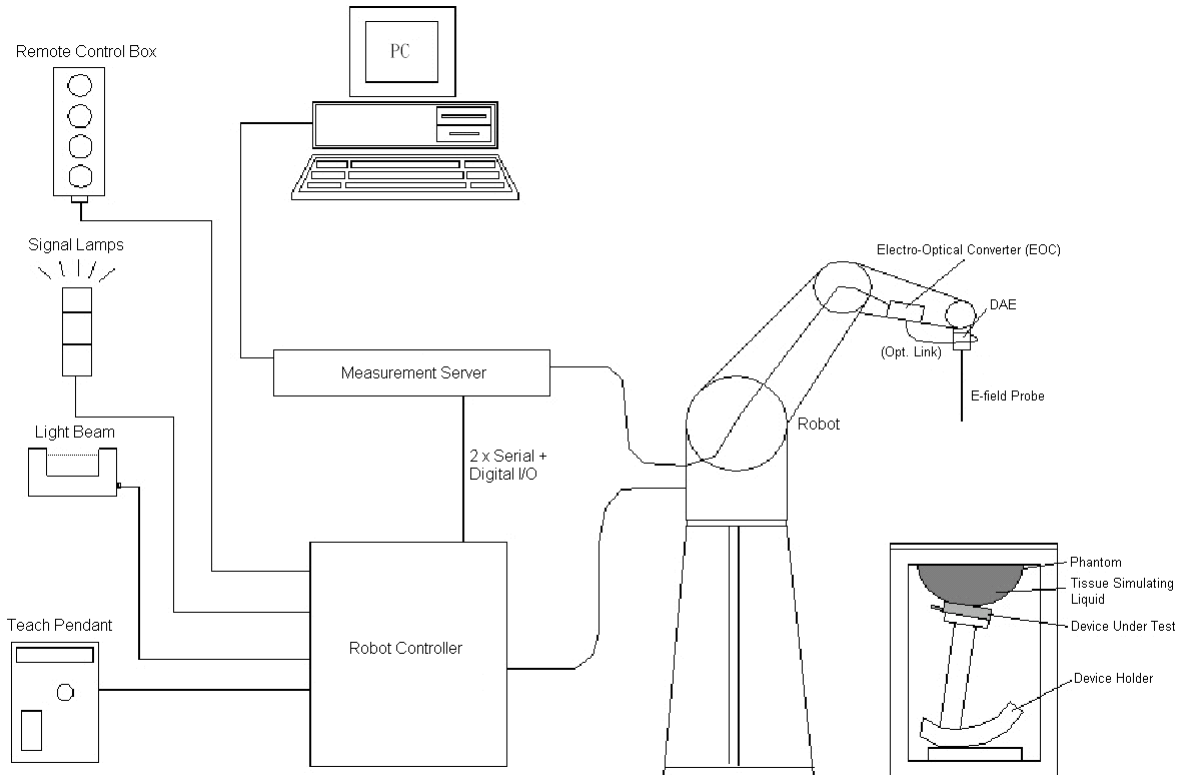

*Figure 1: Schematic diagram of the SAR measurement system*

## TEST REPORT

### ROBOT

The DASY system uses the high precision robots from Stäubli SA (France). For the 6-axis controller system, the robot controller version from Stäubli is used. The Stäubli robot series have many features that are important for our application:

- High precision (repeatability  $\pm 0.02$  mm)
- High reliability (industrial design)
- Jerk-free straight movements
- Low ELF interference (the closed metallic construction shields against motor control fields)

## TEST REPORT

### E-FIELD PROBE

The SAR measurement is conducted with the dosimetric probe. The probe is specially designed and calibrated for use in liquid with high permittivity. The dosimetric probe has special calibration in liquid at different frequency.

<b>Model</b>	EX3DV4
<b>Construction</b>	Symmetrical design with triangular core. Built-in shielding against static charges. PEEK enclosure material (resistant to organic solvents, e.g., DGBE).
<b>Frequency</b>	10 MHz to 6 GHz Linearity: $\pm 0.2$ dB
<b>Directivity</b>	$\pm 0.3$ dB in HSL (rotation around probe axis) $\pm 0.5$ dB in tissue material (rotation normal to probe axis)
<b>Dynamic Range</b>	10 $\mu$ W/g to 100 mW/g Linearity: $\pm 0.2$ dB (noise: typically $< 1$ $\mu$ W/g)
<b>Dimensions</b>	Overall length: 337 mm (Tip: 20 mm) Tip diameter: 2.5 mm (Body: 12 mm) Typical distance from probe tip to dipole centers: 1 mm



<b>Model</b>	ES3DV3
<b>Construction</b>	Symmetrical design with triangular core. Interleaved sensors. Built-in shielding against static charges. PEEK enclosure material (resistant to organic solvents, e.g., DGBE).
<b>Frequency</b>	10 MHz to 4 GHz Linearity: $\pm 0.2$ dB
<b>Directivity</b>	$\pm 0.2$ dB in HSL (rotation around probe axis) $\pm 0.3$ dB in tissue material (rotation normal to probe axis)
<b>Dynamic Range</b>	5 $\mu$ W/g to 100 mW/g Linearity: $\pm 0.2$ dB
<b>Dimensions</b>	Overall length: 337 mm (Tip: 20 mm) Tip diameter: 3.9 mm (Body: 12 mm) Distance from probe tip to dipole centers: 2.0 mm



### Data Acquisition Electronics (DAE)

<b>Model</b>	DAE3, DAE4
<b>Construction</b>	Signal amplifier, multiplexer, A/D converter and control logic. Serial optical link for communication with DASY embedded system (fully remote controlled). Two step probe touch detector for mechanical surface detection and emergency robot stop.
<b>Measurement Range</b>	-100 to +300 mV (16 bit resolution and two range settings: 4mV, 400mV)
<b>Input Offset Voltage</b>	$< 5$ $\mu$ V (with auto zero)
<b>Input Bias Current</b>	$< 50$ fA
<b>Dimensions</b>	60 x 60 x 68 mm



**TEST REPORT**

**SAM TWIN PHANTOM**

<b>Model</b>	Twin SAM
<b>Construction</b>	The shell corresponds to the specifications of the Specific Anthropomorphic Mannequin (SAM) phantom defined in IEEE 1528 and IEC 62209-1. It enables the dosimetric evaluation of left and right hand phone usage as well as body mounted usage at the flat phantom region. A cover prevents evaporation of the liquid. Reference markings on the phantom allow the complete setup of all predefined phantom positions and measurement grids by teaching three points with the robot.
<b>Material</b>	Vinylester, glass fiber reinforced (VE-GF)
<b>Shell Thickness</b>	2 ± 0.2 mm (6 ± 0.2 mm at ear point)
<b>Dimensions</b>	Length: 1000 mm Width: 500 mm Height: adjustable feet
<b>Filling Volume</b>	approx. 25 liters



<b>Model</b>	ELI
<b>Construction</b>	Phantom for compliance testing of handheld and body-mounted wireless devices in the frequency range of 30 MHz to 6 GHz. ELI is fully compatible with the IEC 62209-2 standard and all known tissue simulating liquids. ELI has been optimized regarding its performance and can be integrated into our standard phantom tables. A cover prevents evaporation of the liquid. Reference markings on the phantom allow installation of the complete setup, including all predefined phantom positions and measurement grids, by teaching three points. The phantom is compatible with all SPEAG dosimetric probes and dipoles.
<b>Material</b>	Vinylester, glass fiber reinforced (VE-GF)
<b>Shell Thickness</b>	2.0 ± 0.2 mm (bottom plate)
<b>Dimensions</b>	Major axis: 600 mm Minor axis: 400 mm
<b>Filling Volume</b>	approx. 30 liters



**TEST REPORT**

**DEVICE HOLDER**

<b>Model</b>	Mounting Device In combination with the Twin SAM Phantom or ELI4, the Mounting Device enables the rotation of the mounted transmitter device in spherical coordinates. Rotation point is the ear opening point.
<b>Construction</b>	Transmitter devices can be easily and accurately positioned according to IEC, IEEE, FCC or other specifications. The device holder can be locked for positioning at different phantom sections (left head, right head, flat).
<b>Material</b>	POM



<b>Model</b>	Laptop Extensions Kit Simple but effective and easy-to-use extension for Mounting Device that facilitates the testing of larger devices according to IEC 62209-2 (e.g., laptops, cameras, etc.). It is lightweight and fits easily on the upper part of the Mounting Device in place of the phone positioner.
<b>Construction</b>	
<b>Material</b>	POM, Acrylic glass, Foam

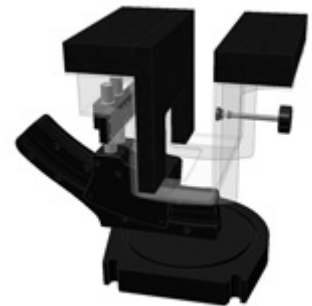

**System Validation Dipoles**

<b>Model</b>	D-Serial Symmetrical dipole with 1/4 balun. Enables measurement of feed point impedance with NWA.
<b>Construction</b>	Matched for use near flat phantoms filled with tissue simulating solutions.
<b>Frequency</b>	750 MHz to 5800 MHz
<b>Return Loss</b>	> 20 dB
<b>Power Capability</b>	> 100 W (f < 1GHz), > 40 W (f > 1GHz)



## TEST REPORT

During measurement, the system first does an area (2D) scan at a fixed depth within the liquid from the inside wall of the phantom scanning area is greater than the projection of EUT and antenna.

Area Scan Parameters extracted from KDB 865664

	≤ 3 GHz	> 3 GHz
Maximum distance from closest measurement point (geometric center of probe sensors) to phantom surface	5 mm ± 1 mm	$\frac{1}{2} \cdot \delta \cdot \ln(2)$ mm ± 0.5 mm
Maximum probe angle from probe axis to phantom surface normal at the measurement location	30° ± 1°	20° ± 1°
Maximum area scan spatial resolution: $\Delta x_{Area}$ , $\Delta y_{Area}$	≤ 2 GHz: ≤ 15 mm 2 – 3 GHz: ≤ 12 mm	3 – 4 GHz: ≤ 12 mm 4 – 6 GHz: ≤ 10 mm
	When the x or y dimension of the test device, in the measurement plane orientation, is smaller than the above, the measurement resolution must be ≤ the corresponding x or y dimension of the test device with at least one measurement point on the test device.	

When the maximum SAR point has been found, the system will then carry out a zoom (3D) scan centred at that point to determine volume averaged SAR level.

Zoom Scan Parameters extracted from KDB 865664

Maximum zoom scan spatial resolution: $\Delta x_{Zoom}$ , $\Delta y_{Zoom}$		≤ 2 GHz: ≤ 8 mm 2 – 3 GHz: ≤ 5 mm*	3 – 4 GHz: ≤ 5 mm* 4 – 6 GHz: ≤ 4 mm*	
Maximum zoom scan spatial resolution, normal to phantom surface	uniform grid: $\Delta z_{Zoom}(n)$	≤ 5 mm	3 – 4 GHz: ≤ 4 mm 4 – 5 GHz: ≤ 3 mm 5 – 6 GHz: ≤ 2 mm	
	graded grid	$\Delta z_{Zoom}(1)$ : between 1 <sup>st</sup> two points closest to phantom surface	≤ 4 mm	3 – 4 GHz: ≤ 3 mm 4 – 5 GHz: ≤ 2.5 mm 5 – 6 GHz: ≤ 2 mm
		$\Delta z_{Zoom}(n>1)$ : between subsequent points	≤ 1.5 · $\Delta z_{Zoom}(n-1)$ mm	
Minimum zoom scan volume	x, y, z	≥ 30 mm	3 – 4 GHz: ≥ 28 mm 4 – 5 GHz: ≥ 25 mm 5 – 6 GHz: ≥ 22 mm	
Note: $\delta$ is the penetration depth of a plane-wave at normal incidence to the tissue medium; see IEEE Std 1528-2013 for details. * When zoom scan is required and the <i>reported</i> SAR from the <i>area scan based 1-g SAR estimation</i> procedures of KDB Publication 447498 is ≤ 1.4 W/kg, ≤ 8 mm, ≤ 7 mm and ≤ 5 mm zoom scan resolution may be applied, respectively, for 2 GHz to 3 GHz, 3 GHz to 4 GHz and 4 GHz to 6 GHz.				

**TEST REPORT**

**4. TISSUE VERIFICATION**

For SAR measurement of field distribution inside phantom, homogeneous tissue simulating liquid as below liquid recipes were filled to a depth of 15cm ± 0.5cm for below 3GHz measurement and of 10cm ± 0.5cm for above 3GHz measurement.

**HEAD TISSUE RECIPES**

Frequency	De-ionized Water	Ingredients				
		Salt	1,2 propanediol	DGBE	DGMH	Triton X100
450 MHz	33.5%	3.4%	63.1%			
750 MHz	34.2%	1.4%	64.4%			
900 MHz	35.3%	1.0%	63.7%			
1800 MHz	55.2%	0.6%		13.8%		30.4%
1900 MHz	55.3%	0.5%		13.8%		30.4%
2000 MHz	55.3%	0.4%		13.8%		30.5%
2450 MHz	55.7%	0.3%		18.7%		25.3%
5000 MHz	65.3%				17.2%	17.5%

**BODY TISSUE RECIPES**

Frequency	De-ionized Water	Ingredients				
		Salt	1,2 propanediol	DGBE	DGMH	Triton X100
450 MHz	52.4%	1.9%	45.7%			
750 MHz	55.4%	1.3%	43.3%			
900 MHz	52.9%	1.0%	46.1%			
1800 MHz	70.8%	0.5%		8.7%		20.0%
1900 MHz	70.1%	0.4%		8.9%		20.6%
2000 MHz	70.2%	0.3%		8.6%		20.9%
2450 MHz	70.8%	0.3%		8.7%		20.2%
5000 MHz	77.8%				11.7%	11.5%

**TEST REPORT**

The head tissue dielectric parameters recommended by the IEEE Std 1528 have been incorporated in the following table. These head parameters are derived from planar layer models simulating the highest expected SAR for the dielectric properties and tissue thickness variations in a human head. For other head and body tissue parameters, they are recommended by KDB 865664.

Target Frequency (MHz)	head		body	
	$\epsilon_r$	$\sigma$ (S/m)	$\epsilon_r$	$\sigma$ (S/m)
300	45.3	0.87	58.2	0.92
450	43.5	0.87	56.7	0.94
835	41.5	0.90	55.2	0.97
900	41.5	0.97	55.0	1.05
915	41.5	1.01	55.0	1.06
1450	40.5	1.20	54.0	1.30
1610	40.3	1.29	53.8	1.40
1800 – 2000	40.0	1.40	53.3	1.52
2450	39.2	1.80	52.7	1.95
3000	38.5	2.40	52.0	2.73
5800	35.3	5.27	48.2	6.00

( $\epsilon_r$  = relative permittivity,  $\sigma$  = conductivity and  $\rho = 1000$  kg/m<sup>3</sup>)

When a transmission band overlaps with one of the target frequencies, the tissue dielectric parameters of the tissue medium at the middle of a device transmission band should be within  $\pm 5\%$  of the parameters specified at that target frequency.



**TEST REPORT**

The dielectric parameters of the liquids were verified prior to the SAR evaluation.

The dielectric parameters were:

Head Liquid

Freq. (MHz)	Temp. (°C)	ε <sub>r</sub> / Relative Permittivity			σ / Conductivity			ρ <sub>v</sub> <sup>**</sup> (kg/m <sup>3</sup> )
		measured	Target*	Δ (±5%)	measured	Target*	Δ (±5%)	
2450	21.2	38.89	39.20	-0.79	1.86	1.80	3.33	1000

\* Target values refer to KDB 865664

\*\* Worst-case assumption

Note:

1. Date of tissue verification measurement: September 19, 2021
2. Ambient temperature: 21.3 deg C
3. The temperature condition is within +/- 2 deg. C during the SAR measurements.

**TEST REPORT**

**5. SAR MEASUREMENT SYSTEM VERIFICATION**

Each DASY system is equipped with one or more system check kits. These units, together with the predefined measurement procedures within the DASY software, enable user to conduct the system check. System kit includes a dipole, and dipole device holder.

The system check verifies that the system operates within its specifications. It's performed daily or before every SAR measurement. The system check uses normal SAR measurement in the flat section of the phantom with a matched dipole at a specified distance. The system check setup is shown as below.

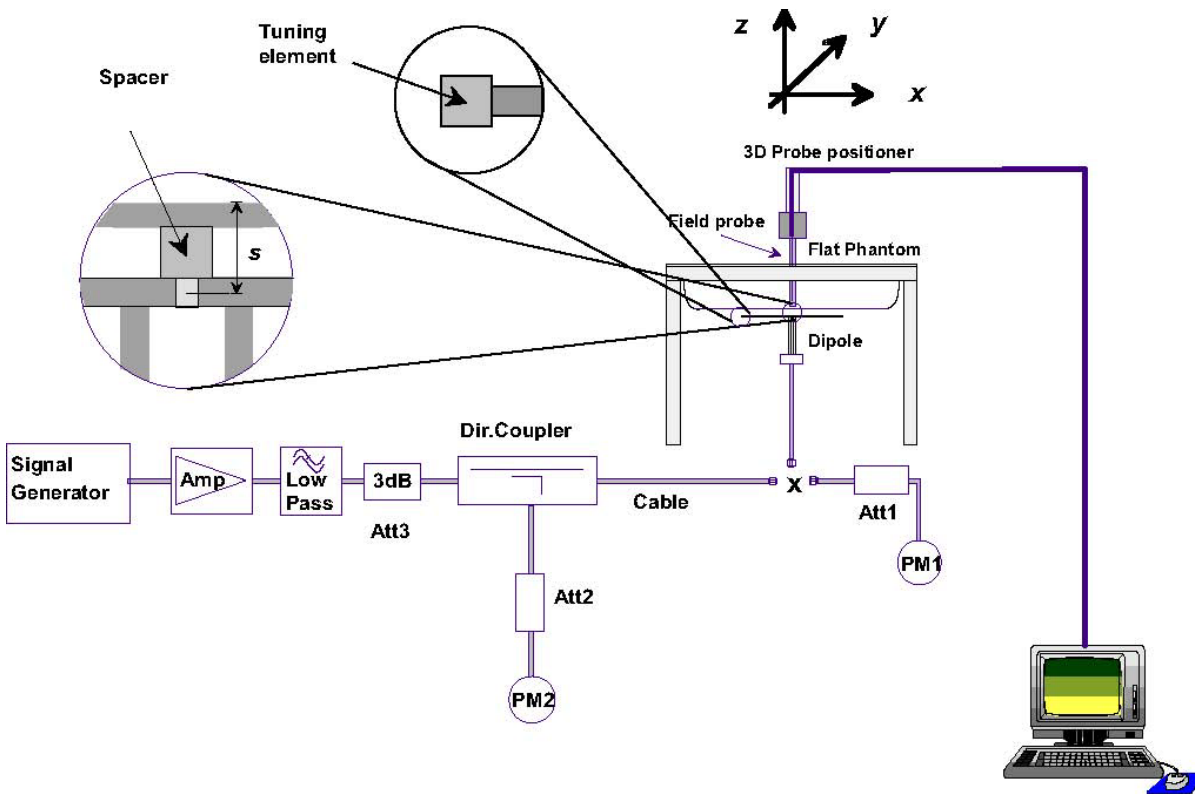

**TEST REPORT**

**VALIDATION DIPOLE**



The dipoles used is based on the IEEE Std 1528, and is complied with mechanical and electrical specifications in line with the requirements of both FCC and KDB requirement. The table below provides details for the mechanical and electrical specifications for the dipoles.

**SYSTEM CHECK RESULTS**

Date	Freq. (MHz)	Liquid Type	System Diople	System Verification				
				Serial No.	Target SAR <sub>1g</sub> (W/kg)	Measured SAR <sub>1g</sub> (W/kg)	Normalized SAR <sub>1g</sub> (W/kg)	Deviation (±10%)
Sep. 19, 2021	2450	Head	D2450V2	1014	51.8	0.514	51.40	-0.78

- \* the target was quoted from dipole calibration report
- \* Input power level = 10dBm (10mW)

SAR<sub>1g</sub> ambient measured value < 12 mW/kg

Details of System Verification plots are shown in the Appendix A - plot 1.

## TEST REPORT

### 6. SAR EVALUATION

#### 6.1. Device test positions relative to the head

This practice specifies two handset test positions against the head phantom—the “cheek” position and the “tilt” position. These two test positions are defined in the following subclauses. The handset should be tested in both positions on left and right sides of the SAM phantom. If handset construction is such that the handset positioning procedures described below to represent normal use conditions cannot be used, e.g., some asymmetric handsets, alternative alignment procedures should be adapted with all details provided in the test report. These alternative procedures should replicate intended use conditions as closely as possible according to the intent of the procedures described in this subclause.

## TEST REPORT

### DEFINITION OF THE CHEEK POSITION

The cheek position is established as follows:

1. Ready the handset for talk operation, if necessary. For example, for handsets with a cover piece (flip cover), open the cover. If the handset can transmit with the cover closed, both configurations must be tested.
2. Define two imaginary lines on the handset—the vertical centerline and the horizontal line. The vertical centerline passes through two points on the front side of the handset—the midpoint of the width  $w_t$  of the handset at the level of the acoustic output (point A in below figure), and the midpoint of the width  $w_b$  of the bottom of the handset (point B). The horizontal line is perpendicular to the vertical centerline and passes through the center of the acoustic output (see below left figure). The two lines intersect at point A. Note that for many handsets, point A coincides with the center of the acoustic output; however, the acoustic output may be located elsewhere on the horizontal line. Also note that the vertical centerline is not necessarily parallel to the front face of the handset (see right figure), especially for clamshell handsets, handsets with flip covers, and other irregularly-shaped handsets.
3. Position the handset close to the surface of the phantom such that point A is on the (virtual) extension of the line passing through points RE and LE on the phantom (see the figure as next page), such that the plane defined by the vertical centerline and the horizontal line of the handset is approximately parallel to the sagittal plane of the phantom.
4. Translate the handset towards the phantom along the line passing through RE and LE until handset point A touches the pinna at the ERP.

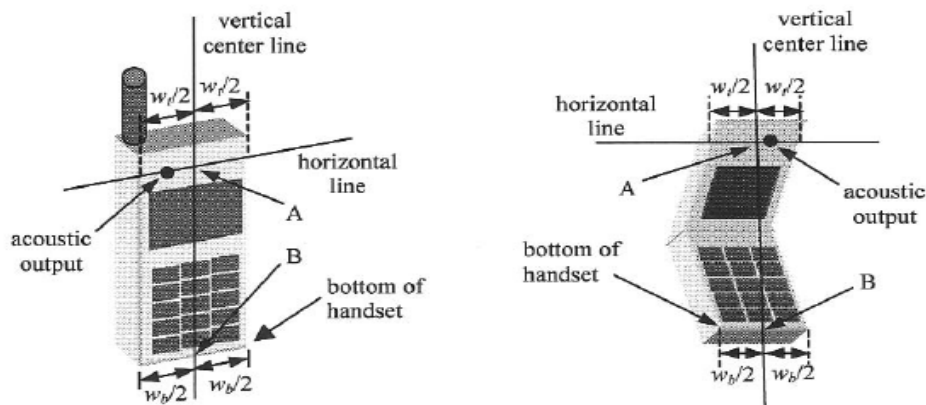

## TEST REPORT

5. While maintaining the handset in this plane, rotate it around the LE-RE line until the vertical centerline is in the plane normal to the plane containing B-M and N-F lines, i.e., the Reference Plane.
6. Rotate the handset around the vertical centerline until the handset (horizontal line) is parallel to the N-F line.
7. While maintaining the vertical centerline in the Reference Plane, keeping point A on the line passing through RE and LE, and maintaining the handset contact with the pinna, rotate the handset about the N-F line until any point on the handset is in contact with a phantom point below the pinna on the cheek.

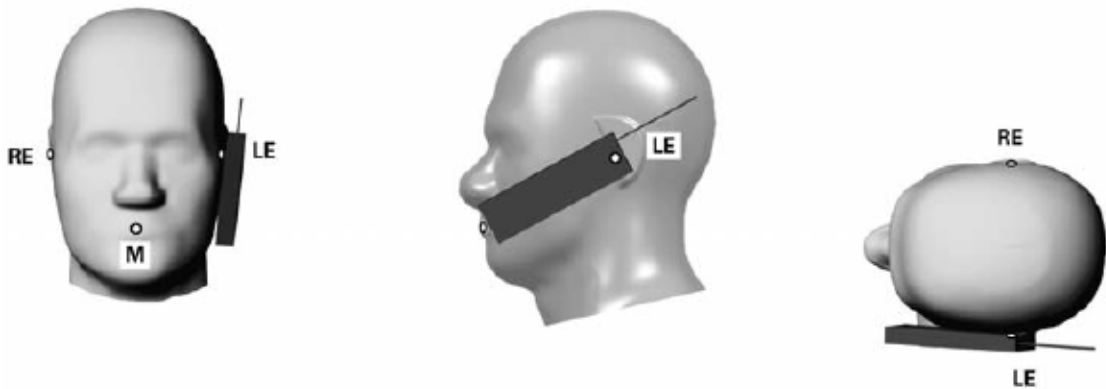

## TEST REPORT

### DEFINITION OF THE TILT POSITION

The tilt position is established as follows:

1. Repeat steps to place the device in the cheek position.
2. While maintaining the orientation of the handset, move the handset away from the pinna along the line passing through RE and LE far enough to allow a rotation of the handset away from the cheek by 15°.
3. Rotate the handset around the horizontal line by 15°.
4. While maintaining the orientation of the handset, move the handset towards the phantom on the line passing through RE and LE until any part of the handset touches the ear. The tilt position is obtained when the contact point is on the pinna. See the figure as below. If contact occurs at any location other than the pinna, e.g., the antenna at the back of the phantom head, the angle of the handset should be reduced.
5. In this case, the tilt position is obtained if any point on the handset is in contact with the pinna and a second point on the handset is in contact with the phantom, e.g., the antenna with the back of the head.

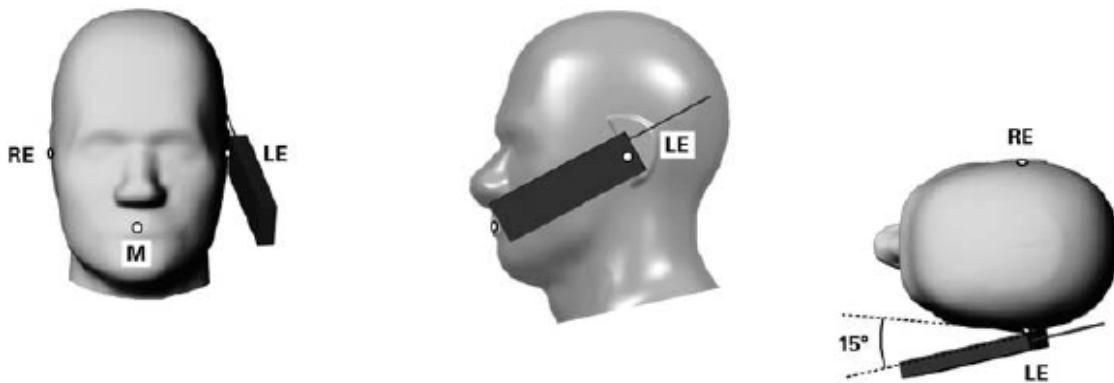

## TEST REPORT

### 6.2. Device test positions relative to body-worn accessory

Body-worn operating configurations are tested with the belt-clips and holsters attached to the device and positioned against a flat phantom in a normal use configuration. Per FCC KDB Publication 648474, Body-worn accessory exposure is typically related to voice mode operations when handsets are carried in body worn accessories. The body-worn accessory procedures in FCC KDB Publication 447498 should be used to test for body-worn accessory SAR compliance, without a headset connected to it. This enables the test results for such configuration to be compatible with that required for hotspot mode when the body-worn accessory test separation distance is greater than or equal to that required for hotspot mode, when applicable. When the reported SAR for a body-worn accessory, measured without a headset connected to the handset, is  $>1.2\text{W/kg}$ , the highest reported SAR configuration for that wireless mode and frequency band should be reported for that body-worn accessory with a headset attached to the handset.

SAR evaluation is required for body-worn accessories supplied with the host device. The test configurations must be conservative for supporting the body-worn accessory use conditions expected by users. Body-worn accessories that do not contain metallic or conductive components may be tested according to worst-case exposure configurations, typically according to the smallest test separation distance required for the group of body-worn accessories with similar operating and exposure characteristics. All body-worn accessories containing metallic components, either supplied with the product or available as an option from the device manufacturer, must be tested in conjunction with the host device to demonstrate compliance

Body-worn accessories may not always be supplied or available as options for some devices intended to be authorized for body-worn use. In this case, a test configuration with a separation distance between the back of the device and the flat phantom is used. Test position spacing was documented. Transmitters that are designed to operate in front of a person's face, as in push-to-talk configurations, are tested for SAR compliance with the front of the device positioned to face the flat phantom in head fluid.



## TEST REPORT

### 6.3. General Device Setup

The device was first charged on a charger over a duration defined by the applicant to make sure the installed battery was fully charged.

The device was then placed into test mode to simulate the worst case configuration through the highest power channel, where the operating parameters established in this test mode is identical to those programmed in production units, including output power levels, amplifier gain settings and other RF performance tuning parameters. The test frequency is corresponded to actual channel frequencies defined for domestic use.

During testing, the device was evaluated with a fully charged battery, power saving function disabled and was configured to operate at maximum output power. A receive antenna and a spectrum analyzer were placed with a distance > 50cm away from the device to monitor the transmission states.

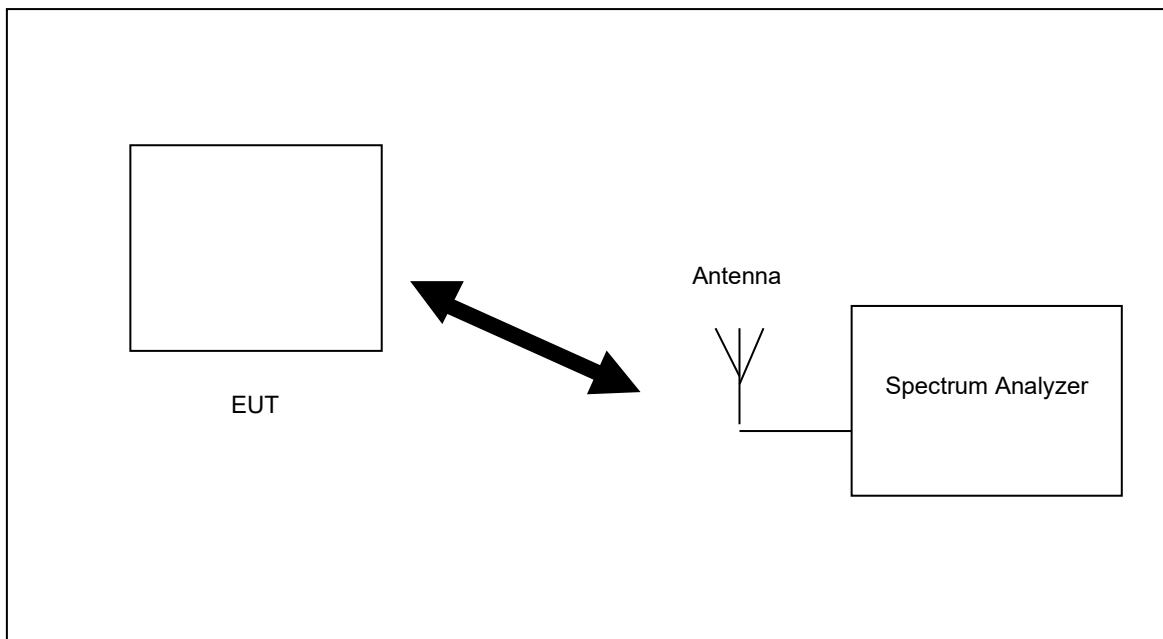

**TEST REPORT**

**6.4. RF Output Power Measurement**

Operating Mode / Band		Date Rate	Channel	Freq. (MHz)	Measured Time-averaged Conducted Power (dBm)
802.11b	2.4G	1Mbps	1	2412	16.9
			6	2437	17.1
			11	2462	16.9
802.11g	2.4G	6Mbps	1	2412	20.9
			6	2437	20.8
			11	2462	20.3
802.11n (HT20)	2.4G	MCS0	1	2412	20.5
			6	2437	20.9
			11	2462	20.8

Note:

1. Time Average power (dBm) = Peak power (dBm) + Time Average factor.
2. Time Average factor =  $10 \cdot \log(\text{duty cycle})$
3. Per KDB 447498, the tested device was within the specified tune-up tolerances range, but not more than 2dB lower than the maximum tune-up tolerance limit.
4. Per KDB 447498, when antenna port was not available on the device to support conducted power measurement and test software was used to establish transmitter power levels, the power level was verified separately according to design and component specifications and product development information specified by the manufacturer.

## TEST REPORT

### 6.5. SAR Test Exclusion Consideration for Adjacent Edges

The SAR test Exclusion Thresholds Evaluation in KDB 447498 D01 can be applied to determine SAR test exclusion for adjacent edge configurations.

The test separation distance for SAR test exclusion of adjacent edges is determined by the closest distance between the antenna and outer housing on the adjacent edge of the device.

According to the antenna to outer housing separation distance and maximum time-averaged output power as below, SAR evaluation of **left and bottom** edges are not required.

Exposure Position	Antenna to outer housing separation distance	Calculated SAR Exclusion Threshold	Maximum Time-averaged Conducted Power	SAR Exclusion Result
Front	12 mm	23.0 mW	125.89 mW	Test required
Top	5 mm	9.6 mW		Test required
Top (antenna extended)	5 mm	9.6 mW		Test required
Left	60 mm	195.8 mW		Excluded
Left (antenna extended)	125 mm	845.8 mW		Excluded
Right	30 mm	57.5 mW		Test required
Back	4 mm	9.6 mW		Test required
Bottom	55 mm	145.8 mW		Excluded

## TEST REPORT

### 6.6. Exposure Conditions

#### In-Front-of Mouth Exposure Conditions

Test Configurations	Distance to phantom	Operation Mode	SAR Required	Note
Front 0mm Separation	Closed	Data	Yes	
Front 0mm Separation	Extended	Data	Yes	

Note:

- Per KDB 447498 D01, if the device is designed to operate in front of the mouth, such as PTT radio, it shall be evaluated with the front of the device positioned at 2.5 cm from a flat phantom. However Front 0mm Separation will be test as the worst case.

#### Body Exposure Conditions

Test Configurations	Distance to phantom	Operation Mode	SAR Required	Note
Front 0mm Separation	Closed	Data	Yes	
Top 0mm Separation	Closed	Data	Yes	
Left 0mm Separation	Closed	Data	No	SAR test exclusion applied
Right 0mm Separation	Closed	Data	Yes	
Back 0mm Separation	Closed	Data	Yes	
Bottom 0mm Separation	Closed	Data	No	SAR test exclusion applied
Front 0mm Separation	Extended	Data	Yes	
Top 0mm Separation	Extended	Data	Yes	
Left 0mm Separation	Extended	Data	No	SAR test exclusion applied
Right 0mm Separation	Extended	Data	Yes	
Back 0mm Separation	Extended	Data	Yes	
Bottom 0mm Separation	Extended	Data	No	SAR test exclusion applied

Note:

- Per KDB 447498 D01, SAR test exclusion can be applied to determine the test configuration for adjacent edge.

## TEST REPORT

### 6.7. Test Result

The results on the following page(s) were obtained when the device was tested in the condition described in this report. Detailed measurement data and plots, which reveal information about the location of the maximum SAR with respect to the device, are reported in Appendix B.

#### In-Front-of Mouth SAR

Chan	Freq. (MHz)	Battery	Band	Test Position	Measurement Result						
					Maximum Allowed Power (dBm)	Measured Power (dBm)	SAR Drift (%)	Measured SAR <sub>1g</sub> (W/kg)	Scaling factor	Reported SAR <sub>1g</sub> (W/kg)	Plot
6	2437	3.7V	802.11b	Front 0mm	18.0	17.1	0.09	0.018	1.23	0.0221	
6	2437	3.7V	802.11b	Front 0mm (antenna extended)	18.0	17.1	0.04	0.153	1.23	0.1882	
1	2412	3.7V	802.11b	Front 0mm (antenna extended)	18.0	16.9	-0.05	0.163	1.29	0.2100	
11	2462	3.7V	802.11b	Front 0mm (antenna extended)	18.0	16.9	0.04	0.179	1.29	0.2306	1

Note:

- Fully charged batteries were used at the beginning of each SAR measurement.
- There was no power reduction used for any band/mode implemented in this device.
- Reported SAR results were scaled to the maximum allowed power with the scaling factor equation  $-10^{[(\text{Maximum power} - \text{measured power}) / 10]}$ .
- Per KDB 447498 D01, when the maximum output power variation across the required test channels was less than 0.5 dB above the output power of the mid-channel, mid-channel shall first be tested.
- Per KDB 248227 D01, When multiple transmission modes (802.11a/g/n/ac) have the same specified maximum output power, largest channel bandwidth, lowest order modulation and lowest data rate, the lowest order 802.11 mode is selected; i.e., 802.11a is chosen over 802.11n then 802.11ac or 802.11g is chosen over 802.11n.
- Per KDB 865664 D01, repeated measurement was not required when the original highest measured SAR was < 0.8W/kg.
- Per KDB 248227 D01, when the highest reported SAR for DSSS was adjusted by the ratio of OFDM to DSSS specified maximum output power and the adjusted SAR is  $\leq 1.2$  W/kg, SAR was not required for the 2.4 GHz OFDM conditions and analysis details were shown as below,

**TEST REPORT**

<b>Adjusted SAR Analysis (IEEE 802.11g)</b>				
<b>Highest Reported SAR (DSSS)</b>	<b>Max power with tolerance (DSSS)</b>	<b>Max power with tolerance (OFDM)</b>	<b>Ratio</b>	<b>Adjusted SAR (OFDM)</b>
0.2306 W/kg	18.0 dBm	21.0 dBm	1.9953	0.4601 W/kg

<b>Adjusted SAR Analysis (IEEE 802.11n (HT20))</b>				
<b>Highest Reported SAR (DSSS)</b>	<b>Max power with tolerance (DSSS)</b>	<b>Max power with tolerance (OFDM)</b>	<b>Ratio</b>	<b>Adjusted SAR (OFDM)</b>
0.2306 W/kg	18.0 dBm	21.0 dBm	1.9953	0.4601 W/kg

**TEST REPORT**

**6.7. Test Result (Cont'd)**

**Body SAR**

Chan	Freq. (MHz)	Battery	Band	Test Position	Measurement Result							Plot
					Maximum Allowed Power (dBm)	Measured Power (dBm)	SAR Drift (%)	Measured SAR <sub>1g</sub> (W/kg)	Scaling factor	Reported SAR <sub>1g</sub> (W/kg)		
6	2437	3.7V	802.11b	Front 0mm	18.0	17.1	0.09	0.018	1.23	0.0221		
6	2437	3.7V	802.11b	Top 0mm	18.0	17.1	0.12	0.251	1.23	0.3088		
6	2437	3.7V	802.11b	Right 0mm	18.0	17.1	0.20	0.003	1.23	0.0037		
6	2437	3.7V	802.11b	Back 0mm	18.0	17.1	0.11	0.629	1.23	0.7738		
1	2412	3.7V	802.11b	Back 0mm	18.0	16.9	0.02	0.640	1.29	0.8245		
11	2462	3.7V	802.11b	Back 0mm	18.0	16.9	0.15	1.020	1.29	1.3140	2	
6	2437	3.7V	802.11b	Back 0mm (antenna extended)	18.0	17.1	0.14	0.565	1.23	0.6951		
6	2437	3.7V	802.11b	Front 0mm (antenna extended)	18.0	17.1	0.04	0.153	1.23	0.1882		
6	2437	3.7V	802.11b	Top 0mm (antenna extended)	18.0	17.1	0.20	0.105	1.23	0.1292		
6	2437	3.7V	802.11b	Right 0mm (antenna extended)	18.0	17.1	0.11	0.058	1.23	0.0714		
6	2437	3.7V	802.11g	Back 0mm	21.0	20.8	0.15	0.382	1.05	0.4000		
1	2412	3.7V	802.11g	Back 0mm	21.0	20.9	0.05	0.297	1.02	0.3039		
11	2462	3.7V	802.11g	Back 0mm	21.0	20.3	-0.04	0.564	1.17	0.6626		
11	2462	3.7V	802.11b	Back 0mm (repeated)	18.0	16.9	0.10	0.994	1.29	1.2805		

**TEST REPORT**

Note:

1. Fully charged batteries were used at the beginning of each SAR measurement.
2. There was no power reduction used for any band/mode implemented in this device.
3. Reported SAR results were scaled to the maximum allowed power with the scaling factor equation  $-10^{[(\text{Maximum power} - \text{measured power}) / 10]}$ .
4. Per KDB 447498 D01, when the maximum output power variation across the required test channels was less than 0.5 dB above the output power of the mid-channel, mid-channel shall first be tested.
5. Per KDB 447498 D01, when the reported SAR is > 0.8 W/kg, SAR is required for that exposure configuration using the next highest measured output power channel. When any reported SAR is > 1.2 W/kg, SAR is required for the third channel; i.e., all channels require testing.
6. Per KDB 248227 D01, When multiple transmission modes (802.11a/g/n/ac) have the same specified maximum output power, largest channel bandwidth, lowest order modulation and lowest data rate, the lowest order 802.11 mode is selected; i.e., 802.11a is chosen over 802.11n then 802.11ac or 802.11g is chosen over 802.11n.
7. Per KDB 865664 D01, repeated measurement was required when the original highest measured SAR was > 0.8W/kg and analysis details were shown as below,

**Measurement Variability**

Per KDB 865664 D01, measurement variability was assessed using the following procedures,

- 1) When the original highest measured SAR is  $\geq 0.80$  W/kg, repeat that measurement once.
- 2) Perform a second repeated measurement only if the ratio of largest to smallest SAR for the original and first repeated measurements is > 1.20 or when the original or repeated measurement is  $\geq 1.45$  W/kg (~ 10% from the 1-g SAR limit).
- 3) Perform a third repeated measurement only if the original, first or second repeated measurement is  $\geq 1.5$  W/kg and the ratio of largest to smallest SAR for the original, first and second repeated measurements is > 1.20.

Chan	Freq. (MHz)	Band	Test Position	Measurement Variability Result						
				Measured SAR <sub>1g</sub> (W/kg)	1 <sup>st</sup> repeated SAR <sub>1g</sub> (W/kg)	Ratio	2 <sup>nd</sup> repeated SAR <sub>1g</sub> (W/kg)	Ratio	3 <sup>rd</sup> repeated SAR <sub>1g</sub> (W/kg)	Ratio
11	2462	802.11b	Back Omm	1.020	0.994	1.03	N/A	N/A	N/A	N/A



**TEST REPORT**

**6.8. SAR Limits**

The following FCC limits (Std. C95.1-1992) for SAR apply to devices operate in General Population/Uncontrolled Exposure and Controlled environment:

**GENERAL POPULATION / UNCONTROLLED ENVIRONMENTS:**

Defined as location where there is the exposure of individuals who have no knowledge or control of their exposure.

<b>EXPOSURE (General Population/Uncontrolled Exposure environment)</b>	<b>SAR (W/kg)</b>
Spatial Peak SAR (Head)*	1.60
Spatial Peak SAR (Partial Body)*	1.60
Spatial Peak SAR (Whole Body)*	0.08
Spatial Peak SAR (Hands / Wrists / Feet / Ankles)**	4.00

**OCCUPATIONAL / CONTROLLED ENVIRONMENTS:**

Defined as location where there is the exposure that may be incurred by persons who are aware of the potential for exposure, (i.e. as a result of employment or occupation)

<b>EXPOSURE (Occupational/Controlled Exposure environment)</b>	<b>SAR (W/kg)</b>
Spatial Peak SAR (Head)*	8.00
Spatial Peak SAR (Partial Body)*	8.00
Spatial Peak SAR (Whole Body)*	0.40
Spatial Peak SAR (Hands / Wrists / Feet / Ankles)**	20.00

Notes:

- \* The Spatial Peak value of the SAR averaged over any 1 gram of tissue.  
(defined as a tissue volume in the shape of a cube) and over the appropriate averaging time
- \*\* The Spatial Peak value of the SAR averaged over any 10 gram of tissue.  
(defined as a tissue volume in the shape of a cube) and over the appropriate averaging time

## TEST REPORT

### 7. TEST EQUIPMENT LIST

Equipment	Manufacturer	Model	SN	Cal. Date	Cal. Interval
System Validation Dipole	SPEAG	D2450V2	1014	May. 19, 2021	3 Year
Dosimetric E-Field Probe	SPEAG	ES3DV3	3090	Apr. 26, 2021	1 Year
Data Acquisition Electronics	SPEAG	DAE4	662	Apr. 09, 2021	1 Year
Twins Phantom	TP-1376	SPEAG	SAM	N/A	N/A
ENA Series Network Analyzer	Agilent	8753ES	US39170317	Nov. 10, 2020	1 Year
Dielectric Assessment Kit	SPEAG	DAK-3.5	1056	N/A	N/A
USB/GPIB Interface	Agilent	82357B	N10149	N/A	N/A
Signal Generator	R&S	SMB100A	103718	Apr. 22, 2021	1 Year
POWER METER	R&S	NRP	101293	Nov. 10, 2020	1 Year
Thermometer	120100323	Shanghai Gao Zhi Precision Instrument Co., Ltd.	HB6801	Nov. 17, 2020	1 Year
Coupler	Agilent	778D	MY52180234	Nov. 16, 2020	1 Year
Amplifier	Mini-Circuit	ZHL42	QA1252001	N/A	N/A
DC Source	Agilent	66319B	MY43000795	N/A	N/A

## TEST REPORT

### 8. MEASUREMENT UNCERTAINTY

Per FCC KDB 865884, the extensive SAR measurement uncertainty analysis was not required when the highest measured SAR was < 1.5W/kg for all frequency band.

**TABLE 1 EXPOSURE ASSESSMENT UNCERTAINTY FOR HANDSET SAR**

Source of Uncertainty	Tolerance (± %)	Probability Distribution	Divisor	Ci (1g)	Ci (10g)	Standard Uncertainty (1g)	Standard Uncertainty (10g)	Vi Veff
<b>Measurement System</b>								
Probe Calibration	6.55	Normal	1	1	1	± 6.0 %	± 6.0 %	∞
Axial Isotropy	4.7	Rectangular	√3	0.7	0.7	± 1.9 %	± 1.9 %	∞
Hemispherical Isotropy	9.6	Rectangular	√3	0.7	0.7	± 3.9 %	± 3.9 %	∞
Boundary Effects	2	Rectangular	√3	1	1	± 0.6 %	± 0.6 %	∞
Linearity	4.7	Rectangular	√3	1	1	± 2.7 %	± 2.7 %	∞
Detection Limits	0.25	Rectangular	√3	1	1	± 0.1 %	± 0.1 %	∞
Modulation Response	2.4	Rectangular	√3	1	1	± 1.4%	± 1.4%	∞
Readout Electronics	0.3	Normal	1	1	1	± 0.3 %	± 0.3 %	∞
Response Time	0	Rectangular	√3	1	1	± 0.0 %	± 0.0 %	∞
Integration Time	1.7	Rectangular	√3	1	1	± 1.0 %	± 1.0 %	∞
RF Ambient – Noise	3	Rectangular	√3	1	1	± 1.7 %	± 1.7 %	∞
RF Ambient – Reflections	3	Rectangular	√3	1	1	± 1.7 %	± 1.7 %	∞
Probe Positioner	0.4	Rectangular	√3	1	1	± 0.2 %	± 0.2 %	∞
Probe Positioning	6.7	Rectangular	√3	1	1	± 1.7 %	± 1.7 %	∞
Max. SAR Evaluation	4	Rectangular	√3	1	1	± 1.2 %	± 1.2 %	∞
<b>Test Sample Related</b>								
Device Positioning	2.3 / 2.4	Normal	1	1	1	± 2.3 %	± 2.4 %	30
Device Holder	2.8 / 2.8	Normal	1	1	1	± 2.8 %	± 2.8 %	30
Power Drift	5	Rectangular	√3	1	1	± 2.9 %	± 2.9 %	∞
Power Scaling	0	Rectangular	√3	1	1	± 0 %	± 0 %	∞
<b>Phantom and Setup</b>								
Phantom Uncertainty	7.9	Rectangular	√3	1	1	± 4.3 %	± 4.3 %	∞
SAR correction	1.2 / 0.97	Rectangular	√3	1	0.84	± 0.7 %	± 0.5 %	∞
Liquid Conductivity (Meas.)	2.5	Rectangular	√3	0.78	0.71	± 1.1 %	± 1 %	∞
Liquid Permittivity (Meas.)	2.5	Rectangular	√3	0.26	0.26	± 0.4 %	± 0.4 %	∞
Temp. unc. - Conductivity	3.4	Rectangular	√3	0.78	0.71	± 2.3 %	± 2.1 %	∞
Temp. unc. - Permittivity	0.4	Rectangular	√3	0.23	0.26	± 0.1 %	± 0.1 %	∞
<b>Combined Standard Uncertainty (k = 1)</b>						± 12.2 %	± 12.3 %	
<b>Expanded Uncertainty (k = 2)</b>						± 24.1 %	± 23.8 %	

## TEST REPORT

**TABLE 2 SYSTEM VALIDATION Measurement uncertainty**

Source of Uncertainty	Tolerance (± %)	Probability Distribution	Divisor	Ci (1g)	Ci (10g)	Standard Uncertainty (1g)	Standard Uncertainty (10g)	Vi Veff
<b>Measurement System</b>								
Probe Calibration	6.55	Normal	1	1	1	± 6.0 %	± 6.0 %	∞
Axial Isotropy	4.7	Rectangular	√3	0.7	0.7	± 1.9 %	± 1.9 %	∞
Hemispherical Isotropy	9.6	Rectangular	√3	0.7	0.7	± 3.9 %	± 3.9 %	∞
Boundary Effects	2	Rectangular	√3	1	1	± 0.6 %	± 0.6 %	∞
Linearity	4.7	Rectangular	√3	1	1	± 2.7 %	± 2.7 %	∞
Detection Limits	0.25	Rectangular	√3	1	1	± 0.1 %	± 0.1 %	∞
Modulation Response	2.4	Rectangular	√3	1	1	± 1.4%	± 1.4%	∞
Readout Electronics	0.3	Normal	1	1	1	± 0.3 %	± 0.3 %	∞
Response Time	0	Rectangular	√3	1	1	± 0.0 %	± 0.0 %	∞
Integration Time	1.7	Rectangular	√3	1	1	± 1.0 %	± 1.0 %	∞
RF Ambient – Noise	3	Rectangular	√3	1	1	± 1.7 %	± 1.7 %	∞
RF Ambient – Reflections	3	Rectangular	√3	1	1	± 1.7 %	± 1.7 %	∞
Probe Positioner	0.4	Rectangular	√3	1	1	± 0.2 %	± 0.2 %	∞
Probe Positioning	6.7	Rectangular	√3	1	1	± 1.7 %	± 1.7 %	∞
Max. SAR Evaluation	4	Rectangular	√3	1	1	± 1.2 %	± 1.2 %	∞
<b>Test Sample Related</b>								
Deviation of experimental dipole	5.0	Rectangular	√3	1	1	± 2.9 %	± 2.9 %	∞
Input power and SAR drift measurement	5.0	Rectangular	√3	1	1	± 2.9 %	± 2.9 %	∞
Dipole axis to liquid distance	2.0	Rectangular	√3	1	1	± 1.2 %	± 1.2 %	∞
<b>Phantom and Setup</b>								
Phantom Uncertainty	7.9	Rectangular	√3	1	1	± 4.3 %	± 4.3 %	∞
SAR correction	1.2 / 0.97	Rectangular	√3	1	0.84	± 0.7 %	± 0.5 %	∞
Liquid Conductivity (Meas.)	2.5	Rectangular	√3	0.78	0.71	± 1.1 %	± 1 %	∞
Liquid Permittivity (Meas.)	2.5	Rectangular	√3	0.26	0.26	± 0.4 %	± 0.4 %	∞
Temp. unc. - Conductivity	3.4	Rectangular	√3	0.78	0.71	± 2.3 %	± 2.1 %	∞
Temp. unc. - Permittivity	0.4	Rectangular	√3	0.23	0.26	± 0.1 %	± 0.1 %	∞
<b>Combined Standard Uncertainty (k = 1)</b>						± 12.0 %	± 12.0 %	
<b>Expanded Uncertainty (k = 2)</b>						<b>± 24.0 %</b>	<b>± 23.9 %</b>	

## TEST REPORT

### 9. E-FIELD PROBE AND DIPOLE ANTENNA CALIBRATION

Probe calibration factors and dipole antenna calibration are included in Appendix C.

## TEST REPORT

### APPENDIX A – SYSTEM CHECK DATA

#### Plot #1

Test Laboratory: UnionTrust

Date/Time: 2021/9/19

#### System Check\_H2450\_10dBm\_SAM1

##### DUT: Dipole 2450 MHz

Communication System: CW; Frequency: 2450 MHz; Duty Cycle: 1:1  
Medium: H2450 Medium parameters used:  $f = 2450$  MHz;  $\sigma = 1.87$  mho/m;  $\epsilon_r = 38.9$ ;  $\rho = 1000$  kg/m<sup>3</sup>

##### DASY4 Configuration:

- Probe: ES3DV3 - SN3090; ConvF(4.6, 4.6, 4.6); Calibrated: 2021/4/26
- Sensor-Surface: 3mm (Mechanical Surface Detection)
- Electronics: DAE4 Sn662; Calibrated: 2021/4/9
- Phantom: SAM 1; Type: QD 000 P40 CB; Serial: TP/1378
- Postprocessing SW: SEMCAD, V1.8 Build 176

**Area Scan (51x71x1):** Measurement grid: dx=15mm, dy=15mm  
Maximum value of SAR (interpolated) = 0.766 mW/g

**Zoom Scan (5x5x7)/Cube 0:** Measurement grid: dx=8mm, dy=8mm, dz=5mm  
Reference Value = 17.2 V/m; Power Drift = 0.167 dB  
Peak SAR (extrapolated) = 1.12 W/kg  
**SAR(1 g) = 0.514 mW/g; SAR(10 g) = 0.231 mW/g**  
Maximum value of SAR (measured) = 0.682 mW/g

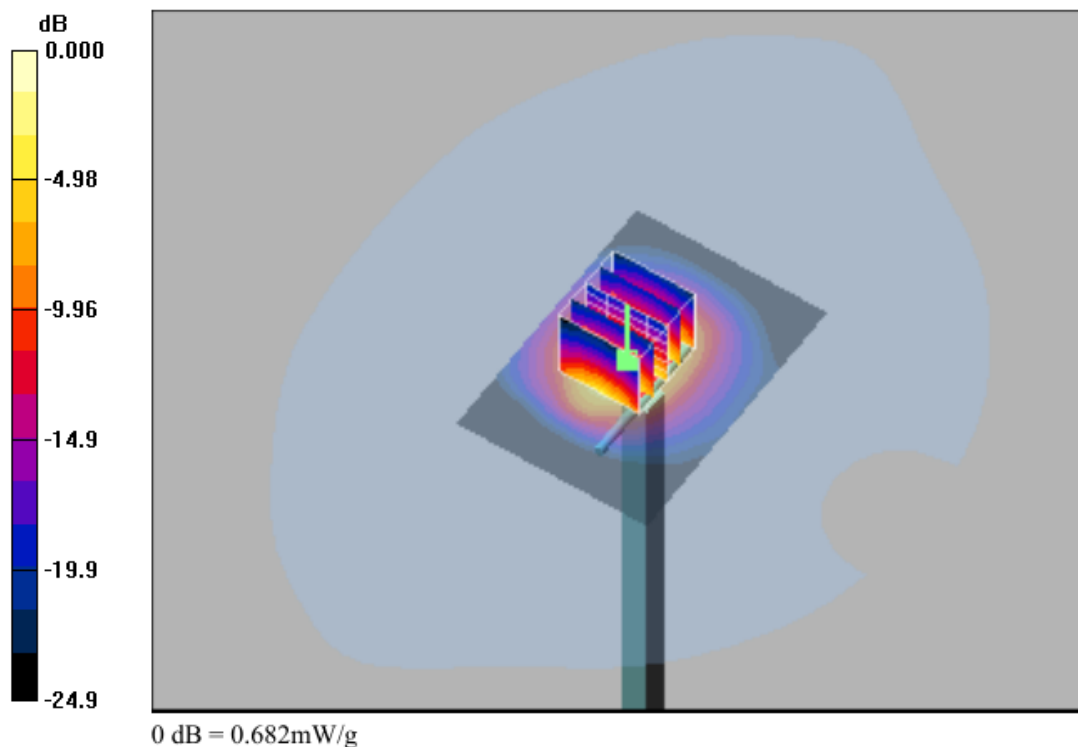

**TEST REPORT**

**APPENDIX B – SAR EVALUATION DATA**

Plot #1

Test Laboratory: UnionTrust

Date/Time: 2021/9/19

**802.11b\_Front Face\_0MM\_11**

**DUT: EUT**

Communication System: Wlan 802.11b; Frequency: 2462 MHz;Duty Cycle: 1:1  
Medium: H2450 Medium parameters used:  $f = 2462 \text{ MHz}$ ;  $\sigma = 1.83 \text{ mho/m}$ ;  $\epsilon_r = 38.2$ ;  $\rho = 1000 \text{ kg/m}^3$

DASY4 Configuration:

- Probe: ES3DV3 - SN3090; ConvF(4.6, 4.6, 4.6); Calibrated: 2021/4/26
- Sensor-Surface: 3mm (Mechanical Surface Detection)
- Electronics: DAE4 Sn662; Calibrated: 2021/4/9
- Phantom: SAM 1; Type: QD 000 P40 CB; Serial: TP/1378
- Postprocessing SW: SEMCAD, V1.8 Build 176

**Area Scan (81x131x1):** Measurement grid:  $dx=12\text{mm}$ ,  $dy=12\text{mm}$   
Maximum value of SAR (interpolated) = 0.242 mW/g

**Zoom Scan (7x7x7)/Cube 0:** Measurement grid:  $dx=5\text{mm}$ ,  $dy=5\text{mm}$ ,  $dz=5\text{mm}$   
Reference Value = 3.65 V/m; Power Drift = 0.043 dB  
Peak SAR (extrapolated) = 0.388 W/kg  
SAR(1 g) = 0.179 mW/g; SAR(10 g) = 0.087 mW/g  
Maximum value of SAR (measured) = 0.235 mW/g

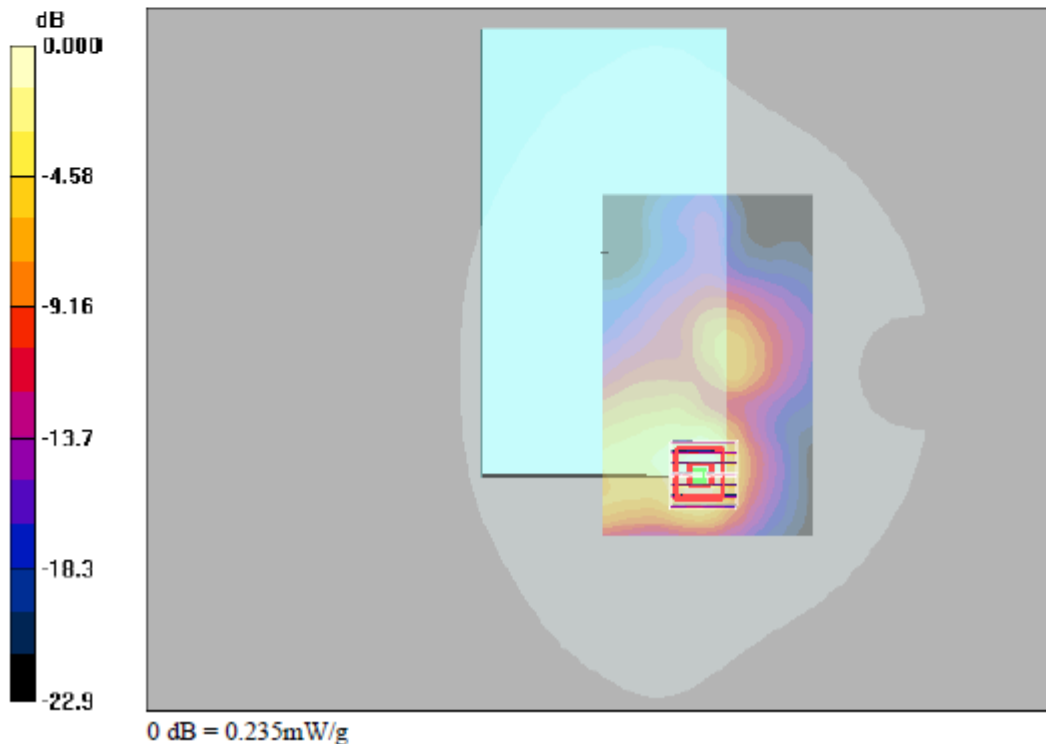

**TEST REPORT**

**APPENDIX B – SAR EVALUATION DATA**

**Plot #2**

Test Laboratory: UnionTrust

Date/Time: 2021/9/19

**802.11b\_Rear Face\_0MM\_11**

**DUT: EUT**

Communication System: Wlan 802.11b; Frequency: 2462 MHz;Duty Cycle: 1:1  
Medium: H2450 Medium parameters used:  $f = 2462$  MHz;  $\sigma = 1.83$  mho/m;  $\epsilon_r = 38.2$ ;  $\rho = 1000$  kg/m<sup>3</sup>

**DASY4 Configuration:**

- Probe: ES3DV3 - SN3090; ConvF(4.6, 4.6, 4.6); Calibrated: 2021/4/26
- Sensor-Surface: 3mm (Mechanical Surface Detection)
- Electronics: DAE4 Sn662; Calibrated: 2021/4/9
- Phantom: SAM 1; Type: QD 000 P40 CB; Serial: TP/1378
- Postprocessing SW: SEMCAD, V1.8 Build 176

**Area Scan (81x111x1):** Measurement grid: dx=12mm, dy=12mm  
Maximum value of SAR (interpolated) = 1.48 mW/g

**Zoom Scan (7x7x7)/Cube 0:** Measurement grid: dx=5mm, dy=5mm, dz=5mm  
Reference Value = 16.8 V/m; Power Drift = 0.151 dB  
Peak SAR (extrapolated) = 2.45 W/kg  
**SAR(1 g) = 1.02 mW/g; SAR(10 g) = 0.425 mW/g**  
Maximum value of SAR (measured) = 1.39 mW/g

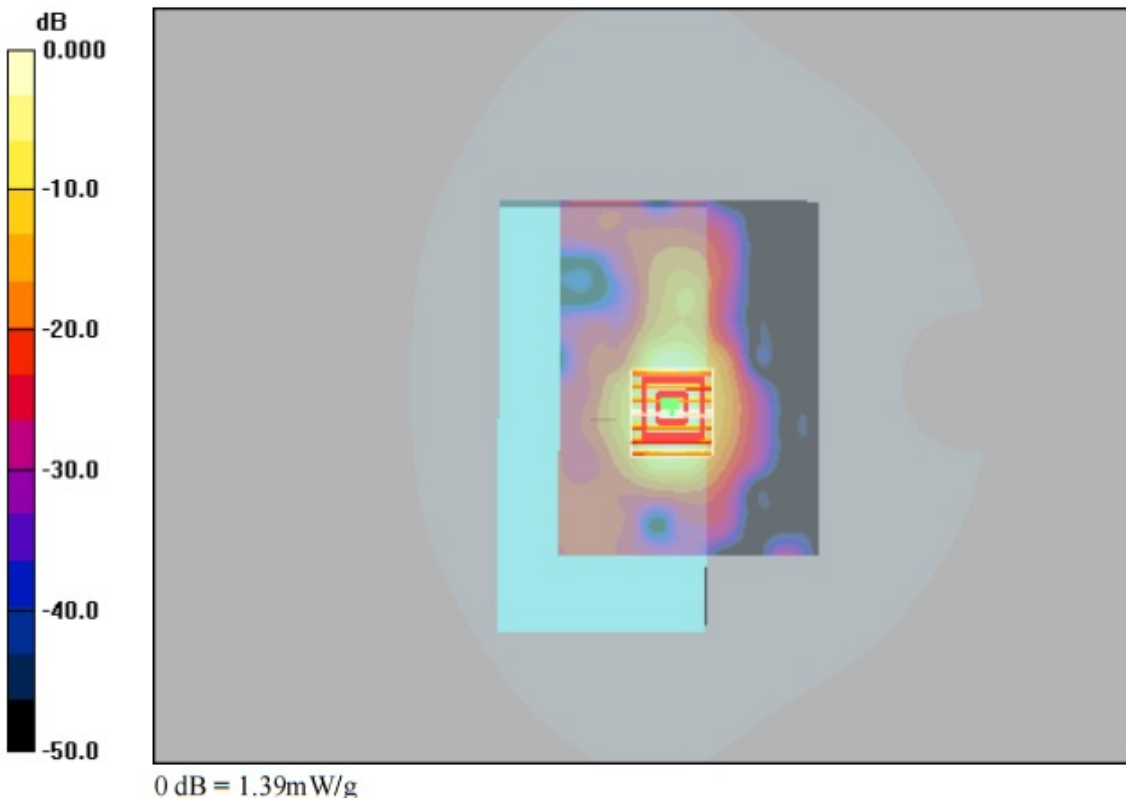



**TEST REPORT**

**APPENDIX C – E-FIELD PROBE AND DIPOLE ANTENNA CALIBRATION**



In Collaboration with  
**s p e a g**  
 CALIBRATION LABORATORY



中国认可  
 国际互认  
 校准  
 CALIBRATION  
 CNAS L0570

Add: No.52 HuaYuanBei Road, Haidian District, Beijing, 100191, China  
 Tel: +86-10-62304633-2512 Fax: +86-10-62304633-2504  
 E-mail: cttl@chinattl.com [Http://www.chinattl.cn](http://www.chinattl.cn)

Client **UnionTrust**

Certificate No: **Z21-60111**

## CALIBRATION CERTIFICATE

Object **ES3DV3 - SN : 3090**

Calibration Procedure(s) **FF-Z11-004-02**  
**Calibration Procedures for Dosimetric E-field Probes**

Calibration date: **April 26, 2021**

This calibration Certificate documents the traceability to national standards, which realize the physical units of measurements(SI). The measurements and the uncertainties with confidence probability are given on the following pages and are part of the certificate.

All calibrations have been conducted in the closed laboratory facility: environment temperature(22±3)°C and humidity<70%.

### Calibration Equipment used (M&TE critical for calibration)

Primary Standards	ID #	Cal Date(Calibrated by, Certificate No.)	Scheduled Calibration
Power Meter NRP2	101919	16-Jun-20(CTTL, No.J20X04344)	Jun-21
Power sensor NRP-Z91	101547	16-Jun-20(CTTL, No.J20X04344)	Jun-21
Power sensor NRP-Z91	101548	16-Jun-20(CTTL, No.J20X04344)	Jun-21
Reference 10dBAttenuator	18N50W-10dB	10-Feb-20(CTTL, No.J20X00525)	Feb-22
Reference 20dBAttenuator	18N50W-20dB	10-Feb-20(CTTL, No.J20X00526)	Feb-22
Reference Probe EX3DV4	SN 3617	27-Jan-21(SPEAG, No.EX3-3617_Jan21)	Jan-22
DAE4	SN 1556	15-Jan-21(SPEAG, No.DAE4-1556_Jan21)	Jan-22
Secondary Standards	ID #	Cal Date(Calibrated by, Certificate No.)	Scheduled Calibration
SignalGenerator MG3700A	6201052605	23-Jun-20(CTTL, No.J20X04343)	Jun-21
Network Analyzer E5071C	MY46110673	21-Jan-21(CTTL, No.J20X00515)	Jan-22

	Name	Function	Signature
Calibrated by:	Yu Zongying	SAR Test Engineer	
Reviewed by:	Lin Hao	SAR Test Engineer	
Approved by:	Qi Dianyuan	SAR Project Leader	

Issued: April 28, 2021

This calibration certificate shall not be reproduced except in full without written approval of the laboratory.



### Glossary:

TSL	tissue simulating liquid
NORM <sub>x,y,z</sub>	sensitivity in free space
ConvF	sensitivity in TSL / NORM <sub>x,y,z</sub>
DCP	diode compression point
CF	crest factor (1/duty_cycle) of the RF signal
A,B,C,D	modulation dependent linearization parameters
Polarization $\Phi$	$\Phi$ rotation around probe axis
Polarization $\theta$	$\theta$ rotation around an axis that is in the plane normal to probe axis (at measurement center), $i$ $\theta=0$ is normal to probe axis

Connector Angle information used in DASY system to align probe sensor X to the robot coordinate system

### Calibration is Performed According to the Following Standards:

- IEEE Std 1528-2013, "IEEE Recommended Practice for Determining the Peak Spatial-Averaged Specific Absorption Rate (SAR) in the Human Head from Wireless Communications Devices: Measurement Techniques", June 2013
- IEC 62209-1, "Measurement procedure for the assessment of Specific Absorption Rate (SAR) from hand-held and body-mounted devices used next to the ear (frequency range of 300 MHz to 6 GHz)", July 2016
- IEC 62209-2, "Procedure to determine the Specific Absorption Rate (SAR) for wireless communication devices used in close proximity to the human body (frequency range of 30 MHz to 6 GHz)", March 2010
- KDB 865664, "SAR Measurement Requirements for 100 MHz to 6 GHz"

### Methods Applied and Interpretation of Parameters:

- NORM<sub>x,y,z</sub>**: Assessed for E-field polarization  $\theta=0$  ( $f \leq 900$  MHz in TEM-cell;  $f > 1800$  MHz: waveguide). NORM<sub>x,y,z</sub> are only intermediate values, i.e., the uncertainties of NORM<sub>x,y,z</sub> does not effect the  $E^2$ -field uncertainty inside TSL (see below ConvF).
- NORM(f)<sub>x,y,z</sub> = NORM<sub>x,y,z</sub> \* frequency\_response** (see Frequency Response Chart). This linearization is implemented in DASY4 software versions later than 4.2. The uncertainty of the frequency response is included in the stated uncertainty of ConvF.
- DCP<sub>x,y,z</sub>**: DCP are numerical linearization parameters assessed based on the data of power sweep (no uncertainty required). DCP does not depend on frequency nor media.
- PAR**: PAR is the Peak to Average Ratio that is not calibrated but determined based on the signal characteristics.
- A<sub>x,y,z</sub>; B<sub>x,y,z</sub>; C<sub>x,y,z</sub>; VR<sub>x,y,z</sub>; A,B,C** are numerical linearization parameters assessed based on the data of power sweep for specific modulation signal. The parameters do not depend on frequency nor media. VR is the maximum calibration range expressed in RMS voltage across the diode.
- ConvF and Boundary Effect Parameters**: Assessed in flat phantom using E-field (or Temperature Transfer Standard for  $f \leq 800$  MHz) and inside waveguide using analytical field distributions based on power measurements for  $f > 800$  MHz. The same setups are used for assessment of the parameters applied for boundary compensation (alpha, depth) of which typical uncertainty valued are given. These parameters are used in DASY4 software to improve probe accuracy close to the boundary. The sensitivity in TSL corresponds to NORM<sub>x,y,z</sub> \* ConvF whereby the uncertainty corresponds to that given for ConvF. A frequency dependent ConvF is used in DASY version 4.4 and higher which allows extending the validity from  $\pm 50$  MHz to  $\pm 100$  MHz.
- Spherical Isotropy (3D deviation from isotropy)**: in a field of low gradients realized using a flat phantom exposed by a patch antenna.
- Sensor Offset**: The sensor offset corresponds to the offset of virtual measurement center from the probe tip (on probe axis). No tolerance required.
- Connector Angle**: The angle is assessed using the information gained by determining the NORM<sub>x</sub> (no uncertainty required).



## DASY/EASY – Parameters of Probe: ES3DV3 – SN:3090

### Basic Calibration Parameters

	Sensor X	Sensor Y	Sensor Z	Unc (k=2)
Norm( $\mu\text{V}/(\text{V}/\text{m})^2$ ) <sup>A</sup>	1.24	1.34	1.35	$\pm 10.0\%$
DCP(mV) <sup>B</sup>	104.6	105.7	104.1	

### Modulation Calibration Parameters

UID	Communication System Name		A dB	B dB $\mu\text{V}$	C	D dB	VR mV	Unc <sup>E</sup> (k=2)
0	CW	X	0.0	0.0	1.0	0.00	268.7	$\pm 2.2\%$
		Y	0.0	0.0	1.0		282.4	
		Z	0.0	0.0	1.0		281.0	

The reported uncertainty of measurement is stated as the standard uncertainty of Measurement multiplied by the coverage factor  $k=2$ , which for a normal distribution Corresponds to a coverage probability of approximately 95%.

<sup>A</sup> The uncertainties of Norm X, Y, Z do not affect the E<sup>2</sup>-field uncertainty inside TSL (see Page 4).

<sup>B</sup> Numerical linearization parameter: uncertainty not required.

<sup>E</sup> Uncertainty is determined using the max. deviation from linear response applying rectangular distribution and is expressed for the square of the field value.



## DASY/EASY – Parameters of Probe: ES3DV3 – SN:3090

### Calibration Parameter Determined in Head Tissue Simulating Media

f [MHz] <sup>C</sup>	Relative Permittivity <sup>F</sup>	Conductivity (S/m) <sup>F</sup>	ConvF X	ConvF Y	ConvF Z	Alpha <sup>G</sup>	Depth <sup>G</sup> (mm)	Uct. (k=2)
750	41.9	0.89	6.32	6.32	6.32	0.40	1.40	±12.1%
835	41.5	0.90	6.15	6.15	6.15	0.37	1.48	±12.1%
1750	40.1	1.37	5.28	5.28	5.28	0.63	1.27	±12.1%
1900	40.0	1.40	5.08	5.08	5.08	0.69	1.23	±12.1%
2300	39.5	1.67	4.80	4.80	4.80	0.90	1.12	±12.1%
2450	39.2	1.80	4.60	4.60	4.60	0.71	1.34	±12.1%
2600	39.0	1.96	4.43	4.43	4.43	0.88	1.15	±12.1%

<sup>C</sup> Frequency validity above 300 MHz of ±100MHz only applies for DASY v4.4 and higher (Page 2), else it is restricted to ±50MHz. The uncertainty is the RSS of ConvF uncertainty at calibration frequency and the uncertainty for the indicated frequency band. Frequency validity below 300 MHz is ± 10, 25, 40, 50 and 70 MHz for ConvF assessments at 30, 64, 128, 150 and 220 MHz respectively. Above 5 GHz frequency validity can be extended to ± 110 MHz.

<sup>F</sup> At frequency below 3 GHz, the validity of tissue parameters ( $\epsilon$  and  $\sigma$ ) can be relaxed to ±10% if liquid compensation formula is applied to measured SAR values. At frequencies above 3 GHz, the validity of tissue parameters ( $\epsilon$  and  $\sigma$ ) is restricted to ±5%. The uncertainty is the RSS of the ConvF uncertainty for indicated target tissue parameters.

<sup>G</sup> Alpha/Depth are determined during calibration. SPEAG warrants that the remaining deviation due to the boundary effect after compensation is always less than ± 1% for frequencies below 3 GHz and below ± 2% for the frequencies between 3-6 GHz at any distance larger than half the probe ip diameter from the boundary.



## Frequency Response of E-Field (TEM-Cell: ifi110 EXX, Waveguide: R22)

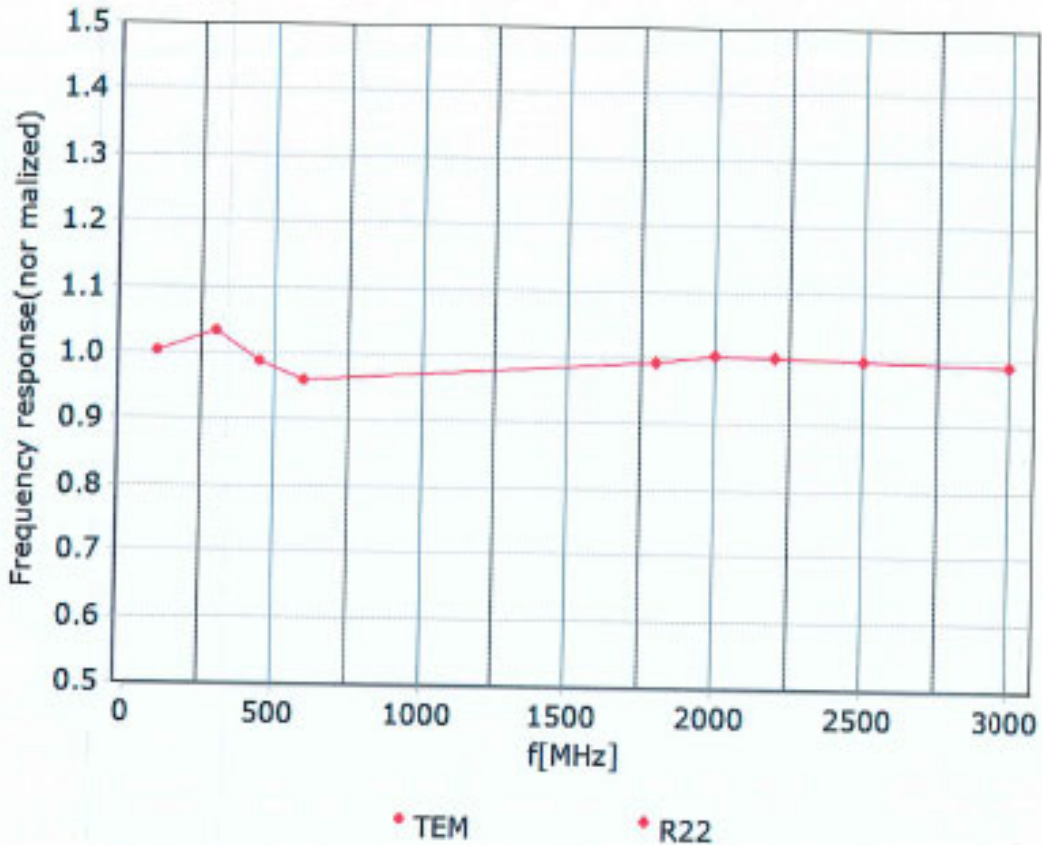

Uncertainty of Frequency Response of E-field:  $\pm 7.4\%$  ( $k=2$ )



## Receiving Pattern ( $\Phi$ ), $\theta=0^\circ$

f=600 MHz, TEM

f=1800 MHz, R22

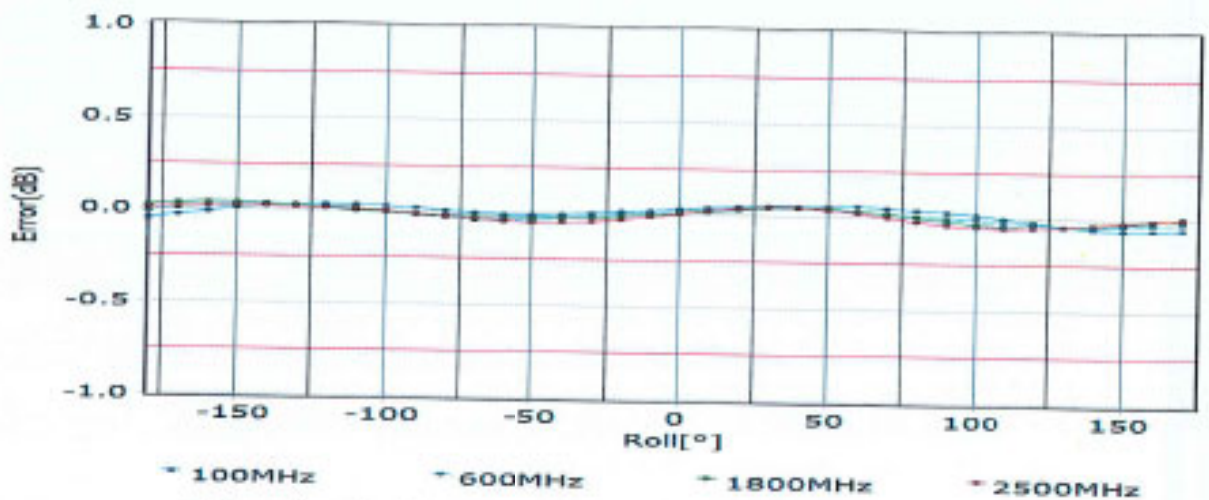
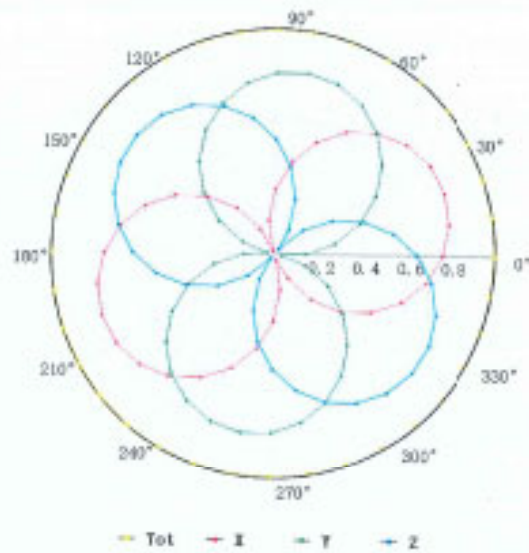
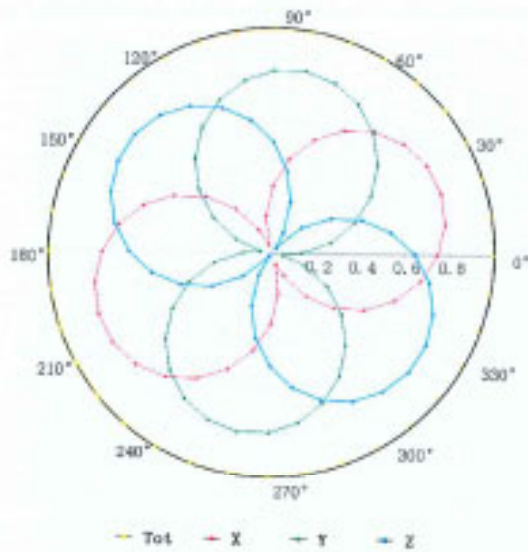

Uncertainty of Axial Isotropy Assessment:  $\pm 1.2\%$  ( $k=2$ )



## Dynamic Range f(SAR<sub>head</sub>) (TEM cell, f = 900 MHz)

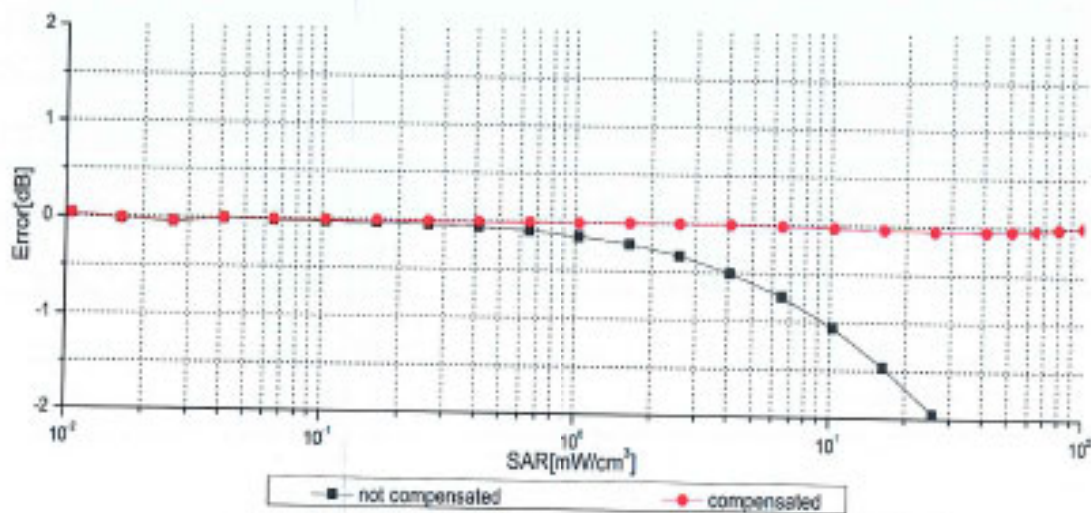
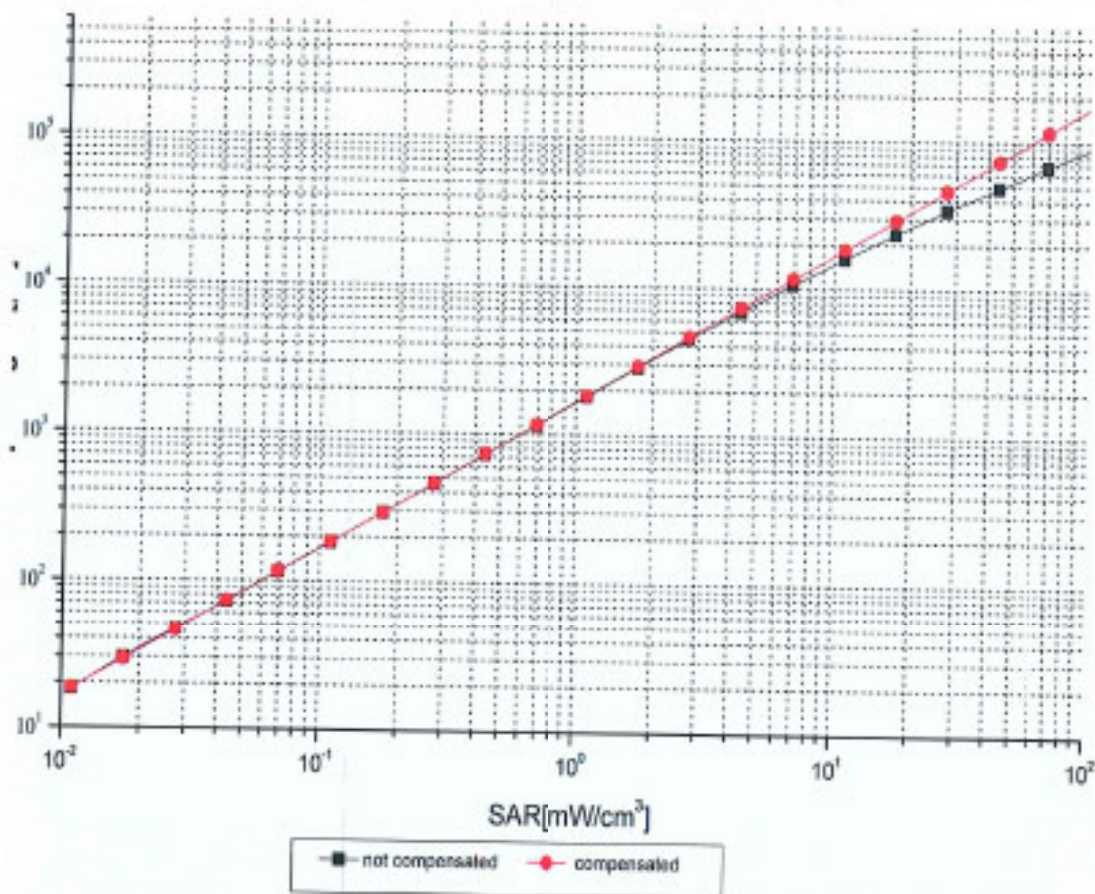

Uncertainty of Linearity Assessment:  $\pm 0.9\%$  ( $k=2$ )





## Conversion Factor Assessment

f=750 MHz,WGLS R9(H\_convF)

f=1750 MHz,WGLS R22(H\_convF)

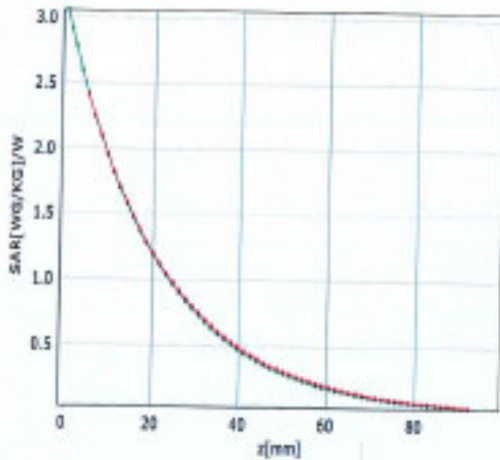

\* analytical \* measured

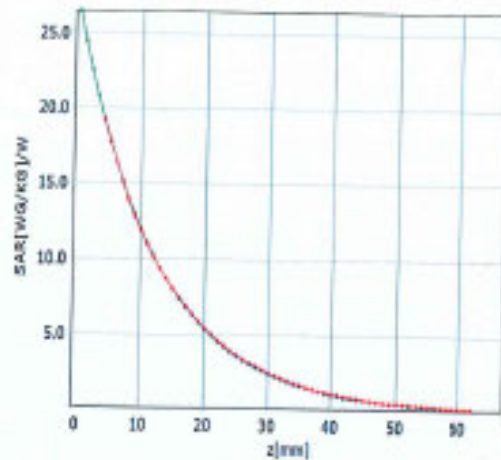

\* analytical \* measured

## Deviation from Isotropy in Liquid

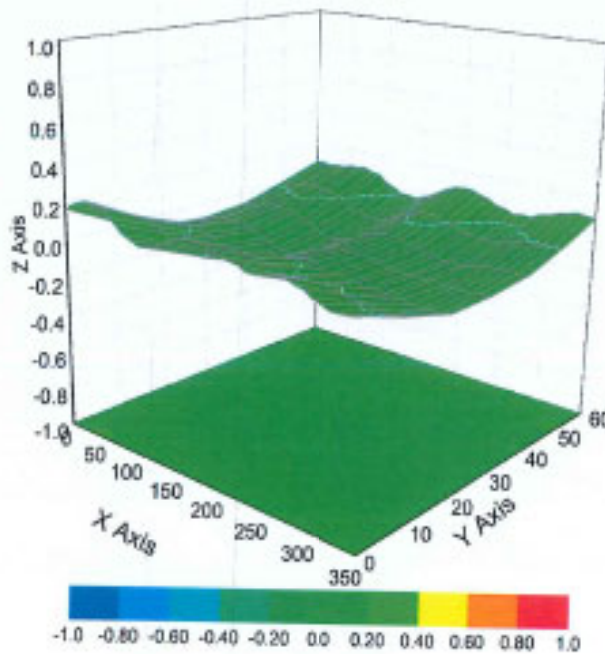

Uncertainty of Spherical Isotropy Assessment:  $\pm 3.2\%$  ( $k=2$ )



## DASY/EASY – Parameters of Probe: ES3DV3 – SN:3090

### Other Probe Parameters

Sensor Arrangement	Triangular
Connector Angle (°)	2.2
Mechanical Surface Detection Mode	enabled
Optical Surface Detection Mode	disable
Probe Overall Length	337mm
Probe Body Diameter	10mm
Tip Length	10mm
Tip Diameter	4mm
Probe Tip to Sensor X Calibration Point	2mm
Probe Tip to Sensor Y Calibration Point	2mm
Probe Tip to Sensor Z Calibration Point	2mm
Recommended Measurement Distance from Surface	3mm



In Collaboration with  
**s p e a g**  
CALIBRATION LABORATORY



中国认可  
国际互认  
校准  
CALIBRATION  
CNAS L0570

Add: No.52 HuaYuanBei Road, Haidian District, Beijing, 100191, China  
Tel: +86-10-62304633-2512 Fax: +86-10-62304631-2504  
E-mail: cttl@chinattl.com [Http://www.chinattl.cn](http://www.chinattl.cn)

Client : **UnionTrust**

Certificate No: **Z21-60110**

## CALIBRATION CERTIFICATE

Object **DAE4 - SN: 662**

Calibration Procedure(s) **FF-Z11-002-01**  
Calibration Procedure for the Data Acquisition Electronics (DAEx)

Calibration date: **April 09, 2021**

This calibration Certificate documents the traceability to national standards, which realize the physical units of measurements(SI). The measurements and the uncertainties with confidence probability are given on the following pages and are part of the certificate.

All calibrations have been conducted in the closed laboratory facility: environment temperature(22±3)°C and humidity<70%.

Calibration Equipment used (M&TE critical for calibration)

Primary Standards	ID #	Cal Date(Calibrated by, Certificate No.)	Scheduled Calibration
Process Calibrator 753	1971018	16-Jun-20 (CTTL, No.J20X04342)	Jun-21

	Name	Function	Signature
Calibrated by:	Yu Zongying	SAR Test Engineer	
Reviewed by:	Lin Hao	SAR Test Engineer	
Approved by:	Qi Dianyuan	SAR Project Leader	

Issued: April 11, 2021

This calibration certificate shall not be reproduced except in full without written approval of the laboratory.



In Collaboration with

**s p e a g**

**CALIBRATION LABORATORY**

Add: No.52 HuaYuanBei Road, Haidian District, Beijing, 100191, China

Tel: +86-10-62304633-2512

Fax: +86-10-62304633-2504

E-mail: [cttl@chinattl.com](mailto:cttl@chinattl.com)

[Http://www.chinattl.cn](http://www.chinattl.cn)

### **Glossary:**

DAE data acquisition electronics  
Connector angle information used in DASY system to align probe sensor X to the robot coordinate system.

### **Methods Applied and Interpretation of Parameters:**

- *DC Voltage Measurement:* Calibration Factor assessed for use in DASY system by comparison with a calibrated instrument traceable to national standards. The figure given corresponds to the full scale range of the voltmeter in the respective range.
- *Connector angle:* The angle of the connector is assessed measuring the angle mechanically by a tool inserted. Uncertainty is not required.
- The report provide only calibration results for DAE, it does not contain other performance test results.



Add: No.52 HuaYuanBei Road, Haidian District, Beijing, 100191, China  
Tel: +86-10-62304633-2512 Fax: +86-10-62304633-2504  
E-mail: cttl@chinattl.com Http://www.chinattl.cn

### DC Voltage Measurement

A/D - Converter Resolution nominal

High Range: 1LSB = 6.1 $\mu$ V, full range = -100...+300 mV

Low Range: 1LSB = 61nV, full range = -1.....+3mV

DASY measurement parameters: Auto Zero Time: 3 sec; Measuring time: 3 sec

Calibration Factors	X	Y	Z
High Range	404.480 $\pm$ 0.15% (k=2)	404.376 $\pm$ 0.15% (k=2)	404.749 $\pm$ 0.15% (k=2)
Low Range	3.97768 $\pm$ 0.7% (k=2)	3.98081 $\pm$ 0.7% (k=2)	3.97674 $\pm$ 0.7% (k=2)

### Connector Angle

Connector Angle to be used in DASY system	22 $^{\circ}$ $\pm$ 1 $^{\circ}$
---	----------------------------------



In Collaboration with  
**s p e a g**  
CALIBRATION LABORATORY



中国认可  
国际互认  
校准  
CALIBRATION  
CNAS L0570

Add: No.52 HuaYuanBei Road, Haidian District, Beijing, 100191, Chi  
Tel: +86-10-62304633-2079 Fax: +86-10-62304633-2504  
E-mail: ctt@chinattl.com http://www.chinattl.cn

Client

TUV-CN

Certificate No: Z21-60202

## CALIBRATION CERTIFICATE

Object D2450V2 - SN: 1014

Calibration Procedure(s) FF-Z11-003-01  
Calibration Procedures for dipole validation kits

Calibration date: May 19, 2021

This calibration Certificate documents the traceability to national standards, which realize the physical units of measurements (SI). The measurements and the uncertainties with confidence probability are given on the following pages and are part of the certificate.

All calibrations have been conducted in the closed laboratory facility: environment temperature (22±3)°C and humidity<70%.

Calibration Equipment used (M&TE critical for calibration)

Primary Standards	ID #	Cal Date(Calibrated by, Certificate No.)	Scheduled Calibration
Power Meter NRP2	106277	23-Sep-20 (CTTL, No.J20X08336)	Sep-21
Power sensor NRP8S	104291	23-Sep-20 (CTTL, No.J20X08336)	Sep-21
ReferenceProbe EX3DV4	SN 3846	26-Apr-21(CTTL-SPEAG,No.Z21-60084)	Apr-22
DAE4	SN 777	08-Jan-21(CTTL-SPEAG,No.Z21-60003)	Jan-22
Secondary Standards	ID #	Cal Date(Calibrated by, Certificate No.)	Scheduled Calibration
Signal Generator E4438C	MY49071430	01-Feb-21 (CTTL, No.J21X00593)	Jan-22
NetworkAnalyzer E5071C	MY46110673	14-Jan-21 (CTTL, No.J21X00232)	Jan-22

	Name	Function	Signature
Calibrated by:	Zhao Jing	SAR Test Engineer	
Reviewed by:	Lin Hao	SAR Test Engineer	
Approved by:	Qi Dianyuan	SAR Project Leader	

Issued: May 24, 2021

This calibration certificate shall not be reproduced except in full without written approval of the laboratory.



In Collaboration with  
**s p e a g**  
CALIBRATION LABORATORY

Add: No.52 HuaYuanBei Road, Haidian District, Beijing, 100191, China  
Tel: +86-10-62304633-2079 Fax: +86-10-62304633-2504  
E-mail: [ctrl@chinattl.com](mailto:ctrl@chinattl.com) <http://www.chinattl.cn>

#### Glossary:

TSL	tissue simulating liquid
ConvF	sensitivity in TSL / NORM <sub>x,y,z</sub>
N/A	not applicable or not measured

#### Calibration is Performed According to the Following Standards:

- IEEE Std 1528-2013, "IEEE Recommended Practice for Determining the Peak Spatial-Averaged Specific Absorption Rate (SAR) in the Human Head from Wireless Communications Devices: Measurement Techniques", June 2013
- IEC 62209-1, "Measurement procedure for assessment of specific absorption rate of human exposure to radio frequency fields from hand-held and body-mounted wireless communication devices- Part 1: Device used next to the ear (Frequency range of 300MHz to 6GHz)", July 2016
- IEC 62209-2, "Procedure to measure the Specific Absorption Rate (SAR) For wireless communication devices used in close proximity to the human body (frequency range of 30MHz to 6GHz)", March 2010
- KDB865664, SAR Measurement Requirements for 100 MHz to 6 GHz

#### Additional Documentation:

- DASY4/5 System Handbook

#### Methods Applied and Interpretation of Parameters:

- Measurement Conditions:** Further details are available from the Validation Report at the end of the certificate. All figures stated in the certificate are valid at the frequency indicated.
- Antenna Parameters with TSL:** The dipole is mounted with the spacer to position its feed point exactly below the center marking of the flat phantom section, with the arms oriented parallel to the body axis.
- Feed Point Impedance and Return Loss:** These parameters are measured with the dipole positioned under the liquid filled phantom. The impedance stated is transformed from the measurement at the SMA connector to the feed point. The Return Loss ensures low reflected power. No uncertainty required.
- Electrical Delay:** One-way delay between the SMA connector and the antenna feed point. No uncertainty required.
- SAR measured:** SAR measured at the stated antenna input power.
- SAR normalized:** SAR as measured, normalized to an input power of 1 W at the antenna connector.
- SAR for nominal TSL parameters:** The measured TSL parameters are used to calculate the nominal SAR result.

The reported uncertainty of measurement is stated as the standard uncertainty of Measurement multiplied by the coverage factor  $k=2$ , which for a normal distribution Corresponds to a coverage probability of approximately 95%.



Add: No.32 HuaYuanBei Road, Haidian District, Beijing, 100191, China  
Tel: +86-10-62304633-2079 Fax: +86-10-62304633-2504  
E-mail: ctf@chinattl.com http://www.chinattl.cn

### Measurement Conditions

DASY system configuration, as far as not given on page 1.

DASY Version	DASY52	V52.10.4
Extrapolation	Advanced Extrapolation	
Phantom	Triple Flat Phantom 5.1C	
Distance Dipole Center - TSL	10 mm	with Spacer
Zoom Scan Resolution	dx, dy, dz = 5 mm	
Frequency	2450 MHz $\pm$ 1 MHz	

### Head TSL parameters

The following parameters and calculations were applied.

	Temperature	Permittivity	Conductivity
Nominal Head TSL parameters	22.0 °C	39.2	1.80 mho/m
Measured Head TSL parameters	(22.0 $\pm$ 0.2) °C	39.4 $\pm$ 6 %	1.79 mho/m $\pm$ 6 %
Head TSL temperature change during test	<1.0 °C	---	---

### SAR result with Head TSL

SAR averaged over 1 $cm^3$ (1 g) of Head TSL	Condition	
SAR measured	250 mW input power	12.9 W/kg
SAR for nominal Head TSL parameters	normalized to 1W	51.8 W/kg $\pm$ 18.8 % ( $k=2$ )
SAR averaged over 10 $cm^3$ (10 g) of Head TSL	Condition	
SAR measured	250 mW input power	5.89 W/kg
SAR for nominal Head TSL parameters	normalized to 1W	23.6 W/kg $\pm$ 18.7 % ( $k=2$ )





## Appendix (Additional assessments outside the scope of CNAS L0570)

### Antenna Parameters with Head TSL

Impedance, transformed to feed point	53.8Ω- 1.16jΩ
Return Loss	- 28.3dB

### General Antenna Parameters and Design

Electrical Delay (one direction)	1.053 ns
----------------------------------	----------

After long term use with 100W radiated power, only a slight warming of the dipole near the feedpoint can be measured.

The dipole is made of standard semirigid coaxial cable. The center conductor of the feeding line is directly connected to the second arm of the dipole. The antenna is therefore short-circuited for DC-signals. On some of the dipoles, small end caps are added to the dipole arms in order to improve matching when loaded according to the position as explained in the "Measurement Conditions" paragraph. The SAR data are not affected by this change. The overall dipole length is still according to the Standard. No excessive force must be applied to the dipole arms, because they might bend or the soldered connections near the feedpoint may be damaged.

### Additional EUT Data

Manufactured by	SPEAG
-----------------	-------



**DASY5 Validation Report for Head TSL**

Date: 05.19.2021

Test Laboratory: CTTL, Beijing, China

**DUT: Dipole 2450 MHz; Type: D2450V2; Serial: D2450V2 - SN: 1014**

Communication System: UID 0, CW; Frequency: 2450 MHz; Duty Cycle: 1:1

Medium parameters used:  $f = 2450$  MHz;  $\sigma = 1.788$  S/m;  $\epsilon_r = 39.43$ ;  $\rho = 1000$  kg/m<sup>3</sup>

Phantom section: Center Section

DASY5 Configuration:

- Probe: EX3DV4 - SN3846; ConvF(7.45, 7.45, 7.45) @ 2450 MHz; Calibrated: 2021-04-26
- Sensor-Surface: 1.4mm (Mechanical Surface Detection)
- Electronics: DAE4 Sn777; Calibrated: 2021-01-08
- Phantom: MFP\_V5.1C (20deg probe tilt); Type: QD 000 P51 Cx; Serial: 1062
- Measurement SW: DASY52, Version 52.10 (4); SEMCAD X Version 14.6.14 (7483)

**Dipole Calibration/Zoom Scan (7x7x7) (7x7x7)/Cube 0: Measurement grid: dx=5mm, dy=5mm, dz=5mm**

Reference Value = 105.6 V/m; Power Drift = -0.04 dB

Peak SAR (extrapolated) = 27.5 W/kg

**SAR(1 g) = 12.9 W/kg; SAR(10 g) = 5.89 W/kg**

Smallest distance from peaks to all points 3 dB below = 9 mm

Ratio of SAR at M2 to SAR at M1 = 46.5%

Maximum value of SAR (measured) = 22.1 W/kg

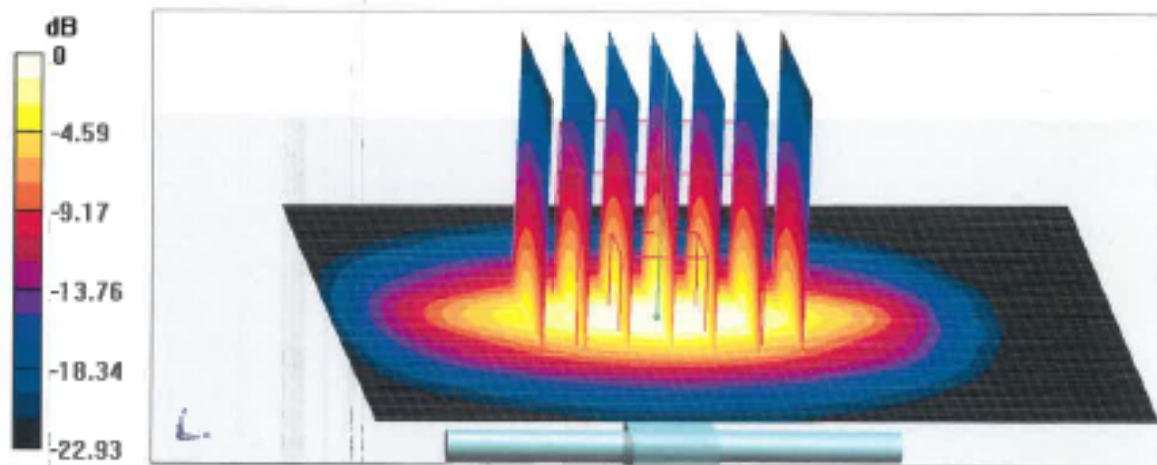

0 dB = 22.1 W/kg = 13.44 dBW/kg



Add: No.52 HuaYuanBei Road, Haidian District, Beijing, 100191, China  
Tel: +86-10-62304633-2079 Fax: +86-10-62304633-2504  
E-mail: cttl@chinatrl.com http://www.chinatrl.cn

### Impedance Measurement Plot for Head TSL

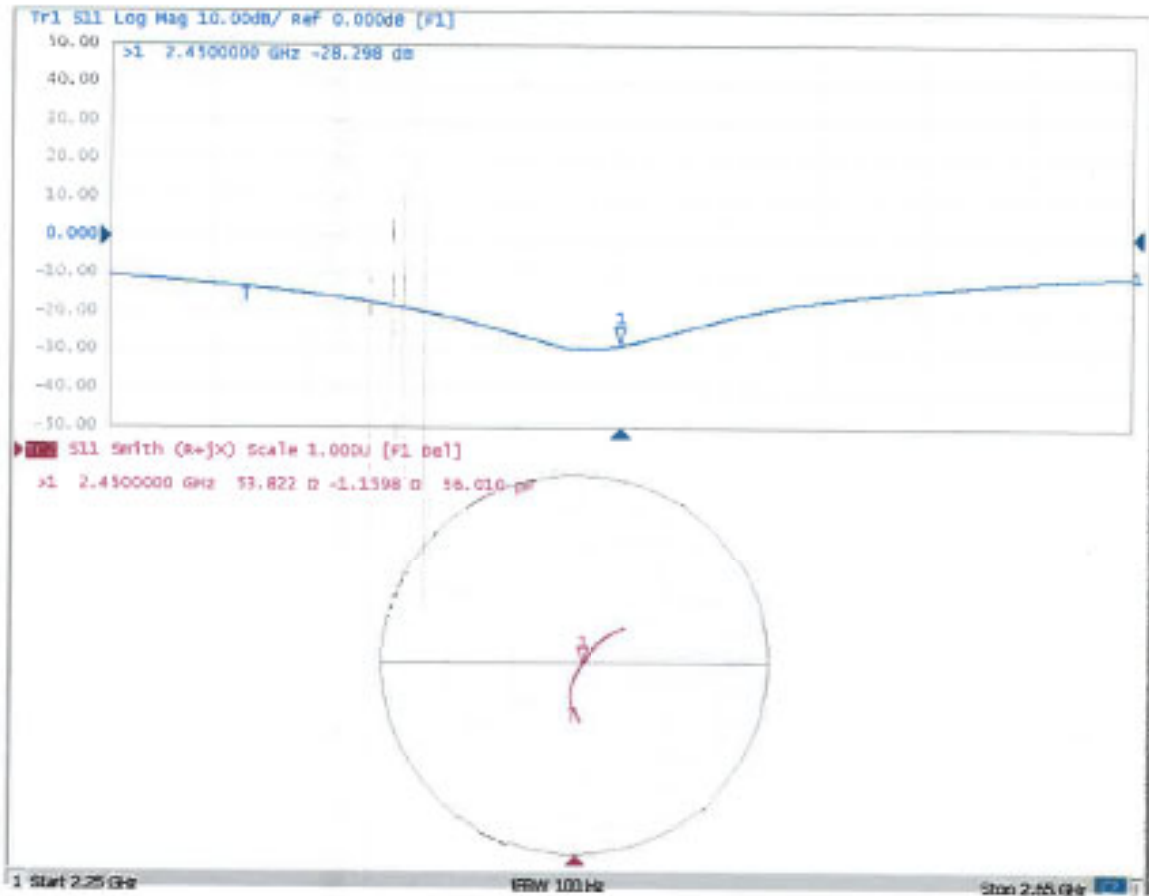

**TEST REPORT**

**APPENDIX D – SAR SYSTEM VALIDATION**

Per KDB 865664, SAR system validation status should be documented to confirm measurement accuracy. SAR measurement systems are validated according to procedures in KDB 865664. The validation status is documented according to the validation date(s), measurement frequencies, SAR probe and tissue dielectric parameters. When multiple SAR system is used, the validation status of each SAR system is needed to be documented separately according to the associated system components.

A tabulated summary of the system validation status including the validation date(s), measurement frequencies, SAR probe and tissue dielectric parameters are shown as below.

Date	Probe S/N	Tested Freq. (MHz)	Tissue Type	Perm	Cond	CW Validation			Mod. Validation		
						Sensitivity	Probe Linearity	Probe Isotropy	Mod. Type	Duty Factor	Peak to average power ratio
26/04/2021	3090	2450	Head	40.20	1.78	PASS	PASS	PASS	OFDM	N/A	PASS