

## TEST REPORT

**Report Number: 21051283HKG-002**

Application for Original Grant of 47 CFR Part 15 Certification  
New Family of RSS-247 Issue 2 Equipment

**FCC ID: EW780-2517-01**

**IC: 1135B-80251701**

**Prepared and Checked by:**

**Approved by:**

Signed On File  
Wong Cheuk Ho, Herbert  
Lead Engineer

---

Tang Kwan Mo, Jess  
Lead Engineer  
Date: July 09, 2021

## TEST REPORT

### GENERAL INFORMATION

<b>Applicant Name:</b>	VTech Telecommunications Ltd.
<b>Applicant Address:</b>	23/F., Tai Ping Industrial Centre, Block 1, 57 Ting Kok Road, Tai Po, Hong Kong.
<b>Manufacturer Name:</b>	VTech (Dongguan) Telecommunications Limited.
<b>Manufacturer Address:</b>	VTech Science Park, Xia Ling Bei Management Zone, Liaobu, Dongguan, Guangdong, China.
<b>FCC Specification Standard:</b>	FCC Part 15, October 1, 2020 Edition
<b>FCC ID:</b>	EW780-2517-01
<b>FCC Model(s):</b>	LF815HD PU, LF815-2HD PU, LF815-abHD PU, LF925HD PU, LF925-2HD PU, LF925-abHD PU
<b>IC Specification Standard:</b>	RSS-247 Issue 2, February 2017 RSS-Gen Issue 5, February 2021
<b>IC:</b>	1135B-80251701
<b>PMN:</b>	LF815HD PU, LF815-2HD PU, LF925HD PU, LF925-2HD PU
<b>HVIN:</b>	35-400369PU
<b>VTech Model(s):</b>	LF815HD PU, LF815-2HD PU, LF925HD PU, LF925-2HD PU
<b>Type of EUT:</b>	Spread Spectrum Transmitter
<b>Description of EUT:</b>	Video Monitor - Parent Unit
<b>Sample Receipt Date:</b>	June 20, 2021
<b>Date of Test:</b>	June 21 - 28, 2021
<b>Report Date:</b>	July 09, 2021
<b>Environmental Conditions:</b>	Temperature: +10 to 40°C Humidity: 10 to 90%
<b>Conclusion:</b>	Test was conducted by client submitted sample. The submitted sample as received complied with the 47 CFR Part 15 / RSS-247 Issue 2 Certification.

**TEST REPORT**

**TABLE OF CONTENTS**

**1.0 TEST RESULTS SUMMARY & STATEMENT OF COMPLIANCE ..... 4**

    1.1 Summary of Test Results.....4

    1.2 Statement of Compliance.....4

**2.0 GENERAL DESCRIPTION..... 5**

    2.1 Product Description .....5

    2.2 Test Methodology .....6

    2.3 Test Facility .....6

    2.4 Related Submittal(s) Grants .....6

**3.0 SYSTEM TEST CONFIGURATION..... 7**

    3.1 Justification .....7

    3.2 EUT Exercising Software.....8

    3.3 Details of EUT and Description of Accessories.....9

    3.4 Measurement Uncertainty .....9

**4.0 TEST RESULTS ..... 10**

    4.1 Maximum Conducted Output Power at Antenna Terminals .....10

    4.2 Minimum 6dB RF Bandwidth.....12

    4.3 Maximum Power Spectral Density .....19

    4.4 Out of Band Conducted Emissions .....26

    4.5 Field Strength Calculation.....39

    4.6 Transmitter Radiated Emissions in Restricted Bands and Spurious Emissions.....40

        4.6.1 Radiated Emission Configuration Photograph .....40

        4.6.2 Radiated Emission Data .....40

        4.6.3 Radiated Emission Test Setup.....51

        4.6.4 Transmitter Duty Cycle Calculation .....52

    4.7 AC Power Line Conducted Emission .....53

        4.7.1 AC Power Line Conducted Emission Configuration Photograph .....53

        4.7.2 AC Power Line Conducted Emission Data .....53

        4.7.3 Conducted Emission Test Setup .....56

**5.0 EQUIPMENT LIST ..... 57**

## TEST REPORT

### 1.0 TEST RESULTS SUMMARY & STATEMENT OF COMPLIANCE

#### 1.1 Summary of Test Results

Test Items	FCC Part 15 Section	RSS-247/ RSS-Gen# Section	Results	Details See Section
Antenna Requirement	15.203	6.8#	Pass	2.1
Max. Conducted Output Power (Average)	15.247(b)(3)&(4)	5.4(e)	Pass	4.1
Min. 6dB RF Bandwidth	15.247(a)(2)	5.2(a)	Pass	4.2
Max. Power Density (average)	15.247(e)	5.2(b)	Pass	4.3
Out of Band Antenna Conducted Emission	15.247(d)	5.5	Pass	4.4
Radiated Emission in Restricted Bands and Spurious Emissions	15.247(d), 15.209 & 15.109	5.5	Pass	4.6
AC Power Line Conducted Emission	15.207 & 15.107	7.2#	Pass	4.7

Note: Pursuant to FCC Part 15 Section 15.215(c), the 20dB bandwidth of the emission was contained within the frequency band designated (mentioned as above) which the EUT operated. The effects, if any, from frequency sweeping, frequency hopping, other modulation techniques and frequency stability over expected variations in temperature and supply voltage were considered.

#### 1.2 Statement of Compliance

The equipment under test is found to be complying with the following standard:

FCC Part 15, October 1, 2019 Edition  
RSS-247 Issue 2, February 2017  
RSS-Gen Issue 5, February 2021

## TEST REPORT

### 2.0 GENERAL DESCRIPTION

#### 2.1 Product Description

The LF815HD PU (35-400369PU) is a Video Monitor - Parent Unit.

The Equipment Under Test (EUT) operates at frequency range of 2412MHz to 2462MHz with 11 channels.

For 802.11b mode, it operates at frequency range of 2412.000MHz to 2462.000MHz with 11 channels. It transmits via Direct-sequence spread spectrum (DSSS) modulation. Maximum bit rate can be up to 11Mbps.

For 802.11g mode, it operates at frequency range of 2412.000MHz to 2462.000MHz with 11 channels. It transmits via Orthogonal Frequency Division Multiplexing (OFDM) modulation. Maximum bit rate can be up to 54Mbps.

For 802.11n (with 20MHz bandwidth) mode, it operates at frequency range of 2412.000MHz to 2462.000MHz with 11 channels. It transmits via Orthogonal Frequency Division Multiplexing (OFDM) modulation. Maximum bit rate can support up to 65Mbps.

The EUT is power by a 3.7VDC (1 x 3.7V 5000mAh 18.5Wh Li-Polymer rechargeable battery) and 100-240VAC 50/60Hz 0.5A adaptor.

The antenna(s) used in the EUT is integral, and the test sample is a prototype.

For FCC, the Model(s): LF815-2HD PU, LF815-abHD PU, LF925HD PU, LF925-2HD PU and LF925-abHD PU are the same as the Model: LF815HD PU in electronics/electrical designs including software & firmware, PCB layout and construction design/physical design/enclosure as declared by client. The only differences between these models are color and model number to be sold for marketing purpose as declared by client. Suffix ("a, b") indicates different number of baby unit and different color of enclosure as declared by client.

The circuit description is saved with filename: descri.pdf.

## TEST REPORT

### 2.2 Test Methodology

Both AC power line-conducted and radiated emission measurements were performed according to the procedures in ANSI C63.10 (2013). Preliminary radiated scans and all radiated measurements were performed in radiated emission test sites. All Radiated tests were performed at an antenna to EUT distance of 3 meters, unless stated otherwise in the "**Justification Section**" of this Application. Antenna port conducted measurements were performed according to ANSI C63.10 (2013) and KDB Publication No.558074 D01 v05r01 (11-February-2019). All other measurements were made in accordance with the procedures in 47 CFR Part 2 and RSS-Gen Issue 5 (2021).

### 2.3 Test Facility

The radiated emission test site and antenna port conducted measurement facility used to collect the radiated data and conductive data are at Workshop No. 3, G/F., World-Wide Industrial Centre, 43-47 Shan Mei Street, Fo Tan, Sha Tin, N.T., Hong Kong SAR, China. This test facility and site measurement data have been fully placed on file with the FCC and Industry Canada No.: 2042H, CABID: HKAP01.

### 2.4 Related Submittal(s) Grants

This is a single application for certification of a transceiver (WiFi portion)

## TEST REPORT

### 3.0 SYSTEM TEST CONFIGURATION

#### 3.1 Justification

For radiated emissions testing, the equipment under test (EUT) was setup to transmit / receive continuously to simplify the measurement methodology. Care was taken to ensure proper power supply voltages during testing. During testing, all cables (if any) were manipulated to produce worst case emissions.

The EUT was powered by a 3.7VDC (1 x 3.7V 5000mAh 18.5Wh Li-Polymer rechargeable battery) and 100-240VAC 50/60Hz 0.5A adaptor.

For the measurements, the EUT was attached to a plastic stand if necessary and placed on the wooden turntable at 0.8m height from the ground plane for emission testing at or below 1GHz and 1.5m for emission measurements above 1GHz. If the baby unit attached to peripherals, they were connected and operational (as typical as possible). The parent unit was remotely located as far from the antenna and the baby as possible to ensure full power transmission from the parent unit. Else, the base was wired to transmit full power with modulation.

The signal was maximized through rotation and placement in the three orthogonal axes. The antenna height and polarization were varied during the search for maximum signal level. The antenna height was varied from 1 to 4 meters. Radiated emissions were taken at three meters unless the signal level was too low for measurement at that distance. If necessary, a pre-amplifier was used and/or the test was conducted at a closer distance.

For any intentional radiator powered by AC power line, measurements of the radiated signal level of the fundamental frequency component of the emission was performed with the supply voltage varied between 85% and 115% of the nominal rated supply voltage.

Radiated emission measurement for transmitter were performed from the lowest radio frequency signal generated in the device which is greater than 9 kHz to the tenth harmonic of the highest fundamental frequency or to 40 GHz, whichever is lower.

Emission that are directly caused by digital circuits in the transmit path and transmitter portion were measured, and the limit are according to FCC Part 15 Section 15.209 / RSS-247 2.5. Digital circuitries used to control additional functions other than the operation of the transmitter are subject to FCC Part 15 Section 15.109 / RSS-247 Section 5.5 Limits.

## TEST REPORT

### 3.1 Justification – Cont'd

Detector function for radiated emissions was in peak mode. Average readings, when required, were taken by measuring the duty cycle of the equipment under test and subtracting the corresponding amount in dB from the measured peak readings. A detailed description for the calculation of the average factor can be found in section 4.8.3.

Determination of pulse desensitization was made according to *Hewlett Packard Application Note 150-2, Spectrum Analysis... Pulsed RF*. The effective period (Teff) was referred to Exhibit 4.8.3. With the resolution bandwidth 1MHz and spectrum analyzer IF bandwidth 3dB, the pulse desensitization factor was 0dB.

For AC line conducted emission test, the EUT along with its peripherals were placed on a 1.0m(W)x1.5m(L) and 0.8m in height wooden table and the EUT was adjusted to maintain a 0.4 meter space from a vertical reference plane. The EUT was connected to power mains through a line impedance stabilization network (LISN), which provided 50ohm coupling impedance for measuring instrument. The LISN housing, measuring instrument case, reference ground plane, and vertical ground plane were bounded together. The excess power cable between the EUT and the LISN was bundled.

All connecting cables of EUT and peripherals were manipulated to find the maximum emission.

Different data rates have been tested. Worst case is reported only.

All relevant operation modes have been tested, and the worst case data is included in this report.

All data rates were tested under normal mode of WiFi. Only the worst-case data is shown in the report for DSSS and OFDM

### 3.2 EUT Exercising Software

The EUT exercise program (Tera Terms Version 4.57) used during radiated and conducted testing was designed to exercise the various system components in a manner similar to a typical use.



## TEST REPORT

### 3.3 Details of EUT and Description of Accessories

#### Details of EUT:

An AC adaptor (provided with the unit) was used to power the device. Their description are listed below.

- (1) Internal Li-Polymer rechargeable battery (3.7V 5000mAh 18.5Wh, Model: GSP806090-5Ah-3.7V-1S1P)
- (2) An AC adaptor (100-240VAC 50/60Hz 0.5A to 5.0VDC 2.0A 10W, Model: VT07EUS05200, Brand VTPL) (Provided by Client)

#### Description of Accessories:

- (1) Baby Unit (FCC ID: EW780-2517-00) (Provided by Client)

### 3.4 Measurement Uncertainty

Decision Rule for compliance: For FCC/IC standard, the measured value must be within the limits of applicable standard without accounting for the measurement uncertainty. For EN/IEC/HKTA/HKTC standard, conformity rules will be used as per standard directly excepted EN/IEC 61000-3-2, EN/IEC 61000-3-3, HKTA1004, HKCA1008, HKTA1019, HKTA1020, HKTA1041 and HKTA1044. For these excepted or not mentioned standards, Cl 4.2.2 of ILAC-G8:09/2019 decision rules will be reference and guard band will be equal to our measurement uncertainty with 95% confidence level (k=2). In case, the measured value is within guard band region, undetermined decision will be used. The values of the Measurement uncertainty for radiated emission test and RF conducted measurement test are  $\pm 5.3\text{dB}$  and  $\pm 0.99\text{dB}$  respectively. The value of the Measurement uncertainty for conducted emission test is  $\pm 4.2\text{dB}$ .

Uncertainty and Compliance - Unless the standard specifically states that measured values are to be extended by the measurement uncertainty in determining compliance, all compliance determinations are based on the actual measured value.

## TEST REPORT

### 4.0 TEST RESULTS

#### 4.1 Maximum Conducted (peak) Output Power at Antenna Terminals

##### RF Conduct Measurement Test Setup

The figure below shows the test setup, which is utilized to make these measurements.

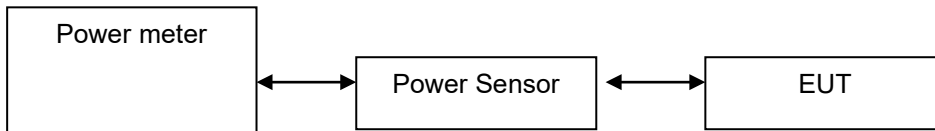

The antenna port of the EUT was connected to the input of a spectrum analyzer.

- The antenna power of the EUT was connected to the input of a power meter. Power was read directly and cable loss correction was added to the reading to the obtain power at the EUT antenna terminals. The measurement procedure 8.3.2.3 was used.
- The EUT should be configured to transmit continuously (at a minimum duty cycle of 98%) at full power over the measurement duration. The measurement procedure AVG1 was used.

##### IEEE 802.11b (DSSS, 1 Mbps) Antenna Gain = 2 dBi

Frequency (MHz)	Output in dBm	Output in mWatt
Low Channel: 2412	14.5	28.2
Middle Channel: 2437	15.3	33.9
High Channel: 2462	15.4	34.7

##### IEEE 802.11g (OFDM, 6 Mbps) Antenna Gain = 2 dBi

Frequency (MHz)	Output in dBm	Output in mWatt
Low Channel: 2412	19.1	81.3
Middle Channel: 2437	20.0	100.0
High Channel: 2462	20.1	102.3

**TEST REPORT**

4.1 Maximum Conducted Output Power at Antenna Terminals – Cont’d

IEEE 802.11n (20MHz) (OFDM, MCS0) Antenna Gain = 2 dBi

Frequency (MHz)	Output in dBm	Output in mWatt
Low Channel: 2412	19.3	85.1
Middle Channel: 2437	19.5	89.1
High Channel: 2462	20.0	100.0

Cable loss : 0.5 dB External Attenuation : 0 dB

Cable loss, external attenuation:  included in OFFSET function  
 added to SA raw reading

IEEE 802.11b (DSSS, 1 Mbps)  
max. conducted (peak) output level = 15.4 dBm

IEEE 802.11g (OFDM, 9 Mbps)  
max. conducted (peak) output level = 20.1 dBm

IEEE 802.11n (20MHz) (OFDM, MCS0)  
max. conducted (peak) output level = 20.0 dBm

Limits:  
 1W (30dBm) for antennas with gains of 6dBi or less

\_\_\_W (\_\_\_dBm) for antennas with gains more than 6dBi

**TEST REPORT**

4.2 Minimum 6dB RF Bandwidth

The antenna port of the EUT was connected to the input of a spectrum analyzer. The EBW measurement procedure was used. A PEAK output reading was taken, a DISPLAY line was drawn 6dB lower than PEAK level. The 6dB bandwidth was determined from where the channel output spectrum intersected the display line.

IEEE 802.11b (DSSS, 1 Mbps)

Frequency (MHz)	6dB Bandwidth (MHz)
Low Channel: 2412	10.24
Middle Channel: 2437	10.24
High Channel: 2462	10.24

IEEE 802.11g (OFDM, 6 Mbps)

Frequency (MHz)	6dB Bandwidth (MHz)
Low Channel: 2412	16.72
Middle Channel: 2437	16.72
High Channel: 2462	16.64

IEEE 802.11n (20MHz) (OFDM, MCS0)

Frequency (MHz)	6dB Bandwidth (MHz)
Low Channel: 2412	16.72
Middle Channel: 2437	16.72
High Channel: 2462	16.72

Limits

6 dB bandwidth shall be at least 500kHz

The plots of 6dB RF bandwidth are saved as below.

**TEST REPORT**

**PLOTS OF 6dB RF BANDWIDTH**

**802.11b, Lowest Channel**

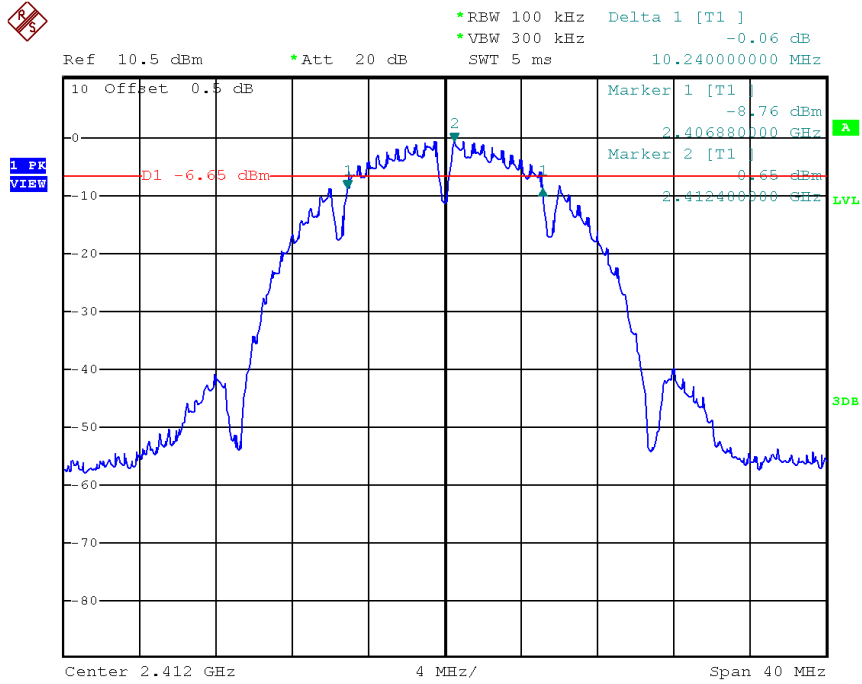

**802.11b, Middle Channel**

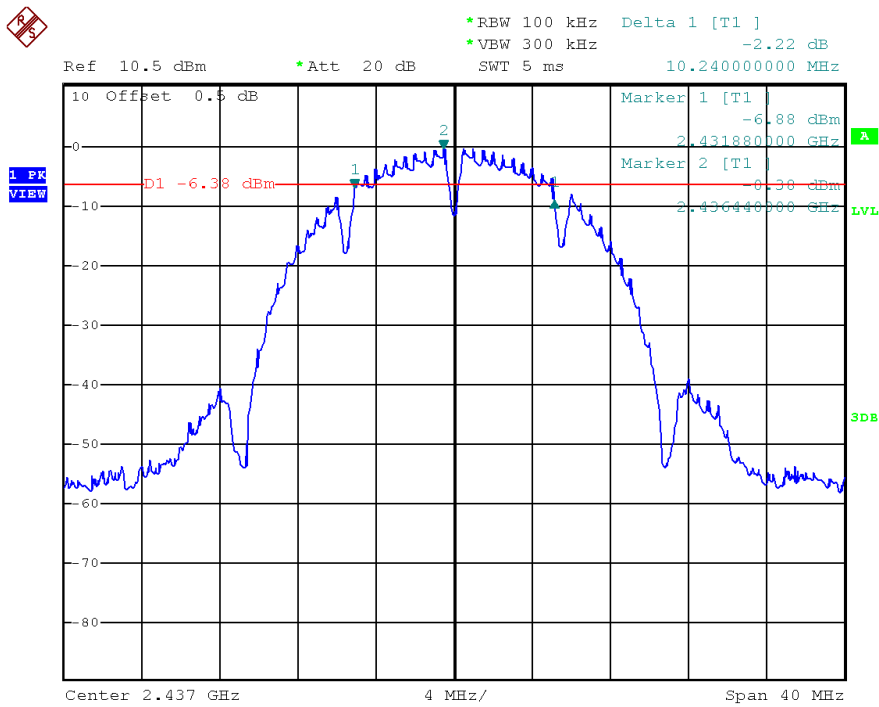

**TEST REPORT**

**PLOTS OF 6dB RF BANDWIDTH**

802.11b, Highest Channel

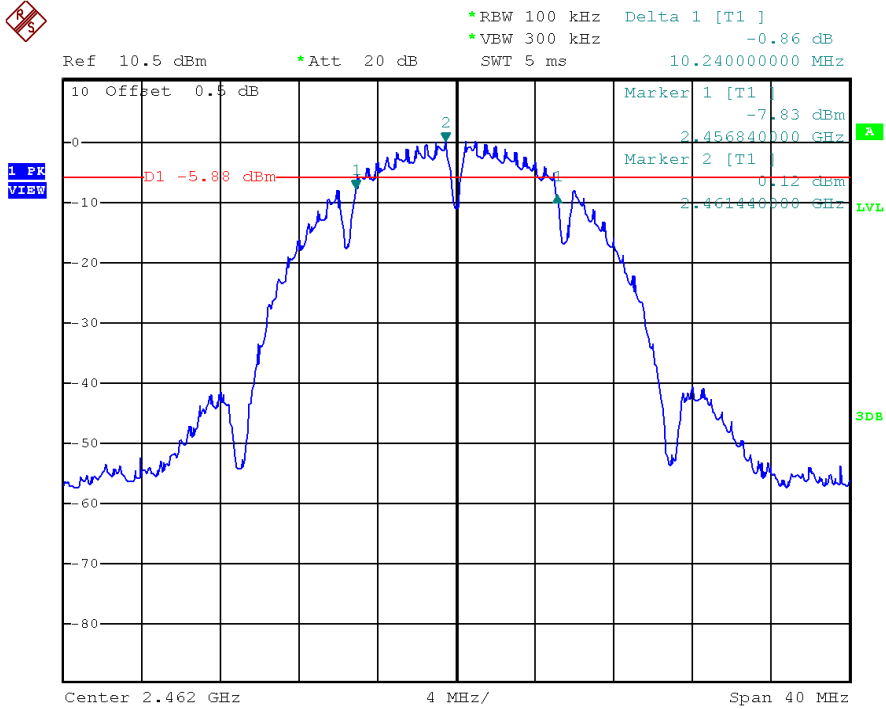

**TEST REPORT**

**PLOTS OF 6dB RF BANDWIDTH**

802.11g, Lowest Channel

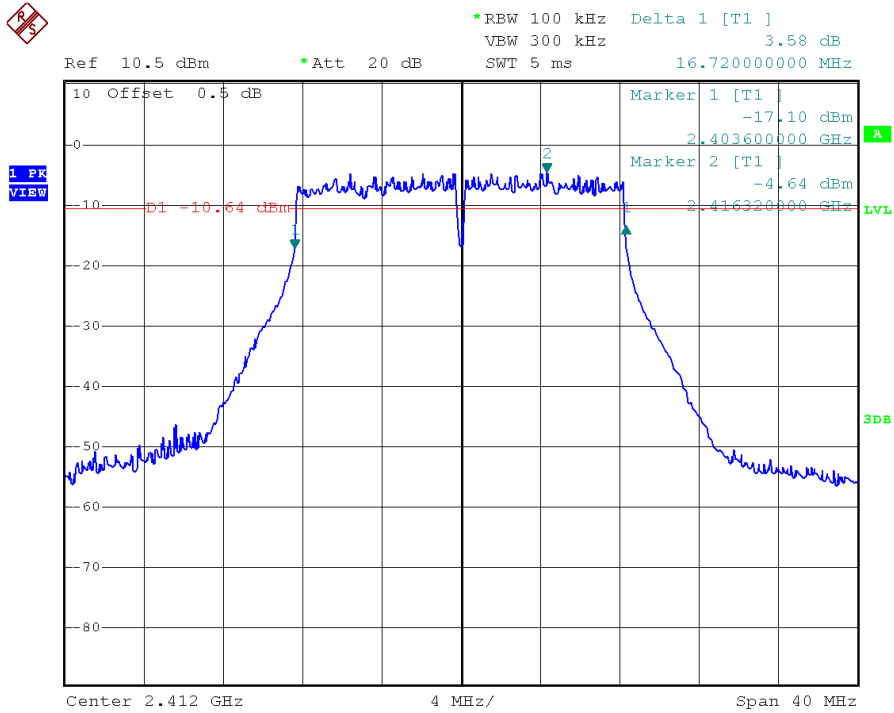

802.11g, Middle Channel

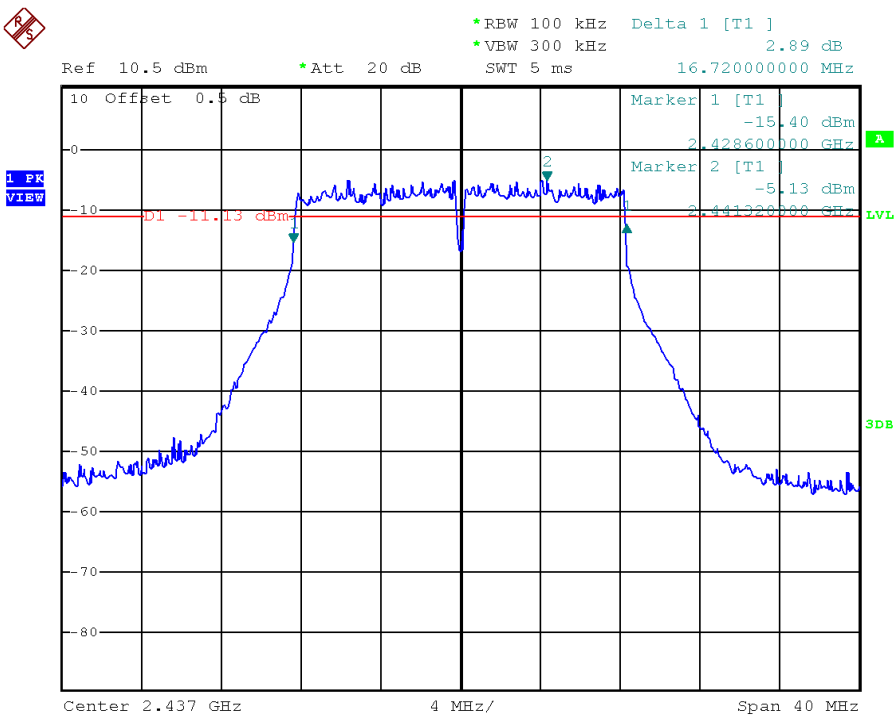

**TEST REPORT**

**PLOTS OF 6dB RF BANDWIDTH**

802.11g, Highest Channel

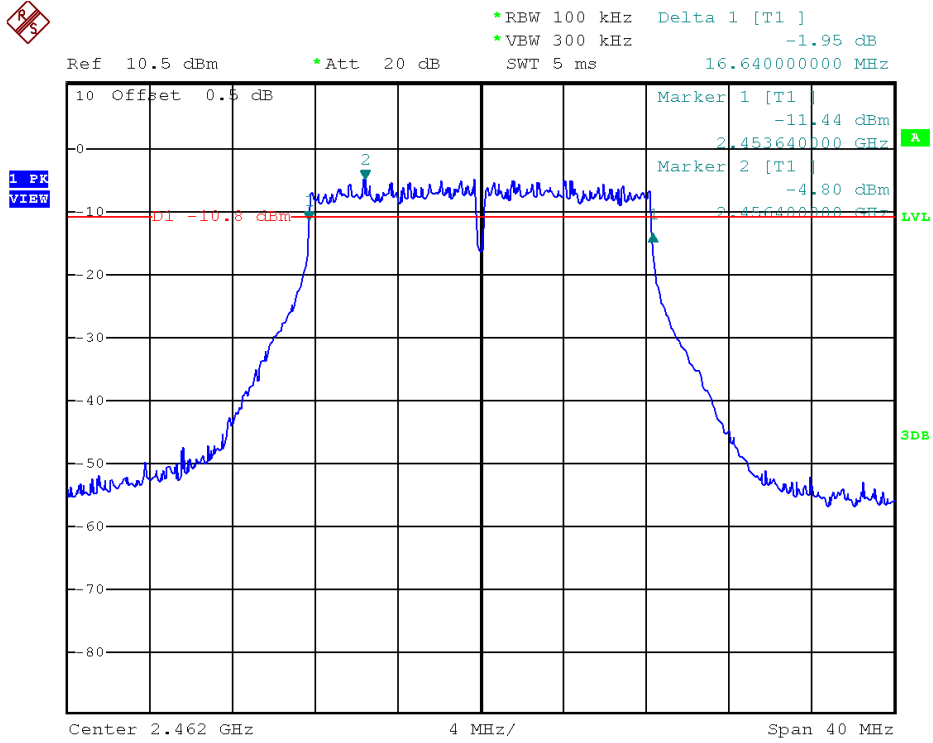



**TEST REPORT**

**PLOTS OF 6dB RF BANDWIDTH**

802.11n (20MHz), Lowest Channel

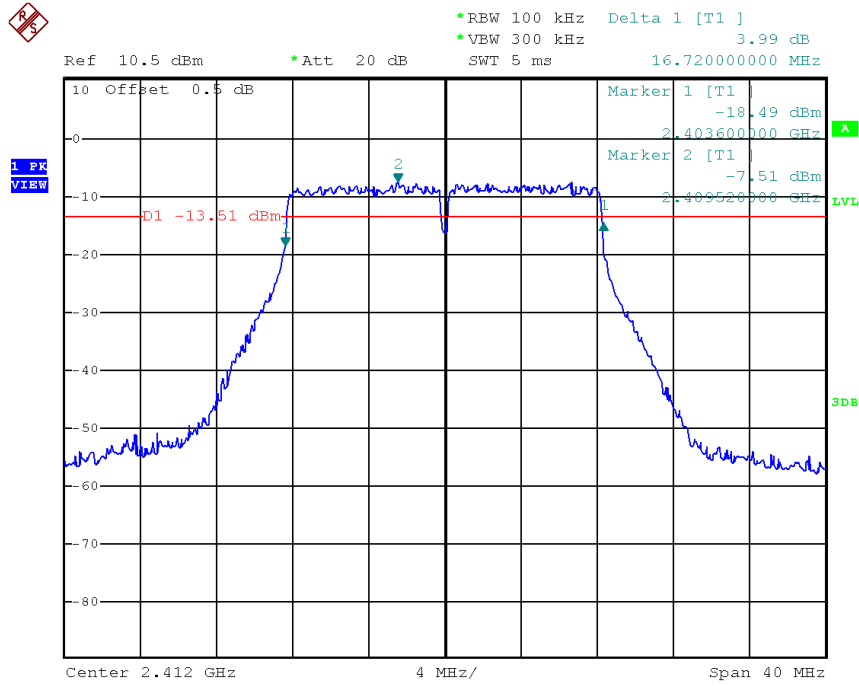

802.11n (20MHz), Middle Channel

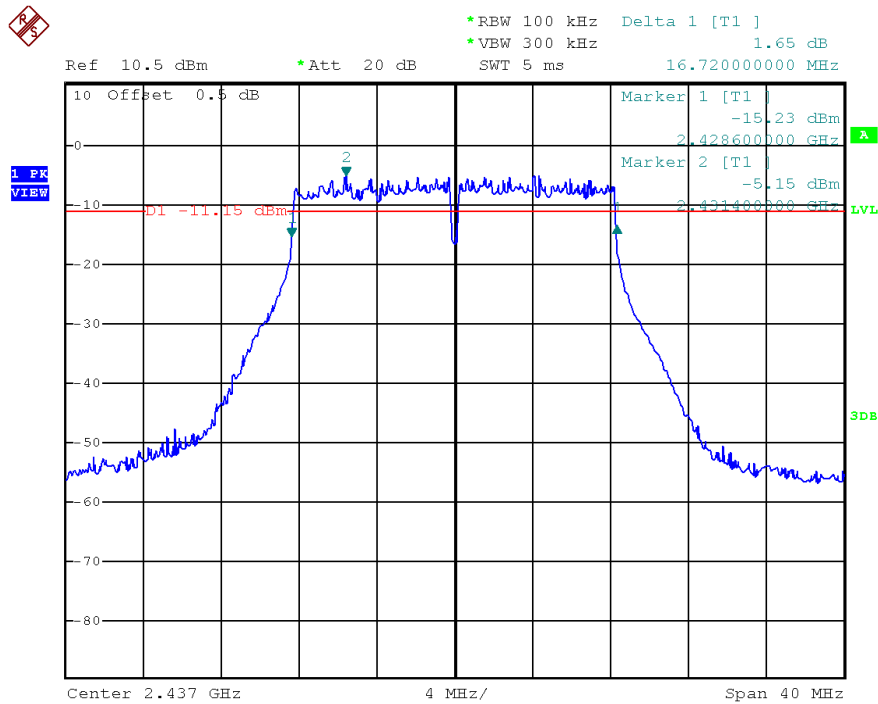

**TEST REPORT**

**PLOTS OF 6dB RF BANDWIDTH**  
802.11n (20MHz), Highest Channel

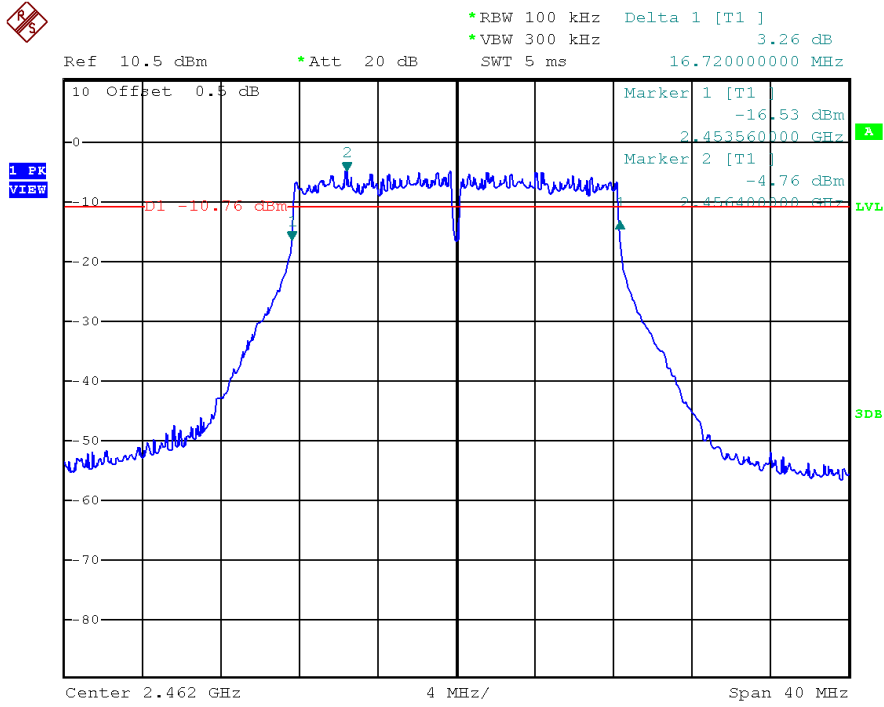

## TEST REPORT

### 4.3 Maximum Power Spectral Density

Antenna output of the EUT was coupled directly to spectrum analyzer. The measurement procedure 10.2 PKPSD was used. If an external attenuator and/or cable was used, these losses are compensated for using the OFFSET function of the analyser.

#### IEEE 802.11b (DSSS, 1 Mbps)

Frequency (MHz)	PSD in 100kHz (dBm)
Low Channel: 2412	-0.49
Middle Channel: 2437	0.33
High Channel: 2462	0.74

#### IEEE 802.11g (OFDM, 6 Mbps)

Frequency (MHz)	PSD in 100kHz (dBm)
Low Channel: 2412	-5.54
Middle Channel: 2437	-4.56
High Channel: 2462	-4.12

#### IEEE 802.11n (20MHz) (OFDM, MCS0)

Frequency (MHz)	PSD in 100kHz (dBm)
Low Channel: 2412	-5.27
Middle Channel: 2437	-4.45
High Channel: 2462	-4.09

Cable Loss: 0.5 dB

Limit:  
8dBm

The plots of power spectral density are as below.

**TEST REPORT**

**PLOTS OF POWER SPECTRAL DENSITY**

802.11b, Lowest channel

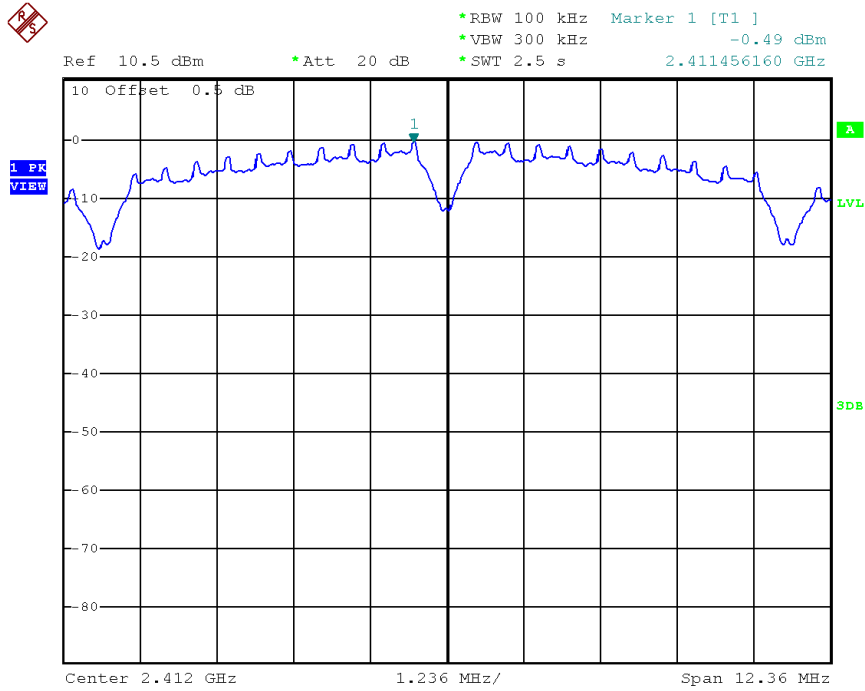

802.11b, Middle channel

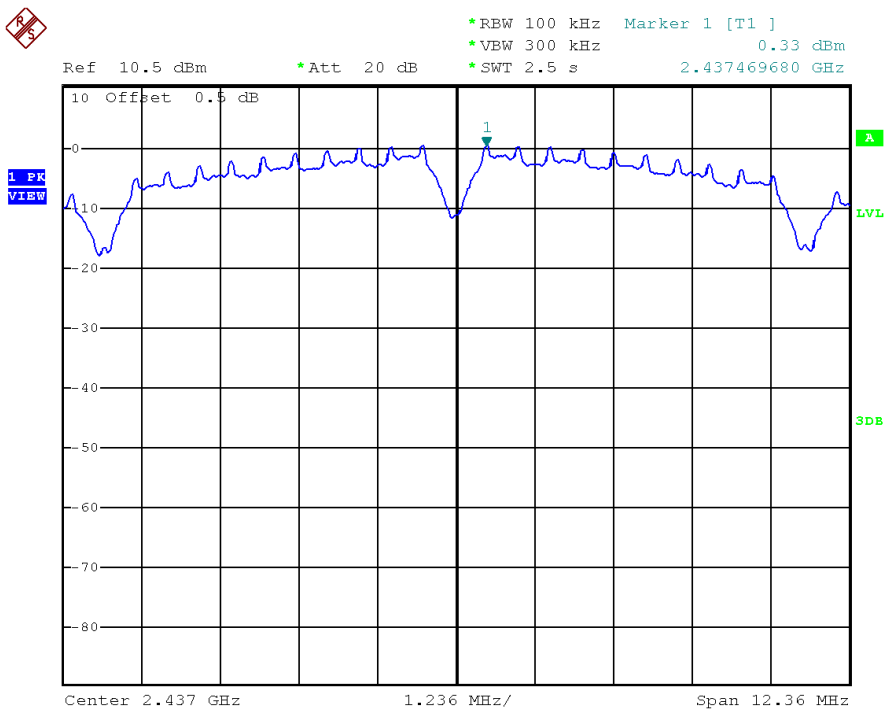

## TEST REPORT

### PLOTS OF POWER SPECTRAL DENSITY

802.11b, Highest channel

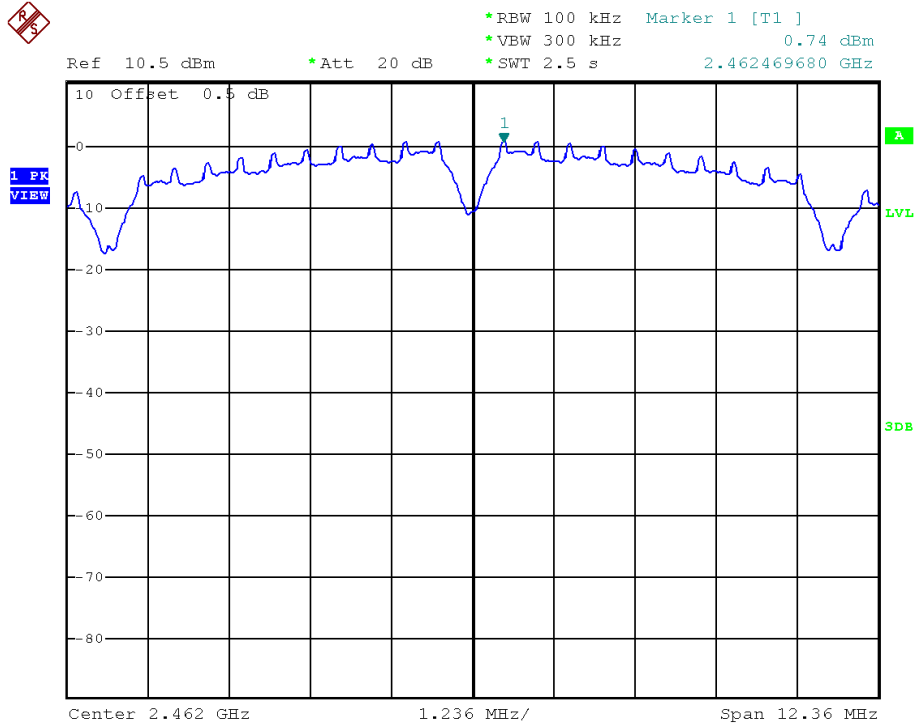

**TEST REPORT**

**PLOTS OF POWER SPECTRAL DENSITY**

802.11g, Lowest channel

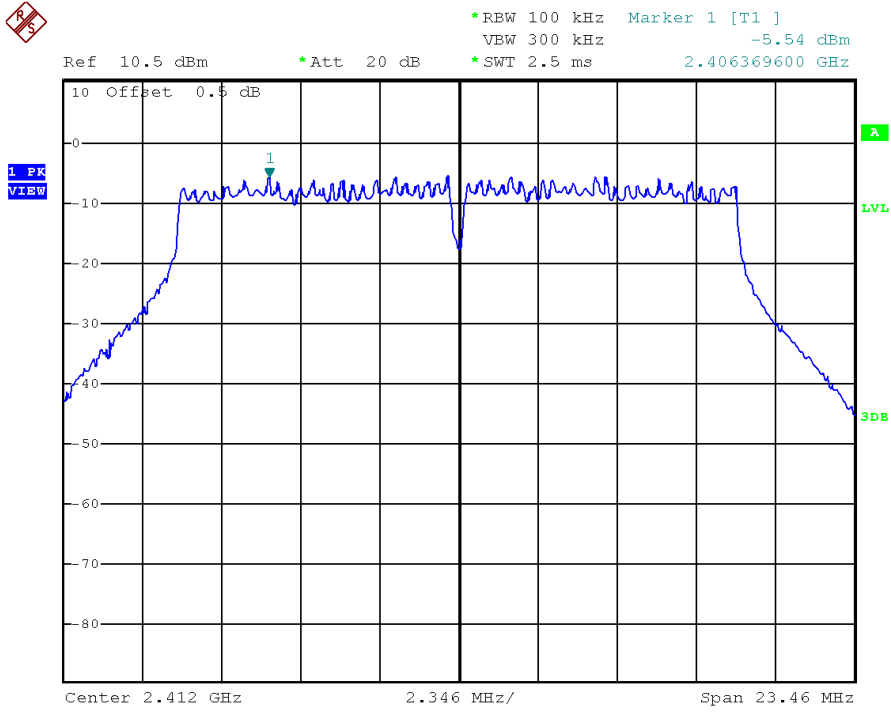

802.11g, Middle channel

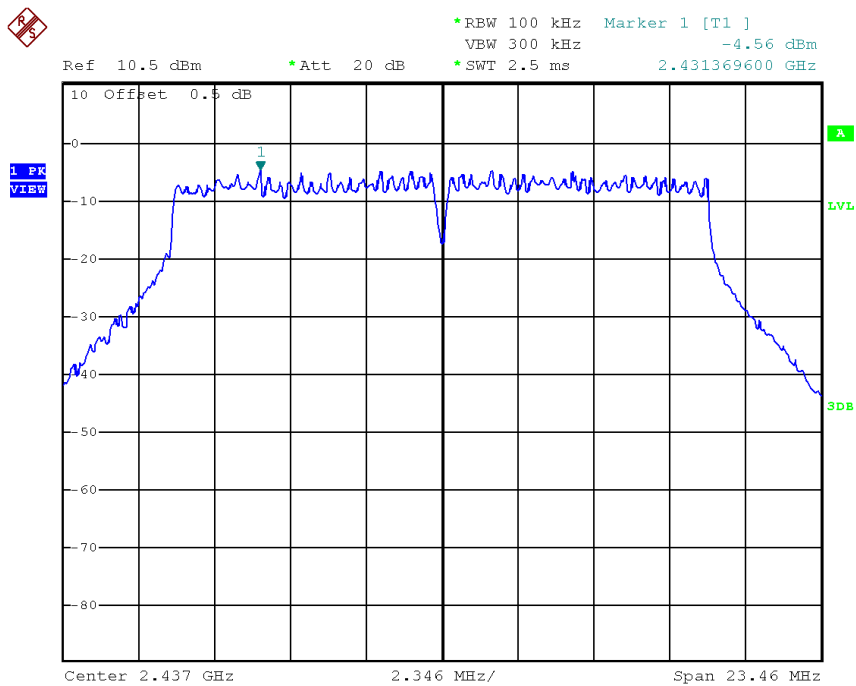

**TEST REPORT**

**PLOTS OF POWER SPECTRAL DENSITY**

802.11g, Highest channel

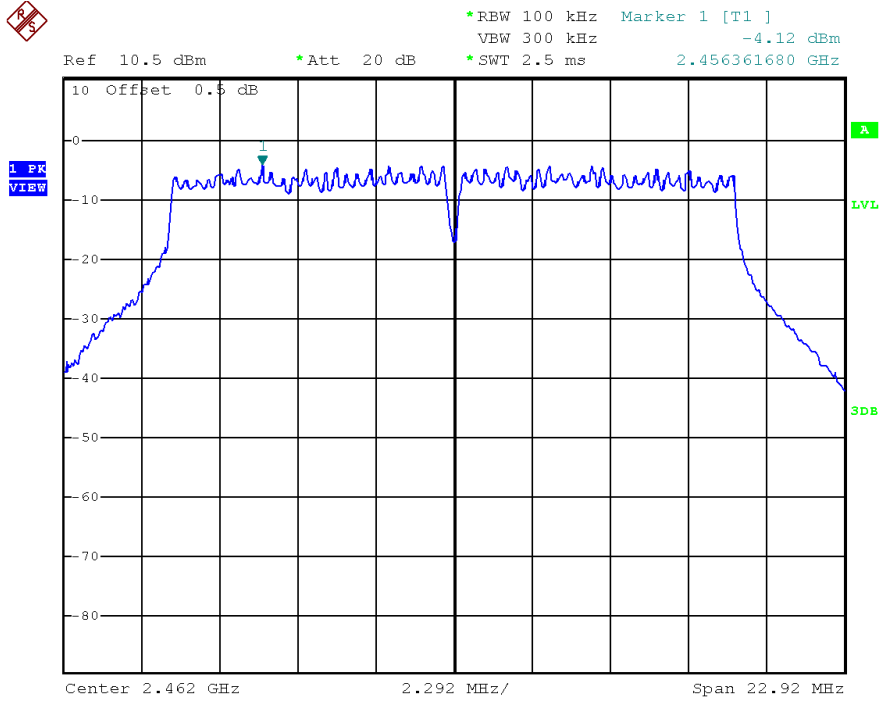

**TEST REPORT**

**PLOTS OF POWER SPECTRAL DENSITY**

802.11n (20MHz), Lowest channel

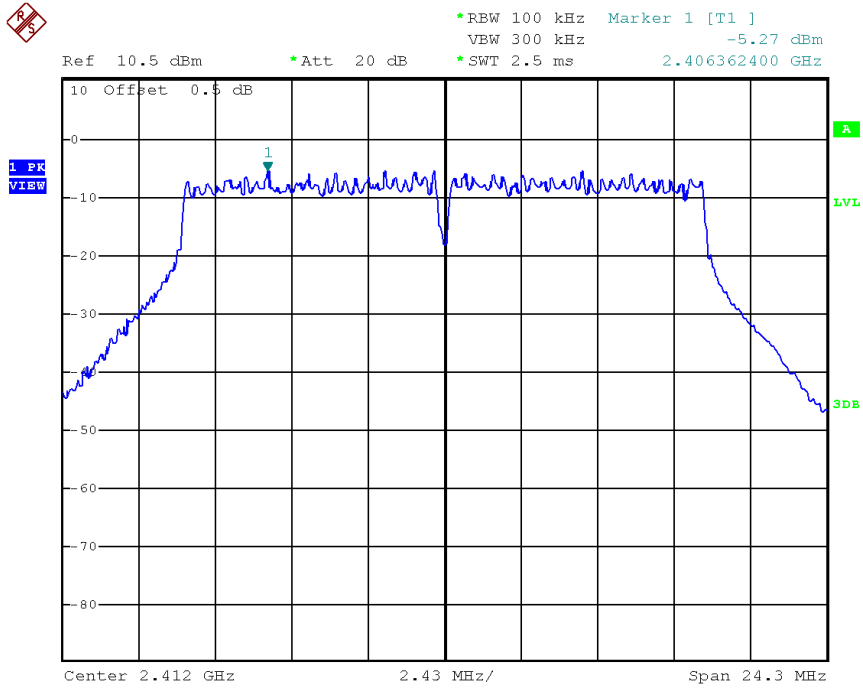

802.11n (20MHz), Middle channel

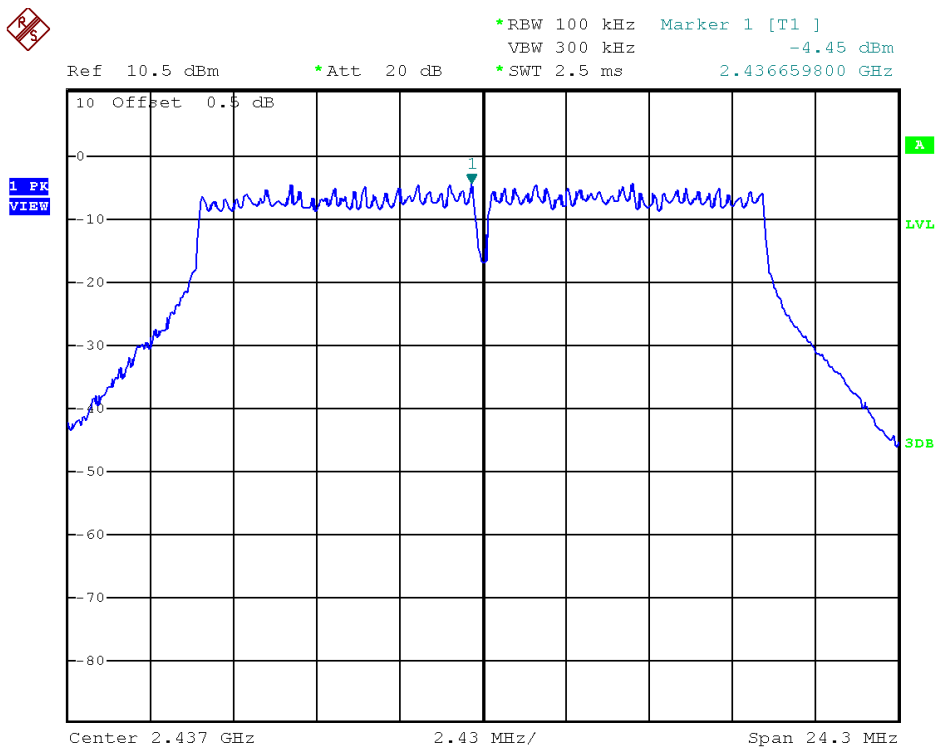



### TEST REPORT

### PLOTS OF POWER SPECTRAL DENSITY

802.11n (20MHz), Highest channel

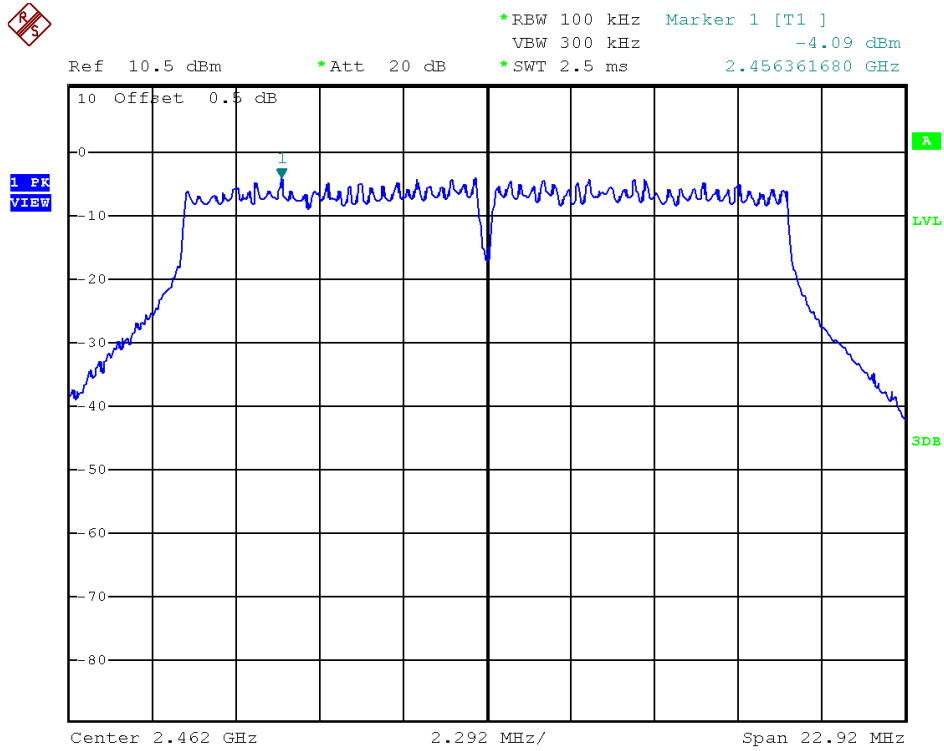

## TEST REPORT

### 4.4 Out of Band Conducted Emissions

For 802.11b/g/n20MHz, the maximum conducted (peak) output power was used to demonstrate compliance as described in 9.1. Then the display line (in red) shown in the following plots denotes the limit at 20dB below maximum measured in-band peak PSD level in 100 KHz bandwidth for 802.11b/g/n20MHz.

The measurement procedures under sections 11 of KDB558074 D01 v05r01 (11-February-2019) were used.

Furthermore, delta measurement technique for measuring bandedge emissions was incorporated in the test of the edge at 2483.5MHz.

#### Limits:

All spurious emission and up to the tenth harmonic was measured and they were found to be at least for 802.11b,g,n20MHz below the maximum measured in-band peak PSD level.

**TEST REPORT**

**PLOTS OF OUT OF BAND CONDUCTED EMISSIONS**

**802.11b, Lowest Channel, Bandedge**

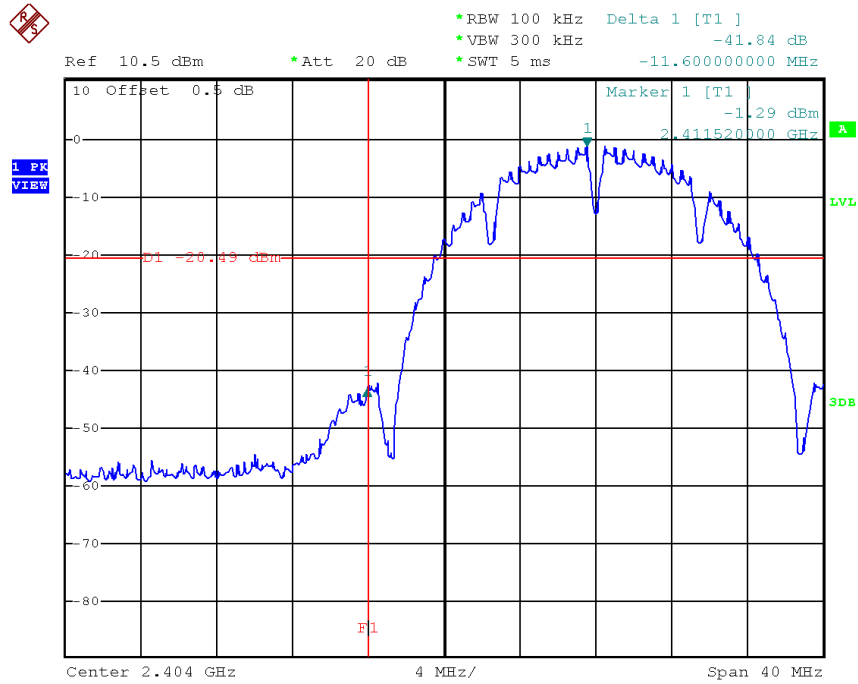

**802.11b, Highest Channel, Bandedge**

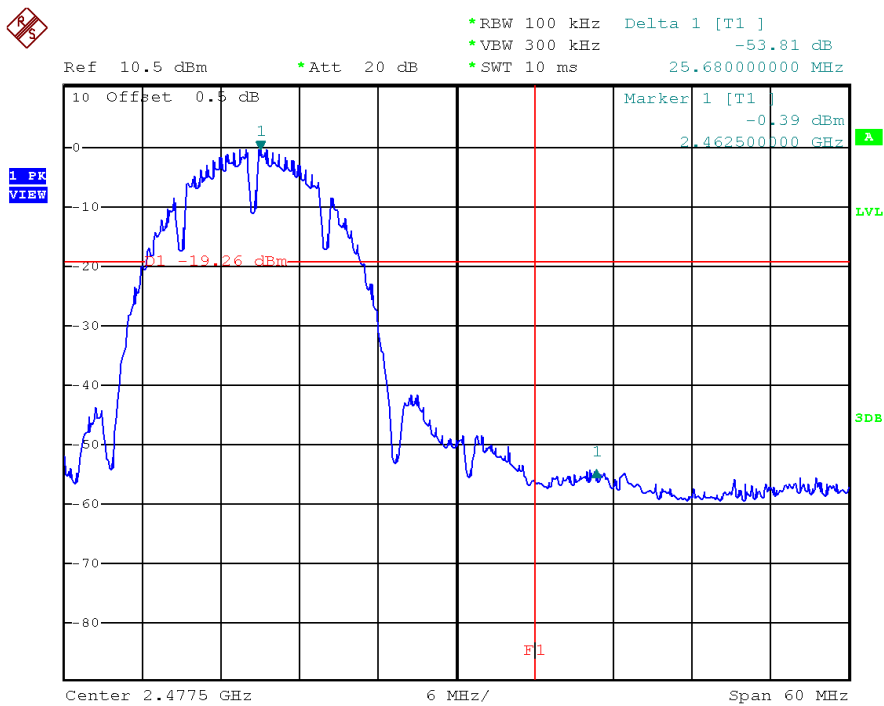

**TEST REPORT**

**PLOTS OF OUT OF BAND CONDUCTED EMISSIONS**

**802.11b, Lowest Channel, Plot A**

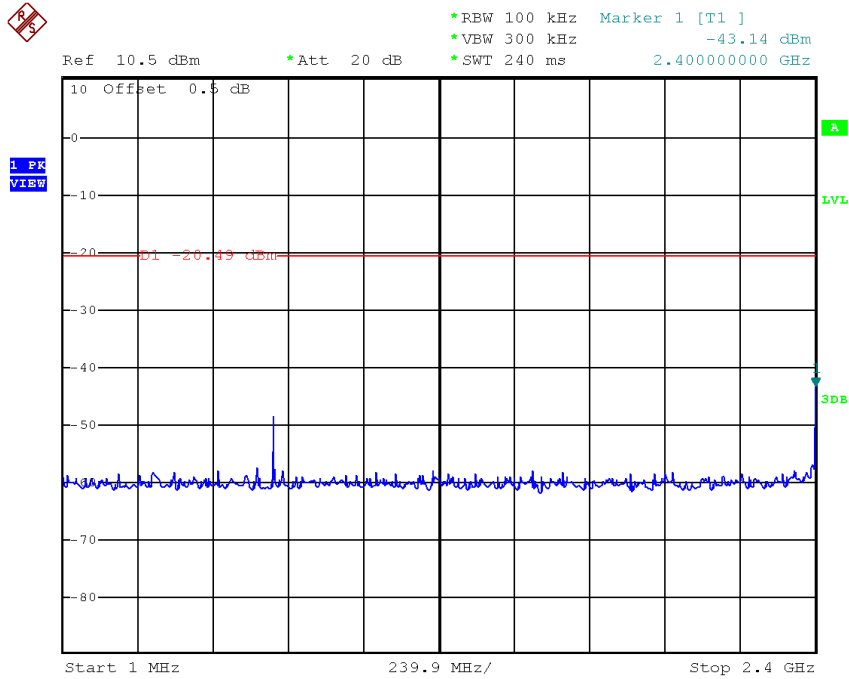

**802.11b, Lowest Channel, Plot B**

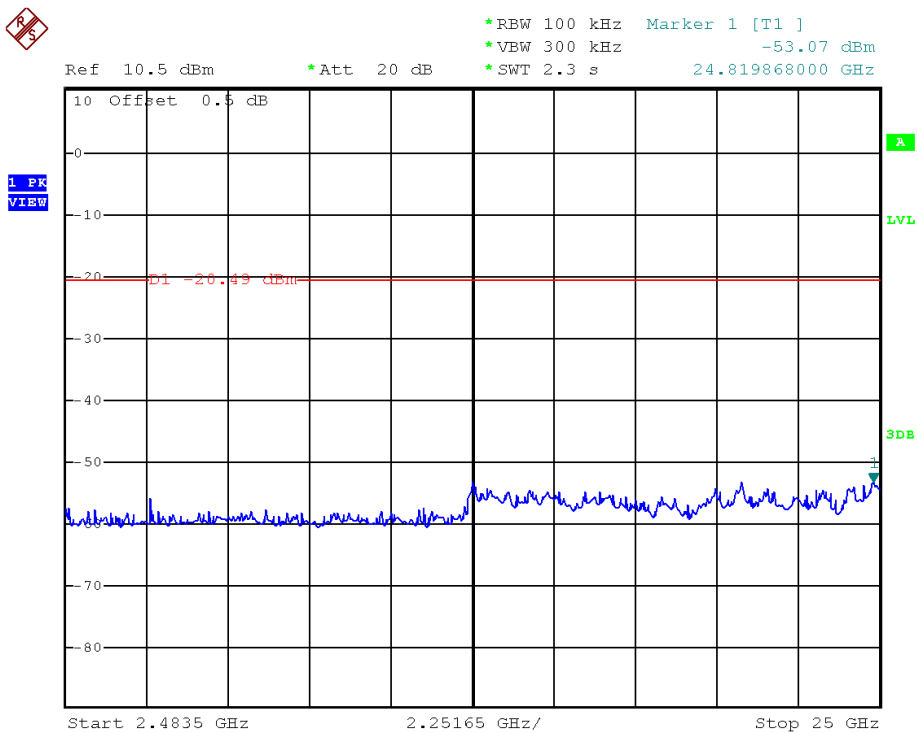

**TEST REPORT**

**PLOTS OF OUT OF BAND CONDUCTED EMISSIONS**

**802.11b, Middle Channel, Plot A**

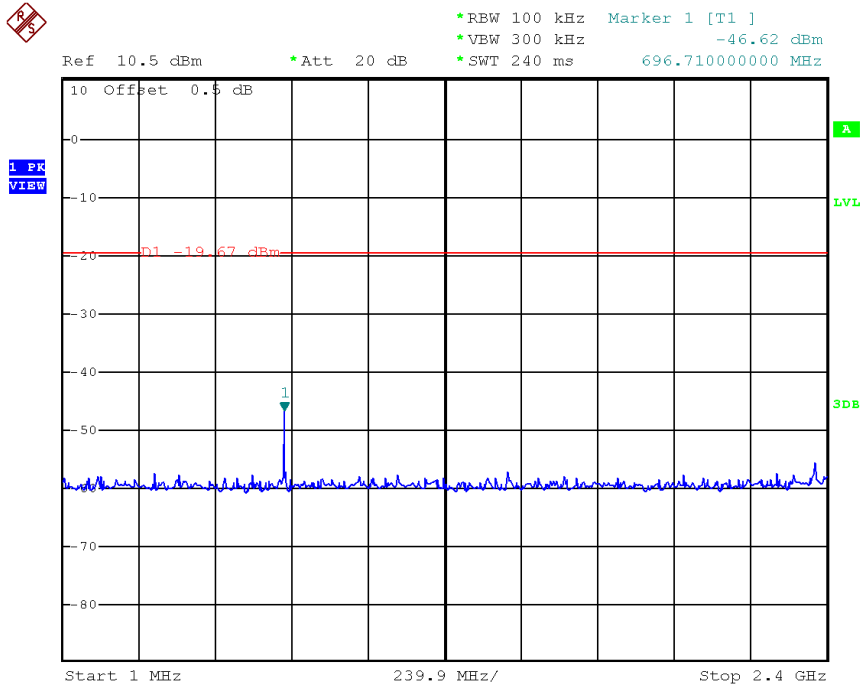

**802.11b, Middle Channel, Plot B**

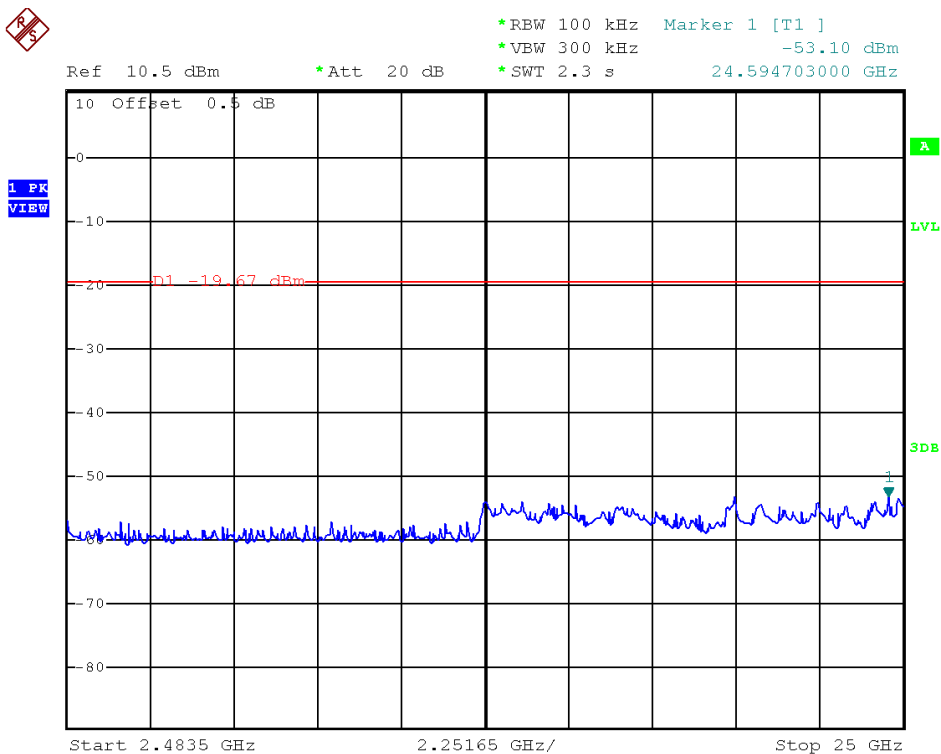

**TEST REPORT**

**PLOTS OF OUT OF BAND CONDUCTED EMISSIONS**

802.11b, Highest Channel, Plot A

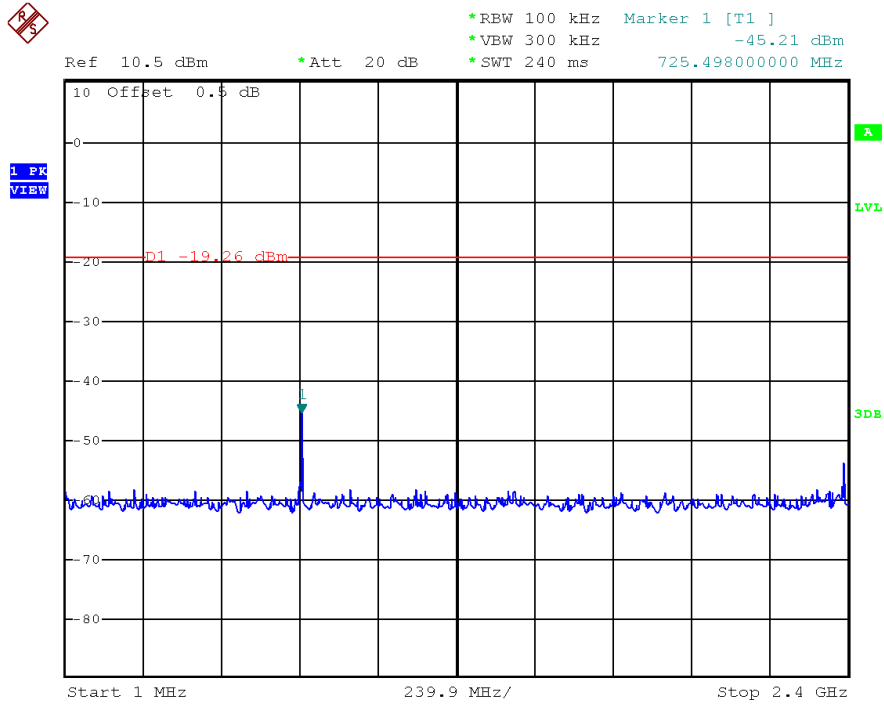

802.11b, Highest Channel, Plot B

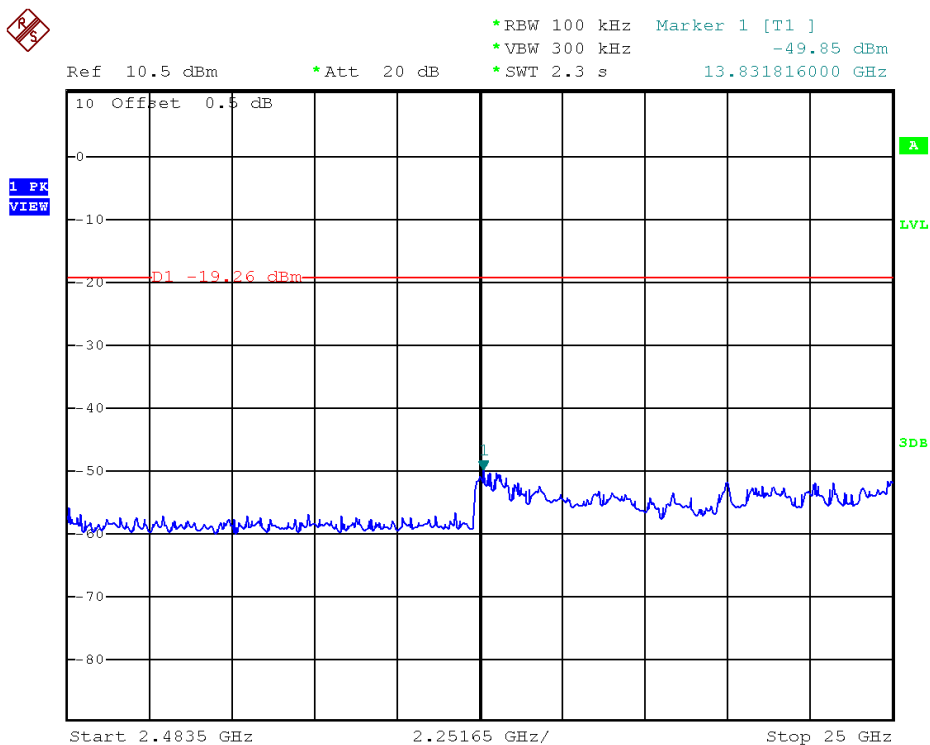

**TEST REPORT**

**PLOTS OF OUT OF BAND CONDUCTED EMISSIONS**

**802.11g, Lowest Channel, Bandedge**

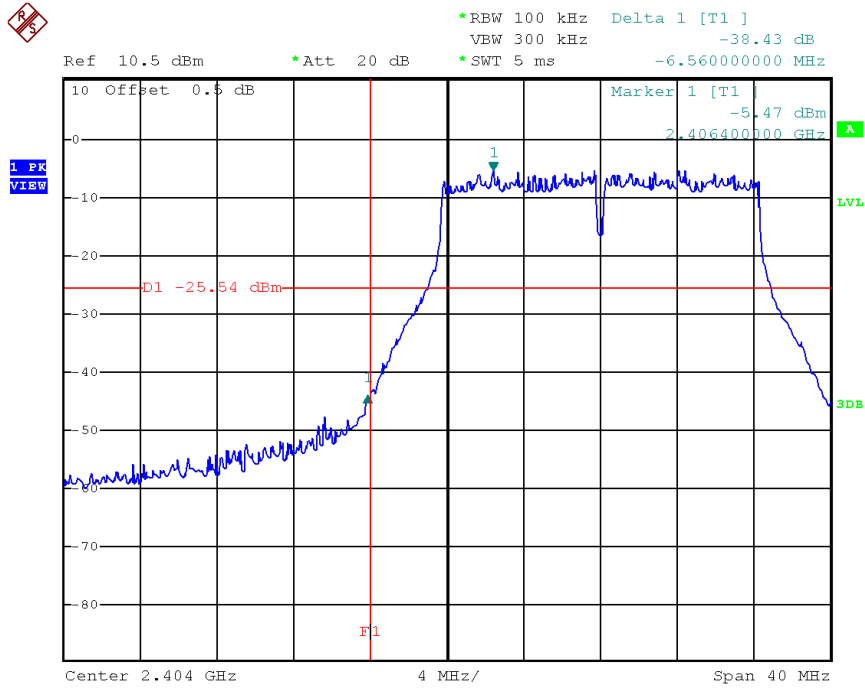

**802.11g, Highest Channel, Bandedge**

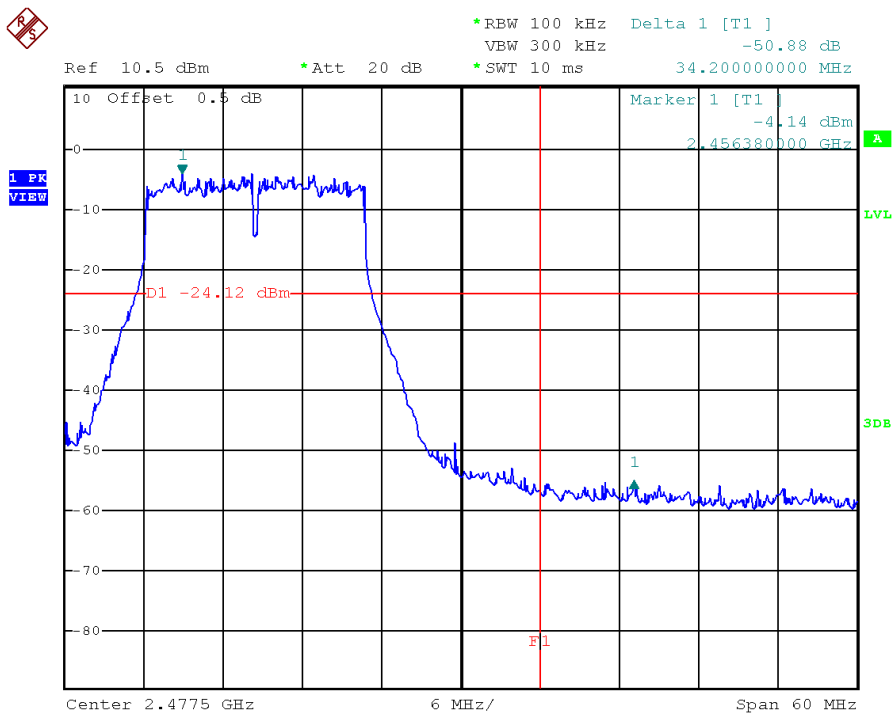

**TEST REPORT**

**PLOTS OF OUT OF BAND CONDUCTED EMISSIONS**

802.11g, Lowest Channel, Plot A

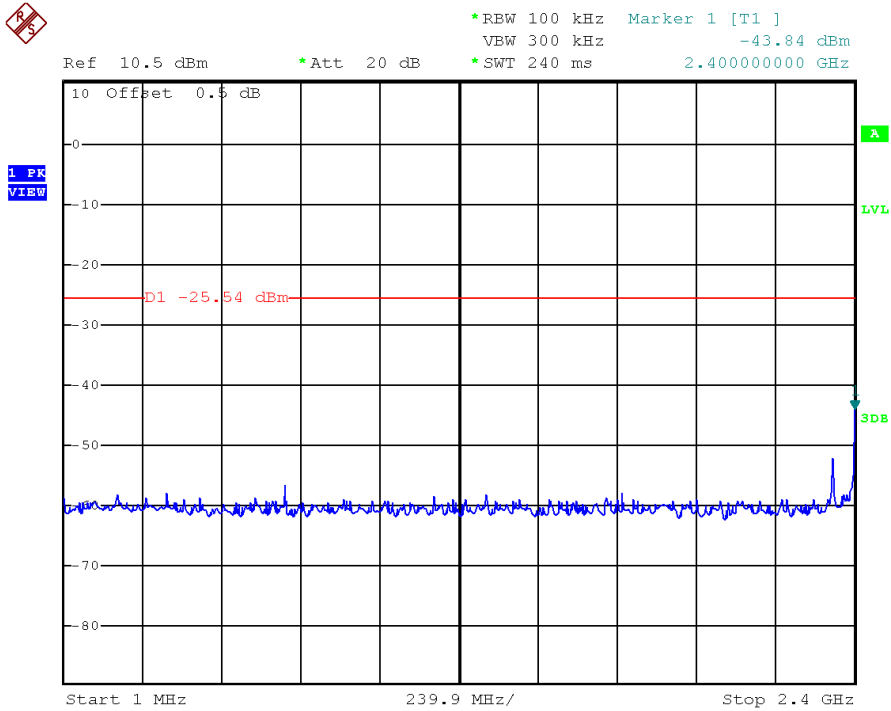

802.11g, Lowest Channel, Plot B

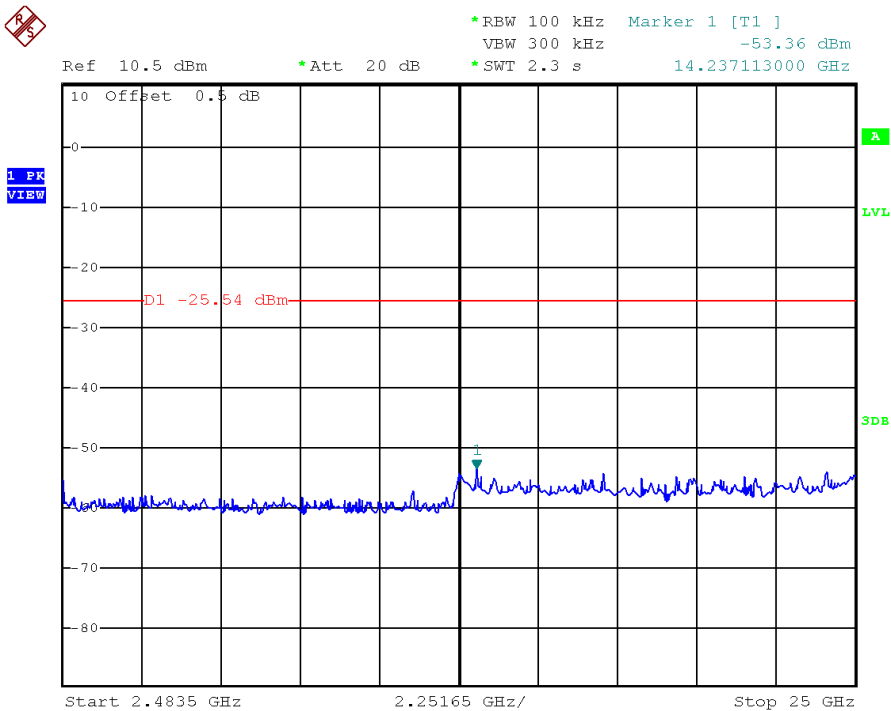



### TEST REPORT

### PLOTS OF OUT OF BAND CONDUCTED EMISSIONS

#### 802.11g, Middle Channel, Plot A

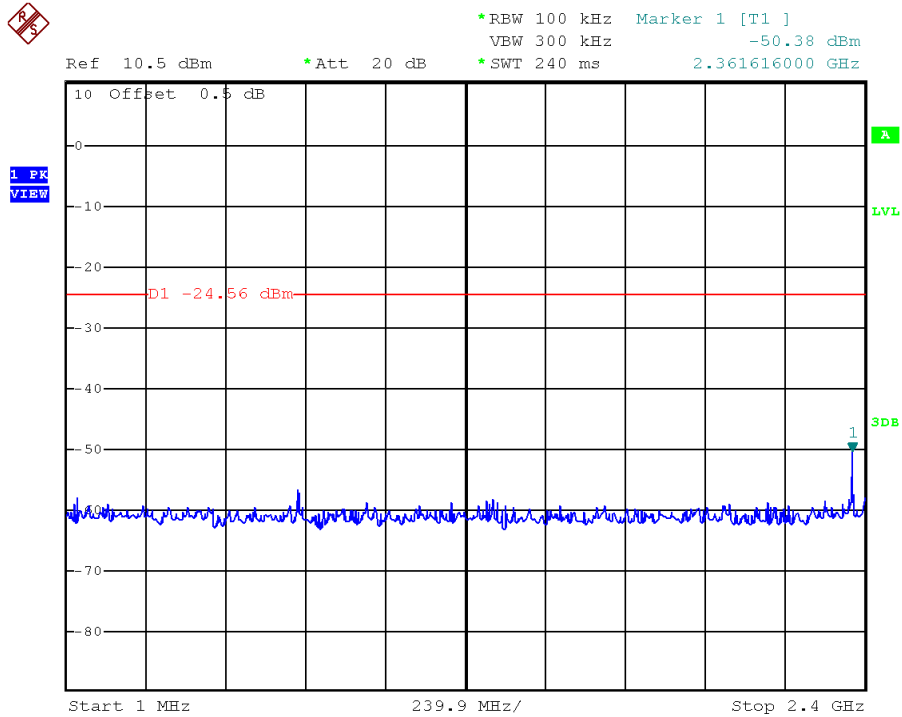

#### 802.11g, Middle Channel, Plot B

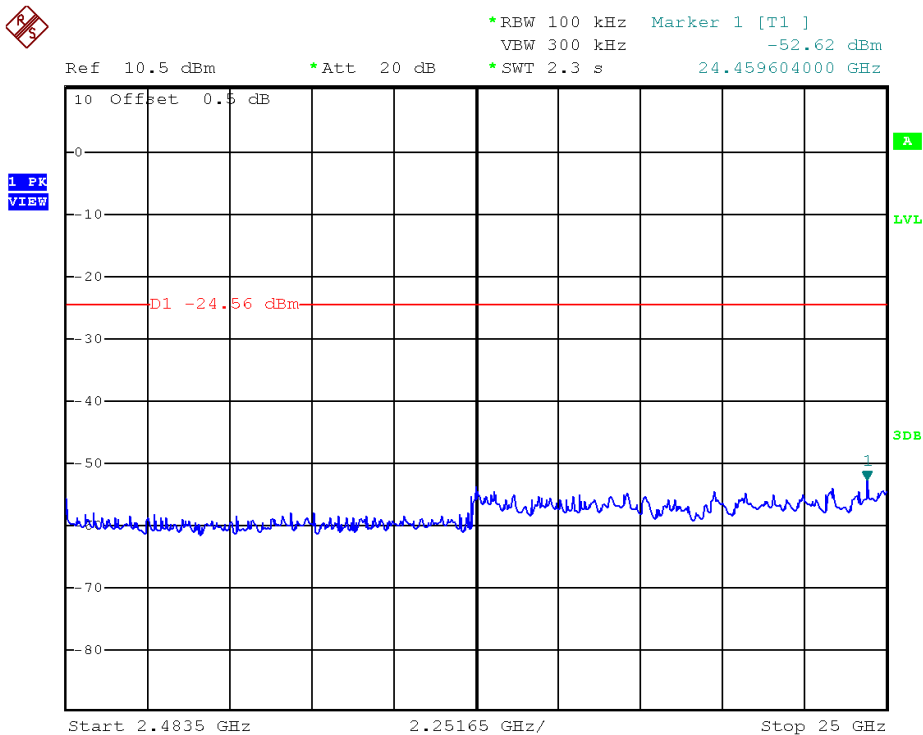

**TEST REPORT**

**PLOTS OF OUT OF BAND CONDUCTED EMISSIONS**

802.11g, Highest Channel, Plot A

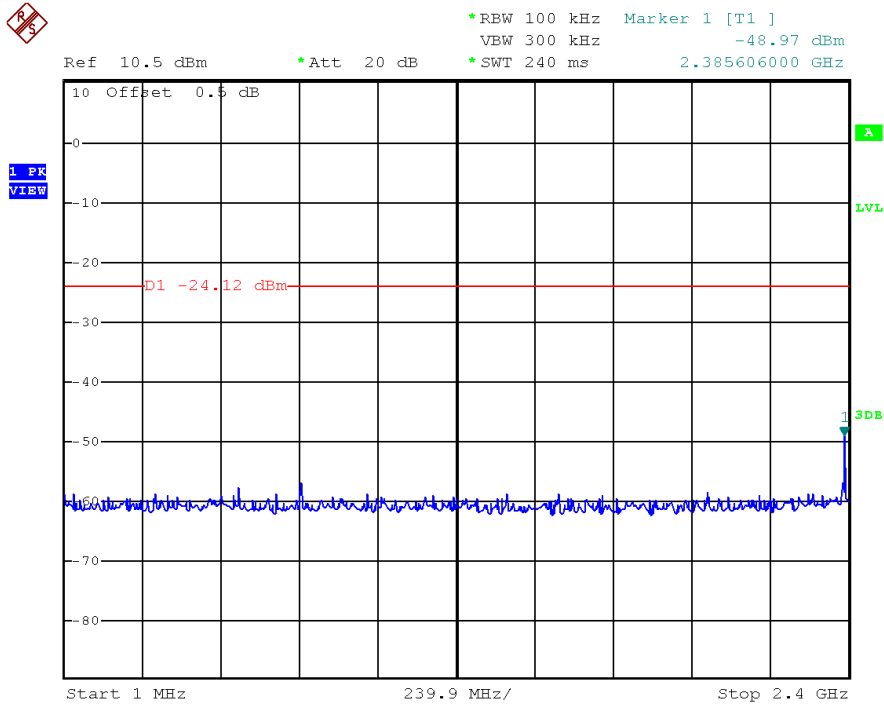

802.11g, Highest Channel, Plot B

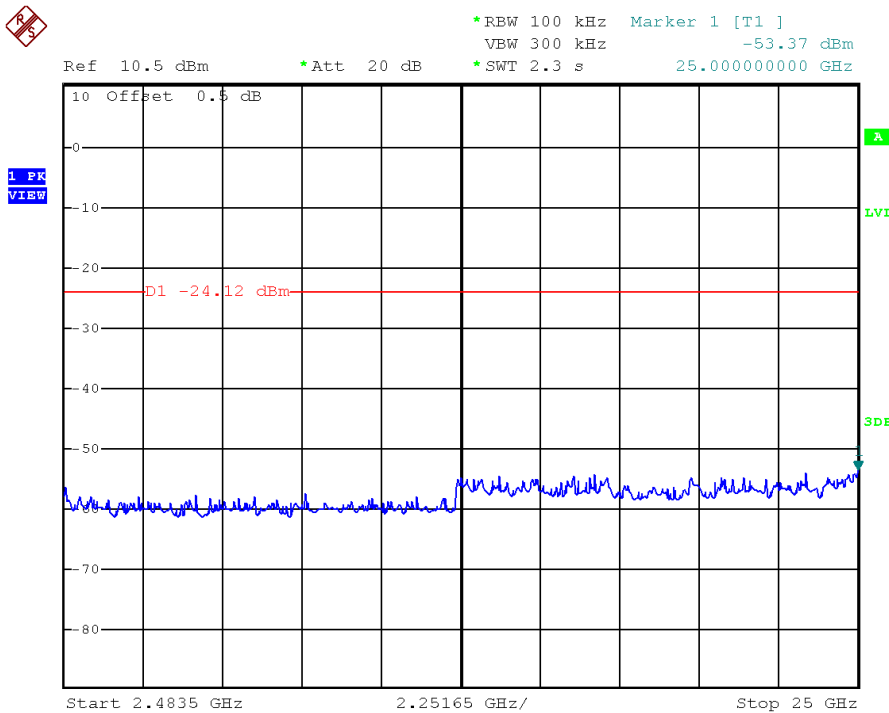

**TEST REPORT**

**PLOTS OF OUT OF BAND CONDUCTED EMISSIONS**

802.11n (20MHz), Lowest Channel, Bandedge

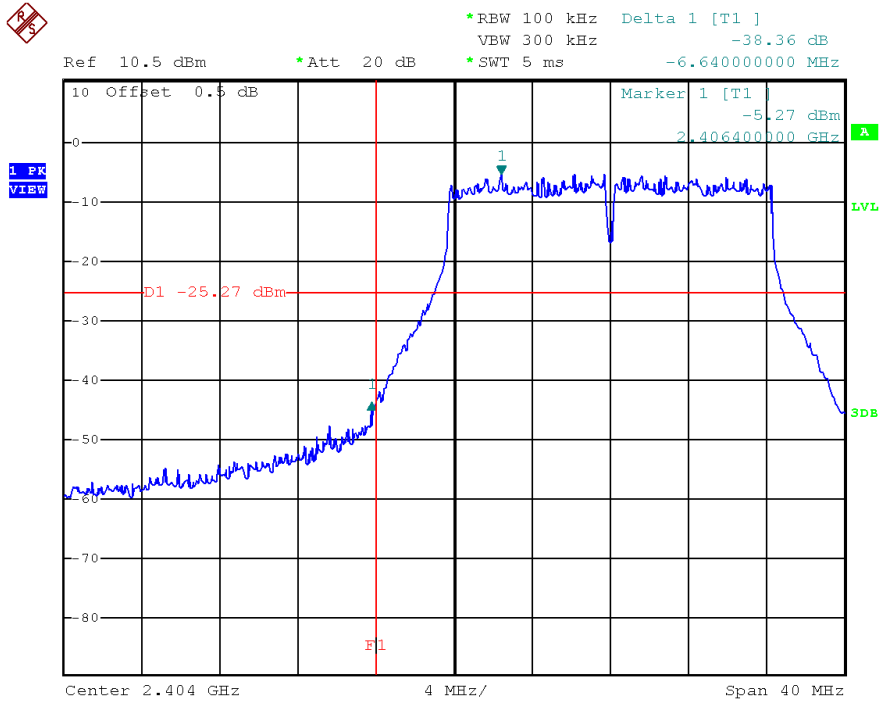

802.11n (20MHz), Highest Channel, Bandedge

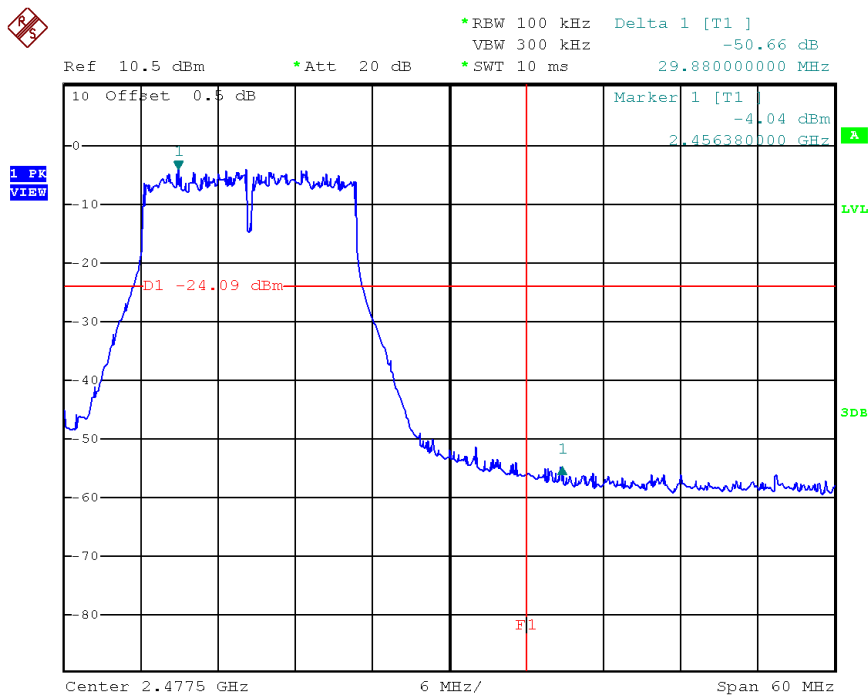

**TEST REPORT**

**PLOTS OF OUT OF BAND CONDUCTED EMISSIONS**

802.11n (20MHz), Lowest Channel, Plot A

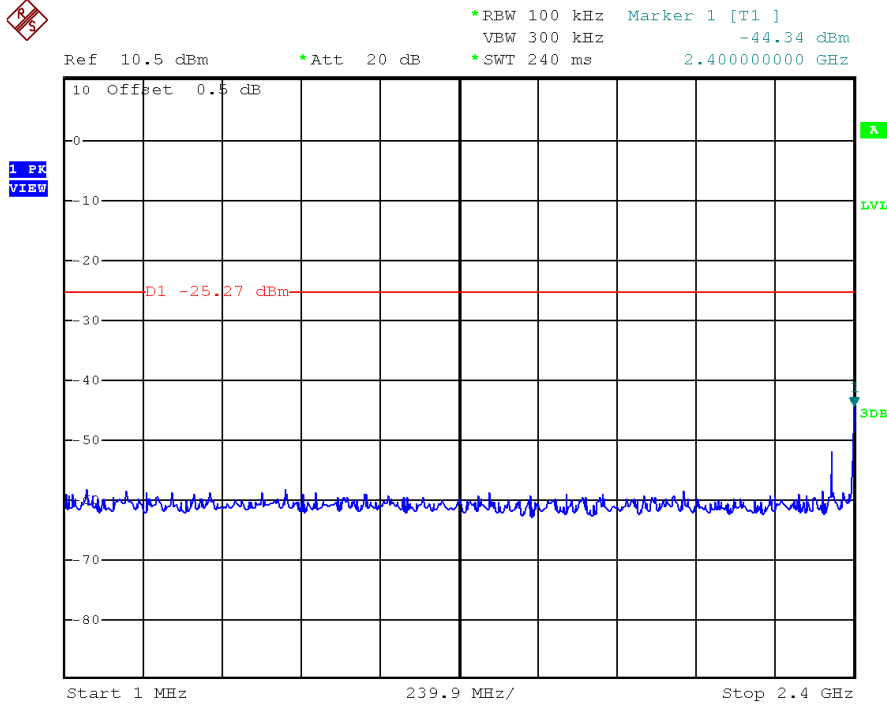

802.11n (20MHz), Lowest Channel, Plot B

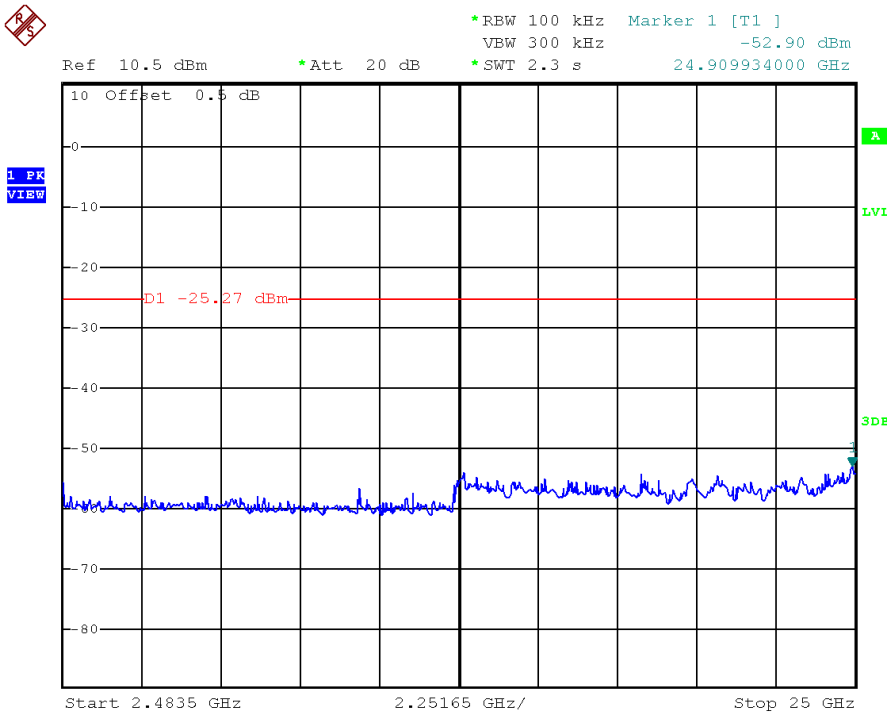

**TEST REPORT**

**PLOTS OF OUT OF BAND CONDUCTED EMISSIONS**

802.11n (20MHz), Middle Channel, Plot A

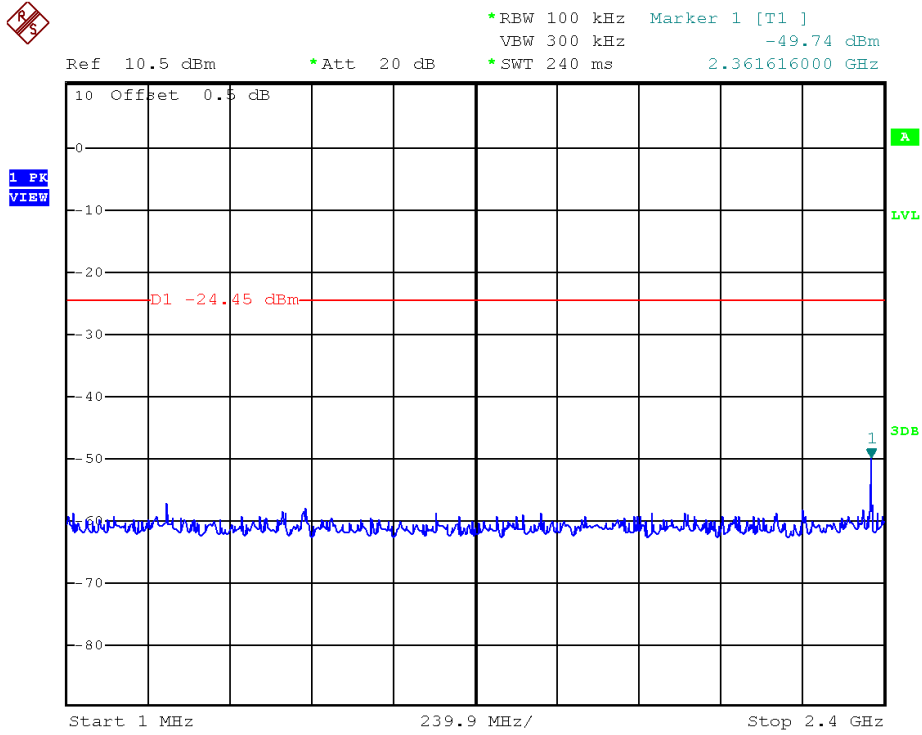

802.11n (20MHz), Middle Channel, Plot B

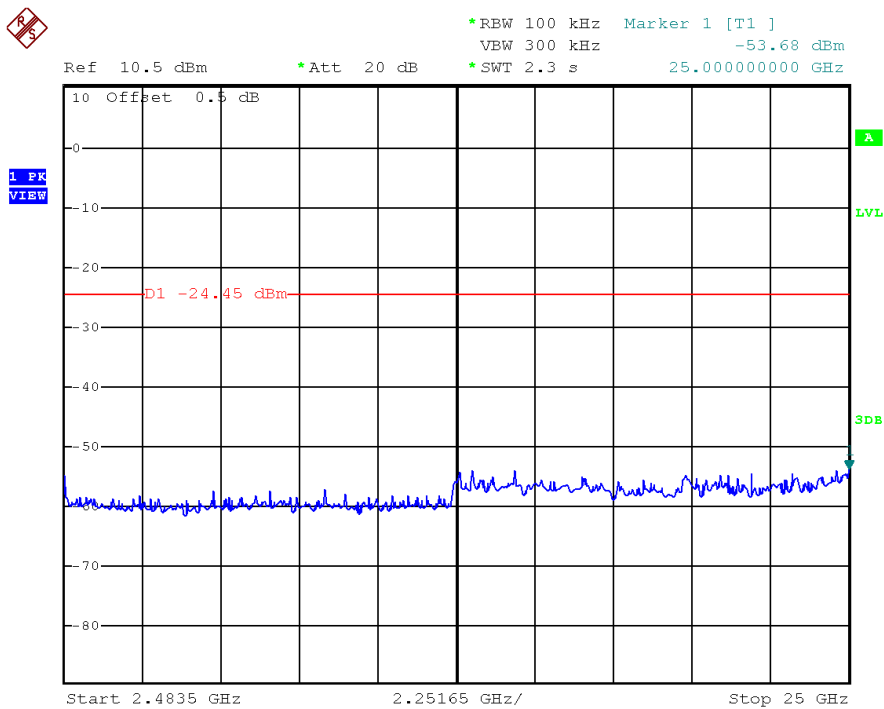

**TEST REPORT**

**PLOTS OF OUT OF BAND CONDUCTED EMISSIONS**

802.11n (20MHz), Highest Channel, Plot A

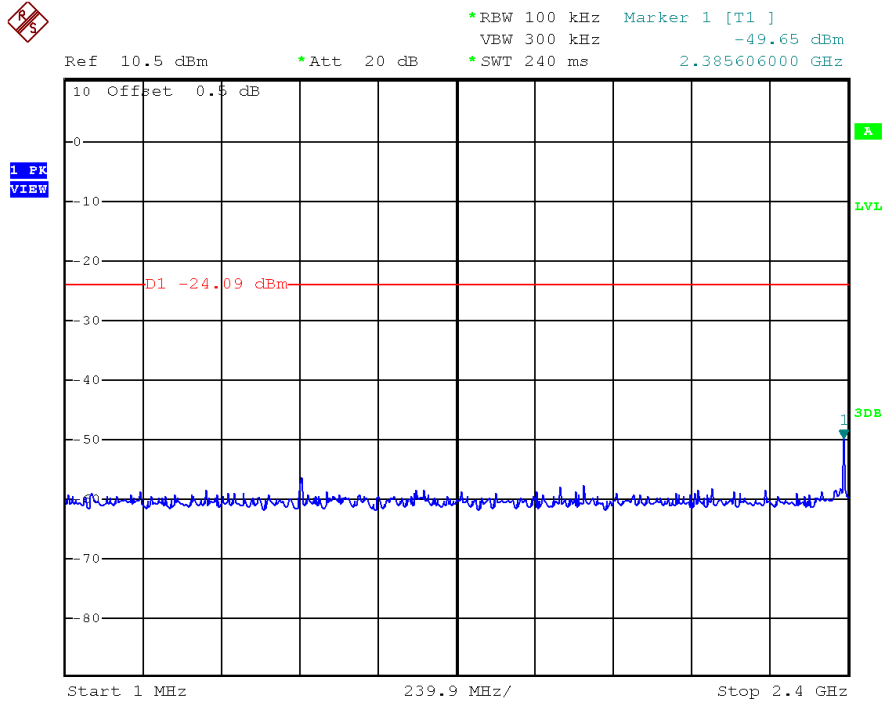

802.11n (20MHz), Highest Channel, Plot B

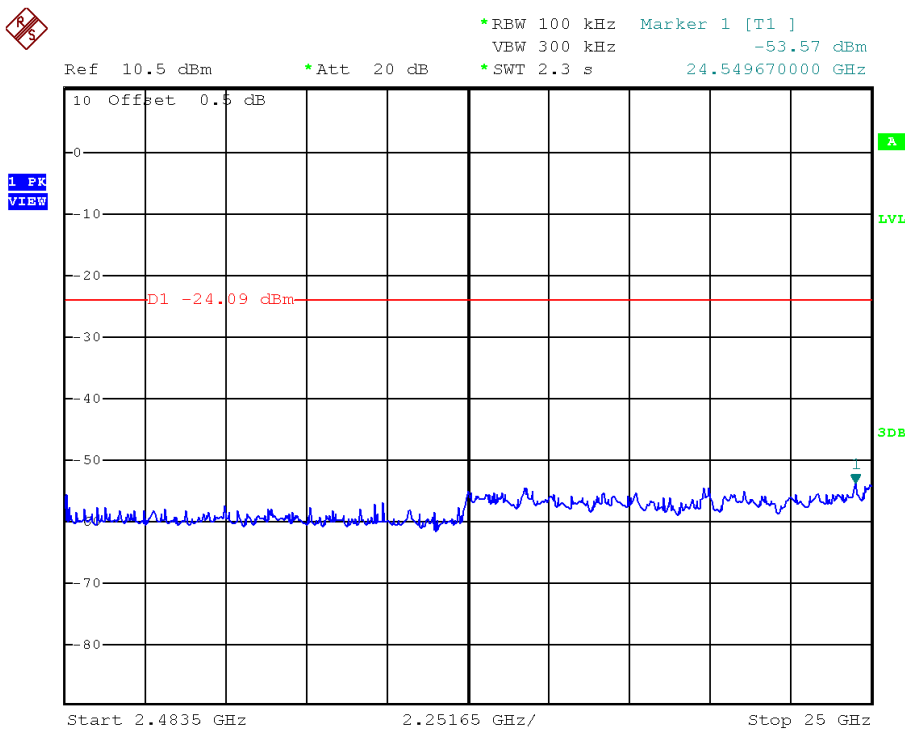

## TEST REPORT

### 4.5 Field Strength Calculation

The field strength is calculated by adding the reading on the Spectrum Analyzer to the factors associated with preamplifiers (if any), antennas, cables, pulse desensitization and average factors (when specified limit is in average and measurements are made with peak detectors). A sample calculation is included below.

$$FS = RA + AF + CF - AG + PD + AV$$

Where FS = Field Strength in dB $\mu$ V/m

RA = Receiver Amplitude (including preamplifier) in dB $\mu$ V

CF = Cable Attenuation Factor in dB

AF = Antenna Factor in dB

AG = Amplifier Gain in dB

PD = Pulse Desensitization in dB

AV = Average Factor in -dB

In the radiated emission table which follows, the reading shown on the data table may reflect the preamplifier gain. An example of the calculations, where the reading does not reflect the preamplifier gain, follows:

$$FS = RA + AF + CF - AG + PD + AV$$

#### Example

Assume a receiver reading of 62.0 dB $\mu$ V is obtained. The antenna factor of 7.4 dB and cable factor of 1.6 dB is added. The amplifier gain of 29.0 dB is subtracted. The pulse desensitization factor of the spectrum analyzer is 0.0 dB, and the resultant average factor is -10.0 dB. The net field strength for comparison to the appropriate emission limit is 32.0 dB $\mu$ V/m. This value in dB $\mu$ V/m is converted to its corresponding level in  $\mu$ V/m.

$$RA = 62.0 \text{ dB}\mu\text{V}$$

$$AF = 7.4 \text{ dB}$$

$$CF = 1.6 \text{ dB}$$

$$AG = 29.0 \text{ dB}$$

$$PD = 0.0 \text{ dB}$$

$$AV = -10 \text{ dB}$$

$$FS = 62.0 + 7.4 + 1.6 - 29.0 + 0.0 + (-10.0) = 32.0 \text{ dB}\mu\text{V/m}$$

$$\text{Level in } \mu\text{V/m} = \text{Common Antilogarithm } [(32.0 \text{ dB}\mu\text{V/m})/20] = 39.8 \mu\text{V/m}$$

## TEST REPORT

### 4.6 Transmitter Radiated Emissions in Restricted Bands and Spurious Emissions

Data is included of the worst case configuration (the configuration which resulted in the highest emission levels). A sample calculation, configuration photographs and data tables of the emissions are included.

The data on the following pages list the significant emission frequencies, the limit and the margin of compliance.

#### 4.6.1 Radiated Emission Configuration Photograph

Worst Case Restricted Band Radiated Emission  
at

200.001 MHz

The worst case radiated emission configuration photographs are saved with filename: config photos.pdf

#### 4.6.2 Radiated Emission Data

The data in tables 1-10 list the significant emission frequencies, the limit and the margin of compliance.

Judgement -

Passed by 5.4 dB margin



**TEST REPORT**

**RADIATED EMISSION DATA**

Mode: TX-Channel 01

Table 1  
IEEE 802.11b (DSSS, 1 Mbps)

Polarization	Frequency (MHz)	Reading (dBµV)	Pre-Amp Gain (dB)	Antenna Factor (dB)	Net at 3m (dBµV/m)	Average Factor (dB)	Calculated at 3m (dBµV/m)	Average Limit at 3m (dBµV/m)	Margin (dB)
V	2390.000	43.4	33	29.4	39.8	0	39.8	54.0	-14.2
V	4804.000	42.8	33	34.9	44.7	0	44.7	54.0	-9.3
H	12010.000	22.9	33	40.5	30.4	0	30.4	54.0	-23.6

Polarization	Frequency (MHz)	Reading (dBµV)	Pre-Amp Gain (dB)	Antenna Factor (dB)	Net at 3m - Peak (dBµV/m)	Peak Limit at 3m (dBµV/m)	Margin (dB)
V	2390.000	58.7	33	29.4	55.1	74.0	-18.9
V	4804.000	47.0	33	34.9	48.9	74.0	-25.1
H	12010.000	31.4	33	40.5	38.9	74.0	-35.1

- NOTES:
1. Peak detector and Average detector is used for the emission measurement.
  2. Average detector is used for the average data of emission measurement.
  3. All measurements were made at 3 meters.
  4. Negative value in the margin column shows emission below limit.
  5. Horn antenna is used for the emission over 1000MHz.
  6. Emission within the restricted band meets the requirement of FCC Part 15 Section 15.205 / RSS-Gen Section 8.10.

**TEST REPORT**

Mode: TX-Channel 06

Table 2  
IEEE 802.11b (DSSS, 1 Mbps)

Polarization	Frequency (MHz)	Reading (dB $\mu$ V)	Pre-Amp Gain (dB)	Antenna Factor (dB)	Net at 3m (dB $\mu$ V/m)	Average Factor (dB)	Calculated at 3m (dB $\mu$ V/m)	Average Limit at 3m (dB $\mu$ V/m)	Margin (dB)
V	4882.000	40.0	33	34.9	41.9	0	41.9	54.0	-12.1
H	7323.000	25.1	33	37.9	30.0	0	30.0	54.0	-24.0
V	12205.000	23.2	33	40.5	30.7	0	30.7	54.0	-23.3

Polarization	Frequency (MHz)	Reading (dB $\mu$ V)	Pre-Amp Gain (dB)	Antenna Factor (dB)	Net at 3m - Peak (dB $\mu$ V/m)	Peak Limit at 3m (dB $\mu$ V/m)	Margin (dB)
V	4882.000	45.2	33	34.9	47.1	74.0	-26.9
H	7323.000	33.1	33	37.9	38.0	74.0	-36.0
V	12205.000	30.9	33	40.5	38.4	74.0	-35.6

- NOTES:
1. Peak detector and Average detector is used for the emission measurement.
  2. Average detector is used for the average data of emission measurement
  3. All measurements were made at 3 meters.
  4. Negative value in the margin column shows emission below limit.
  5. Horn antenna is used for the emission over 1000MHz.
  6. Emission within the restricted band meets the requirement of FCC Part 15 Section 15.205 / RSS-Gen Section 8.10.

**TEST REPORT**

Mode: TX-Channel 11

Table 3  
IEEE 802.11b (DSSS, 1 Mbps)

Polarization	Frequency (MHz)	Reading (dB $\mu$ V)	Pre-Amp Gain (dB)	Antenna Factor (dB)	Net at 3m (dB $\mu$ V/m)	Average Factor (dB)	Calculated at 3m (dB $\mu$ V/m)	Average Limit at 3m (dB $\mu$ V/m)	Margin (dB)
V	2483.500	43.8	33	29.4	40.2	0	40.2	54.0	-13.8
H	4960.000	41.2	33	34.9	43.1	0	43.1	54.0	-10.9
V	7440.000	25.4	33	37.9	30.3	0	30.3	54.0	-23.8
V	12400.000	23.3	33	40.5	30.8	0	30.8	54.0	-23.2

Polarization	Frequency (MHz)	Reading (dB $\mu$ V)	Pre-Amp Gain (dB)	Antenna Factor (dB)	Net at 3m - Peak (dB $\mu$ V/m)	Peak Limit at 3m (dB $\mu$ V/m)	Margin (dB)
V	2483.500	58.0	33	29.4	54.4	74.0	-19.6
H	4960.000	45.8	33	34.9	47.7	74.0	-26.3
V	7440.000	33.3	33	37.9	38.2	74.0	-35.8
V	12400.000	31.2	33	40.5	38.7	74.0	-35.3

- NOTES:
1. Peak detector and Average detector is used for the emission measurement.
  2. Average detector is used for the average data of emission measurement
  3. All measurements were made at 3 meters.
  4. Negative value in the margin column shows emission below limit.
  5. Horn antenna is used for the emission over 1000MHz.
  6. Emission within the restricted band meets the requirement of FCC Part 15 Section 15.205 / RSS-Gen Section 8.10.

**TEST REPORT**

Mode: TX-Channel 01

Table 4  
IEEE 802.11g (OFDM, 6 Mbps)

Polarization	Frequency (MHz)	Reading (dBμV)	Pre-Amp Gain (dB)	Antenna Factor (dB)	Net at 3m (dBμV/m)	Average Factor (dB)	Calculated at 3m (dBμV/m)	Average Limit at 3m (dBμV/m)	Margin (dB)
V	2390.000	43.2	33	29.4	39.6	0	39.6	54.0	-14.4
V	4804.000	38.5	33	34.9	40.4	0	40.4	54.0	-13.6
V	12010.000	22.8	33	40.5	30.3	0	30.3	54.0	-23.8

Polarization	Frequency (MHz)	Reading (dBμV)	Pre-Amp Gain (dB)	Antenna Factor (dB)	Net at 3m - Peak (dBμV/m)	Peak Limit at 3m (dBμV/m)	Margin (dB)
V	2390.000	57.7	33	29.4	54.1	74.0	-19.9
V	4804.000	44.9	33	34.9	46.8	74.0	-27.2
V	12010.000	31.3	33	40.5	38.8	74.0	-35.2

- NOTES:
1. Peak detector and Average detector is used for the emission measurement.
  2. Average detector is used for the average data of emission measurement
  3. All measurements were made at 3 meters.
  4. Negative value in the margin column shows emission below limit.
  5. Horn antenna is used for the emission over 1000MHz.
  6. Emission within the restricted band meets the requirement of FCC Part 15 Section 15.205 / RSS-Gen Section 8.10.

**TEST REPORT**

Mode: TX-Channel 06

Table 5  
IEEE 802.11g (OFDM, 6 Mbps)

Polarization	Frequency (MHz)	Reading (dBμV)	Pre-Amp Gain (dB)	Antenna Factor (dB)	Net at 3m (dBμV/m)	Average Factor (dB)	Calculated at 3m (dBμV/m)	Average Limit at 3m (dBμV/m)	Margin (dB)
V	4882.000	38.3	33	34.9	40.2	0	40.2	54.0	-13.8
V	7323.000	25.6	33	37.9	30.5	0	30.5	54.0	-23.5
V	12205.000	23.3	33	40.5	30.8	0	30.8	54.0	-23.2

Polarization	Frequency (MHz)	Reading (dBμV)	Pre-Amp Gain (dB)	Antenna Factor (dB)	Net at 3m - Peak (dBμV/m)	Peak Limit at 3m (dBμV/m)	Margin (dB)
V	4882.000	44.8	33	34.9	46.7	74.0	-27.3
V	7323.000	33.1	33	37.9	38.0	74.0	-36.0
V	12205.000	30.9	33	40.5	38.4	74.0	-35.6

- NOTES:
1. Peak detector and Average detector is used for the emission measurement.
  2. Average detector is used for the average data of emission measurement
  3. All measurements were made at 3 meters.
  4. Negative value in the margin column shows emission below limit.
  5. Horn antenna is used for the emission over 1000MHz.
  6. Emission within the restricted band meets the requirement of FCC Part 15 Section 15.205 / RSS-Gen Section 8.10.

**TEST REPORT**

Mode: TX-Channel 11

Table 6  
IEEE 802.11g (OFDM, 6 Mbps)

Polarization	Frequency (MHz)	Reading (dB $\mu$ V)	Pre-Amp Gain (dB)	Antenna Factor (dB)	Net at 3m (dB $\mu$ V/m)	Average Factor (dB)	Calculated at 3m (dB $\mu$ V/m)	Average Limit at 3m (dB $\mu$ V/m)	Margin (dB)
V	2483.500	47.5	33	29.4	43.9	0	43.9	54.0	-10.1
H	4960.000	33.4	33	34.9	35.3	0	35.3	54.0	-18.7
V	7440.000	25.5	33	37.9	30.4	0	30.4	54.0	-23.6
V	12400.000	23.4	33	40.5	30.9	0	30.9	54.0	-23.1

Polarization	Frequency (MHz)	Reading (dB $\mu$ V)	Pre-Amp Gain (dB)	Antenna Factor (dB)	Net at 3m - Peak (dB $\mu$ V/m)	Peak Limit at 3m (dB $\mu$ V/m)	Margin (dB)
V	2483.500	58.3	33	29.4	54.7	74.0	-19.3
H	4960.000	42.7	33	34.9	44.6	74.0	-29.4
V	7440.000	39.2	33	37.9	44.1	74.0	-29.9
V	12400.000	31.0	33	40.5	38.5	74.0	-35.6

- NOTES:
1. Peak detector and Average detector is used for the emission measurement.
  2. Average detector is used for the average data of emission measurement
  3. All measurements were made at 3 meters.
  4. Negative value in the margin column shows emission below limit.
  5. Horn antenna is used for the emission over 1000MHz.
  6. Emission within the restricted band meets the requirement of FCC Part 15 Section 15.205 / RSS-Gen Section 8.10.

**TEST REPORT**

Mode: TX-Channel 01

**Table 7**  
**IEEE 802.11n (20MHz) (OFDM, MCS0)**

Polarization	Frequency (MHz)	Reading (dBμV)	Pre-Amp Gain (dB)	Antenna Factor (dB)	Net at 3m (dBμV/m)	Average Factor (dB)	Calculated at 3m (dBμV/m)	Average Limit at 3m (dBμV/m)	Margin (dB)
V	2390.000	45.8	33	29.4	42.2	0	42.2	54.0	-11.8
V	4804.000	39.9	33	34.9	41.8	0	41.8	54.0	-12.2
H	12010.000	23.4	33	40.5	30.9	0	30.9	54.0	-23.2

Polarization	Frequency (MHz)	Reading (dBμV)	Pre-Amp Gain (dB)	Antenna Factor (dB)	Net at 3m - Peak (dBμV/m)	Peak Limit at 3m (dBμV/m)	Margin (dB)
V	2390.000	58.3	33	29.4	54.7	74.0	-19.3
V	4804.000	45.6	33	34.9	47.5	74.0	-26.5
H	12010.000	30.8	33	40.5	38.3	74.0	-35.8

- NOTES:
1. Peak detector and Average detector is used for the emission measurement.
  2. Average detector is used for the average data of emission measurement
  3. All measurements were made at 3 meters.
  4. Negative value in the margin column shows emission below limit.
  5. Horn antenna is used for the emission over 1000MHz.
  6. Emission within the restricted band meets the requirement of FCC Part 15 Section 15.205 / RSS-Gen Section 8.10.

**TEST REPORT**

Mode: TX-Channel 06

Table 8  
IEEE 802.11n (20MHz) (OFDM, MCS0)

Polarization	Frequency (MHz)	Reading (dBμV)	Pre-Amp Gain (dB)	Antenna Factor (dB)	Net at 3m (dBμV/m)	Average Factor (dB)	Calculated at 3m (dBμV/m)	Average Limit at 3m (dBμV/m)	Margin (dB)
V	4882.000	34.1	33	34.9	36.0	0	36.0	54.0	-18.0
H	7323.000	23.9	33	37.9	28.8	0	28.8	54.0	-25.2
V	12205.000	22.4	33	40.5	29.9	0	29.9	54.0	-24.1

Polarization	Frequency (MHz)	Reading (dBμV)	Pre-Amp Gain (dB)	Antenna Factor (dB)	Net at 3m - Peak (dBμV/m)	Peak Limit at 3m (dBμV/m)	Margin (dB)
V	4882.000	42.4	33	34.9	44.3	74.0	-29.7
H	7323.000	33.3	33	37.9	38.2	74.0	-35.8
V	12205.000	31.2	33	40.5	38.7	74.0	-35.3

- NOTES:
1. Peak detector and Average detector is used for the emission measurement.
  2. Average detector is used for the average data of emission measurement
  3. All measurements were made at 3 meters.
  4. Negative value in the margin column shows emission below limit.
  5. Horn antenna is used for the emission over 1000MHz.
  6. Emission within the restricted band meets the requirement of FCC Part 15 Section 15.205 / RSS-Gen Section 8.10.



**TEST REPORT**

Mode: TX-Channel 11

Table 9  
IEEE 802.11n (20MHz) (OFDM, MCS0)

Polarization	Frequency (MHz)	Reading (dBμV)	Pre-Amp Gain (dB)	Antenna Factor (dB)	Net at 3m (dBμV/m)	Average Factor (dB)	Calculated at 3m (dBμV/m)	Average Limit at 3m (dBμV/m)	Margin (dB)
V	2483.500	44.0	33	29.4	40.4	0	40.4	54.0	-13.6
V	4960.000	36.3	33	34.9	38.2	0	38.2	54.0	-15.8
H	7440.000	25.1	33	37.9	30.0	0	30.0	54.0	-24.0
H	12400.000	23.0	33	40.5	30.5	0	30.5	54.0	-23.5

Polarization	Frequency (MHz)	Reading (dBμV)	Pre-Amp Gain (dB)	Antenna Factor (dB)	Net at 3m - Peak (dBμV/m)	Peak Limit at 3m (dBμV/m)	Margin (dB)
V	2483.500	57.8	33	29.4	54.2	74.0	-19.8
V	4960.000	43.3	33	34.9	45.2	74.0	-28.8
H	7440.000	34.0	33	37.9	38.9	74.0	-35.1
H	12400.000	31.5	33	40.5	39.0	74.0	-35.0

- NOTES:
1. Peak detector and Average detector is used for the emission measurement.
  2. Average detector is used for the average data of emission measurement
  3. All measurements were made at 3 meters.
  4. Negative value in the margin column shows emission below limit.
  5. Horn antenna is used for the emission over 1000MHz.
  6. Emission within the restricted band meets the requirement of FCC Part 15 Section 15.205 / RSS-Gen Section 8.10.

**TEST REPORT**

Mode: WiFi Operating

Table 10

Polarization	Frequency (MHz)	Reading (dBµV)	Pre-amp (dB)	Antenna Factor (dB)	Net at 3m (dBµV/m)	Limit at 3m (dBµV/m)	Margin (dB)
V	55.591	34.2	16	11.0	29.2	40.0	-10.8
<b>V</b>	<b>119.941</b>	<b>35.2</b>	<b>16</b>	<b>14.0</b>	<b>33.2</b>	<b>43.5</b>	<b>-10.4</b>
V	200.001	38.1	16	16.0	38.1	43.5	-5.4
H	312.016	31.8	16	23.0	38.8	46.0	-7.2
<b>V</b>	<b>400.009</b>	<b>29.8</b>	<b>16</b>	<b>24.0</b>	<b>37.8</b>	<b>46.0</b>	<b>-8.2</b>
<b>H</b>	<b>960.025</b>	<b>27.2</b>	<b>16</b>	<b>33.0</b>	<b>44.2</b>	<b>54.0</b>	<b>-9.8</b>

- NOTES:
1. Peak detector is used for the emission measurement.
  2. All measurements were made at 3 meters.
  3. Negative value in the margin column shows emission below limit.
  4. Emission (the row indicated by **bold italic**) within the restricted band meets the requirement of FCC Part 15 Section 15.205 / RSS-Gen Section 8.10.

**TEST REPORT**

4.6.3 Radiated Emission Test Setup

The figure below shows the test setup, which is utilized to make these measurements.

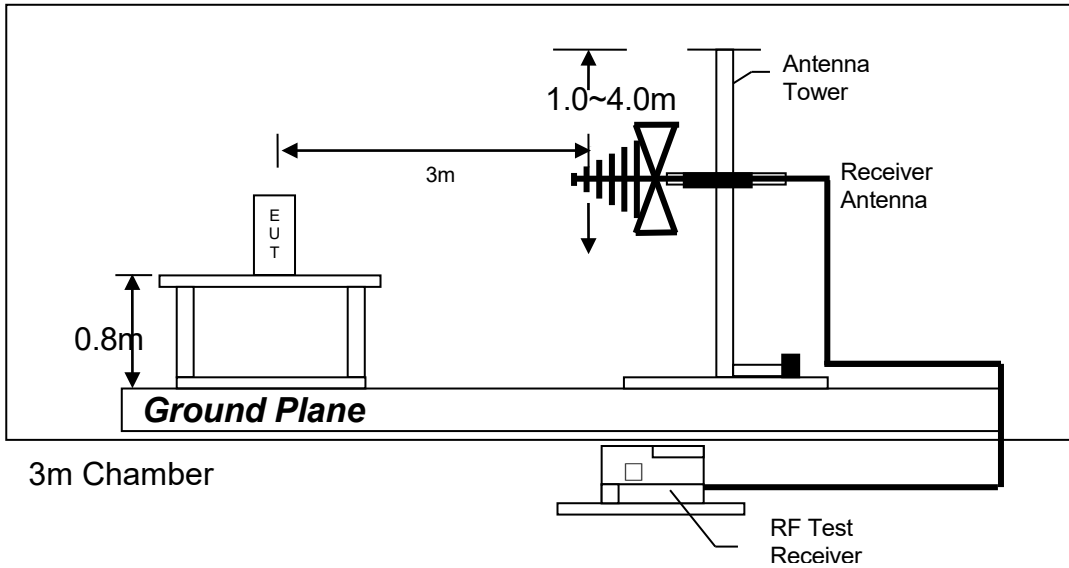

Test setup of radiated emissions up to 1GHz

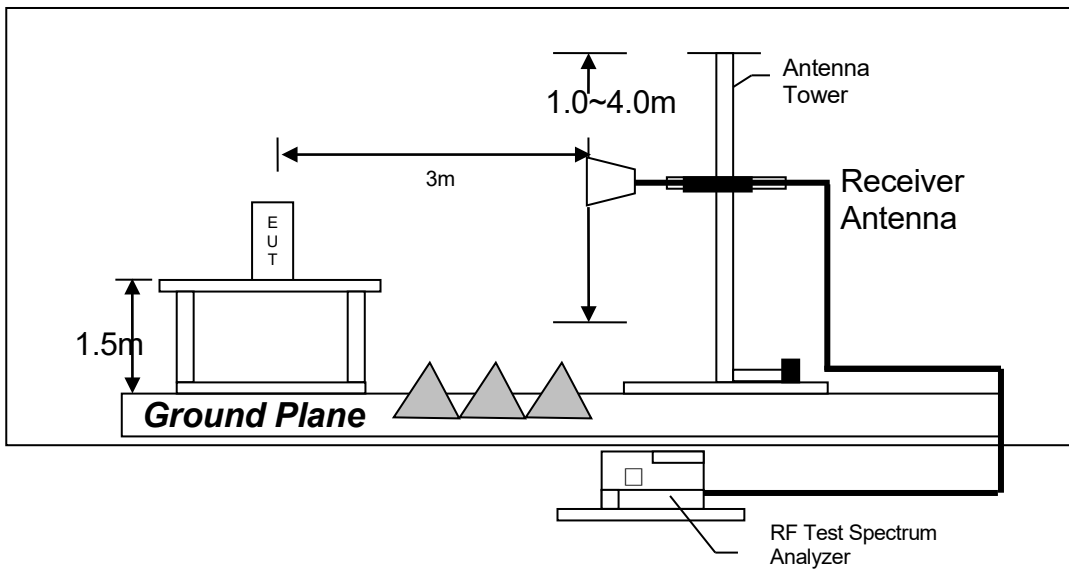

Test setup of radiated emissions above 1GHz

## TEST REPORT

### 4.6.4 Transmitter Duty Cycle Calculation

Not applicable – No average factor is required.

## TEST REPORT

### 4.7 AC Power Line Conducted Emission

- Not applicable – EUT is only powered by battery for operation.
- EUT connects to AC power line. Emission Data is listed in following pages.
  
- Base Unit connects to AC power line and has transmission. Handset connects to AC power line but has no transmission. Emission Data of Base Unit is listed in following pages.

#### 4.7.1 AC Power Line Conducted Emission Configuration Photograph

Worst Case Line-Conducted Configuration  
at

424.5 kHz

The worst case line conducted configuration photographs are attached in the Appendix and saved with filename: config photos.pdf

#### 4.7.2 AC Power Line Conducted Emission Data

The plot(s) and data in the following pages list the significant emission frequencies, the limit and the margin of compliance.

Passed by 1.38 dB margin compare with CISPR Average limit

**TEST REPORT**

**AC POWER LINE CONDUCTED EMISSION**

Worst Case: WiFi Operating

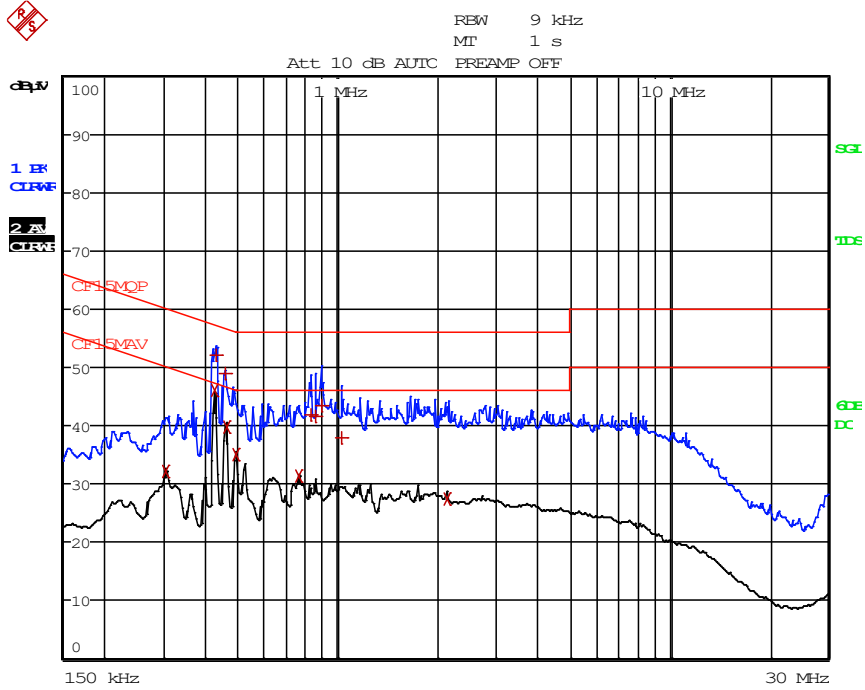

**TEST REPORT**

Worst Case: WiFi Operating

EDIT PEAK LIST (Final Measurement Results)				
Trace1:	CF15MQP			
Trace2:	CF15MAV			
Trace3:	---			
TRACE	FREQUENCY	LEVEL dBµV		DELTA LIMIT dB
2 CISPR Average	303 kHz	32.20	L1	-17.95
2 CISPR Average	424.5 kHz	45.97	L1	-1.38
1 Quasi Peak	429 kHz	52.06	N	-5.21
1 Quasi Peak	456 kHz	48.98	N	-7.78
2 CISPR Average	460.5 kHz	39.84	L1	-6.84
2 CISPR Average	492 kHz	35.13	L1	-10.99
2 CISPR Average	766.5 kHz	31.34	L1	-14.65
1 Quasi Peak	829.5 kHz	41.76	L1	-14.23
1 Quasi Peak	856.5 kHz	41.60	N	-14.39
1 Quasi Peak	892.5 kHz	43.38	L1	-12.61
1 Quasi Peak	1.032 MHz	38.01	L1	-17.98
2 CISPR Average	2.148 MHz	27.46	L1	-18.53

## TEST REPORT

### 4.7.3 Conducted Emission Test Setup

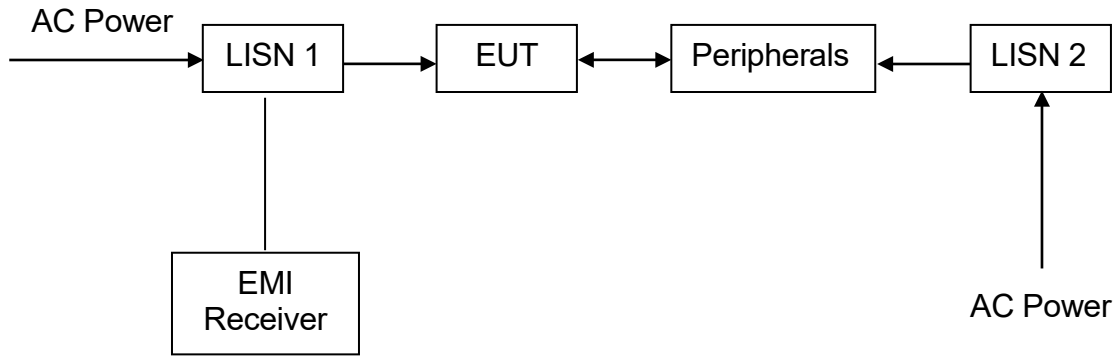



## TEST REPORT

### 5.0 EQUIPMENT LIST

#### 1) Radiated Emissions Test

Equipment	EMI Test Receiver (9kHz to 26.5GHz)	Spectrum Analyzer	BiConiLog Antenna (30MHz - 6GHz)
Registration No.	EW-3156	EW-2466	EW-3408
Manufacturer	ROHDESCHWARZ	ROHDESCHWARZ	EMCO
Model No.	ESR26	FSP30	
Calibration Date	January 25, 2021	September 05, 2020	October 25, 2020
Calibration Due Date	January 25, 2022	September 05, 2021	October 25, 2021

Equipment	14m Double Shield RF Cable (20MHz to 6GHz)	Double Ridged Guide Antenna	RF Cable 14m (1GHz to 26.5GHz)
Registration No.	EW-2074	EW-1133	EW-2781
Manufacturer	RADIALL	EMCO	GREATBILLION
Model No.	N(m)-RG142-BNC(m) L=14M	3115	SMA m/SHF5MPU /SMA m ra14m,26G
Calibration Date	August 29, 2020	June 03, 2021	November 24, 2020
Calibration Due Date	August 29, 2021	June 03, 2022	November 24, 2021

#### 2) Conducted Emissions Test

Equipment	RF Cable 240cm (RG142) (9kHz to 30MHz)	Artificial Mains Network	EMI Test Receiver
Registration No.	EW-2454	EW-2501	EW-2500
Manufacturer	RADIALL	ROHDESCHWARZ	ROHDESCHWARZ
Model No.	Bnc m st / 142 / bnc mra 240cm	ENV-216	ESCI
Calibration Date	November 10, 2020	September 11, 2020	March 29, 2021
Calibration Due Date	November 10, 2021	September 11, 2021	March 29, 2022

#### 3) Conductive Measurement Test

Equipment	5m RF Cable (40GHz)	RF Power Meter with Power Sensor (N1921A)	Spectrum Analyzer
Registration No.	EW-2701	EW-2270	EW-2466
Manufacturer	RADIALL	N/A	ROHDESCHWARZ
Model No.	sma m-m 5m 40G	AGILENTTECH	FSP30
Calibration Date	November 24, 2020	September 03, 2020	September 05, 2020
Calibration Due Date	November 24, 2021	September 03, 2021	September 05, 2021

**END OF TEST REPORT**