

IS9141
IS9141-2
IS9141-3
IS9141-4
IS9141-5

DECT 6.0
2-line corded/cordless
telephone
with BLUETOOTH®
wireless technology



Scan the QR code for
support information



US

CA

vtech®
Quick start guide

Important safety instructions



When using your telephone equipment, basic safety precautions should always be followed to reduce the risk of fire, electric shock and injury, including the following:

1. Read and understand all instructions.
2. Follow all warnings and instructions marked on the product.
3. Unplug this product from the wall outlet before cleaning. Do not use liquid or aerosol cleaners. Use a damp cloth for cleaning.
4. **CAUTION:** Do not install the telephone base at a height above 2 meters.
5. Do not use this product near water such as near a bath tub, wash bowl, kitchen sink, laundry tub or a swimming pool, or in a wet basement or shower.
6. Do not place this product on an unstable table, shelf, stand or other unstable surfaces.
7. Avoid placing the telephone system in places with extreme temperature, direct sunlight, or other electrical devices. Protect your phone from moisture, dust, corrosive liquids and fumes.
8. Slots and openings in the back or bottom of the telephone base and handset are provided for ventilation. To protect them from overheating, these openings must not be blocked by placing the product on a soft surface such as a bed, sofa or rug. This product should never be placed near or over a radiator or heat register. This product should not be placed in any area where proper ventilation is not provided.
9. This product should be operated only from the type of power source indicated on the marking label. If you are not sure of the type of power supply in your home or office, consult your dealer or local power company.
10. Do not allow anything to rest on the power cord. Do not install this product where the cord may be walked on.
11. Never push objects of any kind into this product through the slots in the

telephone base or handset because they may touch dangerous voltage points or create a short circuit. Never spill liquid of any kind on the product.

12. To reduce the risk of electric shock, do not disassemble this product, but take it to an authorized service facility. Opening or removing parts of the telephone base or handset other than specified access doors may expose you to dangerous voltages or other risks. Incorrect reassembling can cause electric shock when the product is subsequently used.
13. Do not overload wall outlets and extension cords.
14. Unplug this product from the wall outlet and refer servicing to an authorized service facility under the following conditions:
 - When the power supply cord or plug is damaged or frayed.
 - If liquid has been spilled onto the product.
 - If the product has been exposed to rain or water.
 - If the product does not operate normally by following the operating instructions. Adjust only those controls that are covered by the operation instructions. Improper adjustment of other controls may result in damage and often requires extensive work by an authorized technician to restore the product to normal operation.
 - If the product has been dropped and the telephone base and/or handset has been damaged.
 - If the product exhibits a distinct change in performance.
15. Avoid using a telephone (other than cordless) during an electrical storm. There is a remote risk of electric shock from lightning.
16. Do not use the telephone to report a gas leak in the vicinity of the leak. Under certain circumstances, a spark may be created when the adapter is plugged into the power outlet, or when the handset is replaced in its cradle. This is

a common event associated with the closing of any electrical circuit. The user should not plug the phone into a power outlet, and should not put a charged handset into the cradle, if the phone is located in an environment containing concentrations of flammable or flame-supporting gases, unless there is adequate ventilation. A spark in such an environment could create a fire or explosion. Such environments might include: medical use of oxygen without adequate ventilation; industrial gases (cleaning solvents; gasoline vapors; etc.); a leak of natural gas; etc.

17. Only put the handset of your telephone next to your ear when it is in normal talk mode.
18. The power adapter is intended to be correctly oriented in a vertical or floor mount position. The prongs are not designed to hold the plug in place if it is plugged into a ceiling, under-the-table or cabinet outlet.
19. For pluggable equipment, the socket-outlet shall be installed near the equipment and shall be easily accessible.
20.   **CAUTION:** Use only the batteries indicated in this manual. There may be a risk of explosion if a wrong type of battery is used for the handset. Use only the supplied rechargeable batteries or replacement batteries (BT162342/BT262342) for the handset. Do not dispose of batteries in a fire. They may explode. Dispose of used battery according to the instruction.
 - Do not use the battery in following conditions:
 - High or low extreme temperature during use, storage or transportation.
 - Replacement of a battery with an incorrect type that can defeat a safeguard.
 - Disposal of a battery into fire or a hot oven, or mechanically crushing or cutting of a battery, that can result in an explosion.

- Leaving a battery in an extremely high temperature surrounding environment that can result in an explosion or the leakage of flammable liquid or gas.
 - A battery subjected to extremely low air pressure that can result in an explosion or the leakage of flammable liquid or gas.
21. Use only the adapter included with this product. Incorrect adapter polarity or voltage can seriously damage the product.
 22. The applied nameplate is located at the bottom or near of the product.

SAVE THESE INSTRUCTIONS

Battery

- Use only the batteries provided or equivalent. To order a replacement, visit our website at www.vtechphones.com or call 1 (800) 595-9511. In Canada, go to phones.vtechcanada.com or call 1 (800) 267-7377.
- Do not dispose of the battery in a fire. Check with local waste management codes for special disposal instructions.
- Do not open or mutilate the battery. Released electrolyte is corrosive and may cause burns or injury to the eyes or skin. The electrolyte may be toxic if swallowed.
- Exercise care in handling batteries in order not to create a short circuit with conductive materials.
- Charge the battery provided with this product only in accordance with the instructions and limitations specified in this manual.

Precautions for users of implanted cardiac pacemakers

Cardiac pacemakers (applies only to digital cordless telephones):
Wireless Technology Research, LLC (WTR), an independent research entity, led a multidisciplinary evaluation of the interference between portable wireless

telephones and implanted cardiac pacemakers. Supported by the U.S. Food and Drug Administration, WTR recommends to physicians that:

Pacemaker patients

- Should keep wireless telephones at least six inches from the pacemaker.
- Should NOT place wireless telephones directly over the pacemaker, such as in a breast pocket, when it is turned ON.
- Should use the wireless telephone at the ear opposite the pacemaker.

WTR's evaluation did not identify any risk to bystanders with pacemakers from other persons using wireless telephones.

About cordless telephones

- **Privacy:** The same features that make a cordless telephone convenient create some limitations. Telephone calls are transmitted between the telephone base and the cordless handset by radio waves, so there is a possibility that the cordless telephone conversations could be intercepted by radio receiving equipment within range of the cordless handset. For this reason, you should not think of cordless telephone conversations as being as private as those on corded telephones.
- **Electrical power:** The telephone base of this cordless telephone must be connected to a working electrical outlet. The electrical outlet should not be controlled by a wall switch. Calls cannot be made from the cordless handset if the telephone base is unplugged, switched off or if the electrical power is interrupted.
- **Potential TV interference:** Some cordless telephones operate at frequencies that may cause interference to televisions and VCRs. To minimize or prevent such interference, do not place the telephone base of the cordless telephone near or on top of a TV or VCR. If interference is experienced, moving the cordless telephone farther away from the TV or VCR often reduces or eliminates the

interference.

- **Rechargeable batteries:** Exercise care in handling batteries in order not to create a short circuit with conducting material such as rings, bracelets and keys. The battery or conductor may overheat and cause harm. Observe proper polarity between the battery and the battery charger.
- **Nickel-metal hydride rechargeable batteries:** Dispose of these batteries in a safe manner. Do not burn or puncture the battery. Like other batteries of this type, if burned or punctured, they could release caustic material which could cause injury.

ECO mode

This power conserving technology reduces power consumption for optimal battery performance. The ECO mode activities automatically whenever the handset is synchronized with the telephone base.

For C-UL compliance only

Mesures de sécurité importantes

Afin de réduire les risques d'incendie, de blessures corporelles ou d'électrocution, suivez toujours ces mesures préventives de base lorsque vous utilisez votre téléphone :

1. Lisez et comprenez bien toutes les instructions.
2. Observez toutes les instructions et mises en garde inscrites sur l'appareil.
3. Débranchez ce téléphone de la prise murale avant de le nettoyer. N'utilisez pas de nettoyeurs liquides ni en aérosol. N'utilisez qu'un chiffon doux et légèrement humecté.
4. ATTENTION: Ne pas installer le socle téléphonique à une hauteur supérieure à 2 mètres.
5. N'utilisez pas ce produit près de l'eau, tel que près d'un bain, d'un lavabo, d'un évier de cuisine, d'un bac de lavage ou d'une piscine, ou dans un sous-sol humide ou sous la douche.

6. Ne déposez pas ce téléphone sur un chariot, support ou table chancelants. L'appareil pourrait tomber et être sérieusement endommagé.
7. Évitez d'installer le système téléphonique dans les endroits soumis à une température extrême, à la lumière directe du soleil ou à proximité immédiate d'autres appareils électriques ou électroniques. Protégez votre téléphone contre les sources d'humidité, la poussière, les vapeurs et les liquides corrosifs.
8. Le boîtier de l'appareil est doté de fentes et d'ouvertures d'aération situées à l'arrière ou en dessous. Afin d'empêcher la surchauffe, ces ouvertures ne doivent pas être obstruées en plaçant l'appareil sur un lit, divan, tapis ou autre surface similaires. Ne placez pas cet appareil proximité d'un élément de chauffage ni d'une plinthe électrique. De plus, ne l'installez pas dans une unité murale ou un cabinet fermé qui ne possède pas d'aération adéquate.
9. Ne faites fonctionner cet appareil qu'avec le type d'alimentation indiqué sur les étiquettes de l'appareil. Si vous ne connaissez pas le voltage de votre maison, consultez votre marchand ou votre fournisseur d'électricité.
10. Ne déposez rien sur le cordon d'alimentation. Installez cet appareil dans un endroit sécuritaire, là où personne ne pourra trébucher sur la ligne d'alimentation ni le cordon téléphonique modulaire.
11. N'insérez jamais d'objets à travers les fentes et ouvertures de cet appareil, car ils pourraient toucher à des points de tension dangereux ou court-circuiter des pièces, ce qui constituerait un risque d'incendie ou d'électrocution. N'échappez pas de liquides dans l'appareil.
12. Afin de réduire les risques d'électrocution, ne démontez pas l'appareil, mais apportez-le plutôt à un centre de service qualifié s'il doit être réparé. En enlevant

le couvercle, vous vous exposez à des tensions dangereuses ou autres dangers similaires. Un remontage inadéquat peut être à l'origine d'une électrocution lors d'une utilisation ultérieure de l'appareil. Débranchez l'appareil avant de procéder au nettoyage. Utilisez un chiffon humide et doux.

13. Ne surchargez pas les prises de courant et les rallonges.
14. Débranchez cet appareil de la prise de courant et communiquez avec le département de service à la clientèle de VTech dans les cas suivants:
 - Lorsque le cordon d'alimentation est endommagé ou écorché.
 - Si du liquide a été échappé dans l'appareil.
 - Si l'appareil a été exposé une source d'humidité telle que la pluie ou l'eau.
 - Si le produit ne fonctionne pas normalement en respectant les instructions de fonctionnement. Réglez uniquement les commandes indiquées dans les instructions de fonctionnement. Les réglages incorrects des autres commandes pourraient provoquer un dommage qui pourrait exiger un travail exhaustif de la part d'un technicien autorisé afin de rétablir le fonctionnement normal de l'appareil.
 - Si le produit a été échappé et que le socle et/ ou le combiné a été endommagé.
 - Si le produit affiche une nette diminution de sa performance.
15. Évitez d'utiliser un téléphone (autre qu'un sans fil) pendant un orage. Les éclairs peuvent être à l'origine d'une électrocution.
16. N'utilisez pas le téléphone pour rapporter une fuite de gaz à proximité de la fuite. En certaines circonstances, une flammèche pourrait être provoquée lorsque l'adaptateur est branché à une prise de courant, ou lorsque le combiné est déposé sur le socle. Ceci est un événement commun associé à la fermeture d'un circuit électrique.

L'utilisateur ne devrait pas brancher le téléphone à une prise de courant, et ne devrait pas déposer le combiné chargé sur le socle, si le téléphone se trouve à proximité d'un endroit comportant des concentrations de gaz inflammables, moins que la ventilation soit adéquate. Une flammèche dans un tel endroit pourrait provoquer un incendie ou une explosion. De tels environnements peuvent comprendre: des endroits où l'on utilise de l'oxygène médical sans ventilation adéquate; des gaz industriels (dissolvants de nettoyage, des vapeurs d'essence, etc.); une fuite de gaz naturel, etc.

- Ne placez que le combiné de votre téléphone près de votre oreille lorsqu'en mode de conversation.
- Ces adaptateurs ont été conçus pour être orientés en position verticale ou montés au sol. Les broches ne sont pas conçues pour maintenir l'adaptateur en place si celui-ci est barché dans une prise au plafond ou sous une table/ armoire.

- Pour le MATÉRIEL RACCORDE PAR PRISE DE COURANT, le socle de prise de courant doit être installé à proximité du matériel et doit être aisément accessible.

-   **MISE EN GARDE:** Il peut y avoir un risque d'explosion si vous utilisez le mauvais type de piles pour le téléphone. N'utilisez que les piles rechargeable inclus ou les piles de rechange (BT162342/BT262342). N'incinerez pas les piles. Celles-ci risqueraient d'exploser. Mettre au rebut les batteries usagées conformément aux instructions du fabricant.

- Évitez d'utiliser la batterie dans les conditions suivantes:
 - des températures extrêmes faibles ou élevées auxquelles une batterie peut être soumise pendant l'utilisation, le stockage ou le transport.
 - remplacement d'une batterie par un type incorrect pouvant supprimer une protection.

- mise au rebut d'une batterie dans un feu ou dans un four chaud, ou écrasement mécanique ou coupure d'une batterie, susceptible de provoquer une explosion.
- maintien d'une batterie dans un environnement à très haute température pouvant provoquer une explosion ou la fuite de liquide ou de gaz inflammables.
- batterie soumise à une pression de l'air extrêmement faible pouvant provoquer une explosion ou la fuite de liquide ou de gaz inflammables.

- N'utilisez que les adaptateurs inclus avec ce produit. L'utilisation d'un adaptateur dont la polarité ou la tension serait inadéquate risque d'endommager sérieusement le produit et mettre votre sécurité en péril.
- La plaque signalétique appliquée est située au bas ou à proximité du produit.

CONSERVEZ CES INSTRUCTIONS

Pile

- N'utilisez que la pile incluse ou l'équivalent. Pour commander une pile de recharge, visitez notre site Web au www.vtechphones.com ou composez le 800-595-9511. Au Canada, visitez les phones. phones.vtechcanada.com ou composez le 800-267-7377.
- Ne jetez pas la pile au feu. Vérifiez les instructions spécifiques de mise au rebut auprès des autorités locales.
- N'ouvrez pas et ne mutilez pas la pile. L'électrolyte qui s'en échapperait est corrosif et pourrait causer des brûlures ou des blessures aux yeux ou à la peau. L'électrolyte est toxique si avalé.
- Soyez prudents lorsque vous manipulez les piles afin d'éviter les courts-circuits provoqués par des matériaux conducteurs.
- Rechargez la pile incluse avec cet appareil, selon les instructions et limites spécifiées dans ce guide d'utilisation.

Stimulateurs cardiaques implantés dans l'organisme

Les simulateurs cardiaques (s'applique uniquement aux téléphones numériques sans fil):

L'organisme 'Wireless Technology Research, LLC (WTR)', une firme de recherche indépendante, a mené une évaluation pluridisciplinaire des interférences entre les téléphones sans fil portatifs et les stimulateurs cardiaques implantés dans l'organisme. Appuyée par l'Administration des aliments et drogues (FDA) des États-Unis, la firme WTR recommande aux médecins:

Avis aux détenteurs de stimulateurs cardiaques

- Ils doivent tenir le téléphone sans fil à une distance d'au moins six pouces du stimulateur cardiaque.
- Ils ne doivent PAS placer le téléphone sans fil directement sur le stimulateur cardiaque, tel que dans une poche de chemise, lorsque celui-ci est en marche.
- Ils doivent utiliser le téléphone sans fil en l'appuyant sur l'oreille qui se trouve dans la direction opposée au stimulateur cardiaque.

L'étude effectuée par l'organisme WRS n'a pas identifié de risque pour les détenteurs de simulateurs cardiaques causés par les gens qui utilisent un téléphone sans fil à proximité de ceux-ci.

À propos des téléphones sans fil

- Alimentation électrique: Les mêmes caractéristiques qui constituent des avantages pour les téléphones sans fil affichent également des restrictions. Les appels téléphoniques sont transmis entre le combiné sans fil et le socle par le biais d'ondes radio ; il y a donc la possibilité que vos conversations téléphoniques sans fil soient interceptées par des équipements de réception radio se trouvant dans la portée du combiné sans fil. Pour cette raison, vous ne devez pas percevoir les communications téléphoniques sans fil comme étant aussi

confidentielles.

- Alimentation électrique: Le socle de ce téléphone sans fil doit être branché à une prise électrique fonctionnelle. La prise électrique ne doit pas être contrôlée par un interrupteur mural. Les appels ne pourront pas être effectués du combiné sans fil si le socle est débranché ou mis hors tension ou si le courant est coupé.
- Possibilité d'interférences aux téléviseurs: Certains téléphones sans fil fonctionnent sur des fréquences pouvant causer des interférences aux téléviseurs et aux magnétoscopes. Pour réduire ou prévenir de telles interférences, ne placez pas le socle du téléphone sans fil près ou sur un téléviseur ou magnétoscope. S'il y a présence de parasites, il est conseillé d'éloigner le téléphone sans fil du téléviseur ou du magnétoscope afin de réduire possiblement les interférences.
- Piles rechargeables: Manipulez les piles avec soin afin de ne pas les court-circuiter avec des bagues, bracelets ou clés. Les piles ou le conducteur peut surchauffer et causer des blessures. Respectez la polarité adéquate entre la pile et le chargeur.
- Les bloc-piles rechargeables à l'hydreure métallique de nickel: Jetez ces blocs-piles de manière écologique et sécuritaire. Ne les incinerez pas et ne les percez pas. Tel que les autres piles de ce type, elles pourraient dégager une matière toxique qui peut causer des blessures corporelles si elles sont brûlées ou percées.

The RBRC Seal

The RBRC Seal on the nickel-metal hydride battery indicates that VTech Communications, Inc. is voluntarily participating in an industry program to collect and recycle these batteries at the end of their useful lives, when taken out of service within the United States and Canada.

The program provides a convenient alternative to placing used nickel-metal hydride batteries into the trash or municipal waste, which may be illegal in your area.

VTech's participation makes it easy for you to drop off the spent battery at local retailers participating in the program or at authorized VTech product service centers. Please call **1 (800) 8 BATTERY®** for information on Ni-MH battery recycling and disposal bans/restrictions in your area.

VTech's involvement in this program is part of its commitment to protecting our environment and conserving natural resources.

The RBRC Seal and 1 (800) 8 BATTERY® are registered trademarks of Call2recycle, Inc.



FCC, ACTA and IC regulations

FCC Part 15

NOTE: This equipment has been tested and found to comply with the requirements for a Class B digital device under Part 15 of the Federal Communications Commission (FCC) rules. These requirements are intended to provide reasonable protection against harmful interference in a residential installation. This equipment generates, uses and can radiate radio frequency energy and, if not installed and used in accordance with the instructions, may cause harmful interference to radio communications. However, there is no guarantee that interference will not occur in a particular installation. If this equipment does cause harmful interference to radio or television reception, which can be determined by turning the equipment off and on, the user is encouraged to try to correct the interference by one or more of the following measures:

- Reorient or relocate the receiving antenna.
- Increase the separation between the equipment and receiver.
- Connect the equipment into an outlet on a circuit different from that to which the receiver is connected.
- Consult the dealer or an experienced radio/TV technician for help.

WARNING: Changes or modifications to this equipment not expressly approved by the party responsible for compliance could void the user's authority to operate the equipment.

This device complies with Part 15 of the FCC rules. Operation is subject to the following two conditions:

(1) this device may not cause harmful interference, and

(2) this device must accept any interference received, including interference that may cause undesired operation. Privacy of communications may not be ensured when using this telephone.

To ensure safety of users, the FCC/ISED has established criteria for the amount of

radio frequency energy that can be safely absorbed by a user or bystander according to the intended usage of the product. This product has been tested and found to comply with the FCC/ISED criteria. The handset may be safely held against the ear of the user. The telephone base shall be installed and used such that parts of the user's body other than the hands are maintained at a distance of approximately 20 cm (8 inches) or more.

This Class B digital apparatus complies with Canadian requirement:
CAN ICES-3 (B)/NMB-3(B).

FCC Part 68 and ACTA

This equipment complies with Part 68 of the FCC rules and with technical requirements adopted by the Administrative Council for Terminal Attachments (ACTA). The label on the back or bottom of this equipment contains, among other things, a product identifier in the format US:AAAEQ##TXXXX. This identifier must be provided to your telephone service provider upon request. The plug and jack used to connect this equipment to premises wiring and the telephone network must comply with applicable Part 68 rules and technical requirements adopted by ACTA. A compliant telephone cord and modular plug is provided with this product. It is designed to be connected to a compatible modular jack that is also compliant. An RJ11 jack should normally be used for connecting to a single line and an RJ14 jack for two lines. See the installation instructions in the user's manual. The Ringer Equivalence Number (REN) is used to determine how many devices you may connect to your telephone line and still have them ring when you are called. The REN for this product is encoded as the 6th and 7th characters following the US: in the product identifier (e.g., if ## is 03, the REN is 0.3). In most, but not all areas, the sum of all RENs should be five (5.0) or less. For more information, please contact your telephone service provider.

This equipment may not be used with Party Lines. If you have specially wired alarm dialing equipment connected to your telephone line, ensure the connection of this equipment does not disable your alarm equipment. If you have questions about what will disable alarm equipment, consult your telephone service provider or a qualified installer.

If this equipment is malfunctioning, it must be unplugged from the modular jack until the problem has been corrected. Replacement of this telephone equipment can only be made by the manufacturer or its authorized agents. For replacement procedures, follow the instructions outlined under the "Limited warranty".

If this equipment is causing harm to the telephone network, the telephone service provider may temporarily discontinue your telephone service. The telephone service provider is required to notify you before interrupting service. If advance notice is not practical, you will be notified as soon as possible. You will be given the opportunity to correct the problem and the telephone service provider is required to inform you of your right to file a complaint with the FCC. Your telephone service provider may make changes in its facilities, equipment, operation, or procedures that could affect the proper functioning of this product. The telephone service provider is required to notify you if such changes are planned.

If this product is equipped with a corded or cordless handset, it is hearing aid compatible.

If this product has memory dialing locations, you may choose to store emergency telephone numbers (e.g., police, fire, medical) in these locations. If you do store or test emergency numbers, please:

- Remain on the line and briefly explain the reason for the call before hanging up.
- Perform such activities in off-peak hours, such as early morning or late evening.

Industry Canada

This device contains licence-exempt transmitter(s)/receiver(s) that comply with Innovation, Science and Economic Development Canada's licence-exempt RSS(s).

Operation is subject to the following two conditions:

- (1) This device may not cause interference.
- (2) This device must accept any interference, including interference that may cause undesired operation of the device.

Privacy of communications may not be ensured when using this telephone.

The term "IC:" before the certification/registration number only signifies that the Industry Canada technical specifications were met.

The Ringer Equivalence Number (REN) for this terminal equipment is 0.1. The REN is an indication of the maximum number of devices allowed to be connected to a telephone interface. The termination on an interface may consist of any combination of devices subject only to the requirement that the sum of the RENs of all the devices does not exceed five.

This product meets the applicable Innovation, Science and Economic Development Canada technical specifications.

California Energy Commission Battery charging testing instructions

This telephone is set up to comply with the energy-conserving standards right out of the box. These instructions are intended for California Energy Commission (CEC) compliance testing only. When the CEC battery charging testing mode is activated, all telephone functions, except battery charging, will be disabled.

To activate the CEC battery charging testing mode:

1. Press the **MENU** soft key.
2. Press the **NEXT** soft key, and then press the **Setting** smart key.

3. Press the **NEXT** soft key, and then press the **Registration** smart key.
4. Press the **Deregister All** smart key.
5. When the telephone base displays **Deregister all devices?**, press the **YES** soft key.
6. The telephone base displays **Deregistered all devices** and you hear a confirmation tone.

When the phone successfully enters the CEC battery charging testing mode, all handsets show **To register, see user manual**.

When the phone fails to enter this mode, repeat all the steps mentioned above.

To deactivate the CEC battery charging testing mode:

Unplug the telephone base power adapter from the power outlet, then plug it back in. The telephone base is powered up as normal. Then, register your handsets to the telephone base:

1. Before you begin registration, make sure the handset is out of the charger and shows **To register, see see manual**.
2. Press the **MENU** soft key.
3. Press the **NEXT** soft key, and then press the **Setting** smart key.
4. Press the **NEXT** soft key, and then press the **Registration** smart key.
5. Press the **Register DECT device** smart key.
6. Place the handset on the charger or press **#** on the handset to register. Both telephone base screen and handset screen show **Registering... Please wait**. It takes up to 90 seconds to complete the registration process. Both the telephone base and cordless handset display **HANSET X Registered** (X represents the registered handset number), and beep when registration completes.

Limited warranty

What does this limited warranty cover?

The manufacturer of this VTech Product warrants to the holder of a valid proof of purchase ("Consumer" or "you") that the Product and all accessories provided in the sales package ("Product") are free from defects in material and workmanship, pursuant to the following terms and conditions, when installed and used normally and in accordance with the Product operating instructions. This limited warranty extends only to the Consumer for Products purchased and used in the United States of America and Canada.

What will VTech do if the Product is not free from defects in materials and workmanship during the limited warranty period ("Materially Defective Product")?

During the limited warranty period, VTech's authorized service representative will replace at VTech's option, without charge, a Materially Defective Product. If we replace the Product, we may use new or refurbished replacement parts. If we choose to replace the Product, we may replace it with a new or refurbished Product of the same or similar design. We will retain defective parts, modules, or equipment. Replacement of the Product, at VTech's option, is your exclusive remedy. VTech will return the replacement Products to you in working condition. You should expect the replacement to take approximately 30 days.

How long is the limited warranty period?

The limited warranty period for the Product extends for ONE (1) YEAR from the date of purchase. If VTech replaces a Materially Defective Product under the terms of this limited warranty, this limited warranty also applies to the replacement Product for a period of either (a) 90 days from the date the replacement Product is shipped to you or (b)

the time remaining on the original one-year warranty; whichever is longer.

What is not covered by this limited warranty?

This limited warranty does not cover:

1. Product that has been subjected to misuse, accident, shipping or other physical damage, improper installation, abnormal operation or handling, neglect, inundation, fire, water or other liquid intrusion.
2. Product that has been subjected to contact with liquid, water, rain, extreme humidity or heavy perspiration, sand, dirt or the like; but then only to the extent the damage was not caused by incorrectly securing the waterproof handset's protective elements, for example, failing to properly close a seal), or such protective elements are damaged or missing (e.g. a cracked battery door), or subjecting a Product to conditions beyond its stated specifications or limits (e.g. 30 minutes in 1 meter of fresh water).
3. Product that has been damaged due to repair, alteration or modification by anyone other than an authorized service representative of VTech;
4. Product to the extent that the problem experienced is caused by signal conditions, network reliability, or cable or antenna systems;
5. Product to the extent that the problem is caused by use with non-VTech accessories;
6. Product whose warranty/quality stickers, product serial number plates or electronic serial numbers have been removed, altered or rendered illegible;
7. Product purchased, used, serviced, or shipped for repair from outside the United States of America or Canada, or used for commercial or institutional purposes (including but not limited to Products used for rental purposes);
8. Product returned without a valid proof of purchase (see item 2 below); or

9. Charges for installation or set up, adjustment of customer controls, and installation or repair of systems outside the unit.

How do you get warranty service?

To obtain warranty service in the USA, please visit our website at www.vtechphones.com or call 1 (800) 595-9511.

To obtain warranty service in Canada, go to phones.vtechcanada.com or dial 1 (800) 267-7377.

NOTE: Before calling for service, please review the user's manual - a check of the Product's controls and features may save you a service call.

Except as provided by applicable law, you assume the risk of loss or damage during transit and transportation and are responsible for delivery or handling charges incurred in the transport of the Product(s) to the service location. VTech will return replaced Product under this limited warranty. Transportation, delivery or handling charges are prepaid.

VTech assumes no risk for damage or loss of the Product in transit. If the Product failure is not covered by this limited warranty, or proof of purchase does not meet the terms of this limited warranty, VTech will notify you and will request that you authorize the cost of replacement prior to any further replacement activity. You must pay for the cost of replacement and return shipping costs for the replacement of Products that are not covered by this limited warranty.

What must you return with the Product to get warranty service?

1. Return the entire original package and contents including the Product to the VTech service location along with a description of the malfunction or difficulty; and
2. Include a "valid proof of purchase" (sales receipt) identifying the Product purchased (Product model) and the date of purchase or receipt; and

3. Provide your name, complete and correct mailing address, and telephone number.

Other limitations

This warranty is the complete and exclusive agreement between you and VTech. It supersedes all other written or oral communications related to this Product. VTech provides no other warranties for this Product. The warranty exclusively describes all of VTech's responsibilities regarding the Product. There are no other express warranties. No one is authorized to make modifications to this limited warranty and you should not rely on any such modification. State/Provincial Law Rights: This warranty gives you specific legal rights, and you may also have other rights, which vary from state to state or province to province.

Limitations: Implied warranties, including those of fitness for a particular purpose and merchantability (an unwritten warranty that the Product is fit for ordinary use) are limited to one year from the date of purchase. Some states/provinces do not allow limitations on how long an implied warranty lasts, so the above limitation may not apply to you. In no event shall

VTech be liable for any indirect, special, incidental, consequential, or similar damages (including, but not limited to lost profits or revenue, inability to use the Product or other associated equipment, the cost of substitute equipment, and claims by third parties) resulting from the use of this Product. Some states/ provinces do not allow the exclusion or limitation of incidental or consequential damages, so the above limitation or exclusion may not apply to you.

Please retain your original sales receipt as proof of purchase.

Disclaimer and Limitation of Liability

VTech Communications, Inc. and its suppliers assume no responsibility for any damage or loss resulting from the use of this user's

manual. VTech Communications, Inc. and its suppliers assume no responsibility for any loss or claims by third parties that may arise through the use of this product.

Company: VTech Communications, Inc.

Address: 9020 SW Washington Square Road - Ste 555 Tigard, OR 97223, United States

Phone: 1 (800) 595-9511 in the U.S. or 1 (800) 267-7377 in Canada

Install Set up	4
What's in the box	4
Connect the telephone base	5
Connect the charger	6
Connect telephone base to fax machine/modem (optional)	6
Tabletop installation	6
Mount the telephone base (optional)	7
Install the battery	8
Charge the battery	8
Check for a dial tone	9
Overview	10
Display	18
Before use	20
Smart keys	22
Add a speed dial number	22
Add an emergency number	23
Add a menu option	23
Change a smart key function	24
Bluetooth	24
Add a Bluetooth cell phone / headset	24
Download your cell phone phonebook using the base	26
Disconnect/ reconnect your Bluetooth device	26
Edit / remove your Bluetooth cell phone or headset	26
Activate remote voice control	27

Operate	27	Answering system	43
Make a home call	27	About the built-in answering system and voicemail service	43
Make a cell call	27	Set number of rings	44
Make a smart key speed dial	28	Turn the built-in answering system on or off	45
Answer a home call	28	Message playback	45
Answer a cell call	28	Options while message playback	46
End a home call	28	Delete all old messages	47
End a cell call	28	Countdown timer	48
Adjust volume	28	Set the countdown timer	48
Caller ID	28	LCD language setting	49
Review caller ID log entries	28	Need help?	49
Save a caller ID log entry to phonebook	29		
Dial a caller ID log entry	30		
Delete a caller ID log entry	31		
Phonebook	32		
Add a phonebook entry	32		
Review phonebook entries	33		
Dial a phonebook entry	34		
Delete a phonebook entry	35		
Smart call blocker	36		
Turn on/off Smart call blocker	36		
Set up block list and star name list	38		
Scenarios of Smart call blocker configuration	40		
Block the caller while on a call	42		
Unblock a telephone number	42		

Install | Set up

What's in the box

Your telephone package contains the following items. Save your sales receipt and original packaging in case it is necessary to ship your telephone for warranty service.

You can add new handsets (IS9141/IS9141-2/ IS9141-3/ IS9141-4/ IS9141-5) to your telephone system. All accessories are sold separately. Your telephone base supports a maximum of five devices

NOTE

- To purchase replacement batteries or power adapters, visit our website at www.vtechphones.com or call 1 (800) 595-9511. In Canada, go to phones.vtechcanada.com or dial 1 (800) 267-7377.



- 2 set for IS9141-2
- 3 sets for IS9141-3
- 4 sets for IS9141-4
- 5 sets for IS9141-5

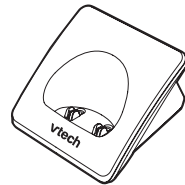
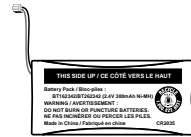

- 1 set for IS9141-2
- 2 sets for IS9141-3
- 3 sets for IS9141-4
- 4 sets for IS9141-5

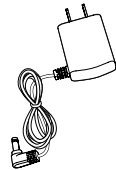

Connect the telephone base

Option 1: If you have separate wall jacks for each line, plug the black telephone line into **LINE 1/L1+L2** jack, and plug the clear telephone line into **LINE 2** jack.

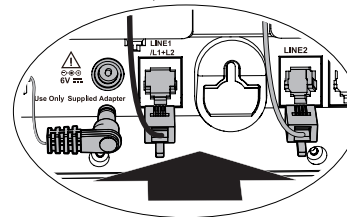
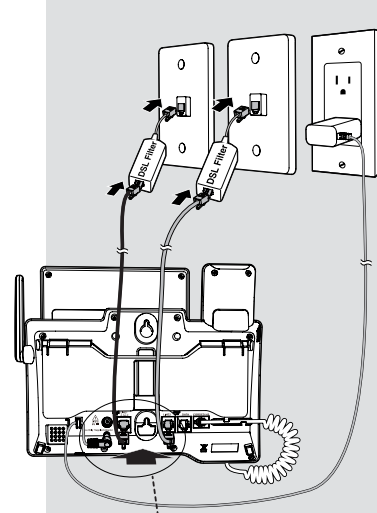

Option 2: If you have a 2-line wall jack, plug the black telephone line into the **LINE 1/L1+L2**.

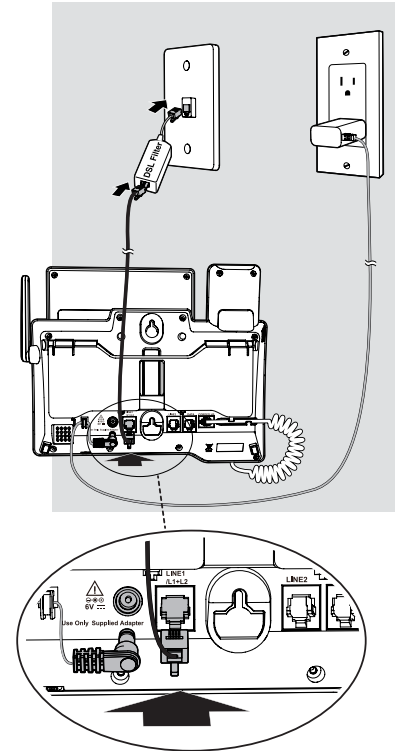

TIPS

- Your telephone is ready for tabletop use. If you want to mount the base, see **"Mount the telephone base (optional)"**.
- If you subscribe to digital subscriber line (DSL) high-speed Internet service through your telephone line, make sure you connect a DSL filter (not included) to the telephone wall jack.

Connect the charger

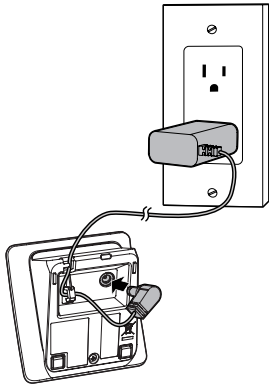

Connect telephone base to fax machine/modem (optional)

You may connect a fax machine or modem through the DATA port located at the back of the telephone base. The DATA port only uses LINE 2 to transmit data.

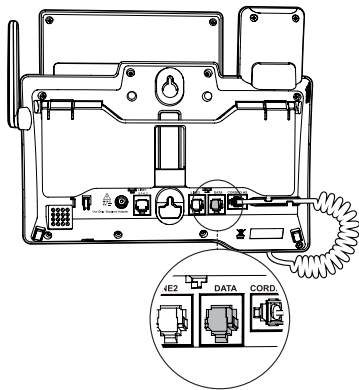

Tabletop installation

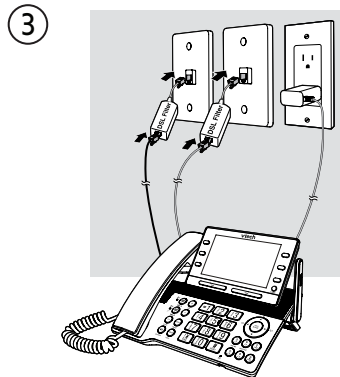
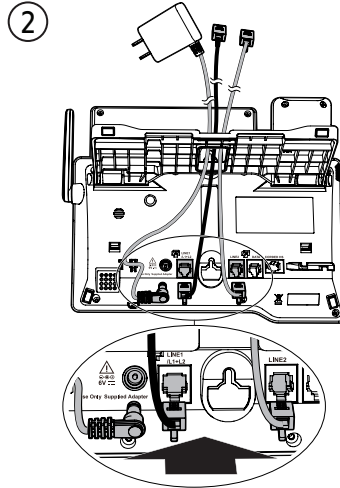
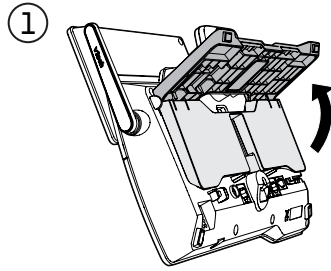

Mount the telephone base (optional)

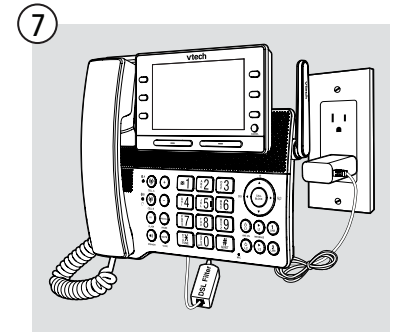
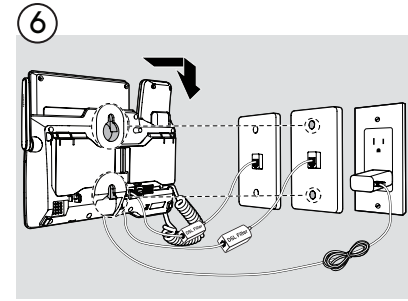
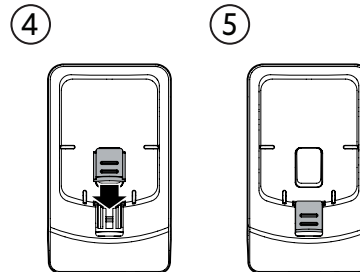
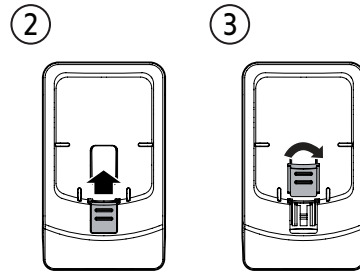
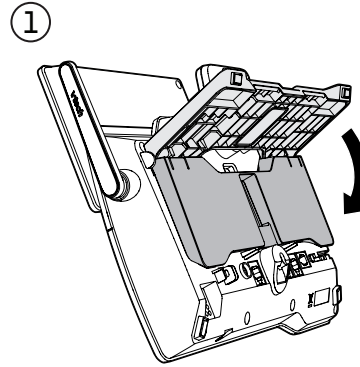

Install the battery

1. Plug the battery connector securely into the socket inside the handset battery compartment.
 - Make sure the battery label **THIS SIDE UP** is facing up, as indicated.

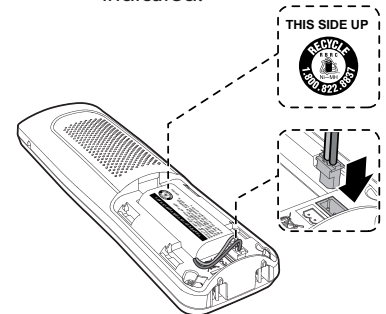

- Align the cover flat against the battery compartment, then slide it upwards until it clicks into place.

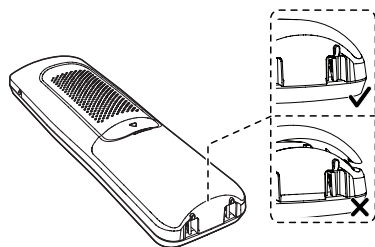
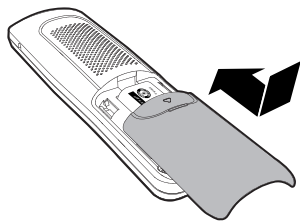

Charge the battery



The following table summarizes the battery indicators and actions to take.

Battery indicators	Battery status	Action
<ul style="list-style-type: none"> The screen is blank, or shows Put in charger and flashes. 	<ul style="list-style-type: none"> The battery has no charge or very little charge. The handset cannot be used. 	<ul style="list-style-type: none"> Charge without interruption (at least 30 minutes).
<ul style="list-style-type: none"> The screen shows Low battery and flashes. 	<ul style="list-style-type: none"> The battery has enough charge to be used for a short time. 	<ul style="list-style-type: none"> Charge without interruption (at least 30 minutes).
<ul style="list-style-type: none"> The screen shows HANDSET X. 	<ul style="list-style-type: none"> The battery is charged. 	<ul style="list-style-type: none"> To keep the battery charged, place it in the handset charger when not in use.

When it is fully charged, you can expect the following performance:

Operation	Operating time
Talk time (cordless handset)	• 10 hours
Talk time (cordless handset speakerphone)	• 4.5 hours
Standby	• 5 days

* Operating times vary depending on your actual use and the age of the battery.

Belt clip and optional corded headset

Attach belt clip

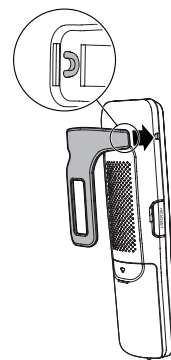

Remove belt clip

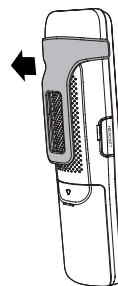

Optional corded headset

For handsfree telephone conversations, you may use any industry standard 2.5 mm headset (purchased separately).

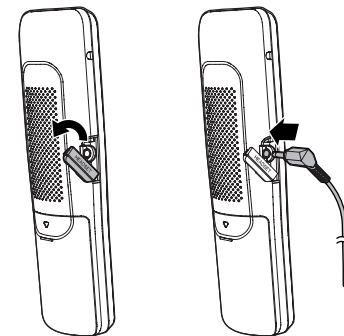

Check for a dial tone

Press **LINE 1** on the handset or **1** on the base. If you hear a dial tone, the installation is successful.

If you do not hear a dial tone

- Make sure the installation procedures are properly done.
- The handset may take a second or two to find the telephone base and produce a dial tone. This is normal. Wait an extra second before dialing.
- If the previous suggestions do not work, disconnect the telephone line cord from your telephone and connect the telephone line cord to another telephone.
- If there is no dial tone on that other telephone either, your telephone line cord may be defective. Install a new telephone line cord.

If changing the telephone line cord does not help, the wall jack (or the wiring to this wall jack) may be defective. Try using a different wall jack in your home to connect your IS9141/IS9141-2/IS9141-3/IS9141-4/IS9141-5 telephone, or contact your telephone service provider (charges may apply).

Overview

Telephone base

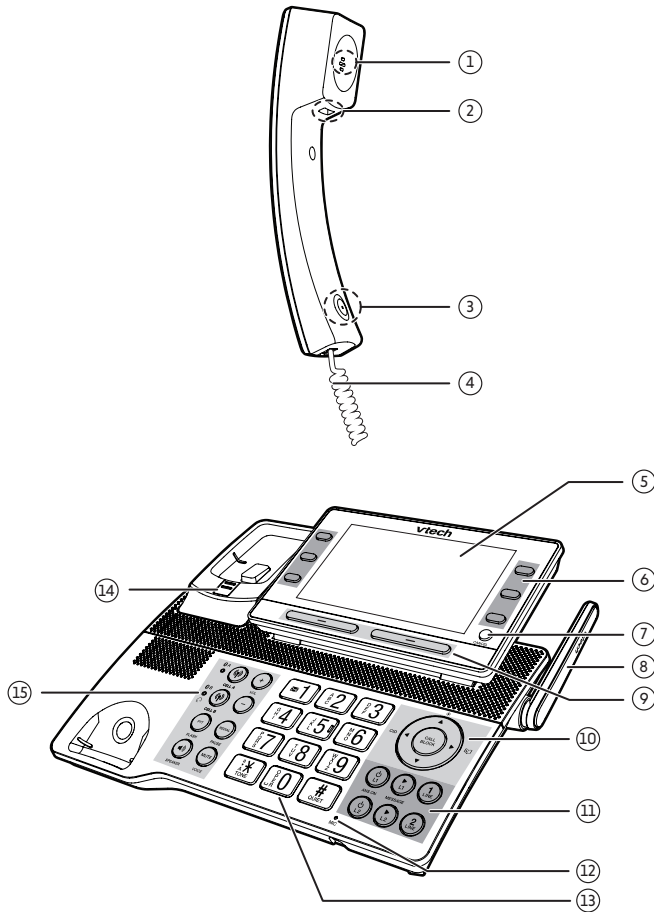

1	• Earpiece
2	• Holding slot for switch hook tab (for wall mounting)
3	• Handset microphone
4	• Handset cord

5	• LCD display	
6		<ul style="list-style-type: none"> • 6 Smart keys • Configurable shortcut of menu option(s), e.g. speed dial number, emergency call, and other menu options. • Press a smart key to select the option displays next to it.
7		<ul style="list-style-type: none"> • While in a menu, press to cancel an operation, back up to the previous menu, or <u>press and hold</u> to exit menu display completely.
8	• Antenna	
9		<ul style="list-style-type: none"> • 2 Soft keys • Press a soft key to select the option displays above.
10		<p>CALL BLOCK</p> <ul style="list-style-type: none"> • When the telephone is ringing, press to block the incoming home call or cell call. • When on a home call or cell call, press to block the call. <p> </p> <ul style="list-style-type: none"> • Adjust LCD display brightness. • Press to dim, and press to increase the LCD brightness. <p> </p> <ul style="list-style-type: none"> • Press to navigate in the menu options. <p>CID </p> <ul style="list-style-type: none"> • Press to review the caller ID log when the telephone is not in use. <p> </p> <ul style="list-style-type: none"> • Press to show phonebook entries when the telephone is not in use.

11

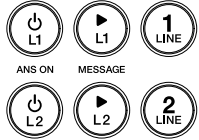

- ANS
 - Press to turn on the answering system of Line 1.



- ANS
 - Press to turn on the answering system of Line 2.



- MESSAGE
 - Press to start or stop playing messages stored in the answering system of Line 1.



- MESSAGE
 - Press to start or stop playing messages stored in the answering system of Line 2.



- - Press to make or answer a home call using Line 1.



- - Press to make or answer a home call using Line 2.

12

- Telephone base microphone

- Keypad



- While reviewing a caller ID log entry, press repeatedly to add or remove 1 in front of the telephone number before dialing or saving it in the phonebook.
- Press and hold to set or dial your voicemail number.



- Press to switch to tone dialing temporarily during a call if you have pulse service.
- While entering names, press to change the next letter to upper or lower case.



- While entering names or numbers, press to add a spacing.



- Press and hold to set and turn on the **QUIET** mode, or turn it off.
- Press to enter # key during a call.
- Press repeatedly to show other dialing options when reviewing a caller ID log entry.

13

12

14 • Switch hook tab

A

- - Flash when searching and pairing the bluetooth device with slot A.
 - Illuminate when the bluetooth device is paired to slot A.



- CELL A
 - Press to make or answer a cell call using Cell line A.

B

- - Flash when searching and pairing the bluetooth device or headset with slot B.
 - Illuminate when the bluetooth device or headset is paired to slot B.



- CELL B
 - Press to make or answer a cell call using Cell line B.



- FLASH
 - During a call, press to answer an incoming home call when you receive a call waiting alert.
 - Press to display the PTT menu to begin a PTT call.
 - Press and hold to broadcast to a group of system devices, i.e. to initiate a one-to-one or one-to-group broadcast.



- SPEAKER
 - Press to turn on the answering system of Line 2.



- VOL
 - Press to increase the listening volume when on a call, or increase the message playback volume.



- - Press to decrease the listening volume when on a call, or decrease the message playback volume.

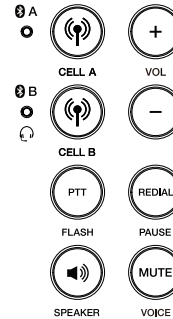

15

13

<p>A</p> <p>CELL A VOL</p> <p>B</p> <p>CELL B PTT REDIAL</p> <p>FLASH PAUSE</p> <p>SPEAKER MUTE</p> <p>VOICE</p>	<p>REDIAL</p> <p>PAUSE</p> <ul style="list-style-type: none"> Press repeatedly to view the last 10 numbers dialed. While entering numbers, <u>press and hold</u> to insert a dialing pause.
	<p>MUTE</p> <p>VOICE</p> <ul style="list-style-type: none"> When the handset is ringing, press to mute the ringer temporarily. Press to activate the voice-controlled application of connected cell phone.

Handset

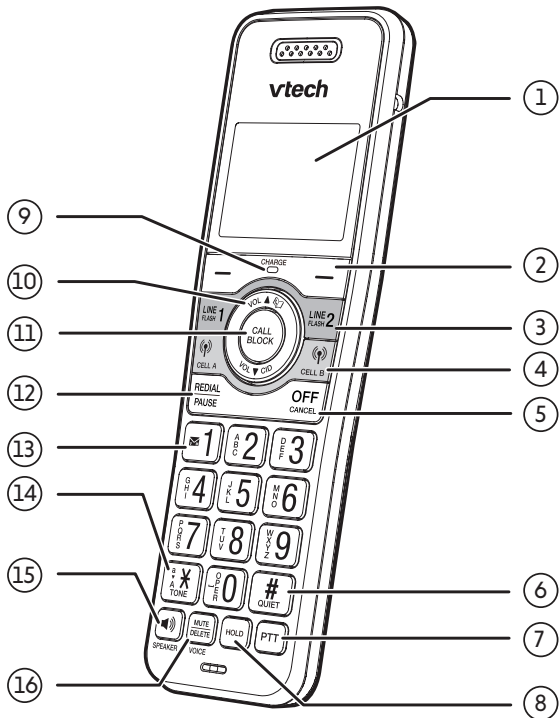

1	• LCD display
2	Soft key (2) • Press a soft key to select the option displays above.
3	LINE FLASH 1 • Press to make or answer a home call using Line 1. • During a call, press to answer an incoming home call using Line 1 when you receive a call waiting alert.
	LINE FLASH 2 • Press to make or answer a home call using Line 2. • During a call, press to answer an incoming home call using Line 2 when you receive a call waiting alert.
4	CELL A • Press to make or answer a cell call using Cell line A. • During a call, press to answer an incoming cell call using Cell line A when you receive a call waiting alert.
	CELL B • Press to make or answer a cell call using Cell line B. • During a call, press to answer an incoming cell call using Cell line B when you receive a call waiting alert.

5	OFF CANCEL	<ul style="list-style-type: none"> During a call, press to hang up. While in a menu, press to cancel an operation, back up to the previous menu, or <u>press and hold</u> this button to exit the menu display completely. When the handset is ringing, press to mute the ringer temporarily. <u>Press and hold</u> while the handset is not in use to erase the missed call indicator.
6	# QUIET	<ul style="list-style-type: none"> <u>Press and hold</u> to set and turn on the QUIET mode, or turn it off. When reviewing a caller ID log entry, press repeatedly to view other dialing options.
7	PTT	<ul style="list-style-type: none"> Press to initiate a one-to-one or one-to-group broadcast. <u>Press and hold</u> to broadcast to a group of system devices.
8	HOLD	<ul style="list-style-type: none"> During a call, press to put the current call on hold.
9	CHARGE light	<ul style="list-style-type: none"> On when the handset is charging in charger.

10

**VOL ▲**

- Press to show phonebook entries when the telephone is not in use.
- Press to scroll up while in a menu.
- Press to increase the listening volume when on a call, or increase the message playback volume.
- While entering names or numbers, press to move the cursor to the right.

VOL ▼ CID

- Press to review the caller ID log when the telephone is not in use.
- Press to scroll down while in a menu.
- Press to decrease the listening volume when on a call, or decrease the message playback volume.
- While entering names or numbers, press to move the cursor to the left.

11

**CALL BLOCK**

- When the telephone is ringing, press to block the incoming home call or cell call.
- When on a home call or cell call, press to block the call.

12

REDIAL PAUSE

- Press repeatedly to view the last 10 numbers dialed.
- While entering numbers, press and hold to insert a dialing pause.

13



- While reviewing a caller ID log entry, press repeatedly to add or remove 1 in front of the telephone number before dialing or saving it in the phonebook.
- Press and hold to set or dial your voicemail number.

14



- Press to switch to tone dialing temporarily during a call if you have pulse service.
- While entering names, press to change the next letter to upper or lower case.

15



SPEAKER

- Press to make or answer a call using the speakerphone.
- Press to switch to the handset speakerphone, press again to resume normal handset use.

16



VOICE

MUTE

- During a call, press to mute the microphone.
- When the handset is ringing, press to mute the ringer temporarily.

16



VOICE

DELETE

- Press to delete an individual entry of the redial list, phonebook, caller ID log.
- Press to delete predialing digits.
- When entering names or numbers, press to delete a digit or character.
- When entering names or numbers, press and hold to erase all digits or characters.
- During message or announcement playback, press to delete the playing message or the recorded announcement.

VOICE

- While connected to one or two cell phones, press to activate the voice controlled application of one of the connected cell phones.

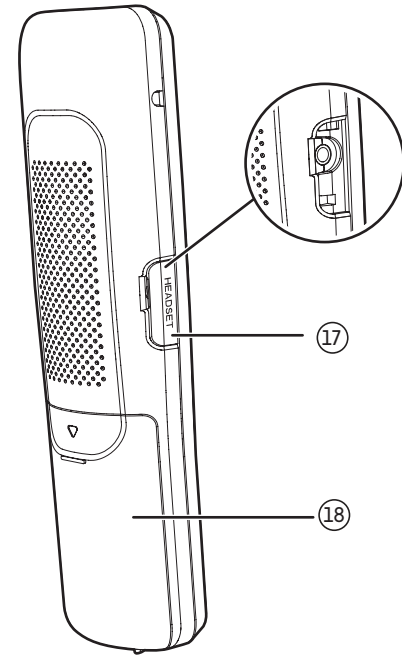

17 • 2.5mm headset jack

18 • Battery compartment cover

Display

Handset



	<ul style="list-style-type: none"> Bluetooth device is paired and active.
	<ul style="list-style-type: none"> Bluetooth device / Cell line is in use.
<i>NEW</i>	<ul style="list-style-type: none"> There are new caller ID log entries
ANS ON	<ul style="list-style-type: none"> Answering system is on.
10:30 AM	<ul style="list-style-type: none"> Time with AM and PM.
	<ul style="list-style-type: none"> Handset ringer is off.
MSG # 10/16	<ul style="list-style-type: none"> Handset displays the current message number being played and the total number of new/old messages recorded.

	<ul style="list-style-type: none"> The handset battery is low and needs charging.
	<ul style="list-style-type: none"> The handset battery is charging.
	<ul style="list-style-type: none"> The handset battery is fully charged.
ECO	<ul style="list-style-type: none"> The ECO mode activates automatically to reduce power consumption when the handset is within range of the telephone base.
	<ul style="list-style-type: none"> New voicemail received from your telephone service provider.
	<ul style="list-style-type: none"> Displays when Home line is in use.

Telephone base

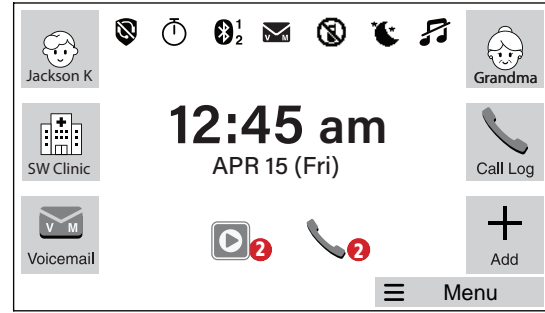

	<ul style="list-style-type: none"> Option(s) displays above a softkey.
	<ul style="list-style-type: none"> Smart call blocker is on.
	<ul style="list-style-type: none"> Timer is set and counting down. Flashes when the countdown reaches.
	<ul style="list-style-type: none"> Bluetooth device is paired and active.
	<ul style="list-style-type: none"> Bluetooth device is in use.
	<ul style="list-style-type: none"> Wireless Bluetooth headset is in use.
	<ul style="list-style-type: none"> New voicemail received from your telephone service provider.
	<ul style="list-style-type: none"> Push to Talk is off.
	<ul style="list-style-type: none"> Quiet mode is on for the selected period of time.
	<ul style="list-style-type: none"> Telephone base ringer is off.
	<ul style="list-style-type: none"> Displays when Home line is in use.
	<ul style="list-style-type: none"> New messages and the total number of new messages displays next to it.
	<ul style="list-style-type: none"> Missed calls and the total number of missed calls displays next to it.

Before use

Set date and time

After you install your telephone or power returns following a power outage and battery depletion, the telephone system will prompt you to set the date and time, and to configure the Smart call blocker* and answering system through voice guide.

NOTE

- Make sure you set the date and time including the year correctly; otherwise the answering system does not announce the correct day of the week for your recorded messages time stamp.

For example: July 25, 2023 and the time is 12:05PM.

Handset

1. Enter the date.
2. Press **NEXT** soft key.
3. Enter the time.



4. Press **SAVE** soft key.

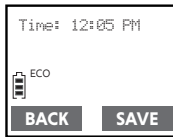

Base

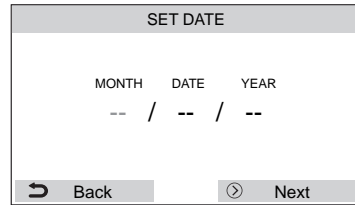

1. Use the dialing keys (0-9) to enter the month (--), date (--) and year (--). Then, press **Next** soft key.
2. Use the dialing keys (0-9) to enter the hour (HH) and minute (MM). Then, press **▲/▼** to choose **AM** or **PM**.
3. Press **Save** soft key to save.

TIP

- To skip setting the date and time, press **OFF/CANCEL** on the handset or **CANCEL** on the base.

Set up Smart call blocker*

After the date and time setting is done or skipped, the base will prompt if you want to set Smart call blocker. Press **Yes** soft key to start the Smart call blocker setup via voice guide.

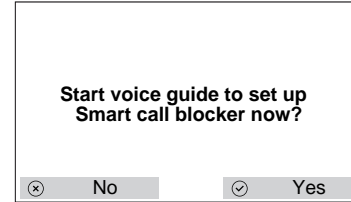

This feature is an easy and alternative way for you to do the basic setup of **"Smart call blocker"**. You can follow the voice guide to set your telephone system to allow or to screen all incoming home calls, or to screen home calls that do not display a phone number.

You hear a voice prompt *"Hello! This voice guide will assist you with the basic setup of Smart call blocker..."*

Set up your Smart call blocker feature by inputting the designated numbers, as instructed in the voice guide.

- To skip the set up, press **CANCEL**.
- Press **1** if you want to screen home calls with telephone numbers that are not saved in your phonebook or star name list; or
- Press **2** if you do not want to screen calls, and want to allow all incoming calls to get through.

NOTE

- The screening feature of Smart call blocker is applicable to home calls only. All incoming cell calls will get through

and ring. If you want to block a cell call, add the number to the block list.

Answering system

After the Smart call blocker setting is done or skipped, the base will then prompt and ask whether you want to set up the answering system.

Press **Yes** soft key to start the answering system setup via voice guide. You hear a voice prompt *"This voice guide will assist you with the basic setup of your answering system..."*

- To skip the set up, press **CANCEL**.

You can record your own announcement, set the number of rings, and set the message alert tone.

Set your own announcement

- Press **7** to record your own announcement, or press **9** to use the standard announcement *"Hello! Please leave a message after the tone..."* and skip to next item - **Set number of rings**.

Set number of rings

- Press **2, 3, 4, 5** or **6** for your preferred number of rings, or **8** for toll saver.
 - Displays and confirms the number of rings being set.

Set message alert tone

When there is at least one new message, the base beeps every 10 seconds. You can press **1** for **On** or **0** for **Off**.

*Includes licenced Qaltel™ technology. Qaltel™ is a trademark of Truecall Group Limited.

Smart keys

On the telephone base, there are six Smart keys along the left and right of the LCD screen.

Smart keys allow you to access the speed dial number, emergency number and other menu options quickly. You can reset the Smart keys anytime you want.

Add a speed dial number

1. Press a **+ Add** smart key to add a Smart key function.
2. Press **Speed dial**  smart key.

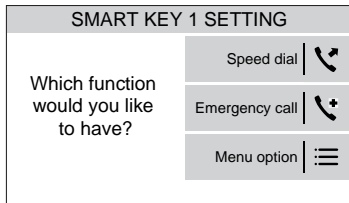

3. Enter the speed dial number, and then press **Next** soft key.
4. Enter the name, and then press **Next**.
5. Press **◀/▲/▼/▶** to highlight a desired profile picture, and then press **Select** soft key.

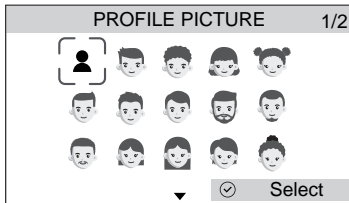

6. Press **◀/▲/▼/▶** to highlight a desired color tone, then press **Select** soft key.

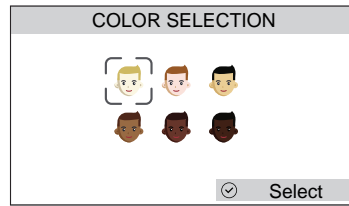

7. Press **Yes** soft key to save.



Add a speed dial number via phonebook

1. Press a **+ Add** smart key to add a Smart key function.
2. Press **Speed dial**  soft key.

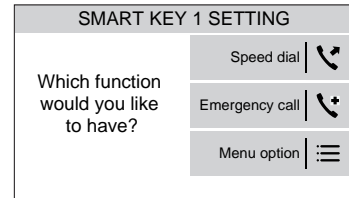

3. Press **Copy from Phonebook**  soft key.

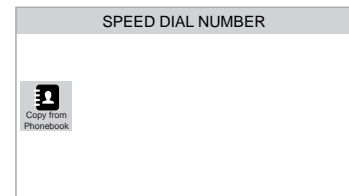

4. Press **▶** smart key next to your desired entry.

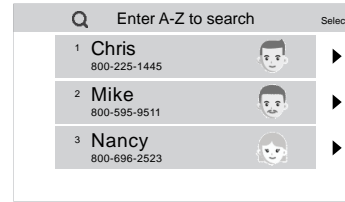

5. Press **Yes** to save.

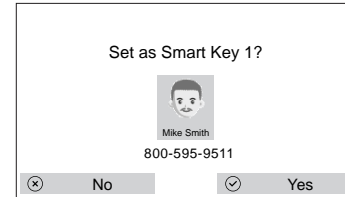

NOTE

- The Smart key speed dial number copies from the Phonebook at the time. It does not auto-update/ synchronize, even if the entries in the Phonebook have changed since then. You need to update it separately.

Update the Smart key speed dial number/ entry

1. Press **Menu** soft key, and then press **▲/▼** to scroll to **Smart key** , and then press its smart key to enter.
2. Press the smart key speed dial contact you want to change.
3. Press **Edit** and then update the telephone number (if required). Press **Next**.
4. Update the name (if required). Press **Next**.

5. Select a new **Profile Picture** (if required). Press **Select**.
6. Select a new **Color Section** (if required). Press **Select**.
7. Press **Yes** to save the updated entry.

Add an emergency number

1. Press a **+ Add** smart key to add a Smart key function.
2. Press **Emergency call**  smart key.
3. Enter the emergency number, and then press **Save** soft key.

Add a menu option

1. Press a **+ Add** smart key to add a Smart key function.
2. Press **Menu option**  smart key.
3. Press **◀/▲/▼/▶** to choose your desired menu option, and then press **Save**.

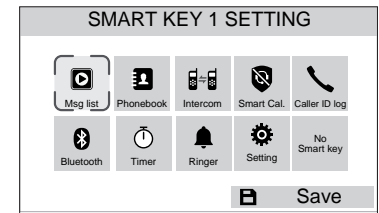

Change a smart key function

You may want to change your existing smart key to another. For instance, from Phonebook to a speed dial number, an emergency number, or another menu option.

1. Press **Menu** soft key on the telephone base.
2. Press ▲/▼ to scroll to **Smart key** , and then press its smart key to enter.
3. Press the smart key you want to change. For instance: **Phonebook** .

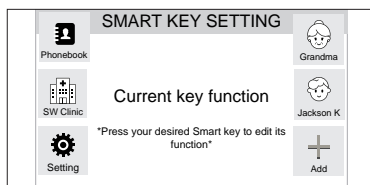

4. Press **Yes** to confirm changing.

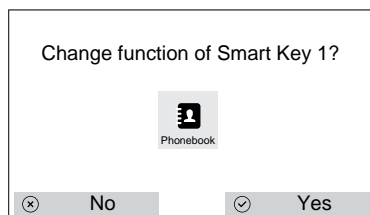

5. Now, select your desired Smart key function.

Follow the steps in **"Add a speed dial number"**, **"Add an emergency number"**, or **"Add a menu option"** sections to change.

Bluetooth

Pair and connect your Bluetooth cellular phone or headset with the telephone base. Before you begin, make sure that you have cellular coverage and your Bluetooth enabled cell phone or handset is not connected to any other Bluetooth device.

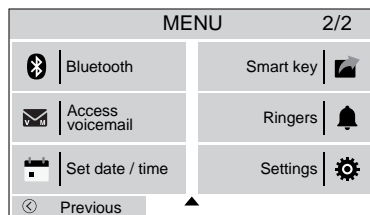

Add a Bluetooth cell phone / headset

1. Press **Menu** soft key on the telephone base.
2. Press ▲/▼ to scroll to the next page, and then select **Bluetooth** smart key.

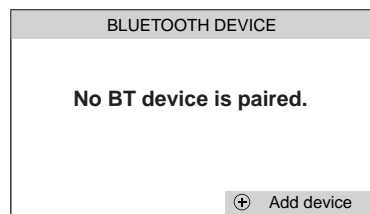

3. Press **Add device** soft key.



4. Press **Add cellular**  or **Add headset**  smart key.
 - For cellular, go to **"Cell phone"**.
 - For headset, go to **"Headset"**.

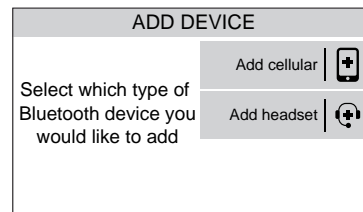

Cell phone

5. Follow the on-screen instructions and press **Next** soft key.

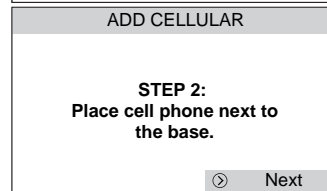
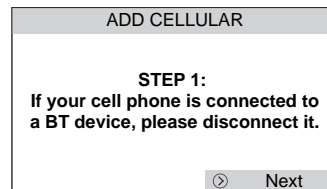

6. Your telephone (**IS9141**) starts searching and pairing with your cell phone, press the appropriate key on your cell phone to continue the pairing process.
 - The **A** | **B** lights on the base flash while pairing.

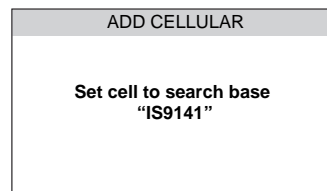

Headset

5. Follow the on-screen instructions and press **Next** soft key.

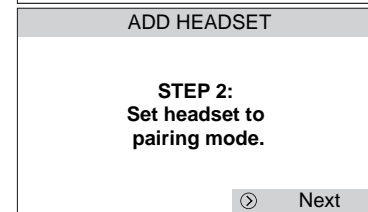
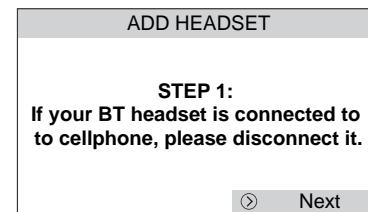

6. Place your headset next to the base and start pairing.

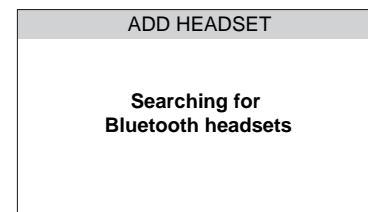

Once your cell phones or headset are paired, **1** and/or **2** display on the base LCD screen.

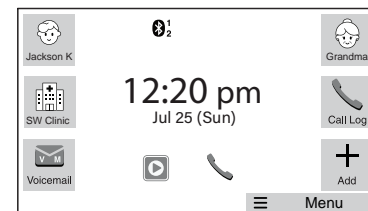

Download your cell phone phonebook using the base

NOTE

- Before downloading the phonebook, make sure cell phone is paired, active, and connected to the system.

1. Press **Menu** soft key on the telephone base.
2. Press **▲/▼** to scroll to the next page, and then select **Bluetooth** smart key.

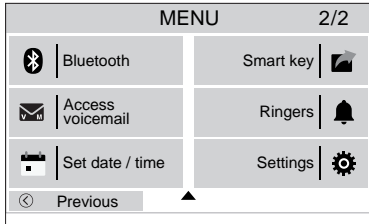

3. Press **Phonebook download** smart key.

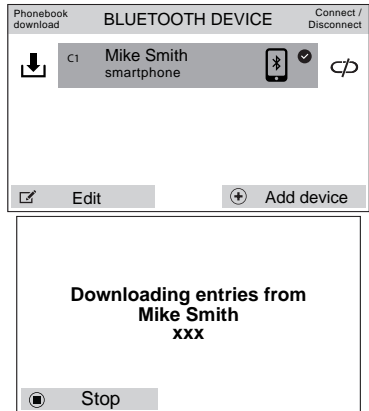

Once your Phonebook entries are added, the LCD screen displays:-



Disconnect/ reconnect your Bluetooth device

1. Press **Menu** soft key on the telephone base.
2. Press **▲/▼** to scroll to the next page, and then select **Bluetooth** smart key.
3. Press the respective smart key **Connect/Disconnect** to disconnect and connect.
-OR-
Press the softkey **Connect** to reconnect.

NOTE

- Make sure to switch on the Bluetooth function of your device if you need to reconnect.

Edit / remove your Bluetooth cell phone or headset

1. Press **Menu** soft key on the telephone base.
2. Press **▲/▼** to scroll to the next page, and then select **Bluetooth** smart key.

3. Press **Edit** soft key.

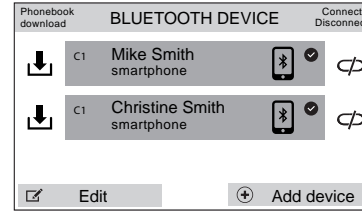

4. Press the respective smart key **X** to select and remove the bluetooth device, or press **Remove all** soft key to delete all devices from the list.

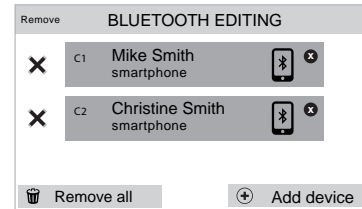

Activate remote voice control

NOTE

- Make sure cell phone is paired, active, and connected to the system via Bluetooth.

Handset

1. Press **MUTE DELETE** soft key.
 - You will hear the confirmation tone from handset via the cell phone's voice app.
2. Speak toward the handset and wait for feedback.

Base

1. Press **MUTE VOICE** soft key.
 - You will hear the confirmation tone from handset via the cell phone's voice app.



2. Speak toward the base and wait for feedback.

Operate

Make a home call

1. Press **LINE 1** / **LINE 2** / **FLASH** / **SPEAKER** (handset) or **1 LINE** / **2 LINE** (base).

2. Enter the telephone number.

Make a cell call

1. Press **CELL A** / **CELL B** (handset) or **CELL A** / **CELL B** (base).

2. Enter the telephone number.



Make a smart key speed dial

TIP

- Make sure you have the speed dial contact first. See "Add a speed dial number".

Press smart key of your speed dial contact and dial.

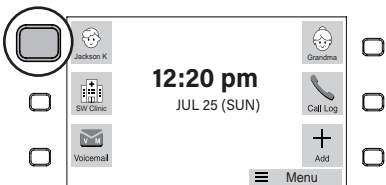

Answer a home call

1. Press **LINE 1** / **LINE 2** / **SPEAKER** (handset) or **1 LINE** / **2 LINE** (base).

Answer a cell call

1. Press **CELL A** / **CELL B** / **SPEAKER** (handset) or **CELL A** / **CELL B** (base).

End a home call

- Press **OFF** / **CANCEL** (handset) or **1 LINE** / **2 LINE** (base).

End a cell call

- Press **OFF** / **CANCEL** (handset) or **CELL A** / **CELL B** (base).

Adjust volume

Handset



Press

Base

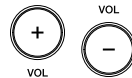

Caller ID

If you subscribe to caller ID service, information about each caller appears after the first or second ring. The caller ID log stores up to 50 entries. Each entry has up to 24 digits for the phone number and 15 characters for the name.

Review caller ID log entries

Handset

1. Press **VOL** / **▼** / **CID**.
- 
2. Press **▲** / **▼** to browse the entries.
- 

Base

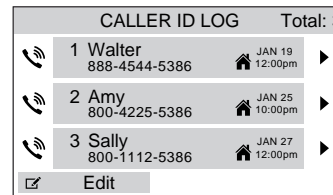

1. Press **CID**.
2. Press **▲** / **▼** to browse the entries.



Save a caller ID log entry to phonebook

When your desired caller ID entry displays on the handset or base LCD screen:-

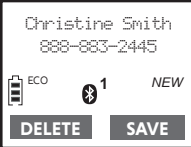
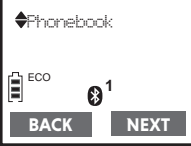
Handset

1. Press **VOL** / **▼** / **CID** and press **▲** / **▼** to browse the entries. At your desired entry, press **SAVE** soft key.
- 
2. Press **▲** / **▼** to scroll to **Phonebook**, then press **NEXT** soft key.
- 
3. Edit the telephone number if needed, and then press **NEXT** soft key.
- 
4. Edit the name if needed, and then press **SAVE** soft key to save.
- 



Base

1. Press **CID** and ▲/▼ to browse the entries.
2. Press the ► smart key next to your desired entry.

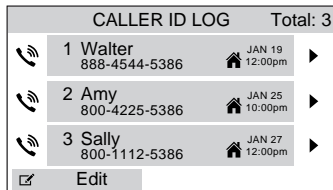

3. On the entry page, press **Phonebook** smart key.

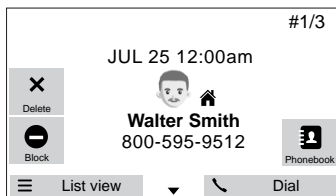

4. Press **YES** soft key to save the telephone number to the Phonebook.

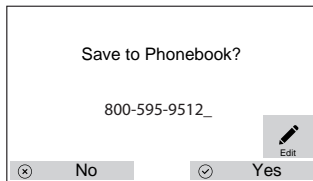

You can also edit the number if needed.

1. Press the smart key **Edit**.
2. Edit the number if needed, and then press **Next** soft key.

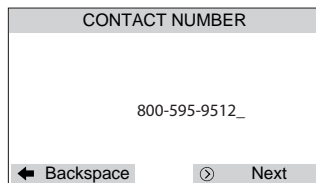

3. Edit the name if needed, and then press **Next** soft key.



4. Press ◀/▲/▼/▶ to select a desired profile picture and then press **Select** soft key.

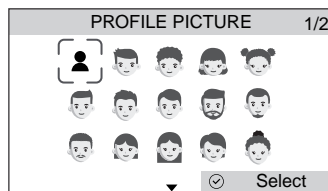

5. Press ◀/▲/▼/▶ to select a preferred color, and then press **Select** soft key.

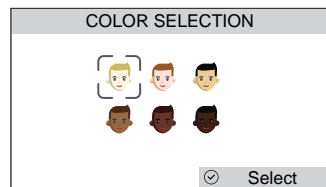



6. Press **Save** soft key to save at **Preview**.

Dial a caller ID log entry

When your desired caller ID entry displays on the handset or base LCD screen:-

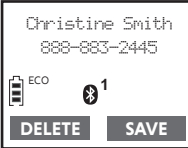
Handset

1. Press **VOL** ▼ **CID**, and press ▲/▼ to scroll to your desired entry.
 
2. Press **LINE 1** / **FLASH 2**, **SPEAKER**, or **CELL A** / **CELL B** to dial.
 

Base

1. Press **CID**.
2. Press ▲/▼ to browse the entries.

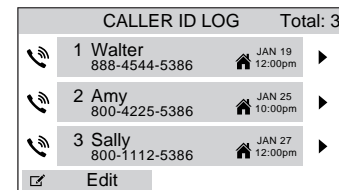

3. Press ► smart key next to your desired entry to call directly. **-OR-** Press ► smart key of your desired entry to go to the caller entry page.



Press **LINE 1** / **LINE 2**, **CELL A** / **CELL B**, or **Dial** soft key.

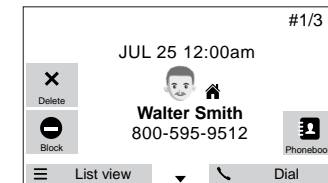

Delete a caller ID log entry

When your desired caller ID entry displays on the handset or base LCD screen:-

Handset

1. Press **VOL** ∇ **CID**, and press \blacktriangle / \blacktriangledown to scroll to your desired entry.



2. Press **MUTE DELETE** **VOICE**.

Base

1. Press **CID** \blacktriangleleft and \blacktriangle / \blacktriangledown to browse the entries.
2. Press the \blacktriangleright smart key next to your desired entry.

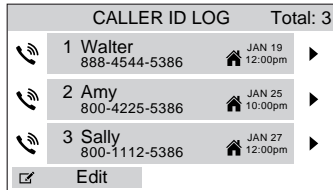

3. On the entry page, press **Delete** **X** smart key.

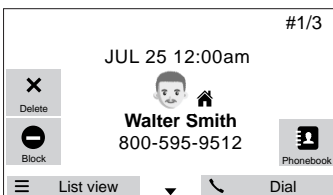

Phonebook

The phonebook can store up to 1,000 entries, which are shared by all handsets and the telephone base. Each entry may consist of a telephone number up to 30 digits, and a name up to 15 characters.

Add a phonebook entry

Handset

1. Press **MENU** soft key.
2. Press \blacktriangle / \blacktriangledown to scroll to **Phonebook**, and then press **SELECT** soft key.
3. Press **SELECT** soft key to select **Add new entry**.
4. Enter the number, and then press **NEXT** soft key.

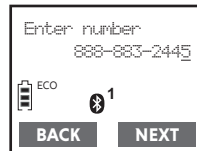
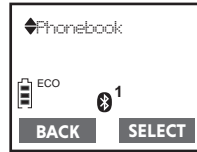

5. Enter the name, and then press **SAVE** soft key to save.

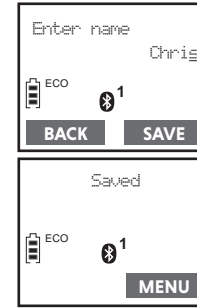

Base

There are 3 ways to access **Phonebook** before adding an entry.

- Press \blacktriangleright \blacktriangleleft to access phonebook directly.
- If you have set up phonebook smart key (**Phonebook**), you can press and access directly.
- Press **Menu** soft key, and then go to **Phonebook** menu option by pressing its smart key.

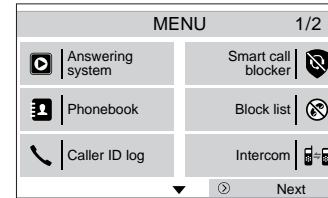

At the **Phonebook**, follow the steps below:-

1. Press **Yes** soft key.

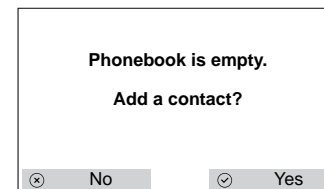

2. Enter the telephone number, and then press **Next** soft key.

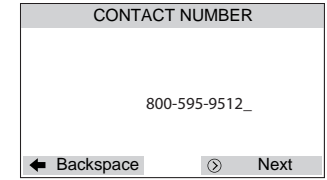

3. Enter the contact name, and then press **Next** soft key.

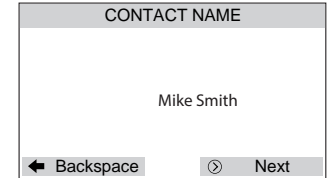

4. Press \blacktriangleleft / \blacktriangle / \blacktriangledown / \blacktriangleright to select a desired profile picture, and then press **Select** soft key.

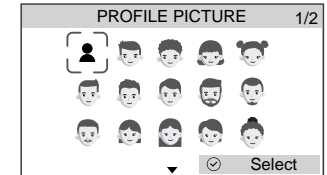

5. Press \blacktriangleleft / \blacktriangle / \blacktriangledown / \blacktriangleright to select a desired color, and then press **Select** soft key.

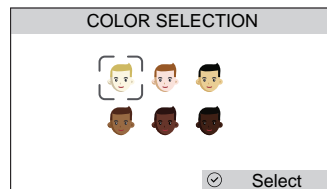

- Press **Save** soft key to save the entry at **Preview**.

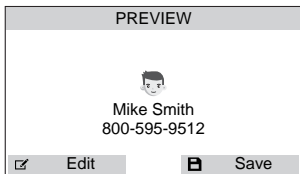

Review phonebook entries

Handset

- Press and then press to browse the entries.
- Press to browse the entries.

Base

There are 3 ways to access and review **Phonebook** entries.

- Press directly.
- If you have set up phonebook smart key (**Phonebook**), you can press and access directly.
- Press **Menu** soft key, and then go to **Phonebook** menu option by pressing its smart key.

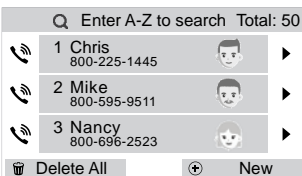

Dial a phonebook entry

Handset

- Press and then press to scroll to your desired entry.
- Press **LINE 1** / **FLASH 1** / **LINE 2** / **FLASH 2**, **SPEAKER**, OR **CELL A** / **CELL B** to dial.

Base

There are 2 ways to dial a phonebook entry.

Option 1

- Press and to scroll to your desired entry. Then, press smart key next to your desired entry to dial.

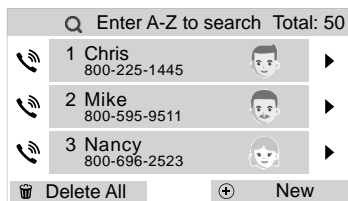

- While calling, you can press **Mute** soft key to mute, or press **End** soft key to end the call when you are done.

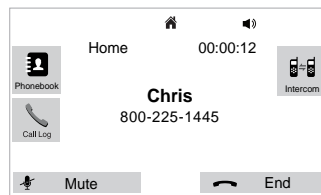

Option 2

- Press and to scroll to your desired entry. Then, press smart key next to your desired entry.

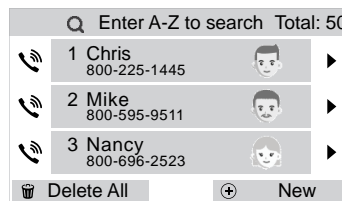

- Press **Dial** soft key.

-OR-

Press / OR / to call.

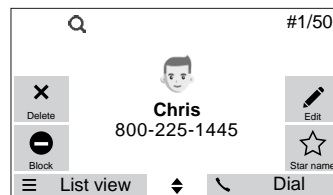

Delete a phonebook entry

Handset

- Press and then press to scroll to your desired entry.
- Press **MUTE DELETE**.
- Press **YES** soft key to confirm deleting the entry.

Base

- Press and to scroll to your desired entry. Then, press smart key next to your desired entry.

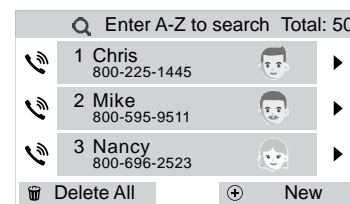

- Press **Delete X** smart key.

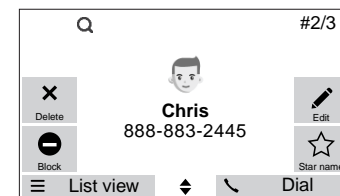

- Press **Yes** soft key to confirm deleting the entry.

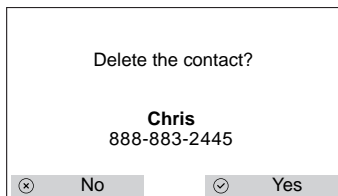

Smart call blocker

If you have subscribed to caller ID service, then you can use the Smart call blocker feature to screen incoming home calls.

NOTE

- The screening feature of Smart call blocker is applicable to incoming home calls only. All incoming cell calls will get through and ring. If you want to block a cell call, add the number to the block list.

Turn on/off Smart call blocker

Smart call blocker is set as **No Screening** by default. In other words, the Smart call blocker is on, yet it allows all incoming calls.

NOTE

- There are separate Smart call blocker settings for Line 1 and Line 2. You can set one home line to screen incoming calls but allow all incoming calls on the other home line.

Turn on/off Line 1 or Line 2 Smart call blocker screening



Handset

- Press  .
- Press **SELECT** soft key to select **Line 1 SCB**; - OR - Press **▲/▼** to scroll to **Line 2 SCB** and then press **SELECT** soft key.
- Press **SELECT** soft key to select **L1 SCB screening** (or **L2 SCB screening** if you have chosen **Line 2 SCB**).
- Press **▲/▼** to scroll to your preferred options of Smart call blocker, including **No Screening** option.
 - No screening**
 - Screen unknown**
 - UnknownToAns.S** - send unknown calls to answering system
 - Block unknown**
- Press **SELECT** soft key to confirm your setting.



NOTES

- You can change the Smart call blocker settings to screen incoming home calls from numbers or names that are not yet saved in your phonebook, block list, or star name list. You can easily add incoming phone numbers to your block list. This allows you to build up your lists of allowed and blocked numbers, and Smart call blocker will know how to handle these calls when they come in again.
- If you turn off Smart call blocker (i.e. selected **No screening**), all unknown incoming home calls will ring.
- When **QUIET** mode is on, and Smart call blocker is in screening mode, all screened home calls will be sent to the answering system after screening.

Base

- Press **Menu** soft key and choose **Smart call blocker** , and then **Line 1 SCB settings** or **Line 2 SCB settings**  by pressing their smart keys.
- Press **Line 1 SCB screening** smart key (or **Line 2 SCB screening** if you have chosen **Line 2 SCB settings**).
- Press the smart key of your desired option.
 - No screening**
 - Screen unknown**
 - UnknownToAns.S** - send unknown calls to answering system
 - Block unknown**

NOTES

- If you press and choose **Screen unknown**  smart key. **Screen all unknown calls** displays and confirms.
-  displays next to the selected option.

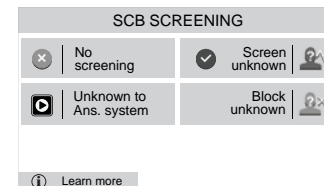

- Select the **Screen unknown** option will set your telephone to screen all unknown calls on the selected home line(s), and ask for the callers' names before putting the calls through to you.

Set up phonebook, block list and star name list

Phonebook

Enter and save telephone numbers of frequently called businesses, family members and friends, so that when they call, your telephone rings without having to go through the screening process.

Block list

Add numbers that you want to prevent their calls from ringing through. Cell calls with numbers that have been added to your block list will also be blocked.

Star name list

Add caller names to your star name list to allow their calls to get through to you without having to go through the screening process.

There are many organizations like schools, medical offices, and pharmacies that use robocalls to communicate important information to you. Robocall uses an autodialer to deliver pre-recorded messages. By entering the **EXACT Caller ID (CID)'s name of the organizations** into the Star name list, it ensures these calls will ring through when you only know the caller names but not their numbers.

Add numbers from caller ID log with handset

Adding CID log entry to phonebook

1. Press  → ▲/▼ to view the entries.
 - Press **SAVE** when the desired entry appears.
2. Press ▲or▼ → **Phonebook** → **NEXT**.
3. Press **NEXT** → **SAVE**.

Adding CID log entry to block list

1. Press  → ▲/▼ to view the entries.
 - Press **SAVE** when the desired entry appears.
2. Press ▲or▼ → **Block list** → **NEXT**.
3. Press **NEXT** → **SAVE**.

Adding CID log entry to star name list

1. Press  → ▲/▼ to view the entries.
 - Press **SAVE** when the desired entry appears.
2. Press ▲or▼ → **Star name list** → **NEXT** → **SAVE**.

Add numbers manually with handset

Adding a new number to the phonebook

1. Enter the telephone number → **OPTION**.
2. Press ▲or▼ → **Phonebook** → **NEXT**.
3. Press **NEXT** → **SAVE**.

Adding a new number to the block list

1. Press **MENU** soft key.
2. Press ▲or▼ → **Block list** → **NEXT**.
3. Press ▲or▼ → **Block numbers** → **NEXT**.
4. Press ▲or▼ → **Add new entry** → **NEXT**.
5. Enter a telephone number up to 30 digits → **NEXT**.
6. Enter a name up to 15 characters → **SAVE**.

Adding a new number to the star name list

1. Press .
2. Press ▲or▼ → **Star name list** → **NEXT**.
3. Press ▲or▼ → **Add new entry** → **NEXT**.
4. Enter a name up to 15 characters → **SAVE**.

Scenarios of Smart call blocker configuration

Choose one that best suits your needs

Scenarios	I want to screen any home calls from numbers not saved in the Phonebook or Star name list. (1)	I want to allow all calls except the people on the Block list only. (2)
Settings	Screen unknown	No screening
Line 1 or Line 2 SCB screening options - Handset		
Line 1 or Line 2 SCB screening options - Base		
Line 1 or Line 2 SCB screening announcement - Handset	<p>SCB will screen your callers by asking them to leave their names.</p> <p>Set Screening announcement:-</p> <ol style="list-style-type: none"> 1. While in the Line 1 SCB or Line 2 SCB menu, scroll to L1 screening annc (or L2 screening annc), then press NEXT soft key. 2. Press NEXT soft key to select SCB annc type. 3. Press SAVE to select Unknown caller. 	
Line 1 or Line 2 SCB screening announcement - Base	<ol style="list-style-type: none"> 1. Select Screening annc smart key, and then Ann Type soft key. 2. Choose Unknown caller . 	

2 types of screening announcements



- To screen unknown calls requiring the callers to announce their names and then press #.

I want to screen robocalls only. (3)	I want to send any home calls from numbers not saved in the Phonebook or Star name list to the answering system. (4)	I want to block any home calls from numbers not saved in the Phonebook or Start name list. (5)
Screen unknown	UnknownToAns.S	Block unknown
<p>SCB will screen your callers by asking them to press # to get through.</p> <p>Set Screening announcement:-</p> <ol style="list-style-type: none"> 1. While in the Line 1 SCB or Line 2 SCB menu, scroll to L1 screening annc (or L2 screening annc), then press NEXT soft key. 2. Press NEXT soft key to select SCB annc type. 3. Scroll to Robocalls only, and then press SAVE. 		
<ol style="list-style-type: none"> 1. Select Screening annc smart key, and then Ann Type soft key. 2. Choose Robocalls only . 		



- To screen robot calls requiring the callers to press #.

Block the caller while on a call

When you are on a home or cell call and speaking to the caller, and you do not want to continue the call, you can end the call with block announcement and add the number to the block list.

1. During a home or cell call, press **CALL BLOCK**.
2. Press  to end the call.



NOTE

There are many organizations like schools, medical offices, and pharmacies that use robocalls to communicate important information to you. Robocall uses an autodialer to deliver pre-recorded messages. By entering the name of the organizations into the star name list, it ensures these calls will ring through when you only know the caller names but not their numbers.



Unblock a telephone number

If you have added a telephone number to the block list, you can unblock it.

Handset

1. Press **CALL BLOCK**.
2. Press **▲** or **▼** → **Block list** → .
3. Press  to select **Review**.
4. Press **▲** or **▼** to browse through the block entries.
5. When the desired entry displays, press **DELETE**, and then press .

Base









1. Press **Menu** softkey, and then go to Block list .
2. Press **Block numbers** smart key, and press **▲**/**▼** to review and browse through the block list.
3. When the desired entry displays, press the  smart key to unblock.
 - The screen shows **Unblock entry?** with the entry name and telephone number.
4. Press **Yes** to unblock.

Answering system

About the built-in answering system and voicemail service

For message recording, your telephone has a built-in answering system, and it also supports voicemail service offered by your telephone service provider (subscription is required, and fee may apply).





Built-in answering system VS Voicemail service

	Built-in Answering system 	Voicemail service 
Support by	Telephone system	Telephone service provider
Subscription	No	Yes
Fees	No	May apply
Answer incoming calls	<ul style="list-style-type: none"> • After 4 rings by default; • It can be changed in the handset or the telephone base menu. 	<ul style="list-style-type: none"> • Usually after 2 rings; • It can be changed by contacting your telephone service provider.
Storage	Telephone base	Server or System
Display new messages	<ul style="list-style-type: none"> • Handset - XX new messages • Telephone base   	<ul style="list-style-type: none"> • Handset  • Telephone base 
Retrieve messages	<ul style="list-style-type: none"> • Press  on the telephone base; • Press  on the handset, and then select Play messages; or • Access remotely with an access code. 	<ul style="list-style-type: none"> • Press and hold  on the dialpad, and enter an access number from your telephone service provider or dial to access voicemail.

Set number of rings

You can set your answering system to answer calls at least two rings earlier than your voicemail service. For example, if your voicemail service answers after six rings, set your answering system to answer after four rings. Thus, if you are on a call, or if the answering system is busy recording a message and you receive another call, the second caller can leave a voicemail message.

Handset

1. Press .
2. Press ▲/▼ to scroll to **Answering sys**, and then press .
3. Press ▲/▼ to scroll to **Ans sys setup**, and then press .
4. Press ▲/▼ to scroll to **# of rings**, and then press .
5. Press ▲/▼ to scroll to the desired number of rings, and then press .

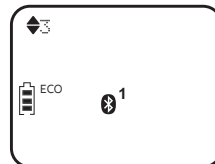

Base

1. Press **Menu** softkey.
2. Press  **Answering system**.

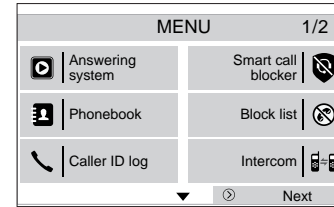

3. Press ▲/▼ to scroll to the next page, and then select **Number of rings** .

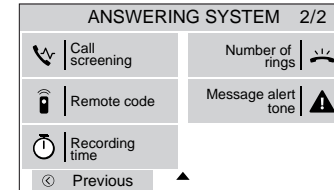

4. Press your desired number of rings.

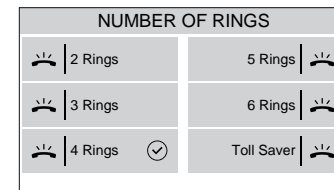



Turn the built-in answering system on or off

Base

- Press  to turn on.
- Press it again to turn off.

Message playback

Handset

1. Press .
2. Press  to select **Play messages**.

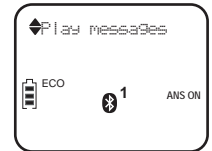

Base

- Press .

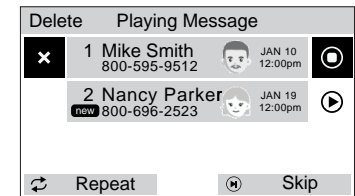

Options while message playback

Skip a message

Handset	Base	
Press MENU 6 .	Press Skip .	

Repeat the playing message

Handset	Base	
Press MENU 4 .	Press Repeat .	

Play the previous message

Handset	Base	
Press MENU 4 twice.	Press Repeat twice.	

Delete all old messages

Handset

1. Press **MENU** **SELECT**.
2. Press **▲/▼** to scroll to **Answering sys**, and then press **MENU** **SELECT**.
3. Press **▲/▼** to scroll to **Delete all old**, and then press **MENU** **SELECT**.

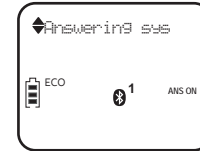

Base

1. Press **Menu**.
2. Press **▶** **Answering system**.

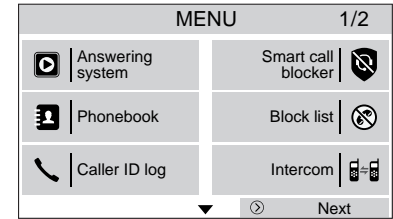

3. Press **Delete all old** .

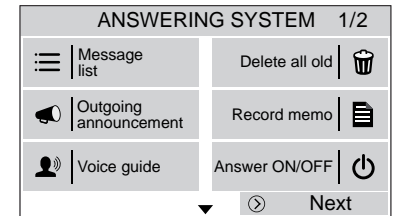

4. Press **Yes**.

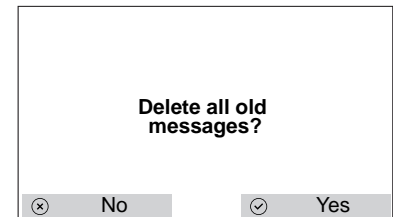

Countdown timer

You can use the timer as your kitchen timer for cooking, meeting timer, exercise timer, study timer, and etc. It assists you to be multitasking while working from home, so that you can better manage your time. This feature is only available on the telephone base. You can set the duration to count down. When the time is up, the alert sounds and a text message pops up.

Set the countdown timer

1. Press **TIMER**.
2. Enter your desired number of minutes and seconds with numeric keys. You can also press ▲/▼ to edit the number of minute and second, and press ▲/▼ to move between **MINUTES** and **SECONDS**.



- You will see the **MINUTES** start flashing.

3. Press **Start** to start counting down.

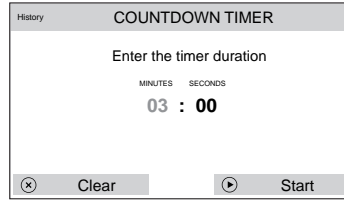

4. Press **Pause** to temporary stop the countdown. You can resume the counting by pressing **Resume**. If you want to Stop the countdown, press **Stop**.

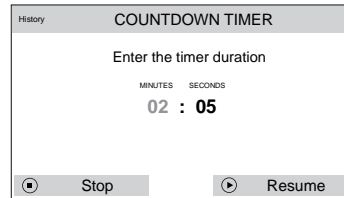
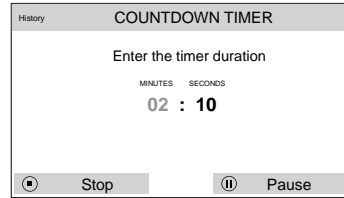

LCD language setting

If you accidentally set the LCD language to Spanish or French, you can change the LCD language back to English while the telephone is not in use:

- On the handset, press **MENU SELECT** → *364#.
 - You will hear a confirmation tone and the screen switch back to English.

Need help?

For operations and guides to help you using your telephone system, and for latest information and supports, go and check the online help topics and online FAQs.

Use your smartphone or mobile device to access our online help.

- Go to <https://help.vtechphones.com/is9141> | <https://phones.vtechcanada.com/en/support/general/manuals> OR

- Scan the QR code on the right. Launch the camera app or QR code scanner app on your smartphone or tablet. Hold the device's camera up to the QR code and frame it. Tap the notification to trigger the redirection of the online help.



US





CA

If the QR code is not clearly displayed, adjust your camera's focus by moving your device closer or further away until it is clear.

You can also call our Customer Support at 1 (800) 595-9511 [in US] or 1 (800) 267-7377 [in Canada] for help.

Technical Specifications

Frequency control	<ul style="list-style-type: none">• Crystal controlled PLL synthesizer
Transmit frequency	<ul style="list-style-type: none">• Handset: 1921.536-1928.448 MHz• Telephone base: 1921.536-1928.448 MHz
Channels	<ul style="list-style-type: none">• 5
Nominal effective range	<ul style="list-style-type: none">• Maximum power allowed by FCC and IC. Actual operating range may vary according to environmental conditions at the time of use.
Power requirement  	<ul style="list-style-type: none">• Handset: 2.4V Ni-MH battery• Telephone base: 6V / 5.9V DC @ 0.6A• Charger: 6V DC @ 0.4A
Memory	<ul style="list-style-type: none">• Phonebook: 1000 memory locations; up to 30 digits and 15 characters• Caller ID log: 50 memory locations; up to 24 digits and 15 characters• Call block: 1000 entries

When it is fully charged, you can expect the following performance.

Operation	Operating time*
Talk time (cordless handset)	<ul style="list-style-type: none">• 10 hours
Standby	<ul style="list-style-type: none">• 5 days

* Operating times vary depending on your actual use and the age of the battery.

Go to www.vtechphones.com (US) to register your product for enhanced warranty support and latest VTech product news.

Go to phones.vtechcanada.com (Canada) for the latest VTech product news.



Specifications are subject to change without notice.

© 2023 VTech Communications, Inc. |

© 2023 VTech Technologies Canada Ltd.

All rights reserved. 03/23.

IS9141-X_QSG_V1 | IS9141-X_CA_QSG_V1

