

## TEST REPORT

### SPECIFIC ABSORPTION RATE (SAR) EVALUATION REPORT

For DECT6.0 Cordless Telephone

Model Number: CS6214-2

Brand Name: vtech

FCC ID: EW780-2400-00

Prepared for  
VTech Telecommunications Ltd.  
23/F., Tai Ping Industrial Centre, Block 1,  
57 Ting Kok Road, Tai Po, Hong Kong.

**PREPARED AND CHECKED BY:**

**APPROVED BY:**

Signed On File  
Chan Tsz Yu, Ezra  
Assistant Engineer  
Date: Feb 10, 2021

---

Siu Yiu Nam, Edwin  
Senior Lead Engineer  
Date: Feb 10, 2021

**TEST REPORT**

**TABLE OF CONTENTS**

1 Test Result Summary..... 3

2 General Information..... 4

3 SAR Measurement System Description ..... 7

4 Tissue Verificaiton ..... 15

5 SAR Measurement System Verification ..... 18

6 SAR Evaluation..... 20

7 Test Equipment List ..... 30

8 Measurement Uncertainty..... 31

9 E-Field Probe and Dipole Antenna Calibration ..... 31

APPENDIX A – System Check Data ..... 32

APPENDIX B – SAR Evaluation Data ..... 33

APPENDIX C – E-Field Probe and Dipole Antenna Calibration ..... 34

## TEST REPORT

### 1. TEST RESULT SUMMARY

|                                  |   |
|----------------------------------|---|
| <b>Applicant:</b>                | VTech Telecommunications Ltd.   |
| <b>Applicant Address:</b>        | 23/F., Tai Ping Industrial Centre, Block 1,<br>57 Ting Kok Road, Tai Po, Hong Kong.   |
| <b>Model:</b>                    | CS6214-2  |
| <b>Brand Name:</b>               | vtech   |
| <b>Serial Number:</b>            | N/A   |
| <b>FCC ID:</b>                   | EW780-2400-00   |
| <b>Test Device:</b>              | Production Unit   |
| <b>Exposure Category:</b>        | General Population/Uncontrolled Exposure  |
| <b>Date of Test:</b>             | Jan 29, 2021  |
| <b>Place of Testing:</b>         | Intertek Testing Services Hong Kong<br>Unit 3, G/F, World-Wide Industrial Centre,<br>43-47 Shan Mei Street, Fo Tan, Sha Tin.  |
| <b>Environmental Conditions:</b> | Temperature: +18 to 25°C<br>Humidity 25 to 75%  |
| <b>Test Specification:</b>       | ANSI/IEEE C95.1<br>IEEE Std 1528: 2013<br>FCC KDB Publication 447498 D01 v06<br>FCC KDB Publication 865664 D01 v01r04<br>FCC KDB Publication 865664 D02 v01r02<br>FCC KDB Publication 648474 D04 v01r03 |

The maximum spatial peak SAR value for the sample device averaged over 1g was found to be:

| Band        | Operating Mode | TX Frequency (MHz)  | Highest Reported SAR    |
|-------------|----------------|---------------------|-------------------------|
| 1.9GHz DECT | Voice          | 1921.536 – 1928.448 | 1 g Head<br>0.0399 W/kg |

This wireless portable device has been shown to be capable of compliance for localized specific absorption rate (SAR) for uncontrolled environment / general population exposure limits specified in ANSI/IEEE C95.1.

## TEST REPORT

### 2. GENERAL INFORMATION

#### 2.1. Description of Equipment under test (EUT)

|   |  |
|---|--|
| <b>Manufacturer:</b>                      | VTech (Dongguan) Telecommunications Limited.   |
| <b>Manufacturer Address:</b>              | VTech Science Park, Xia Ling Bei Management Zone, Liaobu, Dongguan, Guangdong, China.  |
| <b>Device dimension (L x W) :</b>         | 165 (mm) x 52 (mm)   |
| <b>Device thickness:</b>                  | 30 (mm)  |
| <b>Antenna Gain:</b>                      | 0 dBi  |
| <b>Operating Configuration(s) / mode:</b> | Held to head (Voice call)  |
| <b>Tx Frequency (MHz):</b>                | 1921.536MHz to 1928.448MHz   |
| <b>Duty Cycle*:</b>                       | 1/24   |
| <b>H/W Version:</b>                       | N/A  |
| <b>S/W Version:</b>                       | N/A  |
| <b>Battery Type:</b>                      | 2.4VDC (1 x 2.4V 300mAh Ni-MH Rechargeable Battery Pack)<br>- Model: Corun           BT162342/BT262342<br>- Model: HP               BT162342/BT262342<br>- Model: GP               BT162342/BT262342 |

**\*Note:**

1. DECT has a TDD/TDMA frame structure with a complete frame of 10ms duration with 24 time slots. And under these 24 time slots, the first 12 slots are allocated for the transmission from base station to handsets, and the other 12 slots are for the transmission from handsets to base station. During a call, the handset of this product will use one of 24 time slots to transmit under worst case, which gives a duty cycle of 1/24 (= 4.2%).

## TEST REPORT

### 2.2. EUT Antenna Locations

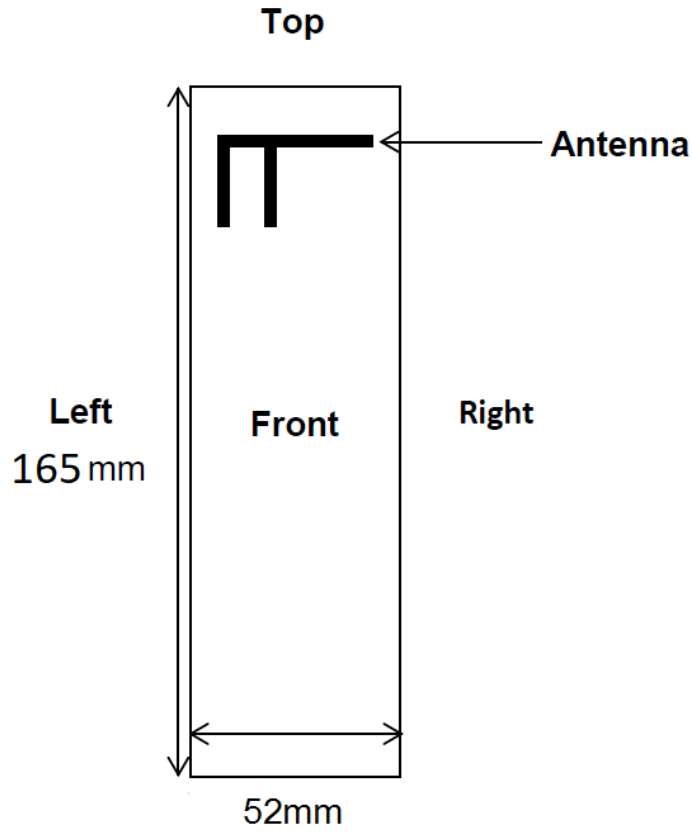

Details of antenna specification are shown in separate antenna dimension document.

## TEST REPORT

### 2.3. Nominal and Maximum Output Power Specifications

The EUT operates using the following maximum and nominal output power specifications. SAR values were scaled to the maximum allowed power to determine compliance per KDB Publication 447498.

| Band        | Operating Mode | TX Frequency (MHz)  | Output Power  |               |
|-------------|----------------|---------------------|---------------|---------------|
|             |                |                     | Nominal (dBm) | Maximum (dBm) |
| 1.9GHz DECT | Voice          | 1921.536 – 1928.448 | 20            | 21            |

## TEST REPORT

### 3. SAR MEASUREMENT SYSTEM DESCRIPTION

SAR is related to the rate at which energy is absorbed per unit mass in object exposed to a radio field. The SAR distribution in a biological body is complicated and is usually carried out by experimental techniques or numerical modeling. The standard recommends limits for two tiers of groups, occupational/controlled and occupational/uncontrolled, based on a person's awareness and ability to exercise control over his or her exposure. In general, occupational/controlled exposure limits are higher than the limits for general population/uncontrolled.

The SAR definition is the time derivative (rate) of the incremental energy (dW) absorbed by (dissipated in) an incremental mass (dm) contained in a volume element (dv) of given mass density ( $\rho$ ). The equation description is as below:

$$SAR = \frac{d}{dt} \left( \frac{dW}{dm} \right) = \frac{d}{dt} \left( \frac{dW}{\rho dV} \right)$$

SAR is expressed in units of Watts per kilogram (W/Kg)

SAR can be obtained using either of the following equations:

$$SAR = \frac{\sigma E^2}{\rho}$$

$$SAR = c_h \left. \frac{dT}{dt} \right|_{t=0}$$

Where

- SAR is the specific absorption rate in watts per kilogram;
- E is the r.m.s. value of the electric field strength in the tissue in volts per meter;
- $\sigma$  is the conductivity of the tissue in siemens per metre;
- $\rho$  is the density of the tissue in kilograms per cubic metre;
- $c_h$  is the heat capacity of the tissue in joules per kilogram and Kelvin;

$\left. \frac{dT}{dt} \right|_{t=0}$  is the initial time derivative of temperature in the tissue in kelvins per second

## TEST REPORT

An SAR measurement system usually consists of a small diameter isotropic electric field probe, a multiple axis probe positioning system, a test device holder, one or more phantom models, the field probe instrumentation, a computer and other electronic equipment for controlling the probe and making the measurements. Other supporting equipment, such as a network analyzer, power meters and RF signal generators, are also required to measure the dielectric parameters of the simulated tissue media and to verify the measurement accuracy of the SAR system.

The SAR measurement system being used is COMOSAR system, which consists following items for performing compliance tests

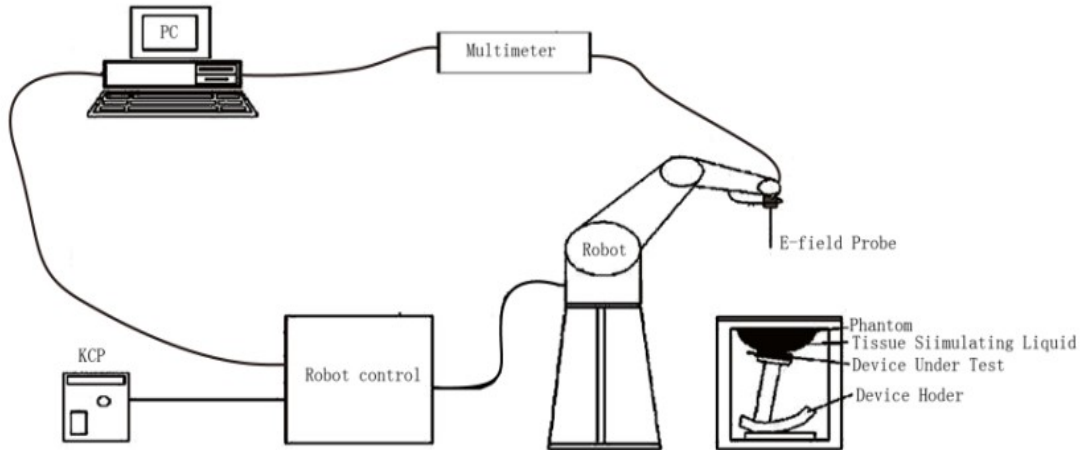

*Figure 1: Schematic diagram of the SAR measurement system*

- The PC. It controls most of the bench devices and stores measurement data. A computer running WinXP and the Opensar software
- The E-Field probe. The probe is a 3-axis system made of 3 distinct dipoles. Each dipole returns a voltage in function of the ambient electric field.
- The Keithley multimeter measures each probe dipole voltages.
- The SAM phantom simulates a human head. The measurement of the electric field is made inside the phantom.
- The liquids simulate the dielectric properties of the human head tissues
- The network emulator controls the mobile phone under test.
- The validation dipoles are used to measure a reference SAR. They are used to periodically check the bench to make sure that there is no drift of the system characteristics over time.
- The phantom, the device holder and other accessories according to the targeted measurement.



## TEST REPORT

### ROBOT

The COMOSAR system uses the KUKA robot from SATIMO SA (France). For the 6-axis controller COMOSAR system, the KUKA robot controller version from SATIMO is used.

The XL robot series have many features that are important for our application:

- High precision (repeatability 0.02 mm)
- High reliability (industrial design)
- Jerk-free straight movements
- Low ELF interference (the closed metallic construction shields against motor control fields)
- 6-axis controller



**TEST REPORT**

**COMOSAR E-FIELD PROBE**

The SAR measurement is conducted with the dissymmetric probe manufactured by SATIMO. The probe is specially designed and calibrated for use in liquid with high permittivity. The dissymmetric probe has special calibration in liquid at different frequency. SATIMO conducts the probe calibration in compliance with international and national standards (e.g. IEEE Std 1528-2013 and relevant KDB files). The calibration data are in Appendix C.

|                      |   |
|----------------------|---|
| <b>Model</b>         | SSE2  |
| <b>Manufacture</b>   | MVG   |
| <b>Frequency</b>     | 0.45GHz-6GHz<br>Linearity:±0.08dB   |
| <b>Dynamic Range</b> | 0.01W/Kg-100W/Kg<br>Linearity:±0.08dB   |
| <b>Dimensions</b>    | Overall length:330mm<br>Length of individual dipoles:2mm<br>Maximum external diameter:8mm<br>Probe Tip external diameter:2.5mm<br>Distance between dipoles/ probe extremity:1mm |

## TEST REPORT

### VIDEO POSITIONING SYSTEM

The video positioning system is used in OpenSAR to check the probe. Which is composed of a camera, LED, mirror and mechanical parts. The camera is piloted by the main computer with firewire link.

During the process, the actual position of the probe tip with respect to the robot arm is measured, as well as the probe length and the horizontal probe offset. The software then corrects all movements, such that the robot coordinates are valid for the probe tip.

The repeatability of this process is better than 0.1 mm. If a position has been taught with an aligned probe, the same position will be reached with another aligned probe within 0.1 mm, even if the other probe has different dimensions. During probe rotations, the probe tip will keep its actual position.

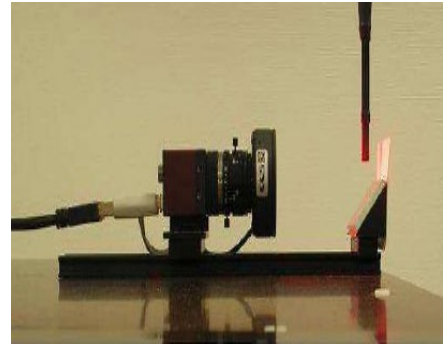

## TEST REPORT

### SAM TWIN PHANTOM

The SAM twin phantom is a fiberglass shell phantom with  $2\text{mm} \pm 0.2\text{ mm}$  shell thickness (except the ear region where shell thickness increases to  $6\text{mm} \pm 0.2\text{ mm}$ ), relative permittivity  $\epsilon_r = 3.4$  and loss tangent  $\delta = 0.02$ . It has three measurement areas:

- Left head
- Right head
- Flat phantom



The bottom plate contains three pair of bolts for locking the device holder. The device holder positions are adjusted to the standard measurement positions in the three sections. A white cover is provided to tap the phantom during off-periods to prevent water evaporation and changes in the liquid parameters. On the phantom top, three reference markers are provided to identify the phantom position with respect to the robot.

## TEST REPORT

### ELLIPTICAL PHANTOM

The elliptical phantom is a fiberglass shell phantom with

- $2\text{mm} \pm 0.2\text{ mm}$  shell thickness
- relative permittivity  $\epsilon_r = 3.4$
- loss tangent  $\delta = 0.02$



### DEVICE HOLDER

The COMOSAR device holder is designed to cope with different positions given in the standard. It has two scales for the device rotation (with respect to the body axis) and the device inclination (with respect to the line between the ear reference points). The rotation center for both scales is the ear reference point (EPR).

Thus the device needs no repositioning when changing the angles.

The COMOSAR device holder has been made out of low-loss POM material having the following dielectric parameters: relative permittivity  $\epsilon_r = 3.7$  and loss tangent  $\delta = 0.005$ . The amount of dielectric material has been reduced in the closest vicinity of the device, since measurements have suggested that the influence of the clamp on the test results could thus be lowered.

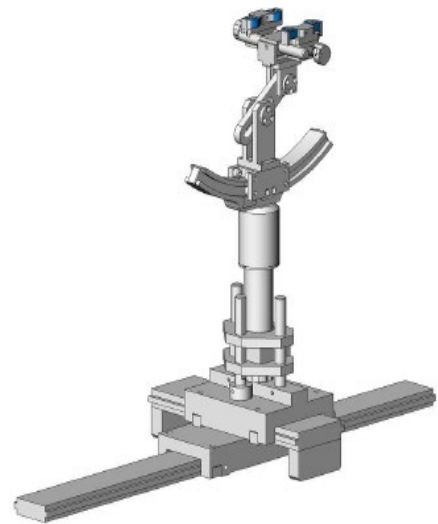

## TEST REPORT

During measurement, the system first does an area (2D) scan at a fixed depth within the liquid from the inside wall of the phantom scanning area is greater than the projection of EUT and antenna.

Area Scan Parameters extracted from KDB 865664

|  | ≤ 3 GHz   | > 3 GHz   |
|--|---|---|
| Maximum distance from closest measurement point (geometric center of probe sensors) to phantom surface | 5 mm ± 1 mm   | $\frac{1}{2} \cdot \delta \cdot \ln(2)$ mm ± 0.5 mm |
| Maximum probe angle from probe axis to phantom surface normal at the measurement location              | 30° ± 1°  | 20° ± 1°  |
| Maximum area scan spatial resolution: $\Delta x_{Area}$ , $\Delta y_{Area}$                            | ≤ 2 GHz: ≤ 15 mm<br>2 – 3 GHz: ≤ 12 mm  | 3 – 4 GHz: ≤ 12 mm<br>4 – 6 GHz: ≤ 10 mm            |
|  | When the x or y dimension of the test device, in the measurement plane orientation, is smaller than the above, the measurement resolution must be ≤ the corresponding x or y dimension of the test device with at least one measurement point on the test device. |   |

When the maximum SAR point has been found, the system will then carry out a zoom (3D) scan centered at that point to determine volume averaged SAR level.

Zoom Scan Parameters extracted from KDB 865664

| Maximum zoom scan spatial resolution: $\Delta x_{Zoom}$ , $\Delta y_{Zoom}$  |                                    | ≤ 2 GHz: ≤ 8 mm<br>2 – 3 GHz: ≤ 5 mm*  | 3 – 4 GHz: ≤ 5 mm*<br>4 – 6 GHz: ≤ 4 mm*                       |
|--|------------------------------------|--|--|
| Maximum zoom scan spatial resolution, normal to phantom surface  | uniform grid: $\Delta z_{Zoom}(n)$ | ≤ 5 mm   | 3 – 4 GHz: ≤ 4 mm<br>4 – 5 GHz: ≤ 3 mm<br>5 – 6 GHz: ≤ 2 mm    |
|  | graded grid                        | $\Delta z_{Zoom}(1)$ : between 1 <sup>st</sup> two points closest to phantom surface | 3 – 4 GHz: ≤ 3 mm<br>4 – 5 GHz: ≤ 2.5 mm<br>5 – 6 GHz: ≤ 2 mm  |
|  |                                    | $\Delta z_{Zoom}(n>1)$ : between subsequent points                                   | ≤ 1.5 · $\Delta z_{Zoom}(n-1)$ mm                              |
| Minimum zoom scan volume   | x, y, z                            | ≥ 30 mm  | 3 – 4 GHz: ≥ 28 mm<br>4 – 5 GHz: ≥ 25 mm<br>5 – 6 GHz: ≥ 22 mm |
| Note: $\delta$ is the penetration depth of a plane-wave at normal incidence to the tissue medium; see IEEE Std 1528-2013 for details.<br>* When zoom scan is required and the <i>reported</i> SAR from the <i>area scan based 1-g SAR estimation</i> procedures of KDB Publication 447498 is ≤ 1.4 W/kg, ≤ 8 mm, ≤ 7 mm and ≤ 5 mm zoom scan resolution may be applied, respectively, for 2 GHz to 3 GHz, 3 GHz to 4 GHz and 4 GHz to 6 GHz. |                                    |  |  |

**TEST REPORT**

**4. TISSUE VERIFICATION**

For SAR measurement of field distribution inside phantom, homogeneous tissue simulating liquid as below liquid recipes were filled to a depth of 15cm ± 0.5cm for below 3GHz measurement and of 10cm ± 0.5cm for above 3GHz.

**HEAD TISSUE RECIPES**

| Frequency | De-ionized Water | Ingredients |                 |       |       |             |
|-----------|------------------|-------------|-----------------|-------|-------|-------------|
|           |                  | Salt        | 1,2 propanediol | DGBE  | DGMH  | Triton X100 |
| 450 MHz   | 33.5%            | 3.4%        | 63.1%           |       |       |             |
| 750 MHz   | 34.2%            | 1.4%        | 64.4%           |       |       |             |
| 900 MHz   | 35.3%            | 1.0%        | 63.7%           |       |       |             |
| 1800 MHz  | 55.2%            | 0.6%        |                 | 13.8% |       | 30.4%       |
| 1900 MHz  | 55.3%            | 0.5%        |                 | 13.8% |       | 30.4%       |
| 2000 MHz  | 55.3%            | 0.4%        |                 | 13.8% |       | 30.5%       |
| 2450 MHz  | 55.7%            | 0.3%        |                 | 18.7% |       | 25.3%       |
| 5000 MHz  | 65.3%            |             |                 |       | 17.2% | 17.5%       |

**BODY TISSUE RECIPES**

| Frequency | De-ionized Water | Ingredients |                 |      |       |             |
|-----------|------------------|-------------|-----------------|------|-------|-------------|
|           |                  | Salt        | 1,2 propanediol | DGBE | DGMH  | Triton X100 |
| 450 MHz   | 52.4%            | 1.9%        | 45.7%           |      |       |             |
| 750 MHz   | 55.4%            | 1.3%        | 43.3%           |      |       |             |
| 900 MHz   | 52.9%            | 1.0%        | 46.1%           |      |       |             |
| 1800 MHz  | 70.8%            | 0.5%        |                 | 8.7% |       | 20.0%       |
| 1900 MHz  | 70.1%            | 0.4%        |                 | 8.9% |       | 20.6%       |
| 2000 MHz  | 70.2%            | 0.3%        |                 | 8.6% |       | 20.9%       |
| 2450 MHz  | 70.8%            | 0.3%        |                 | 8.7% |       | 20.2%       |
| 5000 MHz  | 77.8%            |             |                 |      | 11.7% | 11.5%       |

**TEST REPORT**

The head tissue dielectric parameters recommended by the IEEE Std 1528 have been incorporated in the following table. These head parameters are derived from planar layer models simulating the highest expected SAR for the dielectric properties and tissue thickness variations in a human head. For other head and body tissue parameters, they are recommended by KDB 865664.

| Target Frequency<br>(MHz) | head         |                | body         |                |
|---------------------------|--------------|----------------|--------------|----------------|
|                           | $\epsilon_r$ | $\sigma$ (S/m) | $\epsilon_r$ | $\sigma$ (S/m) |
| 300                       | 45.3         | 0.87           | 58.2         | 0.92           |
| 450                       | 43.5         | 0.87           | 56.7         | 0.94           |
| 835                       | 41.5         | 0.90           | 55.2         | 0.97           |
| 900                       | 41.5         | 0.97           | 55.0         | 1.05           |
| 915                       | 41.5         | 1.01           | 55.0         | 1.06           |
| 1450                      | 40.5         | 1.20           | 54.0         | 1.30           |
| 1610                      | 40.3         | 1.29           | 53.8         | 1.40           |
| 1800 – 2000               | 40.0         | 1.40           | 53.3         | 1.52           |
| 2450                      | 39.2         | 1.80           | 52.7         | 1.95           |
| 3000                      | 38.5         | 2.40           | 52.0         | 2.73           |
| 5800                      | 35.3         | 5.27           | 48.2         | 6.00           |

( $\epsilon_r$  = relative permittivity,  $\sigma$  = conductivity and  $\rho = 1000$  kg/m<sup>3</sup>)

When a transmission band overlaps with one of the target frequencies, the tissue dielectric parameters of the tissue medium at the middle of a device transmission band should be within  $\pm 5\%$  of the parameters specified at that target frequency.



## TEST REPORT

The dielectric parameters of the liquids were verified prior to the SAR evaluation using SATIMO Dielectric Probe Kit and R&S Network Analyzer ZVL6.

The dielectric parameters were:

### Head Liquid

| Freq. (MHz) | Temp. (°C) | $\epsilon_r$ / Relative Permittivity |         |                        | $\sigma$ / Conductivity |         |                        | $\rho$ ** (kg/m <sup>3</sup> ) |
|-------------|------------|--------------------------------------|---------|------------------------|-------------------------|---------|------------------------|--------------------------------|
|             |            | measured                             | Target* | $\Delta$ ( $\pm 5\%$ ) | measured                | Target* | $\Delta$ ( $\pm 5\%$ ) |                                |
| 1900        | 21.1       | 38.86                                | 40      | -2.85                  | 1.42                    | 1.4     | 1.43                   | 1000                           |
| 1920        | 21.1       | 39.80                                | 40      | -0.50                  | 1.43                    | 1.4     | 2.14                   | 1000                           |
| 1930        | 21.1       | 41.35                                | 40      | 3.38                   | 1.37                    | 1.4     | -2.14                  | 1000                           |

\* Target values refer to KDB 865664

\*\* Worst-case assumption

### Note:

1. Date of tissue verification measurement: Jan 29, 2021
2. Ambient temperature: 21.1 deg C
3. The temperature condition is within +/- 2 deg. C during the SAR measurements.

**TEST REPORT**

**5. SAR MEASUREMENT SYSTEM VERIFICATION**

Each SATIMO system is equipped with one or more system check kits. These units, together with the predefined measurement procedures within the SATIMO software, enable user to conduct the system check. System kit includes a dipole, and dipole device holder.

The system check verifies that the system operates within its specifications. It's performed daily or before every SAR measurement. The system check uses normal SAR measurement in the flat section of the phantom with a matched dipole at a specified distance. The system check setup is shown as below.

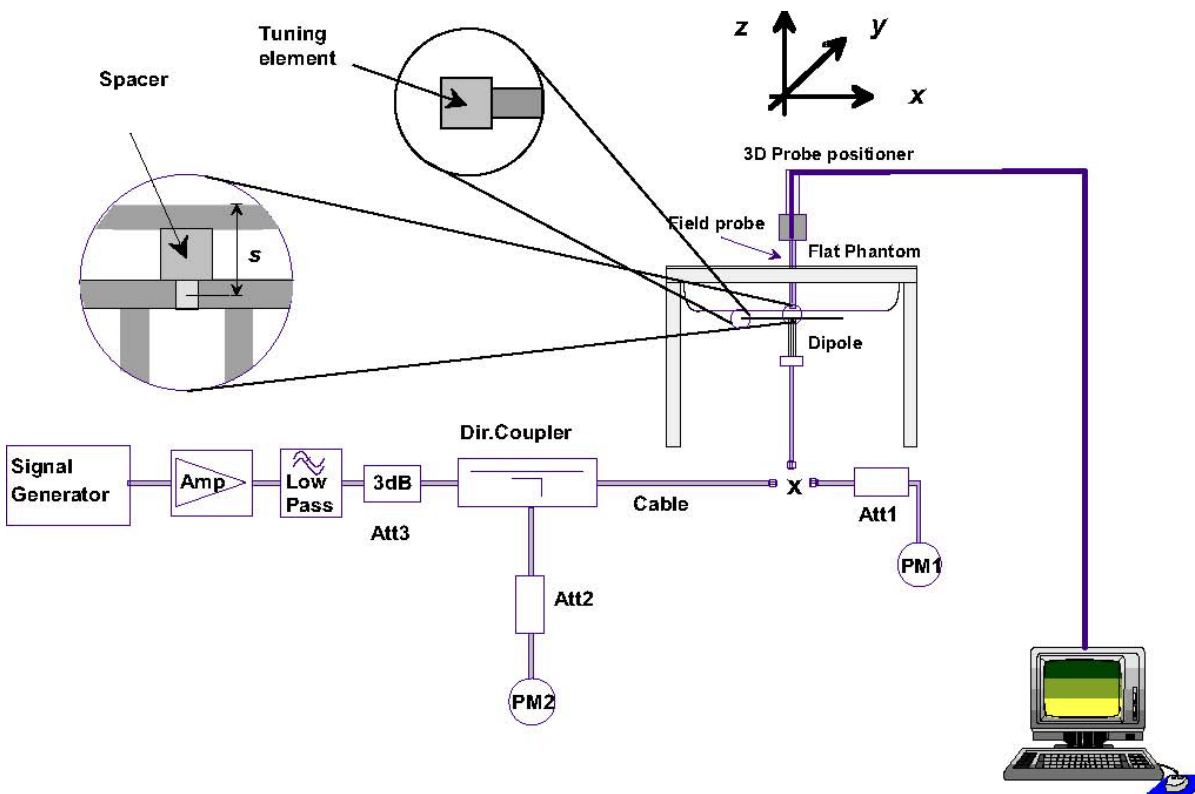

**TEST REPORT**

**VALIDATION DIPOLE**



The dipoles used is based on the IEEE Std 1528, and is complied with mechanical and electrical specifications in line with the requirements of both FCC and KDB requirement.

**SYSTEM CHECK RESULTS**

| Date        | Freq. (MHz) | Liquid Type | System Diople | System Verification          |                                 |                                   |                                     |                  |
|-------------|-------------|-------------|---------------|------------------------------|---------------------------------|-----------------------------------|-------------------------------------|------------------|
|             |             |             |               | Serial No.                   | Target SAR <sub>1g</sub> (W/kg) | Measured SAR <sub>1g</sub> (W/kg) | Normalized SAR <sub>1g</sub> (W/kg) | Deviation (±10%) |
| Jan 29 2021 | 1900        | Head        | 1900MHz       | SN 15/16<br>DIP<br>1G900-402 | 39.61                           | 3.851                             | 38.51                               | -2.78            |

- \* the target was quoted from dipole calibration report
- \* Input power level = 20dBm (0.1W)

SAR<sub>1g</sub> ambient measured value < 12 mW/kg

Details of System Verification plots are shown in the Appendix A - plot 1.

## TEST REPORT

### 6. SAR EVALUATION

#### 6.1. Device test positions relative to the head

This practice specifies two handset test positions against the head phantom—the “cheek” position and the “tilt” position. These two test positions are defined in the following subclauses. The handset should be tested in both positions on left and right sides of the SAM phantom. If handset construction is such that the handset positioning procedures described below to represent normal use conditions cannot be used, e.g., some asymmetric handsets, alternative alignment procedures should be adapted with all details provided in the test report. These alternative procedures should replicate intended use conditions as closely as possible according to the intent of the procedures described in this subclause.

## TEST REPORT

### DEFINITION OF THE CHEEK POSITION

The cheek position is established as follows:

1. Ready the handset for talk operation, if necessary. For example, for handsets with a cover piece (flip cover), open the cover. If the handset can transmit with the cover closed, both configurations must be tested.
2. Define two imaginary lines on the handset—the vertical centerline and the horizontal line. The vertical centerline passes through two points on the front side of the handset—the midpoint of the width  $w_t$  of the handset at the level of the acoustic output (point A in below figure), and the midpoint of the width  $w_b$  of the bottom of the handset (point B). The horizontal line is perpendicular to the vertical centerline and passes through the center of the acoustic output (see below left figure). The two lines intersect at point A. Note that for many handsets, point A coincides with the center of the acoustic output; however, the acoustic output may be located elsewhere on the horizontal line. Also note that the vertical centerline is not necessarily parallel to the front face of the handset (see right figure), especially for clamshell handsets, handsets with flip covers, and other irregularly-shaped handsets.
3. Position the handset close to the surface of the phantom such that point A is on the (virtual) extension of the line passing through points RE and LE on the phantom (see the figure as next page), such that the plane defined by the vertical centerline and the horizontal line of the handset is approximately parallel to the sagittal plane of the phantom.
4. Translate the handset towards the phantom along the line passing through RE and LE until handset point A touches the pinna at the ERP.

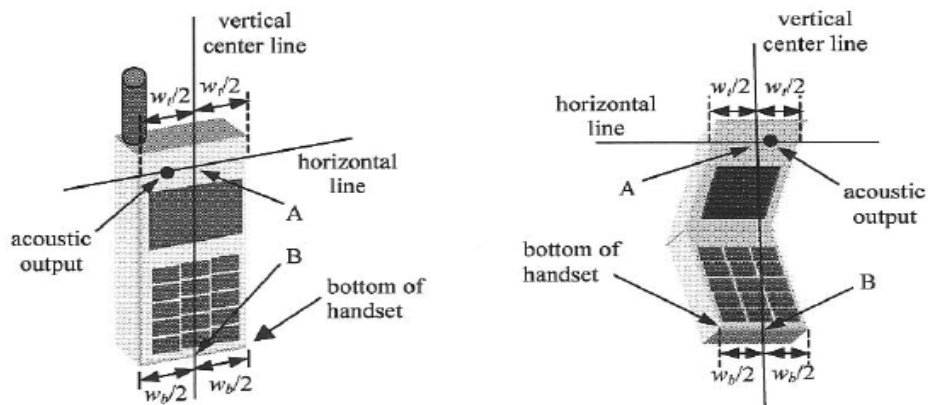

## TEST REPORT

5. While maintaining the handset in this plane, rotate it around the LE-RE line until the vertical centerline is in the plane normal to the plane containing B-M and N-F lines, i.e., the Reference Plane.
6. Rotate the handset around the vertical centerline until the handset (horizontal line) is parallel to the N-F line.
7. While maintaining the vertical centerline in the Reference Plane, keeping point A on the line passing through RE and LE, and maintaining the handset contact with the pinna, rotate the handset about the N-F line until any point on the handset is in contact with a phantom point below the pinna on the cheek.

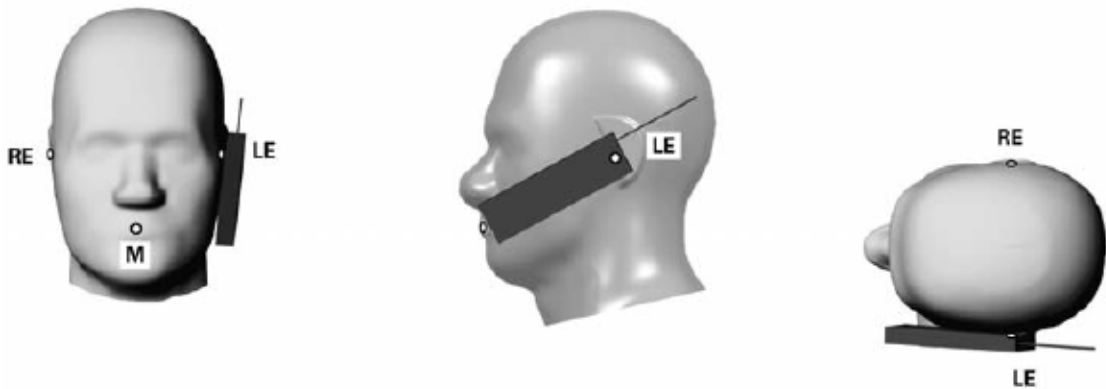

## TEST REPORT

### DEFINITION OF THE TILT POSITION

The tilt position is established as follows:

1. Repeat steps to place the device in the cheek position.
2. While maintaining the orientation of the handset, move the handset away from the pinna along the line passing through RE and LE far enough to allow a rotation of the handset away from the cheek by 15°.
3. Rotate the handset around the horizontal line by 15°.
4. While maintaining the orientation of the handset, move the handset towards the phantom on the line passing through RE and LE until any part of the handset touches the ear. The tilt position is obtained when the contact point is on the pinna. See the figure as below. If contact occurs at any location other than the pinna, e.g., the antenna at the back of the phantom head, the angle of the handset should be reduced.
5. In this case, the tilt position is obtained if any point on the handset is in contact with the pinna and a second point on the handset is in contact with the phantom, e.g., the antenna with the back of the head.

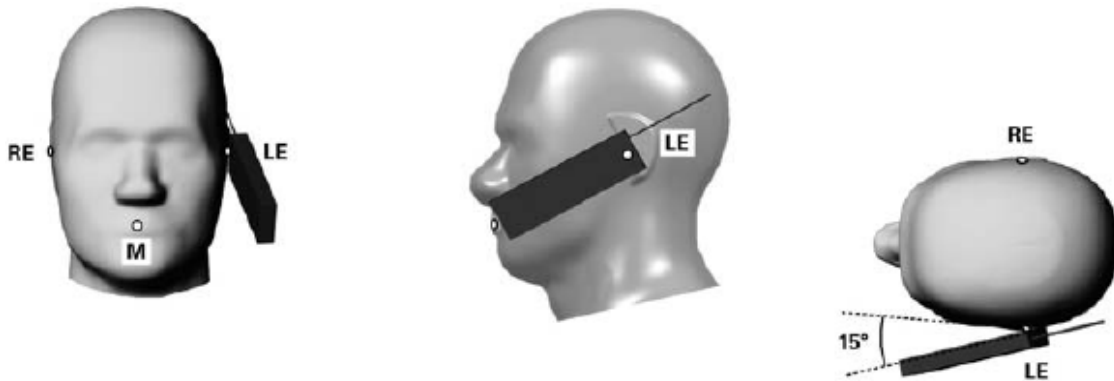

## TEST REPORT

### 6.2. Device test positions relative to body-worn accessory

Body-worn operating configurations are tested with the belt-clips and holsters attached to the device and positioned against a flat phantom in a normal use configuration. Per FCC KDB Publication 648474, Body-worn accessory exposure is typically related to voice mode operations when handsets are carried in body worn accessories. The body-worn accessory procedures in FCC KDB Publication 447498 should be used to test for body-worn accessory SAR compliance, without a headset connected to it. This enables the test results for such configuration to be compatible with that required for hotspot mode when the body-worn accessory test separation distance is greater than or equal to that required for hotspot mode, when applicable. When the reported SAR for a body-worn accessory, measured without a headset connected to the handset, is  $>1.2\text{W/kg}$ , the highest reported SAR configuration for that wireless mode and frequency band should be reported for that body-worn accessory with a headset attached to the handset.

SAR evaluation is required for body-worn accessories supplied with the host device. The test configurations must be conservative for supporting the body-worn accessory use conditions expected by users. Body-worn accessories that do not contain metallic or conductive components may be tested according to worst-case exposure configurations, typically according to the smallest test separation distance required for the group of body-worn accessories with similar operating and exposure characteristics. All body-worn accessories containing metallic components, either supplied with the product or available as an option from the device manufacturer, must be tested in conjunction with the host device to demonstrate compliance

Body-worn accessories may not always be supplied or available as options for some devices intended to be authorized for body-worn use. In this case, a test configuration with a separation distance between the back of the device and the flat phantom is used. Test position spacing was documented. Transmitters that are designed to operate in front of a person's face, as in push-to-talk configurations, are tested for SAR compliance with the front of the device positioned to face the flat phantom in head fluid.



## TEST REPORT

### 6.3. General Device Setup

The device was first charged on a charger over a duration defined by the applicant to make sure the installed battery was fully charged.

The device was then placed into TBR6 test mode to simulate the worst case voice call configuration through highest power channel, where the operating parameters established in this TBR6 test mode is identical to those programmed in production units, including output power levels, amplifier gain settings and other RF performance tuning parameters. The test frequency is corresponded to actual channel frequencies defined for domestic use.

During testing, the device was evaluated with a fully charged battery, power saving function disabled and was configured to operate at maximum output power. A receive antenna and a base station simulator – Digital Radiocommunication Tester, model: CMD60 were placed with a distance > 50cm away from the device to established the voice call communication and monitor the transmission states.

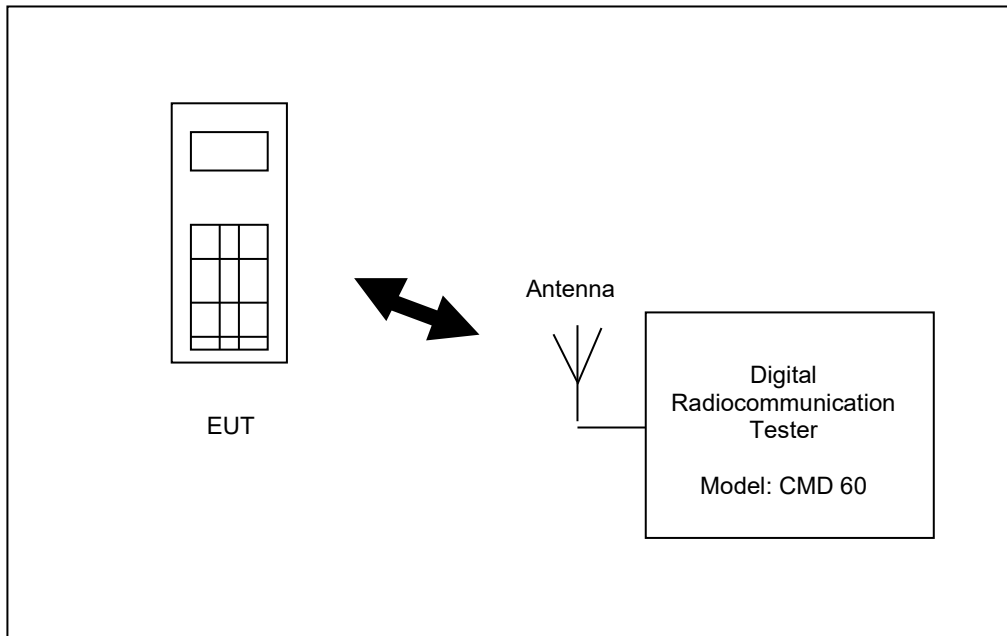

**TEST REPORT**

**6.4. RF Output Power Measurements**

| Frequency   | Channel    | Duty Cycle | Maximum tune-up power (dBm) | Measured Conducted Power (Peak) (dBm) | Measured Conducted Power (Time average) (dBm) |
|-------------|------------|------------|-----------------------------|---------------------------------------|---|
| 1.9GHz DECT | Low - 4    | 1/24       | 21                          | 19.4                                  | 5.6   |
|             | Middle - 2 |            |                             | 19.4                                  | 5.6   |
|             | High - 0   |            |                             | 19.4                                  | 5.6   |

Note:

1. Time Average power (dBm) = Peak power (dBm) + Time Average factor.
2. Time Average factor =  $10 \cdot \log(\text{duty cycle})$
3. Per KDB 447498, the tested device was within the specified tune-up tolerances range, but not more than 2dB lower than the maximum tune-up tolerance limit.
4. Per KDB 447498, when antenna port was not available on the device to support conducted power measurement and test software was used to establish transmitter power levels, the power level was verified separately according to design and component specifications and product development information specified by the manufacturer.

## TEST REPORT

### 6.5. Exposure Conditions

#### Head Exposure Conditions

| Test Configurations    | Operation Mode | SAR Required | Note                                     |
|------------------------|----------------|--------------|--|
| Left Cheek             | Voice          | Yes          | Corun rechargeable battery pack (300mAh) |
| Left Tilt (15 degree)  | Voice          | Yes          | Corun rechargeable battery pack (300mAh) |
| Right Cheek            | Voice          | Yes          | Corun rechargeable battery pack (300mAh) |
| Right Tilt (15 degree) | Voice          | Yes          | Corun rechargeable battery pack (300mAh) |
| Left Cheek             | Voice          | Yes          | HP rechargeable battery pack (300mAh)    |
| Left Cheek             | Voice          | Yes          | GP rechargeable battery pack (300mAh)    |

Note:

1. Highest reported SAR test configuration was repeated for additional supported batteries.

## TEST REPORT

### 6.6. Test Result

The results on the following page(s) were obtained when the device was tested in the condition described in this report. Detailed measurement data and plots, which reveal information about the location of the maximum SAR with respect to the device, are reported in Appendix B.

#### Head SAR

| Chan | Freq. (MHz) | Battery        | Mode  | Test Position | Measurement Result          |                      |               |                                   |                |                                   |      |
|------|-------------|----------------|-------|---------------|-----------------------------|----------------------|---------------|-----------------------------------|----------------|-----------------------------------|------|
|      |             |                |       |               | Maximum Allowed Power (dBm) | Measured Power (dBm) | SAR Drift (%) | Measured SAR <sub>1g</sub> (W/kg) | Scaling factor | Reported SAR <sub>1g</sub> (W/kg) | Plot |
| 2    | 1924        | Corun (300mAh) | Voice | Left cheek    | 21.0                        | 19.4                 | 0.51          | 0.0276                            | 1.45           | 0.0399                            | 1    |
| 2    | 1924        | Corun (300mAh) | Voice | Right cheek   | 21.0                        | 19.4                 | -2.16         | 0.0090                            | 1.45           | 0.0130                            |      |
| 2    | 1924        | Corun (300mAh) | Voice | Left tilt     | 21.0                        | 19.4                 | -1.23         | 0.0206                            | 1.45           | 0.0298                            |      |
| 2    | 1924        | Corun (300mAh) | Voice | Right tilt    | 21.0                        | 19.4                 | 3.11          | 0.0099                            | 1.45           | 0.0143                            |      |
| 2    | 1924        | HP (300mAh)    | Voice | Left cheek    | 21.0                        | 19.4                 | 0.45          | 0.0206                            | 1.45           | 0.0298                            |      |
| 2    | 1924        | GP (300mAh)    | Voice | Left cheek    | 21.0                        | 19.4                 | -0.26         | 0.0218                            | 1.45           | 0.0315                            |      |

Note:

1. Fully charged batteries were used at the beginning of each SAR measurement.
2. There was no power reduction used for any band/mode implemented in this device.
3. Reported SAR results were scaled to the maximum allowed power with the scaling factor equation  $-10^{[(\text{Maximum power} - \text{measured power}) / 10]}$ .
4. Per KDB 447498 D01, when the maximum output power variation across the required test channels was < 0.5 dB, measurement on middle channel was required.
5. Per KDB 865664 D01, repeated measurement was not required when the original highest measured SAR was < 0.8W/kg.
6. Per KDB 865664 D02, SAR plot is required for the highest measured SAR in each exposure configuration, wireless mode and frequency band combination.

## TEST REPORT

### 6.7. SAR Limits

The following FCC limits (Std. C95.1-1992) for SAR apply to devices operate in General Population/Uncontrolled Exposure and Controlled environment:

#### GENERAL POPULATION / UNCONTROLLED ENVIRONMENTS:

Defined as location where there is the exposure of individuals who have no knowledge or control of their exposure.

| EXPOSURE<br>(General Population/Uncontrolled Exposure environment) | SAR<br>(W/kg) |
|--|---------------|
| Spatial Peak SAR (Head)*   | 1.60          |
| Spatial Peak SAR (Partial Body)*                                   | 1.60          |
| Spatial Peak SAR (Whole Body)*                                     | 0.08          |
| Spatial Peak SAR (Hands / Wrists / Feet / Ankles)**                | 4.00          |

#### OCCUPATIONAL / CONTROLLED ENVIRONMENTS:

Defined as location where there is the exposure that may be incurred by persons who are aware of the potential for exposure, (i.e. as a result of employment or occupation)

| EXPOSURE<br>(Occupational/Controlled Exposure environment) | SAR<br>(W/kg) |
|--|---------------|
| Spatial Peak SAR (Head)*                                   | 8.00          |
| Spatial Peak SAR (Partial Body)*                           | 8.00          |
| Spatial Peak SAR (Whole Body)*                             | 0.40          |
| Spatial Peak SAR (Hands / Wrists / Feet / Ankles)**        | 20.00         |

#### Notes:

- \* The Spatial Peak value of the SAR averaged over any 1 gram of tissue.  
(defined as a tissue volume in the shape of a cube) and over the appropriate averaging time
- \*\* The Spatial Peak value of the SAR averaged over any 10 gram of tissue.  
(defined as a tissue volume in the shape of a cube) and over the appropriate averaging time

## TEST REPORT

### 7. TEST EQUIPMENT LIST

| Equipment  | Registration No. | Manufacturer    | Model No.   | Calibration Date   | Calibration Due Date |
|--|------------------|-----------------|---|--------------------|----------------------|
| SAR System   | EW-3211          | MVG             | SATIMO System<br>(OpenSAR<br>Software<br>V4_02_34)    | N/A                | N/A                  |
| Phantom  | EW-3211          | SATIMO          | COMOSAR SAM<br>PHANTOM                                | N/A                | N/A                  |
| Digital<br>Multimeter                              | EW-3206          | KEITHLEY        | 2000  | 28 Aug 2019        | 28 Feb 2021          |
| SAR Probe  | EW-3210          | MVG             | SSE2<br>(SN 36/20<br>EPGO347)                         | 12 Nov 2020        | 12 Nov 2021          |
| SAR Dipole   | EW-3212          | MVG             | SN 15/16 DIP<br>1G900-402                             | 08 Apr 2019        | 08 Apr 2022          |
| Dielectric Probe<br>for SAR Test                   | EW-3213          | EW-3213         | Liquid<br>Measurement<br>Kit<br>(SN 24/16 OCPG<br>76) | 29 Jun 2020        | 29 Jun 2021          |
| Head Liquid<br>Tissue                              | N/A              | MVG             | Head Liquid<br>1900MHz                                | Refer to Section 4 |                      |
| Body Liquid<br>Tissue                              | N/A              | MVG             | Body Liquid<br>1900MHz                                | Refer to Section 4 |                      |
| Network Analyzer                                   | EW-3192          | Rhode & Schwarz | ZVL6  | 26 Aug 2019        | 26 Feb 2021          |
| Vector Signal<br>Generator                         | EW-3457          | ROHDESCHWARZ    | SMBV100B  | 25 Feb 2020        | 25 Feb 2021          |
| Dual-directional<br>coupler (0.1-<br>2.0)GHz       | EW-3189          | KEYSIGHT        | 778D  | 07 Dec 2020        | 07 Dec 2021          |
| Digital Radio-<br>communication<br>Tester for DECT | EW-1739          | ROHDESCHWARZ    | CMD60   | 17 Jun 2020        | 17 Jun 2021          |
| Dual-directional<br>coupler (2-18)GHz              | EW-3188          | KEYSIGHT        | 773D  | 23 Dec 2020        | 23 Dec 2021          |
| Power Sensor<br>(Average) (8kHz<br>to 6GHz)        | EW-3367          | ROHDESCHWARZ    | NRP6A   | 16 Oct 2020        | 16 Oct 2021          |
| VTL 5400<br>Amplifier 10 -<br>2500 MHz 3W          | EW-3185          | INDEXSAR        | VTL 5400  | 07 Dec 2020        | 07 Dec 2021          |

## TEST REPORT

### 8. MEASUREMENT UNCERTAINTY

Per FCC KDB 865884, the extensive SAR measurement uncertainty analysis was not required when the highest measured SAR was  $< 1.5\text{W/kg}$  for all frequency band.

### 9. E-FIELD PROBE AND DIPOLE ANTENNA CALIBRATION

Probe calibration factors and dipole antenna calibration are included in Appendix C.

**TEST REPORT**

**APPENDIX A – SYSTEM CHECK DATA**

Plot #1

Operating Frequency: 1900MHz

Test Date: 29 Jan 2021

|                                    |   |
|------------------------------------|---|
| Medium (Liquid Type)               | : 1900 Head                                 |
| Relative permittivity $\epsilon_r$ | : 38.86                                     |
| Conductivity $\sigma$ :            | : 1.42                                      |
| Probe                              | : Model: SSE2; Serial No.: SN 36/20 EPG0347 |
| Crest factor                       | : 1.0                                       |
| Conversion Factor                  | : 1.99                                      |
| Area Scan                          | : dx=8mm, dy=8mm                            |
| Zoom Scan                          | : 7x7x7,dx=5mm dy=5mm dz=5mm                |
| Phantom                            | : SAM phantom                               |
| Device Position                    | : Dipole                                    |
| SAR Drift (%)                      | : -0.25%                                    |
| Maximum location                   | : X=0.00, Y=0.00                            |
| SAR Peak (W/kg)                    | : 6.71 W/kg                                 |
| SAR 10g (W/kg)                     | : 1.872 W/kg                                |
| SAR 1g (W/kg)                      | : 3.851 W/kg                                |

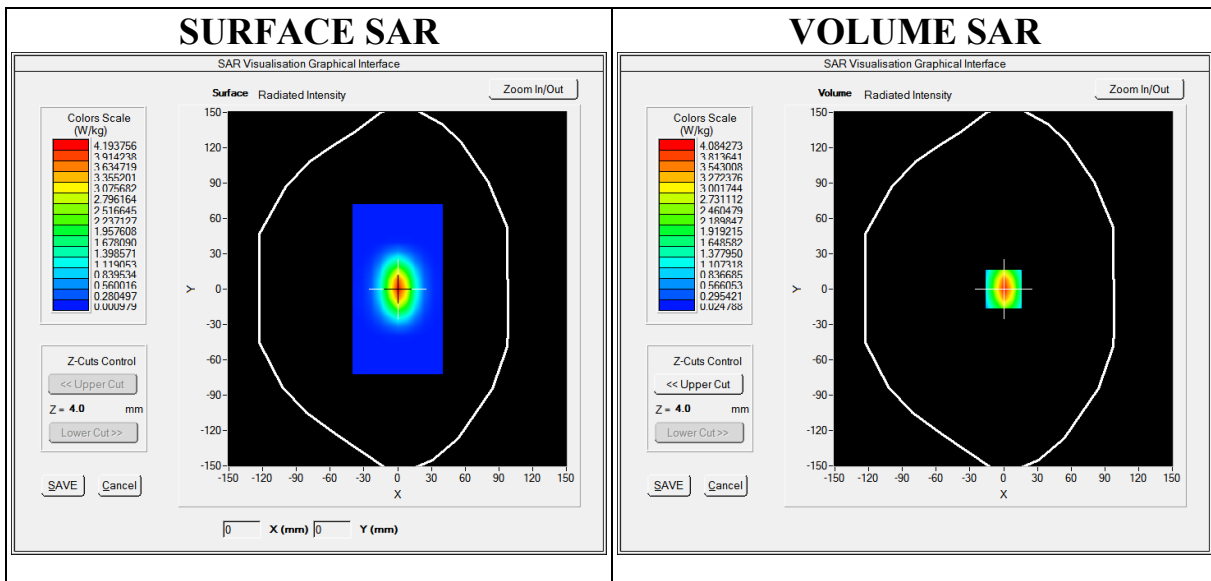



**TEST REPORT**

**APPENDIX B – SAR EVALUATION DATA**

Plot #1

Operating Frequency : 1924.992MHz  
Product Description: DECT 6.0 Cordless Phone  
Model: CS6214-2 (Corun 300mAh rechargeable battery pack)  
Test Date: 29 Jan 2021

|                                    |   |
|------------------------------------|---|
| Medium (Liquid Type)               | : 1900 Head                                 |
| Relative permittivity $\epsilon_r$ | : 38.86                                     |
| Conductivity $\sigma$ :            | : 1.42                                      |
| Probe                              | : Model: SSE2; Serial No.: SN 36/20 EPG0347 |
| Crest factor                       | : 1.0                                       |
| Conversion Factor                  | : 1.99                                      |
| Area Scan                          | : dx=8mm, dy=8mm                            |
| Zoom Scan                          | : 7x7x7,dx=5mm dy=5mm dz=5mm                |
| Phantom                            | : SAM phantom                               |
| Device Position                    | : Left cheek                                |
| SAR Drift (%)                      | : 0.51%                                     |
| Maximum location                   | : X=8.00, Y=1.00                            |
| SAR Peak (W/kg)                    | : 0.08 W/kg                                 |
| SAR 10g (W/kg)                     | : 0.0097 W/kg                               |
| SAR 1g (W/kg)                      | : 0.0276 W/kg                               |

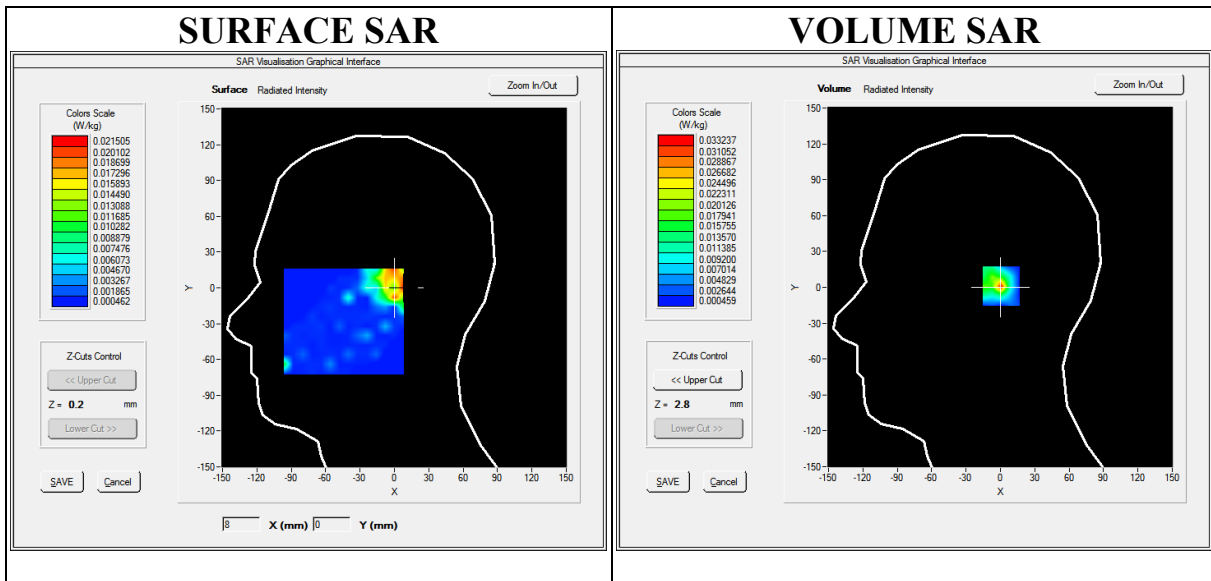

**TEST REPORT**

**APPENDIX C – E-FIELD PROBE AND DIPOLE ANTENNA CALIBRATION**

## Performance Verification Report

For MVG COMOSAR REFERENCE DIPOLE

Frequency: 1900 MHZ

Serial No.: SN 15/16 DIP 1G900-402

Date of Test: Jan 02, 2021

PREPARED AND CHECKED BY:

APPROVED BY:



Intertek Testing  
Services Hong  
Kong Ltd.



Digitally signed by Chow Chi Ming,  
Billy  
DN: cn=Chow Chi Ming, Billy,  
o=Intertek Testing Services Hong  
Kong Ltd, ou,  
email=billy.chow@intertek.com,  
c=HK

Siu Yiu Nam, Edwin  
Senior Lead Engineer  
Date: Feb 10, 2021

Chow Chi Ming, Billy  
Manager  
Date: Feb 10, 2021

Intertek's standard Terms and Conditions can be obtained at our website <http://www.intertek.com/terms/>.

The test report only allows to be revised within the retention period unless further standard or the requirement was noticed.

This report is for the exclusive use of Intertek's Client and is provided pursuant to the agreement between Intertek and its Client. Intertek's responsibility and liability are limited to the terms and conditions of the agreement. Intertek assumes no liability to any party, other than to the Client in accordance with the agreement, for any loss, expense or damage occasioned by the use of this report. Only the Client is authorized to permit copying or distribution of this report and then only in its entirety. Any use of the Intertek name or one of its marks for the sale or advertisement of the tested material, product or service must first be approved in writing by Intertek. The observations and test results in this report are relevant only to the sample tested. This report by itself does not imply that the material, product, or service is or has ever been under an Intertek certification program.

© 2019 Intertek

## 1. INTRODUCTION

According to KDB 865664 SAR measurement 100MHz to 6GHz, it is necessary to re-calibrate reference dipoles at regular intervals to confirm the electrical specifications and SAR targets. A dipole must be calibrated using a fully validated SAR system according to the tissue dielectric parameters and SAR probe calibration frequency required for device testing. It is generally unacceptable to calibrate a dipole using the SAR system that has been validated by the same dipole; therefore, dipoles should be returned to the SAR system manufacturer or its designated calibration facilities for re-calibration. However, instead of the typical annual calibration recommended by measurement standards, longer calibration intervals of up to three years may be considered when it is demonstrated that the SAR target, impedance and return loss of a dipole have remain stable according to the following requirements.

1. The test laboratory must ensure that the required supporting information and documentation are included in the SAR report to qualify for the three-year extended calibration interval; otherwise, the IEEE Std 1528 recommended annual calibration applies.
2. Immediate re-calibration is required for the following conditions.
  - a. After a dipole is damaged and properly repaired to meet required specifications.
  - b. When the measured SAR deviates from the calibrated SAR value by more than 10% due to changes in physical, mechanical, electrical or other relevant dipole conditions; i.e., the error is not introduced by incorrect measurement procedures or other issues relating to the SAR measurement system.
  - c. When the most recent return-loss result, measured at least annually, deviates by more than 20% from the previous measurement (i.e. value in dB x 0.2) or not meeting the required 20 dB minimum return-loss requirement.
  - d. When the most recent measurement of the real or imaginary parts of the impedance, measured at least annually, deviates by more than 5  $\Omega$  from the previous measurement.

And the purpose of this dipole validation report is to demonstrate the SAR target, impedance and return loss of the dipole are still remain stable with reference to the annual calibration data.

## 2. MEASUREMENT CONDITIONS

Measurements were performed using a SAM TWIN phantom with 2mm wall thickness.

A Rhode & Schwarz vector network analyzer was used for the return loss measurements. The dipole was placed in a special holder made of low permittivity, low-loss materials. This holder enables the dipole to be positioned accurately in the centre of the wall of the SAM TWIN phantom used for flat surface testing and verification checks.

### 2.1. Equipment List

| Equipment                             | Registration No. | Manufacturer    | Model No.                                 | Calibration Date     | Calibration Due Date |
|---------------------------------------|------------------|-----------------|---|----------------------|----------------------|
| SAR System                            | EW-3211          | MVG             | SATIMO System (OpenSAR Software V4_02_34) | N/A                  | N/A                  |
| Phantom                               | EW-3211          | SATIMO          | COMOSAR SAM PHANTOM                       | N/A                  | N/A                  |
| Digital Multimeter                    | EW-3206          | KEITHLEY        | 2000                                      | 28 Aug 2019          | 28 Feb 2021          |
| SAR Probe                             | EW-3210          | MVG             | SSE2 (SN 36/20 EPGO347)                   | 12 Nov 2020          | 12 Nov 2021          |
| SAR Dipole                            | EW-3212          | MVG             | SN 15/16 DIP 1G900-402                    | 08 Apr 2019          | 08 Apr 2022          |
| Dielectric Probe for SAR Test         | EW-3213          | EW-3213         | Liquid Measurement Kit (SN 24/16 OCPG 76) | 29 Jun 2020          | 29 Jun 2021          |
| Head Liquid Tissue                    | N/A              | MVG             | Head Liquid 1900MHz                       | Refer to Section 2.2 |                      |
| Body Liquid Tissue                    | N/A              | MVG             | Body Liquid 1900MHz                       | Refer to Section 2.2 |                      |
| Network Analyzer                      | EW-3192          | Rhode & Schwarz | ZVL6                                      | 26 Aug 2019          | 26 Feb 2021          |
| Vector Signal Generator               | EW-3457          | ROHDESCHWARZ    | SMBV100B                                  | 25 Feb 2020          | 25 Feb 2021          |
| Dual-directional coupler (0.1-2.0)GHz | EW-3189          | KEYSIGHT        | 778D                                      | 07 Dec 2020          | 07 Dec 2021          |
| Wideband power sensor                 | EW-3309          | ROHDESCHWARZ    | NRP-Z81                                   | 18 May 2020          | 18 May 2021          |
| VTL 5400 Amplifier 10 - 2500 MHz 3W   | EW-3185          | INDEXSAR        | VTL 5400                                  | 07 Dec 2020          | 07 Dec 2021          |

## TEST REPORT

### 2.2. Tissue Simulating Liquid

For SAR measurement of field distribution inside phantom, homogeneous tissue simulating liquid as below liquid recipes were filled to a depth of  $15\text{cm} \pm 0.5\text{cm}$  for below 3GHz measurement and of  $10\text{cm} \pm 0.5\text{cm}$  for above 3GHz.

#### HEAD TISSUE RECIPES

| Frequency | De-ionized Water | Ingredients |                 |       |       |             |
|-----------|------------------|-------------|-----------------|-------|-------|-------------|
|           |                  | Salt        | 1,2 propanediol | DGBE  | DGMH  | Triton X100 |
| 450 MHz   | 33.5%            | 3.4%        | 63.1%           |       |       |             |
| 750 MHz   | 34.2%            | 1.4%        | 64.4%           |       |       |             |
| 900 MHz   | 35.3%            | 1.0%        | 63.7%           |       |       |             |
| 1800 MHz  | 55.2%            | 0.6%        |                 | 13.8% |       | 30.4%       |
| 1900 MHz  | 55.3%            | 0.5%        |                 | 13.8% |       | 30.4%       |
| 2000 MHz  | 55.3%            | 0.4%        |                 | 13.8% |       | 30.5%       |
| 2450 MHz  | 55.7%            | 0.3%        |                 | 18.7% |       | 25.3%       |
| 5000 MHz  | 65.3%            |             |                 |       | 17.2% | 17.5%       |

#### BODY TISSUE RECIPES

| Frequency | De-ionized Water | Ingredients |                 |      |       |             |
|-----------|------------------|-------------|-----------------|------|-------|-------------|
|           |                  | Salt        | 1,2 propanediol | DGBE | DGMH  | Triton X100 |
| 450 MHz   | 52.4%            | 1.9%        | 45.7%           |      |       |             |
| 750 MHz   | 55.4%            | 1.3%        | 43.3%           |      |       |             |
| 900 MHz   | 52.9%            | 1.0%        | 46.1%           |      |       |             |
| 1800 MHz  | 70.8%            | 0.5%        |                 | 8.7% |       | 20.0%       |
| 1900 MHz  | 70.1%            | 0.4%        |                 | 8.9% |       | 20.6%       |
| 2000 MHz  | 70.2%            | 0.3%        |                 | 8.6% |       | 20.9%       |
| 2450 MHz  | 70.8%            | 0.3%        |                 | 8.7% |       | 20.2%       |
| 5000 MHz  | 77.8%            |             |                 |      | 11.7% | 11.5%       |

## TEST REPORT

The head tissue dielectric parameters recommended by the IEEE Std 1528 have been incorporated in the following table. These head parameters are derived from planar layer models simulating the highest expected SAR for the dielectric properties and tissue thickness variations in a human head. For other head and body tissue parameters, they are recommended by KDB 865664.

| Target Frequency<br>(MHz) | head         |                | body         |                |
|---------------------------|--------------|----------------|--------------|----------------|
|                           | $\epsilon_r$ | $\sigma$ (S/m) | $\epsilon_r$ | $\sigma$ (S/m) |
| 300                       | 45.3         | 0.87           | 58.2         | 0.92           |
| 450                       | 43.5         | 0.87           | 56.7         | 0.94           |
| 835                       | 41.5         | 0.90           | 55.2         | 0.97           |
| 900                       | 41.5         | 0.97           | 55.0         | 1.05           |
| 915                       | 41.5         | 1.01           | 55.0         | 1.06           |
| 1450                      | 40.5         | 1.20           | 54.0         | 1.30           |
| 1610                      | 40.3         | 1.29           | 53.8         | 1.40           |
| 1800 – 2000               | 40.0         | 1.40           | 53.3         | 1.52           |
| 2450                      | 39.2         | 1.80           | 52.7         | 1.95           |
| 3000                      | 38.5         | 2.40           | 52.0         | 2.73           |
| 5800                      | 35.3         | 5.27           | 48.2         | 6.00           |

( $\epsilon_r$  = relative permittivity,  $\sigma$  = conductivity and  $\rho = 1000 \text{ kg/m}^3$ )

When a transmission band overlaps with one of the target frequencies, the tissue dielectric parameters of the tissue medium at the middle of a device transmission band should be within  $\pm 5\%$  of the parameters specified at that target frequency.

## TEST REPORT

The dielectric parameters of the liquids were verified prior to the SAR evaluation using SATIMO Dielectric Probe Kit and R&S Network Analyzer ZVL6.

The dielectric parameters were:

### Head Liquid

| Freq.<br>(MHz) | Temp.<br>(°C) | $\epsilon_r$ / Relative Permittivity |         |                        | $\sigma$ / Conductivity |         |                        | $\rho$<br>**(kg/m <sup>3</sup> ) |
|----------------|---------------|--------------------------------------|---------|------------------------|-------------------------|---------|------------------------|----------------------------------|
|                |               | measured                             | Target* | $\Delta$ ( $\pm 5\%$ ) | measured                | Target* | $\Delta$ ( $\pm 5\%$ ) |                                  |
| 1900           | 21.1          | 38.06                                | 40.00   | -4.85                  | 1.43                    | 1.40    | 2.14                   | 1000                             |

\* Target values refer to KDB 865664

\*\* Worst-case assumption

Note:

1. Date of tissue verification measurement: Jan 02, 2021
2. Ambient temperature: 21.1 deg C
3. The temperature condition is within +/- 2 deg. C during the SAR measurements.

### Body Liquid

| Freq.<br>(MHz) | Temp.<br>(°C) | $\epsilon_r$ / Relative Permittivity |         |                        | $\sigma$ / Conductivity |         |                        | $\rho$<br>**(kg/m <sup>3</sup> ) |
|----------------|---------------|--------------------------------------|---------|------------------------|-------------------------|---------|------------------------|----------------------------------|
|                |               | measured                             | Target* | $\Delta$ ( $\pm 5\%$ ) | measured                | Target* | $\Delta$ ( $\pm 5\%$ ) |                                  |
| 1900           | 21.1          | 54.76                                | 53.30   | 2.74                   | 1.55                    | 1.52    | 1.97                   | 1000                             |

\* Target values refer to KDB 865664

\*\* Worst-case assumption

Note:

1. Date of tissue verification measurement: Jan 02, 2021
2. Ambient temperature: 21.1 deg C
3. The temperature condition is within +/- 2 deg. C during the SAR measurements.



### 3. DIPOLE IMPEDANCE AND RETURN LOSS

The dipoles are designed to have low return loss ONLY when presented against a lossy-phantom at the specified distance. A Vector Network Analyzer (VNA) was used to perform a return loss measurement on the specific dipole when in the measurement-location against the SAM TWIN phantom. The distance was as specified in the standard i.e. 10mm from the liquid (for 1900MHz).

The impedance was measured at the SMA-connector with the network analyzer.

#### Head Liquid

#### DIPOLE IMPEDANCE

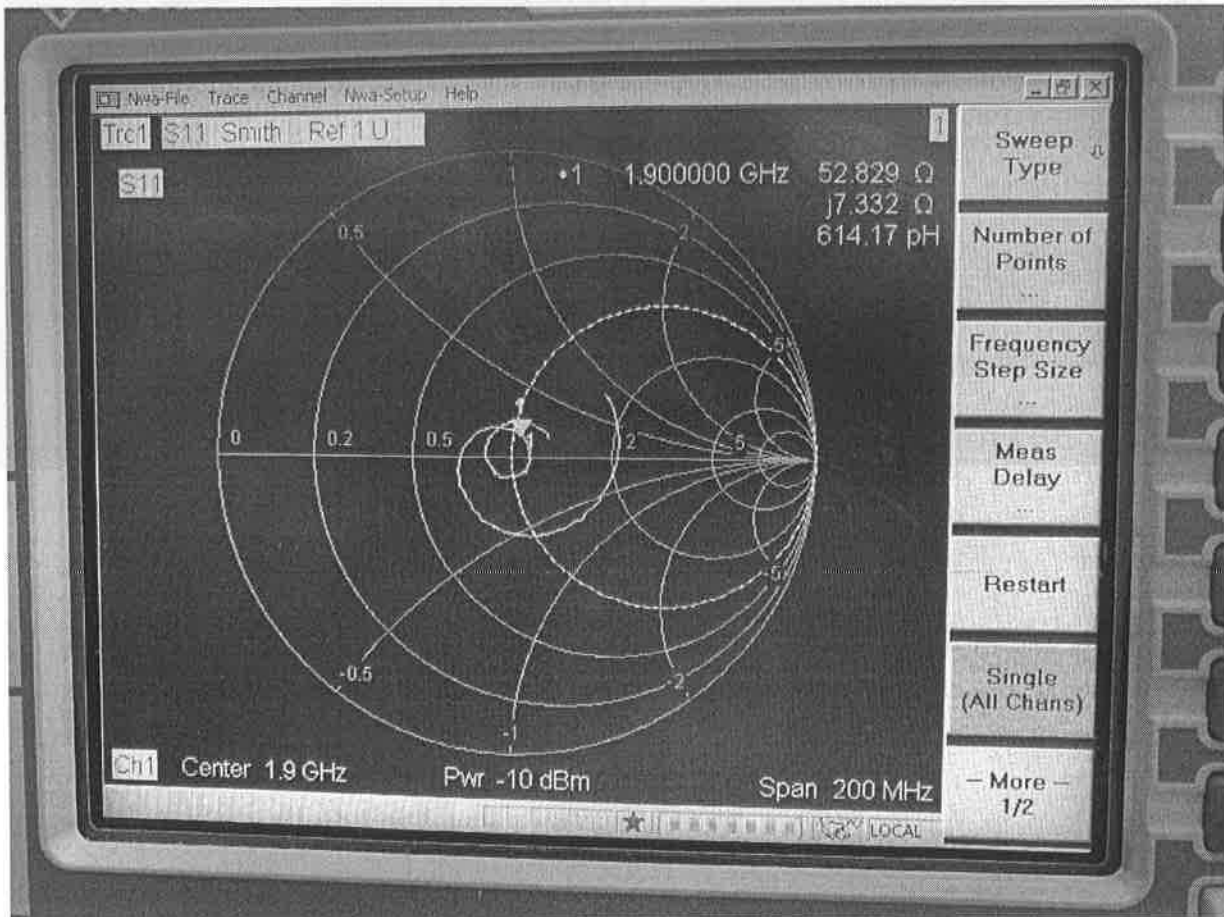

| Freq.<br>(MHz) | Temp.<br>(°C) | Dipole impedance Re{Z} |         |         | Dipole impedance Im{Z} |         |         |
|----------------|---------------|------------------------|---------|---------|------------------------|---------|---------|
|                |               | measured               | Target* | Δ (±5Ω) | measured               | Target* | Δ (±5Ω) |
| 1900           | 21.1          | 52.8                   | 51.6    | 1.2     | 7.3                    | 9.1     | -1.8    |

## TEST REPORT

### RETURN LOSS

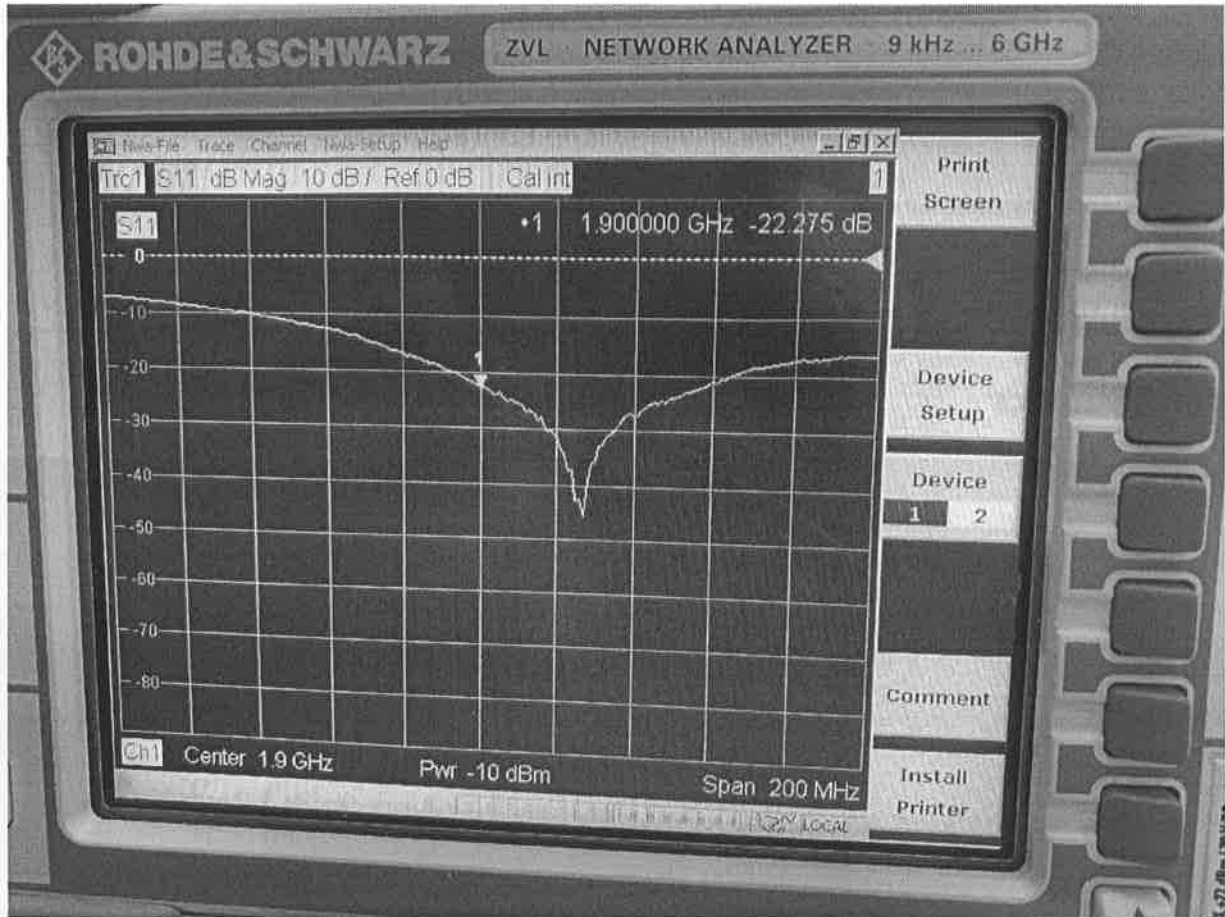

| Freq.<br>(MHz) | Temp.<br>(°C) | Return loss |         |          |
|----------------|---------------|-------------|---------|----------|
|                |               | measured    | Target* | Δ (±20%) |
| 1900           | 21.1          | -22.28      | -20.81  | -7.06%   |

\* the target was quoted from dipole calibration report

## TEST REPORT

## Body Liquid

### DIPOLE IMPEDANCE

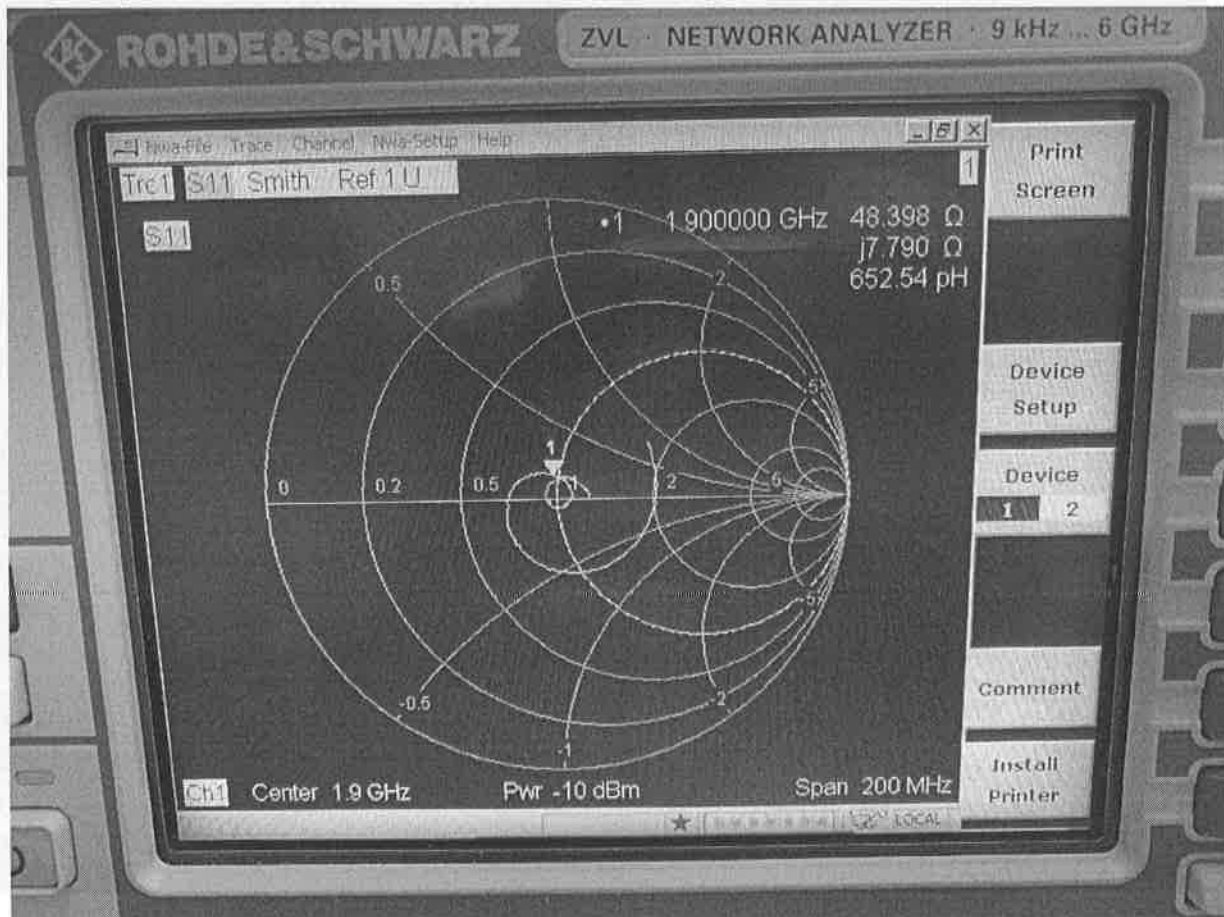

| Freq.<br>(MHz) | Temp.<br>(°C) | Dipole impedance Re{Z} |         |                            | Dipole impedance Im{Z} |         |                            |
|----------------|---------------|------------------------|---------|----------------------------|------------------------|---------|----------------------------|
|                |               | measured               | Target* | $\Delta$ ( $\pm 5\Omega$ ) | measured               | Target* | $\Delta$ ( $\pm 5\Omega$ ) |
| 1900           | 21.1          | 48.4                   | 45.5    | 2.9                        | 7.8                    | 8.3     | -0.5                       |

## RETURN LOSS

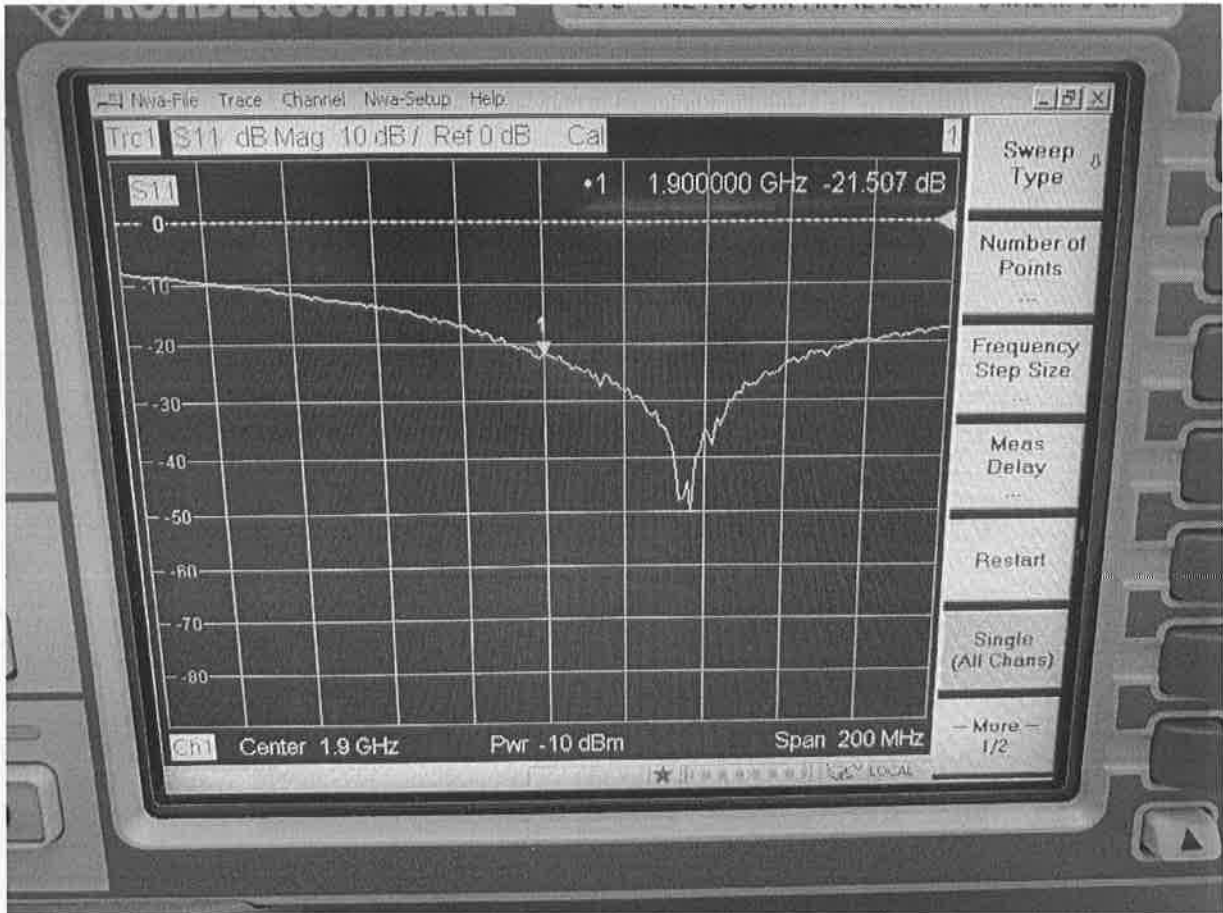

| Freq.<br>(MHz) | Temp.<br>(°C) | Return loss |         |          |
|----------------|---------------|-------------|---------|----------|
|                |               | measured    | Target* | Δ (±20%) |
| 1900           | 21.1          | -21.51      | -20.13  | -6.86%   |

\* the target was quoted from dipole calibration report

## 4. SAR MEASUREMENT SYSTEM VERIFICATION

Routine record keeping procedures should be established for tracking the calibration and performance of SAR measurement system. When SAR measurements are performed, the entire measurement system should be checked daily within the device transmitting frequency ranges to verify system accuracy. A flat phantom irradiated by a half-wavelength dipole is typically used to verify the measurement accuracy of a system. According to KDB 865664, at 300MHz to 6GHz, measurements must be within  $\pm 100\text{MHz}$  of the probe calibration point frequency or the valid frequency range supported by the probe calibration, whichever is less. The measured one-gram SAR should be within 10% of the expected target values specified for the specific phantom and RF source used in the system verification measurement.

The system check verifies that the system operates within its specifications. It's performed daily or before every SAR measurement. The system check uses normal SAR measurement in the flat section of the phantom with a matched dipole at a specified distance. The system check setup is shown as below.

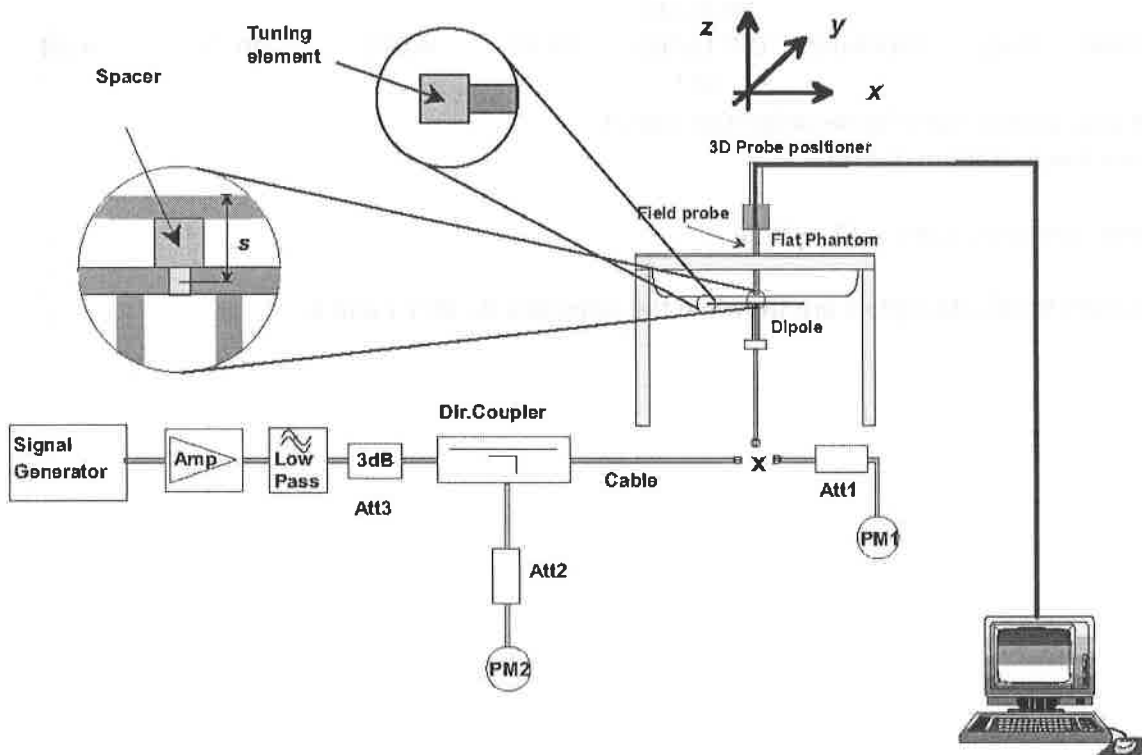

## SYSTEM CHECK RESULTS

| Date   | Freq.<br>(MHz) | Liquid<br>Type | System<br>Diople | System Verification           |                                       |   |   |                     |
|--------|----------------|----------------|------------------|-------------------------------|---------------------------------------|---|---|---------------------|
|        |                |                |                  | Serial No.                    | Target<br>SAR <sub>1g</sub><br>(W/kg) | Measured<br>SAR <sub>1g</sub><br>(W/kg) | Normalized<br>SAR <sub>1g</sub><br>(W/kg) | Deviation<br>(±10%) |
| Jan 02 | 1900           | Head           | 1900MHz          | SN 15/16<br>DIP 1G900-<br>402 | 39.61                                 | 3.885                                   | 38.85                                     | -1.92               |

\* the target was quoted from dipole calibration report

\* Input power level = 20dBm (0.1W)

| Date   | Freq.<br>(MHz) | Liquid<br>Type | System<br>Diople | System Verification           |                                       |   |   |                     |
|--------|----------------|----------------|------------------|-------------------------------|---------------------------------------|---|---|---------------------|
|        |                |                |                  | Serial No.                    | Target<br>SAR <sub>1g</sub><br>(W/kg) | Measured<br>SAR <sub>1g</sub><br>(W/kg) | Normalized<br>SAR <sub>1g</sub><br>(W/kg) | Deviation<br>(±10%) |
| Jan 02 | 1900           | Body           | 1900MHz          | SN 15/16<br>DIP 1G900-<br>402 | 38.82                                 | 4.072                                   | 40.72                                     | 4.89                |

\* the target was quoted from dipole calibration report

\* Input power level = 20dBm (0.1W)

SAR<sub>1g</sub> ambient measured value < 12 mW/kg

Details of System Verification plots are shown in the Appendix A - plot 1 and 2.

## APPENDIX A – SYSTEM CHECK DATA

Plot #1

Operating Frequency : 1900MHz

Test Date: Jan 02 2021

|                                    |   |
|------------------------------------|---|
| Medium (Liquid Type)               | : 1900 Head                                 |
| Relative permittivity $\epsilon_r$ | : 38.06                                     |
| Conductivity $\sigma$ :            | : 1.43                                      |
| Probe                              | : Model: SSE2; Serial No.: SN 36/20 EPGO347 |
| Crest factor                       | : 1.0                                       |
| Conversion Factor                  | : 1.99                                      |
| Area Scan                          | : dx=8mm, dy=8mm                            |
| Zoom Scan                          | : 7x7x7,dx=5mm dy=5mm dz=5mm                |
| Phantom                            | : SAM phantom                               |
| Device Position                    | : Dipole                                    |
| SAR Drift (%)                      | : -0.52%                                    |
| Maximum location                   | : X=0.00, Y=0.00                            |
| SAR Peak (W/kg)                    | : 6.79 W/kg                                 |
| SAR 10g (W/kg)                     | : 1.884 W/kg                                |
| SAR 1g (W/kg)                      | : 3.885 W/kg                                |

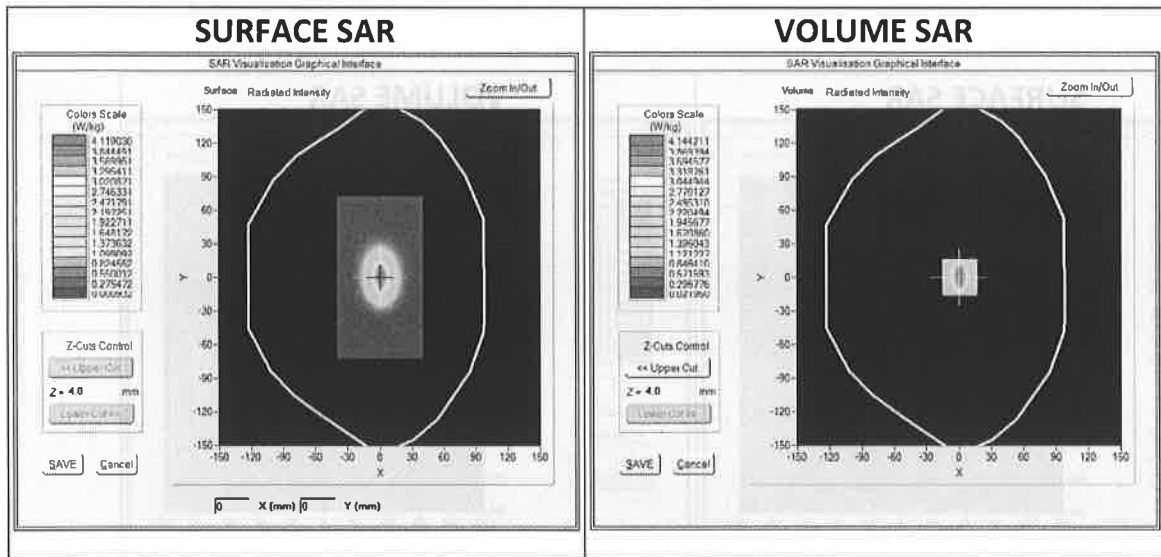

## TEST REPORT

### APPENDIX A – SYSTEM CHECK DATA (CONT'D)

Plot #2

Operating Frequency : 1900MHz

Test Date: Jan 02 2021

|                                    |   |
|------------------------------------|---|
| Medium (Liquid Type)               | : 1900 Body                                 |
| Relative permittivity $\epsilon_r$ | : 54.76                                     |
| Conductivity $\sigma$ :            | : 1.55                                      |
| Probe                              | : Model: SSE2; Serial No.: SN 36/20 EPG0347 |
| Crest factor                       | : 1.0                                       |
| Conversion Factor                  | : 2.08                                      |
| Area Scan                          | : dx=8mm, dy=8mm                            |
| Zoom Scan                          | : 7x7x7, dx=5mm dy=5mm dz=5mm               |
| Phantom                            | : SAM phantom                               |
| Device Position                    | : Dipole                                    |
| SAR Drift (%)                      | : 0.10%                                     |
| Maximum location                   | : X=0.00, Y=0.00                            |
| SAR Peak (W/kg)                    | : 7.15 W/kg                                 |
| SAR 10g (W/kg)                     | : 1.982 W/kg                                |
| SAR 1g (W/kg)                      | : 4.072 W/kg                                |

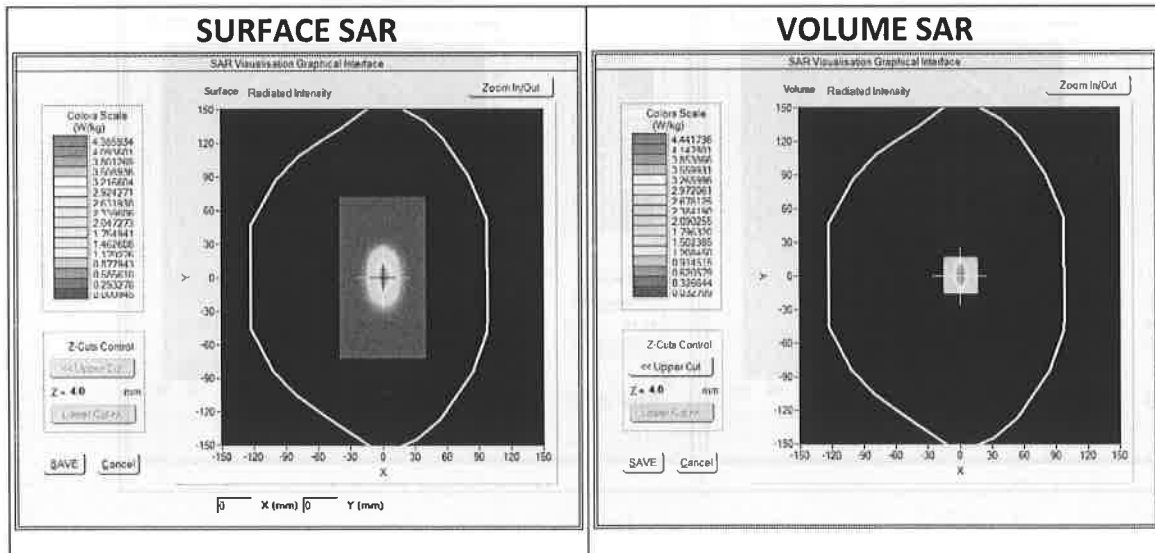





## SAR Reference Dipole Calibration Report

Ref : ACR.98.6.19.SATU.A

### **INTERTEK TESTING SERVICES HONG KONG LIMITED**

**WORKSHOP NO. 3 G/F, WORLD-WIDE INDUSTRIAL  
CENTRE, 43-47 SHAN MEI STREET,  
FO TAN, SHA TIN, N.T. HONG KONG  
MVG COMOSAR REFERENCE DIPOLE**

**FREQUENCY: 1900 MHZ**

**SERIAL NO.: SN 15/16 DIP1G900-402**

**Calibrated at MVG US**

**2105 Barrett Park Dr. - Kennesaw, GA 30144**



**Calibration Date: 04/08/2019**

#### *Summary:*

This document presents the method and results from an accredited SAR reference dipole calibration performed in MVG USA using the COMOSAR test bench. All calibration results are traceable to national metrology institutions.



|                      | <i>Name</i>   | <i>Function</i> | <i>Date</i> | <i>Signature</i>     |
|----------------------|---------------|-----------------|-------------|----------------------|
| <i>Prepared by :</i> | Jérôme LUC    | Product Manager | 4/8/2019    | <i>JS</i>            |
| <i>Checked by :</i>  | Jérôme LUC    | Product Manager | 4/8/2019    | <i>JS</i>            |
| <i>Approved by :</i> | Kim RUTKOWSKI | Quality Manager | 4/8/2019    | <i>Kim Rutkowski</i> |

|                       | <i>Customer Name</i>                        |
|-----------------------|---|
| <i>Distribution :</i> | Intertek Testing Services Hong Kong Limited |

| <i>Issue</i> | <i>Date</i> | <i>Modifications</i> |
|--------------|-------------|----------------------|
| A            | 4/8/2019    | Initial release      |
|              |             |                      |
|              |             |                      |
|              |             |                      |



**TABLE OF CONTENTS**

1 Introduction.....4

2 Device Under Test .....4

3 Product Description .....4

    3.1 General Information .....4

4 Measurement Method .....5

    4.1 Return Loss Requirements .....5

    4.2 Mechanical Requirements.....5

5 Measurement Uncertainty .....5

    5.1 Return Loss .....5

    5.2 Dimension Measurement .....5

    5.3 Validation Measurement.....5

6 Calibration Measurement Results .....6

    6.1 Return Loss and Impedance In Head Liquid .....6

    6.2 Return Loss and Impedance In Body Liquid .....6

    6.3 Mechanical Dimensions .....6

7 Validation measurement .....7

    7.1 Head Liquid Measurement .....7

    7.2 SAR Measurement Result With Head Liquid.....8

    7.3 Body Liquid Measurement .....9

    7.4 SAR Measurement Result With Body Liquid .....10

8 List of Equipment .....11

## 1 INTRODUCTION

This document contains a summary of the requirements set forth by the IEEE 1528, FCC KDBs and CEI/IEC 62209 standards for reference dipoles used for SAR measurement system validations and the measurements that were performed to verify that the product complies with the fore mentioned standards.

## 2 DEVICE UNDER TEST

| Device Under Test              |                                   |
|--------------------------------|-----------------------------------|
| Device Type                    | COMOSAR 1900 MHz REFERENCE DIPOLE |
| Manufacturer                   | MVG                               |
| Model                          | SID1900                           |
| Serial Number                  | SN 15/16 DIP1G900-402             |
| Product Condition (new / used) | Used                              |

A yearly calibration interval is recommended.

## 3 PRODUCT DESCRIPTION

### 3.1 GENERAL INFORMATION

MVG’s COMOSAR Validation Dipoles are built in accordance to the IEEE 1528, FCC KDBs and CEI/IEC 62209 standards. The product is designed for use with the COMOSAR test bench only.



**Figure 1** – MVG COMOSAR Validation Dipole

## 4 MEASUREMENT METHOD

The IEEE 1528, FCC KDBs and CEI/IEC 62209 standards provide requirements for reference dipoles used for system validation measurements. The following measurements were performed to verify that the product complies with the fore mentioned standards.

### 4.1 RETURN LOSS REQUIREMENTS

The dipole used for SAR system validation measurements and checks must have a return loss of -20 dB or better. The return loss measurement shall be performed against a liquid filled flat phantom, with the phantom constructed as outlined in the fore mentioned standards.

### 4.2 MECHANICAL REQUIREMENTS

The IEEE Std. 1528 and CEI/IEC 62209 standards specify the mechanical components and dimensions of the validation dipoles, with the dimensions frequency and phantom shell thickness dependent. The COMOSAR test bench employs a 2 mm phantom shell thickness therefore the dipoles sold for use with the COMOSAR test bench comply with the requirements set forth for a 2 mm phantom shell thickness.

## 5 MEASUREMENT UNCERTAINTY

All uncertainties listed below represent an expanded uncertainty expressed at approximately the 95% confidence level using a coverage factor of k=2, traceable to the Internationally Accepted Guides to Measurement Uncertainty.

### 5.1 RETURN LOSS

The following uncertainties apply to the return loss measurement:

| Frequency band | Expanded Uncertainty on Return Loss |
|----------------|-------------------------------------|
| 400-6000MHz    | 0.1 dB                              |

### 5.2 DIMENSION MEASUREMENT

The following uncertainties apply to the dimension measurements:

| Length (mm) | Expanded Uncertainty on Length |
|-------------|--------------------------------|
| 3 - 300     | 0.05 mm                        |

### 5.3 VALIDATION MEASUREMENT

The guidelines outlined in the IEEE 1528, FCC KDBs, CENELEC EN50361 and CEI/IEC 62209 standards were followed to generate the measurement uncertainty for validation measurements.

| Scan Volume | Expanded Uncertainty |
|-------------|----------------------|
| 1 g         | 20.3 %               |

|      |        |
|------|--------|
| 10 g | 20.1 % |
|------|--------|

## 6 CALIBRATION MEASUREMENT RESULTS

### 6.1 RETURN LOSS AND IMPEDANCE IN HEAD LIQUID

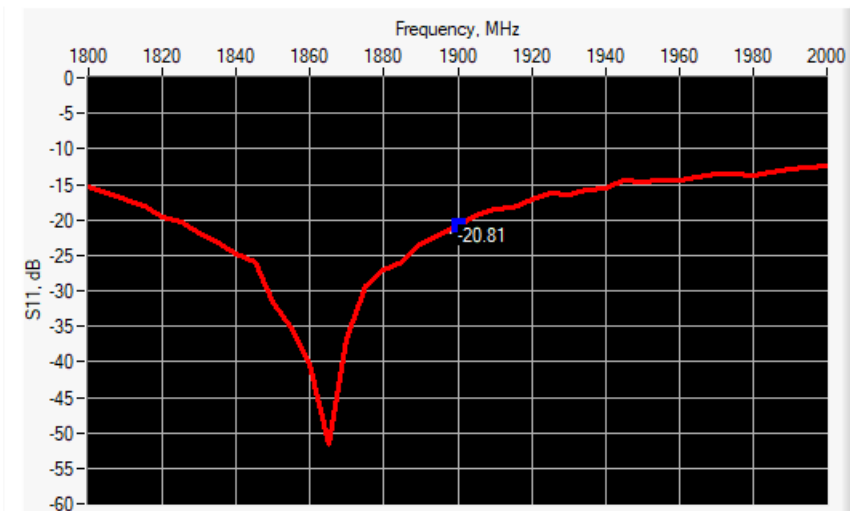

| Frequency (MHz) | Return Loss (dB) | Requirement (dB) | Impedance       |
|-----------------|------------------|------------------|-----------------|
| 1900            | -20.81           | -20              | 51.6 Ω + 9.1 jΩ |

### 6.2 RETURN LOSS AND IMPEDANCE IN BODY LIQUID

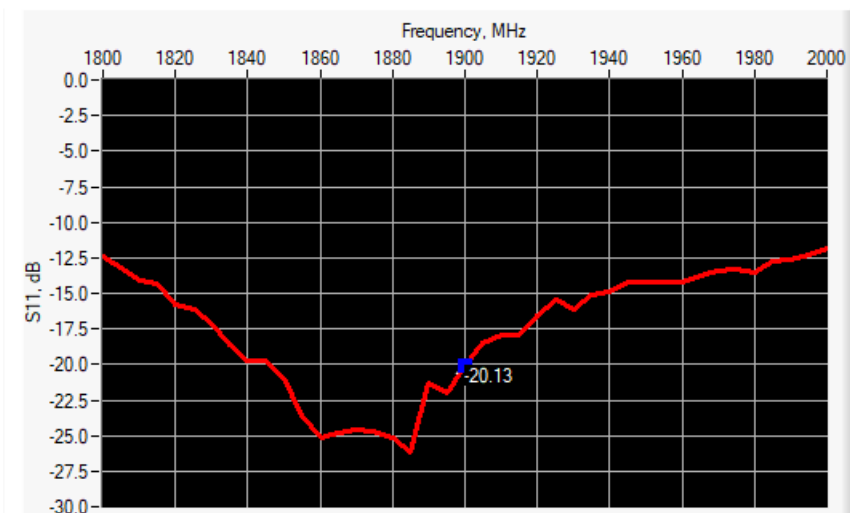

| Frequency (MHz) | Return Loss (dB) | Requirement (dB) | Impedance       |
|-----------------|------------------|------------------|-----------------|
| 1900            | -20.13           | -20              | 45.5 Ω + 8.3 jΩ |

### 6.3 MECHANICAL DIMENSIONS

| Frequency MHz | L mm        |          | h mm        |          | d mm       |          |
|---------------|-------------|----------|-------------|----------|------------|----------|
|               | required    | measured | required    | measured | required   | measured |
| 300           | 420.0 ±1 %. |          | 250.0 ±1 %. |          | 6.35 ±1 %. |          |



|      |             |      |             |      |            |      |
|------|-------------|------|-------------|------|------------|------|
| 450  | 290.0 ±1 %. |      | 166.7 ±1 %. |      | 6.35 ±1 %. |      |
| 750  | 176.0 ±1 %. |      | 100.0 ±1 %. |      | 6.35 ±1 %. |      |
| 835  | 161.0 ±1 %. |      | 89.8 ±1 %.  |      | 3.6 ±1 %.  |      |
| 900  | 149.0 ±1 %. |      | 83.3 ±1 %.  |      | 3.6 ±1 %.  |      |
| 1450 | 89.1 ±1 %.  |      | 51.7 ±1 %.  |      | 3.6 ±1 %.  |      |
| 1500 | 80.5 ±1 %.  |      | 50.0 ±1 %.  |      | 3.6 ±1 %.  |      |
| 1640 | 79.0 ±1 %.  |      | 45.7 ±1 %.  |      | 3.6 ±1 %.  |      |
| 1750 | 75.2 ±1 %.  |      | 42.9 ±1 %.  |      | 3.6 ±1 %.  |      |
| 1800 | 72.0 ±1 %.  |      | 41.7 ±1 %.  |      | 3.6 ±1 %.  |      |
| 1900 | 68.0 ±1 %.  | PASS | 39.5 ±1 %.  | PASS | 3.6 ±1 %.  | PASS |
| 1950 | 66.3 ±1 %.  |      | 38.5 ±1 %.  |      | 3.6 ±1 %.  |      |
| 2000 | 64.5 ±1 %.  |      | 37.5 ±1 %.  |      | 3.6 ±1 %.  |      |
| 2100 | 61.0 ±1 %.  |      | 35.7 ±1 %.  |      | 3.6 ±1 %.  |      |
| 2300 | 55.5 ±1 %.  |      | 32.6 ±1 %.  |      | 3.6 ±1 %.  |      |
| 2450 | 51.5 ±1 %.  |      | 30.4 ±1 %.  |      | 3.6 ±1 %.  |      |
| 2600 | 48.5 ±1 %.  |      | 28.8 ±1 %.  |      | 3.6 ±1 %.  |      |
| 3000 | 41.5 ±1 %.  |      | 25.0 ±1 %.  |      | 3.6 ±1 %.  |      |
| 3500 | 37.0 ±1 %.  |      | 26.4 ±1 %.  |      | 3.6 ±1 %.  |      |
| 3700 | 34.7 ±1 %.  |      | 26.4 ±1 %.  |      | 3.6 ±1 %.  |      |

## 7 VALIDATION MEASUREMENT

The IEEE Std. 1528, FCC KDBs and CEI/IEC 62209 standards state that the system validation measurements must be performed using a reference dipole meeting the fore mentioned return loss and mechanical dimension requirements. The validation measurement must be performed against a liquid filled flat phantom, with the phantom constructed as outlined in the fore mentioned standards. Per the standards, the dipole shall be positioned below the bottom of the phantom, with the dipole length centered and parallel to the longest dimension of the flat phantom, with the top surface of the dipole at the described distance from the bottom surface of the phantom.

### 7.1 HEAD LIQUID MEASUREMENT

| Frequency<br>MHz | Relative permittivity ( $\epsilon_r'$ ) |          | Conductivity ( $\sigma$ ) S/m |          |
|------------------|---|----------|-------------------------------|----------|
|                  | required                                | measured | required                      | measured |
| 300              | 45.3 ±5 %                               |          | 0.87 ±5 %                     |          |
| 450              | 43.5 ±5 %                               |          | 0.87 ±5 %                     |          |
| 750              | 41.9 ±5 %                               |          | 0.89 ±5 %                     |          |
| 835              | 41.5 ±5 %                               |          | 0.90 ±5 %                     |          |
| 900              | 41.5 ±5 %                               |          | 0.97 ±5 %                     |          |
| 1450             | 40.5 ±5 %                               |          | 1.20 ±5 %                     |          |
| 1500             | 40.4 ±5 %                               |          | 1.23 ±5 %                     |          |
| 1640             | 40.2 ±5 %                               |          | 1.31 ±5 %                     |          |
| 1750             | 40.1 ±5 %                               |          | 1.37 ±5 %                     |          |



|      |           |      |           |      |
|------|-----------|------|-----------|------|
| 1800 | 40.0 ±5 % |      | 1.40 ±5 % |      |
| 1900 | 40.0 ±5 % | PASS | 1.40 ±5 % | PASS |
| 1950 | 40.0 ±5 % |      | 1.40 ±5 % |      |
| 2000 | 40.0 ±5 % |      | 1.40 ±5 % |      |
| 2100 | 39.8 ±5 % |      | 1.49 ±5 % |      |
| 2300 | 39.5 ±5 % |      | 1.67 ±5 % |      |
| 2450 | 39.2 ±5 % |      | 1.80 ±5 % |      |
| 2600 | 39.0 ±5 % |      | 1.96 ±5 % |      |
| 3000 | 38.5 ±5 % |      | 2.40 ±5 % |      |
| 3500 | 37.9 ±5 % |      | 2.91 ±5 % |      |

**7.2 SAR MEASUREMENT RESULT WITH HEAD LIQUID**

The IEEE Std. 1528 and CEI/IEC 62209 standards state that the system validation measurements should produce the SAR values shown below (for phantom thickness of 2 mm), within the uncertainty for the system validation. All SAR values are normalized to 1 W forward power. In bracket, the measured SAR is given with the used input power.

|   |  |
|---|--|
| Software                                  | OPENSAR V4                                   |
| Phantom                                   | SN 20/09 SAM71                               |
| Probe                                     | SN 18/11 EPG122                              |
| Liquid                                    | Head Liquid Values: eps' : 38.5 sigma : 1.45 |
| Distance between dipole center and liquid | 10.0 mm                                      |
| Area scan resolution                      | dx=8mm/dy=8mm                                |
| Zoon Scan Resolution                      | dx=8mm/dy=8mm/dz=5mm                         |
| Frequency                                 | 1900 MHz                                     |
| Input power                               | 20 dBm                                       |
| Liquid Temperature                        | 21 °C  |
| Lab Temperature                           | 21 °C  |
| Lab Humidity                              | 45 %   |

| Frequency MHz | 1 g SAR (W/kg/W) |          | 10 g SAR (W/kg/W) |          |
|---------------|------------------|----------|-------------------|----------|
|               | required         | measured | required          | measured |
| 300           | 2.85             |          | 1.94              |          |
| 450           | 4.58             |          | 3.06              |          |
| 750           | 8.49             |          | 5.55              |          |
| 835           | 9.56             |          | 6.22              |          |
| 900           | 10.9             |          | 6.99              |          |
| 1450          | 29               |          | 16                |          |
| 1500          | 30.5             |          | 16.8              |          |
| 1640          | 34.2             |          | 18.4              |          |
| 1750          | 36.4             |          | 19.3              |          |
| 1800          | 38.4             |          | 20.1              |          |



|      |      |              |      |              |
|------|------|--------------|------|--------------|
| 1900 | 39.7 | 39.61 (3.96) | 20.5 | 20.44 (2.04) |
| 1950 | 40.5 |              | 20.9 |              |
| 2000 | 41.1 |              | 21.1 |              |
| 2100 | 43.6 |              | 21.9 |              |
| 2300 | 48.7 |              | 23.3 |              |
| 2450 | 52.4 |              | 24   |              |
| 2600 | 55.3 |              | 24.6 |              |
| 3000 | 63.8 |              | 25.7 |              |
| 3500 | 67.1 |              | 25   |              |
| 3700 | 67.4 |              | 24.2 |              |

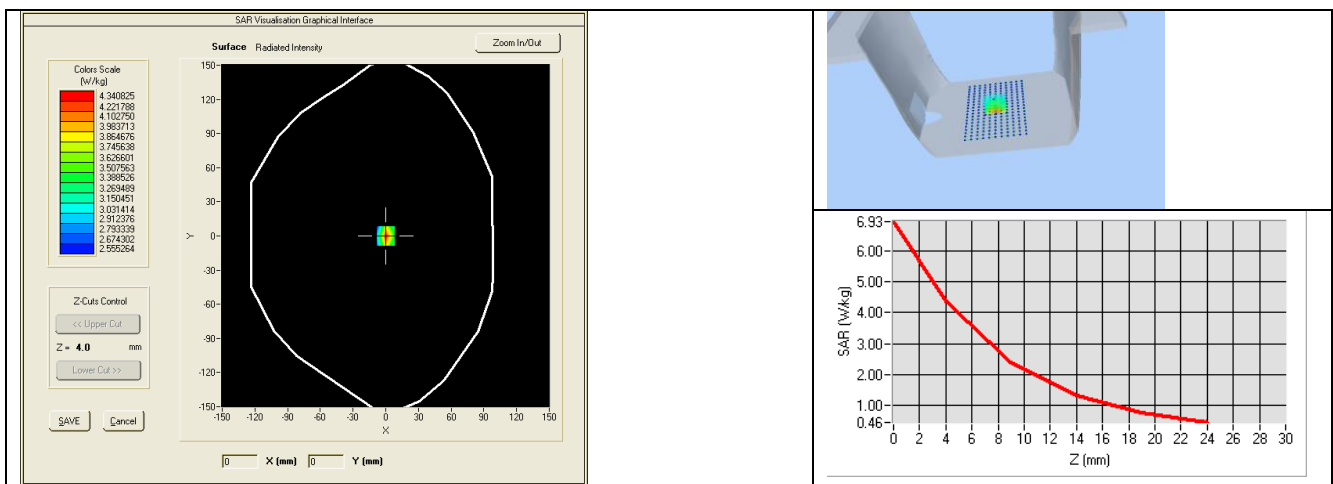

### 7.3 BODY LIQUID MEASUREMENT

| Frequency<br>MHz | Relative permittivity ( $\epsilon_r'$ ) |          | Conductivity ( $\sigma$ ) S/m |          |
|------------------|---|----------|-------------------------------|----------|
|                  | required                                | measured | required                      | measured |
| 150              | 61.9 ± 5 %                              |          | 0.80 ± 5 %                    |          |
| 300              | 58.2 ± 5 %                              |          | 0.92 ± 5 %                    |          |
| 450              | 56.7 ± 5 %                              |          | 0.94 ± 5 %                    |          |
| 750              | 55.5 ± 5 %                              |          | 0.96 ± 5 %                    |          |
| 835              | 55.2 ± 5 %                              |          | 0.97 ± 5 %                    |          |
| 900              | 55.0 ± 5 %                              |          | 1.05 ± 5 %                    |          |
| 915              | 55.0 ± 5 %                              |          | 1.06 ± 5 %                    |          |
| 1450             | 54.0 ± 5 %                              |          | 1.30 ± 5 %                    |          |
| 1610             | 53.8 ± 5 %                              |          | 1.40 ± 5 %                    |          |
| 1800             | 53.3 ± 5 %                              |          | 1.52 ± 5 %                    |          |
| 1900             | 53.3 ± 5 %                              | PASS     | 1.52 ± 5 %                    | PASS     |
| 2000             | 53.3 ± 5 %                              |          | 1.52 ± 5 %                    |          |
| 2100             | 53.2 ± 5 %                              |          | 1.62 ± 5 %                    |          |

|      |            |  |            |  |
|------|------------|--|------------|--|
| 2300 | 52.9 ±5 %  |  | 1.81 ±5 %  |  |
| 2450 | 52.7 ±5 %  |  | 1.95 ±5 %  |  |
| 2600 | 52.5 ±5 %  |  | 2.16 ±5 %  |  |
| 3000 | 52.0 ±5 %  |  | 2.73 ±5 %  |  |
| 3500 | 51.3 ±5 %  |  | 3.31 ±5 %  |  |
| 3700 | 51.0 ±5 %  |  | 3.55 ±5 %  |  |
| 5200 | 49.0 ±10 % |  | 5.30 ±10 % |  |
| 5300 | 48.9 ±10 % |  | 5.42 ±10 % |  |
| 5400 | 48.7 ±10 % |  | 5.53 ±10 % |  |
| 5500 | 48.6 ±10 % |  | 5.65 ±10 % |  |
| 5600 | 48.5 ±10 % |  | 5.77 ±10 % |  |
| 5800 | 48.2 ±10 % |  | 6.00 ±10 % |  |

7.4 SAR MEASUREMENT RESULT WITH BODY LIQUID

|   |  |
|---|--|
| Software                                  | OPENSAR V4                                   |
| Phantom                                   | SN 20/09 SAM71                               |
| Probe                                     | SN 18/11 EPG122                              |
| Liquid                                    | Body Liquid Values: eps' : 53.3 sigma : 1.56 |
| Distance between dipole center and liquid | 10.0 mm                                      |
| Area scan resolution                      | dx=8mm/dy=8mm                                |
| Zoon Scan Resolution                      | dx=8mm/dy=8mm/dz=5mm                         |
| Frequency                                 | 1900 MHz                                     |
| Input power                               | 20 dBm                                       |
| Liquid Temperature                        | 21 °C  |
| Lab Temperature                           | 21 °C  |
| Lab Humidity                              | 45 %   |

| Frequency MHz | 1 g SAR (W/kg/W) | 10 g SAR (W/kg/W) |
|---------------|------------------|-------------------|
|               | measured         | measured          |
| 1900          | 38.82 (3.88)     | 20.32 (2.03)      |

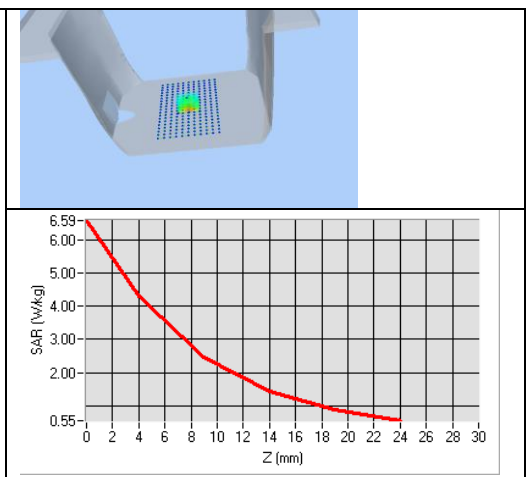
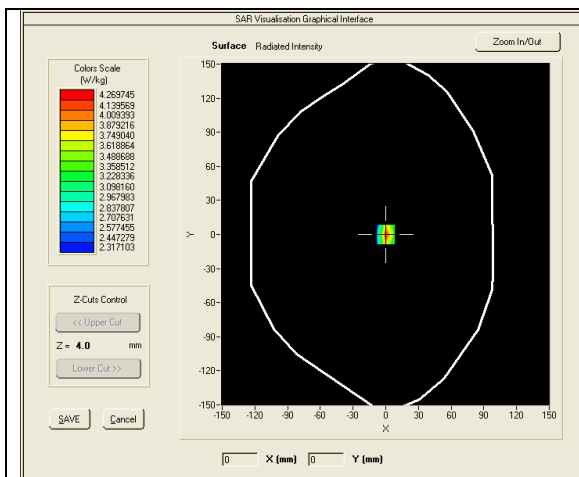



## 8 LIST OF EQUIPMENT

| Equipment Summary Sheet         |                      |                    |   |   |
|---------------------------------|----------------------|--------------------|---|---|
| Equipment Description           | Manufacturer / Model | Identification No. | Current Calibration Date                      | Next Calibration Date                         |
| SAM Phantom                     | MVG                  | SN-20/09-SAM71     | Validated. No cal required.                   | Validated. No cal required.                   |
| COMOSAR Test Bench              | Version 3            | NA                 | Validated. No cal required.                   | Validated. No cal required.                   |
| Network Analyzer                | Rhode & Schwarz ZVA  | SN100132           | 02/2019                                       | 02/2022                                       |
| Calipers                        | Carrera              | CALIPER-01         | 01/2017                                       | 01/2020                                       |
| Reference Probe                 | MVG                  | EPG122 SN 18/11    | 10/2018                                       | 10/2019                                       |
| Multimeter                      | Keithley 2000        | 1188656            | 01/2017                                       | 01/2020                                       |
| Signal Generator                | Agilent E4438C       | MY49070581         | 01/2017                                       | 01/2020                                       |
| Amplifier                       | Aethercomm           | SN 046             | Characterized prior to test. No cal required. | Characterized prior to test. No cal required. |
| Power Meter                     | HP E4418A            | US38261498         | 01/2017                                       | 01/2020                                       |
| Power Sensor                    | HP ECP-E26A          | US37181460         | 01/2017                                       | 01/2020                                       |
| Directional Coupler             | Narda 4216-20        | 01386              | Characterized prior to test. No cal required. | Characterized prior to test. No cal required. |
| Temperature and Humidity Sensor | Control Company      | 150798832          | 11/2017                                       | 11/2020                                       |



## Dielectric Probe Calibration Report

Ref : ACR.181.1.20.MVGB.A

### INTERTEK TESTING SERVICES HONG KONG LIMITED

WORKSHOP NO. 3 G/F, WORLD-WIDE INDUSTRIAL  
CENTRE, 43-47 SHAN MEI STREET,  
FO TAN, SHA TIN, N.T. HONG KONG  
MVG LIMESAR DIELECTRIC PROBE

FREQUENCY: 0.4-6 GHZ

SERIAL NO.: SN 24/16 OCPG76

**Calibrated at MVG**

Z.I. de la pointe du diable

Technopôle Brest Iroise – 295 avenue Alexis de Rochon

29280 PLOUZANE - FRANCE

**Calibration date: 6/29/2020**



Accreditations #2-6789 and #2-6814  
Scope available on [www.cofrac.fr](http://www.cofrac.fr)

#### *Summary:*

This document presents the method and results from an accredited Dielectric Probe calibration performed at MVG, using the LIMESAR test bench. The test results covered by accreditation are traceable to the International System of Units (SI).



|                      | <i>Name</i>  | <i>Function</i>     | <i>Date</i> | <i>Signature</i> |
|----------------------|--------------|---------------------|-------------|------------------|
| <i>Prepared by :</i> | Jérôme LUC   | Technical Manager   | 6/29/2020   |                  |
| <i>Checked by :</i>  | Jérôme LUC   | Technical Manager   | 6/29/2020   |                  |
| <i>Approved by :</i> | Yann Toutain | Laboratory Director | 6/29/2020   |                  |

|                       | <i>Customer Name</i>                        |
|-----------------------|---|
| <i>Distribution :</i> | Intertek Testing Services Hong Kong Limited |

| <i>Issue</i> | <i>Name</i> | <i>Date</i> | <i>Modifications</i> |
|--------------|-------------|-------------|----------------------|
| A            | Jérôme LUC  | 6/29/2020   | Initial release      |
|              |             |             |                      |
|              |             |             |                      |
|              |             |             |                      |

## TABLE OF CONTENTS

|     |   |   |
|-----|---|---|
| 1   | Introduction.....                         | 4 |
| 2   | Device Under Test .....                   | 4 |
| 3   | Product Description .....                 | 4 |
| 3.1 | General Information .....                 | 4 |
| 4   | Measurement Method .....                  | 5 |
| 4.1 | Liquid Permittivity Measurements .....    | 5 |
| 5   | Measurement Uncertainty.....              | 5 |
| 5.1 | Dielectric Permittivity Measurement ..... | 5 |
| 6   | Calibration Measurement Results.....      | 5 |
| 6.1 | Liquid Permittivity Measurement .....     | 6 |
| 7   | List of Equipment .....                   | 7 |

## 1 INTRODUCTION

This document contains a summary of the suggested methods and requirements set forth by the IEEE 1528 and CEI/IEC 62209 standards for liquid permittivity measurements and the measurements that were performed to verify that the product complies with the fore mentioned standards.

## 2 DEVICE UNDER TEST

| Device Under Test              |                          |
|--------------------------------|--------------------------|
| Device Type                    | LIMESAR DIELECTRIC PROBE |
| Manufacturer                   | MVG                      |
| Model                          | SCLMP                    |
| Serial Number                  | SN 24/16 OCPG76          |
| Product Condition (new / used) | Used                     |

## 3 PRODUCT DESCRIPTION

### 3.1 GENERAL INFORMATION

MVG's Dielectric Probes are built in accordance to the IEEE 1528 and CEI/IEC 62209 standards. The product is designed for use with the LIMESAR test bench only.



**Figure 1 – MVG LIMESAR Dielectric Probe**

#### 4 MEASUREMENT METHOD

The IEEE 1528, FCC KDB865664 D01 and CEI/IEC 62209-1 & 2 standards outline techniques for dielectric property measurements. The LIMESAR test bench employs one of the methods outlined in the standards, using a contact probe or open-ended coaxial transmission-line probe and vector network analyzer. The standards recommend the measurement of two reference materials that have well established and stable dielectric properties to validate the system, one for the calibration and one for checking the calibration. The LIMESAR test bench uses De-ionized water as the reference for the calibration and either DMS or Methanol as the reference for checking the calibration. The following measurements were performed to verify that the product complies with the fore mentioned standards.

##### 4.1 LIQUID PERMITTIVITY MEASUREMENTS

The permittivity of a liquid with well established dielectric properties was measured and the measurement results compared to the values provided in the fore mentioned standards.

#### 5 MEASUREMENT UNCERTAINTY

All uncertainties listed below represent an expanded uncertainty expressed at approximately the 95% confidence level using a coverage factor of k=2, traceable to the Internationally Accepted Guides to Measurement Uncertainty.

##### 5.1 DIELECTRIC PERMITTIVITY MEASUREMENT

The following uncertainties apply to the Dielectric Permittivity measurement:

| Uncertainty analysis of Permittivity Measurement      |                          |                          |         |    |                             |
|---|--------------------------|--------------------------|---------|----|-----------------------------|
| ERROR SOURCES   | Uncertainty value (+/-%) | Probability Distribution | Divisor | ci | Standard Uncertainty (+/-%) |
| Expanded uncertainty (confidence level of 95%, k = 2) |                          |                          |         |    | 10 %                        |

| Uncertainty analysis of Conductivity Measurement      |                          |                          |         |    |                             |
|---|--------------------------|--------------------------|---------|----|-----------------------------|
| ERROR SOURCES   | Uncertainty value (+/-%) | Probability Distribution | Divisor | ci | Standard Uncertainty (+/-%) |
| Expanded uncertainty (confidence level of 95%, k = 2) |                          |                          |         |    | 8.2%                        |

#### 6 CALIBRATION MEASUREMENT RESULTS

##### Measurement Condition

|                    |             |
|--------------------|-------------|
| Software           | LIMESAR     |
| Liquid Temperature | 20 +/- 1 °C |
| Lab Temperature    | 20 +/- 1 °C |
| Lab Humidity       | 30-80 %     |



## 6.1 LIQUID PERMITTIVITY MEASUREMENT

A liquid of known characteristics (methanol or ethanediol) is measured with the probe and the results (complex permittivity  $\epsilon' + j\epsilon''$ ) are compared with the reference values for this liquid.

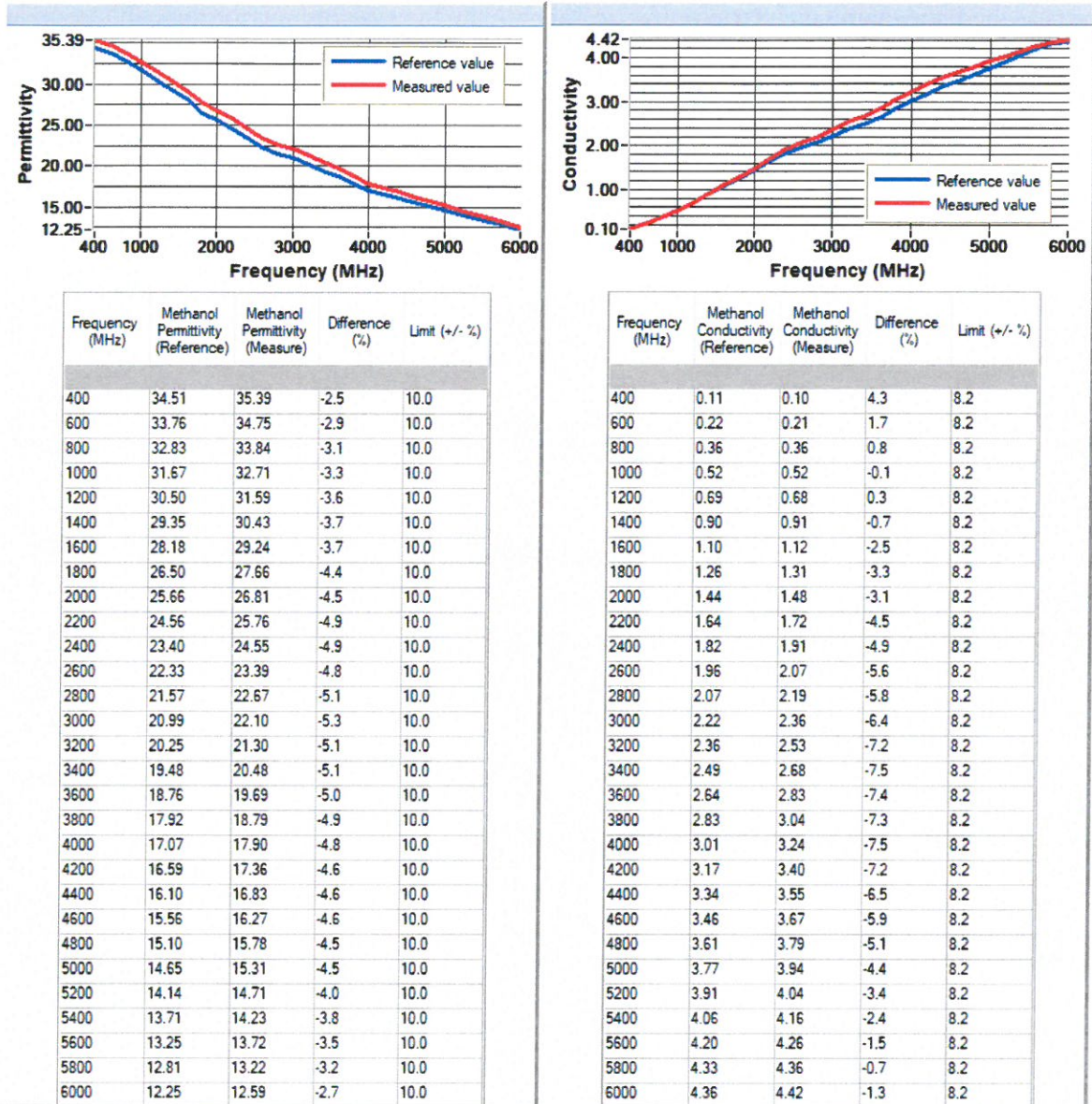



7 LIST OF EQUIPMENT

| Equipment Summary Sheet            |                         |                    |                             |                             |
|------------------------------------|-------------------------|--------------------|-----------------------------|-----------------------------|
| Equipment Description              | Manufacturer / Model    | Identification No. | Current Calibration Date    | Next Calibration Date       |
| LIMESAR Test Bench                 | Version 3               | NA                 | Validated. No cal required. | Validated. No cal required. |
| Network Analyzer                   | Rohde & Schwarz ZVM     | 100203             | 05/2019                     | 05/2022                     |
| Network Analyzer – Calibration kit | Rohde & Schwarz ZV-Z235 | 101223             | 05/2019                     | 05/2022                     |
| Methanol CAS 67-56-1               | Alpha Aesar             | Lot D13W011        | Validated. No cal required. | Validated. No cal required. |
| Temperature and Humidity Sensor    | Control Company         | 150798832          | 11/2017                     | 11/2020                     |



## COMOSAR E-Field Probe Calibration Report

Ref : ACR.317.1.20.MVGB.A

### INTERTEK TESTING SERVICES HONG KONG LIMITED

WORKSHOP NO. 3 G/F, WORLD-WIDE INDUSTRIAL  
CENTRE, 43-47 SHAN MEI STREET,  
FO TAN, SHA TIN, N.T. HONG KONG  
MVG COMOSAR DOSIMETRIC E-FIELD PROBE  
SERIAL NO.: SN 36/20 EPGO347

Calibrated at MVG

Z.I. de la pointe du diable

Technopôle Brest Iroise – 295 avenue Alexis de Rochon

29280 PLOUZANE - FRANCE

Calibration date: 11/12/2020



Accreditations #2-6789 and #2-6814  
Scope available on [www.cofrac.fr](http://www.cofrac.fr)

#### *Summary:*

This document presents the method and results from an accredited COMOSAR E-Field Probe calibration performed at MVG, using the CALIPROBE test bench, for use with a MVG COMOSAR system only. The test results covered by accreditation are traceable to the International System of Units (SI).



|                      | <i>Name</i>  | <i>Function</i>     | <i>Date</i> | <i>Signature</i> |
|----------------------|--------------|---------------------|-------------|------------------|
| <i>Prepared by :</i> | Jérôme LUC   | Technical Manager   | 11/12/2020  | <i>JLS</i>       |
| <i>Checked by :</i>  | Jérôme LUC   | Technical Manager   | 11/12/2020  | <i>JLS</i>       |
| <i>Approved by :</i> | Yann Toutain | Laboratory Director | 11/16/2020  |                  |

|                       | <i>Customer Name</i>                        |
|-----------------------|---|
| <i>Distribution :</i> | Intertek Testing Services Hong Kong Limited |

| <i>Issue</i> | <i>Name</i> | <i>Date</i> | <i>Modifications</i> |
|--------------|-------------|-------------|----------------------|
| A            | Jérôme LUC  | 11/12/2020  | Initial release      |
|              |             |             |                      |
|              |             |             |                      |



**TABLE OF CONTENTS**

1 Device Under Test ..... 4

2 Product Description ..... 4

    2.1 General Information ..... 4

3 Measurement Method ..... 4

    3.1 Linearity ..... 4

    3.2 Sensitivity ..... 5

    3.3 Lower Detection Limit ..... 5

    3.4 Isotropy ..... 5

    3.1 Boundary Effect ..... 5

4 Measurement Uncertainty ..... 6

5 Calibration Measurement Results ..... 6

    5.1 Sensitivity in air ..... 6

    5.2 Linearity ..... 7

    5.3 Sensitivity in liquid ..... 8

    5.4 Isotropy ..... 9

6 List of Equipment ..... 10

## 1 DEVICE UNDER TEST

| Device Under Test                        |   |
|--|---|
| Device Type                              | COMOSAR DOSIMETRIC E FIELD PROBE  |
| Manufacturer                             | MVG   |
| Model                                    | SSE2  |
| Serial Number                            | SN 36/20 EPGO347  |
| Product Condition (new / used)           | New   |
| Frequency Range of Probe                 | 0.15 GHz-6GHz   |
| Resistance of Three Dipoles at Connector | Dipole 1: R1=0.228 MΩ<br>Dipole 2: R2=0.232 MΩ<br>Dipole 3: R3=0.213 MΩ |

## 2 PRODUCT DESCRIPTION

### 2.1 GENERAL INFORMATION

MVG’s COMOSAR E field Probes are built in accordance to the IEEE 1528, FCC KDB865664 D01, CENELEC EN62209 and CEI/IEC 62209 standards.



**Figure 1 – MVG COMOSAR Dosimetric E field Dipole**

|  |        |
|--|--------|
| Probe Length                               | 330 mm |
| Length of Individual Dipoles               | 2 mm   |
| Maximum external diameter                  | 8 mm   |
| Probe Tip External Diameter                | 2.5 mm |
| Distance between dipoles / probe extremity | 1 mm   |

## 3 MEASUREMENT METHOD

The IEEE 1528, FCC KDB865664 D01, CENELEC EN62209 and CEI/IEC 62209 standards provide recommended practices for the probe calibrations, including the performance characteristics of interest and methods by which to assess their affect. All calibrations / measurements performed meet the fore mentioned standards.

### 3.1 LINEARITY

The evaluation of the linearity was done in free space using the waveguide, performing a power sweep to cover the SAR range 0.01W/kg to 100W/kg.

### 3.2 SENSITIVITY

The sensitivity factors of the three dipoles were determined using a two step calibration method (air and tissue simulating liquid) using waveguides as outlined in the standards.

### 3.3 LOWER DETECTION LIMIT

The lower detection limit was assessed using the same measurement set up as used for the linearity measurement. The required lower detection limit is 10 mW/kg.

### 3.4 ISOTROPY

The axial isotropy was evaluated by exposing the probe to a reference wave from a standard dipole with the dipole mounted under the flat phantom in the test configuration suggested for system validations and checks. The probe was rotated along its main axis from 0 to 360 degrees in 15-degree steps. The hemispherical isotropy is determined by inserting the probe in a thin plastic box filled with tissue-equivalent liquid, with the plastic box illuminated with the fields from a half wave dipole. The dipole is rotated about its axis (0°–180°) in 15° increments. At each step the probe is rotated about its axis (0°–360°).

### 3.1 BOUNDARY EFFECT

The boundary effect is defined as the deviation between the SAR measured data and the expected exponential decay in the liquid when the probe is oriented normal to the interface. To evaluate this effect, the liquid filled flat phantom is exposed to fields from either a reference dipole or waveguide. With the probe normal to the phantom surface, the peak spatial average SAR is measured and compared to the analytical value at the surface.

The boundary effect uncertainty can be estimated according to the following uncertainty approximation formula based on linear and exponential extrapolations between the surface and  $d_{be} + d_{step}$  along lines that are approximately normal to the surface:

$$SAR_{uncertainty} [\%] = \Delta SAR_{be} \frac{(d_{be} + d_{step})^2}{2d_{step}} \frac{(e^{-d_{be}/\delta})}{\delta/2} \quad \text{for } (d_{be} + d_{step}) < 10 \text{ mm}$$

where

- $SAR_{uncertainty}$  is the uncertainty in percent of the probe boundary effect
- $d_{be}$  is the distance between the surface and the closest *zoom-scan* measurement point, in millimetre
- $\Delta_{step}$  is the separation distance between the first and second measurement points that are closest to the phantom surface, in millimetre, assuming the boundary effect at the second location is negligible
- $\delta$  is the minimum penetration depth in millimetres of the head tissue-equivalent liquids defined in this standard, i.e.,  $\delta \approx 14$  mm at 3 GHz;
- $\Delta SAR_{be}$  in percent of SAR is the deviation between the measured SAR value, at the distance  $d_{be}$  from the boundary, and the analytical SAR value.

The measured worst case boundary effect SARuncertainty[%] for scanning distances larger than 4mm is 1.0% Limit ,2%).

#### 4 MEASUREMENT UNCERTAINTY

The guidelines outlined in the IEEE 1528, OET 65 Bulletin C, CENELEC EN50361 and CEI/IEC 62209 standards were followed to generate the measurement uncertainty associated with an E-field probe calibration using the waveguide technique. All uncertainties listed below represent an expanded uncertainty expressed at approximately the 95% confidence level using a coverage factor of k=2, traceable to the Internationally Accepted Guides to Measurement Uncertainty.

| Uncertainty analysis of the probe calibration in waveguide |                       |                          |         |    |                          |
|--|-----------------------|--------------------------|---------|----|--------------------------|
| ERROR SOURCES  | Uncertainty value (%) | Probability Distribution | Divisor | ci | Standard Uncertainty (%) |
| Expanded uncertainty<br>95 % confidence level k = 2        |                       |                          |         |    | 14 %                     |

#### 5 CALIBRATION MEASUREMENT RESULTS

| Calibration Parameters |             |
|------------------------|-------------|
| Liquid Temperature     | 20 +/- 1 °C |
| Lab Temperature        | 20 +/- 1 °C |
| Lab Humidity           | 30-80 %     |

##### 5.1 SENSITIVITY IN AIR

| Normx dipole<br>1 (µV/(V/m) <sup>2</sup> ) | Normy dipole<br>2 (µV/(V/m) <sup>2</sup> ) | Normz dipole<br>3 (µV/(V/m) <sup>2</sup> ) |
|--|--|--|
| 0.80                                       | 0.60                                       | 0.79                                       |

| DCP dipole 1<br>(mV) | DCP dipole 2<br>(mV) | DCP dipole 3<br>(mV) |
|----------------------|----------------------|----------------------|
| 110                  | 109                  | 108                  |

Calibration curves  $e_i=f(V)$  (i=1,2,3) allow to obtain E-field value using the formula:

$$E = \sqrt{E_1^2 + E_2^2 + E_3^2}$$



### Calibration curves

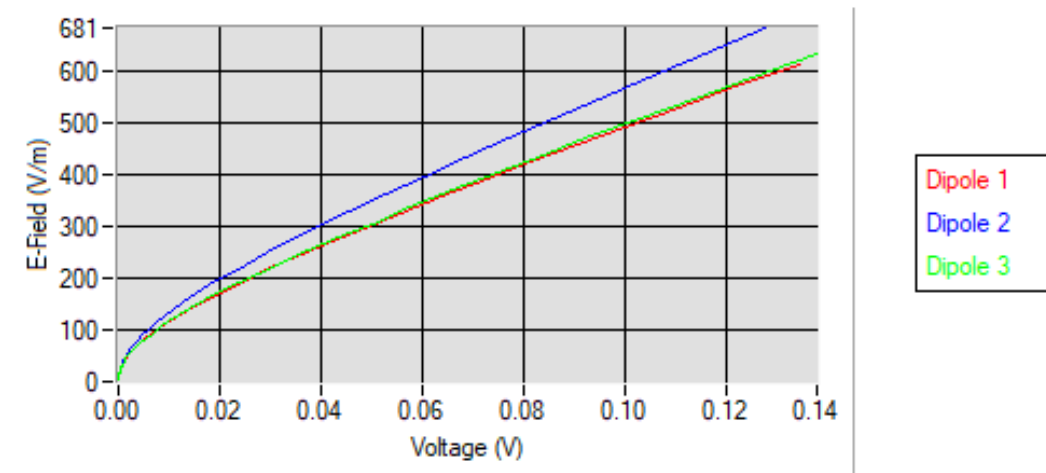

### 5.2 LINEARITY

#### Linearity

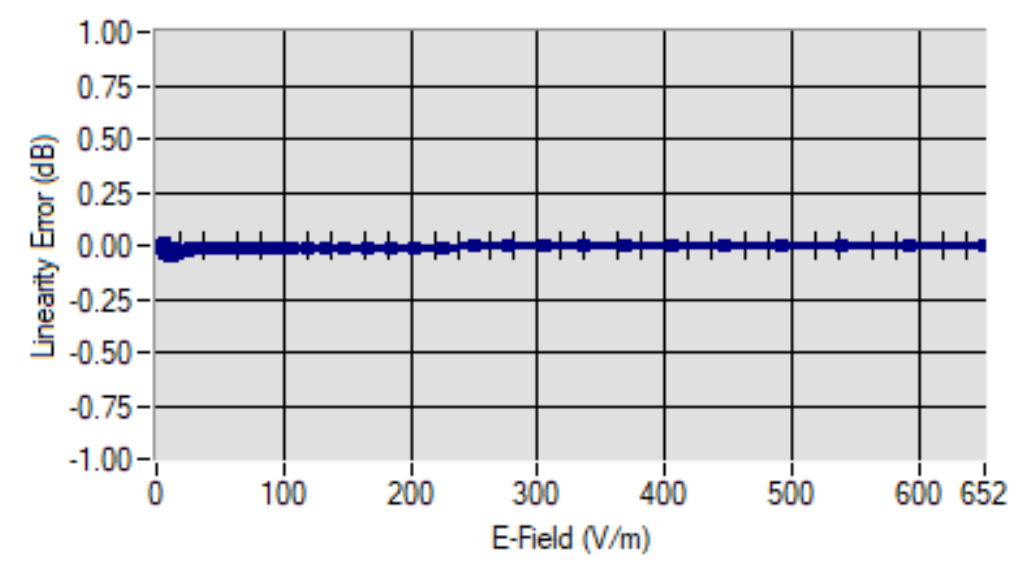

**Linearity: +/-1.17% (+/-0.05dB)**



5.3 SENSITIVITY IN LIQUID

| <u>Liquid</u> | <u>Frequency<br/>(MHz +/-<br/>100MHz)</u> | <u>ConvF</u> |
|---------------|---|--------------|
| HL450*        | 450                                       | 1.77         |
| BL450*        | 450                                       | 1.74         |
| HL750         | 750                                       | 1.67         |
| BL750         | 750                                       | 1.82         |
| HL850         | 835                                       | 1.65         |
| BL850         | 835                                       | 1.78         |
| HL900         | 900                                       | 1.75         |
| BL900         | 900                                       | 1.81         |
| HL1800        | 1800                                      | 1.43         |
| BL1800        | 1800                                      | 1.88         |
| HL1900        | 1900                                      | 1.99         |
| BL1900        | 1900                                      | 2.08         |
| HL2000        | 2000                                      | 2.12         |
| BL2000        | 2000                                      | 2.21         |
| HL2300        | 2300                                      | 2.01         |
| BL2300        | 2300                                      | 2.25         |
| HL2450        | 2450                                      | 2.04         |
| BL2450        | 2450                                      | 2.29         |
| HL2600        | 2600                                      | 2.07         |
| BL2600        | 2600                                      | 2.20         |
| HL5200        | 5200                                      | 1.65         |
| BL5200        | 5200                                      | 1.50         |
| HL5400        | 5400                                      | 1.79         |
| BL5400        | 5400                                      | 1.69         |
| HL5600        | 5600                                      | 2.11         |
| BL5600        | 5600                                      | 1.91         |
| HL5800        | 5800                                      | 1.99         |
| BL5800        | 5800                                      | 1.81         |

\* Frequency not covered by COFRAC scope, calibration not accredited

LOWER DETECTION LIMIT: 8mW/kg

## 5.4 ISOTROPY

### HL1800 MHz

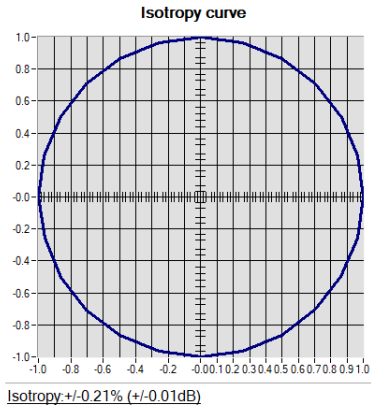



6 LIST OF EQUIPMENT

| Equipment Summary Sheet            |                         |                    |   |   |
|------------------------------------|-------------------------|--------------------|---|---|
| Equipment Description              | Manufacturer / Model    | Identification No. | Current Calibration Date                      | Next Calibration Date                         |
| Flat Phantom                       | MVG                     | SN-20/09-SAM71     | Validated. No cal required.                   | Validated. No cal required.                   |
| COMOSAR Test Bench                 | Version 3               | NA                 | Validated. No cal required.                   | Validated. No cal required.                   |
| Network Analyzer                   | Rohde & Schwarz ZVM     | 100203             | 05/2019                                       | 05/2022                                       |
| Network Analyzer – Calibration kit | Rohde & Schwarz ZV-Z235 | 101223             | 05/2019                                       | 05/2022                                       |
| Multimeter                         | Keithley 2000           | 1160271            | 02/2020                                       | 02/2023                                       |
| Signal Generator                   | Rohde & Schwarz SMB     | 106589             | 04/2019                                       | 04/2022                                       |
| Amplifier                          | Aethercomm              | SN 046             | Characterized prior to test. No cal required. | Characterized prior to test. No cal required. |
| Power Meter                        | NI-USB 5680             | 170100013          | 05/2019                                       | 05/2022                                       |
| Directional Coupler                | Narda 4216-20           | 01386              | Characterized prior to test. No cal required. | Characterized prior to test. No cal required. |
| Waveguide                          | Mega Industries         | 069Y7-158-13-712   | Validated. No cal required.                   | Validated. No cal required.                   |
| Waveguide Transition               | Mega Industries         | 069Y7-158-13-701   | Validated. No cal required.                   | Validated. No cal required.                   |
| Waveguide Termination              | Mega Industries         | 069Y7-158-13-701   | Validated. No cal required.                   | Validated. No cal required.                   |
| Temperature / Humidity Sensor      | Testo 184 H1            | 44220687           | 05/2020                                       | 05/2023                                       |

**TEST REPORT**

**APPENDIX D – SAR SYSTEM VALIDATION**

Per KDB 865664, SAR system validation status should be documented to confirm measurement accuracy. SAR measurement systems are validated according to procedures in KDB 865664. The validation status is documented according to the validation date(s), measurement frequencies, SAR probe and tissue dielectric parameters. When multiple SAR system is used, the validation status of each SAR system is needed to be documented separately according to the associated system components.

A tabulated summary of the system validation status including the validation date(s), measurement frequencies, SAR probe and tissue dielectric parameters are shown as below.

| Date       | Probe S/N | Tested Freq. (MHz) | Tissue Type | Perm  | Cond | CW Validation |                 |                | Mod. Validation |             |                             |
|------------|-----------|--------------------|-------------|-------|------|---------------|-----------------|----------------|-----------------|-------------|-----------------------------|
|            |           |                    |             |       |      | Sensitivity   | Probe Linearity | Probe Isotropy | Mod. Type       | Duty Factor | Peak to average power ratio |
| 15/01/2021 | EPGO 347  | 1900               | Head        | 40.93 | 1.43 | PASS          | PASS            | PASS           | GFSK            | PASS        | PASS                        |
| 15/01/2021 | EPGO 347  | 1900               | Body        | 53.76 | 1.48 | PASS          | PASS            | PASS           | GFSK            | PASS        | PASS                        |