

# TEST REPORT

Applicant Name: VTech Telecommunications Ltd  
Address: 23/F Tai Ping Ind Center Block 1 57 Ting Kok Rd Tai Po NT, Hong Kong  
Report Number: SZ1240220-08465E-RF-00A  
FCC ID: EW780-2142-00

## Test Standard (s)

FCC PART 15D

## Sample Description

Product Type: DECT 6.0 cordless phone  
Model No.: BL102-2  
Multiple Model(s) No.: BL102, BL102-3, BL102-4, BL102-5, BL102-XY  
Trade Mark: AT&T  
Date Received: 2024/03/12  
Issue Date: 2024/04/23

Test Result:	Pass▲
--------------	-------

▲ In the configuration tested, the EUT complied with the standards above.

## Prepared and Checked By:

*April Zhang*

April Zhang  
RF Engineer

## Approved By:

*Jimmy Xiao*

Jimmy Xiao  
RF Supervisor

Note: The information marked # is provided by the applicant, the laboratory is not responsible for its authenticity and this information can affect the validity of the result in the test report. Customer model name, addresses, names, trademarks etc. are included.

This report cannot be reproduced except in full, without prior written approval of the Company. Unless otherwise stated the results shown in this test report refer only to the sample(s) tested. This report is valid only with a valid digital signature. The digital signature may be available only under the Adobe software above version 7.0.

This report must not be used by the customer to claim product certification, approval, or endorsement by NVLAP or any agency of the U.S. Government.

This report may contain data that are not covered by the NVLAP accreditation and are marked with an asterisk "▼".

## Bay Area Compliance Laboratories Corp. (Shenzhen)

5F(B-West), 6F, 7F, the 3rd Phase of Wan Li Industrial Building D, Shihua Rd, FuTian Free Trade Zone, Shenzhen, China

Tel: +86-755-33320018 Fax: +86-755-33320008 www.baclcorp.com.cn

## TABLE OF CONTENTS

<b>DOCUMENT REVISION HISTORY .....</b>	<b>4</b>
<b>GENERAL INFORMATION.....</b>	<b>5</b>
PRODUCT DESCRIPTION FOR EQUIPMENT UNDER TEST (EUT).....	5
OBJECTIVE .....	5
TEST METHODOLOGY .....	6
MEASUREMENT UNCERTAINTY.....	7
TEST FACILITY .....	7
<b>SYSTEM TEST CONFIGURATION.....</b>	<b>8</b>
DESCRIPTION OF TEST CONFIGURATION .....	8
EQUIPMENT MODIFICATIONS .....	8
LOCAL SUPPORT EQUIPMENT LIST AND DETAILS .....	8
EXTERNAL I/O CABLE.....	8
BLOCK DIAGRAM OF TEST SETUP .....	8
<b>SUMMARY OF TEST RESULTS .....</b>	<b>10</b>
<b>TEST EQUIPMENT LIST .....</b>	<b>11</b>
<b>FCC §1.1307(B) &amp; §2.1091 – RF EXPOSURE EVALUATION.....</b>	<b>13</b>
APPLICABLE STANDARD .....	13
RESULT .....	14
<b>§ 15.317, § 15.203 ANTENNA REQUIREMENT .....</b>	<b>15</b>
APPLICABLE STANDARD .....	15
ANTENNA CONNECTOR CONSTRUCTION .....	15
<b>FCC§15.315 &amp; §15.207 - CONDUCTED EMISSIONS.....</b>	<b>16</b>
APPLICABLE STANDARD .....	16
EUT SETUP .....	16
EMI TEST RECEIVER SETUP.....	16
TEST PROCEDURE .....	17
FACTOR & OVER LIMIT CALCULATION.....	17
TEST RESULTS SUMMARY .....	17
TEST DATA .....	17
<b>FCC §15.205, §15.209 &amp; §15.319 (G) - RADIATED EMISSIONS.....</b>	<b>32</b>
APPLICABLE STANDARD .....	32
EUT SETUP .....	32
EMI TEST RECEIVER & SPECTRUM ANALYZER SETUP .....	33
TEST PROCEDURE .....	33
FACTOR & OVER LIMIT/MARGIN CALCULATION .....	34
TEST DATA .....	34
<b>FCC§15.323 (A) - EMISSION BANDWIDTH.....</b>	<b>58</b>
APPLICABLE STANDARD .....	58
TEST PROCEDURE .....	58
TEST DATA .....	58

**FCC§15.319 (C) - PEAK TRANSMIT POWER.....63**  
 APPLICABLE STANDARD ..... 63  
 TEST PROCEDURE .....63  
 TEST DATA .....64

**FCC§15.319 (D) - POWER SPECTRAL DENSITY .....69**  
 APPLICABLE STANDARD .....69  
 TEST PROCEDURE .....69  
 TEST DATA .....69

**FCC§15.323 (D) - EMISSION INSIDE AND OUTSIDE THE SUB-BAND.....74**  
 APPLICABLE STANDARD .....74  
 TEST PROCEDURE .....74  
 TEST DATA .....74

**FCC§15.323 (F) - FREQUENCY STABILITY.....84**  
 APPLICABLE STANDARD .....84  
 TEST PROCEDURE .....84  
 TEST DATA .....84

**FCC§15.323 (C) (E) & §15.319(F) – SPECIFIC REQUIREMENTS FOR UPCS DEVICE.....86**  
 APPLICABLE STANDARD .....86  
 TEST PROCEDURE .....86  
 TEST DATA .....86  
 1) AUTOMATIC DISCONTINUATION OF TRANSMISSION, FCC §15.319(F) .....87  
 2) MONITORING TIME, FCC §15.323(c) (1) .....87  
 3) LOWER MONITORING THRESHOLD, FCC §15.323(c) (2) .....87  
 4) MAXIMUM TRANSMIT PERIOD, FCC §15.323(c) (3) .....87  
 5) SYSTEM ACKNOWLEDGEMENT, FCC §15.323(c) (4) .....88  
 6) LEAST INTERFERED CHANNEL (LIC), FCC §15.323(c) (5) .....88  
 7) RANDOM WAITING, FCC §15.323(c) (6) .....89  
 8) MONITORING BANDWIDTH AND REACTION TIME, FCC §15.323(c) (7) .....89  
 9) MONITORING ANTENNA, FCC §15.323(c) (8) .....89  
 10) MONITORING THRESHOLD RELAXATION, FCC §15.323(c) (9) .....89  
 11) DUPLEX CONNECTIONS, FCC §15.323(c) (10).....90  
 12) ALTERNATIVE MONITORING INTERVAL, FCC §15.323(c) (11).....90  
 13) FAIR ACCESS, FCC §15.323(c) (12) .....90  
 14) FRAME REPETITION STABILITY FRAME PERIOD AND JITTER, FCC§15.323 (E) .....90

**EUT PHOTOGRAPHS.....91**

**TEST SETUP PHOTOGRAPHS.....92**

## DOCUMENT REVISION HISTORY

Revision Number	Report Number	Description of Revision	Date of Revision
0	SZ1240220-08465E-RF-00A	Original Report	2024/04/23

## GENERAL INFORMATION

### Product Description for Equipment under Test (EUT)

Product	DECT 6.0 cordless phone
Tested Model	BL102-2
Multiple Model(s)	BL102, BL102-3, BL102-4, BL102-5, BL102-XY
Frequency Range	1921.536-1928.448 MHz
Maximum conducted peak output power	20.55dBm
Modulation Technique	GFSK
Antenna Specification <sup>#</sup>	ANT0 :0dBi, ANT1: 1dBi (It is provided by the applicant)
Voltage Range	DC 6V from adapter
Sample serial number	2HSY-1 for AC Line Conducted Emissions and Radiated Emission 2HSY-6 for RF Conducted Test (Assigned by BAACL, Shenzhen)
Sample/EUT Status	Good condition
Adapter Information	<p>Adapter 1 Model: A318-060040W-US1 Input: AC 100-120V, 50-60Hz, 0.15A Output: DC 6.0V, 0.4A</p> <p>Adapter 2 Model: VT05UUS06040 Input: AC 100-120V, 60Hz, 0.15A Output: DC 6.0V, 0.4A</p> <p>Adapter 3 Model: VT04UUS06040 Input: AC 100-120V, 60Hz, 0.15A Output: DC 6.0V, 0.4A</p> <p>Adapter 4 Model: E004-1A060040VU Input: AC 100-120V, 50/60Hz, 0.1A Output: DC 6.0V, 0.4A</p> <p>Adapter 5 Model: DSA-3PFM-05 BUS 060040 Input: AC 100-120V, 50/60Hz, 0.15A Output: DC 6.0V, 0.4A, 2.4W</p> <p>Adapter 6 Model: GQ06-060040-ZU Input: AC 100-120V, 50/60Hz, 0.15A Output: DC 6.0V, 0.4A</p>
<p>Note: The Multiple models are electrically identical with the test model except for Color, Model number, Package type and the number of Handset and Charger. Please refer to the declaration letter<sup>#</sup> for more detail, which was provided by manufacturer.</p>	

### Objective

The tests were performed in order to determine the compliance of the EUT with FCC Part 15-Subpart D, section 15.207, 15.209, 15.315, 15.317, 15.319 and 15.323 rules. The EMI measurements were performed according to the measurement procedure described in ANSI C63.17 – 2013.

## **Test Methodology**

All measurements contained in this report were conducted with ANSI C63.17 - 2013, American National Standard Methods of Measurement of the Electromagnetic and Operational Compatibility of Unlicensed Personal Communications Services (UPCS) Devices.

All emissions measurement was performed at Bay Area Compliance Laboratories Corp. (Shenzhen). The radiated testing was performed at an antenna-to-EUT distance of 3 meters.

Each test item follows test standards and with no deviation.

**Measurement Uncertainty**

Parameter		Uncertainty
Occupied Channel Bandwidth		±5%
RF Frequency		213.55 Hz(k=2, 95% level of confidence)
RF output power, conducted		0.72 dB(k=2, 95% level of confidence)
Unwanted Emission, conducted		1.75 dB(k=2, 95% level of confidence)
AC Power Lines Conducted Emissions	9kHz-150kHz	3.94dB(k=2, 95% level of confidence)
	150kHz-30MHz	3.84dB(k=2, 95% level of confidence)
Radiated Emissions	9kHz - 30MHz	3.30dB(k=2, 95% level of confidence)
	30MHz~200MHz (Horizontal)	4.48dB(k=2, 95% level of confidence)
	30MHz~200MHz (Vertical)	4.55dB(k=2, 95% level of confidence)
	200MHz~1000MHz (Horizontal)	4.85dB(k=2, 95% level of confidence)
	200MHz~1000MHz (Vertical)	5.05dB(k=2, 95% level of confidence)
	1GHz - 6GHz	5.35dB(k=2, 95% level of confidence)
	6GHz - 18GHz	5.44dB(k=2, 95% level of confidence)
Temperature		±1°C
Humidity		±1%
Supply voltages		±0.4%

*Note: The extended uncertainty given in this report is obtained by combining the standard uncertainty times the coverage factor K with the 95% confidence interval. Otherwise required by the applicant or Product Regulations, Decision Rule in this report did not consider the uncertainty.*

**Test Facility**

The Test site used by Bay Area Compliance Laboratories Corp. (Shenzhen) to collect test data is located on the 5F(B-West) , 6F, 7F, the 3rd Phase of Wan Li Industrial Building D, Shihua Rd, FuTian Free Trade Zone, Shenzhen, China.

The lab has been recognized as the FCC accredited lab under the KDB 974614 D01 and is listed in the FCC Public Access Link (PAL) database, FCC Registration No. : 715558, the FCC Designation No. : CN5045.

## SYSTEM TEST CONFIGURATION

### Description of Test Configuration

The system was configured to testing mode which is provided by the manufacturer.

For the AC line conducted emission and Radiated spurious emission below 1GHz, Maximum output power mode: ANT 1: Middle channel was used for test.

### Equipment Modifications

No modification was made to the EUT tested.

### Local Support Equipment List and Details

Manufacturer	Description	Model	Serial Number
Rohde & Schwarz	Digital Radio Communication Tester	CMD60	830553/018

### External I/O Cable

Cable Description	Length (m)	From Port	To
Un-shielding Un-detachable DC Cable	1.0	EUT	Adapter
Un-shielded Detachable AC Cable	1.2	AC Power	CMD60

### Block Diagram of Test Setup

For conducted emission

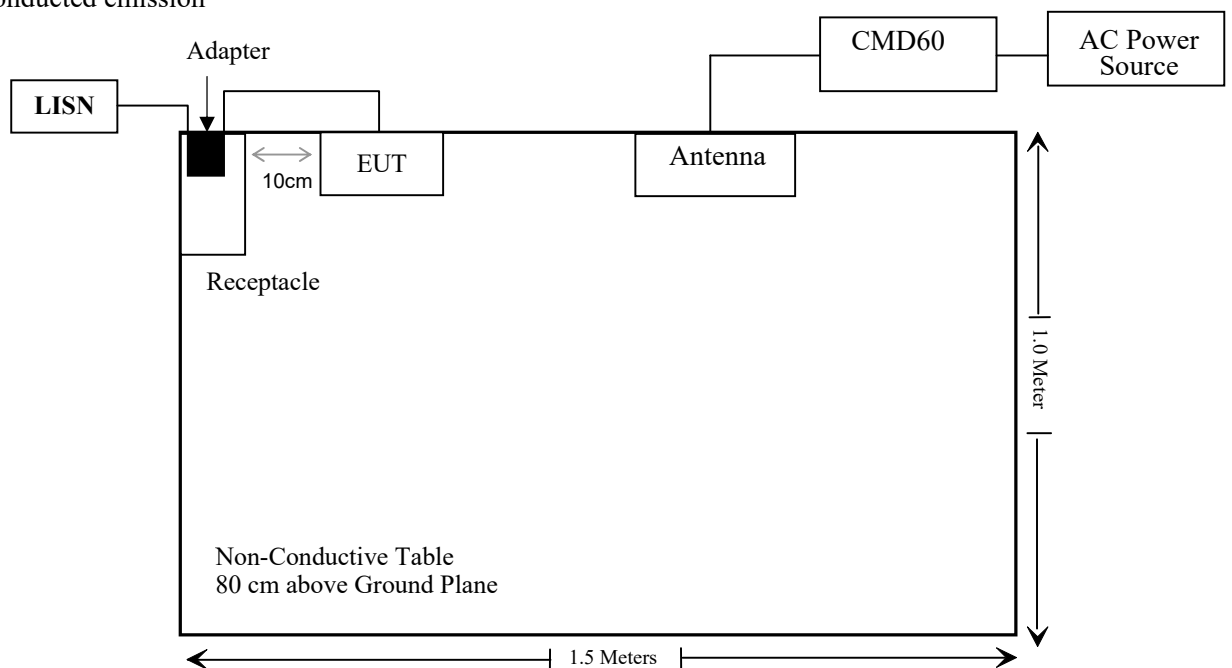



For Radiated Emissions:

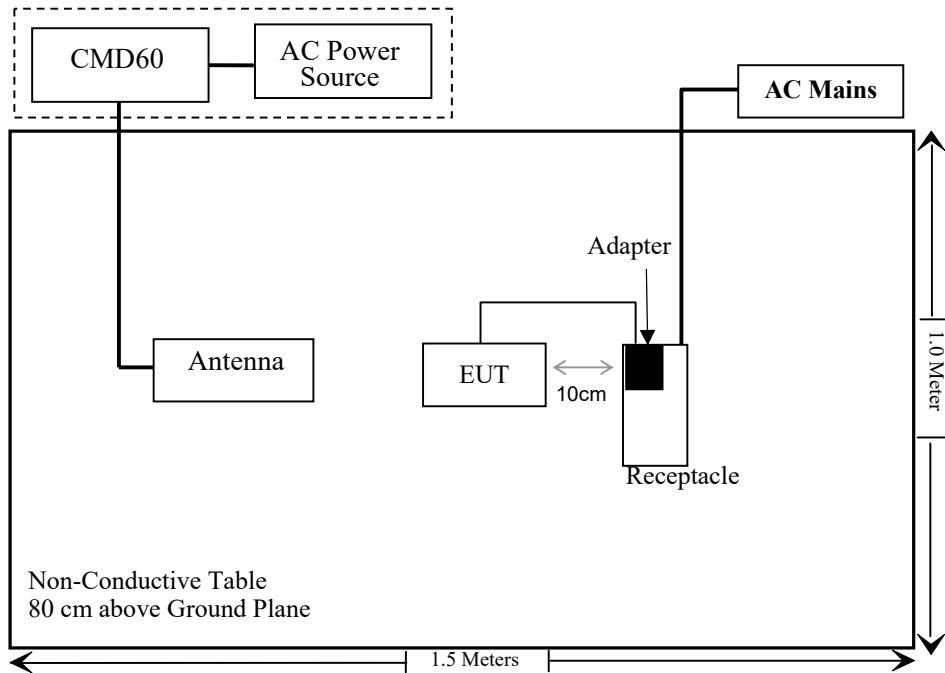

**SUMMARY OF TEST RESULTS**

<b>FCC Rules</b>	<b>Description of Test</b>	<b>Result</b>
§1.1310 & §2.1091	RF Exposure Evaluation	Compliant
§ 15.317, § 15.203	Antenna Requirement	Compliant
§ 15.315, § 15.207	Conducted Emission	Compliant
§15.205, §15.209, § 15.319 (g)	Radiated Emissions	Compliant
§ 15.323 (a)	Emission Bandwidth	Compliant
§ 15.319 (c)	Peak Transmit Power	Compliant
§ 15.319 (d)	Power Spectral Density	Compliant
§ 15.323 (d)	Emission Inside and Outside the sub-band	Compliant
§ 15.323 (f)	Frequency Stability	Compliant
§ 15.323 (c)(e) § 15.319 (f)	Specific Requirements for UPCS	Compliant

Note: the EUT has two antennas, pre-scan the conducted power with them. The larger one is the ANT1 which was chosen for the full test.

**TEST EQUIPMENT LIST**

Manufacturer	Description	Model	Serial Number	Calibration Date	Calibration Due Date
<b>Conducted Emissions Test</b>					
Rohde & Schwarz	EMI Test Receiver	ESCI	101120	2024/01/16	2025/01/15
Rohde & Schwarz	LISN	ENV216	101613	2024/01/16	2025/01/15
Rohde & Schwarz	Transient Limiter	ESH3Z2	DE25985	2023/08/03	2024/08/02
Unknown	CE Cable	CE Cable	UF A210B-1-0720-504504	2023/08/03	2024/08/02
Audix	EMI Test software	E3	191218	NCR	NCR
<b>Radiated Emission Test</b>					
R&S	EMI Test Receiver	ESR3	102455	2024/01/16	2025/01/15
Sonoma instrument	Pre-amplifier	310 N	186238	2023/06/08	2024/06/07
Sunol Sciences	Broadband Antenna	JB1	A040904-1	2023/07/20	2024/07/19
ETS	Passive Loop Antenna	6512	29604	2023/07/07	2024/07/06
Unknown	Cable	Chamber Cable 1	F-03-EM236	2023/08/03	2024/08/02
Unknown	Cable	Chamber Cable 4	EC-007	2023/08/03	2024/08/02
Audix	EMI Test software	E3	19821b(V9)	NCR	NCR
Rohde & Schwarz	Spectrum Analyzer	FSV40	101605	2023/04/18	2024/04/17
COM-POWER	Pre-amplifier	PA-122	181919	2023/06/29	2024/06/28
Schwarzbeck	Horn Antenna	BBHA9120D(1201)	1143	2023/07/26	2024/07/25
A.H.System	Horn Antenna	SAS-200/571	135	2021/07/14	2024/07/13
Unknown	RF Cable	KMSE	0735	2023/10/08	2024/10/07
Unknown	RF Cable	UFA147	219661	2023/10/08	2024/10/07
Unknown	RF Cable	XH750A-N	J-10M	2023/10/08	2024/10/07
Audix	EMI Test software	E3	191218(V9)	NCR	NCR
A.H.System	Pre-amplifier	PAM-1840VH	190	2023/08/03	2024/08/02
Electro-Mechanics Co	Horn Antenna	3116	9510-2270	2023/09/18	2026/09/17
UTIFLEX	RF Cable	NO. 13	232308-001	2023/08/03	2024/08/02
Wainwright Germany	B1(DECT) Pass filter	1920-1980	F-03-EM233	2023/07/04	2024/07/03
MICRO-TRONICS	2.8G Passband filter	HPM50111	F-03-EM217	2023/08/03	2024/08/02

Manufacturer	Description	Model	Serial Number	Calibration Date	Calibration Due Date
<b>RF Conducted Test</b>					
R&S	spectrum analyzer	FSV40	101942	2023/12/18	2024/12/17
BACL	Temperature & Humidity Chamber	BTH-150-40	30145	2024/01/16	2025/01/15
Rohde & Schwarz	Digital Radio Communication Tester	CMD60	830553/018	2023/06/08	2024/06/07
Fluke	Digital Multimeter	287	19000011	2023/06/08	2024/06/07
Keysight	MXG Vector Signal Generator	N5182B	MY53051503	2024/01/08	2025/01/07
Unknown	3dB Attenuator	Unknown	F-03-EM121	2023/07/04	2024/07/03
WEINSCHEL	Power Splitter	1515	RH386	2023/07/04	2024/07/03
HELLVIAO	Contact voltage regulator	TDGC2-5KVA	Unknown	NCR	NCR

\* **Statement of Traceability:** Bay Area Compliance Laboratories Corp. (Shenzhen) attests that all calibrations have been performed in accordance to requirements that traceable to National Primary Standards and International System of Units (SI).

## FCC §1.1307(b) & §2.1091 – RF EXPOSURE EVALUATION

### Applicable Standard

According to KDB 447498 D04 Interim General RF Exposure Guidance v01, clause 2.1.4 –MPE-Based Exemption:

An alternative to the SAR-based exemption is provided in § 1.1307(b)(3)(i)(C), for a much wider frequency range, from 300 kHz to 100 GHz, applicable for separation distances greater or equal to  $\lambda/2\pi$ , where  $\lambda$  is the free-space operating wavelength in meters. The MPE-based test exemption condition is in terms of ERP, defined as the product of the maximum antenna gain and the delivered maximum time-averaged power. For this case, a RF source is an RF exempt device if its ERP (watts) is no more than a frequency-dependent value, as detailed tabular form in Appendix B. These limits have been derived based on the basic specifications on Maximum Permissible Exposure (MPE) considered for the FCC rules in § 1.1310(e)(1).

Table to § 1.1307(b)(3)(i)(C) - Single RF Sources Subject to Routine Environmental Evaluation

RF Source frequency (MHz)	Threshold ERP (watts)
0.3-1.34	$1,920 R^2$ .
1.34-30	$3,450 R^2/f^2$ .
30-300	$3.83 R^2$ .
300-1,500	$0.0128 R^2f$ .
1,500-100,000	$19.2R^2$ .

f = frequency in MHz;

R = minimum separation distance from the body of a nearby person (appropriate units, e.g., m);

For multiple RF sources: Multiple RF sources are exempt if:

in the case of fixed RF sources operating in the same time-averaging period, or of multiple mobile or portable RF sources within a device operating in the same time averaging period, if the sum of the fractional contributions to the applicable thresholds is less than or equal to 1 as indicated in the following equation:

$$\sum_{i=1}^a \frac{P_i}{P_{th,i}} + \sum_{j=1}^b \frac{ERP_j}{ERP_{th,j}} + \sum_{k=1}^c \frac{Evaluated_k}{Exposure Limit_k} \leq 1$$

**Result**

Mode	Frequency (MHz)	Tune up conducted power <sup>#</sup>	Antenna Gain <sup>#</sup>		ERP		Evaluation Distance (m)	MPE-Based Exemption Threshold (mW)
		(dBm)	(dBi)	(dBd)	(dBm)	(mW)		
DECT	1921.536-1928.448	20.6	1.0	-1.15	19.45	88.10	0.2	768
Bluetooth	2402-2480	7.0	-1.0	-3.15	3.85	2.43	0.2	768

Note 1: The tune-up power and antenna gain was declared by the applicant.

Note 2: 0dBd=2.15dBi.

Note 3: The DECT function can transmit at the same time with the Bluetooth function.

Simultaneous transmitting consideration (worst case):

The ratio=  $ERP_{DECT}/limit + ERP_{BT}/limit = 88.10/768 + 2.43/768 = 0.12 < 1.0$

**Result: Compliant**

---

## **§ 15.317, § 15.203 ANTENNA REQUIREMENT**

---

### **Applicable Standard**

According to FCC § 15.203, an intentional radiator shall be designed to ensure that no antenna other than that furnished by the responsible party shall be used with the device. The use of a permanently attached antenna or of an antenna that uses a unique coupling to the intentional radiator shall be considered sufficient to comply with the provisions of this Section. The manufacturer may design the unit so that a broken antenna can be replaced by the user, but the use of a standard antenna jack or electrical connector is prohibited.

### **Antenna Connector Construction**

The EUT has two antennas which were permanently attached and the maximum antenna gain<sup>#</sup> is 1dBi, fulfill the requirement of this section. Please refer to the EUT photos.

**Result: Compliant**

## FCC§15.315 & §15.207 - CONDUCTED EMISSIONS

### Applicable Standard

FCC§15.315, an unlicensed PCS device that is designed to be connected to the public utility (AC) power line must meet the limits specified in §15.207.

### EUT Setup

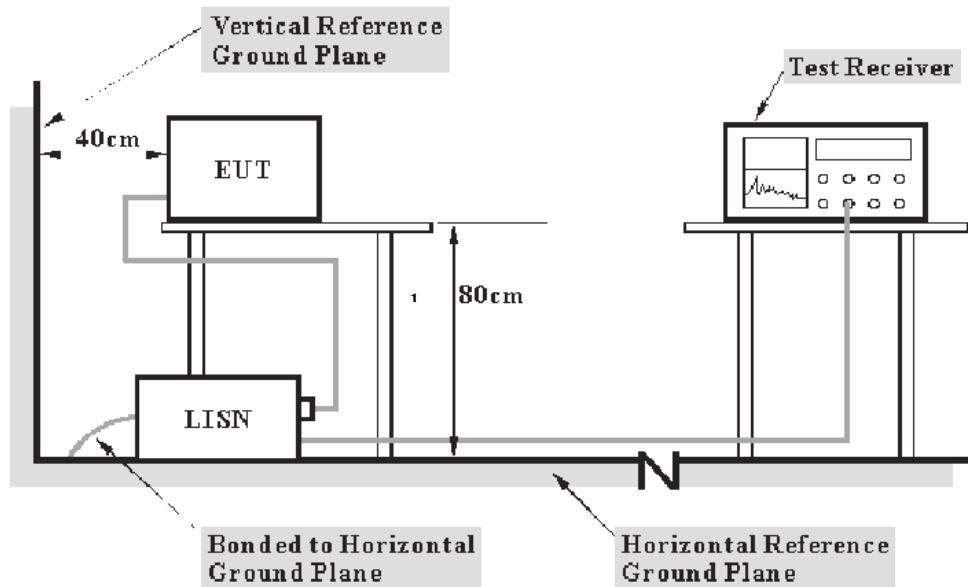

- Note: 1. Support units were connected to second LISN.  
 2. Both of LISNs (AMN) 80 cm from EUT and at the least 80 cm from other units and other metal planes support units.

The setup of EUT is according with per ANSI C63.4-2014 measurement procedure. The specification used was with the FCC 15.315 and FCC 15.207 limits.

The external I/O cables were draped along the test table and formed a bundle 30 to 40 cm long in the middle.

The spacing between the peripherals was 10 cm.

The adapter was connected to a 120 VAC/60 Hz power source.

### EMI Test Receiver Setup

The EMI test receiver was set to investigate the spectrum from 150 kHz to 30 MHz.

During the conducted emission test, the EMI test receiver was set with the following configurations:

Frequency Range	IF B/W
150 kHz – 30 MHz	9 kHz



## Test Procedure

During the conducted emission test, adapter was connected to the outlet of the LISN.

Maximizing procedure was performed on the six (6) highest emissions of the EUT.

All final data was recorded in the Quasi-peak and average detection mode.

## Factor & Over Limit Calculation

The factor is calculated by adding LISN VDF (Voltage Division Factor) and Cable Loss. The basic equation is as follows:

$$\text{Factor} = \text{LISN VDF} + \text{Cable Loss}$$

The “**Over limit**” column of the following data tables indicates the degree of compliance with the applicable limit. For example, an Over limit of -7 dB means the emission is 7 dB below the limit. The equation for calculation is as follows:

$$\begin{aligned} \text{Over Limit} &= \text{Level} - \text{Limit} \\ \text{Level} &= \text{Read Level} + \text{Factor} \end{aligned}$$

Note: The term "cable loss" refers to the combination of a cable and a 10dB transient limiter (attenuator).

## Test Results Summary

According to the recorded data in following table, the EUT complied with the FCC Part 15.207.

## Test Data

### Environmental Conditions

<b>Temperature:</b>	23 °C
<b>Relative Humidity:</b>	55 %
<b>ATM Pressure:</b>	101 kPa

*The testing was performed by Macy Shi on 2024-03-15.*

*Test mode: Transmitting*

For Adapter A318-060040W-US1  
 AC 120V/60 Hz, Line

Date: 2024-03-15

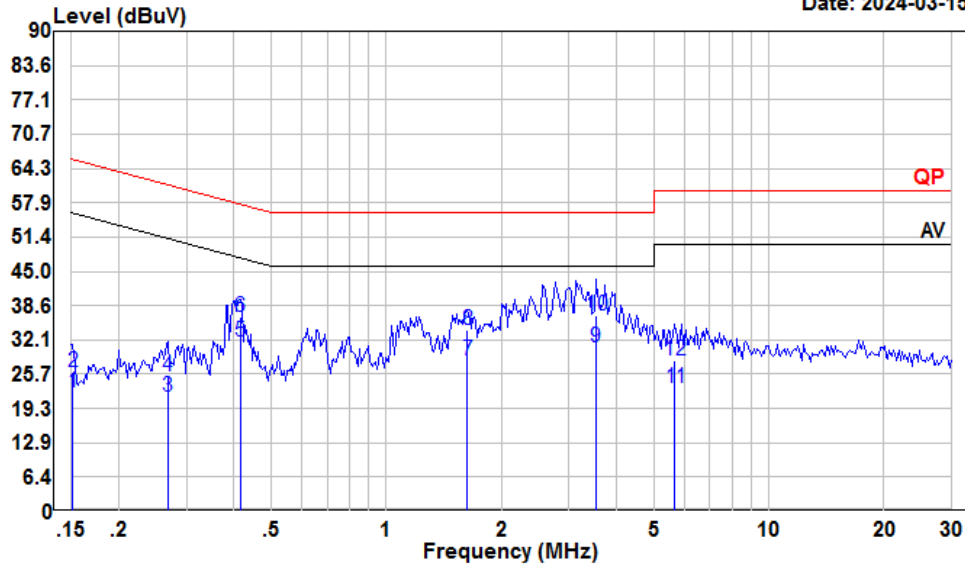

Condition: Line  
 Project : SZ1240220-08465E-RF  
 Tester : Macy shi  
 Note : GFSK

	Read	LISN	Cable	Limit	Over			
Freq	Level	Level	Loss	Line	Limit	Remark		
MHz	dBuV	dBuV	dB	dB	dBuV	dB		
1	0.15	1.27	22.32	10.90	10.15	55.91	-33.59	Average
2	0.15	4.97	26.02	10.90	10.15	65.91	-39.89	QP
3	0.27	0.61	21.49	10.70	10.18	51.16	-29.67	Average
4	0.27	4.33	25.21	10.70	10.18	61.16	-35.95	QP
5	0.41	11.17	31.94	10.56	10.21	47.55	-15.61	Average
6	0.41	15.77	36.54	10.56	10.21	57.55	-21.01	QP
7	1.63	7.66	28.29	10.54	10.09	46.00	-17.71	Average
8	1.63	13.48	34.11	10.54	10.09	56.00	-21.89	QP
9	3.53	10.25	30.86	10.35	10.26	46.00	-15.14	Average
10	3.53	16.16	36.77	10.35	10.26	56.00	-19.23	QP
11	5.68	2.50	23.15	10.43	10.22	50.00	-26.85	Average
12	5.68	7.74	28.39	10.43	10.22	60.00	-31.61	QP

AC 120V/60 Hz, Neutral

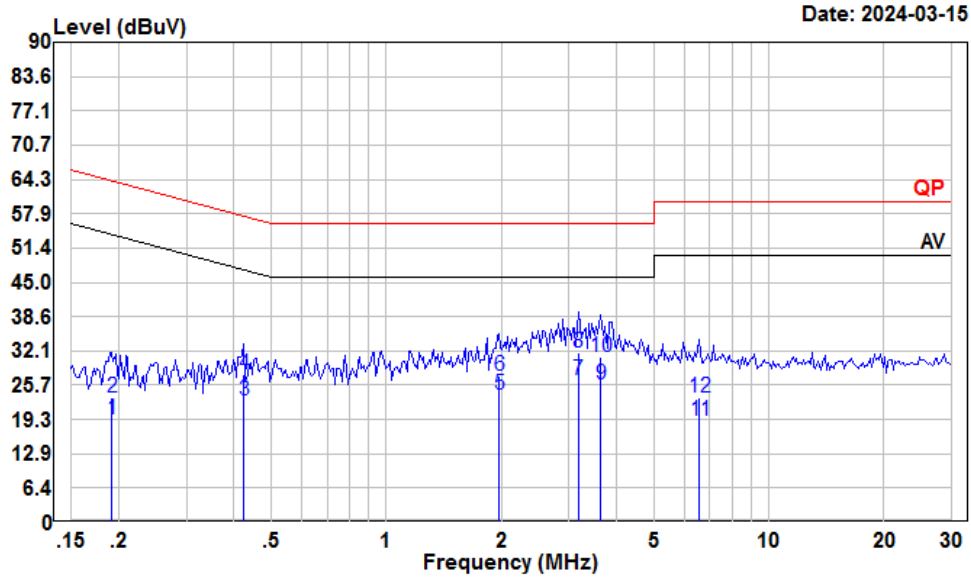

Condition: Neutral  
 Project : SZ1240220-08465E-RF  
 Tester : Macy shi  
 Note : GFSK

	Read	LISN	Cable	Limit	Over			
Freq	Level	Level	Factor	Line	Limit	Remark		
MHz	dBuV	dBuV	dB	dB	dBuV	dB		
1	0.19	-1.20	19.34	10.43	10.11	53.98	-34.64	Average
2	0.19	2.81	23.35	10.43	10.11	63.98	-40.63	QP
3	0.42	2.07	22.92	10.65	10.20	47.37	-24.45	Average
4	0.42	7.03	27.88	10.65	10.20	57.37	-29.49	QP
5	1.97	3.26	23.85	10.41	10.18	46.00	-22.15	Average
6	1.97	6.91	27.50	10.41	10.18	56.00	-28.50	QP
7	3.17	5.97	26.64	10.40	10.27	46.00	-19.36	Average
8	3.17	11.11	31.78	10.40	10.27	56.00	-24.22	QP
9	3.64	5.30	25.96	10.40	10.26	46.00	-20.04	Average
10	3.64	10.30	30.96	10.40	10.26	56.00	-25.04	QP
11	6.59	-1.86	19.03	10.67	10.22	50.00	-30.97	Average
12	6.59	2.53	23.42	10.67	10.22	60.00	-36.58	QP

For Adapter VT05UUS06040  
 AC 120V/60 Hz, Line

Date: 2024-03-15

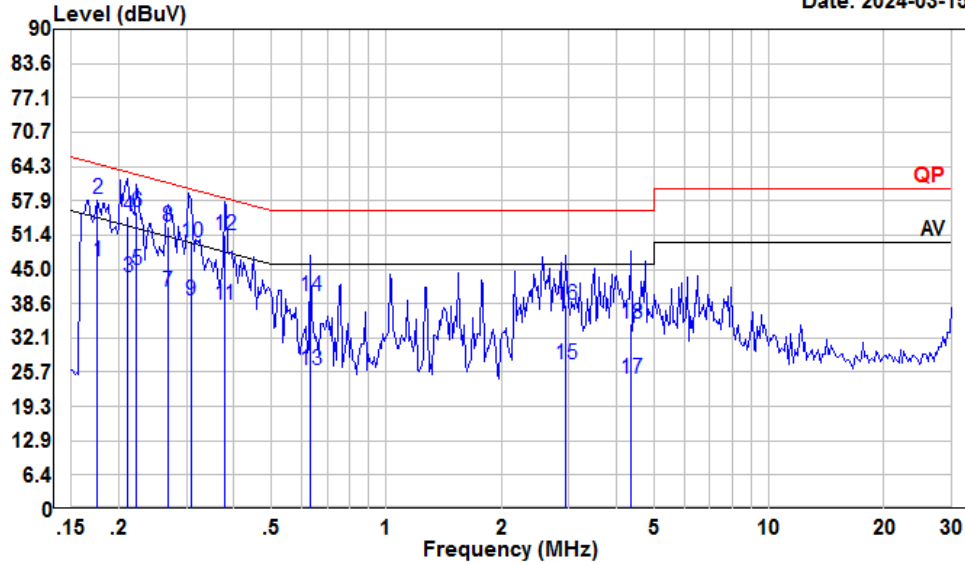

Condition: Line  
 Project : SZ1240220-08465E-RF  
 Tester : Macy shi  
 Note : GFSK

	Freq	Read Level	LISN Level	LISN Factor	Cable Loss	Limit Line	Over Limit	Remark
	MHz	dBuV	dBuV	dB	dB	dBuV	dB	
1	0.18	25.55	46.53	10.84	10.14	54.68	-8.15	Average
2	0.18	37.31	58.29	10.84	10.14	64.68	-6.39	QP
3	0.21	22.50	43.40	10.78	10.12	53.18	-9.78	Average
4	0.21	34.00	54.90	10.78	10.12	63.18	-8.28	QP
5	0.22	23.95	44.86	10.77	10.14	52.74	-7.88	Average
6	0.22	34.87	55.78	10.77	10.14	62.74	-6.96	QP
7	0.27	20.00	40.88	10.70	10.18	51.16	-10.28	Average
8	0.27	32.20	53.08	10.70	10.18	61.16	-8.08	QP
9	0.31	18.38	39.17	10.66	10.13	50.02	-10.85	Average
10	0.31	29.24	50.03	10.66	10.13	60.02	-9.99	QP
11	0.38	17.70	38.48	10.59	10.19	48.34	-9.86	Average
12	0.38	30.60	51.38	10.59	10.19	58.34	-6.96	QP
13	0.63	5.35	26.07	10.50	10.22	46.00	-19.93	Average
14	0.63	19.15	39.87	10.50	10.22	56.00	-16.13	QP
15	2.95	6.41	27.10	10.43	10.26	46.00	-18.90	Average
16	2.95	17.71	38.40	10.43	10.26	56.00	-17.60	QP

	Freq	Read Level	Level	LISN Factor	Cable Loss	Limit Line	Over Limit	Remark
	MHz	dBuV	dBuV	dB	dB	dBuV	dB	
17	4.36	3.94	24.52	10.33	10.25	46.00	-21.48	Average
18	4.36	14.32	34.90	10.33	10.25	56.00	-21.10	QP

AC 120V/60 Hz, Neutral

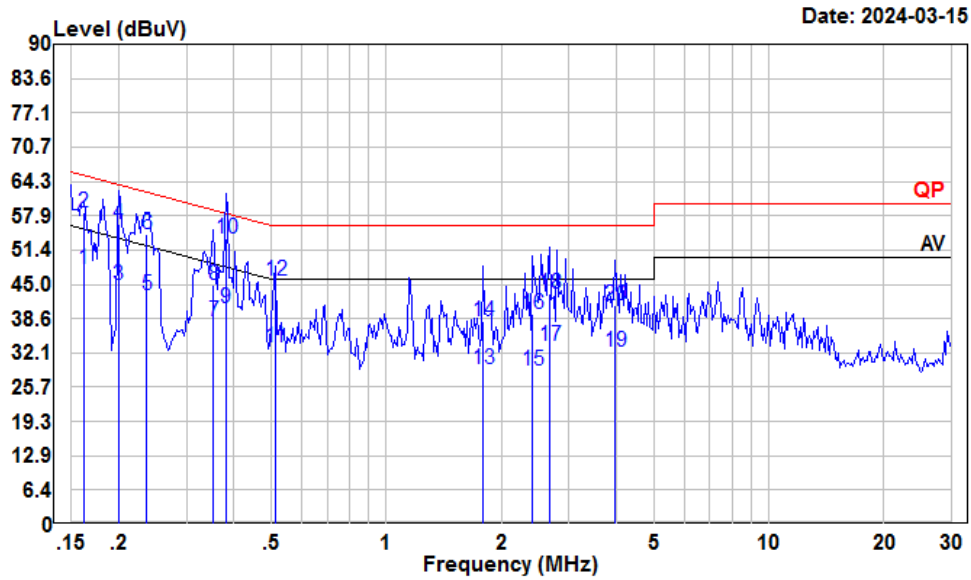

Condition: Neutral  
 Project : SZ1240220-08465E-RF  
 Tester : Macy shi  
 Note : GFSK

	Read Freq	Read Level	LISN Level	LISN Factor	Cable Loss	Limit Line	Over Limit	Remark
	MHz	dBuV	dBuV	dB	dB	dBuV	dB	
1	0.16	27.20	47.90	10.55	10.15	55.38	-7.48	Average
2	0.16	37.70	58.40	10.55	10.15	65.38	-6.98	QP
3	0.20	24.29	44.78	10.40	10.09	53.62	-8.84	Average
4	0.20	35.89	56.38	10.40	10.09	63.62	-7.24	QP
5	0.24	22.33	42.96	10.45	10.18	52.22	-9.26	Average
6	0.24	33.71	54.34	10.45	10.18	62.22	-7.88	QP
7	0.35	17.20	37.95	10.59	10.16	48.87	-10.92	Average
8	0.35	24.00	44.75	10.59	10.16	58.87	-14.12	QP
9	0.38	19.68	40.49	10.61	10.20	48.25	-7.76	Average
10	0.38	32.68	53.49	10.61	10.20	58.25	-4.76	QP
11	0.51	12.33	33.19	10.70	10.16	46.00	-12.81	Average
12	0.51	24.92	45.78	10.70	10.16	56.00	-10.22	QP
13	1.79	8.40	29.02	10.48	10.14	46.00	-16.98	Average
14	1.79	17.50	38.12	10.48	10.14	56.00	-17.88	QP
15	2.41	8.20	28.81	10.40	10.21	46.00	-17.19	Average
16	2.41	18.90	39.51	10.40	10.21	56.00	-16.49	QP

	Freq	Read Level	Level	LISN Factor	Cable Loss	Limit Line	Over Limit	Remark
	MHz	dBuV	dBuV	dB	dB	dBuV	dB	
17	2.68	12.71	33.34	10.40	10.23	46.00	-12.66	Average
18	2.68	22.50	43.13	10.40	10.23	56.00	-12.87	QP
19	3.96	11.60	32.26	10.40	10.26	46.00	-13.74	Average
20	3.96	20.30	40.96	10.40	10.26	56.00	-15.04	QP

For Adapter VT04UUS06040  
 AC 120V/60 Hz, Line

Date: 2024-03-15

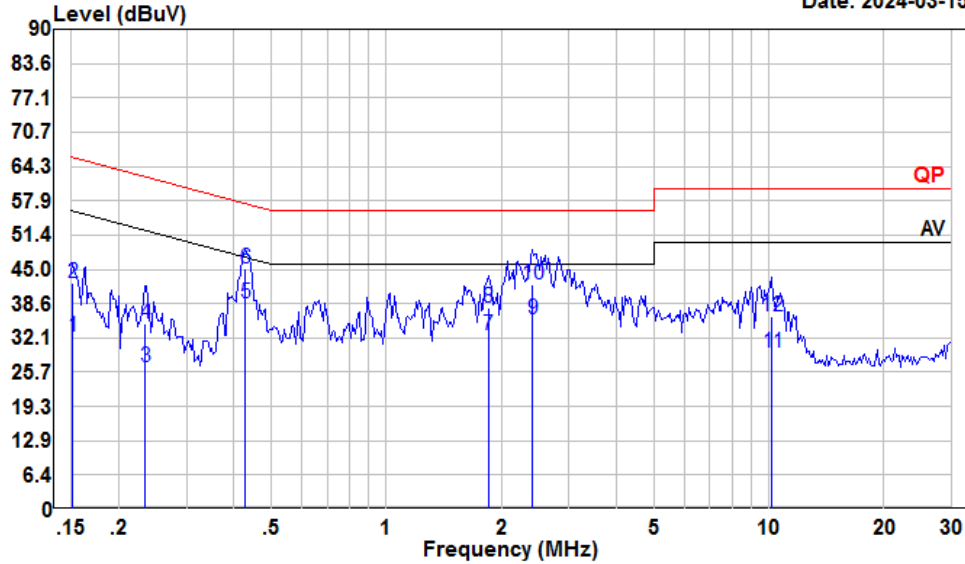

Condition: Line  
 Project : SZ1240220-08465E-RF  
 Tester : Macy shi  
 Note : GFSK

	Read Freq	Read Level	LISN Level	LISN Factor	Cable Loss	Limit Line	Over Limit	Remark
	MHz	dBuV	dBuV	dB	dB	dBuV	dB	
1	0.15	11.32	32.37	10.90	10.15	55.91	-23.54	Average
2	0.15	21.26	42.31	10.90	10.15	65.91	-23.60	QP
3	0.23	5.65	26.57	10.75	10.17	52.30	-25.73	Average
4	0.23	14.00	34.92	10.75	10.17	62.30	-27.38	QP
5	0.43	17.82	38.57	10.55	10.20	47.29	-8.72	Average
6	0.43	24.28	45.03	10.55	10.20	57.29	-12.26	QP
7	1.85	11.78	32.51	10.58	10.15	46.00	-13.49	Average
8	1.85	17.10	37.83	10.58	10.15	56.00	-18.17	QP
9	2.41	14.89	35.62	10.52	10.21	46.00	-10.38	Average
10	2.41	21.54	42.27	10.52	10.21	56.00	-13.73	QP
11	10.18	8.64	29.49	10.60	10.25	50.00	-20.51	Average
12	10.18	15.32	36.17	10.60	10.25	60.00	-23.83	QP



AC 120V/60 Hz, Neutral

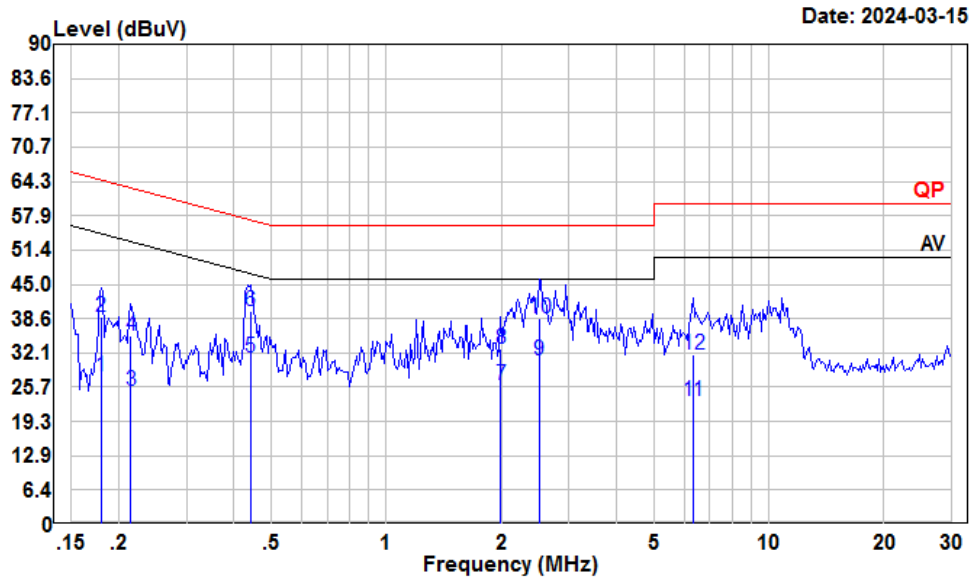

Condition: Neutral  
 Project : SZ1240220-08465E-RF  
 Tester : Macy shi  
 Note : GFSK

	Read Freq	Read Level	LISN Level	LISN Factor	Cable Loss	Limit Line	Over Limit	Remark
	MHz	dBuV	dBuV	dB	dB	dBuV	dB	
1	0.18	7.17	27.77	10.47	10.13	54.50	-26.73	Average
2	0.18	18.28	38.88	10.47	10.13	64.50	-25.62	QP
3	0.22	4.51	25.06	10.42	10.13	53.01	-27.95	Average
4	0.22	14.88	35.43	10.42	10.13	63.01	-27.58	QP
5	0.44	10.47	31.32	10.66	10.19	47.02	-15.70	Average
6	0.44	19.17	40.02	10.66	10.19	57.02	-17.00	QP
7	1.99	5.62	26.21	10.40	10.19	46.00	-19.79	Average
8	1.99	12.32	32.91	10.40	10.19	56.00	-23.09	QP
9	2.51	10.25	30.86	10.40	10.21	46.00	-15.14	Average
10	2.51	17.97	38.58	10.40	10.21	56.00	-17.42	QP
11	6.32	2.38	23.25	10.65	10.22	50.00	-26.75	Average
12	6.32	11.08	31.95	10.65	10.22	60.00	-28.05	QP

For Adapter E004-1A060040VU  
 AC 120V/60 Hz, Line

Date: 2024-03-15

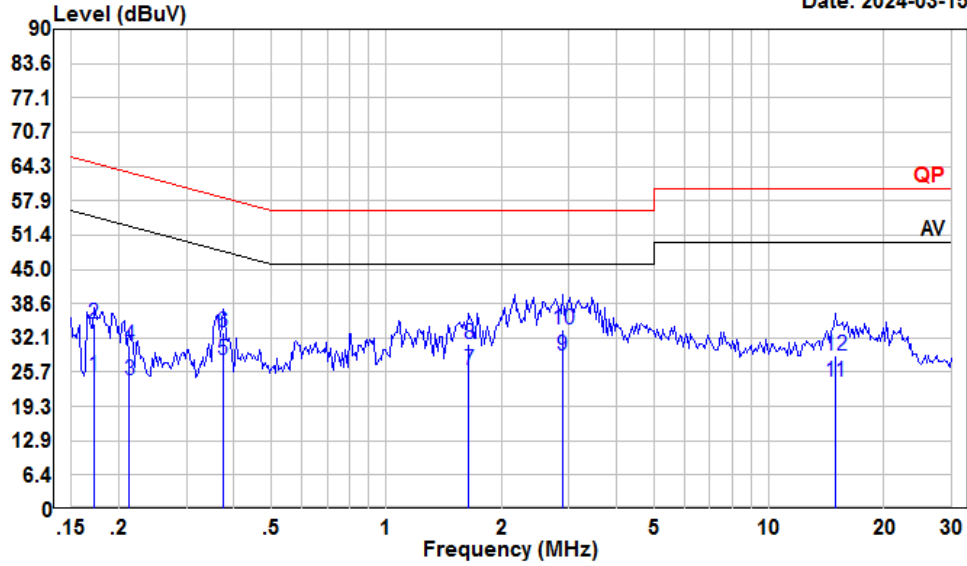

Condition: Line  
 Project : SZ1240220-08465E-RF  
 Tester : Macy shi  
 Note : GFSK

	Read	LISN	Cable	Limit	Over			
Freq	Level	Level	Factor	Line	Limit	Remark		
MHz	dBuV	dBuV	dB	dB	dBuV	dB		
1	0.17	4.15	25.15	10.85	10.15	54.86	-29.71	Average
2	0.17	13.81	34.81	10.85	10.15	64.86	-30.05	QP
3	0.21	3.42	24.32	10.78	10.12	53.10	-28.78	Average
4	0.21	9.72	30.62	10.78	10.12	63.10	-32.48	QP
5	0.37	7.27	28.06	10.60	10.19	48.43	-20.37	Average
6	0.37	12.44	33.23	10.60	10.19	58.43	-25.20	QP
7	1.65	5.57	26.21	10.54	10.10	46.00	-19.79	Average
8	1.65	10.37	31.01	10.54	10.10	56.00	-24.99	QP
9	2.88	8.10	28.80	10.44	10.26	46.00	-17.20	Average
10	2.88	12.99	33.69	10.44	10.26	56.00	-22.31	QP
11	14.91	3.11	23.81	10.60	10.10	50.00	-26.19	Average
12	14.91	8.04	28.74	10.60	10.10	60.00	-31.26	QP

AC 120V/60 Hz, Neutral

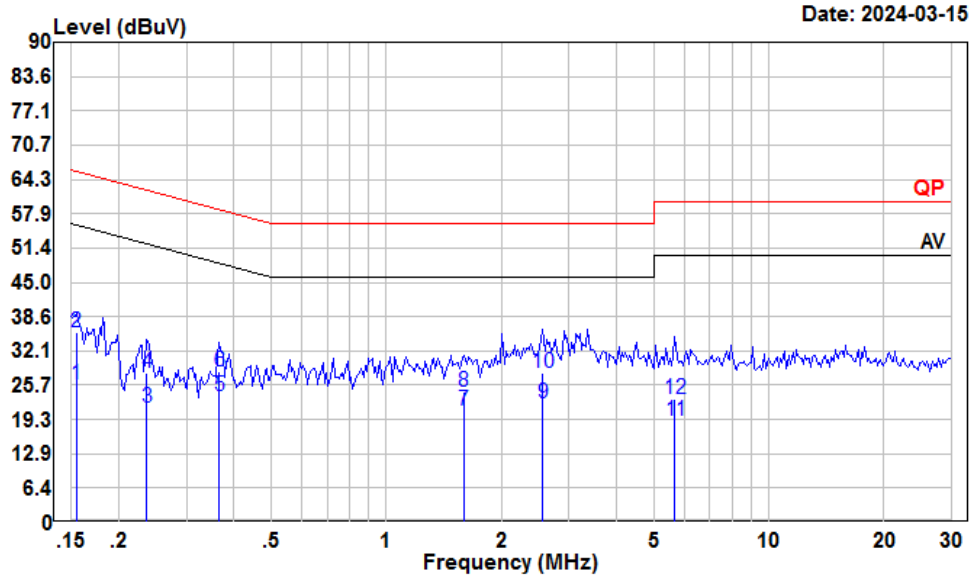

Condition: Neutral  
 Project : SZ1240220-08465E-RF  
 Tester : Macy shi  
 Note : GFSK

	Read Freq	Read Level	LISN Level	LISN Factor	Cable Loss	Limit Line	Over Limit	Remark
	MHz	dBuV	dBuV	dB	dB	dBuV	dB	
1	0.15	5.22	25.95	10.58	10.15	55.74	-29.79	Average
2	0.15	14.98	35.71	10.58	10.15	65.74	-30.03	QP
3	0.24	0.79	21.42	10.45	10.18	52.22	-30.80	Average
4	0.24	7.39	28.02	10.45	10.18	62.22	-34.20	QP
5	0.37	2.82	23.60	10.60	10.18	48.61	-25.01	Average
6	0.37	7.48	28.26	10.60	10.18	58.61	-30.35	QP
7	1.59	0.24	20.88	10.56	10.08	46.00	-25.12	Average
8	1.59	3.83	24.47	10.56	10.08	56.00	-31.53	QP
9	2.57	1.76	22.38	10.40	10.22	46.00	-23.62	Average
10	2.57	7.36	27.98	10.40	10.22	56.00	-28.02	QP
11	5.68	-1.76	19.05	10.59	10.22	50.00	-30.95	Average
12	5.68	2.23	23.04	10.59	10.22	60.00	-36.96	QP

For Adapter DSA-3PFM-05 BUS 060040  
 AC 120V/60 Hz, Line

Date: 2024-03-15

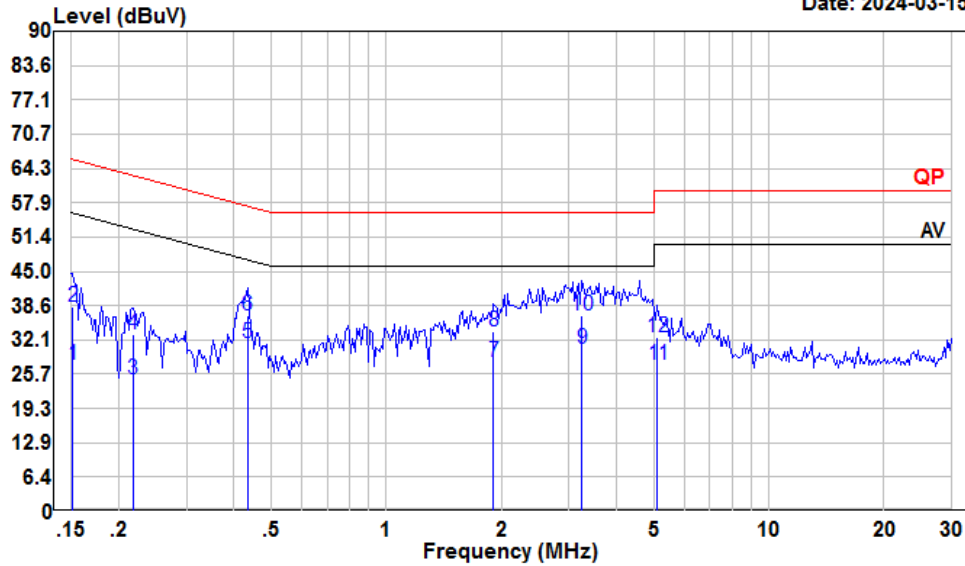

Condition: Line  
 Project : SZ1240220-08465E-RF  
 Tester : Macy shi  
 Note : GFSK

	Read	LISN	Cable	Limit	Over			
Freq	Level	Level	Loss	Line	Limit	Remark		
MHz	dBuV	dBuV	dB	dB	dBuV	dB		
1	0.15	6.33	27.38	10.90	10.15	55.91	-28.53	Average
2	0.15	17.34	38.39	10.90	10.15	65.91	-27.52	QP
3	0.22	3.82	24.72	10.77	10.13	52.92	-28.20	Average
4	0.22	12.31	33.21	10.77	10.13	62.92	-29.71	QP
5	0.43	10.69	31.44	10.55	10.20	47.20	-15.76	Average
6	0.43	15.96	36.71	10.55	10.20	57.20	-20.49	QP
7	1.91	7.29	28.05	10.59	10.17	46.00	-17.95	Average
8	1.91	12.97	33.73	10.59	10.17	56.00	-22.27	QP
9	3.24	9.73	30.39	10.39	10.27	46.00	-15.61	Average
10	3.24	16.19	36.85	10.39	10.27	56.00	-19.15	QP
11	5.11	6.79	27.40	10.39	10.22	50.00	-22.60	Average
12	5.11	12.09	32.70	10.39	10.22	60.00	-27.30	QP

AC 120V/60 Hz, Neutral

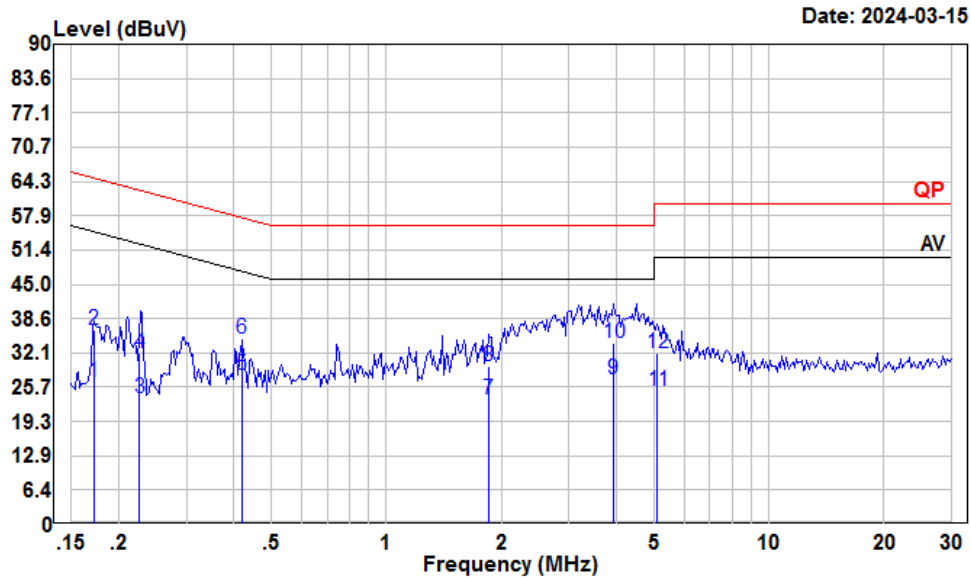

Condition: Neutral  
 Project : SZ1240220-08465E-RF  
 Tester : Macy shi  
 Note : GFSK

	Read Freq	Read Level	LISN Level	LISN Factor	Cable Loss	Limit Line	Over Limit	Remark
	MHz	dBuV	dBuV	dB	dB	dBuV	dB	
1	0.17	5.93	26.58	10.50	10.15	54.86	-28.28	Average
2	0.17	15.79	36.44	10.50	10.15	64.86	-28.42	QP
3	0.23	3.02	23.61	10.44	10.15	52.57	-28.96	Average
4	0.23	11.38	31.97	10.44	10.15	62.57	-30.60	QP
5	0.42	7.17	28.02	10.64	10.21	47.46	-19.44	Average
6	0.42	13.94	34.79	10.64	10.21	57.46	-22.67	QP
7	1.85	2.92	23.53	10.46	10.15	46.00	-22.47	Average
8	1.85	9.02	29.63	10.46	10.15	56.00	-26.37	QP
9	3.92	6.48	27.14	10.40	10.26	46.00	-18.86	Average
10	3.92	13.46	34.12	10.40	10.26	56.00	-21.88	QP
11	5.11	4.23	24.98	10.53	10.22	50.00	-25.02	Average
12	5.11	11.43	32.18	10.53	10.22	60.00	-27.82	QP

For Adapter G006-060040-ZU  
 AC 120V/60 Hz, Line

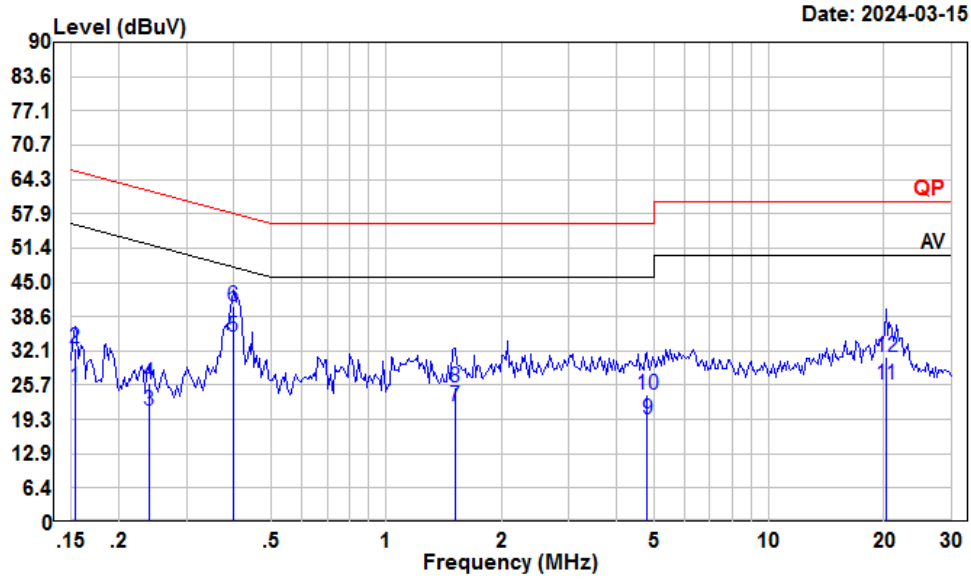

Date: 2024-03-15

Condition: Line  
 Project : SZ1240220-08465E-RF  
 Tester : Macy shi  
 Note : GFSK

	Read Freq	Read Level	LISN Level	LISN Factor	Cable Loss	Limit Line	Over Limit	Remark
	MHz	dBuV	dBuV	dB	dB	dBuV	dB	
1	0.15	4.35	25.39	10.89	10.15	55.82	-30.43	Average
2	0.15	11.71	32.75	10.89	10.15	65.82	-33.07	QP
3	0.24	-0.10	20.82	10.74	10.18	52.13	-31.31	Average
4	0.24	5.14	26.06	10.74	10.18	62.13	-36.07	QP
5	0.40	13.93	34.73	10.58	10.22	47.90	-13.17	Average
6	0.40	19.63	40.43	10.58	10.22	57.90	-17.47	QP
7	1.51	1.29	21.87	10.52	10.06	46.00	-24.13	Average
8	1.51	4.59	25.17	10.52	10.06	56.00	-30.83	QP
9	4.80	-1.27	19.32	10.36	10.23	46.00	-26.68	Average
10	4.80	3.25	23.84	10.36	10.23	56.00	-32.16	QP
11	20.27	4.89	25.90	10.89	10.12	50.00	-24.10	Average
12	20.27	9.89	30.90	10.89	10.12	60.00	-29.10	QP

AC 120V/60 Hz, Neutral

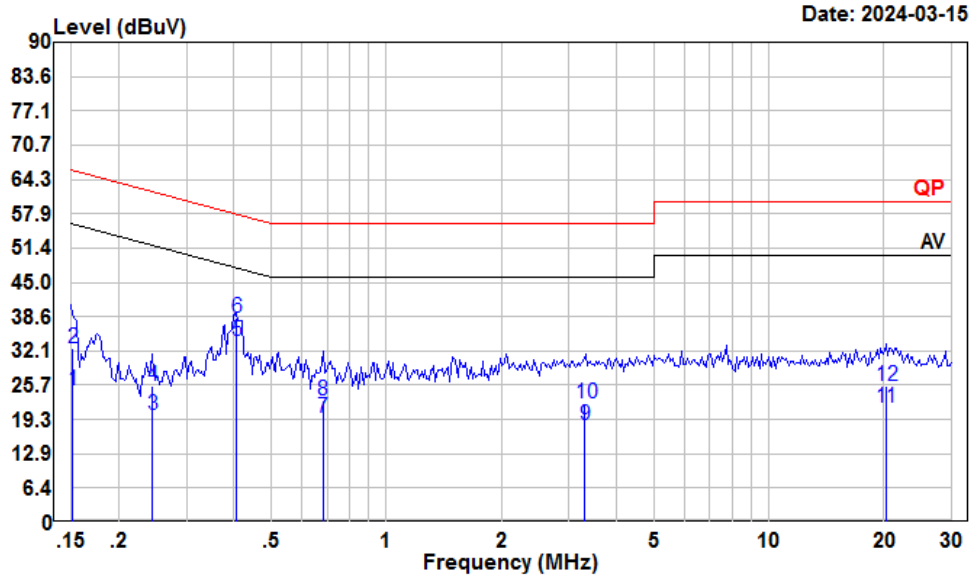

Condition: Neutral  
 Project : SZ1240220-08465E-RF  
 Tester : Macy shi  
 Note : GFSK

	Read Freq	Read Level	LISN Level	LISN Factor	Cable Loss	Limit Line	Over Limit	Remark
	MHz	dBuV	dBuV	dB	dB	dBuV	dB	
1	0.15	3.93	24.67	10.59	10.15	55.91	-31.24	Average
2	0.15	11.94	32.68	10.59	10.15	65.91	-33.23	QP
3	0.24	-0.54	20.13	10.47	10.20	51.95	-31.82	Average
4	0.24	5.01	25.68	10.47	10.20	61.95	-36.27	QP
5	0.41	13.17	34.02	10.63	10.22	47.73	-13.71	Average
6	0.41	17.41	38.26	10.63	10.22	57.73	-19.47	QP
7	0.68	-1.28	19.63	10.70	10.21	46.00	-26.37	Average
8	0.68	2.04	22.95	10.70	10.21	56.00	-33.05	QP
9	3.31	-2.37	18.30	10.40	10.27	46.00	-27.70	Average
10	3.31	1.56	22.23	10.40	10.27	56.00	-33.77	QP
11	20.27	0.63	21.44	10.69	10.12	50.00	-28.56	Average
12	20.27	4.85	25.66	10.69	10.12	60.00	-34.34	QP

## FCC §15.205, §15.209 & §15.319 (g) - RADIATED EMISSIONS

### Applicable Standard

FCC §15.205; §15.209; §15.319 (g)

### EUT Setup

9 kHz-30MHz:

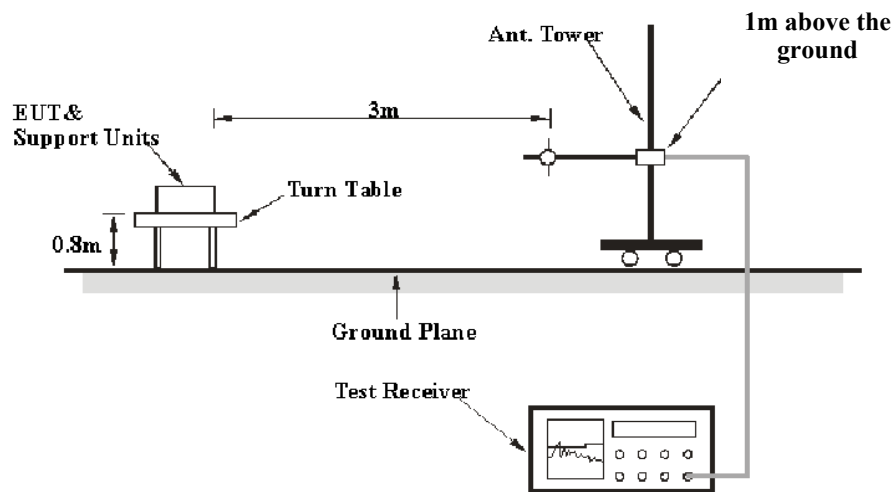

30MHz-1GHz:

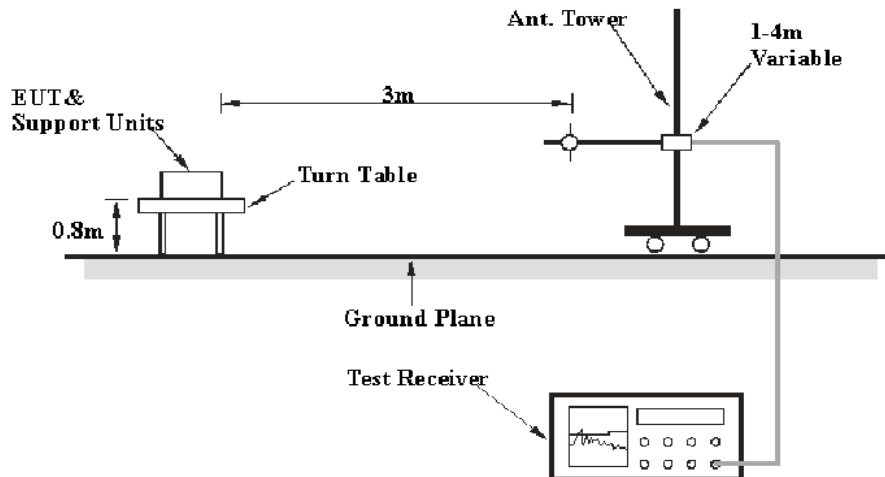



**Above 1GHz:**

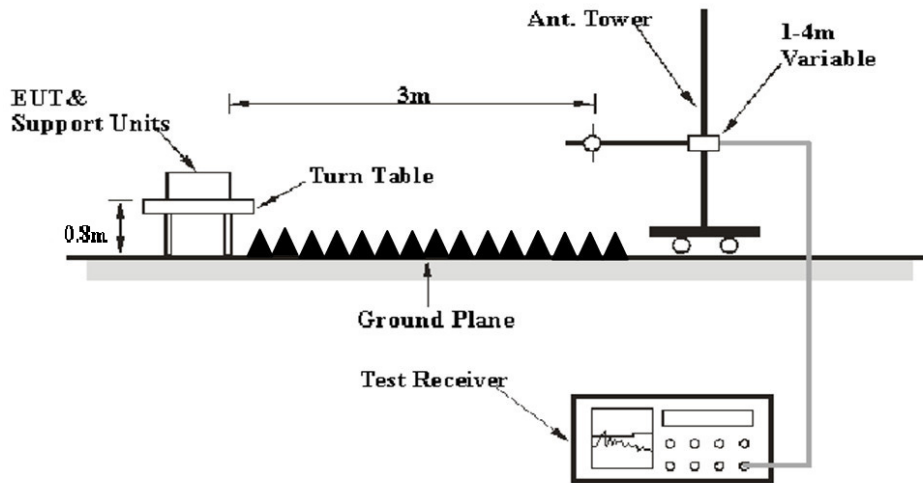

The radiated emission tests were performed in the 3 meters, using the setup accordance with the ANSI C63.17-2013. The specification used was the FCC 15.209 and FCC 15.319 (g) limits.

**EMI Test Receiver & Spectrum Analyzer Setup**

Frequency Range	RBW	Video B/W	IF B/W	Measurement
9 kHz – 150 kHz	/	/	200 Hz	QP
	300 Hz	1 kHz	/	PK
150 kHz – 30 MHz	/	/	9 kHz	QP
	10 kHz	30 kHz	/	PK
30 MHz – 1000 MHz	/	/	120 kHz	QP
	100 kHz	300 kHz	/	PK
Above 1 GHz	1MHz	3 MHz	/	PK

If the maximized peak measured value complies with under the QP/Average limit more than 6dB, then it is unnecessary to perform an QP/Average measurement.

For the average spurious emission above 1GHz, it was calculated by the below formula:

$$\text{Average} = \text{Peak Measurement} + \text{Duty Cycle Corrected Factor}$$

**Test Procedure**

Maximizing procedure was performed on the highest emissions to ensure that the EUT complied with all installation combinations.

All final data was recorded in Quasi-peak detection mode except for the frequency bands 9–90 kHz, 110–490 kHz and above 1000 MHz, average detection modes for frequency bands 9–90 kHz and 110–490 kHz, peak and average detection modes for frequencies above 1 GHz.

For 9 kHz-30MHz, the report shall list the six emissions with the smallest margin relative to the limit, for each of the three antenna orientations (parallel, perpendicular, and ground-parallel) unless the margin is greater than 20 dB.

If the maximized peak measured value complies with under the QP/Average limit more than 6dB, then it is unnecessary to perform an QP/Average measurement.

**Factor & Over Limit/Margin Calculation**

The Factor is calculated by adding the Antenna Factor and Cable Loss, and subtracting the Amplifier Gain. The basic equation is as follows:

$$\text{Factor} = \text{Antenna Factor} + \text{Cable Loss} - \text{Amplifier Gain}$$

The “**Over Limit/Margin**” column of the following data tables indicates the degree of compliance with the applicable limit. For example, an Over Limit/margin of -7dB means the emission is 7dB below the limit. The equation for calculation is as follows:

$$\begin{aligned} \text{Over Limit/Margin} &= \text{Level/Corrected Amplitude} - \text{Limit} \\ \text{Level / Corrected Amplitude} &= \text{Read Level} + \text{Factor} \end{aligned}$$

**Test Data**

**Environmental Conditions**

<b>Temperature:</b>	25.6~26 °C
<b>Relative Humidity:</b>	50~54 %
<b>ATM Pressure:</b>	101 kPa

*The testing was performed by Anson Su on 2024-04-10 for below 1GHz and Dylan Yang on 2024-04-11 for above 1GHz, Hanic Pan on 2024-03-12 for Duty cycle.*

*Test mode: Transmitting*

Note: For the spurious radiated emission below 30MHz, the emissions are 20dB below the limit which were not recorded.

For Adapter A318-060040W-US1  
**30MHz-1GHz:**

**Horizontal**

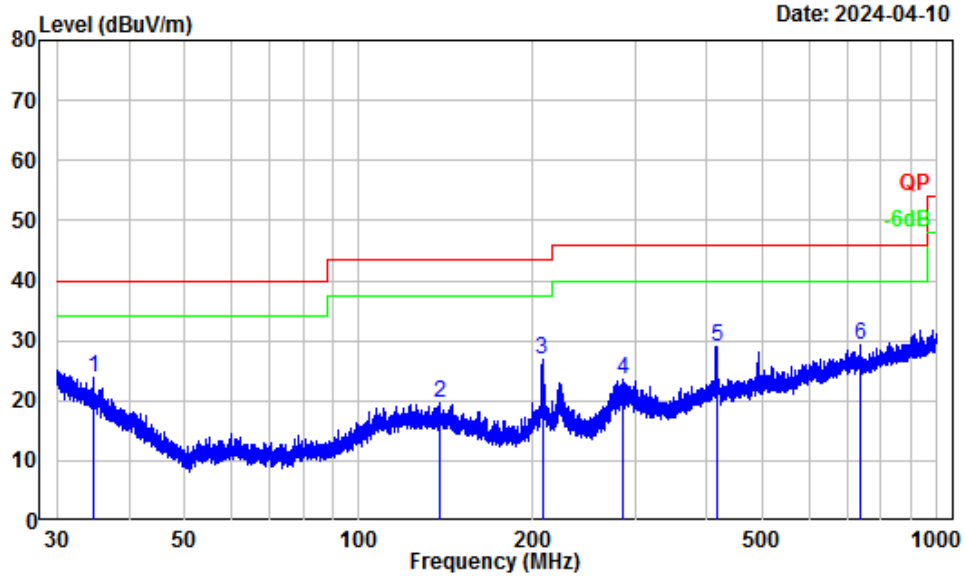

Site : Chamber A  
 Condition : 3m Horizontal  
 Project Number: SZ1240220-08465E-RF  
 Note : GFSK  
 Tester : Anson Su

	Freq Factor		Read Level		Limit	Over	Remark
	MHz	dB/m	dBuV	dBuV/m	Line	Limit	
1	34.71	-6.83	30.69	23.86	40.00	-16.14	Peak
2	137.54	-10.62	30.10	19.48	43.50	-24.02	Peak
3	207.49	-11.15	37.99	26.84	43.50	-16.66	Peak
4	285.98	-10.49	34.00	23.51	46.00	-22.49	Peak
5	415.27	-6.83	35.80	28.97	46.00	-17.03	Peak
6	736.75	-1.63	30.80	29.17	46.00	-16.83	Peak

Vertical

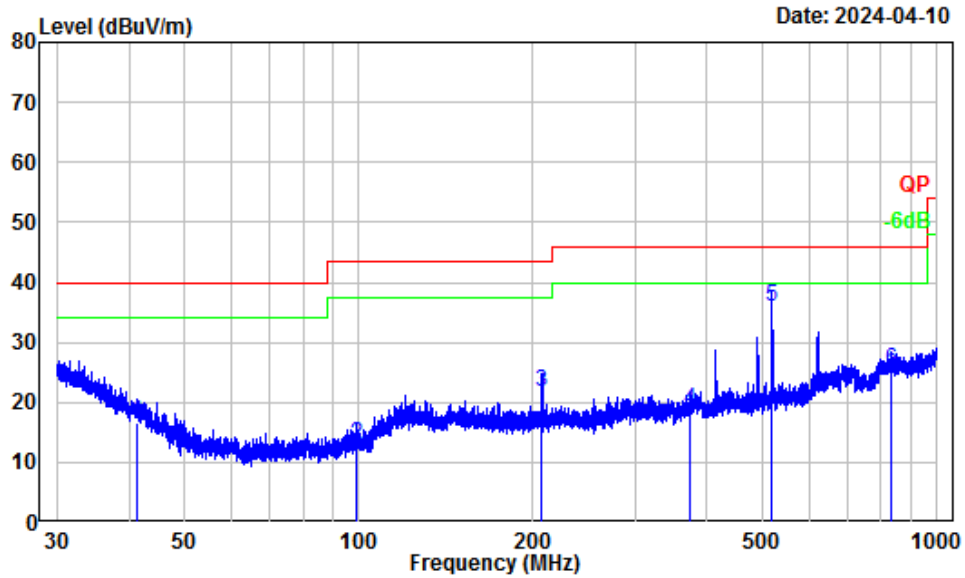

Site : Chamber A  
 Condition : 3m Vertical  
 Project Number: SZ1240220-08465E-RF  
 Note : GFSK  
 Tester : Anson Su

	Freq Factor		Read Level		Limit Line	Over Limit	Remark
	MHz	dB/m	dBuV	dBuV/m	dBuV/m	dB	
1	41.26	-12.60	29.19	16.59	40.00	-23.41	QP
2	98.75	-15.50	28.33	12.83	43.50	-30.67	QP
3	207.40	-12.23	33.88	21.65	43.50	-21.85	QP
4	372.66	-8.98	27.76	18.78	46.00	-27.22	QP
5	518.38	-5.11	40.95	35.84	46.00	-10.16	QP
6	832.59	-0.30	25.63	25.33	46.00	-20.67	QP

For Adapter VT05UUS06040

30MHz-1GHz:

Horizontal

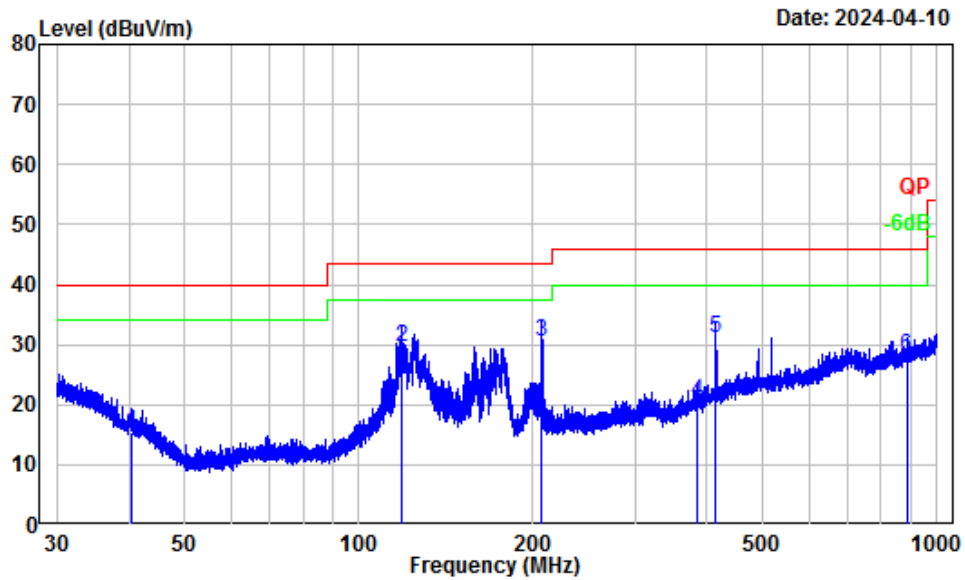

Site : Chamber A  
 Condition : 3m Horizontal  
 Project Number: SZ1240220-08465E-RF  
 Note : GFSK  
 Tester : Anson Su

	Freq Factor		Read Level		Limit Line	Over Limit	Remark
	MHz	dB/m	dBuV	dBuV/m	dBuV/m	dB	
1	40.49	-10.70	25.95	15.25	40.00	-24.75	QP
2	118.81	-10.44	40.00	29.56	43.50	-13.94	QP
3	207.30	-11.15	41.78	30.63	43.50	-12.87	QP
4	385.28	-8.09	28.57	20.48	46.00	-25.52	QP
5	414.72	-6.85	37.87	31.02	46.00	-14.98	QP
6	886.06	0.78	27.18	27.96	46.00	-18.04	QP

Vertical

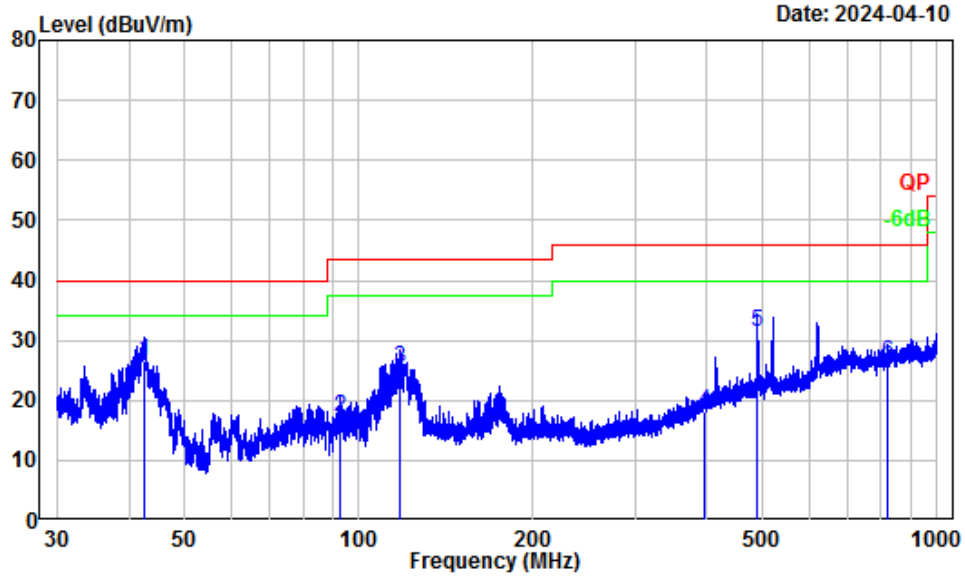

Site : Chamber A  
 Condition : 3m Vertical  
 Project Number: SZ1240220-08465E-RF  
 Note : GFSK  
 Tester : Anson Su

	Freq Factor		Read Level		Limit Line	Over Limit	Remark
	MHz	dB/m	dBuV	dBuV/m	dBuV/m	dB	
1	42.54	-13.33	39.88	26.55	40.00	-13.45	QP
2	92.58	-16.81	33.95	17.14	43.50	-26.36	QP
3	117.77	-11.10	36.47	25.37	43.50	-18.13	QP
4	395.55	-7.79	25.92	18.13	46.00	-27.87	QP
5	489.24	-5.44	36.94	31.50	46.00	-14.50	QP
6	822.43	-0.41	26.75	26.34	46.00	-19.66	QP

For Adapter VT04UUS06040

30MHz-1GHz:

Horizontal

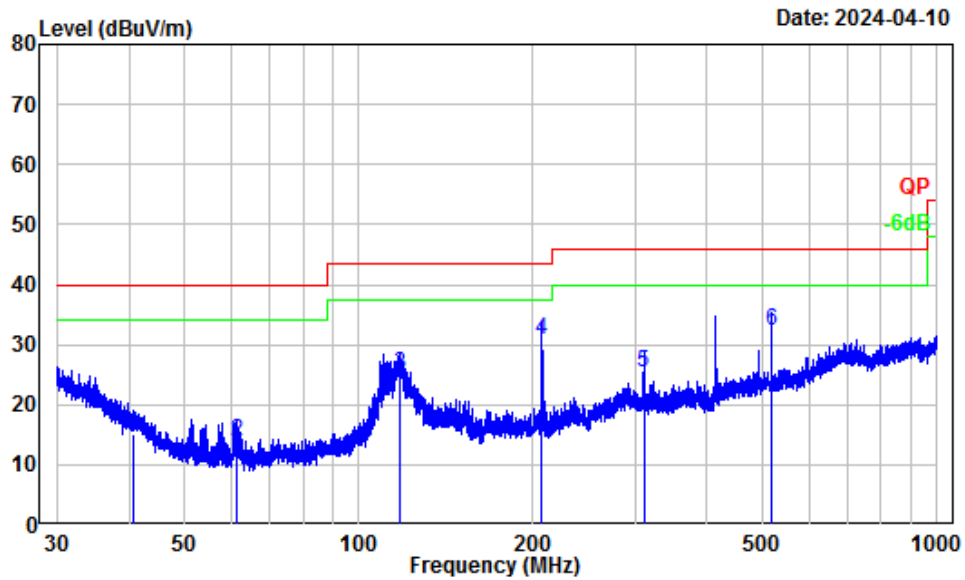

Site : Chamber A  
 Condition : 3m Horizontal  
 Project Number: SZ1240220-08465E-RF  
 Note : GFSK  
 Tester : Anson Su

	Freq Factor		Read Level		Limit	Over	Remark
	MHz	dB/m	dBuV	dBuV/m	Line	Limit	
1	40.59	-10.76	25.87	15.11	40.00	-24.89	QP
2	61.53	-16.45	30.43	13.98	40.00	-26.02	QP
3	117.67	-10.53	35.50	24.97	43.50	-18.53	QP
4	207.30	-11.15	41.85	30.70	43.50	-12.80	QP
5	310.95	-9.94	35.44	25.50	46.00	-20.50	QP
6	518.61	-4.87	37.28	32.41	46.00	-13.59	QP

Vertical

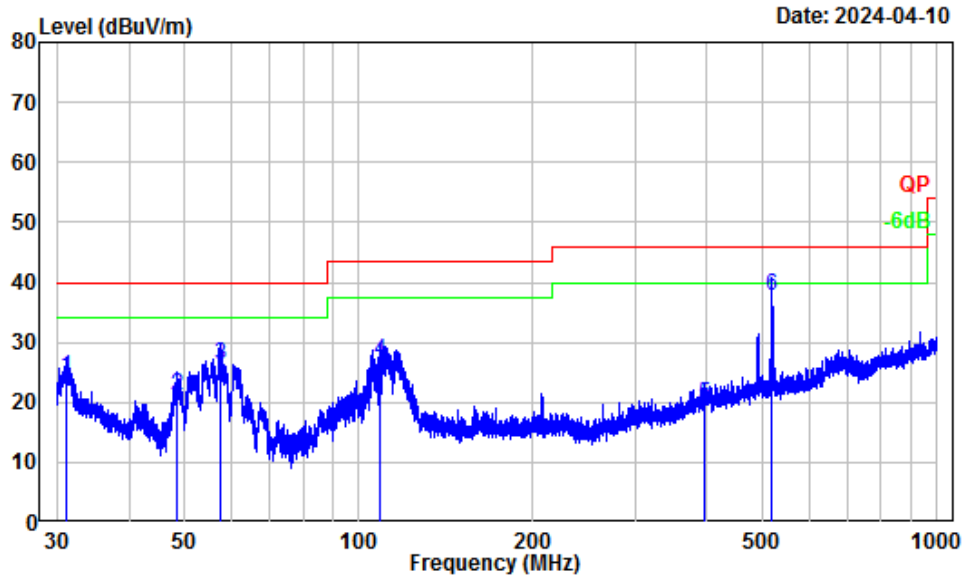

Site : Chamber A  
 Condition : 3m Vertical  
 Project Number: SZ1240220-08465E-RF  
 Note : GFSK  
 Tester : Anson Su

	Freq Factor		Read Level		Limit Line	Over Limit	Remark
	MHz	dB/m	dBuV	dBuV/m	dBuV/m	dB	
1	31.26	-6.36	30.50	24.14	40.00	-15.86	QP
2	48.33	-16.56	37.60	21.04	40.00	-18.96	QP
3	57.42	-17.56	43.73	26.17	40.00	-13.83	QP
4	108.89	-12.66	39.48	26.82	43.50	-16.68	QP
5	395.37	-7.80	27.57	19.77	46.00	-26.23	QP
6	518.38	-5.11	42.93	37.82	46.00	-8.18	QP



For Adapter E004-LA060040VU

30MHz-1GHz:

Horizontal

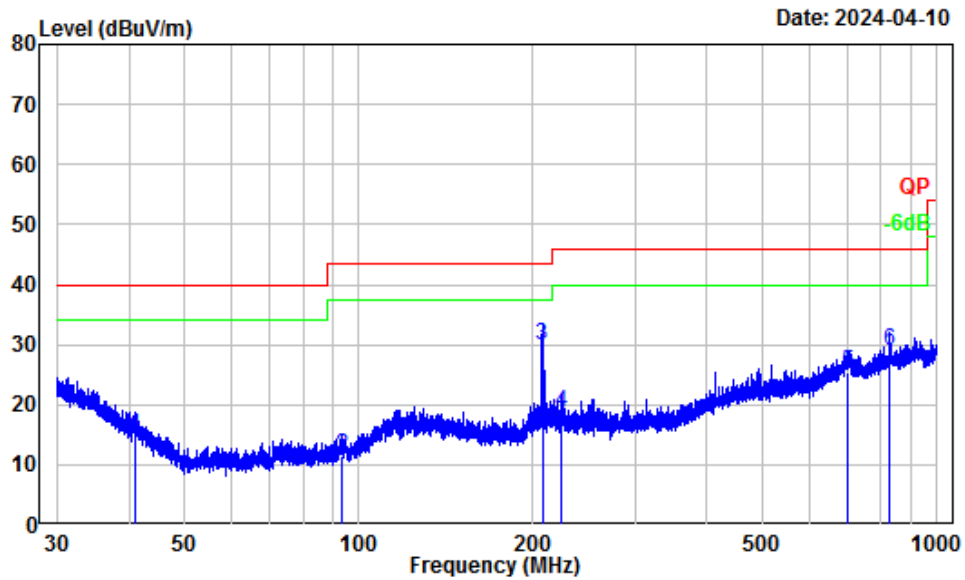

Site : Chamber A  
 Condition : 3m Horizontal  
 Project Number: SZ1240220-08465E-RF  
 Note : GFSK  
 Tester : Anson Su

	Freq Factor		Read Level		Limit	Over	Remark
	MHz	dB/m	dBuV	dBuV/m	Line	Limit	
1	40.92	-10.98	25.72	14.74	40.00	-25.26	QP
2	93.28	-15.64	27.09	11.45	43.50	-32.05	QP
3	207.49	-11.15	41.08	29.93	43.50	-13.57	QP
4	224.62	-11.43	30.25	18.82	46.00	-27.18	QP
5	699.92	-1.51	26.86	25.35	46.00	-20.65	QP
6	829.67	-0.11	29.08	28.97	46.00	-17.03	QP

Vertical

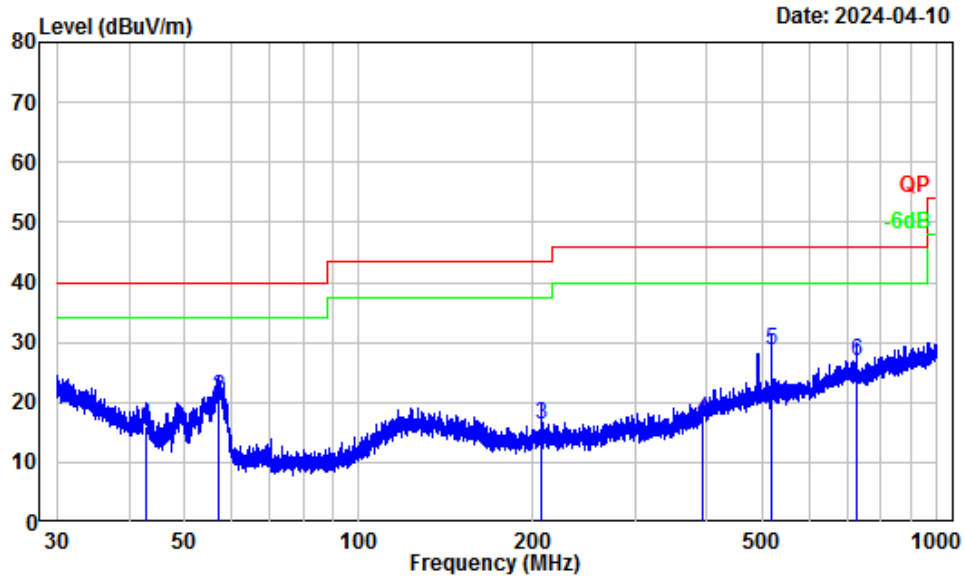

Site : Chamber A  
 Condition : 3m Vertical  
 Project Number: SZ1240220-08465E-RF  
 Note : GFSK  
 Tester : Anson Su

	Freq Factor		Read Level		Limit Line	Over Limit	Remark
	MHz	dB/m	dBuV	dBuV/m	dBuV/m	dB	
1	42.73	-13.44	29.32	15.88	40.00	-24.12	QP
2	57.12	-17.55	38.33	20.78	40.00	-19.22	QP
3	207.40	-12.23	28.62	16.39	43.50	-27.11	QP
4	394.51	-7.84	25.13	17.29	46.00	-28.71	QP
5	518.16	-5.11	33.66	28.55	46.00	-17.45	QP
6	725.85	-2.04	28.87	26.83	46.00	-19.17	QP

For Adapter DSA-3PFM-05 BUS 060040

30MHz-1GHz:

Horizontal

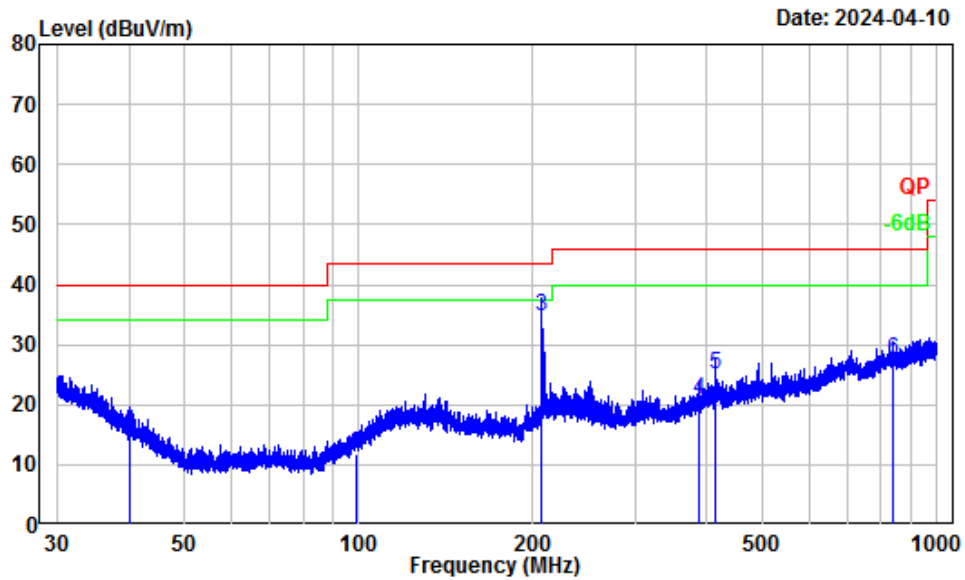

Site : Chamber A  
 Condition : 3m Horizontal  
 Project Number: SZ1240220-08465E-RF  
 Note : GFSK  
 Tester : Anson Su

	Freq Factor		Read Level		Limit	Over	Remark
	MHz	dB/m	dBuV	dBuV/m	Line	Limit	
1	40.21	-10.52	26.01	15.49	40.00	-24.51	QP
2	99.09	-13.98	25.87	11.89	43.50	-31.61	QP
3	207.30	-11.15	45.87	34.72	43.50	-8.78	QP
4	388.16	-7.95	28.70	20.75	46.00	-25.25	QP
5	414.90	-6.84	31.79	24.95	46.00	-21.05	QP
6	841.76	0.07	27.27	27.34	46.00	-18.66	QP

Vertical

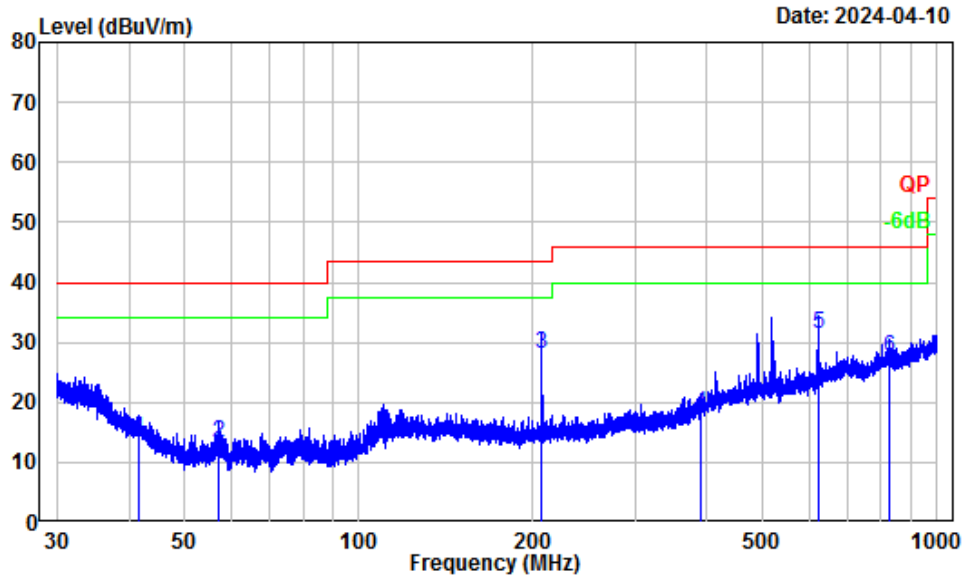

Site : Chamber A  
 Condition : 3m Vertical  
 Project Number: SZ1240220-08465E-RF  
 Note : GFSK  
 Tester : Anson Su

	Freq Factor		Read Level		Limit Line	Over Limit	Remark
	MHz	dB/m	dBuV	dBuV/m	dBuV/m	dB	
1	41.57	-12.78	26.52	13.74	40.00	-26.26	QP
2	57.22	-17.55	30.81	13.26	40.00	-26.74	QP
3	207.30	-12.23	40.38	28.15	43.50	-15.35	QP
4	391.24	-8.02	26.27	18.25	46.00	-27.75	QP
5	622.34	-3.74	35.18	31.44	46.00	-14.56	QP
6	829.67	-0.33	27.80	27.47	46.00	-18.53	QP

For Adapter GQ06-060040-ZU

30MHz-1GHz:

Horizontal

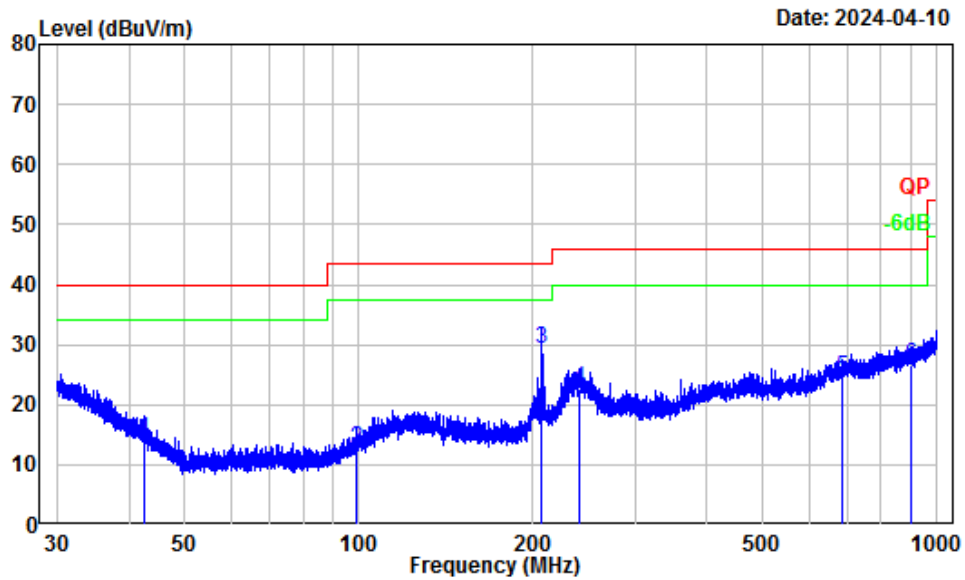

Site : Chamber A  
 Condition : 3m Horizontal  
 Project Number: SZ1240220-08465E-RF  
 Note : GFSK  
 Tester : Anson Su

	Freq Factor		Read Level		Limit	Over	Remark
	MHz	dB/m	dBuV	dBuV/m	Line	Limit	
1	42.51	-11.99	26.23	14.24	40.00	-25.76	QP
2	99.22	-13.95	26.53	12.58	43.50	-30.92	QP
3	207.21	-11.14	40.49	29.35	43.50	-14.15	QP
4	241.25	-11.71	34.49	22.78	46.00	-23.22	QP
5	686.55	-1.77	26.26	24.49	46.00	-21.51	QP
6	899.36	1.00	25.56	26.56	46.00	-19.44	QP

Vertical

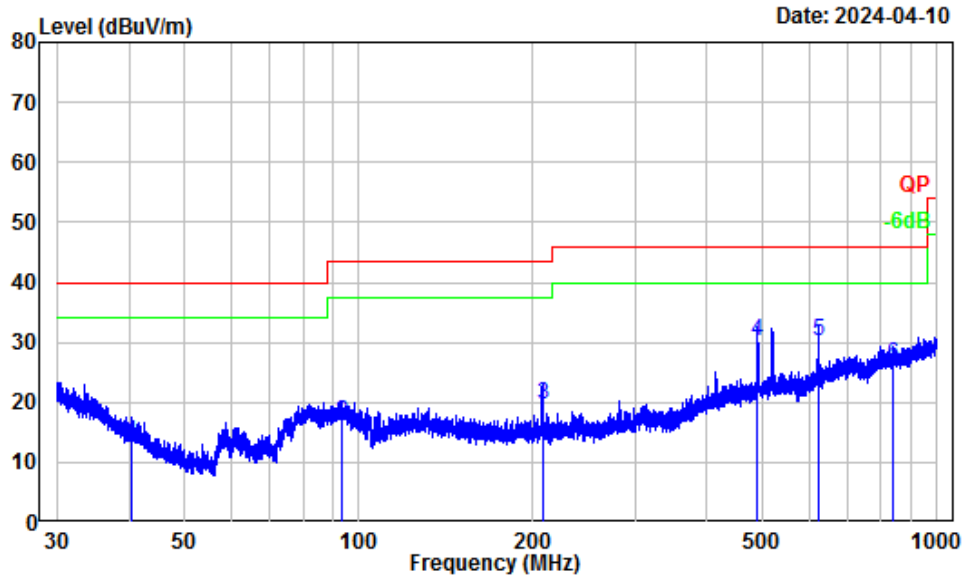

Site : Chamber A  
 Condition : 3m Vertical  
 Project Number: SZ1240220-08465E-RF  
 Note : GFSK  
 Tester : Anson Su

	Freq Factor		Read Level		Limit Line	Over Limit	Remark
	MHz	dB/m	dBuV	dBuV/m	dBuV/m	dB	
1	40.47	-12.15	25.52	13.37	40.00	-26.63	QP
2	93.73	-16.56	33.13	16.57	43.50	-26.93	QP
3	207.58	-12.23	31.93	19.70	43.50	-23.80	QP
4	489.67	-5.43	35.54	30.11	46.00	-15.89	QP
5	622.34	-3.74	33.81	30.07	46.00	-15.93	QP
6	840.29	-0.22	26.54	26.32	46.00	-19.68	QP

**Above 1GHz:**

**ANT 0**

Frequency (MHz)	Receiver		Polar (H/V)	Factor (dB/m)	Corrected Amplitude (dBµV/m)	Limit (dBµV/m)	Margin (dB)
	Reading (dBµV)	PK/Ave					
Low Channel							
1921.54	116.64	PK	H	-6.39	110.25	/	/
1921.54	114.58	PK	V	-6.39	108.19	/	/
3843.08	58.02	PK	H	-0.78	57.24	74	-16.76
3843.08	61.35	PK	V	-0.78	60.57	74	-13.43
Middle Channel							
1924.99	116.52	PK	H	-6.39	110.13	/	/
1924.99	114.23	PK	V	-6.39	107.84	/	/
3849.98	57.59	PK	H	-0.79	56.80	74	-17.20
3849.98	60.21	PK	V	-0.79	59.42	74	-14.58
High Channel							
1928.45	116.33	PK	H	-6.39	109.94	/	/
1928.45	114.43	PK	V	-6.39	108.04	/	/
3856.90	57.57	PK	H	-0.74	56.83	74	-17.17
3856.90	61.39	PK	V	-0.74	60.65	74	-13.35

Field Strength of Average							
Frequency (MHz)	Peak Measurement @3m (dBµV/m)	Polar (H/V)	Duty Cycle Correction Factor (dB)	Corrected Amplitude (dBµV/m)	Limit (dBµV/m)	Margin (dB)	Comment
Low channel							
1921.54	110.25	H	-28.18	82.07	/	/	Fundamental
1921.54	108.19	V	-28.18	80.01	/	/	Fundamental
3843.08	57.24	H	-28.18	29.06	54	-24.94	Harmonic
3843.08	60.57	V	-28.18	32.39	54	-21.61	Harmonic
Middle channel							
1924.99	110.13	H	-28.18	81.95	/	/	Fundamental
1924.99	107.84	V	-28.18	79.66	/	/	Fundamental
3849.98	56.80	H	-28.18	28.62	54	-25.38	Harmonic
3849.98	59.42	V	-28.18	31.24	54	-22.76	Harmonic
High channel							
1928.45	109.94	H	-28.18	81.76	/	/	Fundamental
1928.45	108.04	V	-28.18	79.86	/	/	Fundamental
3856.90	56.83	H	-28.18	28.65	54	-25.35	Harmonic
3856.90	60.65	V	-28.18	32.47	54	-21.53	Harmonic

Note:

Corrected Amplitude = Corrected Factor + Reading

Corrected Factor=Antenna factor (RX)+cable loss – amplifier factor

Margin = Corr. Amplitude- Limit

All other spurious emission are noise floor which are not recorded.

Duty cycle:

Ton =0.39ms

Tp = 10 .02ms

Duty cycle = Ton/Tp = 0.39/10.02=0.039

Duty Cycle Corrected Factor = 20lg (Duty cycle) = 20lg0.039 = -28.18



**ANT1**

Frequency (MHz)	Receiver		Polar (H/V)	Factor (dB/m)	Corrected Amplitude (dBµV/m)	Limit (dBµV/m)	Margin (dB)
	Reading (dBµV)	PK/Ave					
Low Channel							
1921.54	112.55	PK	H	-6.39	106.16	/	/
1921.54	117.99	PK	V	-6.39	111.60	/	/
3843.08	57.09	PK	H	-0.78	56.31	74	-17.69
3843.08	60.55	PK	V	-0.78	59.77	74	-14.23
Middle Channel							
1924.99	112.68	PK	H	-6.39	106.29	/	/
1924.99	117.98	PK	V	-6.39	111.59	/	/
3849.98	56.69	PK	H	-0.79	55.90	74	-18.10
3849.98	60.62	PK	V	-0.79	59.83	74	-14.17
High Channel							
1928.45	112.61	PK	H	-6.39	106.22	/	/
1928.45	118.01	PK	V	-6.39	111.62	/	/
3856.90	56.62	PK	H	-0.74	55.88	74	-18.12
3856.90	60.61	PK	V	-0.74	59.87	74	-14.13

Field Strength of Average							
Frequency (MHz)	Peak Measurement @3m (dBµV/m)	Polar (H/V)	Duty Cycle Correction Factor (dB)	Corrected Amplitude (dBµV/m)	Limit (dBµV/m)	Margin (dB)	Comment
Low Channel							
1921.54	106.16	H	-28.18	77.98	/	/	Fundamental
1921.54	111.60	V	-28.18	83.42	/	/	Fundamental
3843.08	56.31	H	-28.18	28.13	54	-25.87	Harmonic
3843.08	59.77	V	-28.18	31.59	54	-22.41	Harmonic
Middle Channel							
1924.99	106.29	H	-28.18	78.11	/	/	Fundamental
1924.99	111.59	V	-28.18	83.41	/	/	Fundamental
3849.98	55.90	H	-28.18	27.72	54	-26.28	Harmonic
3849.98	59.83	V	-28.18	31.65	54	-22.35	Harmonic
High Channel							
1928.45	106.22	H	-28.18	78.04	/	/	Fundamental
1928.45	111.62	V	-28.18	83.44	/	/	Fundamental
3856.90	55.88	H	-28.18	27.70	54	-26.30	Harmonic
3856.90	59.87	V	-28.18	31.69	54	-22.31	Harmonic

Note:

Corrected Amplitude = Corrected Factor + Reading

Corrected Factor=Antenna factor (RX)+cable loss – amplifier factor

Margin = Corr. Amplitude- Limit

All other spurious emission are noise floor which are not recorded.

Duty cycle:

Ton =0.39ms

Tp = 10.02ms

Duty cycle = Ton/Tp = 0.39/10.02=0.039

Duty Cycle Corrected Factor = 20lg (Duty cycle) = 20lg0.039 = -28.18

### Duty cycle

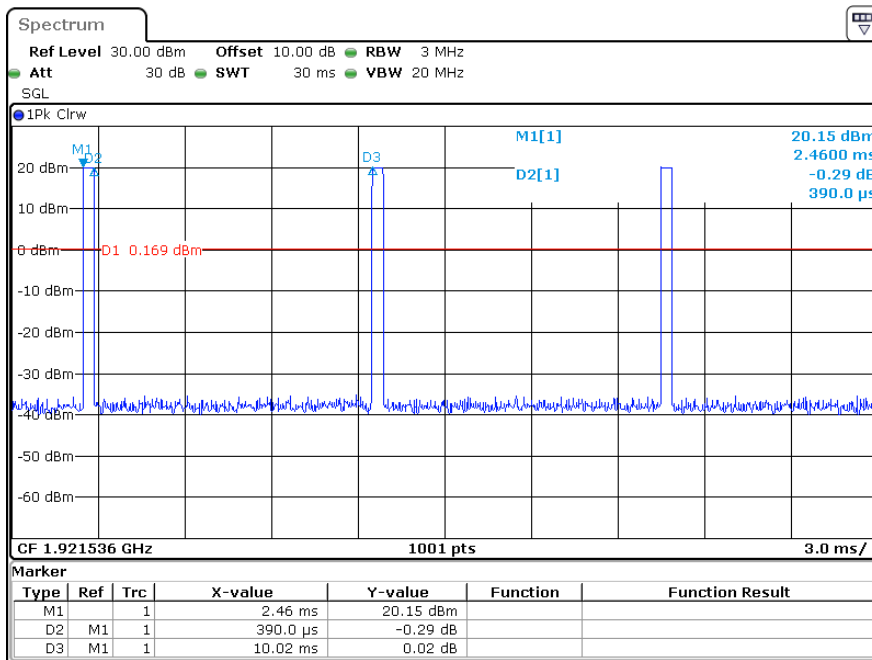

ProjectNo.:SZ1240220-08465E-RF Tester:Hanic Pan  
 Date: 12.MAR.2024 14:18:55

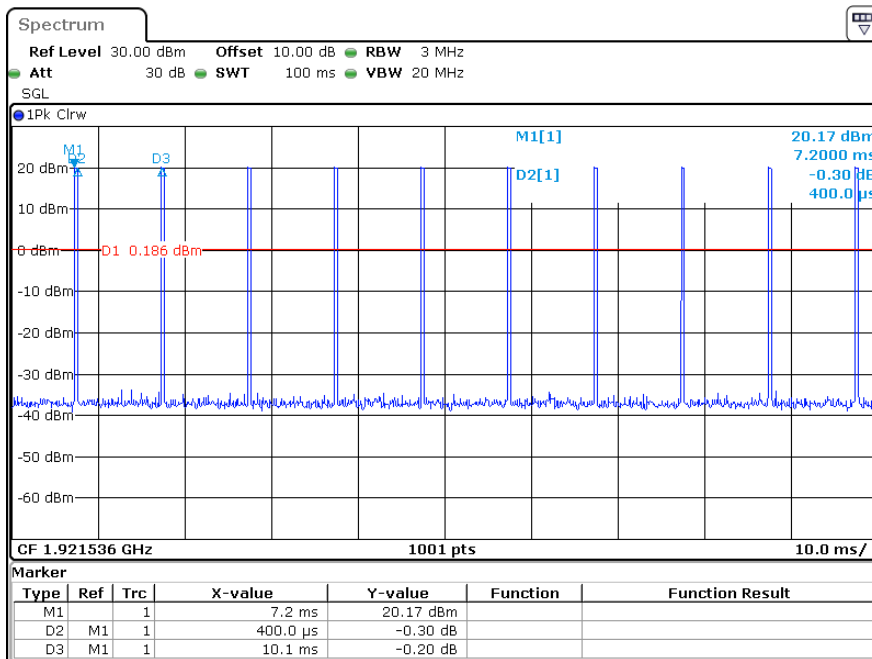

ProjectNo.:SZ1240220-08465E-RF Tester:Hanic Pan  
 Date: 12.MAR.2024 14:19:13

**Test plots:**

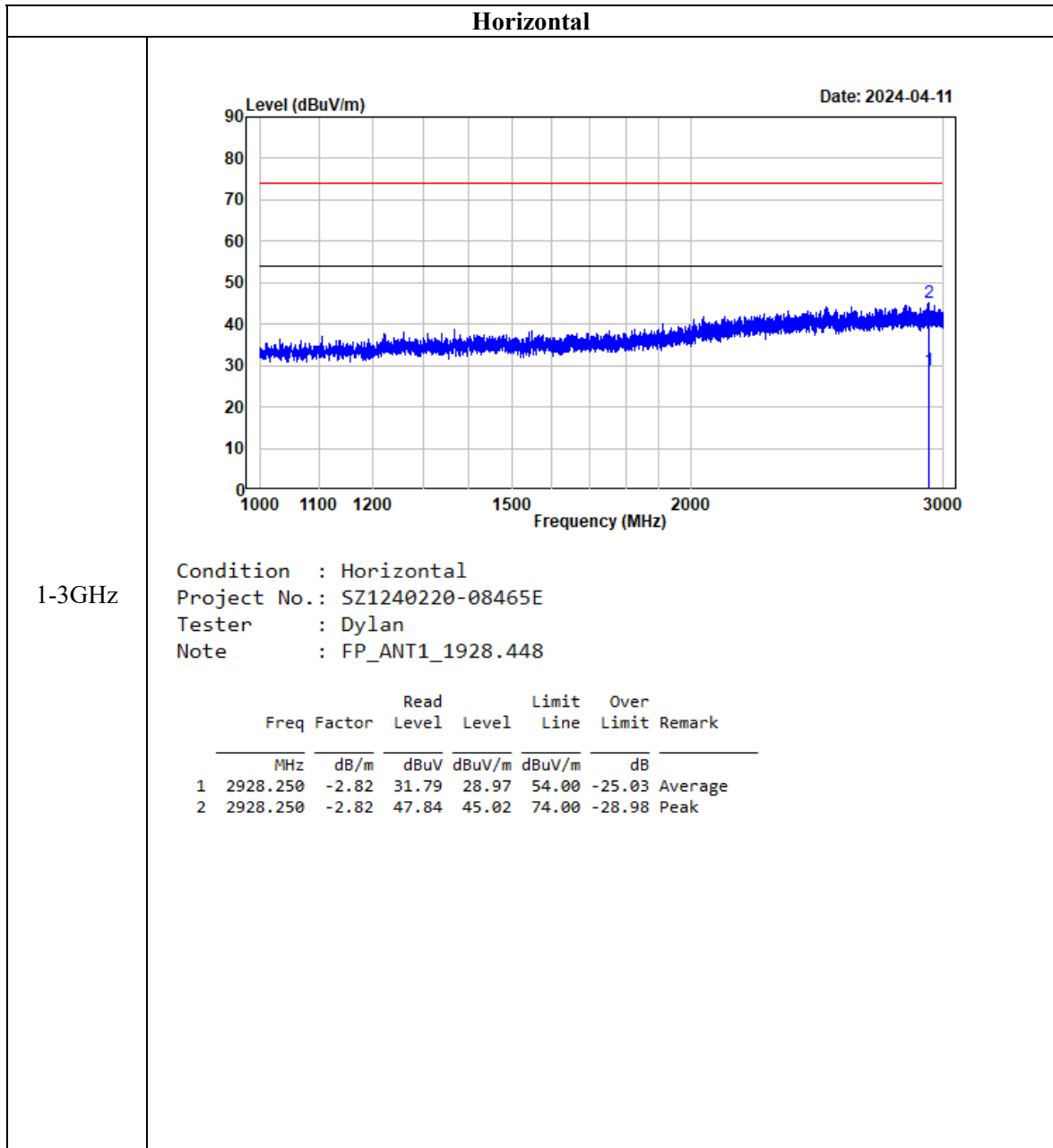

**Vertical**

1-3GHz

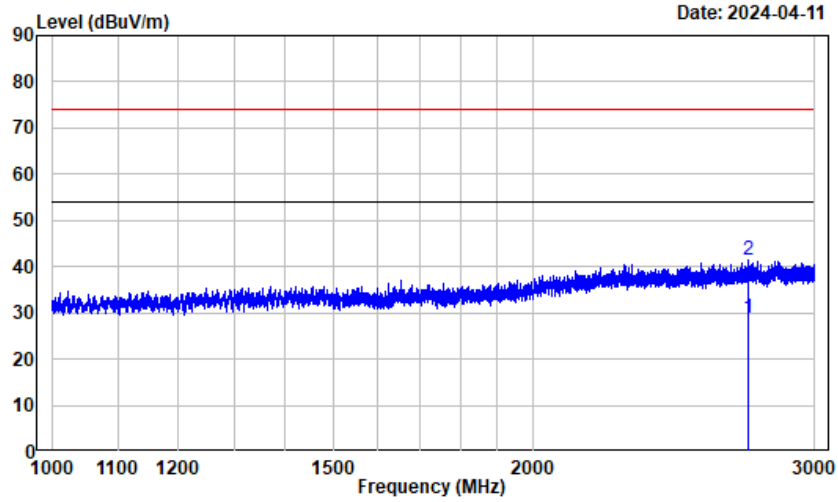

Condition : Vertical  
 Project No.: SZ1240220-08465E  
 Tester : Dylan  
 Note : FP\_ANT1\_1928.448

	Freq	Factor	Read Level	Read Level	Limit Line	Over Limit	Remark
	MHz	dB/m	dBuV	dBuV/m	dBuV/m	dB	
1	2724.250	-2.72	31.54	28.82	54.00	-25.18	Average
2	2724.250	-2.72	44.24	41.52	74.00	-32.48	Peak

**Horizontal**

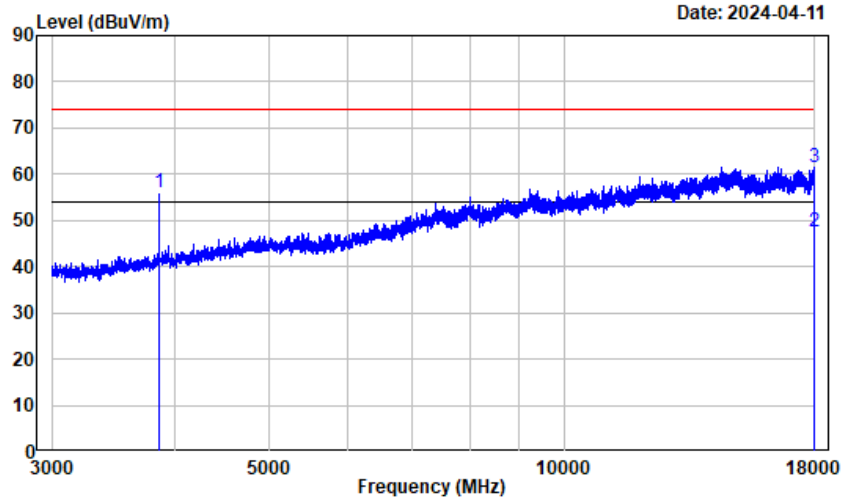

3-18GHz

Condition : Horizontal  
 Project No.: SZ1240220-08465E  
 Tester : Dylan  
 Note : FP\_ANT1\_1928.448

	Freq	Factor	Read Level	Level	Limit Line	Over Limit	Remark
	MHz	dB/m	dBuV	dBuV/m	dBuV/m	dB	
1	3856.900	-0.74	56.62	55.88	74.00	-18.12	Peak
2	17970.000	24.41	23.11	47.52	54.00	-6.48	Average
3	17970.000	24.41	37.20	61.61	74.00	-12.39	Peak

**Vertical**

3-18GHz

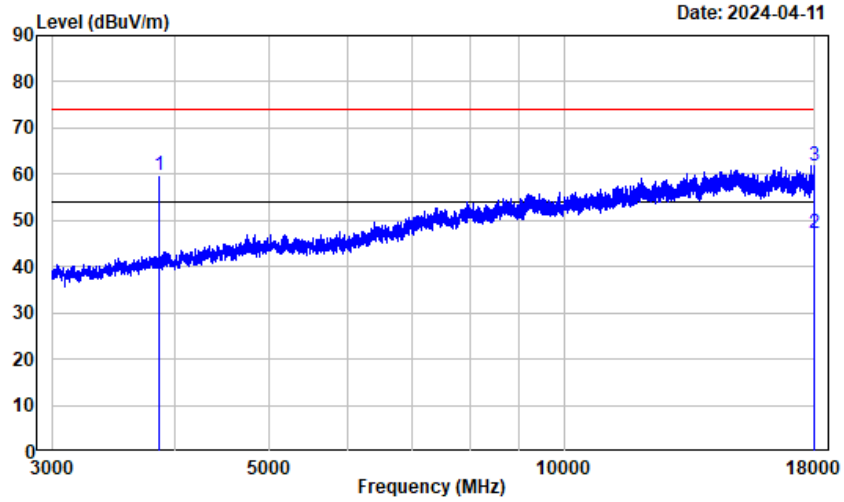

Date: 2024-04-11

Condition : Vertical  
 Project No.: SZ1240220-08465E  
 Tester : Dylan  
 Note : FP\_ANT1\_1928.448

	Freq	Factor	Read Level	Level	Limit Line	Over Limit	Remark
	MHz	dB/m	dBuV	dBuV/m	dBuV/m	dB	
1	3856.900	-0.74	60.61	59.87	74.00	-14.13	Peak
2	17977.500	24.45	22.80	47.25	54.00	-6.75	Average
3	17977.500	24.45	37.31	61.76	74.00	-12.24	Peak

**Horizontal**

18-20GHz

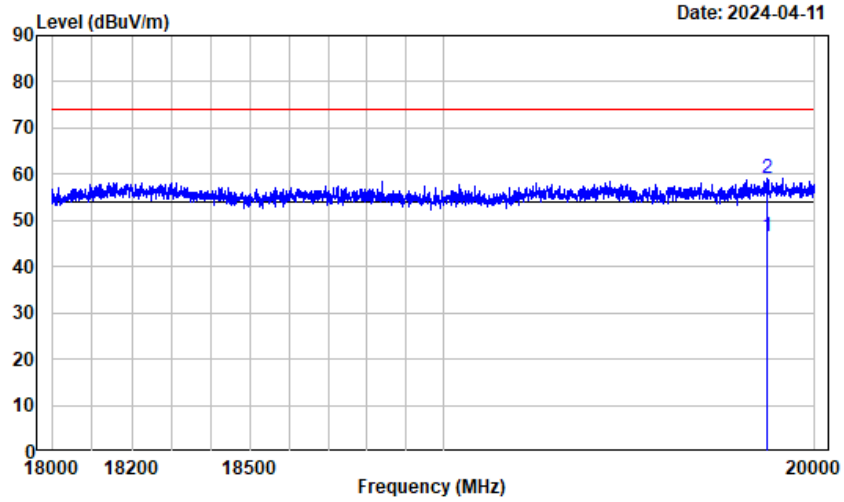

Condition : Horizontal  
 Project No.: SZ1240220-08465E  
 Tester : Dylan  
 Note : FP\_ANT1\_1928.448

	Read	Limit	Over				
Freq	Factor	Level	Level	Line			
MHz	dB/m	dBuV	dBuV/m	dBuV/m			
1	19869.000	13.85	32.67	46.52	54.00	-7.48	Average
2	19869.000	13.85	45.29	59.14	74.00	-14.86	Peak



**Vertical**

18-20GHz

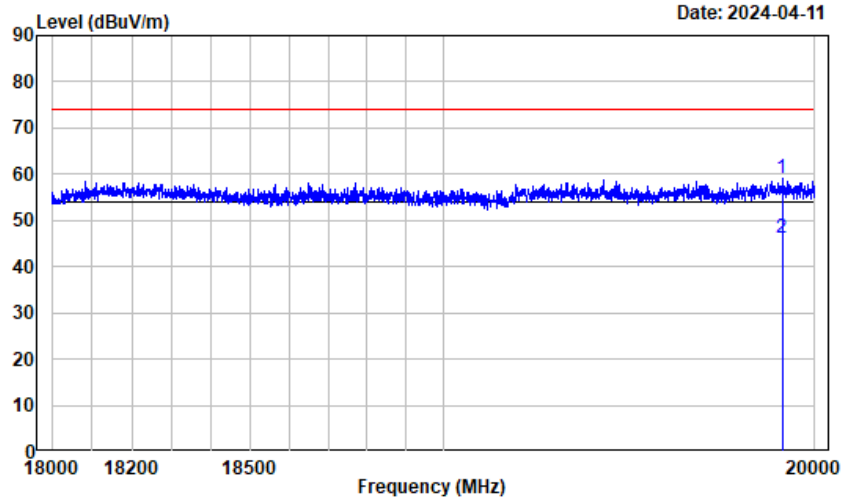

Date: 2024-04-11

Condition : Vertical  
 Project No.: SZ1240220-08465E  
 Tester : Dylan  
 Note : FP\_ANT1\_1928.448

	Read	Limit	Over			
Freq	Factor	Level	Level	Line	Limit Remark	
MHz	dB/m	dBuV	dBuV/m	dBuV/m	dB	
1	19910.130	13.83	45.40	59.23	74.00	-14.77 Peak
2	19910.130	13.83	32.41	46.24	54.00	-7.76 Average

## FCC§15.323 (a) - EMISSION BANDWIDTH

### Applicable Standard

Operation shall be contained within the 1920–1930 MHz band. The emission bandwidth shall be less than 2.5 MHz and greater than 50 kHz.

The emission bandwidth is measured in accordance with ANSI C63.17 sub-clause 6.1.3 using the setup below:

Test Setup 1:

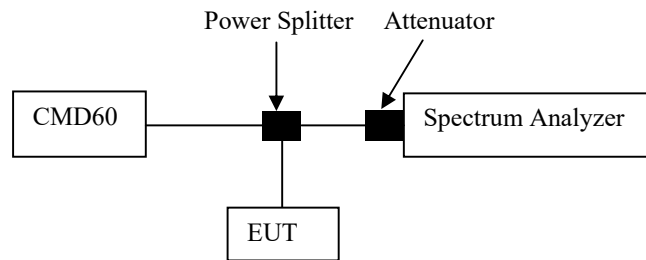

The width, in Hz, of the signal between two points, one below the carrier center frequency and one above the carrier center frequency, that is 26 dB down relative to the maximum level of the modulated carrier. It is based on the use of measurement instrumentation employing a peak detector function with an instrument resolution bandwidth approximately equal to 1% of the emission band-width of the device under measurement. [Extraction from 47 CFR 15, subpart D, 15.303 (C)].

### Test Procedure

Using the manufacturer’s information on occupied bandwidth set the spectrum analyzer as follows:

Resolution bandwidth	1.0% of the emission bandwidth (as close as possible)
Video bandwidth	>3 times the resolution bandwidth
Number of sweeps	sufficient to stability the trace
Detection mode	peak detection with maximum hold

### Test Data

#### Environmental Conditions

<b>Temperature:</b>	24.5 °C
<b>Relative Humidity:</b>	46 %
<b>ATM Pressure:</b>	101 kPa

*The testing was performed by Hanic Pan on 2024-03-12.*

*Test mode: Transmitting*

**Test Result: Compliant.** Please refer to the following table and plots.

Channel	Center Frequency (MHz)	99% Emission Bandwidth (MHz)	26 dB Emission Bandwidth (MHz)	Limit
Low	1921.536	1.211	1.465	50 kHz ~ 2.5 MHz
Middle	1924.992	1.217	1.465	50 kHz ~ 2.5 MHz
High	1928.448	1.241	1.443	50 kHz ~ 2.5 MHz

26 dB Emission Bandwidth

Low Channel

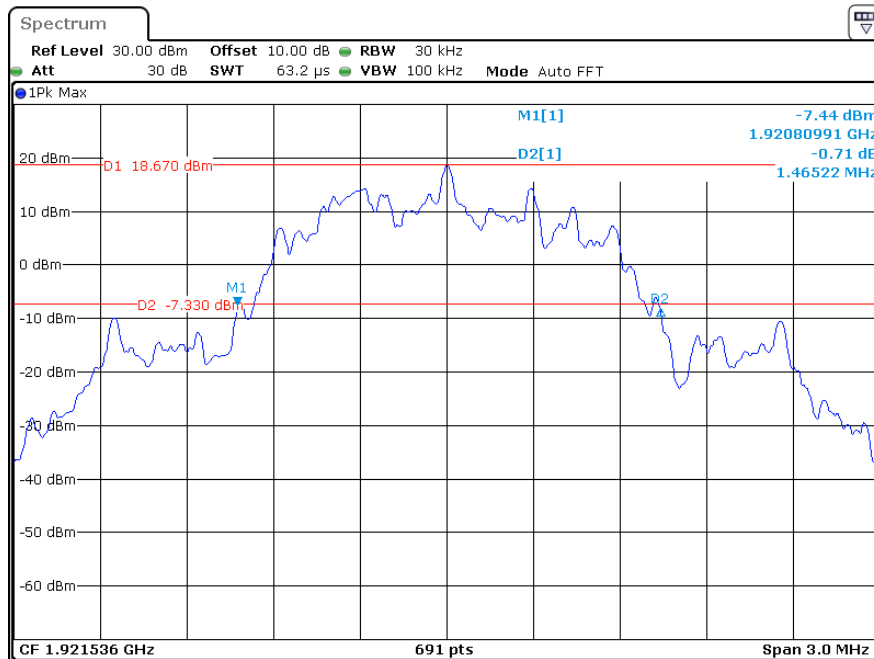

ProjectNo.:SZ1240220-08465E-RF Tester:Hanic Pan  
 Date: 12.MAR.2024 14:20:36

### Middle Channel



ProjectNo.:SZ1240220-08465E-RF Tester:Hanic Pan  
 Date: 12.MAR.2024 13:42:51

### High Channel

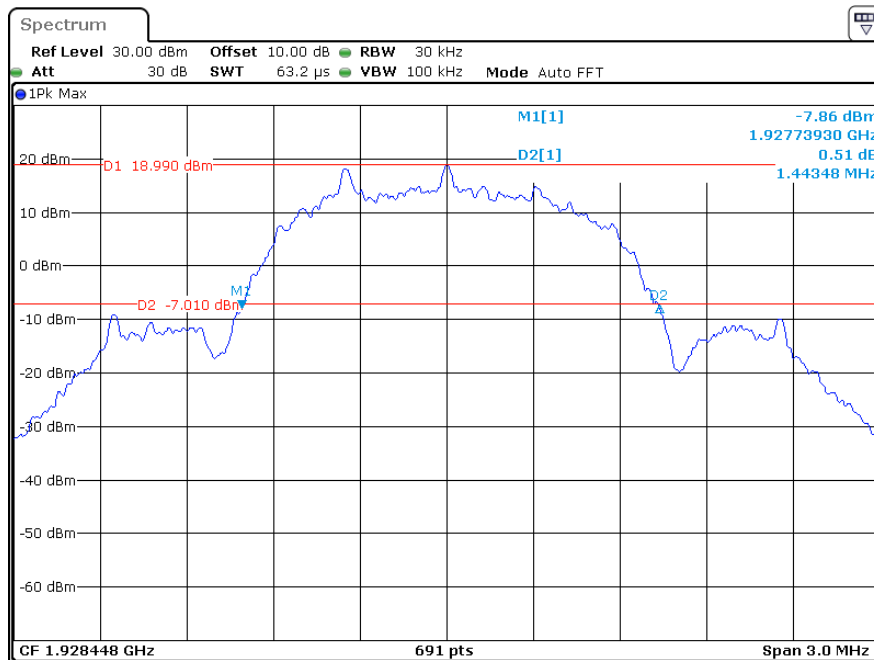

ProjectNo.:SZ1240220-08465E-RF Tester:Hanic Pan  
 Date: 12.MAR.2024 14:05:38

### 99% Emission Bandwidth

#### Low Channel

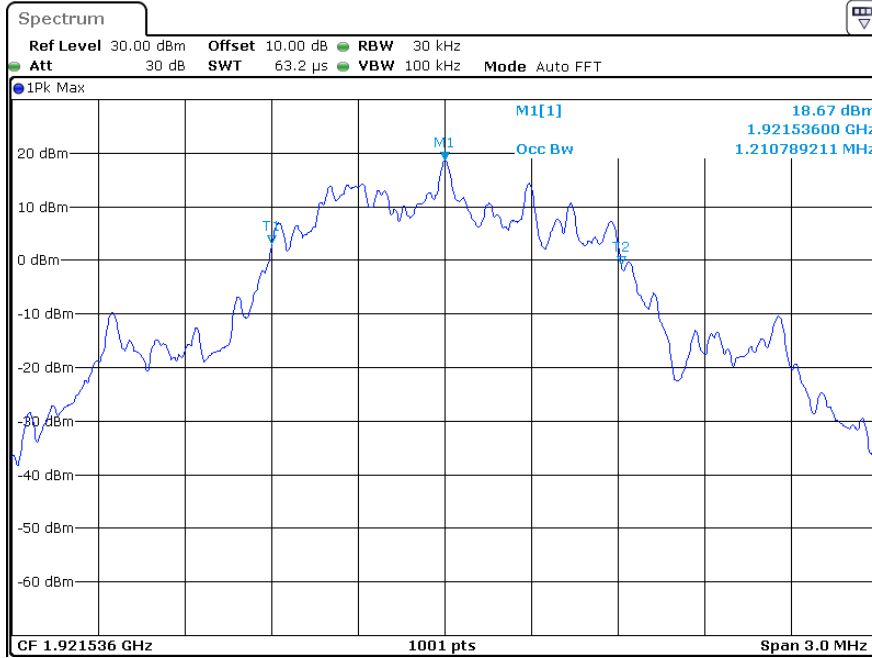

ProjectNo.:SZ1240220-08465E-RF Tester:Hanic Pan

Date: 12.MAR.2024 14:20:06

#### Middle Channel

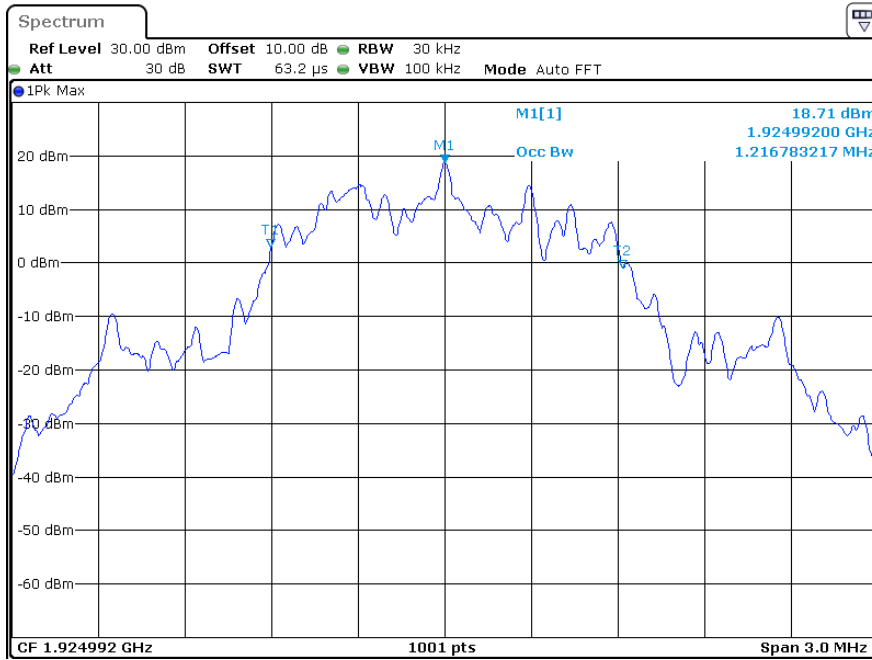

ProjectNo.:SZ1240220-08465E-RF Tester:Hanic Pan

Date: 12.MAR.2024 13:42:21

### High Channel

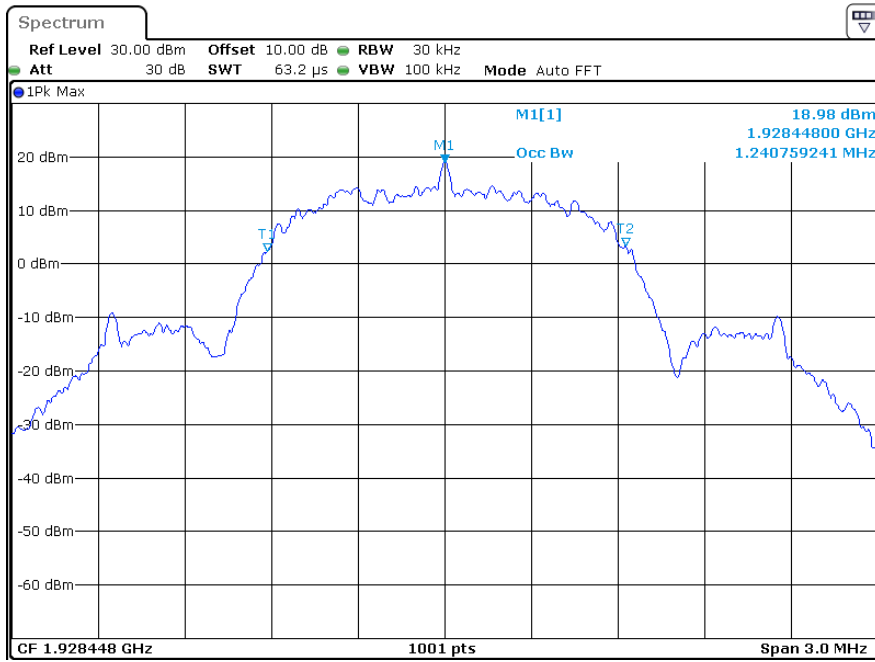

ProjectNo.:SZ1240220-08465E-RF    Tester:Hanic Pan  
Date: 12.MAR.2024 14:05:08

## FCC§15.319 (c) - PEAK TRANSMIT POWER

### Applicable Standard

The peak power output as measured over an interval of time equal to the frame rate or transmission burst of the device under all conditions of modulation. Usually this parameter is measured as a conducted emission by direct connection of a calibrated test instrument to the equipment under test. If the device cannot be connected directly, alternative techniques acceptable to the Commission may be used[47 CFR 15, subpart D, 15.303].

The peak transmit power is according to ANSI C63.17-2013 §6.1.2

Per FCC Part15.319 (c) Peak transmit power shall not exceed 100 microwatts multiplied by the square root of the emission bandwidth in hertz. Peak transmit power must be measured over any interval of continuous transmission using instrumentation calibrated in terms of an rms-equivalent voltage. The measurement results shall be properly adjusted for any instrument limitations, such as detector response times, limited resolution bandwidth capability when compared to the emission bandwidth, sensitivity, etc., so as to obtain a true peak measurement for the emission in question over the full bandwidth of the channel.

Per FCC Part15.319 (e), the peak transmit power shall be reduced by the amount in decibels that the maximum directional gain of the antenna exceeds 3 dBi.

Calculation of Peak Transmit Power Limit:

$$\text{Peak Transmit Power Limit} = 100\mu\text{W} \times (\text{EBW})^{1/2}$$

EBW is the transmit emission bandwidth in Hz determined in the other test item:

### Test Procedure

Using the manufacturer’s information on occupied bandwidth set the spectrum analyzer as follows:

RBW	≥ Emission bandwidth
Video bandwidth	≥ RBW
Span	Zero
Center frequency	Nominal center frequency of channels
Amplitude scale	Log (linear may be used if analyzer has sufficient linear dynamic range and accuracy)
Detection	Peak detection
Trigger	Video
Sweep rate	Sufficiently rapid to permit the transmit pulse to be resolved accurately

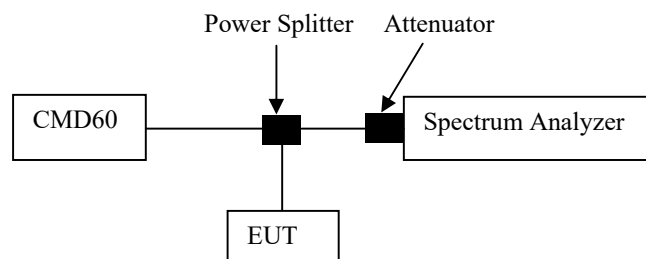

**Test Data**

**Environmental Conditions**

<b>Temperature:</b>	25 °C
<b>Relative Humidity:</b>	47 %
<b>ATM Pressure:</b>	101 kPa

The testing was performed by Hanic Pan on 2024-03-12.

Test mode: Transmitting

**Test Result: Compliant.** Please refer to the following table and plots.

Channel	Frequency (MHz)	Peak Transmit Power (dBm)	Limit (dBm)
ANT 0			
Low	1921.536	20.17	20.83
Middle	1924.992	20.29	20.83
High	1928.448	20.55	20.80
ANT 1			
Low	1921.536	20.42	20.83
Middle	1924.992	20.55	20.83
High	1928.448	20.45	20.80
EBW <sub>Low channel</sub> = 1465000Hz, EBW <sub>Middle channel</sub> = 1465000 Hz, EBW <sub>High channel</sub> = 1443000 Hz Peak Transmit Power Limit = 100(EBW) <sup>1/2</sup> μW			



ANT 0

Low Channel

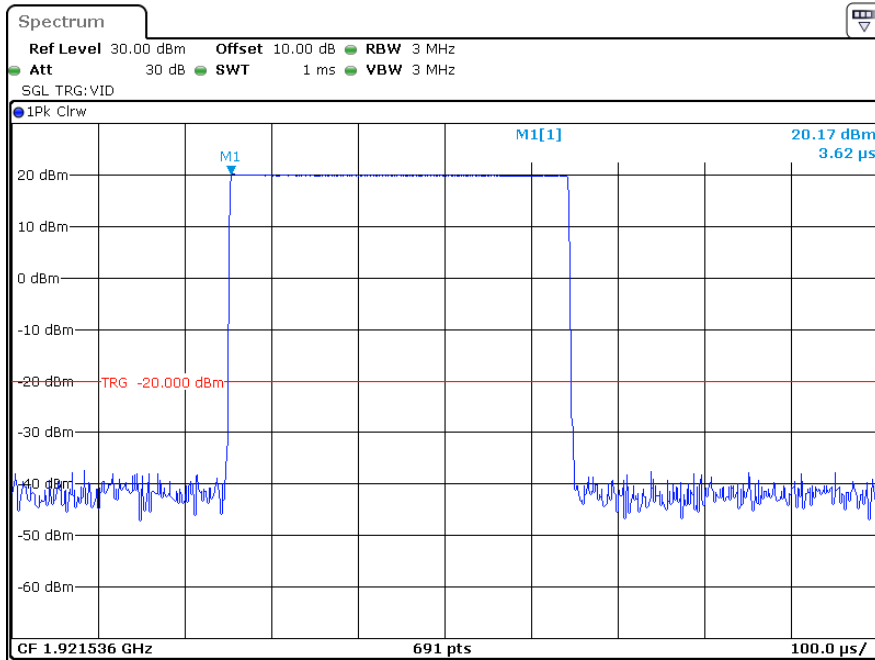

ProjectNo.:SZ1240220-08465E-RF Tester:Hanic Pan  
Date: 12.MAR.2024 14:18:10

Middle Channel

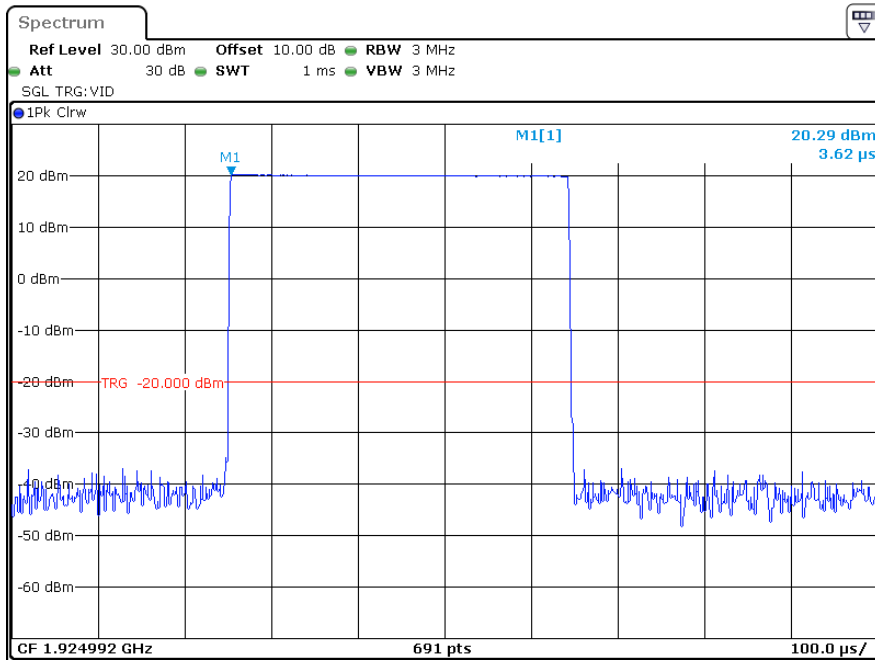

ProjectNo.:SZ1240220-08465E-RF Tester:Hanic Pan  
Date: 12.MAR.2024 13:34:54

### High Channel

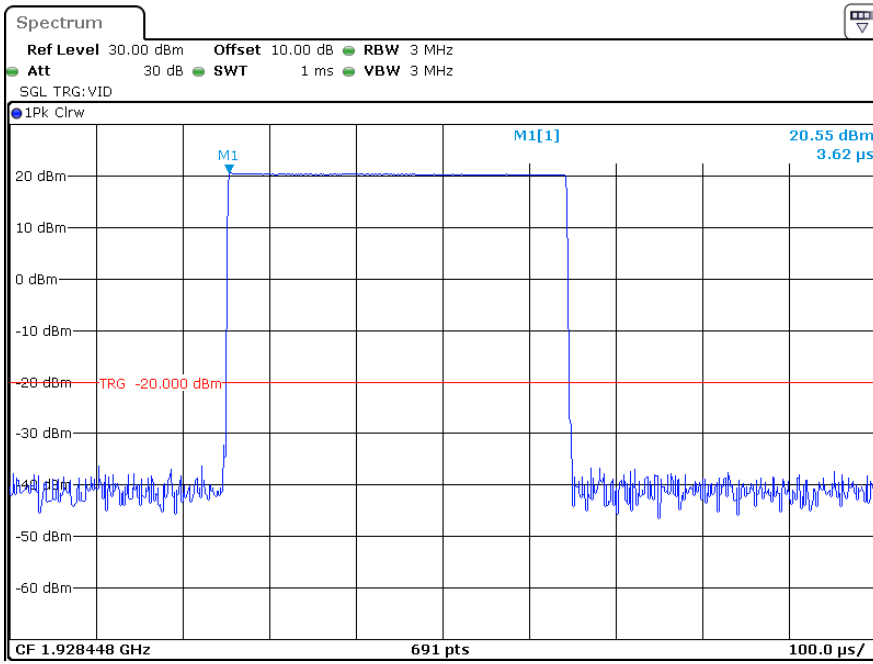

ProjectNo.:SZ1240220-08465E-RF    Tester:Hanic Pan  
Date: 12.MAR.2024 14:07:46

ANT 1

Low Channel

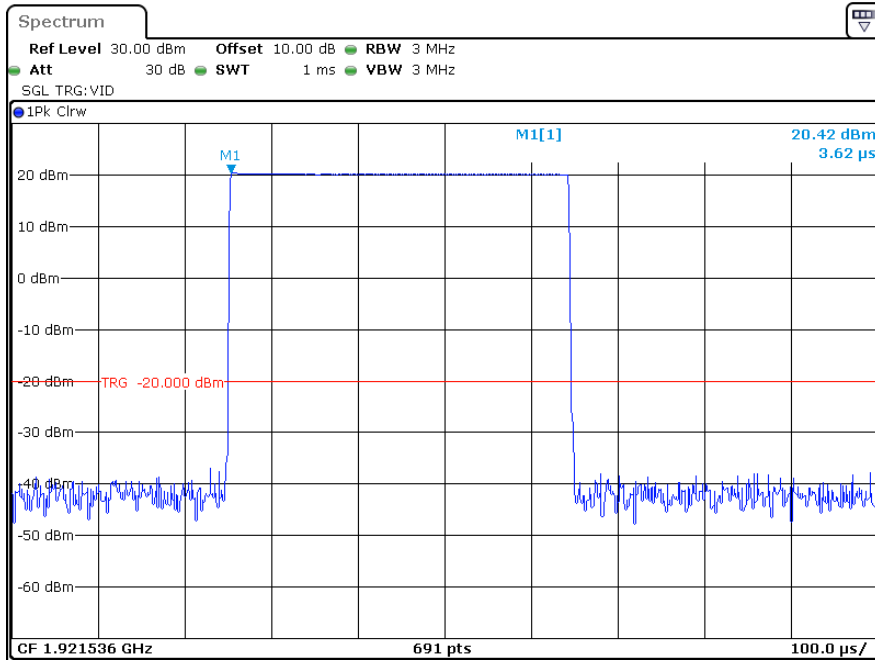

ProjectNo.:SZ1240220-08465E-RF Tester:Hanic Pan  
Date: 12.MAR.2024 16:53:08

Middle Channel

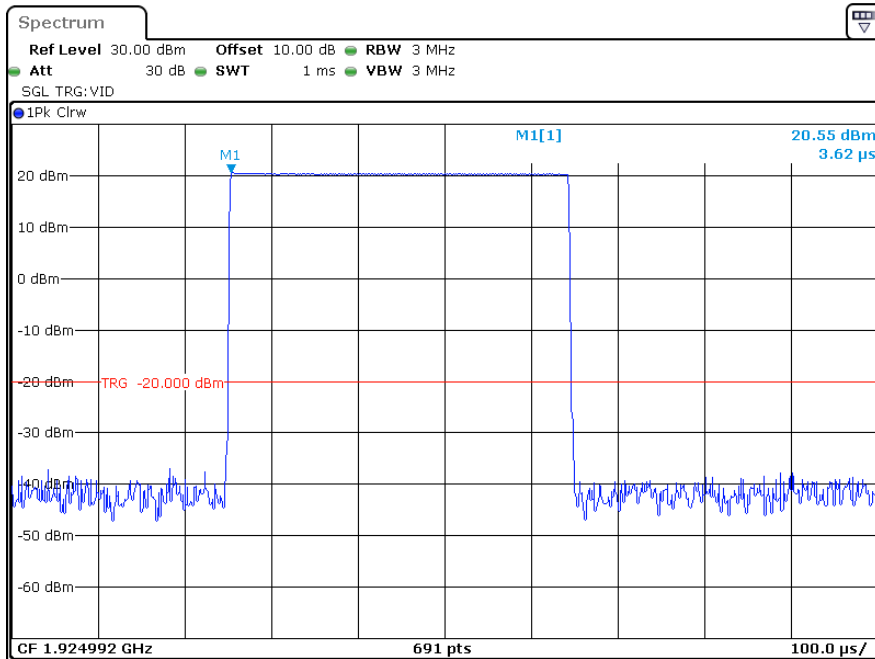

ProjectNo.:SZ1240220-08465E-RF Tester:Hanic Pan  
Date: 12.MAR.2024 16:52:27

### High Channel

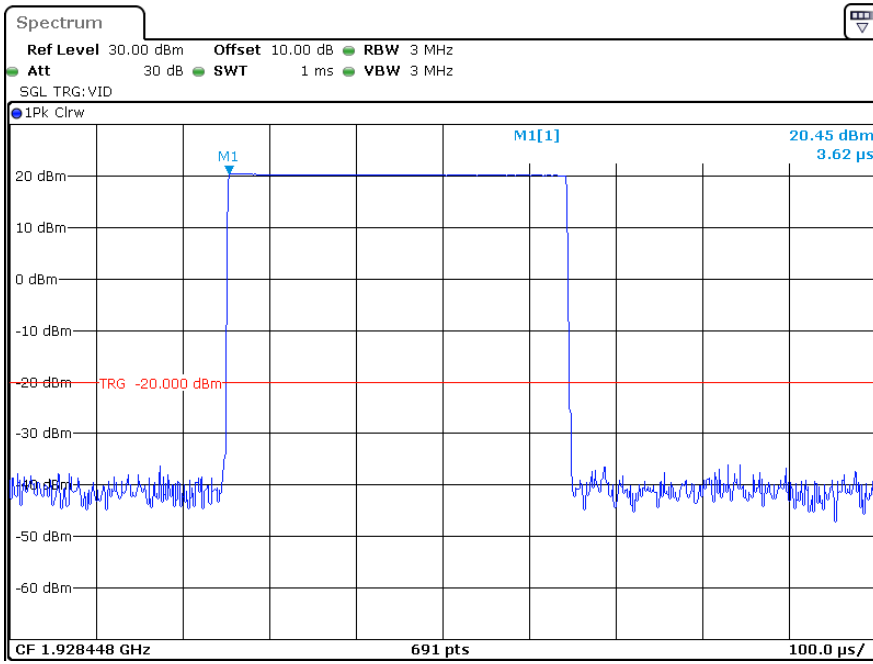

ProjectNo.:SZ1240220-08465E-RF    Tester:Hanic Pan  
Date: 12.MAR.2024 16:51:39

## FCC§15.319 (d) - POWER SPECTRAL DENSITY

### Applicable Standard

The average pulse energy in a 3 kHz bandwidth is divided by the pulse duration.

The power spectral density shall not exceed 3mW in any 3 kHz bandwidth as measured with a spectrum analyzer having a resolution bandwidth of 3 kHz.

The power spectral density is measured in accordance with ANSI C63.17.2013 Clause 6.1.5.

### Test Procedure

Using the manufacturer’s information on occupied bandwidth set the spectrum analyzer as follows:

RBW	3 kHz
Video bandwidth	$\geq 3 \times \text{RBW}$
Span	Zero span at frequency with the maximum level (frequency determined in 6.1.3 if the same type of signal (continuous versus burst) was used in 6.1.3)
Center frequency	Spectral peak as determined in 6.1.3
Sweep time	For burst signals, sufficient to include essentially all of the maximum length burst at the output of a 3 kHz filter (e.g., maximum input burst duration plus 600 $\mu\text{s}$ ). For continuous signals, 20 ms.
Amplitude scale	Log power
Detection	Sample detection and averaged for a minimum of 100 sweeps
Trigger	External or internal

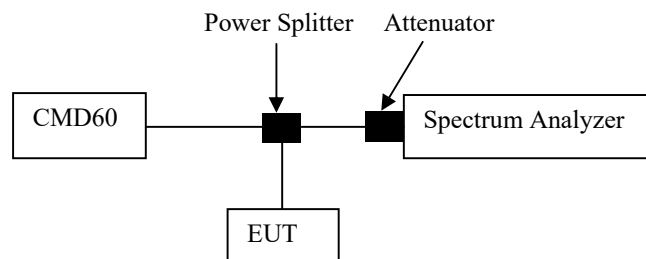

### Test Data

#### Environmental Conditions

<b>Temperature:</b>	28 °C
<b>Relative Humidity:</b>	54 %
<b>ATM Pressure:</b>	101 kPa

The testing was performed by Cheeb on 2024-04-15.

Test mode: Transmitting

**Test Result: Compliant.** Please refer to following table and plots

Channel	Frequency (MHz)	Power Spectral Density		Limit (mW/3kHz)
		(dBm/3kHz)	(mW/3kHz)	
Low	1921.536	-3.06	0.494	3
Middle	1924.992	-2.34	0.583	3
High	1928.448	-2.93	0.509	3

### Low Channel

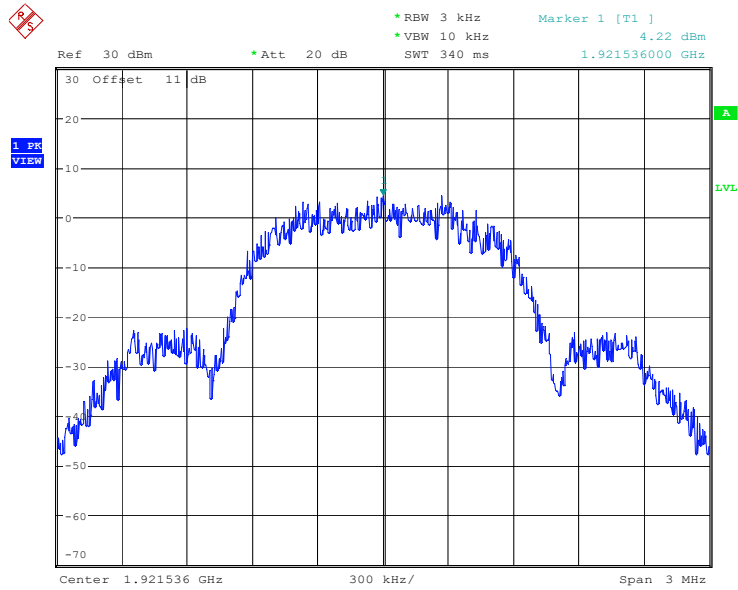

ProjectNo.:SZ1240220-08465E-RF Tester:Cheeb Huang  
Date: 15.APR.2024 02:29:33

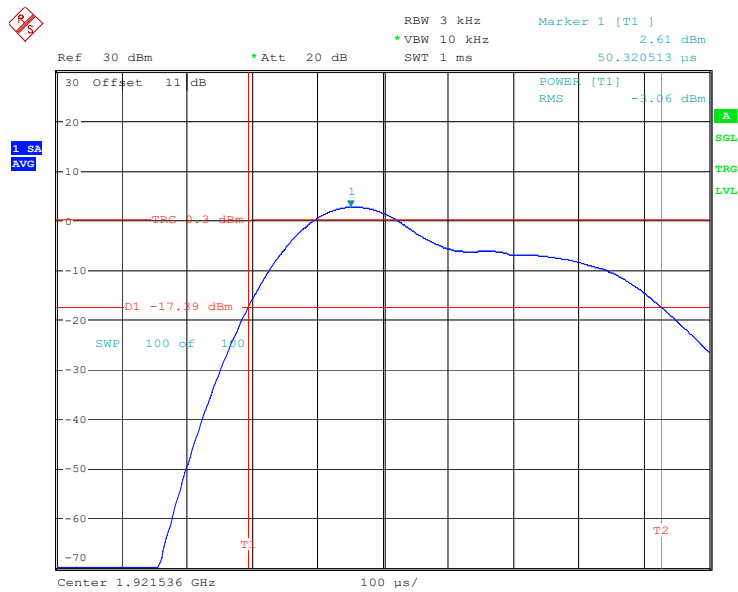

ProjectNo.:SZ1240220-08465E-RF Tester:Cheeb Huang  
Date: 15.APR.2024 02:34:51

### Middle Channel

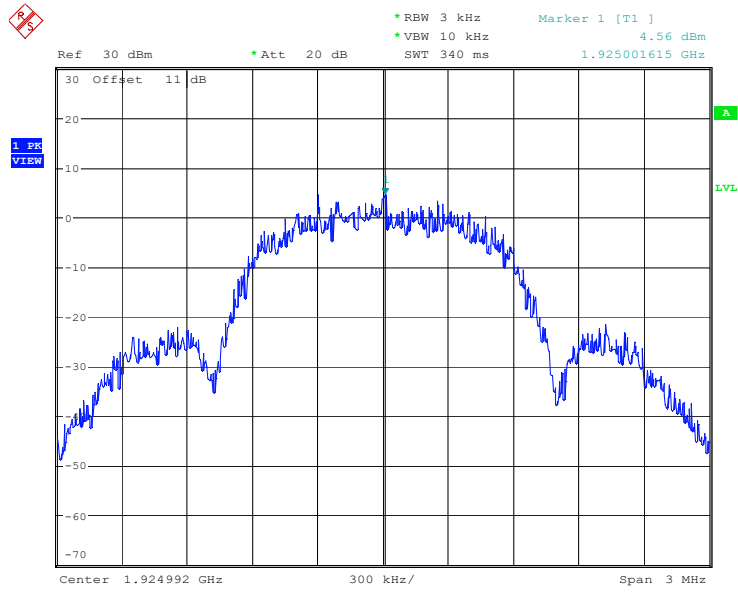

ProjectNo.:SZ1240220-08465E-RF    Tester:Cheeb Huang  
Date: 15.APR.2024    02:38:23

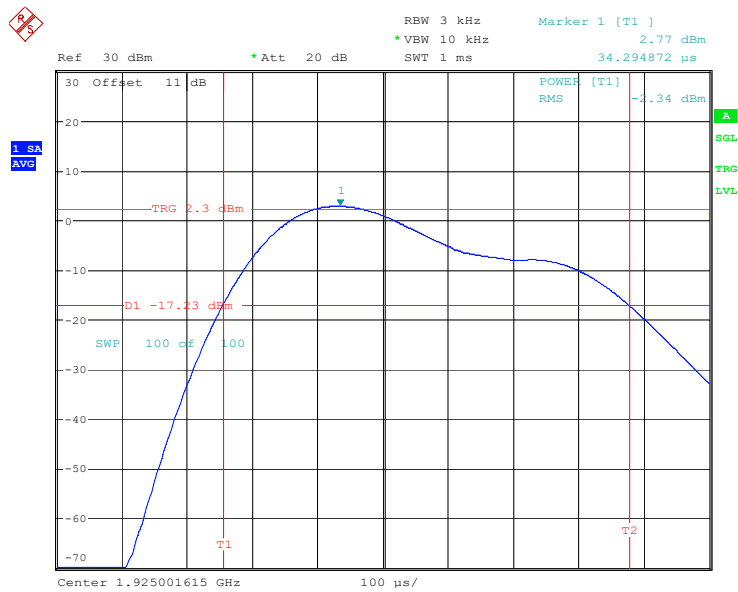

ProjectNo.:SZ1240220-08465E-RF    Tester:Cheeb Huang  
Date: 15.APR.2024    02:45:13



### High Channel

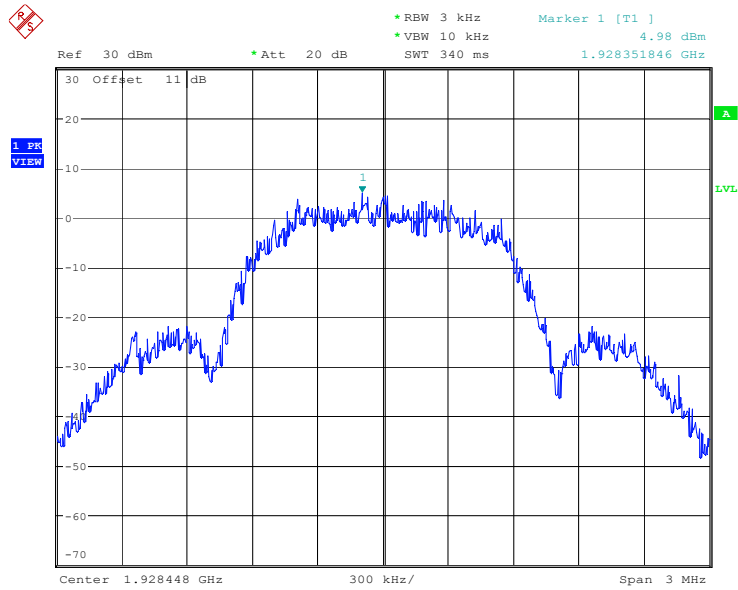

ProjectNo.:SZ1240220-08465E-RF Tester:Cheeb Huang  
Date: 15.APR.2024 02:50:55

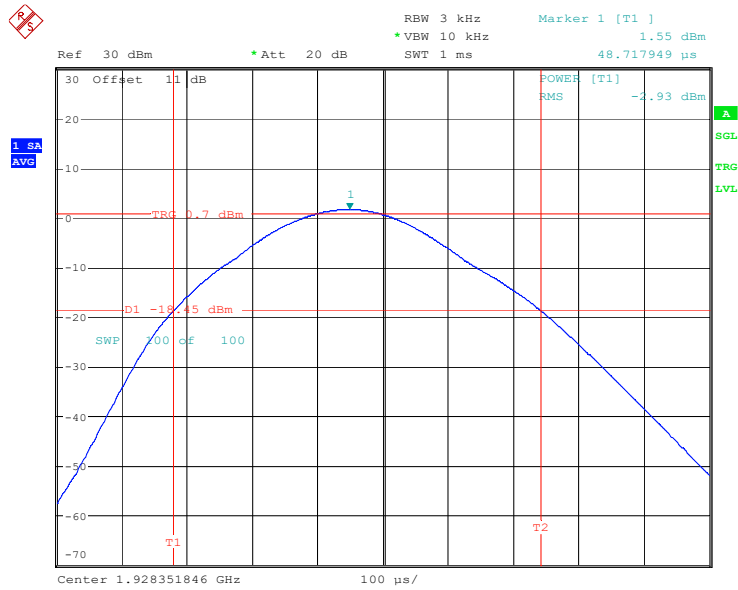

ProjectNo.:SZ1240220-08465E-RF Tester:Cheeb Huang  
Date: 15.APR.2024 02:56:14

**FCC§15.323 (d) - EMISSION INSIDE AND OUTSIDE THE SUB-BAND**

**Applicable Standard**

Emissions inside the sub-band must comply with the following emission mask:

1. In the bands between 1B and 2B measured from the center of the emission bandwidth the total power emitted by the device shall be at least 30 dB below the transmit power permitted for that device;
2. in the bands between 2B and 3B measured from the center of the emission bandwidth the total power emitted by an intentional radiator shall be at least 50 dB below the transmit power permitted for that radiator;
3. in the bands between 3B and the sub-band edge the total power emitted by an intentional radiator in the measurement bandwidth shall be at least 60 dB below the transmit power permitted for that radiator.

Where B = emission bandwidth

Emission Outside the sub-band shall be attenuated below a reference power of 112 mw (20.5 dBm) as follows:

1. 30 dB between the sub-band and 1.25 MHz above or below the sub-band;
2. 50 dB between 1.25 and 2.5 MHz above or below the sub-band;
3. 60 dB at 2.5 MHz or greater above or below the sub-band.

**Test Procedure**

According to ANSI C63.17-2013 Clause 6.1.6.

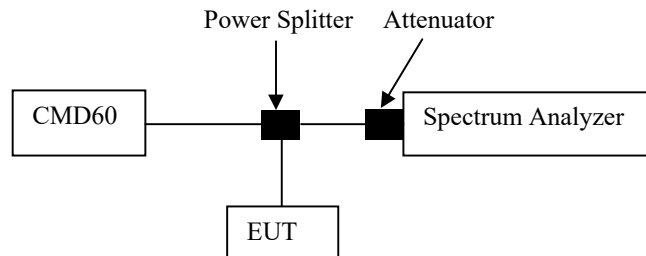

**Test Data**

**Environmental Conditions**

<b>Temperature:</b>	26~27 °C
<b>Relative Humidity:</b>	46~47 %
<b>ATM Pressure:</b>	101 kPa

*The testing was performed by Hanic Pan on 2024-03-12.*

*Test mode: Transmitting*

**Test Result: Compliant.** Please refer to following plots

### Low Channel (Unwanted Emission inside the Sub-band)



ProjectNo.:SZ1240220-08465E-RF Tester:Hanic Pan  
Date: 12.MAR.2024 14:24:54

### Middle Channel (Unwanted Emission inside the Sub-band)

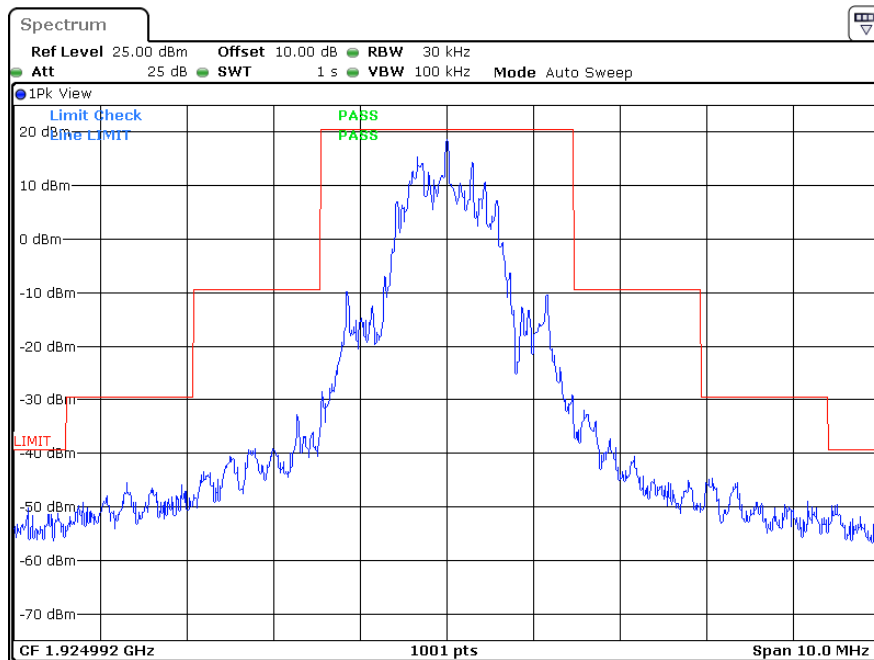

ProjectNo.:SZ1240220-08465E-RF Tester:Hanic Pan  
Date: 12.MAR.2024 13:37:08

### High Channel (Unwanted Emission inside the Sub-band)

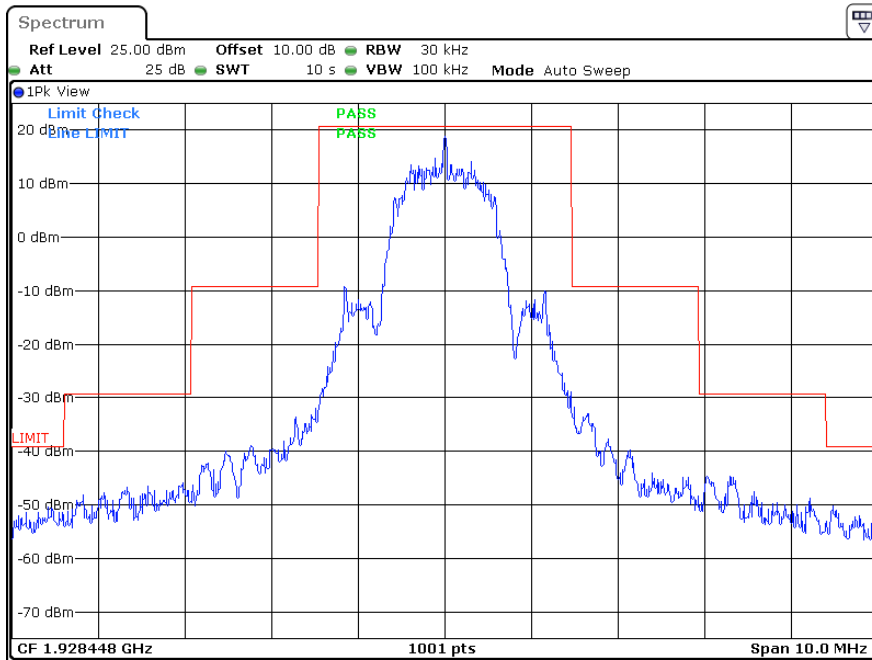

ProjectNo.:SZ1240220-08465E-RF Tester:Hanic Pan  
Date: 12.MAR.2024 14:10:32

### Low Channel (Unwanted Emission outside the Sub-band)

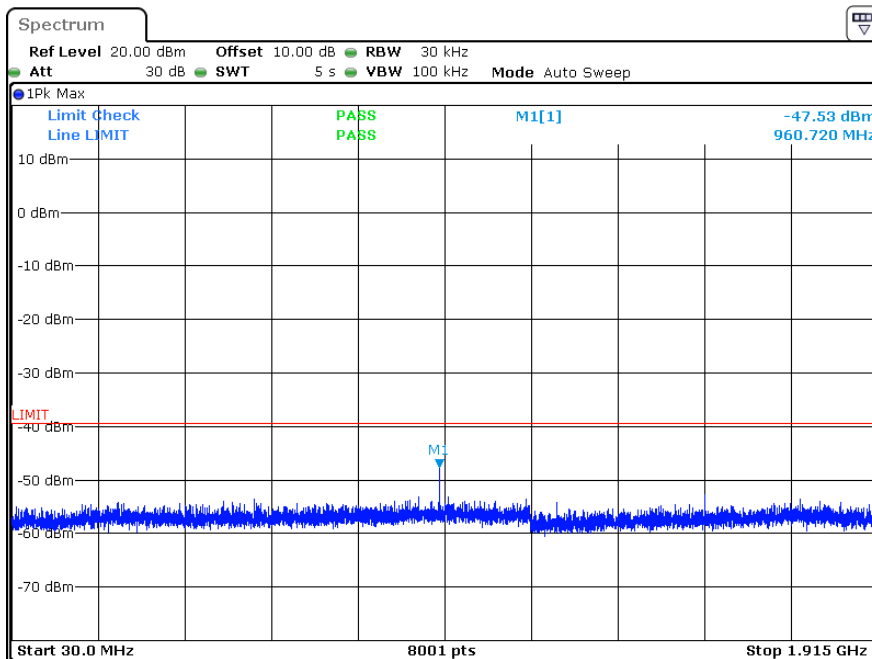

ProjectNo.:SZ1240220-08465E-RF Tester:Hanic Pan  
Date: 12.MAR.2024 14:25:35

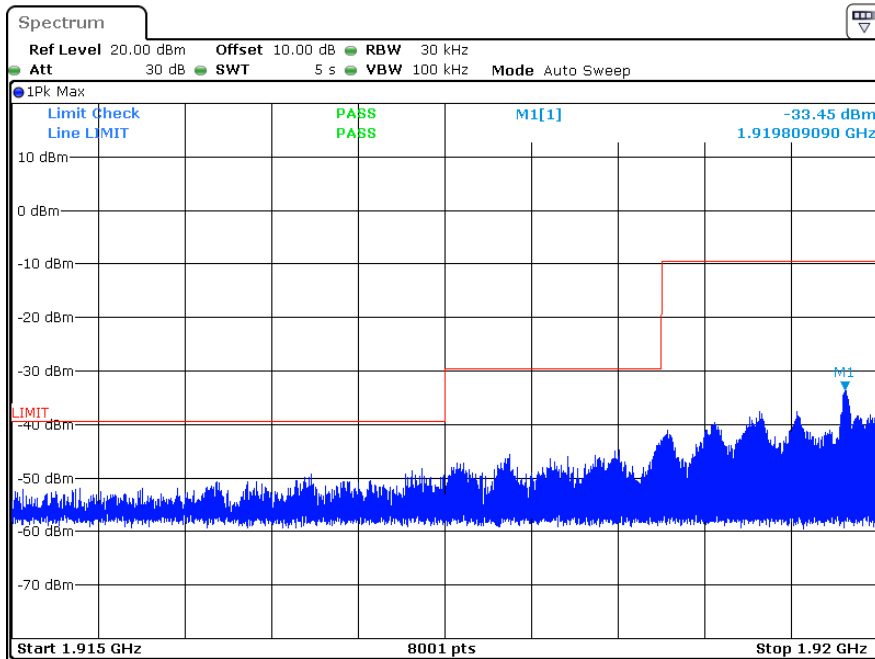

ProjectNo.:SZ1240220-08465E-RF Tester:Hanic Pan  
Date: 12.MAR.2024 14:26:17

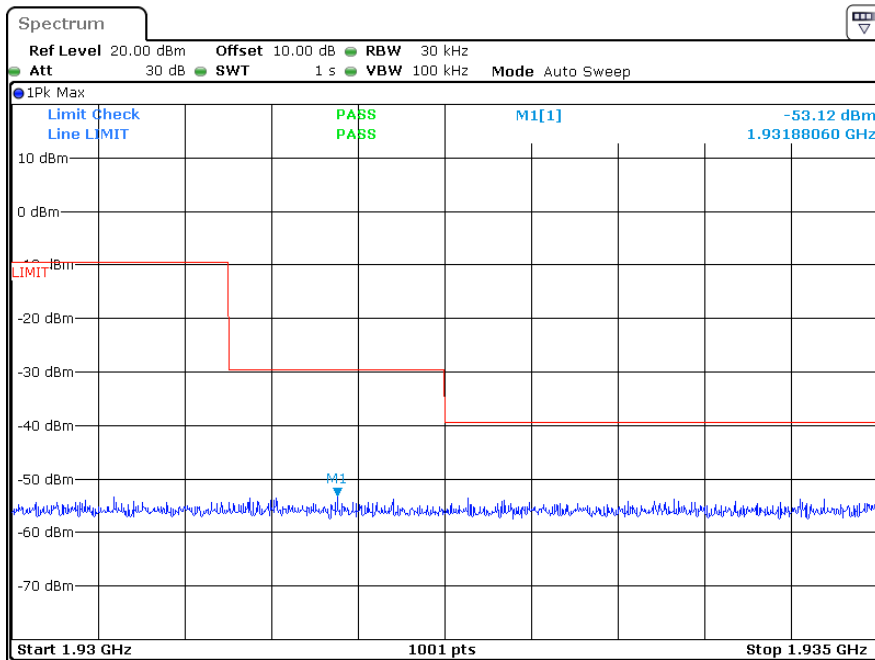

ProjectNo.:SZ1240220-08465E-RF Tester:Hanic Pan  
Date: 12.MAR.2024 14:26:52

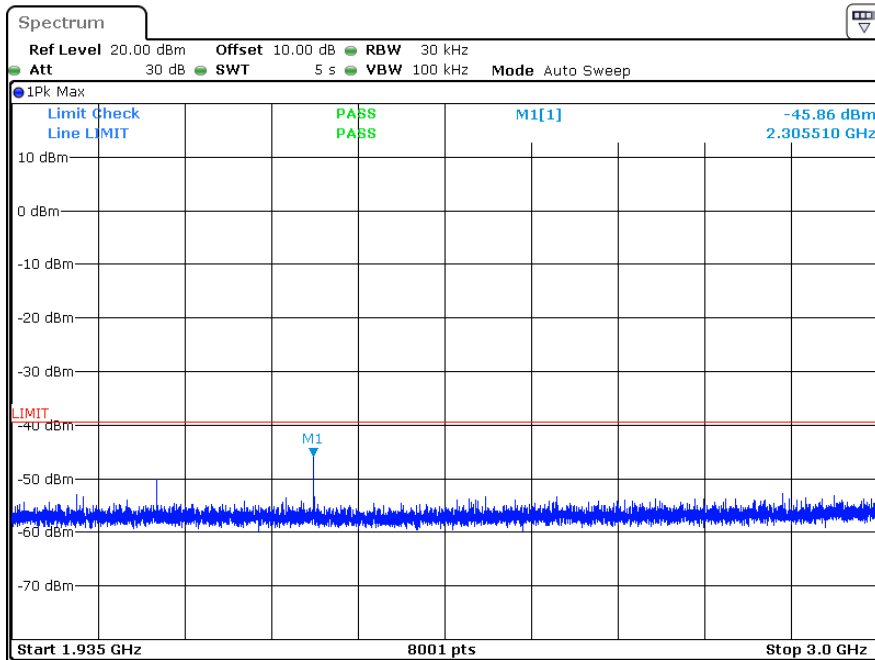

ProjectNo.:SZ1240220-08465E-RF Tester:Hanic Pan  
Date: 12.MAR.2024 14:27:34

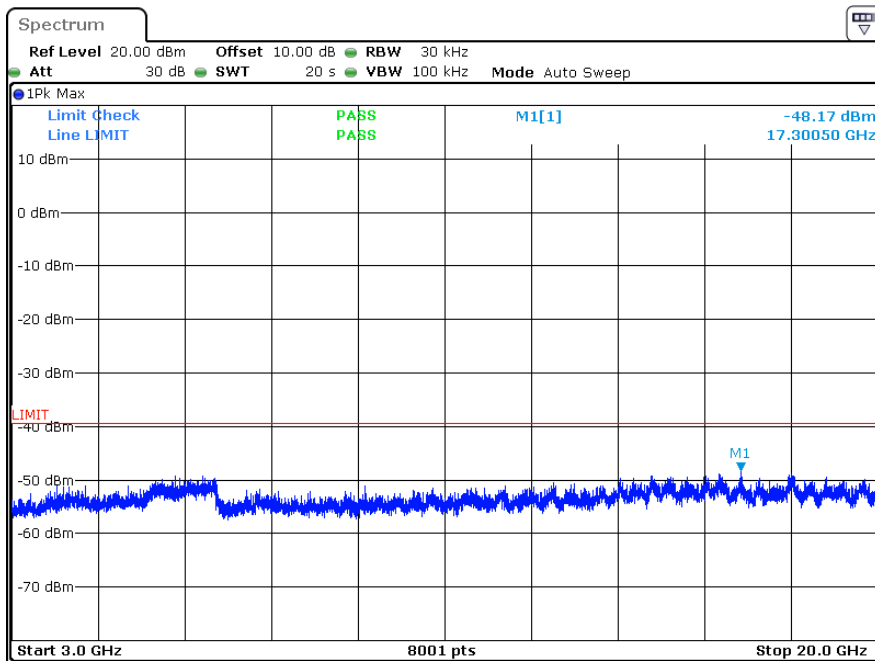

ProjectNo.:SZ1240220-08465E-RF Tester:Hanic Pan  
Date: 12.MAR.2024 14:28:36

Middle Channel (Unwanted Emission outside the Sub-band)

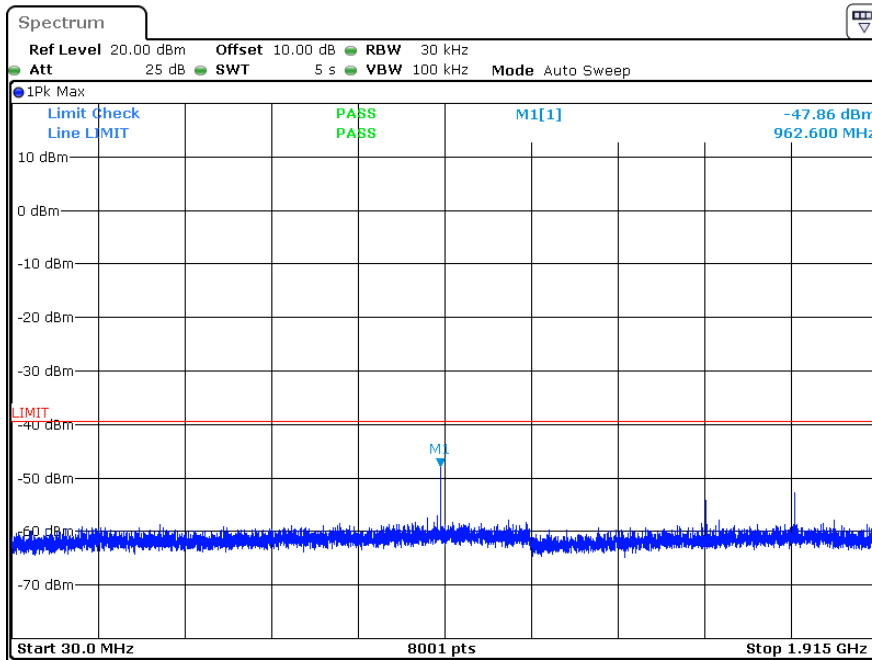

ProjectNo.:SZ1240220-08465E-RF Tester:Hanic Pan  
 Date: 12.MAR.2024 13:37:49

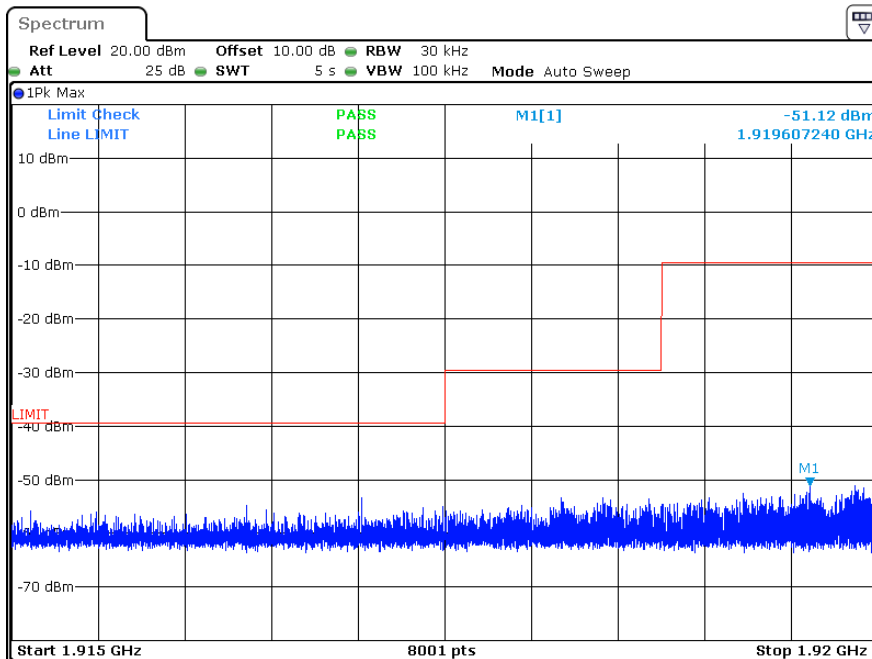

ProjectNo.:SZ1240220-08465E-RF Tester:Hanic Pan  
 Date: 12.MAR.2024 13:38:32

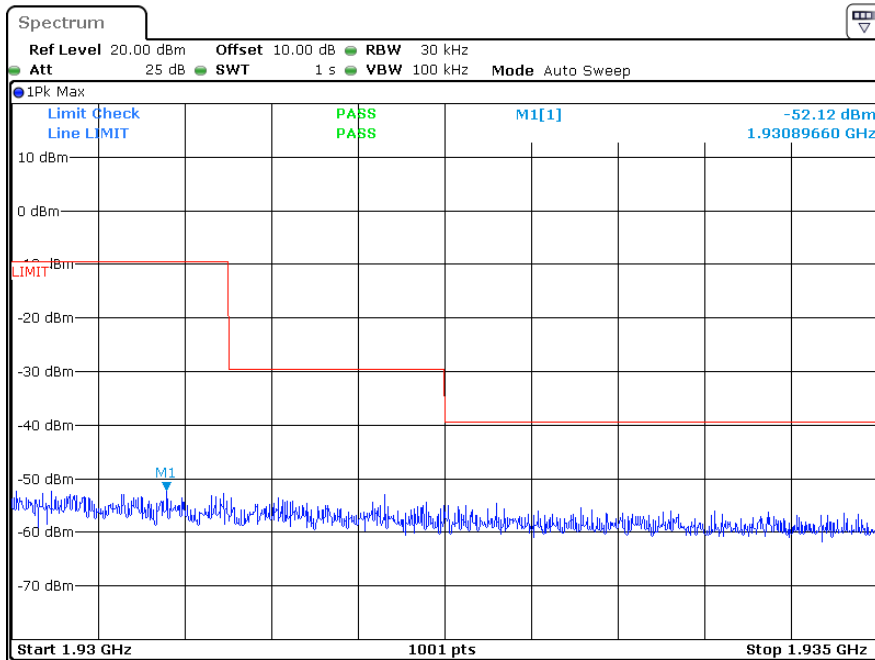

ProjectNo.:SZ1240220-08465E-RF Tester:Hanic Pan  
Date: 12.MAR.2024 13:39:06

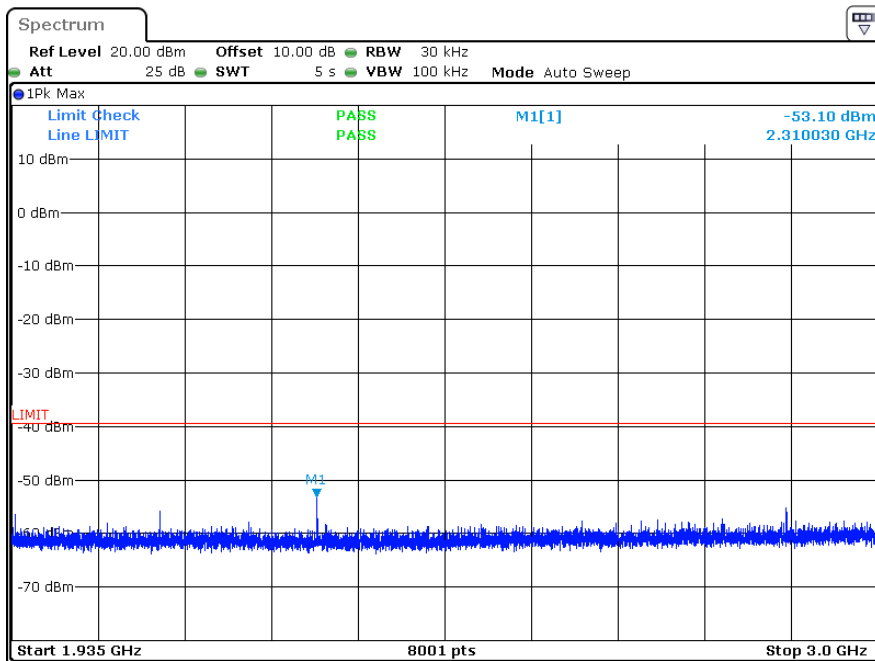

ProjectNo.:SZ1240220-08465E-RF Tester:Hanic Pan  
Date: 12.MAR.2024 13:39:49



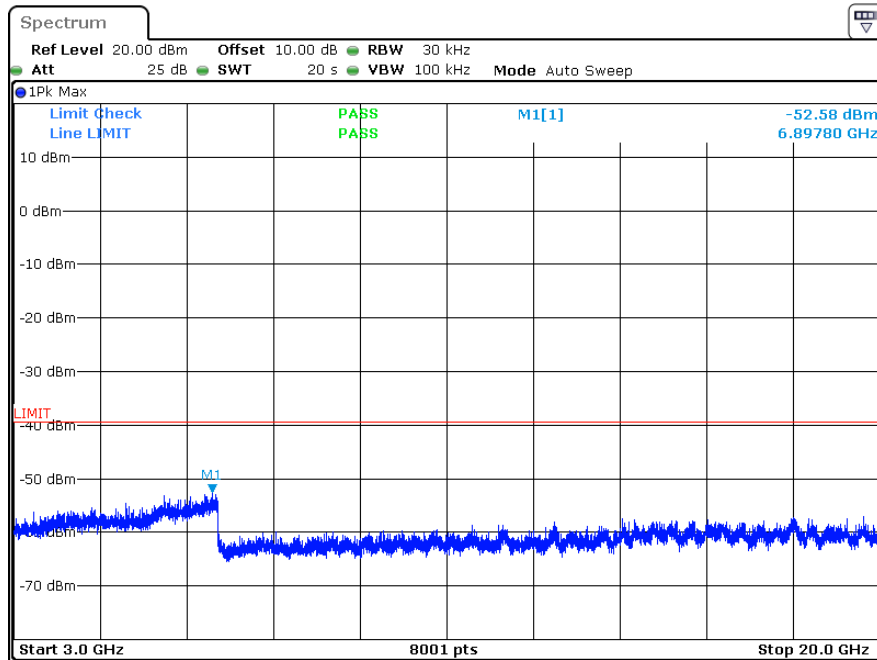

ProjectNo.:SZ1240220-08465E-RF Tester:Hanic Pan  
Date: 12.MAR.2024 13:40:50

### High Channel (Unwanted Emission outside the Sub-band)

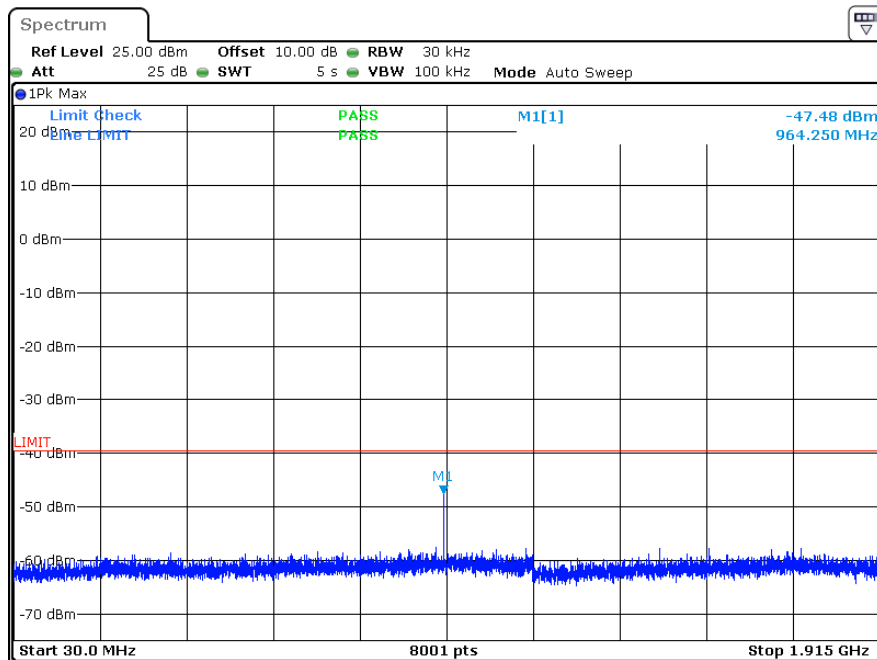

ProjectNo.:SZ1240220-08465E-RF Tester:Hanic Pan  
Date: 12.MAR.2024 14:11:15

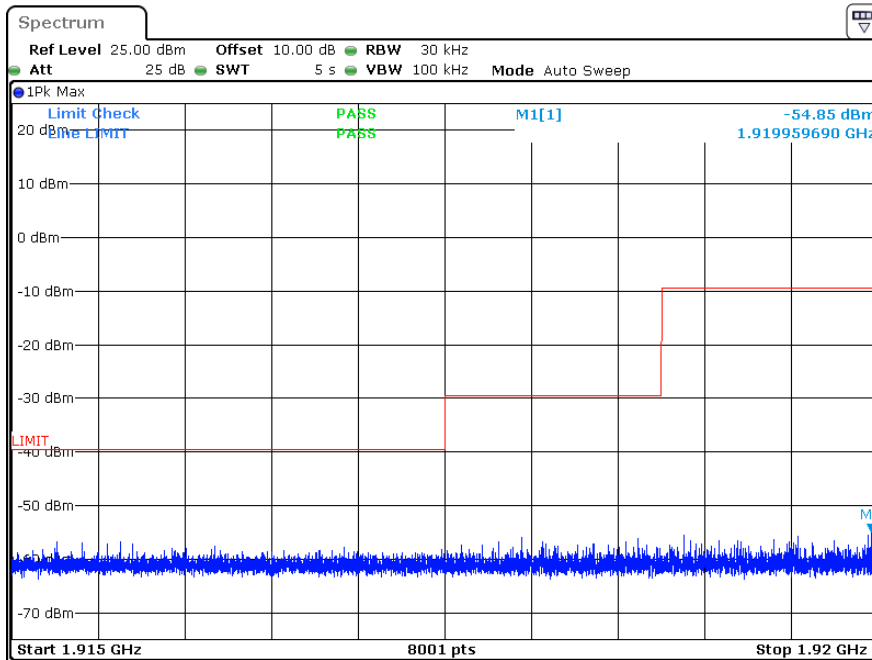

ProjectNo.:SZ1240220-08465E-RF Tester:Hanic Pan  
Date: 12.MAR.2024 14:11:56

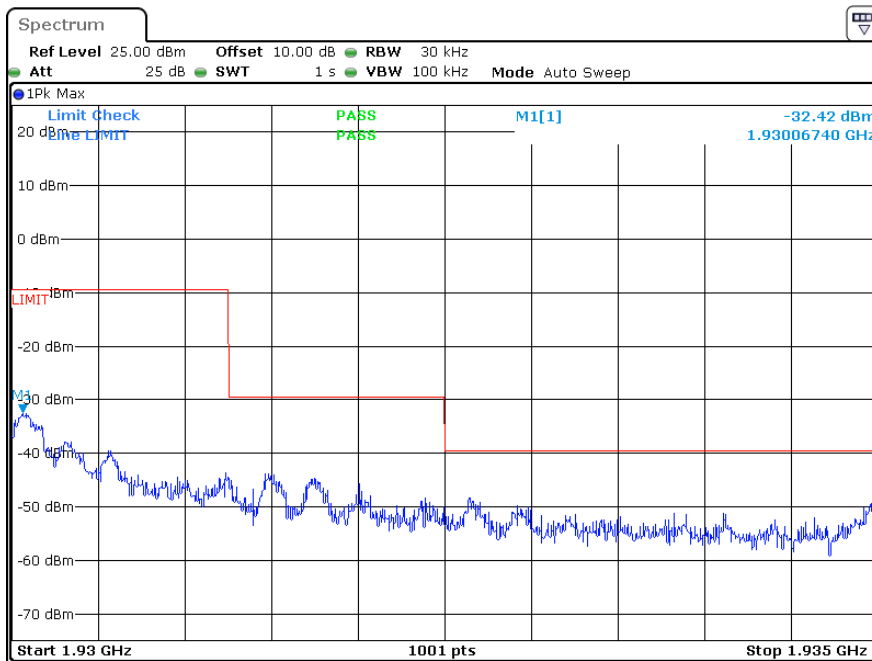

ProjectNo.:SZ1240220-08465E-RF Tester:Hanic Pan  
Date: 12.MAR.2024 14:12:31

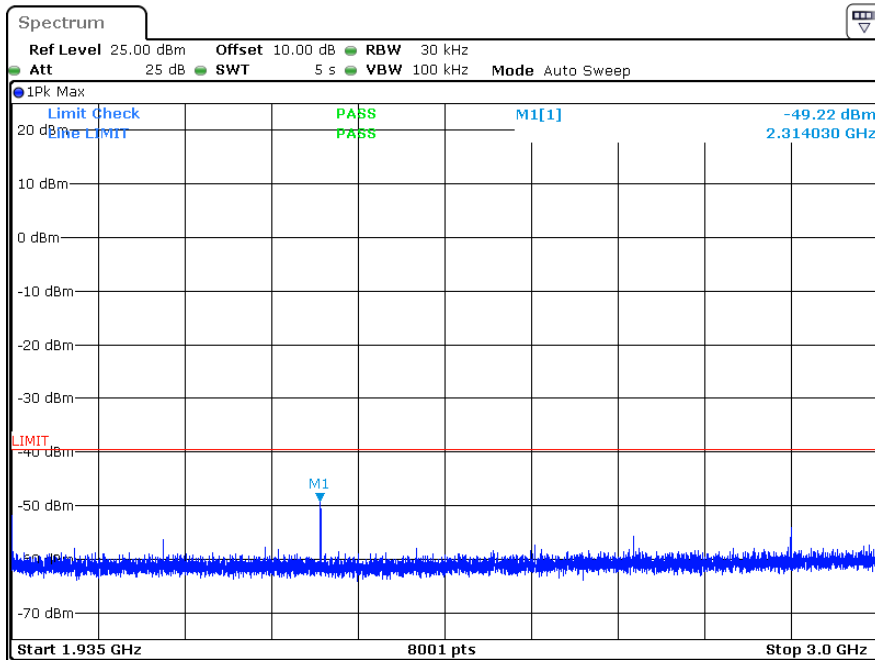

ProjectNo.:SZ1240220-08465E-RF Tester:Hanic Pan  
Date: 12.MAR.2024 14:13:12

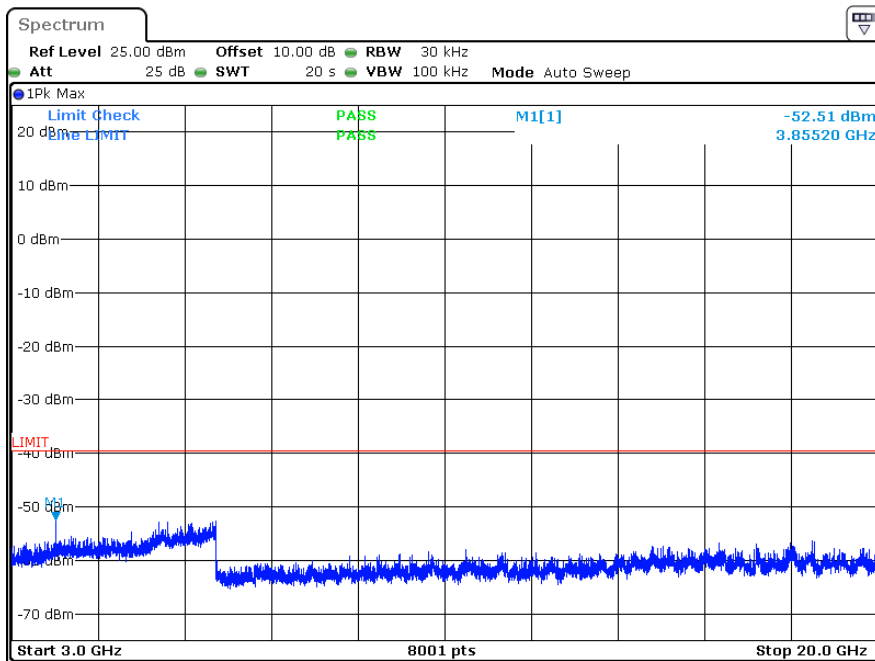

ProjectNo.:SZ1240220-08465E-RF Tester:Hanic Pan  
Date: 12.MAR.2024 14:14:14

## FCC§15.323 (f) - FREQUENCY STABILITY

### Applicable Standard

Per §15.323(f), the frequency stability of the carrier frequency of the intentional radiator shall be maintained within  $\pm 10$  ppm over 1 hour or the interval between channel access monitoring, whichever is shorter. The frequency stability shall be maintained over a temperature variation of  $-20^{\circ}\text{C}$  to  $+50^{\circ}\text{C}$  at normal supply voltage, and over a variation in the primary supply voltage of 85 percent to 115 percent of the rated supply voltage at a temperature of  $20^{\circ}\text{C}$ . For equipment that is capable only of operating from a battery, the frequency stability tests shall be performed using a new battery without any further requirement to vary supply voltage

### Test Procedure

This procedure should be carried out for each of the following test cases:

Temperature	Supply Voltage
20°C	85-115% or new batteries
-20°C	Normal
+50°C	Normal

During test, the equipment shall be placed in the boxes and set the temperature to the specified requirement until the thermal balance has been reached.

Using the mean carrier frequency at  $20^{\circ}\text{C}$  and at nominal supply voltage as the reference, the mean carrier frequency shall be maintained within  $\pm 10$  ppm at the two extreme temperatures (or as declared by the manufacturer) and at normal temperature (typically  $20^{\circ}\text{C}$ ) at the two extreme supply voltages. This test does not apply to a EUT that is capable only of operating from a battery.

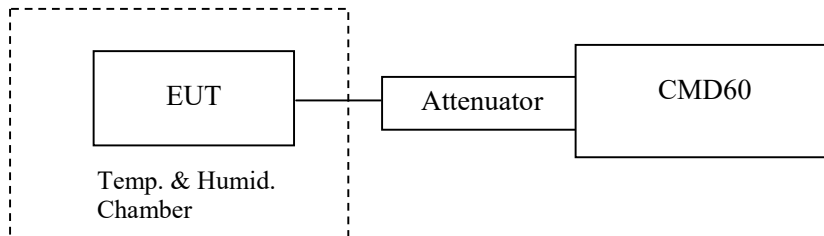

### Test Data

#### Environmental Conditions

Temperature:	25 °C
Relative Humidity:	47 %
ATM Pressure:	101 kPa

*The testing was performed by Hanic Pan on 2024-03-12.*

*Test mode: Transmitting*

**Test Result: Compliant**

Temperature (°C)	Voltage (V <sub>AC</sub> )	Channel Frequency (MHz)	Measured Frequency Offset (kHz)	Measured Frequency Offset (ppm)	Limit (ppm)
-20	120	1924.992	5	2.60	±10
20	102	1924.992	7	3.64	±10
	138	1924.992	8	4.16	±10
50	120	1924.992	5	2.60	±10

## FCC§15.323 (c) (e) & §15.319(f) – SPECIFIC REQUIREMENTS FOR UPCS DEVICE

### Applicable Standard

FCC§15.323(c)(e) & §15.319(f) Specific Requirements for UPCS device.  
 ANSI C63.17 2013 §6.2 Frequency and time stability and §7.Monitoring tests and §8.Time and spectrum window access procedure.

### Test Procedure

Measurement method according to ANSI C63.17 -2013

Test configuration as below

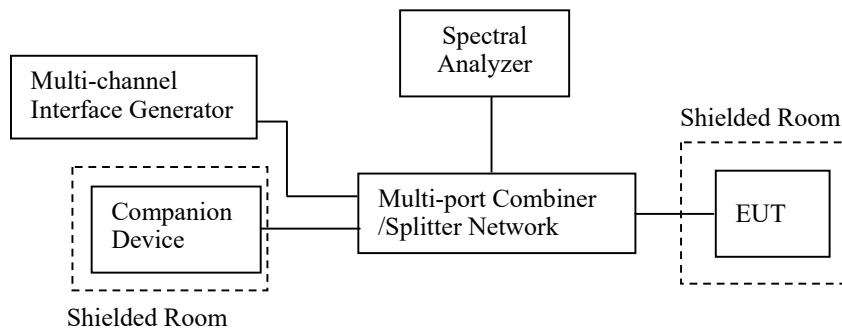

### Test Data

#### Environmental Conditions

<b>Temperature:</b>	25 °C
<b>Relative Humidity:</b>	47 %
<b>ATM Pressure:</b>	101 kPa

*The testing was performed by Hanic Pan on 2024-03-12.*

**Test Result: Compliant**, please see the below data

**1) Automatic Discontinuation of Transmission, FCC §15.319(f)**

**Test result:**

The following tests were performed after a connection had been established with handset unit.

Test condition	Reaction of EUT	Pass/Fail
Adapter removed from EUT	Connection break down	Pass
Battery remove from Handset	Connection break down	Pass

**2) Monitoring Time, FCC §15.323(c) (1)**

**Test result:**

This requirement is covered by the results of Least Interfered Channel (LIC).

Interference (Refer to ANSI C63.17 clause 7.3.3)	Reaction of EUT	Results
a) Apply the interference on $f_1$ at level $T_L+U_M+20\text{dB}$ and no interference on $f_2$ . Initiate transmission and verify the transmission only on $f_2$ . Then terminate it.	EUT transmits on $f_2$	Pass
b) Apply the interference on $f_2$ at level $T_L+U_M+20\text{dB}$ and immediately remove all interference from $f_1$ . The EUT should immediately attempt transmission on $f_1$ (but at least 20 ms after the interference on $f_2$ is applied), verify the transmission only on $f_1$ .	EUT transmission $f_1$	Pass

**3) Lower Monitoring Threshold, FCC §15.323(c) (2)**

**Test result:**

Not applicable because the EUT has more 40 defined duplex system access channels and meet the provision of the Least Interfered Channel (LIC).

**4) Maximum Transmit Period, FCC §15.323(c) (3)**

**Test result:**

Repetition of Access Criteria	Measured Maximum Transmission Time (Second)	Limit (Second)	Results
First	18950	28,800	Pass
Second	18910	28,800	Pass

**5) System Acknowledgement, FCC §15.323(c) (4)**

**Test result:**

Test	Time taken (second)	Limit (second)	Result
Initial Connection acknowledgement	0.43	1	Pass
Change of access criteria for control information	N/A	30	N/A
Transmission cease time	5.12	30	Pass

Note: N/A=Not Applicable

**6) Least Interfered Channel (LIC), FCC §15.323(c) (5)**

Calculation of monitoring threshold limits for isochroous devices:

Lower threshold:  $TL = -174 + 10 \log_{10} B + ML + P_{MAX} - PEUT$  (dBm)

Where: B=Emission bandwidth (Hz)

ML = dB the threshold may exceed thermal noise (30 for TL)

$P_{MAX} = 5 \log_{10} B - 10$  (dBm)

PEUT = Transmitted power (dBm)

**Calculated thresholds:**

Monitor Threshold	B(MHz)	ML(dB)	P <sub>MAX</sub> (dBm)	P <sub>EUT</sub> (dBm)	Threshold (dBm)
Lower threshold	1.465	30	20.83	20.55	-82.06

Note: 1.The upper threshold is applicable as the EUT utilizes more than 20 duplex system channels

**Test result:**

**1) LIC procedure test:**

Interference (Refer to ANSI C63.17 clause 7.3.3)	Reaction of EUT	Results
a) Apply the interference on $f_1$ at level $T_L + U_M + 7$ dB and the interference on $f_2$ at level $T_L + U_M$ . Initiate transmission and verify the transmission only on $f_2$ . Repeat 5 times.	EUT transmits on $f_2$	Pass
b) Apply the interference on $f_1$ at level $T_L + U_M$ and the interference on $f_2$ at level $T_L + U_M + 7$ dB. Initiate transmission and verify the transmission only on $f_1$ . Repeat 5 times.	EUT transmits on $f_1$	Pass
c) Apply the interference on $f_1$ at level $T_L + U_M + 1$ dB the interference on $f_2$ at level $T_L + U_M - 6$ dB. Initiate transmission and verify the transmission only on $f_2$ . Repeat 5 times.	EUT transmits on $f_2$	Pass
d) Apply the interference on $f_1$ at level $T_L + U_M - 6$ dB and the interference on $f_2$ at level $T_L + U_M + 1$ dB. Initiate transmission and verify the transmission only on $f_1$ . Repeat 5 times.	EUT transmits on $f_1$	Pass



**2) Selected channel confirmation:**

Interference (Refer to ANSI C63.17 clause 7.3.4)	Reaction of EUT	Results
a) Apply the interference on $f_1$ at level $T_U+U_M$ and no interference on $f_2$ . Initiate transmission and verify the transmission only on $f_2$ . Then terminate it.	EUT transmits on $f_2$	Pass
b) Apply the interference on $f_2$ at level $T_L+U_M$ and immediately remove all interference from $f_1$ . The EUT should immediately attempt transmission on $f_1$ (but at least 20 ms after the interference on $f_2$ is applied), verify the transmission only on $f_1$ .	EUT transmission $f_1$	Pass

**7) Random waiting, FCC §15.323(c) (6)**

Note: This is Not Applicable

**8) Monitoring Bandwidth and Reaction Time, FCC §15.323(c) (7)**

**Test result:**

**1) Monitoring Bandwidth:**

The antenna of the EUT used for monitoring is the same interior antenna that used for transmission, so the monitoring system bandwidth is equal to the emission bandwidth of the intended transmission

**2) Reaction Time Test:**

No.	Interference Pulse width ( $\mu$ s)	Reaction of EUT	Observing time ( $\mu$ s)	Result
1	50 $\mu$ s with level $T_L+U_M$	No transmission	45.12	Pass
2	35 $\mu$ s with level $T_L+U_M+6$ dB	No transmission	31.24	Pass

**9) Monitoring Antenna, FCC §15.323(c) (8)**

**Test result:**

The antenna of the EUT used for transmission is the same interior antenna that used for monitoring.

**10) Monitoring threshold relaxation, FCC §15.323(c) (9)**

**Test result:**

This requirement is covered by the results of Least Interfered Channel (LIC).

**11) Duplex Connections, FCC §15.323(c) (10)**

**Test result:**

Interference (Refer to ANSI C63.17 § 8.3.2)	Reaction of EUT	Results
a) Only a single carrier $f_1$ for EUT TDMA systems and on $f_1$ and $f_2$ and corresponding duplex carriers for FDMA systems.	EUT can transmit	Pass
b) All Tx windows with level TL+UM except one & Rx windows with level TL+UM+7dB except one, which are not the duplex mate.	Connected on the target Rx window and its duplex mate.	Pass
c) All Tx windows with level TL+UM+7dB except one & Rx windows with level TL+UM except one, which are not duplex mate.	Connected on the target Tx window and its duplex mate.	Pass
d) All Tx & Rx windows with level TU+UM, except one for Tx window & one for Rx window, which are not duplex mate.	No connection possible	Pass

**12) Alternative monitoring interval, FCC §15.323(c) (11)**

**Test result:**

Interference (Refer to ANSI C63.17 § 8.4)	Reaction of EUT	Results
a) Only a single carrier $f_1$ for EUT TDMA systems and on $f_1$ and $f_2$ and corresponding duplex carriers for FDMA systems.	EUT can transmit	Pass
b) Apply interference with same parameters as EUT transmissions on all Tx windows with level TL+UM on the enabled carrier(s) and no interference on the Rx windows on the enabled carriers.	No connection is established	Pass

**13) Fair Access, FCC §15.323(c) (12)**

**Test result:**

The manufacturer declares that this device does not use any mechanisms as provided by FCC §15.323(c)(10) or (11) to extend the range of spectrum occupied over space or time for the purpose of denying fair access to spectrum to other device.

**14) Frame Repetition Stability Frame Period and Jitter, FCC§15.323 (e)**

**Test result:**

Frame Period and Jitter:

Max. pos. Jitter (µs)	Max. neg. Jitter (µs)	Frame period (ms)	Limit	
			Frame Period (ms)	Jitter (µs)
0.07	-0.07	10.25	20 or 10/X	25

Note: X is a positive whole number.

## **EUT PHOTOGRAPHS**

---

Please refer to the attachment SZ1240220-08465E-RF External photo and SZ1240220-08465E-RF Internal photo.

## **TEST SETUP PHOTOGRAPHS**

---

Please refer to the attachment SZ1240220-08465E-RF-00A Test Setup photo.

**\*\*\*\*\* END OF REPORT \*\*\*\*\***