

## TEST REPORT

### SPECIFIC ABSORPTION RATE (SAR) EVALUATION REPORT

**Report No.: 22060626HKG-001**

For Video Monitor - Parent Unit  
Model: VM5463 PU  
Brand Name: vtech  
FCC ID: EW780-2023-01

Prepared for  
VTech Telecommunications Ltd.  
23/F., Tai Ping Industrial Centre, Block 1,  
57 Ting Kok Road, Tai Po,  
Hong Kong.

**PREPARED AND CHECKED BY:**

**APPROVED BY:**

Signed On File  
Lee King Fai, Thomas  
Assistant Engineer

---

Wong Kwok Yeung, Kenneth  
Assistant Manager  
Date: June 28, 2023

**TEST REPORT**

**TABLE OF CONTENTS**

**1 Test Result Summary ..... 3**

**2 General Information ..... 4**

**3 SAR Measurement System Description ..... 8**

**4 Tissue Verificaiton..... 16**

**5 SAR Measurement System Verification ..... 19**

**6 SAR Evaluation..... 21**

**7 Test Equipment List..... 35**

**8 Measurement Uncertainty ..... 36**

**9 E-Field Probe and Dipole Antenna Calibration..... 41**

**APPENDIX A – System Check Data ..... 42**

**APPENDIX B – SAR Evaluation Data..... 43**

**APPENDIX C – E-Field Probe and Dipole Antenna Calibration ..... 45**

**Appendix D – SAR System Validation ..... 46**

**TEST REPORT**

**1. TEST RESULT SUMMARY**

<b>Applicant:</b>	VTech Telecommunications Ltd.
<b>Applicant Address:</b>	23/F., Tai Ping Industrial Centre, Block 1, 57 Ting Kok Road, Tai Po, Hong Kong.
<b>Brand Name:</b>	vtech
<b>Description of EUT:</b>	Video Monitor - Parent Unit
<b>Model:</b>	VM5463 PU VM5463-2 PU; LM918-1W PU; LM918-2W PU; VM5263 PU; VM5263-2 PU
<b>FCC ID:</b>	EW780-2023-01
<b>Serial Number:</b>	N/A
<b>Test Device:</b>	Production Unit
<b>Exposure Category:</b>	General Population/Uncontrolled Exposure
<b>Date of Test:</b>	June 27, 2022
<b>Test Location:</b>	Workshop No. 3, G/F., World-Wide Industrial Centre, 43-47 Shan Mei Street, Fo Tan, Sha Tin, N.T., Hong Kong SAR, China.
<b>CAB Identifier:</b>	HKAP01
<b>Environmental Conditions:</b>	Temperature: +18 to 25°C Humidity 25 to 75%
<b>Test Specification:</b>	ANSI/IEEE C95.1 IEEE Std 1528: 2013 FCC KDB Publication 447498 D01 v06 FCC KDB Publication 865664 D01 v01r04 FCC KDB Publication 865664 D02 v01r02

The maximum spatial peak SAR value for the sample device averaged over 1g was found to be:

Band	Operating Mode	TX Frequency (MHz)	Highest Reported SAR	
			In-front-of mouth	Body
2.4GHz FHSS	Data	2405 – 2475	0.023 W/kg	0.159 W/kg

This wireless portable device has been shown to be capable of compliance for localized specific absorption rate (SAR) for uncontrolled environment / general population exposure limits specified in ANSI/IEEE C95.1.

## TEST REPORT

### 2. GENERAL INFORMATION

#### 2.1. Description of Equipment Under Test (EUT)

<b>Manufacturer:</b>	VTech (Dongguan) Telecommunications Limited
<b>Manufacturer Address:</b>	VTech Science Park, Xia Ling Bei Management Zone, Liaobu, Dongguan, Guangdong, China.
<b>Device Dimension (L x W):</b>	169 (mm) x 95 (mm)
<b>Device Thickness:</b>	23 (mm)
<b>Antenna Gain:</b>	2dBi
<b>Operating Configuration(s) / Mode:</b>	In-front-of mouth (Data) Body (Data)
<b>TX Frequency (MHz):</b>	2405 - 2475MHz
<b>Duty Cycle*:</b>	9.7%
<b>H/W Version:</b>	N/A
<b>S/W Version:</b>	N/A
<b>Battery Type:</b>	3.7VDC (1 x 3.7V 5000mAh 18.5Wh Li-Polymer rechargeable battery)
<b>Body-worn Accessories:</b>	N/A
<b>Remark:</b>	The models VM5463-2 PU; LM918-1W PU; LM918-2W PU; VM5263 PU; VM5263-2 PU are the same as the model VM5463 PU in hardware aspect as declared by client. The models are different in color and model number only as declared by client.

**TEST REPORT**

**2.2. EUT Antenna Locations**

**Antenna Closed Configuration**

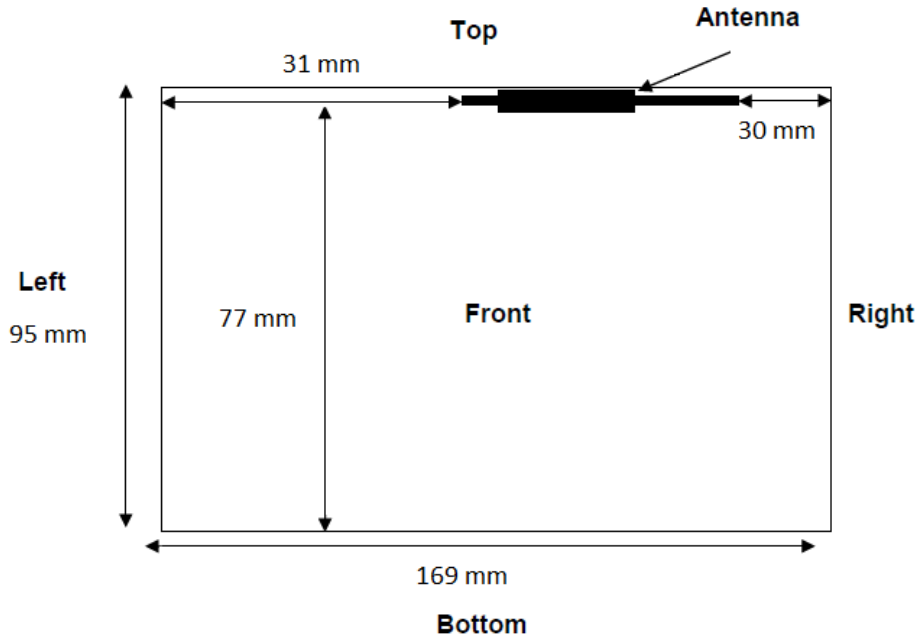

Exposure Position	Separation Distance from the Antenna to the Outer Surface (Antenna Closed)
Front	14
Top	5
Left	30
Right	31
Back	0
Bottom	77

Details of antenna specification are shown in separate antenna dimension document.

**TEST REPORT**

**2.2. EUT Antenna Locations (Cont'd)**

**Antenna Extended Configuration**

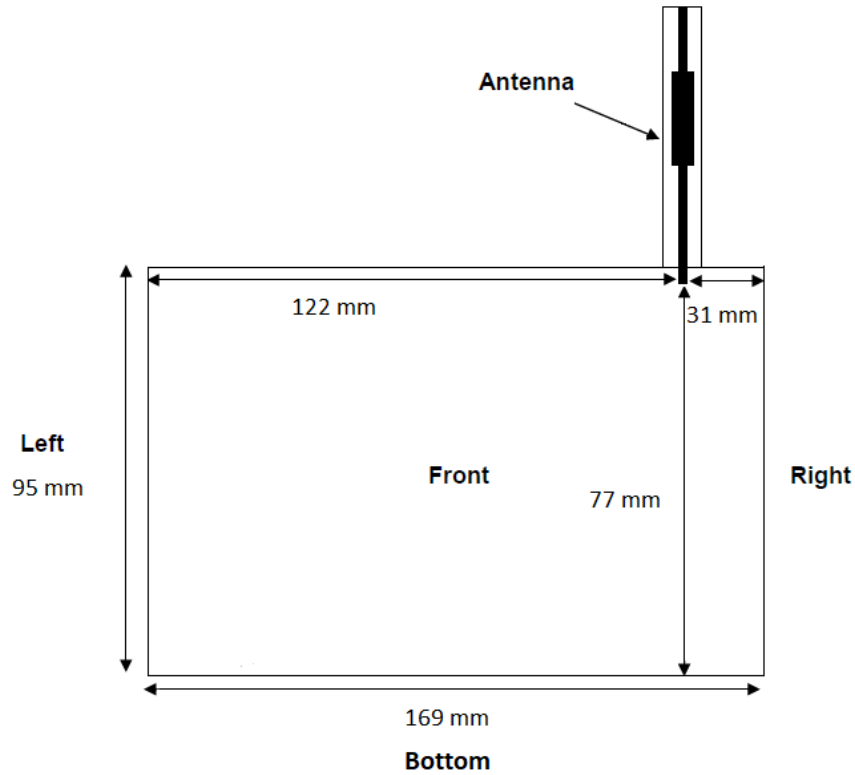

Exposure Position	Separation Distance from the Antenna to the Outer Surface (Antenna Extended)
Front	14
Top	4
Left	122
Right	31
Back	0
Bottom	77

Details of antenna specification are shown in separate antenna dimension document.

## TEST REPORT

### 2.3. Nominal and Maximum Output Power Specifications

The EUT operates using the following maximum and nominal output power specifications. SAR values were scaled to the maximum allowed power to determine compliance per KDB Publication 447498.

Band	Operating Mode	TX Frequency (MHz)	Output Power	
			Nominal (dBm)	Maximum (dBm)
2.4GHz FHSS	Data	2405 – 2475	17.04	18

## TEST REPORT

### 3. SAR MEASUREMENT SYSTEM DESCRIPTION

SAR is related to the rate at which energy is absorbed per unit mass in object exposed to a radio field. The SAR distribution in a biological body is complicated and is usually carried out by experimental techniques or numerical modeling. The standard recommends limits for two tiers of groups, occupational/controlled and occupational/uncontrolled, based on a person's awareness and ability to exercise control over his or her exposure. In general, occupational/controlled exposure limits are higher than the limits for general population/uncontrolled.

The SAR definition is the time derivative (rate) of the incremental energy (dW) absorbed by (dissipated in) an incremental mass (dm) contained in a volume element (dv) of given mass density ( $\rho$ ). The equation description is as below:

$$SAR = \frac{d}{dt} \left( \frac{dW}{dm} \right) = \frac{d}{dt} \left( \frac{dW}{\rho dV} \right)$$

SAR is expressed in units of Watts per kilogram (W/Kg)

SAR can be obtained using either of the following equations:

$$SAR = \frac{\sigma E^2}{\rho}$$

$$SAR = c_h \left. \frac{dT}{dt} \right|_{t=0}$$

Where

- SAR is the specific absorption rate in watts per kilogram;
- E is the r.m.s. value of the electric field strength in the tissue in volts per meter;
- $\sigma$  is the conductivity of the tissue in siemens per metre;
- $\rho$  is the density of the tissue in kilograms per cubic metre;
- $c_h$  is the heat capacity of the tissue in joules per kilogram and Kelvin;

$\left. \frac{dT}{dt} \right|_{t=0}$  is the initial time derivative of temperature in the tissue in kelvins per second.



## TEST REPORT

An SAR measurement system usually consists of a small diameter isotropic electric field probe, a multiple axis probe positioning system, a test device holder, one or more phantom models, the field probe instrumentation, a computer and other electronic equipment for controlling the probe and making the measurements. Other supporting equipment, such as a network analyzer, power meters and RF signal generators, are also required to measure the dielectric parameters of the simulated tissue media and to verify the measurement accuracy of the SAR system.

The SAR measurement system being used is COMOSAR system, which consists following items for performing compliance tests.

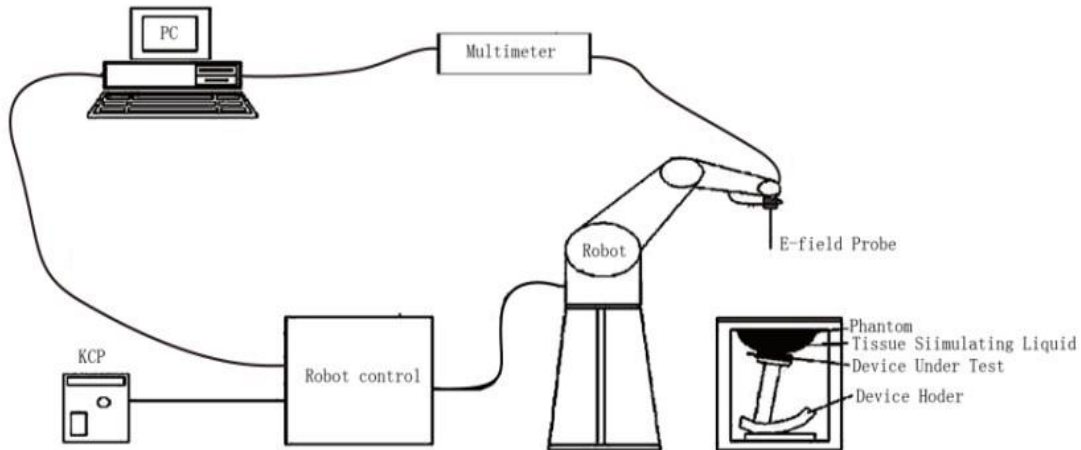

*Figure 1: Schematic diagram of the SAR measurement system*

- The PC. It controls most of the bench devices and stores measurement data. A computer running WinXP and the Opensar software.
- The E-Field probe. The probe is a 3-axis system made of 3 distinct dipoles. Each dipole returns a voltage in function of the ambient electric field.
- The Keithley multimeter measures each probe dipole voltages.
- The SAM phantom simulates a human head. The measurement of the electric field is made inside the phantom.
- The liquids simulate the dielectric properties of the human head tissues
- The network emulator controls the mobile phone under test.
- The validation dipoles are used to measure a reference SAR. They are used to periodically check the bench to make sure that there is no drift of the system characteristics over time.
- The phantom, the device holder and other accessories according to the targeted measurement.

## TEST REPORT

### ROBOT

The COMOSAR system uses the KUKA robot from SATIMO SA (France). For the 6-axis controller COMOSAR system, the KUKA robot controller version from SATIMO is used.

The XL robot series have many features that are important for our application:

- High precision (repeatability 0.02 mm)
- High reliability (industrial design)
- Jerk-free straight movements
- Low ELF interference (the closed metallic construction shields against motor control fields)
- 6-axis controller



**TEST REPORT**

**COMOSAR E-FIELD PROBE**

The SAR measurement is conducted with the dissymmetric probe manufactured by SATIMO. The probe is specially designed and calibrated for use in liquid with high permittivity. The dissymmetric probe has special calibration in liquid at different frequency. SATIMO conducts the probe calibration in compliance with international and national standards (e.g. IEC/IEEE 62209-1528:2020 and relevant KDB files). The calibration data are in Appendix C.

<b>Model</b>	SSE2
<b>Manufacturer</b>	MVG
<b>Frequency</b>	0.45GHz-6GHz Linearity:±0.08dB
<b>Dynamic Range</b>	0.01W/Kg-100W/Kg Linearity:±0.08dB
<b>Dimensions</b>	Overall length:330mm Length of individual dipoles:2mm Maximum external diameter:8mm Probe Tip external diameter:2.5mm Distance between dipoles/ probe extremity:1mm



## TEST REPORT

### VIDEO POSITIONING SYSTEM

The video positioning system is used in OpenSAR to check the probe. Which is composed of a camera, LED, mirror and mechanical parts. The camera is piloted by the main computer with firewire link.

During the process, the actual position of the probe tip with respect to the robot arm is measured, as well as the probe length and the horizontal probe offset. The software then corrects all movements, such that the robot coordinates are valid for the probe tip.

The repeatability of this process is better than 0.1 mm. If a position has been taught with an aligned probe, the same position will be reached with another aligned probe within 0.1 mm, even if the other probe has different dimensions. During probe rotations, the probe tip will keep its actual position.

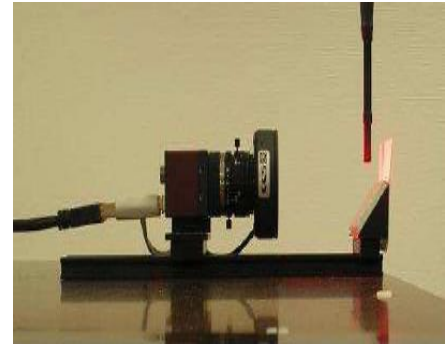

## TEST REPORT

### SAM TWIN PHANTOM

The SAM twin phantom is a fiberglass shell phantom with  $2\text{mm} \pm 0.2\text{ mm}$  shell thickness (except the ear region where shell thickness increases to  $6\text{mm} \pm 0.2\text{ mm}$ ), relative permittivity  $\epsilon_r = 3.4$  and loss tangent  $\delta = 0.02$ . It has three measurement areas:

- Left head
- Right head
- Flat phantom



The bottom plate contains three pair of bolts for locking the device holder. The device holder positions are adjusted to the standard measurement positions in the three sections. A white cover is provided to tap the phantom during off-periods to prevent water evaporation and changes in the liquid parameters. On the phantom top, three reference markers are provided to identify the phantom position with respect to the robot.

## TEST REPORT

### ELLIPTICAL PHANTOM

The elliptical phantom is a fiberglass shell phantom with

- $2\text{mm} \pm 0.2\text{ mm}$  shell thickness
- relative permittivity  $\epsilon_r = 3.4$
- loss tangent  $\delta = 0.02$



### DEVICE HOLDER

The COMOSAR device holder is designed to cope with different positions given in the standard. It has two scales for the device rotation (with respect to the body axis) and the device inclination (with respect to the line between the ear reference points). The rotation center for both scales is the ear reference point (EPR).

Thus the device needs no repositioning when changing the angles.

The COMOSAR device holder has been made out of low-loss POM material having the following dielectric parameters: relative permittivity  $\epsilon_r = 3.7$  and loss tangent  $\delta = 0.005$ . The amount of dielectric material has been reduced in the closest vicinity of the device, since measurements have suggested that the influence of the clamp on the test results could thus be lowered.

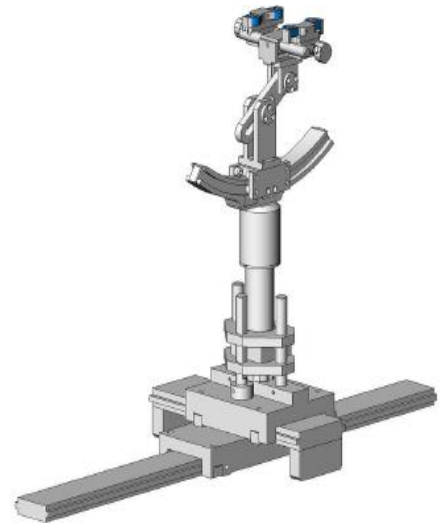

## TEST REPORT

During measurement, the system first does an area (2D) scan at a fixed depth within the liquid from the inside wall of the phantom scanning area is greater than the projection of EUT and antenna.

Area Scan Parameters extracted from KDB 865664

	≤ 3 GHz	> 3 GHz
Maximum distance from closest measurement point (geometric center of probe sensors) to phantom surface	5 mm ± 1 mm	$\frac{1}{2} \cdot \delta \cdot \ln(2)$ mm ± 0.5 mm
Maximum probe angle from probe axis to phantom surface normal at the measurement location	30° ± 1°	20° ± 1°
Maximum area scan spatial resolution: $\Delta x_{Area}$ , $\Delta y_{Area}$	≤ 2 GHz: ≤ 15 mm 2 – 3 GHz: ≤ 12 mm	3 – 4 GHz: ≤ 12 mm 4 – 6 GHz: ≤ 10 mm
	When the x or y dimension of the test device, in the measurement plane orientation, is smaller than the above, the measurement resolution must be ≤ the corresponding x or y dimension of the test device with at least one measurement point on the test device.	

When the maximum SAR point has been found, the system will then carry out a zoom (3D) scan centered at that point to determine volume averaged SAR level.

Zoom Scan Parameters extracted from KDB 865664

Maximum zoom scan spatial resolution: $\Delta x_{Zoom}$ , $\Delta y_{Zoom}$		≤ 2 GHz: ≤ 8 mm 2 – 3 GHz: ≤ 5 mm*	3 – 4 GHz: ≤ 5 mm* 4 – 6 GHz: ≤ 4 mm*	
Maximum zoom scan spatial resolution, normal to phantom surface	uniform grid: $\Delta z_{Zoom}(n)$	≤ 5 mm	3 – 4 GHz: ≤ 4 mm 4 – 5 GHz: ≤ 3 mm 5 – 6 GHz: ≤ 2 mm	
	graded grid	$\Delta z_{Zoom}(1)$ : between 1 <sup>st</sup> two points closest to phantom surface	≤ 4 mm	3 – 4 GHz: ≤ 3 mm 4 – 5 GHz: ≤ 2.5 mm 5 – 6 GHz: ≤ 2 mm
		$\Delta z_{Zoom}(n>1)$ : between subsequent points	≤ 1.5 · $\Delta z_{Zoom}(n-1)$ mm	
Minimum zoom scan volume	x, y, z	≥ 30 mm	3 – 4 GHz: ≥ 28 mm 4 – 5 GHz: ≥ 25 mm 5 – 6 GHz: ≥ 22 mm	
Note: $\delta$ is the penetration depth of a plane-wave at normal incidence to the tissue medium; see IEEE Std 1528-2013 for details. * When zoom scan is required and the <i>reported</i> SAR from the <i>area scan based 1-g SAR estimation</i> procedures of KDB Publication 447498 is ≤ 1.4 W/kg, ≤ 8 mm, ≤ 7 mm and ≤ 5 mm zoom scan resolution may be applied, respectively, for 2 GHz to 3 GHz, 3 GHz to 4 GHz and 4 GHz to 6 GHz.				

**TEST REPORT**

**4. TISSUE VERIFICATION**

For SAR measurement of field distribution inside phantom, homogeneous tissue simulating liquid as below liquid recipes were filled to a depth of 15cm ± 0.5cm for below 3GHz measurement and of 10cm ± 0.5cm for above 3GHz.

**HEAD TISSUE RECIPES**

Frequency	De-ionized Water	Ingredients				
		Salt	1,2 propanediol	DGBE	DGMH	Triton X100
450 MHz	33.5%	3.4%	63.1%			
750 MHz	34.2%	1.4%	64.4%			
900 MHz	35.3%	1.0%	63.7%			
1800 MHz	55.2%	0.6%		13.8%		30.4%
1900 MHz	55.3%	0.5%		13.8%		30.4%
2000 MHz	55.3%	0.4%		13.8%		30.5%
2450 MHz	55.7%	0.3%		18.7%		25.3%
5000 MHz	65.3%				17.2%	17.5%

**BODY TISSUE RECIPES**

Frequency	De-ionized Water	Ingredients				
		Salt	1,2 propanediol	DGBE	DGMH	Triton X100
450 MHz	52.4%	1.9%	45.7%			
750 MHz	55.4%	1.3%	43.3%			
900 MHz	52.9%	1.0%	46.1%			
1800 MHz	70.8%	0.5%		8.7%		20.0%
1900 MHz	70.1%	0.4%		8.9%		20.6%
2000 MHz	70.2%	0.3%		8.6%		20.9%
2450 MHz	70.8%	0.3%		8.7%		20.2%
5000 MHz	77.8%				11.7%	11.5%



**TEST REPORT**

The head tissue dielectric parameters recommended by the IEC/IEEE 62209-1528:2020 have been incorporated in the following table. These head parameters are derived from planar layer models simulating the highest expected SAR for the dielectric properties and tissue thickness variations in a human head. For other head and body tissue parameters, they are recommended by KDB 865664.

Target Frequency (MHz)	Head		Body	
	$\epsilon_r$	$\sigma$ (S/m)	$\epsilon_r$	$\sigma$ (S/m)
300	45.3	0.87	58.2	0.92
450	43.5	0.87	56.7	0.94
835	41.5	0.90	55.2	0.97
900	41.5	0.97	55.0	1.05
915	41.5	1.01	55.0	1.06
1450	40.5	1.20	54.0	1.30
1610	40.3	1.29	53.8	1.40
1800 – 2000	40.0	1.40	53.3	1.52
2450	39.2	1.80	52.7	1.95
3000	38.5	2.40	52.0	2.73
5800	35.3	5.27	48.2	6.00

( $\epsilon_r$  = relative permittivity,  $\sigma$  = conductivity and  $\rho = 1000$  kg/m<sup>3</sup>)

When a transmission band overlaps with one of the target frequencies, the tissue dielectric parameters of the tissue medium at the middle of a device transmission band should be within  $\pm 5\%$  of the parameters specified at that target frequency.

## TEST REPORT

The dielectric parameters of the liquids were verified prior to the SAR evaluation using SATIMO Dielectric Probe Kit and R&S Network Analyzer ZVL6.

The dielectric parameters were:

### Head Liquid

Freq. (MHz)	Temp. (°C)	$\epsilon_r$ / Relative Permittivity			$\sigma$ / Conductivity			$\rho$ **(kg/m <sup>3</sup> )
		Measured	Target*	$\Delta$ ( $\pm 5\%$ )	Measured	Target*	$\Delta$ ( $\pm 5\%$ )	
2450	20.4	40.3	39.20	2.81	1.84	1.80	2.22	1000

\* Target values refer to KDB 865664

\*\* Worst-case assumption

### Note:

1. Date of tissue verification measurement: June 27, 2022.
2. Ambient temperature: 20.4 deg C.
3. The temperature condition is within +/- 2 deg. C during the SAR measurements.

**TEST REPORT**

**5. SAR MEASUREMENT SYSTEM VERIFICATION**

Each SATIMO system is equipped with one or more system check kits. These units, together with the predefined measurement procedures within the SATIMO software, enable user to conduct the system check. System kit includes a dipole, and dipole device holder.

The system check verifies that the system operates within its specifications. It's performed daily or before every SAR measurement. The system check uses normal SAR measurement in the flat section of the phantom with a matched dipole at a specified distance. The system check setup is shown as below.

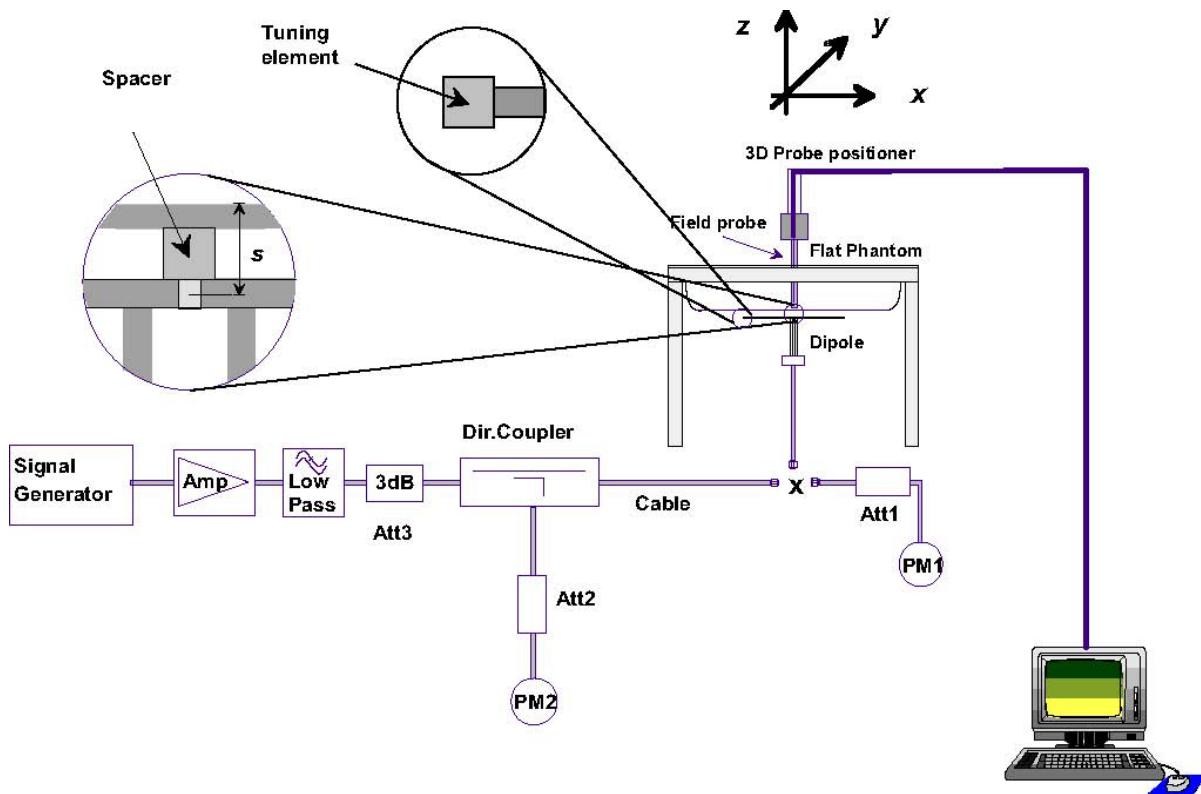

**TEST REPORT**

**VALIDATION DIPOLE**



The dipoles used is based on the IEEE Std 1528, and is complied with mechanical and electrical specifications in line with the requirements of both FCC and KDB requirement.

**SYSTEM CHECK RESULTS**

Date	Freq. (MHz)	Liquid Type	System Dipole	System Verification				
				Serial No.	Target SAR <sub>1g</sub> (W/kg)	Measured SAR <sub>1g</sub> (W/kg)	Normalized SAR <sub>1g</sub> (W/kg)	Deviation (±10%)
June 27, 2022	2450	Head	2450MHz	SN 22/16 DIP 2G450-411	55.89	5.486	54.86	-1.84

\* The target was quoted from dipole calibration report

\* Input power level = 20dBm (0.1W)

SAR<sub>1g</sub> ambient measured value < 12 mW/kg

Details of System Verification plots are shown in the Appendix A - plot 1.

## TEST REPORT

### 6. SAR EVALUATION

#### 6.1. Device Test Positions Relative to the Head

This practice specifies two handset test positions against the head phantom—the “cheek” position and the “tilt” position. These two test positions are defined in the following subclauses. The handset should be tested in both positions on left and right sides of the SAM phantom. If handset construction is such that the handset positioning procedures described below to represent normal use conditions cannot be used, e.g., some asymmetric handsets, alternative alignment procedures should be adapted with all details provided in the test report. These alternative procedures should replicate intended use conditions as closely as possible according to the intent of the procedures described in this subclause.

## TEST REPORT

### DEFINITION OF THE CHEEK POSITION

The cheek position is established as follows:

1. Ready the handset for talk operation, if necessary. For example, for handsets with a cover piece (flip cover), open the cover. If the handset can transmit with the cover closed, both configurations must be tested.
2. Define two imaginary lines on the handset—the vertical centerline and the horizontal line. The vertical centerline passes through two points on the front side of the handset—the midpoint of the width  $w_t$  of the handset at the level of the acoustic output (point A in below figure), and the midpoint of the width  $w_b$  of the bottom of the handset (point B). The horizontal line is perpendicular to the vertical centerline and passes through the center of the acoustic output (see below left figure). The two lines intersect at point A. Note that for many handsets, point A coincides with the center of the acoustic output; however, the acoustic output may be located elsewhere on the horizontal line. Also note that the vertical centerline is not necessarily parallel to the front face of the handset (see right figure), especially for clamshell handsets, handsets with flip covers, and other irregularly-shaped handsets.
3. Position the handset close to the surface of the phantom such that point A is on the (virtual) extension of the line passing through points RE and LE on the phantom (see the figure as next page), such that the plane defined by the vertical centerline and the horizontal line of the handset is approximately parallel to the sagittal plane of the phantom.
4. Translate the handset towards the phantom along the line passing through RE and LE until handset point A touches the pinna at the ERP.

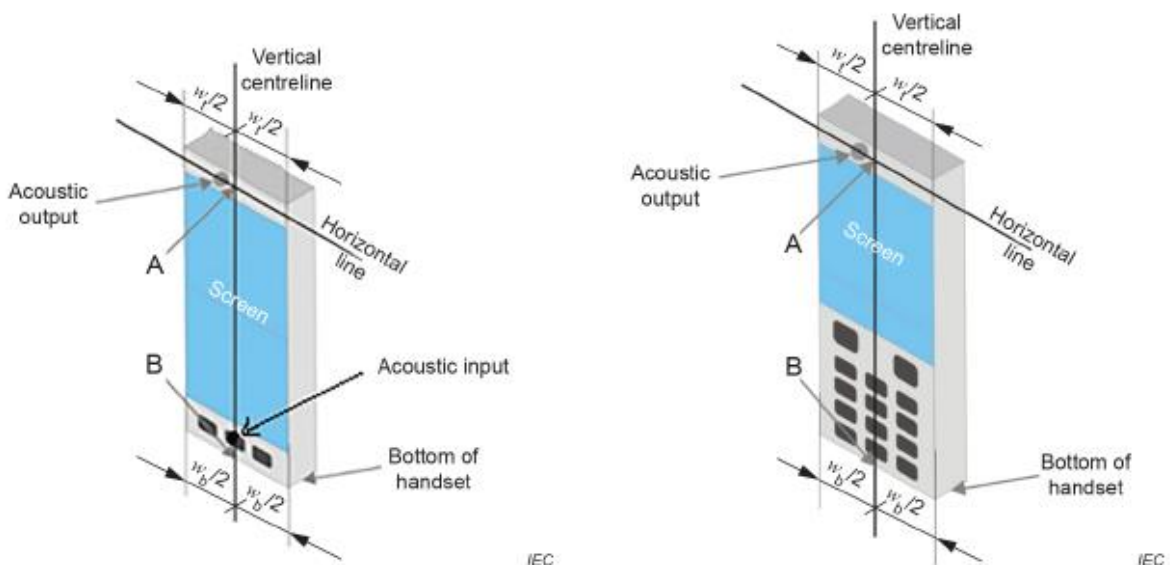

## TEST REPORT

5. While maintaining the handset in this plane, rotate it around the LE-RE line until the vertical centerline is in the plane normal to the plane containing B-M and N-F lines, i.e., the Reference Plane.
6. Rotate the handset around the vertical centerline until the handset (horizontal line) is parallel to the N-F line.
7. While maintaining the vertical centerline in the Reference Plane, keeping point A on the line passing through RE and LE, and maintaining the handset contact with the pinna, rotate the handset about the N-F line until any point on the handset is in contact with a phantom point below the pinna on the cheek.

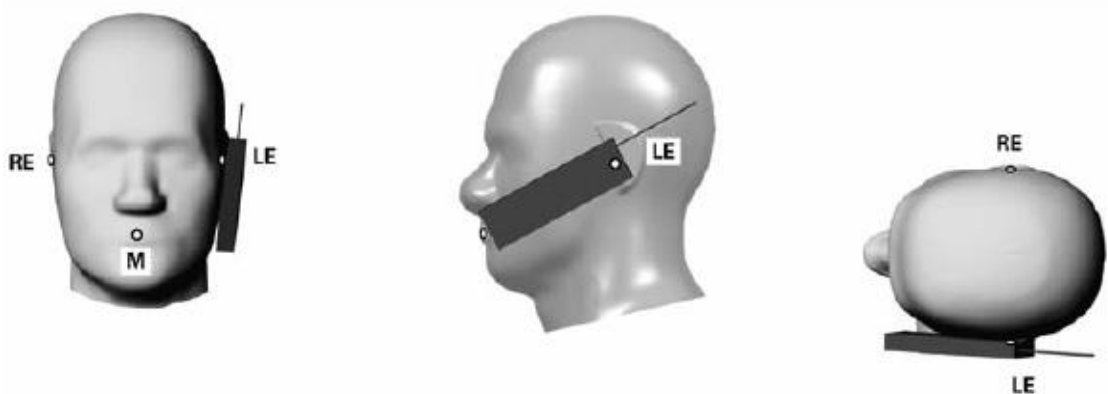

## TEST REPORT

### DEFINITION OF THE TILT POSITION

The tilt position is established as follows:

1. Repeat steps to place the device in the cheek position.
2. While maintaining the orientation of the handset, move the handset away from the pinna along the line passing through RE and LE far enough to allow a rotation of the handset away from the cheek by 15°.
3. Rotate the handset around the horizontal line by 15°.
4. While maintaining the orientation of the handset, move the handset towards the phantom on the line passing through RE and LE until any part of the handset touches the ear. The tilt position is obtained when the contact point is on the pinna. See the figure as below. If contact occurs at any location other than the pinna, e.g., the antenna at the back of the phantom head, the angle of the handset should be reduced.
5. In this case, the tilt position is obtained if any point on the handset is in contact with the pinna and a second point on the handset is in contact with the phantom, e.g., the antenna with the back of the head.

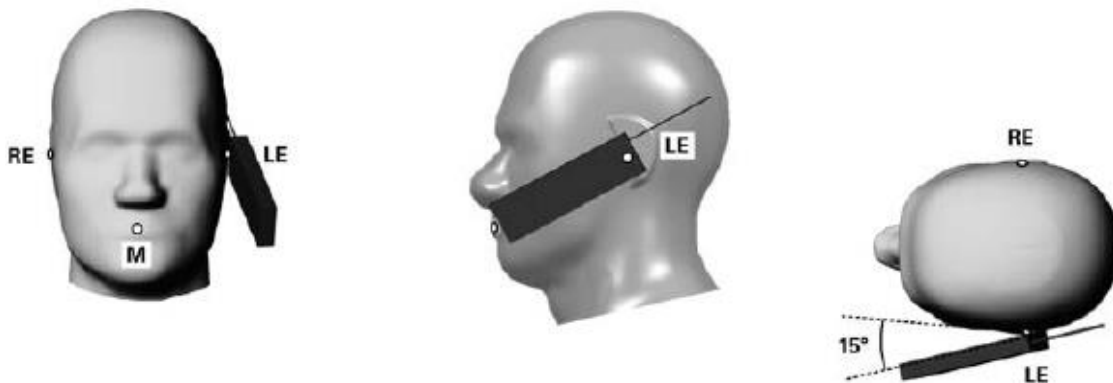



## TEST REPORT

### 6.2. Device Test Positions Relative To Body-Worn Accessory

Body-worn operating configurations are tested with the belt-clips and holsters attached to the device and positioned against a flat phantom in a normal use configuration. Per FCC KDB Publication 648474, Body-worn accessory exposure is typically related to voice mode operations when handsets are carried in body worn accessories. The body-worn accessory procedures in FCC KDB Publication 447498 should be used to test for body-worn accessory SAR compliance, without a headset connected to it. This enables the test results for such configuration to be compatible with that required for hotspot mode when the body-worn accessory test separation distance is greater than or equal to that required for hotspot mode, when applicable. When the reported SAR for a body-worn accessory, measured without a headset connected to the handset, is  $>1.2\text{W/kg}$ , the highest reported SAR configuration for that wireless mode and frequency band should be reported for that body-worn accessory with a headset attached to the handset.

SAR evaluation is required for body-worn accessories supplied with the host device. The test configurations must be conservative for supporting the body-worn accessory use conditions expected by users. Body-worn accessories that do not contain metallic or conductive components may be tested according to worst-case exposure configurations, typically according to the smallest test separation distance required for the group of body-worn accessories with similar operating and exposure characteristics. All body-worn accessories containing metallic components, either supplied with the product or available as an option from the device manufacturer, must be tested in conjunction with the host device to demonstrate compliance.

Body-worn accessories may not always be supplied or available as options for some devices intended to be authorized for body-worn use. In this case, a test configuration with a separation distance between the back of the device and the flat phantom is used. Test position spacing was documented. Transmitters that are designed to operate in front of a person's face, as in push-to-talk configurations, are tested for SAR compliance with the front of the device positioned to face the flat phantom in head fluid.

## TEST REPORT

### 6.3. Device Test Positions Relative To Body-Supported Device

Per IEC/IEEE 62209-1528: 2020, a typical example of a body supported device is a wireless enabled laptop device that among other orientations may be supported on the thighs of a sitting user. To represent this orientation, the device shall be positioned with its base against the flat phantom. Other orientations may be specified by the manufacturer in the user instructions. If the intended use is not specified, the device shall be tested directly against the flat phantom in all usable orientations.

Devices that fall into this category include tablet type portable computers and credit card transaction authorization terminals, point-of-sale and/or inventory terminals. Where these devices may be torso or limb-supported, the same principles for body-supported devices are applied.

The example in Figure a) shows a tablet form factor portable computer for which SAR should be separately assessed with each surface and the separation distances positioned against the flat phantom that correspond to the intended use as specified by the manufacturer. If the intended use is not specified in the user instructions, the device shall be tested directly against the flat phantom in all usable orientations.

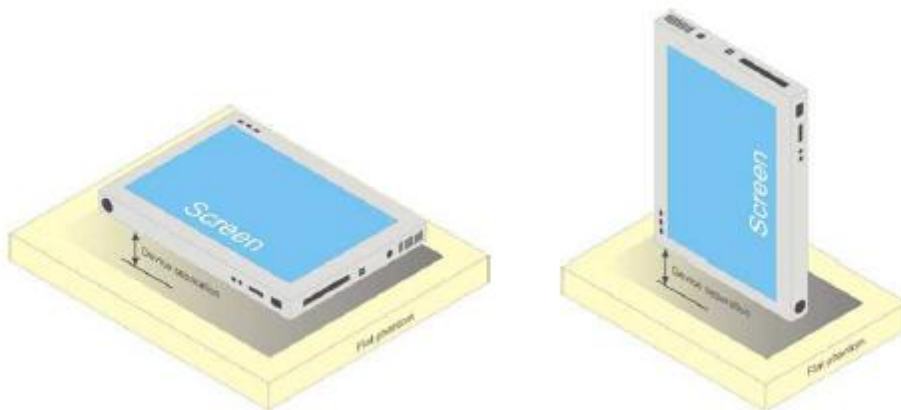
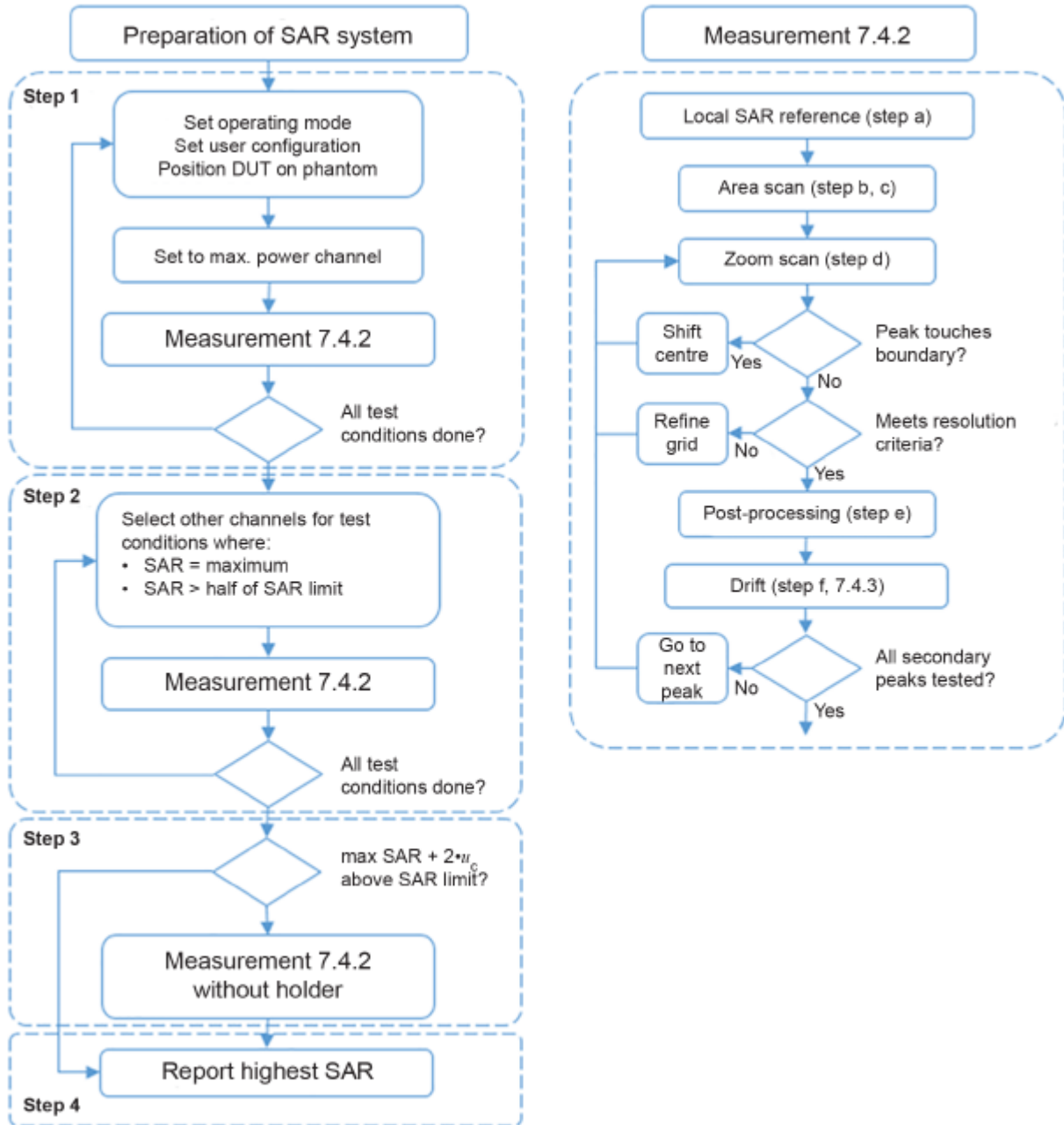

Figure a) – Tablet form factor portable computer

**TEST REPORT**

A block diagram of testing procedure is shown as below figure.



IEC

## TEST REPORT

### 6.4. General Device Setup

The device was first charged on a charger over a duration defined by the applicant to make sure the installed battery was fully charged.

The device was then placed into test mode to simulate the worst case configuration through the highest power channel, where the operating parameters established in this test mode is identical to those programmed in production units, including output power levels, amplifier gain settings and other RF performance tuning parameters. The test frequency is corresponded to actual channel frequencies defined for domestic use.

During testing, the device was evaluated with a fully charged battery, power saving function disabled and was configured to operate at maximum output power. A receive antenna and a spectrum analyzer were placed with a distance > 50cm away from the device to monitor the transmission states.

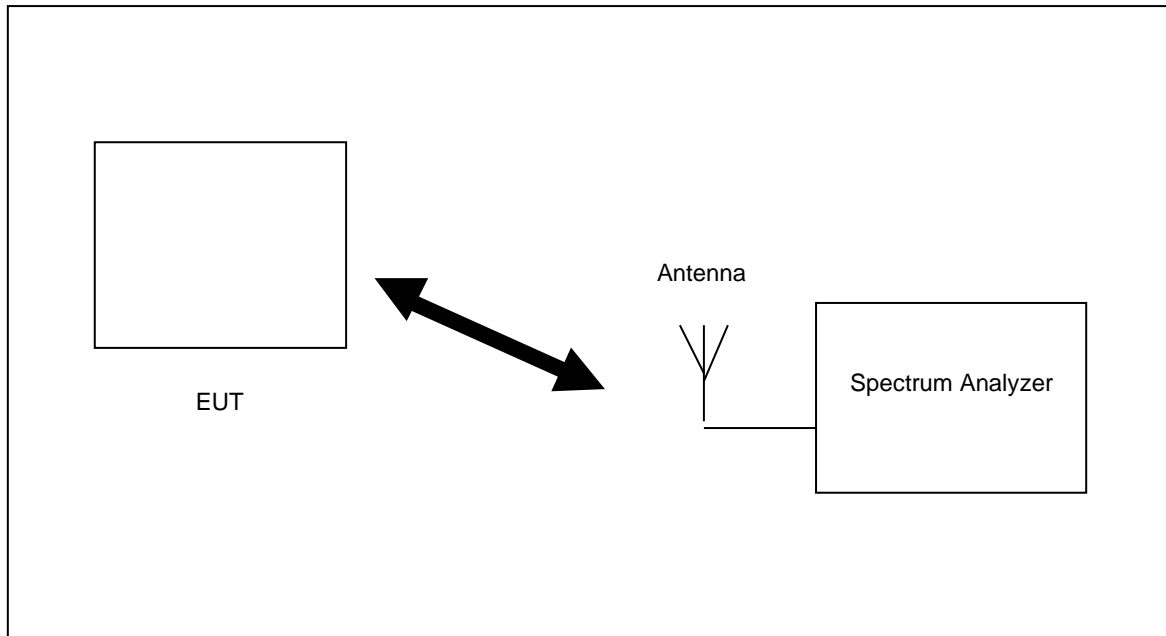

**TEST REPORT**

**6.5. RF Output Power Measurements**

Frequency	Channel	Duty Cycle	Maximum Tune-up Power (dBm)	Measured Conducted Power (Peak) (dBm)	Measured Conducted Power (Time Average) (dBm)
2405	1		18.00	16.48	4.3
2439	17	9.7%	18.00	16.74	4.6
2475	32		18.00	17.04	4.9

Note:

1. Time Average power (dBm) = Peak power (dBm) + Time Average factor.
2. Time Average factor =  $10 \cdot \log(\text{duty cycle})$ .
3. Per KDB 447498, the tested device was within the specified tune-up tolerances range, but not more than 2dB lower than the maximum tune-up tolerance limit.
4. Per KDB 447498, when antenna port was not available on the device to support conducted power measurement and test software was used to establish transmitter power levels, the power level was verified separately according to design and component specifications and product development information specified by the manufacturer.

## TEST REPORT

### 6.6. SAR Test Exclusion Consideration for Adjacent Edges

The Exemption limits for Routine Evaluation – SAR Evaluation in KDB 447498 D01 can be applied to determine SAR test exclusion for adjacent edge configurations.

The test separation distance for SAR test exclusion of adjacent edges is determined by the closest distance between the antenna and outer housing on the adjacent edge of the device.

According to the antenna to outer housing separation distance and maximum time-averaged output power as below, SAR evaluation of **front, top, left, right, back and bottom** edges are not required. However, client optional decided to keep Front position for data evaluation.

Exposure Position	Antenna to Outer Housing Separation Distance	SAR Exemption Limit	Maximum Time-Averaged Conducted Power	SAR Exclusion Result
Front	14 mm	26.7 mW		Test required <sup>1</sup>
Top	5 mm	9.5 mW		Excluded
Top (antenna extended)	4 mm	9.5 mW		Excluded
Left	30 mm	57.2 mW	6.12 mW	Excluded
Left (antenna extended)	122 mm	>95.3 mW		Excluded
Right	31 mm	59.1 mW		Excluded
Back	0 mm	9.5 mW		Excluded
Bottom	77 mm	>95.3 mW		Excluded

Note:

1. Client optional decided to keep Front position for data evaluation.

## TEST REPORT

### 6.7. Exposure Conditions

#### In-Front-of Mouth Exposure Conditions

Test Configurations	Distance to Phantom	Operation Mode	SAR Required	Note
Front 0mm Separation	Closed	Data	Yes <sup>1</sup>	
Front 0mm Separation	Extended	Data	Yes <sup>1</sup>	

Note:

1. Client optional decided to keep Front position for data evaluation.
2. Per KDB 447498 D01, SAR Evaluation can be applied to determine SAR test exclusion for adjacent edge configuration.

#### Body Exposure Conditions

Test Configurations	Distance to Phantom	Operation Mode	SAR Required	Note
Front 0mm Separation	Closed	Data	Yes <sup>1</sup>	
Top 0mm Separation	Closed	Data	No	SAR test exclusion applied
Left 0mm Separation	Closed	Data	No	SAR test exclusion applied
Right 0mm Separation	Closed	Data	No	SAR test exclusion applied
Back 0mm Separation	Closed	Data	No	SAR test exclusion applied
Bottom 0mm Separation	Closed	Data	No	SAR test exclusion applied
Front 0mm Separation	Extended	Data	No	SAR test exclusion applied
Top 0mm Separation	Extended	Data	No	SAR test exclusion applied
Left 0mm Separation	Extended	Data	No	SAR test exclusion applied
Right 0mm Separation	Extended	Data	No	SAR test exclusion applied
Back 0mm Separation	Extended	Data	No	SAR test exclusion applied
Bottom 0mm Separation	Extended	Data	No	SAR test exclusion applied

Note:

1. Client optional decided to keep Front position for data evaluation.
2. Per KDB 447498 D01, SAR Evaluation can be applied to determine SAR test exclusion for adjacent edge configuration.

**TEST REPORT**

**6.8. Test Result**

The results on the following page(s) were obtained when the device was tested in the condition described in this report. Detailed measurement data and plots, which reveal information about the location of the maximum SAR with respect to the device, are reported in Appendix B.

**In-Front-of Mouth SAR**

Chan	Freq. (MHz)	Battery	Mode	Test Position	Measurement Result						
					Maximum Allowed Power (dBm)	Measured Power (dBm)	SAR Drift (%)	Measured SAR <sub>1g</sub> (W/kg)	Scaling factor	Reported SAR <sub>1g</sub> (W/kg)	Plot
17	2439	3.7V	Data	Front 0mm	18	16.74	1.21	0.002	1.34	0.003	
17	2439	3.7V	Data	Front 0mm (antenna extended)	18	16.74	-1.65	0.017	1.34	0.023	2
1	2405	3.7V	Data	Front 0mm (antenna extended)	18	16.48	-1.37	0.014	1.42	0.020	
32	2475	3.7V	Data	Front 0mm (antenna extended)	18	17.04	-2.45	0.009	1.25	0.011	

Note:

1. Fully charged batteries were used at the beginning of each SAR measurement.
2. There was no power reduction used for any band/mode implemented in this device.
3. Reported SAR results were scaled to the maximum allowed power with the scaling factor equation  $-10^{[(\text{Maximum power} - \text{measured power}) / 10]}$ .
4. Per KDB 447498 D01, if the reported SAR value was  $\leq 0.8$  W/kg and the transmission band was  $\leq 100$ MHz, SAR testing was not required for the other test channels in the band.
5. Per KDB 865664 D01, repeated measurement was not required when the original highest measured SAR was  $< 0.8$ W/kg.



**TEST REPORT**

**6.8. Test Result (Cont'd)**  
**Body SAR**

Chan	Freq. (MHz)	Battery	Mode	Test Position	Measurement Result						
					Maximum Allowed Power (dBm)	Measured Power (dBm)	SAR Drift (%)	Measured SAR <sub>1g</sub> (W/kg)	Scaling factor	Reported SAR <sub>1g</sub> (W/kg)	Plot
17	2439	3.7V	Data	Front Omm	18	16.74	1.21	0.002	1.337	0.003	
17	2439	3.7V	Data	Top Omm	18	16.74	-2.39	0.021	1.337	0.028	
17	2439	3.7V	Data	Back Omm	18	16.74	-1.82	0.033	1.337	0.044	
17	2439	3.7V	Data	Front Omm (antenna extended)	18	16.74	-1.65	0.017	1.337	0.023	
17	2439	3.7V	Data	Top Omm (antenna extended)	18	16.74	0.92	0.018	1.337	0.024	
17	2439	3.7V	Data	Back Omm (antenna extended)	18	16.74	-1.51	0.119	1.337	0.159	3
1	2405	3.7V	Data	Back Omm (antenna extended)	18	16.48	-1.08	0.048	1.419	0.068	
32	2475	3.7V	Data	Back Omm (antenna extended)	18	17.04	-1.67	0.033	1.247	0.041	

Note:

- Fully charged batteries were used at the beginning of each SAR measurement.
- There was no power reduction used for any band/mode implemented in this device.
- Reported SAR results were scaled to the maximum allowed power with the scaling factor equation  $-10^{((Maximum\ power - measured\ power) / 10)}$ .
- Per RSS 102 Issue 5, when the maximum output power variation across the required test channels was less than 0.5 dB above the output power of the mid-channel, mid-channel shall first be tested.
- Per KDB 447498 D01, when the reported SAR is > 0.8 W/kg, SAR is required for that exposure configuration using the next highest measured output power channel. When any reported SAR is > 1.2 W/kg, SAR is required for the third channel; i.e., all channels require testing.
- Per RSS-102 Issue 5, the low, middle and high frequency channels for the configuration with the highest SAR value must be tested regardless of the SAR value measured.

## TEST REPORT

### 6.9. SAR Limits

The following FCC limits (Std. C95.1-1992) for SAR apply to devices operate in General Population/Uncontrolled Exposure and Controlled environment:

#### GENERAL POPULATION / UNCONTROLLED ENVIRONMENTS:

Defined as location where there is the exposure of individuals who have no knowledge or control of their exposure.

EXPOSURE (General Population/Uncontrolled Exposure environment)	SAR (W/kg)
Spatial Peak SAR (Head)*	1.60
Spatial Peak SAR (Partial Body)*	1.60
Spatial Peak SAR (Whole Body)*	0.08
Spatial Peak SAR (Hands / Wrists / Feet / Ankles)**	4.00

#### OCCUPATIONAL / CONTROLLED ENVIRONMENTS:

Defined as location where there is the exposure that may be incurred by persons who are aware of the potential for exposure, (i.e. as a result of employment or occupation)

EXPOSURE (Occupational/Controlled Exposure environment)	SAR (W/kg)
Spatial Peak SAR (Head)*	8.00
Spatial Peak SAR (Partial Body)*	8.00
Spatial Peak SAR (Whole Body)*	0.40
Spatial Peak SAR (Hands / Wrists / Feet / Ankles)**	20.00

#### Notes:

- \* The Spatial Peak value of the SAR averaged over any 1 gram of tissue.  
(defined as a tissue volume in the shape of a cube) and over the appropriate averaging time
- \*\* The Spatial Peak value of the SAR averaged over any 10 gram of tissue.  
(defined as a tissue volume in the shape of a cube) and over the appropriate averaging time

## TEST REPORT

### 7. TEST EQUIPMENT LIST

Equipment	Registration No.	Manufacturer	Model No.	Calibration Date	Calibration Due Date
SAR System	EW-3211	MVG	SATIMO System (OpenSAR Software V4_02_34)	N/A	N/A
Phantom	EW-3211	SATIMO	COMOSAR SAM PHANTOM	N/A	N/A
Digital Multimeter	EW-3206	KEITHLEY	2000	27 Jul 2021	27 Jul 2022
SAR Probe	EW-3210	MVG	SSE2 (SN 36/20 EPGO347)	02 Nov 2021	02 Nov 2022
SAR Dipole	EW-3212	MVG	SN 22/16 DIP2G450-411	02 Nov 2021	02 Nov 2024
Dielectric Probe for SAR Test	EW-3213	MVG	Liquid Measurement Kit (SN 24/16 OCPG 76)	02 Nov 2021	02 Nov 2022
Head Liquid Tissue	N/A	MVG	Head Liquid 2450MHz	Refer to Section 4	
Body Liquid Tissue	N/A	MVG	Body Liquid 2450MHz	Refer to Section 4	
Network Analyzer	EW-3192	Rhode & Schwarz	ZVL6	27 Jul 2021	27 Jul 2022
Vector Signal Generator	EW-3063	ROHDESCHWARZ	SMBV100A	24 Jul 2021	24 Jul 2022
Plastic Ruler	EW-3084	MUJI	30cm	23 Jan 2022	23 Jan 2023
Signal and Spectrum Analyzer (10Hz to 40GHz)	EW-3016	Rhode & Schwarz	FSV40	29 Oct 2021	29 Oct 2022
Precision Dual Coupler (0.8-3GHz 20dB)	EW-3184	VectaWave USA	VDC0830-20	30 Nov 2021	30 Nov 2022
Wideband power sensor 2 pcs 50MHz to 18GHz	EW-3309	ROHDESCHWARZ	NRP-Z81	01 Dec 2021	01 Dec 2022
SAR Amplifier	EW-3275	MVG	0.4-6GHz	11 Nov 2021	11 Nov 2022
Thermo-HyGrometer	EW-3046	Oregon Scientific	THG312	07 Aug 2021	07 Aug 2022
Digital Thermo-Meter For SAR test	EW-2901	TES	1306	08 Dec 2021	08 Dec 2022

## TEST REPORT

### 8. MEASUREMENT UNCERTAINTY

Per FCC KDB 865884, the extensive SAR measurement uncertainty analysis was not required when the highest measured SAR was  $< 1.5\text{W/kg}$  for all frequency band.

## TEST REPORT

**TABLE 1 EXPOSURE ASSESSMENT UNCERTAINTY FOR HEAD SAR**

Uncertainty Component	Tol. (± %)	Prob. Dist.	Div.	c <sub>1</sub> (1 g)	c <sub>1</sub> (10 g)	1 g u <sub>i</sub> (± %)	10 g u <sub>i</sub> (± %)	v <sub>i</sub>
<b>Measurement System</b>								
Probe Calibration	5.8	N	1	1	1	5.8	5.8	∞
Axial Isotropy	3.5	R	√3	√0.5	√0.5	1.43	1.43	∞
Hemispherical Isotropy	5.9	R	√3	√0.5	√0.5	2.41	2.41	∞
Boundary Effect	1	R	√3	1	1	0.58	0.58	∞
Linearity	4.7	R	√3	1	1	2.71	2.71	∞
System Detection Limits	1	R	√3	1	1	0.58	0.58	∞
Modulation response	3	R	√3	1	1	1.73	1.73	∞
Readout Electronics	0.5	N	1	1	1	0.50	0.50	∞
Response Time	0	R	√3	1	1	0.00	0.00	∞
Integration Time	1.4	R	√3	1	1	0.81	0.81	∞
RF Ambient Conditions - Noise	3	R	√3	1	1	1.73	1.73	∞
RF Ambient Conditions - Reflections	3	R	√3	1	1	1.73	1.73	∞
Probe Positioner Mechanical Tolerance	1.4	R	√3	1	1	0.81	0.81	∞
Probe Positioning with respect to Phantom Shell	1.4	R	√3	1	1	0.81	0.81	∞
Extrapolation, interpolation and Integration Algorithms for Max. SAR Evaluation	2.3	R	√3	1	1	1.33	1.33	∞
<b>Test sample Related</b>								
Test Sample Positioning	2.6	N	1	1	1	2.60	2.60	11
Device Holder Uncertainty	3	N	1	1	1	3.00	3.00	7
Output Power Variation - SAR drift measurement	5	R	√3	1	1	2.89	2.89	∞
SAR scaling	2	R	√3	1	1	1.15	1.15	∞
<b>Phantom and Tissue Parameters</b>								
Phantom Shell Uncertainty - Shape, Thickness and Permittivity	4	R	√3	1	1	2.31	2.31	∞
Uncertainty in SAR correction for deviation in permittivity and conductivity	2	N	1	1	0.84	2.00	1.68	∞
Liquid Conductivity Measurement	4	N	1	0.78	0.71	3.12	2.84	5
Liquid Permittivity Measurement	5	N	1	0.23	0.26	1.15	1.30	5
Liquid Conductivity - Temperature Uncertainty	2.5	R	√3	0.78	0.71	1.13	1.02	∞
Liquid Permittivity - Temperature Uncertainty	2.5	R	√3	0.23	0.26	0.33	0.38	∞
<b>Combined Standard Uncertainty</b>		RSS				10.47	10.34	
<b>Expanded Uncertainty (95% CONFIDENCE INTERVAL)</b>		k				20.95	20.69	

## TEST REPORT

**TABLE 2 SYSTEM VALIDATION FOR HEAD LIQUID**

Uncertainty Component	Tol. (± %)	Prob. Dist.	Div.	c <sub>i</sub> (1 g)	c <sub>i</sub> (10 g)	1 g u <sub>i</sub> (± %)	10 g u <sub>i</sub> (± %)	v <sub>i</sub>
<b>Measurement System</b>								
Probe Calibration	5.8	N	1	1	1	5.80	5.80	∞
Axial Isotropy	3.5	R	√3	1	1	2.02	2.02	∞
Hemispherical Isotropy	5.9	R	√3	0	0	0.00	0.00	∞
Boundary Effect	1	R	√3	1	1	0.58	0.58	∞
Linearity	4.7	R	√3	1	1	2.71	2.71	∞
System Detection Limits	1	R	√3	1	1	0.58	0.58	∞
Modulation response	0	N	√3	0	0	0.00	0.00	∞
Readout Electronics	0.5	N	1	1	1	0.50	0.50	∞
Response Time	0	R	√3	0	0	0.00	0.00	∞
Integration Time	1.4	R	√3	0	0	0.00	0.00	∞
RF Ambient Conditions - Noise	3	R	√3	1	1	1.73	1.73	∞
RF Ambient Conditions - Reflections	3	R	√3	1	1	1.73	1.73	∞
Probe Positioner Mechanical Tolerance	1.4	R	√3	1	1	0.81	0.81	∞
Probe Positioning with respect to Phantom Shell	1.4	R	√3	1	1	0.81	0.81	∞
Extrapolation, interpolation and Integration Algorithms for Max. SAR Evaluation	2.3	R	√3	1	1	1.33	1.33	∞
<b>Dipole</b>								
Deviation of experimental source from numerical source	5	N	1	1	1	5.00	5.00	∞
Input Power and SAR drift measurement	0.5	R	√3	1	1	0.29	0.29	∞
Dipole Axis to Liquid Distance	2	R	√3	1	1	1.15	1.15	∞
<b>Phantom and Tissue Parameters</b>								
Phantom Shell Uncertainty - Thickness and Permittivity	4	R	√3	1	1	2.31	2.31	∞
Uncertainty in SAR correction for deviation in permittivity and conductivity	2	N	1	1	0.84	2.00	1.68	∞
Liquid Conductivity Measurement	4	N	1	0.78	0.71	3.12	2.84	5
Liquid Permittivity Measurement	5	N	1	0.23	0.26	1.15	1.30	5
Liquid Conductivity - Temperature Uncertainty	2.5	R	√3	0.78	0.71	1.13	1.02	∞
Liquid Permittivity - Temperature Uncertainty	2.5	R	√3	0.23	0.26	0.33	0.38	∞
<b>Combined Standard Uncertainty</b>		RSS				10.16	10.03	
<b>Expanded Uncertainty (95% CONFIDENCE INTERVAL)</b>		k				20.32	20.06	

## TEST REPORT

**TABLE 3 EXPOSURE ASSESSMENT UNCERTAINTY FOR BODY SAR**

Uncertainty Component	Tol. (± %)	Prob. Dist.	Div.	c <sub>i</sub> (1 g)	c <sub>i</sub> (10 g)	1 g u <sub>i</sub> (± %)	10 g u <sub>i</sub> (± %)	v <sub>i</sub>
<b>Measurement System</b>								
Probe Calibration	5.8	N	1	1	1	5.8	5.8	∞
Axial Isotropy	3.5	R	√3	√0.5	√0.5	1.43	1.43	∞
Hemispherical Isotropy	5.9	R	√3	√0.5	√0.5	2.41	2.41	∞
Boundary Effect	1	R	√3	1	1	0.58	0.58	∞
Linearity	4.7	R	√3	1	1	2.71	2.71	∞
System Detection Limits	1	R	√3	1	1	0.58	0.58	∞
Modulation response	3	R	√3	1	1	1.73	1.73	∞
Readout Electronics	0.5	N	1	1	1	0.50	0.50	∞
Response Time	0	R	√3	1	1	0.00	0.00	∞
Integration Time	1.4	R	√3	1	1	0.81	0.81	∞
RF Ambient Conditions - Noise	3	R	√3	1	1	1.73	1.73	∞
RF Ambient Conditions - Reflections	3	R	√3	1	1	1.73	1.73	∞
Probe Positioner Mechanical Tolerance	1.4	R	√3	1	1	0.81	0.81	∞
Probe Positioning with respect to Phantom Shell	1.4	R	√3	1	1	0.81	0.81	∞
Extrapolation, interpolation and Integration Algorithms for Max. SAR Evaluation	2.3	R	√3	1	1	1.33	1.33	∞
<b>Test sample Related</b>								
Test Sample Positioning	2.6	N	1	1	1	2.60	2.60	11
Device Holder Uncertainty	3	N	1	1	1	3.00	3.00	7
Output Power Variation - SAR drift measurement	5	R	√3	1	1	2.89	2.89	∞
SAR scaling	2	R	√3	1	1	1.15	1.15	∞
<b>Phantom and Tissue Parameters</b>								
Phantom Shell Uncertainty - Shape, Thickness and Permittivity	4	R	√3	1	1	2.31	2.31	∞
Uncertainty in SAR correction for deviation in permittivity and conductivity	2	N	1	1	0.84	2.00	1.68	∞
Liquid Conductivity Measurement	4	N	1	0.78	0.71	3.12	2.84	5
Liquid Permittivity Measurement	5	N	1	0.23	0.26	1.15	1.30	5
Liquid Conductivity - Temperature Uncertainty	2.5	R	√3	0.78	0.71	1.13	1.02	∞
Liquid Permittivity - Temperature Uncertainty	2.5	R	√3	0.23	0.26	0.33	0.38	∞
<b>Combined Standard Uncertainty</b>		RSS				10.47	10.34	
<b>Expanded Uncertainty (95% CONFIDENCE INTERVAL)</b>		k				20.95	20.69	

**TEST REPORT**

**TABLE 4 SYSTEM VALIDATION FOR BODY LIQUID**

Uncertainty Component	Tol. (± %)	Prob. Dist.	Div.	c <sub>i</sub> (1 g)	c <sub>i</sub> (10 g)	1 g u <sub>i</sub> (± %)	10 g u <sub>i</sub> (± %)	v <sub>i</sub>
<b>Measurement System</b>								
Probe Calibration	5.8	N	1	1	1	5.80	5.80	∞
Axial Isotropy	3.5	R	√3	1	1	2.02	2.02	∞
Hemispherical Isotropy	5.9	R	√3	0	0	0.00	0.00	∞
Boundary Effect	1	R	√3	1	1	0.58	0.58	∞
Linearity	4.7	R	√3	1	1	2.71	2.71	∞
System Detection Limits	1	R	√3	1	1	0.58	0.58	∞
Modulation response	0	N	√3	0	0	0.00	0.00	∞
Readout Electronics	0.5	N	1	1	1	0.50	0.50	∞
Response Time	0	R	√3	0	0	0.00	0.00	∞
Integration Time	1.4	R	√3	0	0	0.00	0.00	∞
RF Ambient Conditions - Noise	3	R	√3	1	1	1.73	1.73	∞
RF Ambient Conditions - Reflections	3	R	√3	1	1	1.73	1.73	∞
Probe Positioner Mechanical Tolerance	1.4	R	√3	1	1	0.81	0.81	∞
Probe Positioning with respect to Phantom Shell	1.4	R	√3	1	1	0.81	0.81	∞
Extrapolation, interpolation and Integration Algorithms for Max. SAR Evaluation	2.3	R	√3	1	1	1.33	1.33	∞
<b>Dipole</b>								
Deviation of experimental source from numerical source	5	N	1	1	1	5.00	5.00	∞
Input Power and SAR drift measurement	0.5	R	√3	1	1	0.29	0.29	∞
Dipole Axis to Liquid Distance	2	R	√3	1	1	1.15	1.15	∞
<b>Phantom and Tissue Parameters</b>								
Phantom Shell Uncertainty - Thickness and Permittivity	4	R	√3	1	1	2.31	2.31	∞
Uncertainty in SAR correction for deviation in permittivity and conductivity	2	N	1	1	0.84	2.00	1.68	∞
Liquid Conductivity Measurement	4	N	1	0.78	0.71	3.12	2.84	5
Liquid Permittivity Measurement	5	N	1	0.23	0.26	1.15	1.30	5
Liquid Conductivity - Temperature Uncertainty	2.5	R	√3	0.78	0.71	1.13	1.02	∞
Liquid Permittivity - Temperature Uncertainty	2.5	R	√3	0.23	0.26	0.33	0.38	∞
<b>Combined Standard Uncertainty</b>		RSS				10.16	10.03	
<b>Expanded Uncertainty (95% CONFIDENCE INTERVAL)</b>		k				20.32	20.06	



## TEST REPORT

### 9. E-FIELD PROBE AND DIPOLE ANTENNA CALIBRATION

Probe calibration factors and dipole antenna calibration are included in Appendix C.

**TEST REPORT**

**APPENDIX A – SYSTEM CHECK DATA**

Plot #1

Operating Frequency: 2450MHz

Test Date: June 27, 2022

Medium (Liquid Type)	: 2450 Head
Relative permittivity $\epsilon_r$	: 40.3
Conductivity $\sigma$ :	: 1.84
Probe	: Model: SSE2; Serial No.: SN 36/20 EPG0347
Crest factor	: 1.0
Conversion Factor	: 2.36
Area Scan	: dx=8mm, dy=8mm
Zoom Scan	: 7x7x7,dx=5mm dy=5mm dz=5mm
Phantom	: SAM phantom
Device Position	: Dipole
SAR Drift (%)	: 0.13%
Maximum location	: X=1.00, Y=1.00
SAR Peak (W/kg)	: 9.00 W/kg
SAR 10g (W/kg)	: 2.775 W/kg
SAR 1g (W/kg)	: 5.486 W/kg

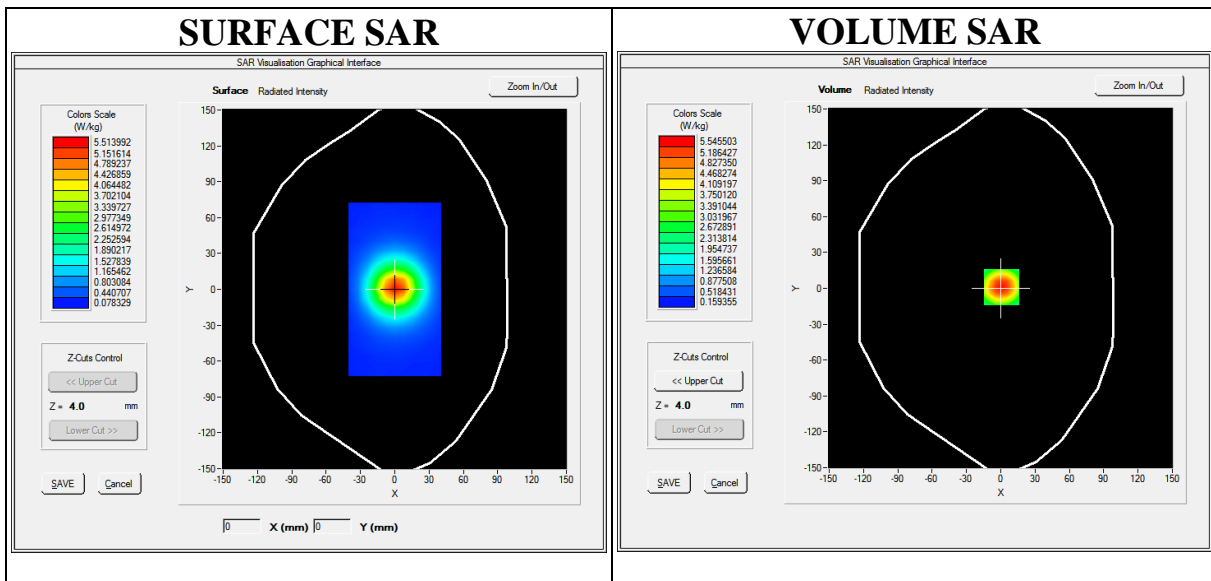

**TEST REPORT**

**APPENDIX B – SAR EVALUATION DATA**

Plot #1

Operating Frequency: 2439MHz

Product Description: Video Monitor - Parent Unit

Model: VM5463 PU (3.7VDC (1 x 3.7V 5000mAh 18.5Wh Li-Polymer rechargeable battery))

Test Date: June 27, 2022

Medium (Liquid Type)	: 2450 Head
Relative permittivity $\epsilon_r$	: 40.3
Conductivity $\sigma$ :	: 1.84
Probe	: Model: SSE2; Serial No.: SN 36/20 EPG0347
Crest factor	: 1.0
Conversion Factor	: 2.36
Area Scan	: dx=8mm, dy=8mm
Zoom Scan	: 7x7x7,dx=5mm dy=5mm dz=5mm
Phantom	: SAM phantom
Device Position	: front 0mm separation (antenna extended)
SAR Drift (%)	: -1.65%
Maximum location	: X=-5.00, Y=13.00
SAR Peak (W/kg)	: 0.06 W/kg
SAR 10g (W/kg)	: 0.0098 W/kg
SAR 1g (W/kg)	: 0.0174 W/kg

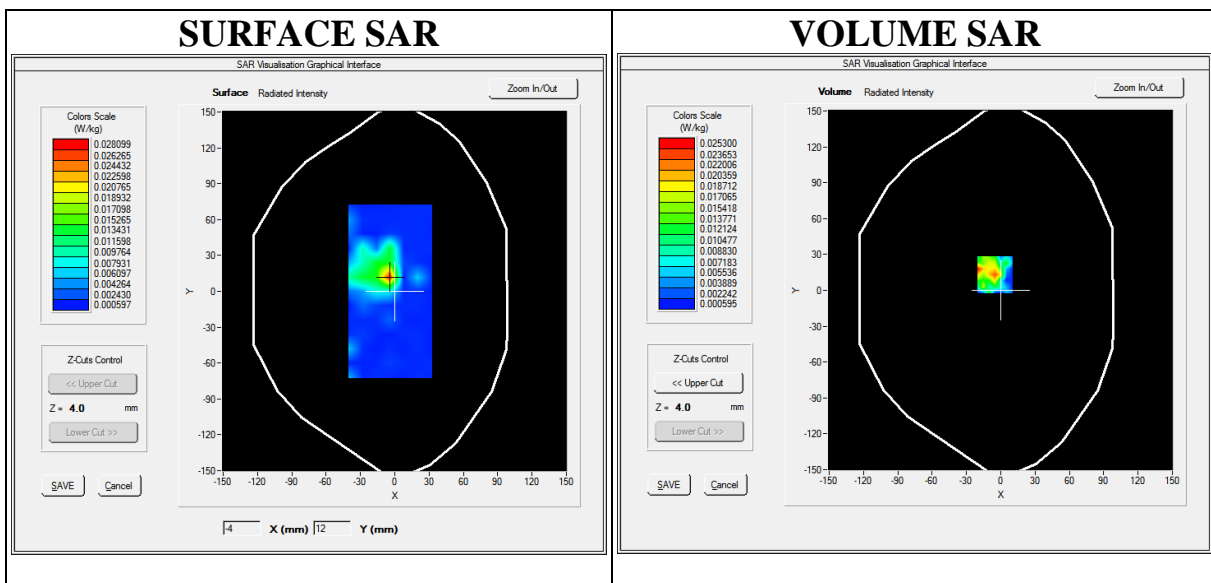

**TEST REPORT**

**APPENDIX B – SAR EVALUATION DATA**

Plot #3

Operating Frequency: 2439MHz

Product Description: Video Monitor - Parent Unit

HVIN: 35-201952PU (3.7VDC (1 x 3.7V 5000mAh 18.5Wh Li-Polymer rechargeable battery))

Test Date: June 27, 2022

Medium (Liquid Type)	: 2450 Head
Relative permittivity $\epsilon_r$	: 40.3
Conductivity $\sigma$ :	: 1.84
Probe	: Model: SSE2; Serial No.: SN 36/20 EPG0347
Crest factor	: 1.0
Conversion Factor	: 2.36
Area Scan	: dx=8mm, dy=8mm
Zoom Scan	: 7x7x7,dx=5mm dy=5mm dz=5mm
Phantom	: SAM phantom
Device Position	: Back 0mm separation (antenna extended)
SAR Drift (%)	: -1.51%
Maximum location	: X=-3.00, Y=-1.00
SAR Peak (W/kg)	: 0.25 W/kg
SAR 10g (W/kg)	: 0.0453 W/kg
SAR 1g (W/kg)	: 0.1189 W/kg

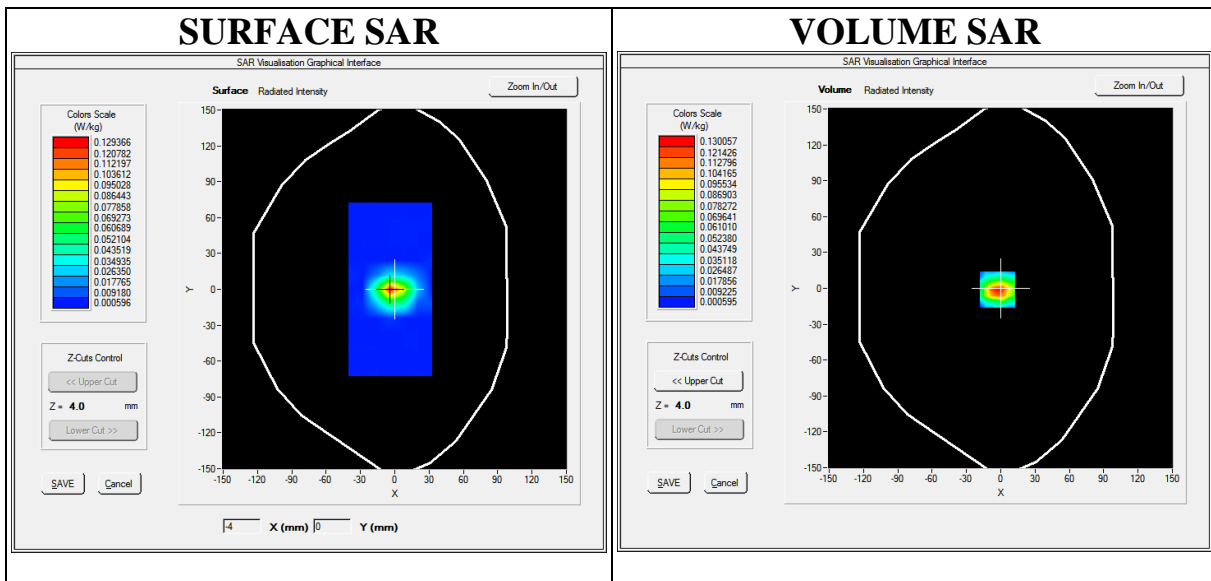

**TEST REPORT**

**APPENDIX C – E-FIELD PROBE AND DIPOLE ANTENNA CALIBRATION**



# COMOSAR E-Field Probe Calibration Report

Ref : ACR.307.26.21.BES.B

Cancel and replace the report ACR.307.26.21.BES.A

## INTERTEK TESTING SERVICES HONG KONG LIMITED

WORKSHOP NO. 3 G/F, WORLD-WIDE INDUSTRIAL  
CENTRE, 43-47 SHAN MEI STREET,  
FO TAN, SHA TIN, N.T. HONG KONG  
MVG COMOSAR DOSIMETRIC E-FIELD PROBE  
SERIAL NO.: SN 36/20 EPGO347

Calibrated at MVG

Z.I. de la pointe du diable

Technopôle Brest Iroise – 295 avenue Alexis de Rochon

29280 PLOUZANE - FRANCE

Calibration date: 11/2/2021



Accreditations #2-6789  
Scope available on [www.cofrac.fr](http://www.cofrac.fr)

**The use of the Cofrac brand and the accreditation references is prohibited from any reproduction.**

### Summary:

This document presents the method and results from an accredited COMOSAR E-Field Probe calibration performed at MVG, using the CALIPROBE test bench, for use with a MVG COMOSAR system only. The test results covered by accreditation are traceable to the International System of Units (SI).



	<i>Name</i>	<i>Function</i>	<i>Date</i>	<i>Signature</i>
<i>Prepared by :</i>	Jérôme Le Gall	Measurement Responsible	11/3/2021	
<i>Checked by :</i>	Jérôme Luc	Technical Manager	11/3/2021	
<i>Approved by :</i>	Yann Toutain	Laboratory Director	11/10/2021	

	<i>Customer Name</i>
<i>Distribution :</i>	Intertek Testing Services Hong Kong Limited

<i>Issue</i>	<i>Name</i>	<i>Date</i>	<i>Modifications</i>
A	Jérôme Luc	11/3/2021	Initial release
B	Jérôme Luc	11/10/2021	Add EN standard



**TABLE OF CONTENTS**

1 Device Under Test ..... 4

2 Product Description ..... 4

    2.1 General Information ..... 4

3 Measurement Method ..... 4

    3.1 Linearity ..... 4

    3.2 Sensitivity ..... 5

    3.3 Lower Detection Limit ..... 5

    3.4 Isotropy ..... 5

    3.1 Boundary Effect ..... 5

4 Measurement Uncertainty ..... 6

5 Calibration Measurement Results ..... 6

    5.1 Sensitivity in air ..... 6

    5.2 Linearity ..... 7

    5.3 Sensitivity in liquid ..... 8

    5.4 Isotropy ..... 9

6 List of Equipment ..... 10



## 1 DEVICE UNDER TEST

Device Under Test	
Device Type	COMOSAR DOSIMETRIC E FIELD PROBE
Manufacturer	MVG
Model	SSE2
Serial Number	SN 36/20 EPGO347
Product Condition (new / used)	Used
Frequency Range of Probe	0.15 GHz-6GHz
Resistance of Three Dipoles at Connector	Dipole 1: R1=0.227 MΩ Dipole 2: R2=0.231 MΩ Dipole 3: R3=0.211 MΩ

## 2 PRODUCT DESCRIPTION

### 2.1 GENERAL INFORMATION

MVG's COMOSAR E field Probes are built in accordance to the IEC/IEEE 62209-1528, EN 62209-1/2 and FCC KDB865664 D01 standards.



**Figure 1 – MVG COMOSAR Dosimetric E field Dipole**

Probe Length	330 mm
Length of Individual Dipoles	2 mm
Maximum external diameter	8 mm
Probe Tip External Diameter	2.5 mm
Distance between dipoles / probe extremity	1 mm

## 3 MEASUREMENT METHOD

The IEC/IEEE 62209-1528, EN 62209-1/2 and FCC KDB865664 D01 standards provide recommended practices for the probe calibrations, including the performance characteristics of interest and methods by which to assess their affect. All calibrations / measurements performed meet the fore mentioned standards.

### 3.1 LINEARITY

The evaluation of the linearity was done in free space using the waveguide, performing a power sweep to cover the SAR range 0.01W/kg to 100W/kg.

### 3.2 SENSITIVITY

The sensitivity factors of the three dipoles were determined using a two step calibration method (air and tissue simulating liquid) using waveguides as outlined in the standards.

### 3.3 LOWER DETECTION LIMIT

The lower detection limit was assessed using the same measurement set up as used for the linearity measurement. The required lower detection limit is 10 mW/kg.

### 3.4 ISOTROPY

The axial isotropy was evaluated by exposing the probe to a reference wave from a standard dipole with the dipole mounted under the flat phantom in the test configuration suggested for system validations and checks. The probe was rotated along its main axis from 0 to 360 degrees in 15-degree steps. The hemispherical isotropy is determined by inserting the probe in a thin plastic box filled with tissue-equivalent liquid, with the plastic box illuminated with the fields from a half wave dipole. The dipole is rotated about its axis (0°–180°) in 15° increments. At each step the probe is rotated about its axis (0°–360°).

### 3.1 BOUNDARY EFFECT

The boundary effect is defined as the deviation between the SAR measured data and the expected exponential decay in the liquid when the probe is oriented normal to the interface. To evaluate this effect, the liquid filled flat phantom is exposed to fields from either a reference dipole or waveguide. With the probe normal to the phantom surface, the peak spatial average SAR is measured and compared to the analytical value at the surface.

The boundary effect uncertainty can be estimated according to the following uncertainty approximation formula based on linear and exponential extrapolations between the surface and  $d_{be} + d_{step}$  along lines that are approximately normal to the surface:

$$SAR_{uncertainty} [\%] = \Delta SAR_{be} \frac{(d_{be} + d_{step})^2}{2d_{step}} \frac{(e^{-d_{be}/\delta})}{\delta/2} \quad \text{for } (d_{be} + d_{step}) < 10 \text{ mm}$$

where

- $SAR_{uncertainty}$  is the uncertainty in percent of the probe boundary effect
- $d_{be}$  is the distance between the surface and the closest *zoom-scan* measurement point, in millimetre
- $\Delta_{step}$  is the separation distance between the first and second measurement points that are closest to the phantom surface, in millimetre, assuming the boundary effect at the second location is negligible
- $\delta$  is the minimum penetration depth in millimetres of the head tissue-equivalent liquids defined in this standard, i.e.,  $\delta \approx 14$  mm at 3 GHz;
- $\Delta SAR_{be}$  in percent of SAR is the deviation between the measured SAR value, at the distance  $d_{be}$  from the boundary, and the analytical SAR value.

The measured worst case boundary effect SARuncertainty[%] for scanning distances larger than 4mm is 1.0% Limit ,2%).

#### 4 MEASUREMENT UNCERTAINTY

The guidelines outlined in the IEC/IEEE 62209-1528, EN 62209-1/2 and FCC KDB865664 D01 standards were followed to generate the measurement uncertainty associated with an E-field probe calibration using the waveguide technique. All uncertainties listed below represent an expanded uncertainty expressed at approximately the 95% confidence level using a coverage factor of k=2, traceable to the Internationally Accepted Guides to Measurement Uncertainty.

Uncertainty analysis of the probe calibration in waveguide					
ERROR SOURCES	Uncertainty value (%)	Probability Distribution	Divisor	ci	Standard Uncertainty (%)
Expanded uncertainty 95 % confidence level k = 2					14 %

#### 5 CALIBRATION MEASUREMENT RESULTS

Calibration Parameters	
Liquid Temperature	20 +/- 1 °C
Lab Temperature	20 +/- 1 °C
Lab Humidity	30-70 %

##### 5.1 SENSITIVITY IN AIR

Normx dipole 1 (µV/(V/m) <sup>2</sup> )	Normy dipole 2 (µV/(V/m) <sup>2</sup> )	Normz dipole 3 (µV/(V/m) <sup>2</sup> )
0.80	0.59	0.77

DCP dipole 1 (mV)	DCP dipole 2 (mV)	DCP dipole 3 (mV)
109	110	109

Calibration curves  $e_i=f(V)$  (i=1,2,3) allow to obtain E-field value using the formula:

$$E = \sqrt{E_1^2 + E_2^2 + E_3^2}$$

### Calibration curves

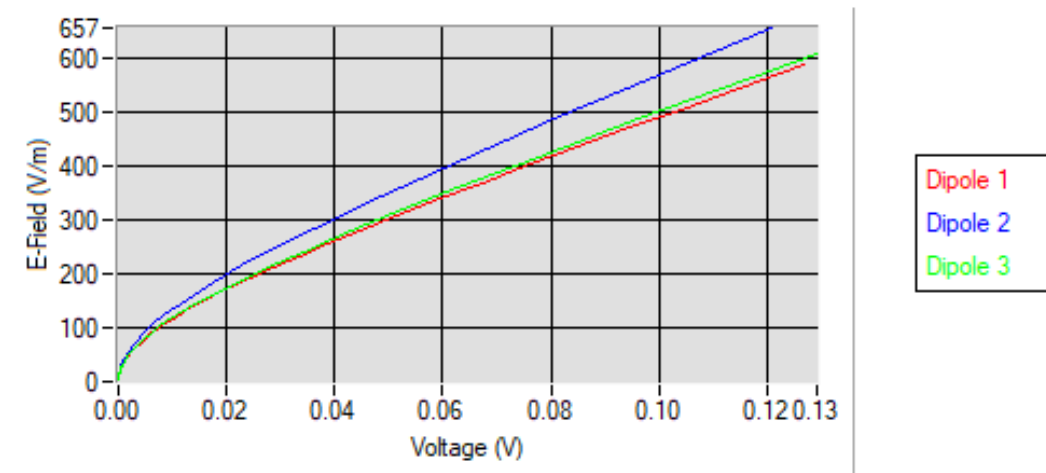

## 5.2 LINEARITY

### Linearity

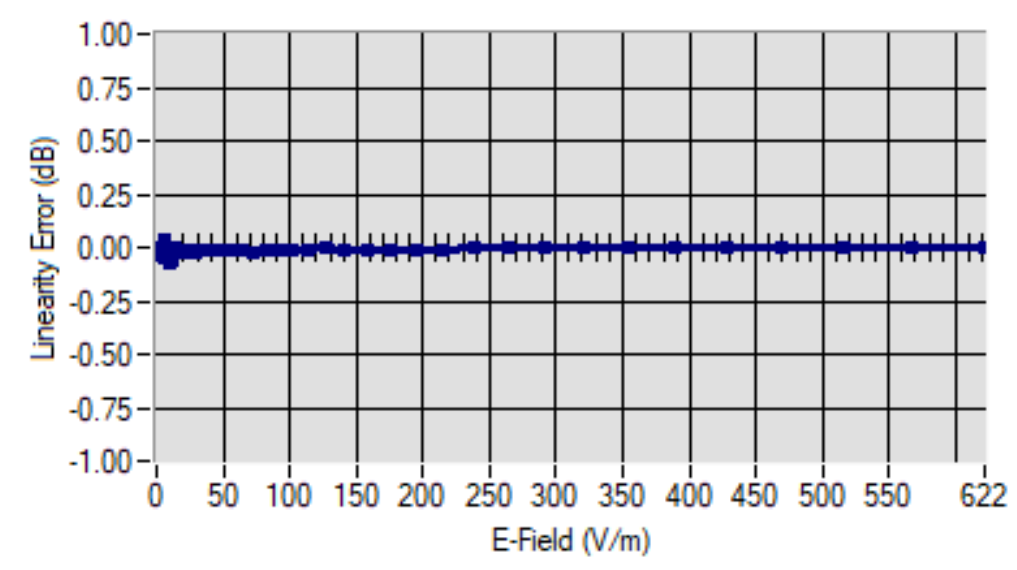

**Linearity: +/-1.70% (+/-0.07dB)**



5.3 SENSITIVITY IN LIQUID

<u>Liquid</u>	<u>Frequency (MHz +/- 100MHz)</u>	<u>ConvF</u>
HL450*	450	1.93
BL450*	450	1.90
HL750	750	1.69
BL750	750	1.80
HL850	835	1.69
BL850	835	1.74
HL900	900	1.77
BL900	900	1.80
HL1800	1800	2.13
BL1800	1800	2.17
HL1900	1900	2.08
BL1900	1900	2.35
HL2000	2000	2.40
BL2000	2000	2.58
HL2300	2300	2.53
BL2300	2300	2.85
HL2450	2450	2.36
BL2450	2450	2.85
HL2600	2600	2.42
BL2600	2600	2.77
HL5200	5200	2.66
BL5200	5200	2.60
HL5400	5400	2.60
BL5400	5400	2.39
HL5600	5600	2.70
BL5600	5600	2.48
HL5800	5800	2.56
BL5800	5800	2.50

\* Frequency not covered by COFRAC scope, calibration not accredited

LOWER DETECTION LIMIT: 8mW/kg

## 5.4 ISOTROPY

### HL1800 MHz

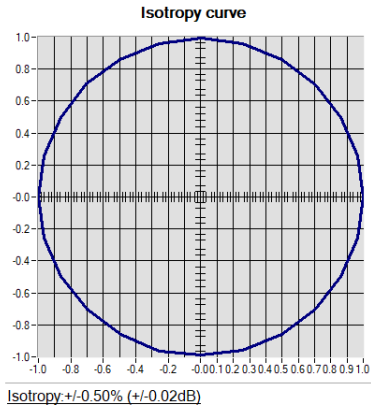

6 LIST OF EQUIPMENT

Equipment Summary Sheet				
Equipment Description	Manufacturer / Model	Identification No.	Current Calibration Date	Next Calibration Date
CALIPROBE Test Bench	Version 2	NA	Validated. No cal required.	Validated. No cal required.
Network Analyzer	Rohde & Schwarz ZVM	100203	08/2021	08/2024
Network Analyzer	Agilent 8753ES	MY40003210	10/2019	10/2022
Network Analyzer – Calibration kit	Rohde & Schwarz ZV-Z235	101223	05/2019	05/2022
Network Analyzer – Calibration kit	HP 85033D	3423A08186	06/2021	06/2027
Multimeter	Keithley 2000	1160271	02/2020	02/2023
Signal Generator	Rohde & Schwarz SMB	106589	04/2019	04/2022
Amplifier	MVG	MODU-023-C-0002	Characterized prior to test. No cal required.	Characterized prior to test. No cal required.
Power Meter	NI-USB 5680	170100013	06/2021	06/2024
Power Meter	Rohde & Schwarz NRVD	832839-056	11/2019	11/2022
Directional Coupler	Krytar 158020	131467	Characterized prior to test. No cal required.	Characterized prior to test. No cal required.
Waveguide	MVG	SN 32/16 WG4_1	Validated. No cal required.	Validated. No cal required.
Liquid transition	MVG	SN 32/16 WGLIQ_0G900_1	Validated. No cal required.	Validated. No cal required.
Waveguide	MVG	SN 32/16 WG6_1	Validated. No cal required.	Validated. No cal required.
Liquid transition	MVG	SN 32/16 WGLIQ_1G500_1	Validated. No cal required.	Validated. No cal required.
Waveguide	MVG	SN 32/16 WG8_1	Validated. No cal required.	Validated. No cal required.
Liquid transition	MVG	SN 32/16 WGLIQ_1G800B_1	Validated. No cal required.	Validated. No cal required.
Liquid transition	MVG	SN 32/16 WGLIQ_1G800H_1	Validated. No cal required.	Validated. No cal required.
Waveguide	MVG	SN 32/16 WG10_1	Validated. No cal required.	Validated. No cal required.
Liquid transition	MVG	SN 32/16 WGLIQ_3G500_1	Validated. No cal required.	Validated. No cal required.



COMOSAR E-FIELD PROBE CALIBRATION REPORT

Ref: ACR.307.26.21.BES.B

Waveguide	MVG	SN 32/16 WG12_1	Validated. No cal required.	Validated. No cal required.
Liquid transition	MVG	SN 32/16 WGLIQ_5G000_1	Validated. No cal required.	Validated. No cal required.
Temperature / Humidity Sensor	Testo 184 H1	44225320	06/2021	06/2024





## SAR Reference Dipole Calibration Report

Ref : ACR.307.35.21.BES.B

Cancel and replace the report ACR.307.35.21.BES.A

### **INTERTEK TESTING SERVICES HONG KONG LIMITED**

**WORKSHOP NO. 3 G/F, WORLD-WIDE INDUSTRIAL  
CENTRE, 43-47 SHAN MEI STREET,  
FO TAN, SHA TIN, N.T. HONG KONG**

**MVG COMOSAR REFERENCE DIPOLE**

**FREQUENCY: 2450 MHZ**

**SERIAL NO.: SN 22/16 DIP2G450-411**

**Calibrated at MVG**

**Z.I. de la pointe du diable**

**Technopôle Brest Iroise – 295 avenue Alexis de Rochon**

**29280 PLOUZANE - FRANCE**

**Calibration date: 11/2/2021**



Accreditations #2-6789 and #2-6814  
Scope available on [www.cofrac.fr](http://www.cofrac.fr)

**The use of the Cofrac brand and the accreditation references is prohibited from any reproduction.**

#### *Summary:*

This document presents the method and results from an accredited SAR reference dipole calibration performed in MVG using the COMOSAR test bench. All calibration results are traceable to national metrology institutions.



	<i>Name</i>	<i>Function</i>	<i>Date</i>	<i>Signature</i>
<i>Prepared by :</i>	Jérôme Le Gall	Measurement Responsible	11/3/2021	
<i>Checked by :</i>	Jérôme Luc	Technical Manager	11/3/2021	
<i>Approved by :</i>	Yann Toutain	Laboratory Director	11/10/2021	

	<i>Customer Name</i>
<i>Distribution :</i>	Intertek Testing Services Hong Kong Limited

<i>Issue</i>	<i>Name</i>	<i>Date</i>	<i>Modifications</i>
A	Jérôme Luc	11/3/2021	Initial release
B	Jérôme Luc	11/10/2021	Add EN standard



**TABLE OF CONTENTS**

1 Introduction..... 4

2 Device Under Test ..... 4

3 Product Description ..... 4

    3.1 General Information ..... 4

4 Measurement Method ..... 5

    4.1 Return Loss Requirements ..... 5

    4.2 Mechanical Requirements ..... 5

5 Measurement Uncertainty ..... 5

    5.1 Return Loss ..... 5

    5.2 Dimension Measurement ..... 5

    5.3 Validation Measurement ..... 5

6 Calibration Measurement Results ..... 6

    6.1 Return Loss and Impedance In Head Liquid ..... 6

    6.2 Return Loss and Impedance In Body Liquid ..... 6

    6.3 Mechanical Dimensions ..... 7

7 Validation measurement ..... 7

    7.1 Head Liquid Measurement ..... 8

    7.2 SAR Measurement Result With Head Liquid ..... 8

    7.3 Body Liquid Measurement ..... 11

    7.4 SAR Measurement Result With Body Liquid ..... 12

8 List of Equipment ..... 13

## 1 INTRODUCTION

This document contains a summary of the requirements set forth by the IEC/IEEE 62209-1528, EN 62209-1/2 and FCC KDB865664 D01 standards for reference dipoles used for SAR measurement system validations and the measurements that were performed to verify that the product complies with the fore mentioned standards.

## 2 DEVICE UNDER TEST

Device Under Test	
Device Type	COMOSAR 2450 MHz REFERENCE DIPOLE
Manufacturer	MVG
Model	SID2450
Serial Number	SN 22/16 DIP2G450-411
Product Condition (new / used)	Used

## 3 PRODUCT DESCRIPTION

### 3.1 GENERAL INFORMATION

MVG’s COMOSAR Validation Dipoles are built in accordance to the IEC/IEEE 62209-1528, EN 62209-1/2 and FCC KDB865664 D01 standards. The product is designed for use with the COMOSAR test bench only.



**Figure 1 – MVG COMOSAR Validation Dipole**

## 4 MEASUREMENT METHOD

The IEC/IEEE 62209-1528, EN 62209-1/2 and FCC KDB865664 D01 standards provide requirements for reference dipoles used for system validation measurements. The following measurements were performed to verify that the product complies with the fore mentioned standards.

### 4.1 RETURN LOSS REQUIREMENTS

The dipole used for SAR system validation measurements and checks must have a return loss of -20 dB or better. The return loss measurement shall be performed against a liquid filled flat phantom, with the phantom constructed as outlined in the fore mentioned standards. A direct method is used with a network analyser and its calibration kit, both with a valid ISO17025 calibration.

### 4.2 MECHANICAL REQUIREMENTS

The IEC/IEEE 62209-1528, EN 62209-1/2 and FCC KDB865664 D01 standards specify the mechanical components and dimensions of the validation dipoles, with the dimension's frequency and phantom shell thickness dependent. The COMOSAR test bench employs a 2 mm phantom shell thickness therefore the dipoles sold for use with the COMOSAR test bench comply with the requirements set forth for a 2 mm phantom shell thickness. A direct method is used with a ISO17025 calibrated caliper.

## 5 MEASUREMENT UNCERTAINTY

All uncertainties listed below represent an expanded uncertainty expressed at approximately the 95% confidence level using a coverage factor of k=2, traceable to the Internationally Accepted Guides to Measurement Uncertainty.

### 5.1 RETURN LOSS

The following uncertainties apply to the return loss measurement:

Frequency band	Expanded Uncertainty on Return Loss
400-6000MHz	0.08 LIN

### 5.2 DIMENSION MEASUREMENT

The following uncertainties apply to the dimension measurements:

Length (mm)	Expanded Uncertainty on Length
0 - 300	0.20 mm
300 - 450	0.44 mm

### 5.3 VALIDATION MEASUREMENT

The guidelines outlined in the IEC/IEEE 62209-1528, EN 62209-1/2 and FCC KDB865664 D01 standards were followed to generate the measurement uncertainty for validation measurements.

Scan Volume	Expanded Uncertainty
1 g	19 % (SAR)
10 g	19 % (SAR)

## 6 CALIBRATION MEASUREMENT RESULTS

### 6.1 RETURN LOSS AND IMPEDANCE IN HEAD LIQUID

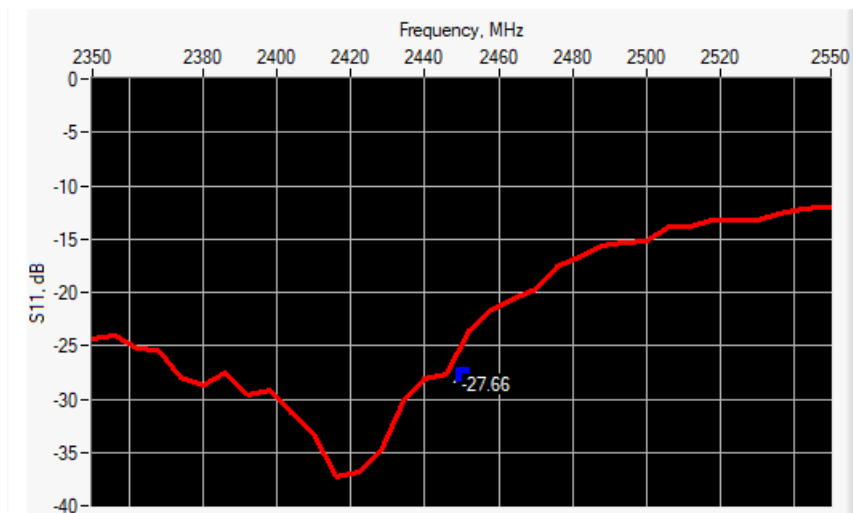

Frequency (MHz)	Return Loss (dB)	Requirement (dB)	Impedance
2450	-27.66	-20	48.4 Ω - 3.8 jΩ

### 6.2 RETURN LOSS AND IMPEDANCE IN BODY LIQUID

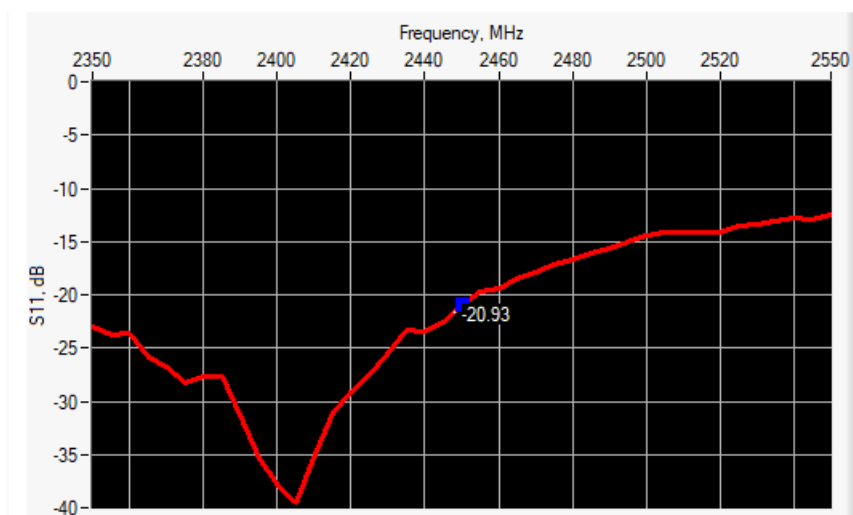

Frequency (MHz)	Return Loss (dB)	Requirement (dB)	Impedance
2450	-20.93	-20	48.4 Ω - 8.8 jΩ



6.3 MECHANICAL DIMENSIONS

Frequency MHz	L mm		h mm		d mm	
	required	measured	required	measured	required	measured
300	420.0 ±1 %.		250.0 ±1 %.		6.35 ±1 %.	
450	290.0 ±1 %.		166.7 ±1 %.		6.35 ±1 %.	
750	176.0 ±1 %.		100.0 ±1 %.		6.35 ±1 %.	
835	161.0 ±1 %.		89.8 ±1 %.		3.6 ±1 %.	
900	149.0 ±1 %.		83.3 ±1 %.		3.6 ±1 %.	
1450	89.1 ±1 %.		51.7 ±1 %.		3.6 ±1 %.	
1500	86.2 ±1 %.		50.0 ±1 %.		3.6 ±1 %.	
1640	79.0 ±1 %.		45.7 ±1 %.		3.6 ±1 %.	
1750	75.2 ±1 %.		42.9 ±1 %.		3.6 ±1 %.	
1800	72.0 ±1 %.		41.7 ±1 %.		3.6 ±1 %.	
1900	68.0 ±1 %.		39.5 ±1 %.		3.6 ±1 %.	
1950	66.3 ±1 %.		38.5 ±1 %.		3.6 ±1 %.	
2000	64.5 ±1 %.		37.5 ±1 %.		3.6 ±1 %.	
2100	61.0 ±1 %.		35.7 ±1 %.		3.6 ±1 %.	
2300	55.5 ±1 %.		32.6 ±1 %.		3.6 ±1 %.	
2450	51.5 ±1 %.	-	30.4 ±1 %.	-	3.6 ±1 %.	-
2600	48.5 ±1 %.		28.8 ±1 %.		3.6 ±1 %.	
3000	41.5 ±1 %.		25.0 ±1 %.		3.6 ±1 %.	
3300	-		-		-	
3500	37.0±1 %.		26.4 ±1 %.		3.6 ±1 %.	
3700	34.7±1 %.		26.4 ±1 %.		3.6 ±1 %.	
3900	-		-		-	
4200	-		-		-	
4600	-		-		-	
4900	-		-		-	

7 VALIDATION MEASUREMENT

The IEC/IEEE 62209-1528, EN 62209-1/2 and FCC KDB865664 D01 standards state that the system validation measurements must be performed using a reference dipole meeting the fore mentioned return loss and mechanical dimension requirements. The validation measurement must be performed against a liquid filled flat phantom, with the phantom constructed as outlined in the fore mentioned standards. Per the standards, the dipole shall be positioned below the bottom of the phantom, with the dipole length centered and parallel to the longest dimension of the flat phantom, with the top surface of the dipole at the described distance from the bottom surface of the phantom.

7.1 HEAD LIQUID MEASUREMENT

Frequency MHz	Relative permittivity ( $\epsilon_r'$ )		Conductivity ( $\sigma$ ) S/m	
	required	measured	required	measured
300	45.3 ±10 %		0.87 ±10 %	
450	43.5 ±10 %		0.87 ±10 %	
750	41.9 ±10 %		0.89 ±10 %	
835	41.5 ±10 %		0.90 ±10 %	
900	41.5 ±10 %		0.97 ±10 %	
1450	40.5 ±10 %		1.20 ±10 %	
1500	40.4 ±10 %		1.23 ±10 %	
1640	40.2 ±10 %		1.31 ±10 %	
1750	40.1 ±10 %		1.37 ±10 %	
1800	40.0 ±10 %		1.40 ±10 %	
1900	40.0 ±10 %		1.40 ±10 %	
1950	40.0 ±10 %		1.40 ±10 %	
2000	40.0 ±10 %		1.40 ±10 %	
2100	39.8 ±10 %		1.49 ±10 %	
2300	39.5 ±10 %		1.67 ±10 %	
2450	39.2 ±10 %	36.4	1.80 ±10 %	1.96
2600	39.0 ±10 %		1.96 ±10 %	
3000	38.5 ±10 %		2.40 ±10 %	
3300	38.2 ±10 %		2.71 ±10 %	
3500	37.9 ±10 %		2.91 ±10 %	
3700	37.7 ±10 %		3.12 ±10 %	
3900	37.5 ±10 %		3.32 ±10 %	
4200	37.1 ±10 %		3.63 ±10 %	
4600	36.7 ±10 %		4.04 ±10 %	
4900	36.3 ±10 %		4.35 ±10 %	

7.2 SAR MEASUREMENT RESULT WITH HEAD LIQUID

The IEC/IEEE 62209-1528, EN 62209-1/2 and FCC KDB865664 D01 standards state that the system validation measurements should produce the SAR values shown below (for phantom thickness of 2 mm), within the uncertainty for the system validation. All SAR values are normalized to 1 W forward power. In bracket, the measured SAR is given with the used input power.





Software	OPENSAR V5
Phantom	SN 13/09 SAM68
Probe	SN 41/18 EPGO333
Liquid	Head Liquid Values: eps' : 36.4 sigma : 1.96
Distance between dipole center and liquid	10.0 mm
Area scan resolution	dx=8mm/dy=8mm
Zoon Scan Resolution	dx=5mm/dy=5mm/dz=5mm
Frequency	2450 MHz
Input power	20 dBm
Liquid Temperature	20 +/- 1 °C
Lab Temperature	20 +/- 1 °C
Lab Humidity	30-70 %

Frequency MHz	1 g SAR (W/kg/W)		10 g SAR (W/kg/W)	
	required	measured	required	measured
300	2.85		1.94	
450	4.58		3.06	
750	8.49		5.55	
835	9.56		6.22	
900	10.9		6.99	
1450	29		16	
1500	30.5		16.8	
1640	34.2		18.4	
1750	36.4		19.3	
1800	38.4		20.1	
1900	39.7		20.5	
1950	40.5		20.9	
2000	41.1		21.1	
2100	43.6		21.9	
2300	48.7		23.3	
2450	52.4	55.89 (5.59)	24	24.46 (2.45)
2600	55.3		24.6	
3000	63.8		25.7	
3300	-		-	
3500	67.1		25	
3700	67.4		24.2	
3900	-		-	
4200	-		-	
4600	-		-	
4900	-		-	

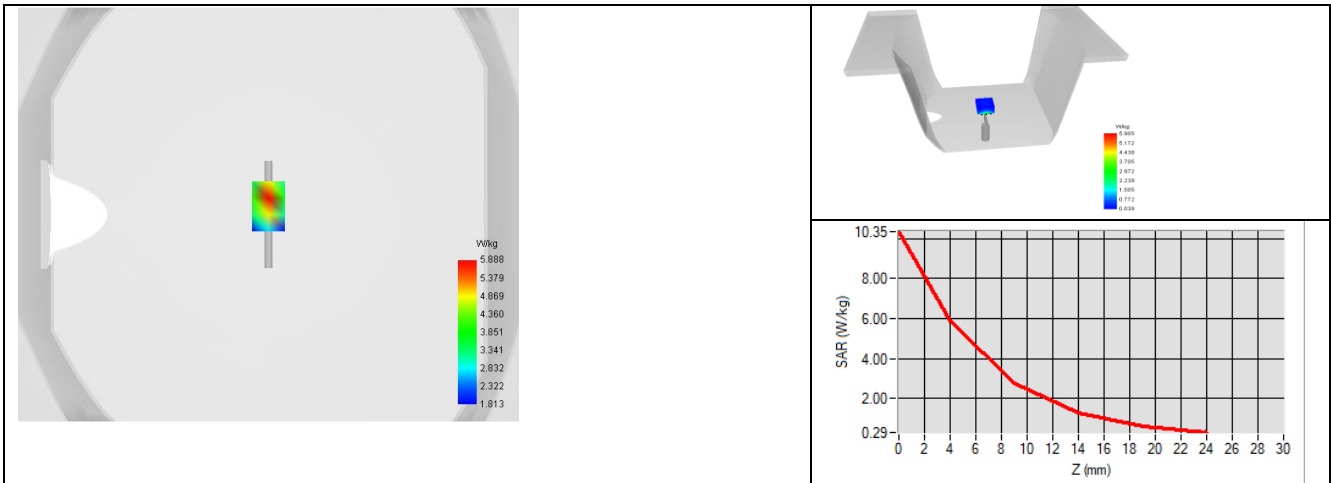

7.3 BODY LIQUID MEASUREMENT

Frequency MHz	Relative permittivity ( $\epsilon_r'$ )		Conductivity ( $\sigma$ ) S/m	
	required	measured	required	measured
150	61.9 ±10 %		0.80 ±10 %	
300	58.2 ±10 %		0.92 ±10 %	
450	56.7 ±10 %		0.94 ±10 %	
750	55.5 ±10 %		0.96 ±10 %	
835	55.2 ±10 %		0.97 ±10 %	
900	55.0 ±10 %		1.05 ±10 %	
915	55.0 ±10 %		1.06 ±10 %	
1450	54.0 ±10 %		1.30 ±10 %	
1610	53.8 ±10 %		1.40 ±10 %	
1800	53.3 ±10 %		1.52 ±10 %	
1900	53.3 ±10 %		1.52 ±10 %	
2000	53.3 ±10 %		1.52 ±10 %	
2100	53.2 ±10 %		1.62 ±10 %	
2300	52.9 ±10 %		1.81 ±10 %	
2450	52.7 ±10 %	53.4	1.95 ±10 %	2.14
2600	52.5 ±10 %		2.16 ±10 %	
3000	52.0 ±10 %		2.73 ±10 %	
3300	51.6 ±10 %		3.08 ±10 %	
3500	51.3 ±10 %		3.31 ±10 %	
3700	51.0 ±10 %		3.55 ±10 %	
3900	50.8 ±10 %		3.78 ±10 %	
4200	50.4 ±10 %		4.13 ±10 %	
4600	49.8 ±10 %		4.60 ±10 %	
4900	49.4 ±10 %		4.95 ±10 %	
5200	49.0 ±10 %		5.30 ±10 %	
5300	48.9 ±10 %		5.42 ±10 %	
5400	48.7 ±10 %		5.53 ±10 %	
5500	48.6 ±10 %		5.65 ±10 %	
5600	48.5 ±10 %		5.77 ±10 %	
5800	48.2 ±10 %		6.00 ±10 %	

7.4 SAR MEASUREMENT RESULT WITH BODY LIQUID

Software	OPENSAR V5
Phantom	SN 13/09 SAM68
Probe	SN 41/18 EPGO333
Liquid	Body Liquid Values: eps' : 53.4 sigma : 2.14
Distance between dipole center and liquid	10.0 mm
Area scan resolution	dx=8mm/dy=8mm
Zoon Scan Resolution	dx=5mm/dy=5mm/dz=5mm
Frequency	2450 MHz
Input power	20 dBm
Liquid Temperature	20 +/- 1 °C
Lab Temperature	20 +/- 1 °C
Lab Humidity	30-70 %

Frequency MHz	1 g SAR (W/kg/W)	10 g SAR (W/kg/W)
	measured	measured
2450	54.20 (5.42)	23.89 (2.39)

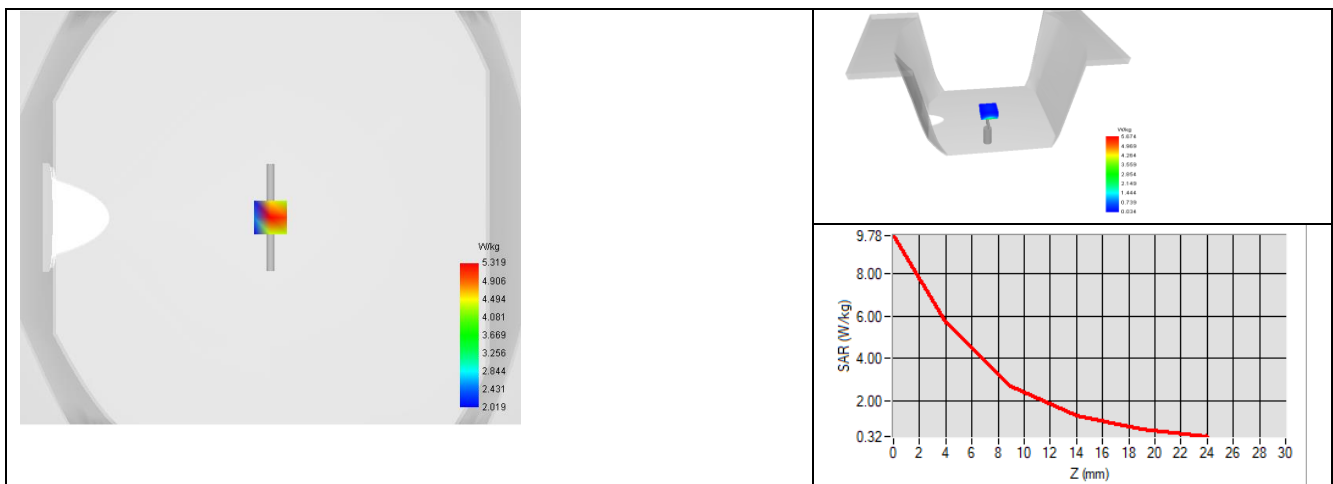



**8 LIST OF EQUIPMENT**

Equipment Summary Sheet				
Equipment Description	Manufacturer / Model	Identification No.	Current Calibration Date	Next Calibration Date
SAM Phantom	MVG	SN 13/09 SAM68	Validated. No cal required.	Validated. No cal required.
COMOSAR Test Bench	Version 3	NA	Validated. No cal required.	Validated. No cal required.
Network Analyzer	Rohde & Schwarz ZVM	100203	08/2021	08/2024
Network Analyzer	Agilent 8753ES	MY40003210	10/2019	10/2022
Network Analyzer – Calibration kit	Rohde & Schwarz ZV-Z235	101223	05/2019	05/2022
Network Analyzer – Calibration kit	HP 85033D	3423A08186	06/2021	06/2027
Calipers	Mitutoyo	SN 0009732	10/2019	10/2022
Reference Probe	MVG	SN 41/18 EPGO333	10/2021	10/2022
Multimeter	Keithley 2000	1160271	02/2020	02/2023
Signal Generator	Rohde & Schwarz SMB	106589	04/2019	04/2022
Amplifier	MVG	MODU-023-C-0002	Characterized prior to test. No cal required.	Characterized prior to test. No cal required.
Power Meter	NI-USB 5680	170100013	06/2021	06/2024
Power Meter	Rohde & Schwarz NRVD	832839-056	11/2019	11/2022
Directional Coupler	Krytar 158020	131467	Characterized prior to test. No cal required.	Characterized prior to test. No cal required.
Temperature / Humidity Sensor	Testo 184 H1	44225320	06/2021	06/2024



## Dielectric Probe Calibration Report

Ref : ACR.307.37.21.BES.B

Cancel and replace the report ACR.307.37.21.BES.A

### **INTERTEK TESTING SERVICES HONG KONG LIMITED**

**WORKSHOP NO. 3 G/F, WORLD-WIDE INDUSTRIAL  
CENTRE, 43-47 SHAN MEI STREET,  
FO TAN, SHA TIN, N.T. HONG KONG  
MVG LIMESAR DIELECTRIC PROBE**

**FREQUENCY: 0.4-6 GHZ**

**SERIAL NO.: SN 24/16 OCPG76**

**Calibrated at MVG**

**Z.I. de la pointe du diable**

**Technopôle Brest Iroise – 295 avenue Alexis de Rochon**

**29280 PLOUZANE - FRANCE**

**Calibration date: 11/2/2021**



Accreditations #2-6789  
Scope available on [www.cofrac.fr](http://www.cofrac.fr)

**The use of the Cofrac brand and the accreditation references is prohibited from any reproduction.**

#### *Summary:*

This document presents the method and results from an accredited Dielectric Probe calibration performed at MVG, using the LIMESAR test bench. The test results covered by accreditation are traceable to the International System of Units (SI).



	<i>Name</i>	<i>Function</i>	<i>Date</i>	<i>Signature</i>
<i>Prepared by :</i>	Jérôme Le Gall	Measurement Responsible	11/3/2021	
<i>Checked by :</i>	Jérôme Luc	Technical Manager	11/3/2021	
<i>Approved by :</i>	Yann Toutain	Laboratory Director	11/10/2021	

	<i>Customer Name</i>
<i>Distribution :</i>	Intertek Testing Services Hong Kong Limited

<i>Issue</i>	<i>Name</i>	<i>Date</i>	<i>Modifications</i>
A	Jérôme Luc	11/3/2021	Initial release
B	Jérôme Luc	11/10/2021	Add EN standard



**TABLE OF CONTENTS**

1 Introduction..... 4

2 Device Under Test ..... 4

3 Product Description ..... 4

    3.1 General Information ..... 4

4 Measurement Method ..... 5

    4.1 Liquid Permittivity Measurements ..... 5

5 Measurement Uncertainty ..... 5

    5.1 Dielectric Permittivity Measurement ..... 5

6 Calibration Measurement Results ..... 5

    6.1 Liquid Permittivity Measurement ..... 6

7 List of Equipment ..... 7



## 1 INTRODUCTION

This document contains a summary of the suggested methods and requirements set forth by the IEC/IEEE 62209-1528, EN 62209-1/2 and FCC KDB865664 D01 standards for liquid permittivity measurements and the measurements that were performed to verify that the product complies with the fore mentioned standards.

## 2 DEVICE UNDER TEST

Device Under Test	
Device Type	LIMESAR DIELECTRIC PROBE
Manufacturer	MVG
Model	SCLMP
Serial Number	SN 24/16 OCPG76
Product Condition (new / used)	Used

## 3 PRODUCT DESCRIPTION

### 3.1 GENERAL INFORMATION

MVG’s Dielectric Probes are built in accordance to the IEC/IEEE 62209-1528, EN 62209-1/2 and FCC KDB865664 D01 standards. The product is designed for use with the LIMESAR test bench only.



**Figure 1 – MVG LIMESAR Dielectric Probe**



## 4 MEASUREMENT METHOD

The IEC/IEEE 62209-1528, EN 62209-1/2 and FCC KDB865664 D01 standards outline techniques for dielectric property measurements. The LIMESAR test bench employs one of the methods outlined in the standards, using a contact probe or open-ended coaxial transmission-line probe and vector network analyzer. The standards recommend the measurement of two reference materials that have well established and stable dielectric properties to validate the system, one for the calibration and one for checking the calibration. The LIMESAR test bench uses De-ionized water as the reference for the calibration and either DMS or Methanol as the reference for checking the calibration. The following measurements were performed to verify that the product complies with the fore mentioned standards.

### 4.1 LIQUID PERMITTIVITY MEASUREMENTS

The permittivity of a liquid with well established dielectric properties was measured and the measurement results compared to the values provided in the fore mentioned standards.

## 5 MEASUREMENT UNCERTAINTY

All uncertainties listed below represent an expanded uncertainty expressed at approximately the 95% confidence level using a coverage factor of  $k=2$ , traceable to the Internationally Accepted Guides to Measurement Uncertainty.

### 5.1 DIELECTRIC PERMITTIVITY MEASUREMENT

The following uncertainties apply to the Dielectric Permittivity measurement:

Uncertainty analysis of Permittivity Measurement					
ERROR SOURCES	Uncertainty value (+/-%)	Probability Distribution	Divisor	ci	Standard Uncertainty (+/-%)
Expanded uncertainty (confidence level of 95%, $k = 2$ )					10 %

Uncertainty analysis of Conductivity Measurement					
ERROR SOURCES	Uncertainty value (+/-%)	Probability Distribution	Divisor	ci	Standard Uncertainty (+/-%)
Expanded uncertainty (confidence level of 95%, $k = 2$ )					8.2%

## 6 CALIBRATION MEASUREMENT RESULTS

### Measurement Condition

Software	LIMESAR
Liquid Temperature	20 +/- 1 °C
Lab Temperature	20 +/- 1 °C
Lab Humidity	30-70 %

### 6.1 LIQUID PERMITTIVITY MEASUREMENT

A liquid of known characteristics (methanol or ethanediol) is measured with the probe and the results (complex permittivity  $\epsilon' + j\epsilon''$ ) are compared with the reference values for this liquid.

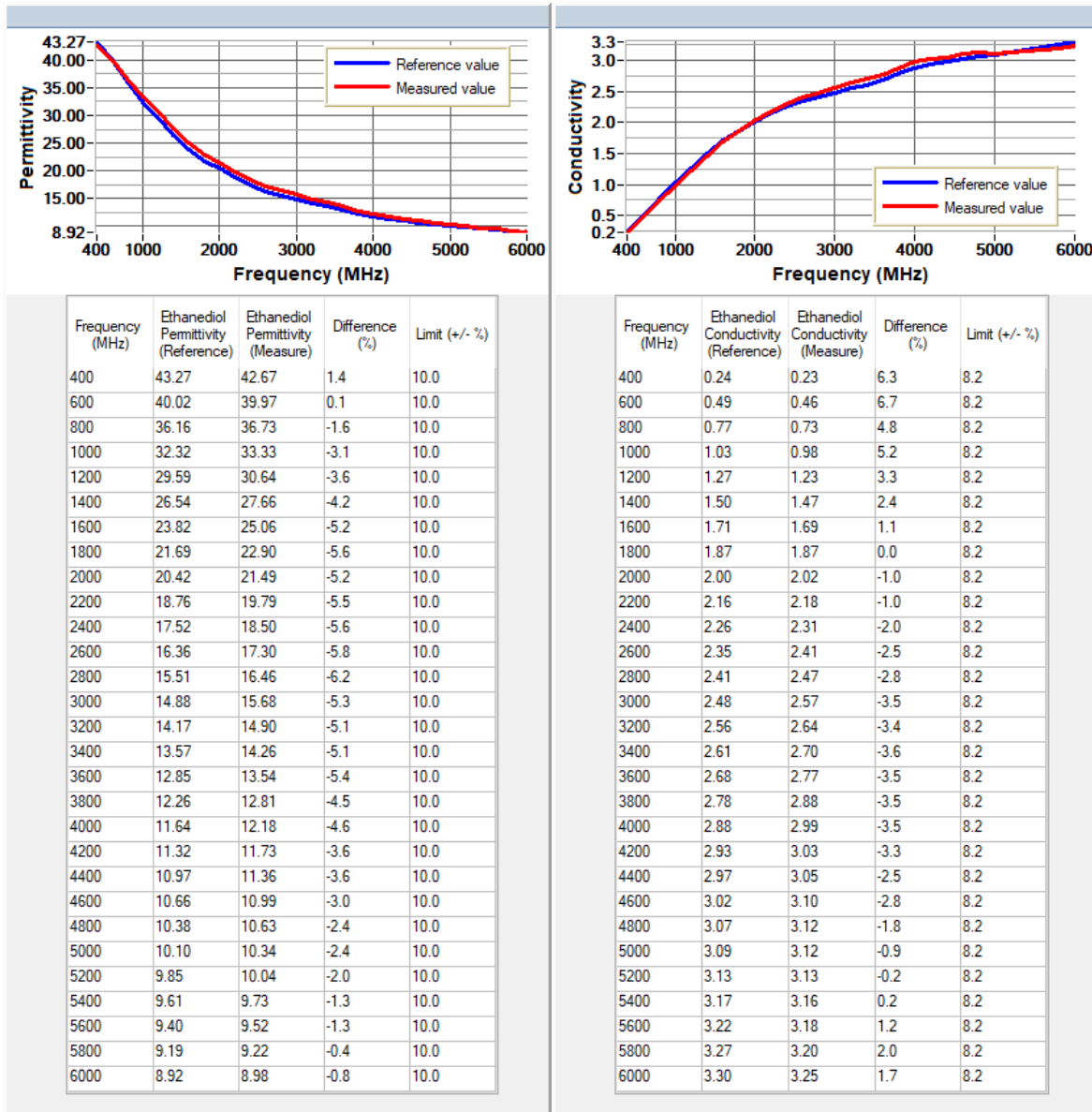



7 LIST OF EQUIPMENT

Equipment Summary Sheet				
Equipment Description	Manufacturer / Model	Identification No.	Current Calibration Date	Next Calibration Date
LIMESAR Test Bench	Version 3	NA	Validated. No cal required.	Validated. No cal required.
Liquid measurement probe	MVG	SN 35/10 OCPG37	11/2021	11/2022
Network Analyzer	Rohde & Schwarz ZVM	100203	08/2021	08/2024
Network Analyzer	Agilent 8753ES	MY40003210	10/2019	10/2022
Network Analyzer – Calibration kit	Rohde & Schwarz ZV-Z235	101223	05/2019	05/2022
Network Analyzer – Calibration kit	HP 85033D	3423A08186	06/2021	06/2027
Temperature / Humidity Sensor	Testo 184 H1	44225320	06/2021	06/2024

**TEST REPORT**

**APPENDIX D – SAR SYSTEM VALIDATION**

Per KDB 865664, SAR system validation status should be documented to confirm measurement accuracy. SAR measurement systems are validated according to procedures in KDB 865664. The validation status is documented according to the validation date(s), measurement frequencies, SAR probe and tissue dielectric parameters. When multiple SAR system is used, the validation status of each SAR system is needed to be documented separately according to the associated system components.

A tabulated summary of the system validation status including the validation date(s), measurement frequencies, SAR probe and tissue dielectric parameters are shown as below.

Date	Probe S/N	Tested Freq. (MHz)	Tissue Type	Perm	Cond	CW Validation			Mod. Validation		
						Sensitivity	Probe Linearity	Probe Isotropy	Mod. Type	Duty Factor	Peak to average power ratio
20/11/2021	EPGO 347	2450	Head	38.92	1.86	PASS	PASS	PASS	FHSS	PASS	PASS
20/11/2021	EPGO 347	2450	Body	51.64	1.99	PASS	PASS	PASS	FHSS	PASS	PASS
20/11/2021	EPGO 347	2450	Head	38.92	1.86	PASS	PASS	PASS	OFDM	N/A	PASS
20/11/2021	EPGO 347	2450	Body	51.64	1.99	PASS	PASS	PASS	OFDM	N/A	PASS
20/11/2021	EPGO 347	2450	Head	38.92	1.86	PASS	PASS	PASS	DSSS	PASS	N/A
20/11/2021	EPGO 347	2450	Body	51.64	1.99	PASS	PASS	PASS	DSSS	PASS	N/A