

TEST REPORT

SPECIFIC ABSORPTION RATE (SAR) EVALUATION REPORT

Report No.: 23120043HKG-001

For Video Monitor - Parent Unit
Model: VM3254 PU, VM3254-2 PU
Brand Name: vtech
FCC ID: EW780-1960-01D
Prepared for
VTech Telecommunications Ltd.
23/F., Tai Ping Industrial Centre, Block 1,
57 Ting Kok Road, Tai Po,
Hong Kong.

PREPARED AND CHECKED BY:

APPROVED BY:

Signed On File
Ma King Hang
Assistant Engineer
Date: January 09, 2024

Tang Kwan Mo, Jess
Lead Engineer
Date: January 09, 2024

TEST REPORT

TABLE OF CONTENTS

1 Test Result Summary 3

2 General Information 4

3 SAR Measurement System Description 7

4 Tissue Verificaiton..... 15

5 SAR Measurement System Verification 18

6 SAR Evaluation..... 20

7 Test Equipment List..... 33

8 Measurement Uncertainty 34

9 E-Field Probe and Dipole Antenna Calibration..... 35

APPENDIX A – System Check Data 36

APPENDIX B – SAR Evaluation Data..... 37

APPENDIX C – E-Field Probe and Dipole Antenna Calibration 38

APPENDIX D – SAR SYSTEM VALIDATION 39

TEST REPORT

1. TEST RESULT SUMMARY

Applicant:	VTech Telecommunications Ltd.
Applicant Address:	23/F., Tai Ping Industrial Centre, Block 1, 57 Ting Kok Road, Tai Po, Hong Kong.
Brand Name:	vtech
Description of EUT:	Video Monitor - Parent Unit
Model:	VM3254 PU, VM3254-2 PU, VM819 PU, VM819-2 PU
FCC ID:	EW780-1960-01D
Serial Number:	N/A
Test Device:	Production Unit
EUT Exercising Software:	ComTestSerial Version 3.0.0.108
Exposure Category:	General Population/Uncontrolled Exposure
Sample Receive Date:	December 07, 2023
Date of Test:	December 08, 2023 to December 12, 2023
Test Location:	Workshop No. 3, G/F., World-Wide Industrial Centre, 43-47 Shan Mei Street, Fo Tan, Sha Tin, N.T., Hong Kong SAR, China.
Environmental Conditions:	Temperature: +18 to 25°C Humidity 25 to 75%
Test Specification:	ANSI/IEEE C95.1 IEEE Std 1528: 2013 FCC KDB Publication 447498 D01 v06 FCC KDB Publication 865664 D01 v01r04 FCC KDB Publication 865664 D02 v01r02

The maximum spatial peak SAR value for the sample device averaged over 1g was found to be:

Band	Operating Mode	TX Frequency (MHz)	Highest Reported SAR
			In-front-of mouth
2.4GHz FHSS	Data	2405 – 2475	0.583 W/kg

This wireless portable device has been shown to be capable of compliance for localized specific absorption rate (SAR) for uncontrolled environment / general population exposure limits specified in ANSI/IEEE C95.1.

TEST REPORT

2. GENERAL INFORMATION

2.1. Description of Equipment Under Test (EUT)

Manufacturer:	VTech (Dongguan) Telecommunications Limited
Manufacturer Address:	VTech Science Park, Xia Ling Bei Management Zone, Liaobu, Dongguan, Guangdong, China.
Device Dimension (L x W):	120(mm) x 61(mm)
Device Thickness:	33(mm)
Antenna Gain:	0dBi
Operating Configuration(s) / Mode:	In-front-of mouth (Data) Body (Data)
TX Frequency (MHz):	2405 - 2475MHz
Duty Cycle*:	9.7%
H/W Version:	N/A
S/W Version:	N/A
Battery Type:	3.6VDC 2600mAh Li-ion rechargeable Battery
Body-worn Accessories:	N/A
Remark:	The models VM3254-2 PU, VM819 PU, VM819-2 PU are the same as the model VM3254 PU in hardware aspect. The difference in model number serves as marketing strategy as declared by client. The difference in model number represents different color as declared by client.

Model Number	Remarks
VM3254 PU, VM3254-2 PU	1 Parent Unit
VM819 PU, VM819-2 PU	1 Parent Unit

The production units are required to conform to the initial sample as received when the units are placed on the market.

***Note:**

1. Worst case was selected to present by client request. SAR test was tested and present in test mode with 100% to represent the worst case.

TEST REPORT

2.2. EUT Antenna Locations

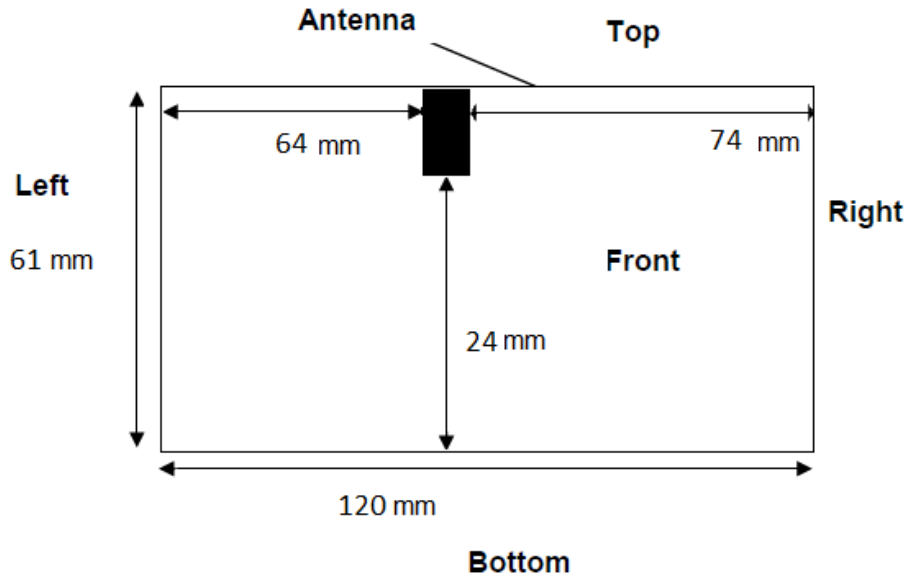

Exposure Position	Separation Distance from the Antenna to the Outer Surface
Front	5
Top	5
Left	64
Right	74
Back	4
Bottom	24

Details of antenna specification are shown in separate antenna dimension document.

TEST REPORT

2.3 Nominal and Maximum Output Power Specifications

The EUT operates using the following maximum and nominal output power specifications. SAR values were scaled to the maximum allowed power to determine compliance per KDB Publication 447498.

Band	Operating Mode	TX Frequency (MHz)	Output Power	
			Nominal (dBm)	Maximum (dBm)
2.4GHz FHSS	Data	2405 – 2475	15.6	17

TEST REPORT

3. SAR MEASUREMENT SYSTEM DESCRIPTION

SAR is related to the rate at which energy is absorbed per unit mass in object exposed to a radio field. The SAR distribution in a biological body is complicated and is usually carried out by experimental techniques or numerical modeling. The standard recommends limits for two tiers of groups, occupational/controlled and occupational/uncontrolled, based on a person's awareness and ability to exercise control over his or her exposure. In general, occupational/controlled exposure limits are higher than the limits for general population/uncontrolled.

The SAR definition is the time derivative (rate) of the incremental energy (dW) absorbed by (dissipated in) an incremental mass (dm) contained in a volume element (dv) of given mass density (ρ). The equation description is as below:

$$SAR = \frac{d}{dt} \left(\frac{dW}{dm} \right) = \frac{d}{dt} \left(\frac{dW}{\rho dV} \right)$$

SAR is expressed in units of Watts per kilogram (W/Kg)

SAR can be obtained using either of the following equations:

$$SAR = \frac{\sigma E^2}{\rho}$$

$$SAR = c_h \left. \frac{dT}{dt} \right|_{t=0}$$

Where

- SAR is the specific absorption rate in watts per kilogram;
- E is the r.m.s. value of the electric field strength in the tissue in volts per meter;
- σ is the conductivity of the tissue in siemens per metre;
- ρ is the density of the tissue in kilograms per cubic metre;
- c_h is the heat capacity of the tissue in joules per kilogram and Kelvin;
- $\left. \frac{dT}{dt} \right|_{t=0}$ is the initial time derivative of temperature in the tissue in kelvins per second.

TEST REPORT

An SAR measurement system usually consists of a small diameter isotropic electric field probe, a multiple axis probe positioning system, a test device holder, one or more phantom models, the field probe instrumentation, a computer and other electronic equipment for controlling the probe and making the measurements. Other supporting equipment, such as a network analyzer, power meters and RF signal generators, are also required to measure the dielectric parameters of the simulated tissue media and to verify the measurement accuracy of the SAR system.

The SAR measurement system being used is COMOSAR system, which consists following items for performing compliance tests.

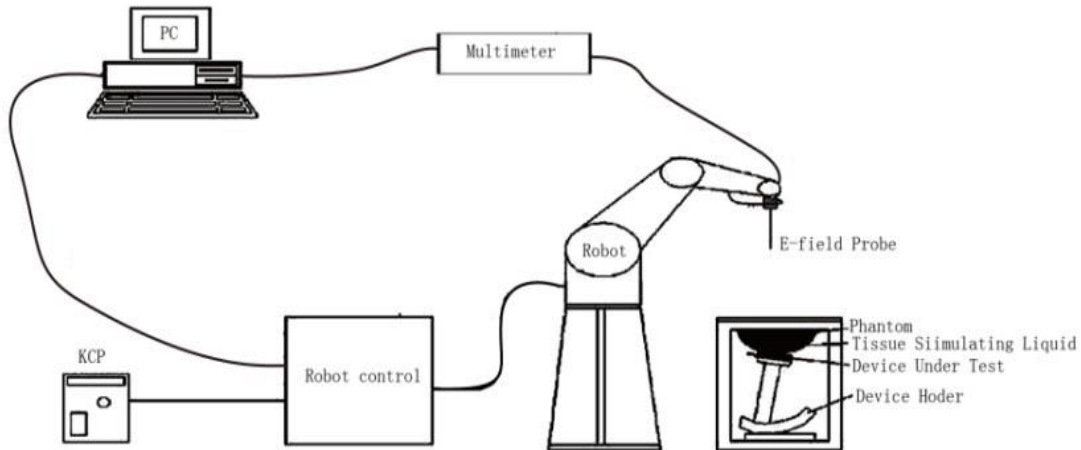

Figure 1: Schematic diagram of the SAR measurement system

- The PC. It controls most of the bench devices and stores measurement data. A computer running WinXP and the Opensar software.
- The E-Field probe. The probe is a 3-axis system made of 3 distinct dipoles. Each dipole returns a voltage in function of the ambient electric field.
- The Keithley multimeter measures each probe dipole voltages.
- The SAM phantom simulates a human head. The measurement of the electric field is made inside the phantom.
- The liquids simulate the dielectric properties of the human head tissues.
- The network emulator controls the mobile phone under test.
- The validation dipoles are used to measure a reference SAR. They are used to periodically check the bench to make sure that there is no drift of the system characteristics over time.
- The phantom, the device holder and other accessories according to the targeted measurement.

TEST REPORT

ROBOT

The COMOSAR system uses the KUKA robot from SATIMO SA (France). For the 6-axis controller COMOSAR system, the KUKA robot controller version from SATIMO is used.

The XL robot series have many features that are important for our application:

- High precision (repeatability 0.02 mm)
- High reliability (industrial design)
- Jerk-free straight movements
- Low ELF interference (the closed metallic construction shields against motor control fields)
- 6-axis controller



TEST REPORT

COMOSAR E-FIELD PROBE

The SAR measurement is conducted with the dissymmetric probe manufactured by SATIMO. The probe is specially designed and calibrated for use in liquid with high permittivity. The dissymmetric probe has special calibration in liquid at different frequency. SATIMO conducts the probe calibration in compliance with international and national standards (e.g. IEC/IEEE 62209-1528:2020 and relevant KDB files). The calibration data are in Appendix C.

Model	SSE2
Manufacturer	MVG
Frequency	0.45GHz-6GHz Linearity: $\pm 0.09\text{dB}$
Dynamic Range	0.01W/Kg-100W/Kg Linearity: $\pm 0.09\text{dB}$
Dimensions	Overall length:330mm Length of individual dipoles:2mm Maximum external diameter:8mm Probe Tip external diameter:2.5mm Distance between dipoles/ probe extremity:1mm



TEST REPORT

VIDEO POSITIONING SYSTEM

The video positioning system is used in OpenSAR to check the probe. Which is composed of a camera, LED, mirror and mechanical parts. The camera is piloted by the main computer with firewire link.

During the process, the actual position of the probe tip with respect to the robot arm is measured, as well as the probe length and the horizontal probe offset. The software then corrects all movements, such that the robot coordinates are valid for the probe tip.

The repeatability of this process is better than 0.1 mm. If a position has been taught with an aligned probe, the same position will be reached with another aligned probe within 0.1 mm, even if the other probe has different dimensions. During probe rotations, the probe tip will keep its actual position.

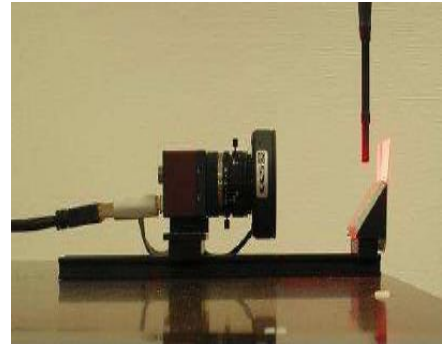

TEST REPORT

SAM TWIN PHANTOM

The SAM twin phantom is a fiberglass shell phantom with $2\text{mm} \pm 0.2\text{ mm}$ shell thickness (except the ear region where shell thickness increases to $6\text{mm} \pm 0.2\text{ mm}$), relative permittivity $\epsilon_r = 3.4$ and loss tangent $\delta = 0.02$. It has three measurement areas:

- Left head
- Right head
- Flat phantom



The bottom plate contains three pair of bolts for locking the device holder. The device holder positions are adjusted to the standard measurement positions in the three sections. A white cover is provided to tap the phantom during off-periods to prevent water evaporation and changes in the liquid parameters. On the phantom top, three reference markers are provided to identify the phantom position with respect to the robot.

TEST REPORT

ELLIPTICAL PHANTOM

The elliptical phantom is a fiberglass shell phantom with

- $2\text{mm} \pm 0.2\text{ mm}$ shell thickness
- relative permittivity $\epsilon_r = 3.4$
- loss tangent $\delta = 0.02$



DEVICE HOLDER

The COMOSAR device holder is designed to cope with different positions given in the standard. It has two scales for the device rotation (with respect to the body axis) and the device inclination (with respect to the line between the ear reference points). The rotation center for both scales is the ear reference point (EPR).

Thus the device needs no repositioning when changing the angles.

The COMOSAR device holder has been made out of low-loss POM material having the following dielectric parameters: relative permittivity $\epsilon_r = 3.7$ and loss tangent $\delta = 0.005$. The amount of dielectric material has been reduced in the closest vicinity of the device, since measurements have suggested that the influence of the clamp on the test results could thus be lowered.

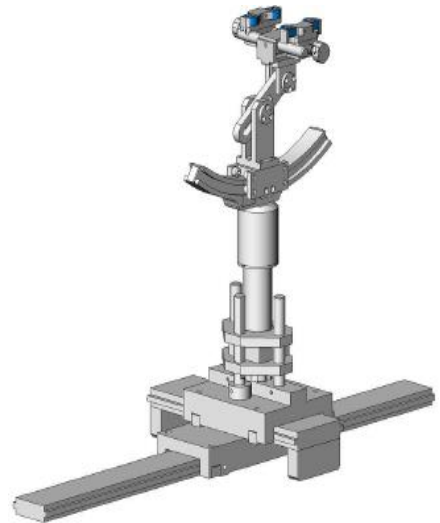

TEST REPORT

During measurement, the system first does an area (2D) scan at a fixed depth within the liquid from the inside wall of the phantom scanning area is greater than the projection of EUT and antenna.

Area Scan Parameters extracted from KDB 865664

	≤ 3 GHz	> 3 GHz
Maximum distance from closest measurement point (geometric center of probe sensors) to phantom surface	5 mm \pm 1 mm	$\frac{1}{2} \cdot \delta \cdot \ln(2)$ mm \pm 0.5 mm
Maximum probe angle from probe axis to phantom surface normal at the measurement location	30° \pm 1°	20° \pm 1°
Maximum area scan spatial resolution: Δx_{Area} , Δy_{Area}	≤ 2 GHz: ≤ 15 mm 2 – 3 GHz: ≤ 12 mm	3 – 4 GHz: ≤ 12 mm 4 – 6 GHz: ≤ 10 mm
	When the x or y dimension of the test device, in the measurement plane orientation, is smaller than the above, the measurement resolution must be \leq the corresponding x or y dimension of the test device with at least one measurement point on the test device.	

When the maximum SAR point has been found, the system will then carry out a zoom (3D) scan centered at that point to determine volume averaged SAR level.

Zoom Scan Parameters extracted from KDB 865664

Maximum zoom scan spatial resolution: Δx_{Zoom} , Δy_{Zoom}		≤ 2 GHz: ≤ 8 mm 2 – 3 GHz: ≤ 5 mm*	3 – 4 GHz: ≤ 5 mm* 4 – 6 GHz: ≤ 4 mm*
Maximum zoom scan spatial resolution, normal to phantom surface	uniform grid: $\Delta z_{Zoom}(n)$	≤ 5 mm	3 – 4 GHz: ≤ 4 mm 4 – 5 GHz: ≤ 3 mm 5 – 6 GHz: ≤ 2 mm
	graded grid	$\Delta z_{Zoom}(1)$: between 1 st two points closest to phantom surface	≤ 4 mm
		$\Delta z_{Zoom}(n>1)$: between subsequent points	$\leq 1.5 \cdot \Delta z_{Zoom}(n-1)$ mm
Minimum zoom scan volume	x, y, z	≥ 30 mm	3 – 4 GHz: ≥ 28 mm 4 – 5 GHz: ≥ 25 mm 5 – 6 GHz: ≥ 22 mm
<p>Note: δ is the penetration depth of a plane-wave at normal incidence to the tissue medium; see IEEE Std 1528-2013 for details.</p> <p>* When zoom scan is required and the <i>reported</i> SAR from the <i>area scan based 1-g SAR estimation</i> procedures of KDB Publication 447498 is ≤ 1.4 W/kg, ≤ 8 mm, ≤ 7 mm and ≤ 5 mm zoom scan resolution may be applied, respectively, for 2 GHz to 3 GHz, 3 GHz to 4 GHz and 4 GHz to 6 GHz.</p>			

TEST REPORT

4. TISSUE VERIFICATION

For SAR measurement of field distribution inside phantom, homogeneous tissue simulating liquid as below liquid recipes were filled to a depth of 15cm ± 0.5cm for below 3GHz measurement and of 10cm ± 0.5cm for above 3GHz.

HEAD TISSUE RECIPES

Frequency	De-ionized Water	Ingredients				
		Salt	1,2 propanediol	DGBE	DGMH	Triton X100
450 MHz	33.5%	3.4%	63.1%			
750 MHz	34.2%	1.4%	64.4%			
900 MHz	35.3%	1.0%	63.7%			
1800 MHz	55.2%	0.6%		13.8%		30.4%
1900 MHz	55.3%	0.5%		13.8%		30.4%
2000 MHz	55.3%	0.4%		13.8%		30.5%
2450 MHz	55.7%	0.3%		18.7%		25.3%
5000 MHz	65.3%				17.2%	17.5%

BODY TISSUE RECIPES

Frequency	De-ionized Water	Ingredients				
		Salt	1,2 propanediol	DGBE	DGMH	Triton X100
450 MHz	52.4%	1.9%	45.7%			
750 MHz	55.4%	1.3%	43.3%			
900 MHz	52.9%	1.0%	46.1%			
1800 MHz	70.8%	0.5%		8.7%		20.0%
1900 MHz	70.1%	0.4%		8.9%		20.6%
2000 MHz	70.2%	0.3%		8.6%		20.9%
2450 MHz	70.8%	0.3%		8.7%		20.2%
5000 MHz	77.8%				11.7%	11.5%

TEST REPORT

The head tissue dielectric parameters recommended by the IEC/IEEE 62209-1528:2020 have been incorporated in the following table. These head parameters are derived from planar layer models simulating the highest expected SAR for the dielectric properties and tissue thickness variations in a human head. For other head and body tissue parameters, they are recommended by KDB 865664.

Target Frequency (MHz)	Head		Body	
	ϵ_r	σ (S/m)	ϵ_r	σ (S/m)
300	45.3	0.87	58.2	0.92
450	43.5	0.87	56.7	0.94
835	41.5	0.90	55.2	0.97
900	41.5	0.97	55.0	1.05
915	41.5	1.01	55.0	1.06
1450	40.5	1.20	54.0	1.30
1610	40.3	1.29	53.8	1.40
1800 – 2000	40.0	1.40	53.3	1.52
2450	39.2	1.80	52.7	1.95
3000	38.5	2.40	52.0	2.73
5800	35.3	5.27	48.2	6.00

(ϵ_r = relative permittivity, σ = conductivity and $\rho = 1000$ kg/m³)

When a transmission band overlaps with one of the target frequencies, the tissue dielectric parameters of the tissue medium at the middle of a device transmission band should be within $\pm 5\%$ of the parameters specified at that target frequency.

TEST REPORT

The dielectric parameters of the liquids were verified prior to the SAR evaluation using SATIMO Dielectric Probe Kit and R&S Network Analyzer ZVL6.

The dielectric parameters were:

Head Liquid

Freq. (MHz)	Temp. (°C)	ϵ_r / Relative Permittivity			σ / Conductivity			ρ ** (kg/m ³)
		Measured	Target*	Δ ($\pm 5\%$)	Measured	Target*	Δ ($\pm 5\%$)	
2450	22.6	40.4	39.2	3.06	1.87	1.8	3.89	1000

* Target values refer to KDB 865664

** Worst-case assumption

Note:

1. Date of tissue verification measurement: 8 December, 2023.
2. Ambient temperature: 22.6 deg C.
3. The temperature condition is within +/- 2 deg. C during the SAR measurements.

TEST REPORT

5. SAR MEASUREMENT SYSTEM VERIFICATION

Each SATIMO system is equipped with one or more system check kits. These units, together with the predefined measurement procedures within the SATIMO software, enable user to conduct the system check. System kit includes a dipole, and dipole device holder.

The system check verifies that the system operates within its specifications. It's performed daily or before every SAR measurement. The system check uses normal SAR measurement in the flat section of the phantom with a matched dipole at a specified distance. The system check setup is shown as below.

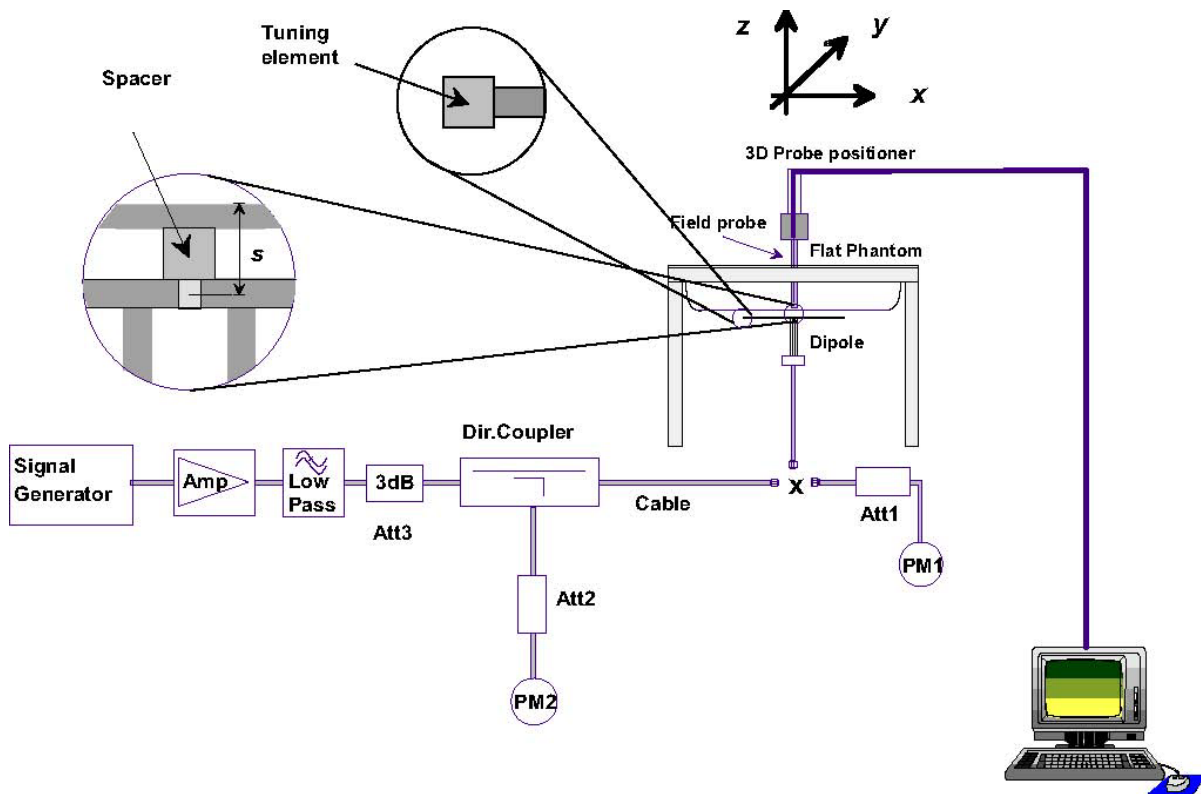

TEST REPORT

VALIDATION DIPOLE



The dipoles used is based on the IEC/IEEE 62209-1528:2020, and is complied with mechanical and electrical specifications in line with the requirements of both FCC and KDB requirement.

SYSTEM CHECK RESULTS

Date	Freq. (MHz)	Liquid Type	System Dipole	System Verification				
				Serial No.	Target SAR _{1g} (W/kg)	Measured SAR _{1g} (W/kg)	Normalized SAR _{1g} (W/kg)	Deviation (±10%)
8 December, 2023	2450	Head	2450MHz	SN 22/16 DIP 2G450-411	53.37	5.54	55.39	3.78

- * The target was quoted from dipole calibration report
- * Input power level = 20dBm (0.1W)

SAR_{1g} ambient measured value < 12 mW/kg

Details of System Verification plot is shown in the Appendix A - plot 1.

TEST REPORT

6. SAR EVALUATION

6.1. Device Test Positions Relative to the Head

This practice specifies two handset test positions against the head phantom—the “cheek” position and the “tilt” position. These two test positions are defined in the following subclauses. The handset should be tested in both positions on left and right sides of the SAM phantom. If handset construction is such that the handset positioning procedures described below to represent normal use conditions cannot be used, e.g., some asymmetric handsets, alternative alignment procedures should be adapted with all details provided in the test report. These alternative procedures should replicate intended use conditions as closely as possible according to the intent of the procedures described in this subclause.

TEST REPORT

DEFINITION OF THE CHEEK POSITION

The cheek position is established as follows:

1. Ready the handset for talk operation, if necessary. For example, for handsets with a cover piece (flip cover), open the cover. If the handset can transmit with the cover closed, both configurations must be tested.
2. Define two imaginary lines on the handset—the vertical centerline and the horizontal line. The vertical centerline passes through two points on the front side of the handset—the midpoint of the width w_t of the handset at the level of the acoustic output (point A in below figure), and the midpoint of the width w_b of the bottom of the handset (point B). The horizontal line is perpendicular to the vertical centerline and passes through the center of the acoustic output (see below left figure). The two lines intersect at point A. Note that for many handsets, point A coincides with the center of the acoustic output; however, the acoustic output may be located elsewhere on the horizontal line. Also note that the vertical centerline is not necessarily parallel to the front face of the handset (see right figure), especially for clamshell handsets, handsets with flip covers, and other irregularly-shaped handsets.
3. Position the handset close to the surface of the phantom such that point A is on the (virtual) extension of the line passing through points RE and LE on the phantom (see the figure as next page), such that the plane defined by the vertical centerline and the horizontal line of the handset is approximately parallel to the sagittal plane of the phantom.
4. Translate the handset towards the phantom along the line passing through RE and LE until handset point A touches the pinna at the ERP.

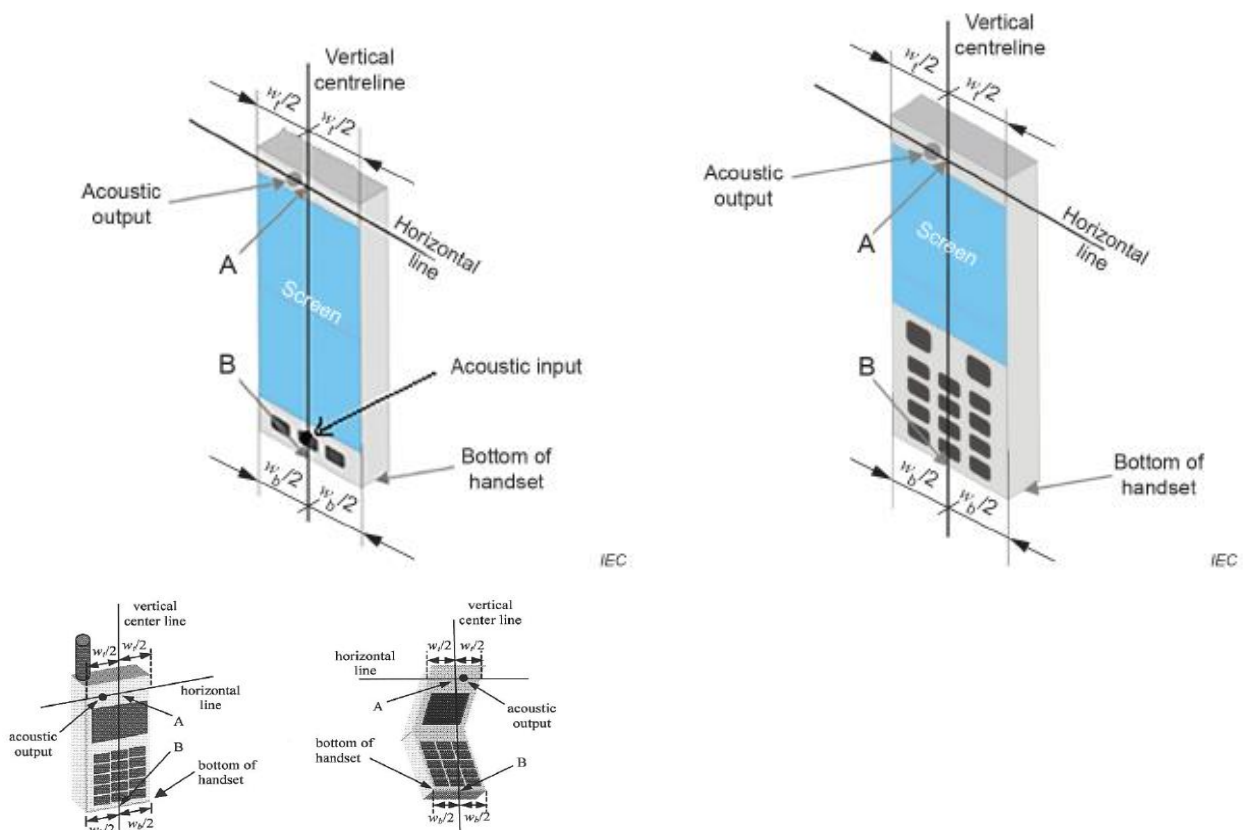

TEST REPORT

5. While maintaining the handset in this plane, rotate it around the LE-RE line until the vertical centerline is in the plane normal to the plane containing B-M and N-F lines, i.e., the Reference Plane.
6. Rotate the handset around the vertical centerline until the handset (horizontal line) is parallel to the N-F line.
7. While maintaining the vertical centerline in the Reference Plane, keeping point A on the line passing through RE and LE, and maintaining the handset contact with the pinna, rotate the handset about the N-F line until any point on the handset is in contact with a phantom point below the pinna on the cheek.

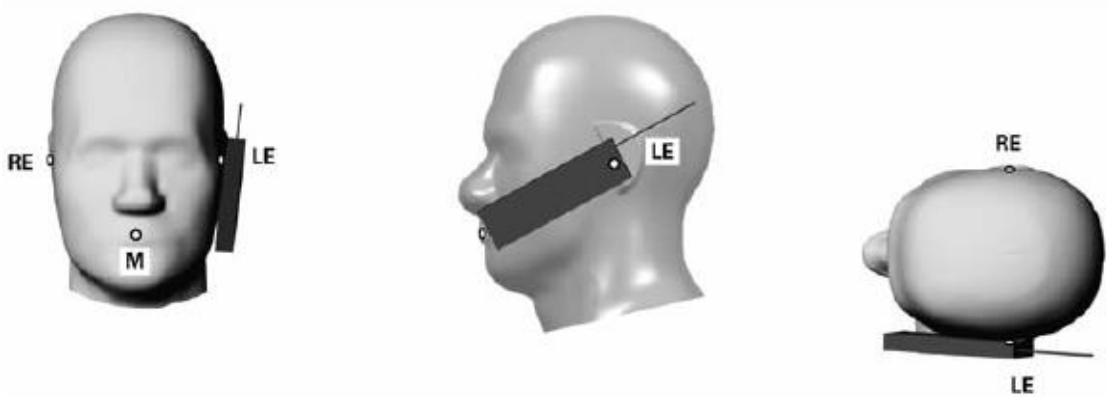

TEST REPORT

DEFINITION OF THE TILT POSITION

The tilt position is established as follows:

1. Repeat steps to place the device in the cheek position.
2. While maintaining the orientation of the handset, move the handset away from the pinna along the line passing through RE and LE far enough to allow a rotation of the handset away from the cheek by 15°.
3. Rotate the handset around the horizontal line by 15°.
4. While maintaining the orientation of the handset, move the handset towards the phantom on the line passing through RE and LE until any part of the handset touches the ear. The tilt position is obtained when the contact point is on the pinna. See the figure as below. If contact occurs at any location other than the pinna, e.g., the antenna at the back of the phantom head, the angle of the handset should be reduced.
5. In this case, the tilt position is obtained if any point on the handset is in contact with the pinna and a second point on the handset is in contact with the phantom, e.g., the antenna with the back of the head.

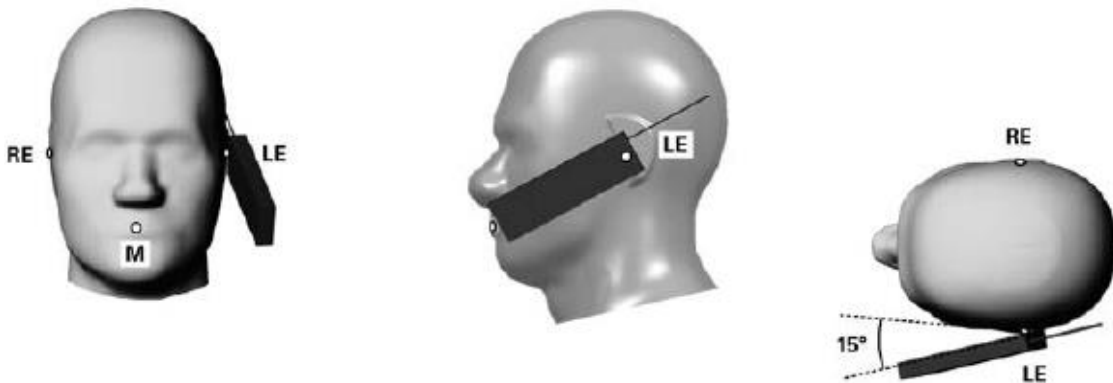

TEST REPORT

6.2. Device test positions relative to body-worn accessory

Body-worn operating configurations are tested with the belt-clips and holsters attached to the device and positioned against a flat phantom in a normal use configuration. Per FCC KDB Publication 648474, Body-worn accessory exposure is typically related to voice mode operations when handsets are carried in body worn accessories. The body-worn accessory procedures in FCC KDB Publication 447498 should be used to test for body-worn accessory SAR compliance, without a headset connected to it. This enables the test results for such configuration to be compatible with that required for hotspot mode when the body-worn accessory test separation distance is greater than or equal to that required for hotspot mode, when applicable. When the reported SAR for a body-worn accessory, measured without a headset connected to the handset, is $>1.2\text{W/kg}$, the highest reported SAR configuration for that wireless mode and frequency band should be reported for that body-worn accessory with a headset attached to the handset.

SAR evaluation is required for body-worn accessories supplied with the host device. The test configurations must be conservative for supporting the body-worn accessory use conditions expected by users. Body-worn accessories that do not contain metallic or conductive components may be tested according to worst-case exposure configurations, typically according to the smallest test separation distance required for the group of body-worn accessories with similar operating and exposure characteristics. All body-worn accessories containing metallic components, either supplied with the product or available as an option from the device manufacturer, must be tested in conjunction with the host device to demonstrate compliance

Body-worn accessories may not always be supplied or available as options for some devices intended to be authorized for body-worn use. In this case, a test configuration with a separation distance between the back of the device and the flat phantom is used. Test position spacing was documented. Transmitters that are designed to operate in front of a person's face, as in push-to-talk configurations, are tested for SAR compliance with the front of the device positioned to face the flat phantom in head fluid.

TEST REPORT

6.3. Device test positions relative to Body-supported device

Per IEC/IEEE 62209-1528: 2020, a typical example of a body supported device is a wireless enabled laptop device that among other orientations may be supported on the thighs of a sitting user. To represent this orientation, the device shall be positioned with its base against the flat phantom. Other orientations may be specified by the manufacturer in the user instructions. If the intended use is not specified, the device shall be tested directly against the flat phantom in all usable orientations.

Devices that fall into this category include tablet type portable computers and credit card transaction authorization terminals, point-of-sale and/or inventory terminals. Where these devices may be torso or limb-supported, the same principles for body-supported devices are applied.

The example in Figure a) shows a tablet form factor portable computer for which SAR should be separately assessed with each surface and the separation distances positioned against the flat phantom that correspond to the intended use as specified by the manufacturer. If the intended use is not specified in the user instructions, the device shall be tested directly against the flat phantom in all usable orientations.

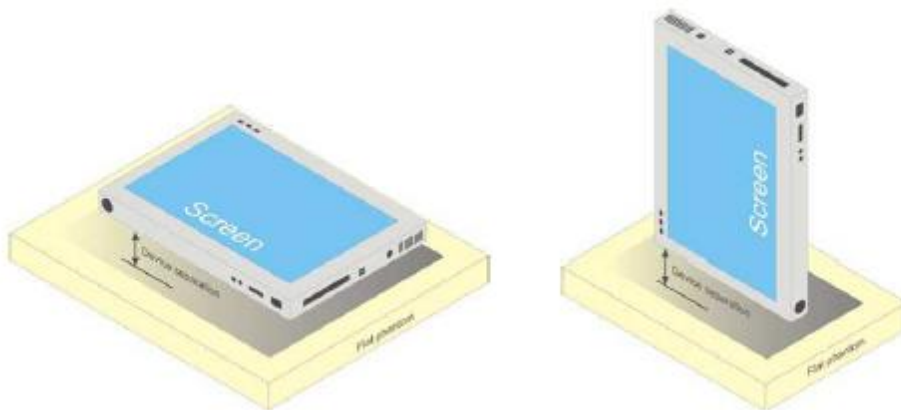
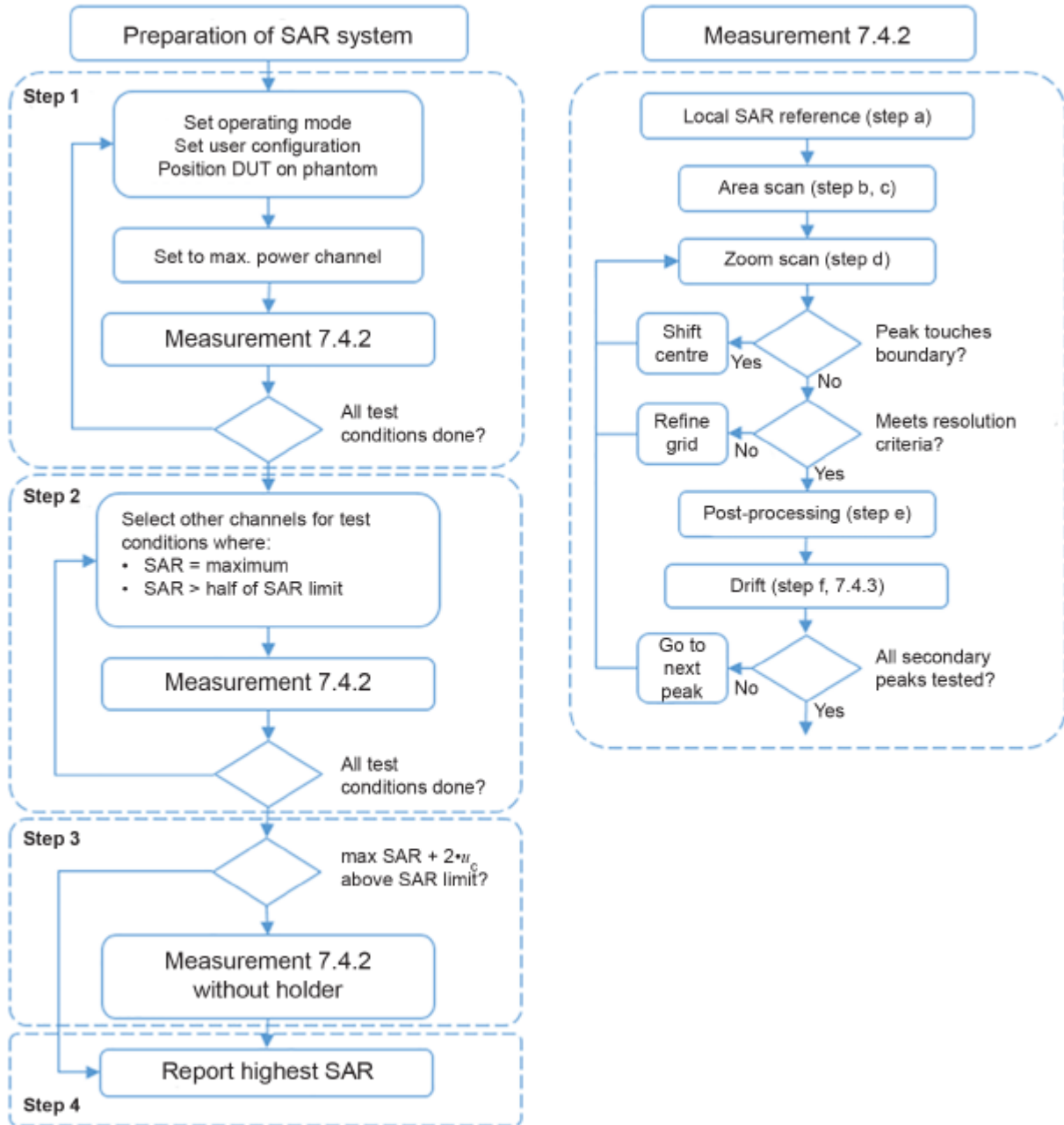

Figure a) – Tablet form factor portable computer

TEST REPORT

A block diagram of testing procedure is shown as below figure.



IEC

TEST REPORT

6.4. General Device Setup

The device was first charged on a charger over a duration defined by the applicant to make sure the installed battery was fully charged.

The device was then placed into test mode to simulate the worst case configuration through the highest power channel, where the operating parameters established in this test mode is identical to those programmed in production units, including output power levels, amplifier gain settings and other RF performance tuning parameters. The test frequency is corresponded to actual channel frequencies defined for domestic use.

During testing, the device was evaluated with a fully charged battery, power saving function disabled and was configured to operate at maximum output power. A receive antenna and a spectrum analyzer were placed with a distance > 50cm away from the device to monitor the transmission states.

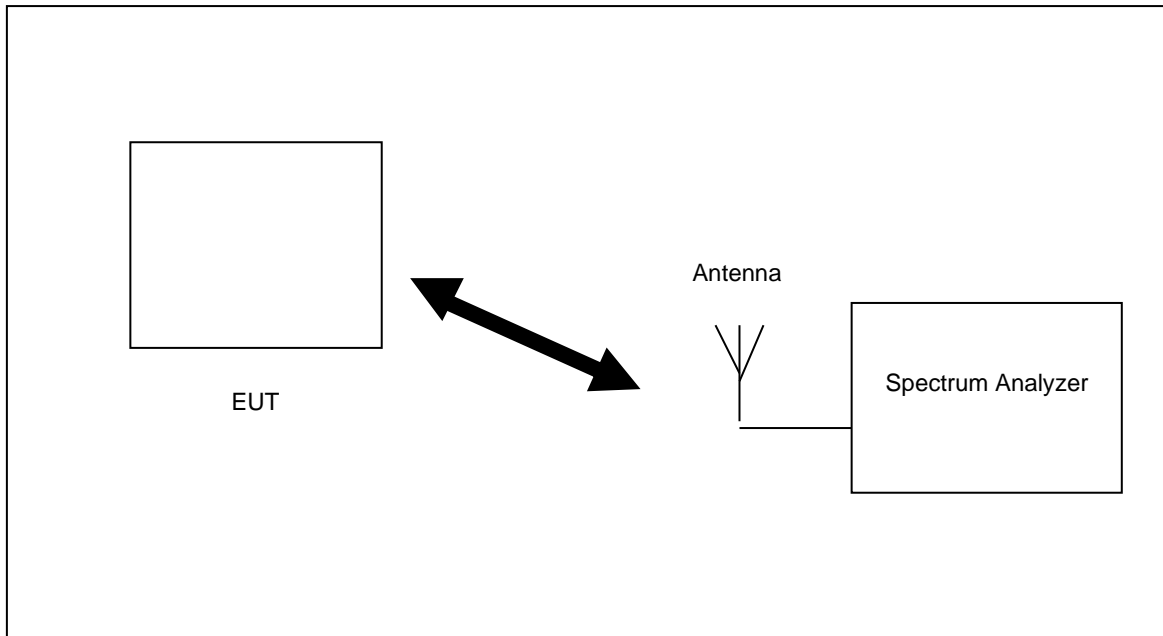

TEST REPORT

6.5. RF Output Power Measurements

Frequency	Channel	Duty Cycle	Maximum Tune-up Power (dBm)	Measured Conducted Power (Peak) (dBm)	Measured Conducted Power (Time Average) (dBm)
2405	1		17	16.8	6.7
2439	17	9.7%	17	15.6	5.5
2475	32		17	15.0	4.9

Note:

1. Time Average power (dBm) = Peak power (dBm) + Time Average factor.
2. Time Average factor = $10 \cdot \log(\text{duty cycle})$
3. Per KDB 447498, the tested device was within the specified tune-up tolerances range, but not more than 2dB lower than the maximum tune-up tolerance limit.
4. Per KDB 447498, when antenna port was not available on the device to support conducted power measurement and test software was used to establish transmitter power levels, the power level was verified separately according to design and component specifications and product development information specified by the manufacturer.

TEST REPORT

6.6. SAR Test Exclusion Consideration for Adjacent Edges

The Exemption limits for Routine Evaluation – SAR Evaluation in KDB 447498 can be applied to determine SAR test exclusion for adjacent edge configurations.

The test separation distance for SAR test exclusion of adjacent edges is determined by the closest distance between the antenna and outer housing on the adjacent edge of the device.

According to the antenna to outer housing separation distance and maximum time-averaged output power as below, SAR evaluation of **top, left, right, back and bottom** edges are not required. However, client optional decided to keep Front position for data evaluation.

Exposure Position	Antenna to Outer Housing Separation Distance	SAR Exemption Limit	Maximum Time-Averaged Conducted Power	SAR Exclusion Result
Front	5 mm	>9.6 mW	4.7 mW	Test required ¹
Top	5 mm	>9.6 mW		Excluded
Left	64 mm	>96 mW		Excluded
Right	74 mm	>96 mW		Excluded
Back	4 mm	>9.6 mW		Excluded
Bottom	24 mm	46 mW		Excluded

Note:

1. Client optional decided to keep Front position for data evaluation.

TEST REPORT

6.7. Exposure Conditions

In-Front-of Mouth Exposure Conditions

Test Configurations	Distance to Phantom	Operation Mode	SAR Required	Note
Front	0mm Separation	Data	Yes ¹	

Note:

1. Client optional decided to keep Front position for data evaluation.
2. Per KDB 447498 D01, if the device is designed to operate in front of the mouth, such as PTT radio, it shall be evaluated with the front of the device positioned at 2.5 cm from a flat phantom. However, Front 0mm Separation will be tested as the worst case.

Body Exposure Conditions

Test Configurations	Distance to Phantom	Operation Mode	SAR Required	Note
Front	0mm Separation	Data	No	SAR test exclusion applied
Top	0mm Separation	Data	No	SAR test exclusion applied
Left	0mm Separation	Data	No	SAR test exclusion applied
Right	0mm Separation	Data	No	SAR test exclusion applied
Back	0mm Separation	Data	No	SAR test exclusion applied
Bottom	0mm Separation	Data	No	SAR test exclusion applied

Note:

1. Per KDB 447498 D01, SAR Evaluation can be applied to determine SAR test exclusion for adjacent edge configuration.

TEST REPORT

6.8. Test Result

The results on the following page(s) were obtained when the device was tested in the condition described in this report. Detailed measurement data and plots, which reveal information about the location of the maximum SAR with respect to the device, are reported in Appendix B.

In-Front-of Mouth SAR

Chan	Freq. (MHz)	Battery	Mode	Test Position	Measurement Result						
					Maximum Allowed Power (dBm)	Measured Power (dBm)	SAR Drift (%)	Measured SAR _{1g} (W/kg)	Scaling factor	Reported SAR _{1g} (W/kg)	Plot
1	2405	3.6V	Data	Front 0mm	17	16.8	-1.14	0.264	1.047	0.276	
17	2439	3.6V	Data	Front 0mm	17	15.6	-3.48	0.281	1.380	0.388	
32	2475	3.6V	Data	Front 0mm	17	15	1.43	0.351	1.585	0.556	
32	2475	3.6V	Data	Front 0mm	17	15	-0.77	0.368	1.585	0.583	1

Note:

1. Fully charged batteries were used at the beginning of each SAR measurement.
2. There was no power reduction used for any band/mode implemented in this device.
3. Reported SAR results were scaled to the maximum allowed power with the scaling factor equation $-10^{[(\text{Maximum power} - \text{measured power}) / 10]}$.
4. Per KDB 447498 D01, if the reported SAR value was ≤ 0.8 W/kg and the transmission band was ≤ 100 MHz, SAR testing was not required for the other test channels in the band.
5. Per KDB 865664 D01, repeated measurement was not required when the original highest measured SAR was < 0.8 W/kg.
6. Per KDB 865664 D02, SAR plot is required for the highest measured SAR in each exposure configuration, wireless mode, and frequency band combination.
7. Per KDB 865664 D01, when the maximum output power variation across the required test channels was < 0.5 dB, measurement on the middle channel was required.

TEST REPORT

6.9. SAR Limits

The following FCC limits (Std. C95.1-1992) for SAR apply to devices operate in General Population/Uncontrolled Exposure and Controlled environment:

GENERAL POPULATION / UNCONTROLLED ENVIRONMENTS:

Defined as location where there is the exposure of individuals who have no knowledge or control of their exposure.

EXPOSURE (General Population/Uncontrolled Exposure environment)	SAR (W/kg)
Spatial Peak SAR (Head)*	1.60
Spatial Peak SAR (Partial Body)*	1.60
Spatial Peak SAR (Whole Body)*	0.08
Spatial Peak SAR (Hands / Wrists / Feet / Ankles)**	4.00

OCCUPATIONAL / CONTROLLED ENVIRONMENTS:

Defined as location where there is the exposure that may be incurred by persons who are aware of the potential for exposure, (i.e. as a result of employment or occupation)

EXPOSURE (Occupational/Controlled Exposure environment)	SAR (W/kg)
Spatial Peak SAR (Head)*	8.00
Spatial Peak SAR (Partial Body)*	8.00
Spatial Peak SAR (Whole Body)*	0.40
Spatial Peak SAR (Hands / Wrists / Feet / Ankles)**	20.00

Notes:

- * The Spatial Peak value of the SAR averaged over any 1 gram of tissue.
(defined as a tissue volume in the shape of a cube) and over the appropriate averaging time
- ** The Spatial Peak value of the SAR averaged over any 10 gram of tissue.
(defined as a tissue volume in the shape of a cube) and over the appropriate averaging time

TEST REPORT

7. TEST EQUIPMENT LIST

Equipment	Registration No.	Manufacturer	Model No.	Calibration Date	Calibration Due Date
SAR System	EW-3211	MVG	SATIMO System (OpenSAR Software V4_02_34)	N/A	N/A
Phantom	EW-3211	SATIMO	COMOSAR SAM PHANTOM	N/A	N/A
SAR Probe	EW-3210	MVG	SSE2 (SN 05/23 EPGO402)	14 Feb 2023	14 Feb 2024
SAR Dipole	EW-3212	MVG	SN 22/16 DIP2G450-411	14 Feb 2023	14 Feb 2024
Dielectric Probe for SAR Test	EW-3213	MVG	Liquid Measurement Kit (SN 24/16 OCPG 76)	14 Feb 2023	14 Feb 2024
Head Liquid Tissue	N/A	MVG	Head Liquid 2450MHz	Refer to Section 4	
Body Liquid Tissue	N/A	MVG	Body Liquid 2450MHz	Refer to Section 4	
Network Analyzer	EW-3192	Rhode & Schwarz	ZVL6	20 Dec 2022	20 Dec 2023
Plastic Ruler	EW-3084	MUJI	30cm	23 Jan 2023	23 Jan 2024
Signal and Spectrum Analyzer (9kHz to 13.6GHz)	EW-2839	Rhode & Schwarz	FSP13	29 Nov 2023	29 Nov 2024
Precision Dual Coupler (0.8-3GHz 20dB)	EW-3184	VectaWave USA	VDC0830-20	19 Sept 2023	19 Sept 2024
SAR Amplifier	EW-3185	IndexSAR	VTL 5400	04 Sept 2023	04 Sept 2024
Digital Thermo- Meter for SAR test	EW-2901	TES	1306	28 Aug 2023	28 Aug 2024
Signal Generator (250kHz – 40GHz)	EW-1983	Agilent Technologies	E8247C	04 Sept 2023	04 Sept 2025
Wideband power sensor 2 pcs 50MHz to 18GHz	EW-3309	Rhode & Schwarz	NRP-Z81	14 Feb 2023	14 Feb 2024

TEST REPORT

8. MEASUREMENT UNCERTAINTY

Per FCC KDB 865884, the extensive SAR measurement uncertainty analysis was not required when the highest measured SAR was $< 1.5\text{W/kg}$ for all frequency band.

Decision Rule for compliance: For FCC/IC standard, the measured value must be within the limits of applicable standard without accounting for the measurement uncertainty. For EN/IEC/HKTA/HKTC standard, conformity rules will be used as per standard directly excepted EN/IEC 61000-3-2, EN/IEC 61000-3-3, HKTA1004, HKCA1008, HKTA1019, HKTA1020, HKTA1041 and HKTA1044.

TEST REPORT

9. E-FIELD PROBE AND DIPOLE ANTENNA CALIBRATION

Probe calibration factors and dipole antenna calibration are included in Appendix C.

TEST REPORT

APPENDIX A – SYSTEM CHECK DATA

Plot #1

Operating Frequency: 2450MHz

Test Date: December 8, 2023

Medium (Liquid Type)	: 2450 Head
Relative permittivity ϵ_r	: 40.42
Conductivity σ :	: 1.87
Probe	: Model: SSE2; Serial No.: SN 05/23 EPGO402
Crest factor	: 1.0
Conversion Factor	: 2.54
Area Scan	: dx=8mm, dy=8mm
Zoom Scan	: 7x7x7, dx=5mm dy=5mm dz=5mm
Phantom	: SAM phantom
Device Position	: Dipole
SAR Drift (%)	: 0.49%
Maximum location	: X=-7.00, Y=-1.00
SAR Peak (W/kg)	: 9.46 W/kg
SAR 10g (W/kg)	: 2.836 W/kg
SAR 1g (W/kg)	: 5.539 W/kg

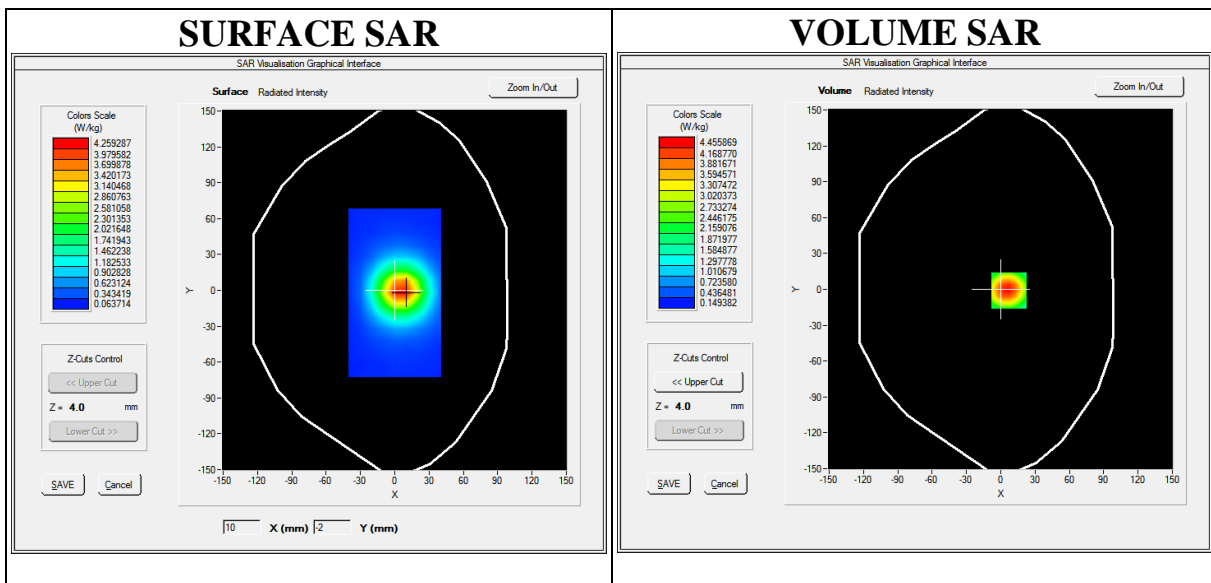

TEST REPORT

APPENDIX B – SAR EVALUATION DATA

Plot #1

Operating Frequency: 2475MHz

Product Description: Video Monitor - Parent Unit

Model: VM3254 PU (3.6VDC 2600mAh Li-ion rechargeable Battery)

Test Date: December 8, 2023

Medium (Liquid Type)	: 2450 Head
Relative permittivity ϵ_r	: 40.42
Conductivity σ :	: 1.87
Probe	: Model: SSE2; Serial No.: SN 05/23 EPG0402
Crest factor	: 1.0
Conversion Factor	: 2.54
Area Scan	: dx=8mm, dy=8mm
Zoom Scan	: 7x7x7, dx=5mm dy=5mm dz=5mm
Phantom	: SAM phantom
Device Position	: Front 0mm separation
SAR Drift (%)	: -0.77%
Maximum location	: X=0.00, Y=9.00
SAR Peak (W/kg)	: 0.46 W/kg
SAR 10g (W/kg)	: 0.198 W/kg
SAR 1g (W/kg)	: 0.368 W/kg

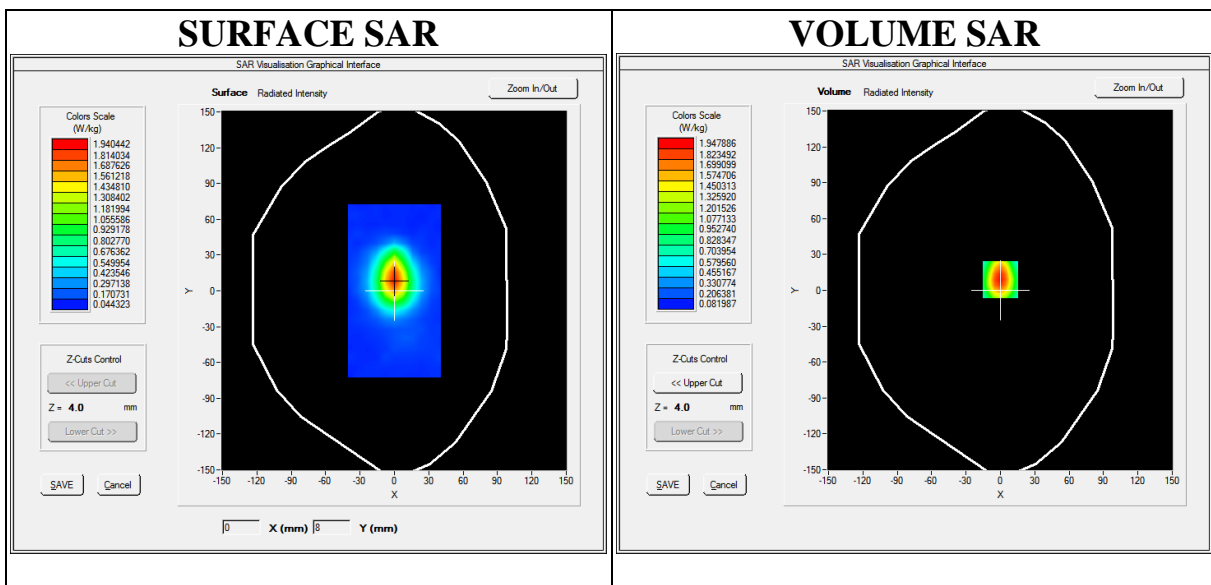

TEST REPORT

APPENDIX C – E-FIELD PROBE AND DIPOLE ANTENNA CALIBRATION



COMOSAR E-Field Probe Calibration Report

Ref : ACR.45.13.23.BES.A

INTERTEK TESTING SERVICES HONG KONG LIMITED

WORKSHOP NO. 3 G/F, WORLD-WIDE INDUSTRIAL
CENTRE, 43-47 SHAN MEI STREET,
FO TAN, SHA TIN, N.T. HONG KONG
MVG COMOSAR DOSIMETRIC E-FIELD PROBE
SERIAL NO.: 0523-EPGO-402

Calibrated at MVG

Z.I. de la pointe du diable

Technopôle Brest Iroise – 295 avenue Alexis de Rochon
29280 PLOUZANE - FRANCE

Calibration date: 02/14/2023





Accreditations #2-6789
Scope available on www.cofrac.fr

The use of the Cofrac brand and the accreditation references is prohibited from any reproduction.

Summary:

This document presents the method and results from an accredited COMOSAR Dosimetric E-Field Probe calibration performed at MVG, using the CALIPROBE test bench, for use with a MVG COMOSAR system only. The test results covered by accreditation are traceable to the International System of Units (SI).

	<i>Name</i>	<i>Function</i>	<i>Date</i>	<i>Signature</i>
<i>Prepared by :</i>	Cyrille ONNEE	Measurement Responsible	2/14/2023	
<i>Checked & approved by:</i>	Jérôme Luc	Technical Manager	2/14/2023	
<i>Authorized by:</i>	Yann Toutain	Laboratory Director	2/14/2023	<i>Yann TOUTAIN</i>

Yann
Toutain ID  Signature numérique
de Yann Toutain IC
Date : 2023.02.14
17:05:25 +01'00'

	<i>Customer Name</i>
<i>Distribution :</i>	Intertek Testing Services Hong Kong Limited

<i>Issue</i>	<i>Name</i>	<i>Date</i>	<i>Modifications</i>
A	Cyrille ONNEE	2/14/2023	Initial release

TABLE OF CONTENTS

1 Device Under Test 4

2 Product Description 4

 2.1 General Information 4

3 Measurement Method 4

 3.1 Sensitivity 4

 3.2 Linearity 5

 3.3 Isotropy 5

 3.4 Boundary Effect 5

4 Measurement Uncertainty 6

5 Calibration Results..... 6

 5.1 Calibration in air 6

 5.2 Calibration in liquid 7

6 Verification Results 8

7 List of Equipment 9

1 DEVICE UNDER TEST

Device Under Test	
Device Type	COMOSAR DOSIMETRIC E FIELD PROBE
Manufacturer	MVG
Model	SSE2
Serial Number	0523-EPGO-402
Product Condition (new / used)	New
Frequency Range of Probe	0.15 GHz-7.5GHz
Resistance of Three Dipoles at Connector	Dipole 1: R1=0.221 MΩ Dipole 2: R2=0.211 MΩ Dipole 3: R3=0.230 MΩ

2 PRODUCT DESCRIPTION

2.1 GENERAL INFORMATION

MVG's COMOSAR E field Probes are built in accordance to the IEC/IEEE 62209-1528 and FCC KDB865664 D01 standards.



Figure 1 – MVG COMOSAR Dosimetric E field Probe

Probe Length	330 mm
Length of Individual Dipoles	2 mm
Maximum external diameter	8 mm
Probe Tip External Diameter	2.5 mm
Distance between dipoles / probe extremity	1 mm

3 MEASUREMENT METHOD

The IEC/IEEE 62209-1528 and FCC KDB865664 D01 standards provide recommended practices for the probe calibrations, including the performance characteristics of interest and methods by which to assess their effect. All calibrations / measurements performed meet the fore-mentioned standards.

3.1 SENSITIVITY

The sensitivity factors of the three dipoles were determined using a two step calibration method (air and tissue simulating liquid) using waveguides as outlined in the standards for frequency range 600-7500MHz and using the calorimeter cell method (transfer method) as outlined in the standards for frequency 150-450 MHz.

3.2 LINEARITY

The evaluation of the linearity was done in free space using the waveguide, performing a power sweep to cover the SAR range 0.01W/kg to 100W/kg.

3.3 ISOTROPY

The axial isotropy was evaluated by exposing the probe to a reference wave from a standard dipole with the dipole mounted under the flat phantom in the test configuration suggested for system validations and checks. The probe was rotated along its main axis from 0 to 360 degrees in 15-degree steps. The hemispherical isotropy is determined by inserting the probe in a thin plastic box filled with tissue-equivalent liquid, with the plastic box illuminated with the fields from a half wave dipole. The dipole is rotated about its axis (0°–180°) in 15° increments. At each step the probe is rotated about its axis (0°–360°).

3.4 BOUNDARY EFFECT

The boundary effect is defined as the deviation between the SAR measured data and the expected exponential decay in the liquid when the probe is oriented normal to the interface. To evaluate this effect, the liquid filled flat phantom is exposed to fields from either a reference dipole or waveguide. With the probe normal to the phantom surface, the peak spatial average SAR is measured and compared to the analytical value at the surface.

The boundary effect uncertainty can be estimated according to the following uncertainty approximation formula based on linear and exponential extrapolations between the surface and $d_{be} + d_{step}$ along lines that are approximately normal to the surface:

$$SAR_{uncertainty} [\%] = \Delta SAR_{be} \frac{(d_{be} + d_{step})^2}{2d_{step}} \frac{(e^{-d_{be}/\delta})}{\delta/2} \text{ for } (d_{be} + d_{step}) < 10 \text{ mm}$$

where

- $SAR_{uncertainty}$ is the uncertainty in percent of the probe boundary effect
- d_{be} is the distance between the surface and the closest *zoom-scan* measurement point, in millimetre
- Δ_{step} is the separation distance between the first and second measurement points that are closest to the phantom surface, in millimetre, assuming the boundary effect at the second location is negligible
- δ is the minimum penetration depth in millimetres of the head tissue-equivalent liquids defined in this standard, i.e., $\delta \approx 14$ mm at 3 GHz;
- ΔSAR_{be} in percent of SAR is the deviation between the measured SAR value, at the distance d_{be} from the boundary, and the analytical SAR value.

The measured worst case boundary effect $SAR_{uncertainty}[\%]$ for scanning distances larger than 4mm is 1.0% Limit ,2%).

4 MEASUREMENT UNCERTAINTY

The guidelines outlined in the IEC/IEEE 62209-1528 and FCC KDB865664 D01 standards were followed to generate the measurement uncertainty associated with a SAR probe calibration using the waveguide or calorimetric cell technique depending on the frequency.

The estimated expanded uncertainty (k=2) in calibration for SAR (W/kg) is +/-11% for the frequency range 150-450MHz.

The estimated expanded uncertainty (k=2) in calibration for SAR (W/kg) is +/-14% for the frequency range 600-7500MHz.

5 CALIBRATION RESULTS

Ambient condition	
Liquid Temperature	20 +/- 1 °C
Lab Temperature	20 +/- 1 °C
Lab Humidity	30-70 %

5.1 CALIBRATION IN AIR

The following curve represents the measurement in waveguide of the voltage picked up by the probe toward the E-field generated inside the waveguide.

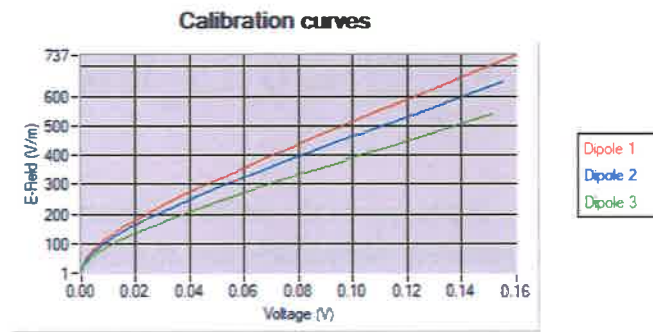

From this curve, the sensitivity in air is calculated using the below formula.

$$E^2 = \sum_{i=1}^3 \frac{V_i (1 + V_i / DCP_i)}{Norm_i}$$

where

Vi=voltage readings on the 3 channels of the probe

DCPi=diode compression point given below for the 3 channels of the probe

Normi=dipole sensitivity given below for the 3 channels of the probe

Normx dipole 1 ($\mu\text{V}/(\text{V}/\text{m})^2$)	Normy dipole 2 ($\mu\text{V}/(\text{V}/\text{m})^2$)	Normz dipole 3 ($\mu\text{V}/(\text{V}/\text{m})^2$)
0.72	0.86	1.24

DCP dipole 1 (mV)	DCP dipole 2 (mV)	DCP dipole 3 (mV)
112	119	110

5.2 CALIBRATION IN LIQUID

The calorimeter cell or the waveguide is used to determine the calibration in liquid using the formula below.

$$ConvF = \frac{E_{liquid}^2}{E_{air}^2}$$

The E-field in the liquid is determined from the SAR measurement according to the below formula.

$$E_{liquid}^2 = \frac{\rho SAR}{\sigma}$$

where

σ =the conductivity of the liquid

ρ =the volumetric density of the liquid

SAR=the SAR measured from the formula that depends on the setup used. The SAR formulas are given below

For the calorimeter cell (150-450 MHz), the formula is:

$$SAR = c \frac{dT}{dt}$$

where

c =the specific heat for the liquid

dT/dt =the temperature rises over the time

For the waveguide setup (600-75000 MHz), the formula is:

$$SAR = \frac{4Pw}{ab\delta} e^{-\frac{2z}{\delta}}$$

where

a =the larger cross-sectional of the waveguide

b =the smaller cross-sectional of the waveguide

δ =the skin depth for the liquid in the waveguide

Pw =the power delivered to the liquid

The below table summarize the ConvF for the calibrated liquid. The curves give examples for the measured SAR depending on the voltage in some liquid.

Liquid	Frequency (MHz*)	ConvF
HL1800	1800	2.31
BL1800	1800	2.27
HL1900	1900	2.40
BL1900	1900	2.52
HL2450	2450	2.54
BL2450	2450	2.82

(*) Frequency validity is +/-50MHz below 600MHz, +/-100MHz from 600MHz to 6GHz and +/-500MHz above 6GHz

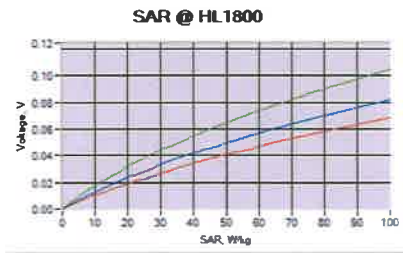

6 VERIFICATION RESULTS

The figures below represent the measured linearity and axial isotropy for this probe. The probe specification is +/-0.2 dB for linearity and +/-0.15 dB for axial isotropy.

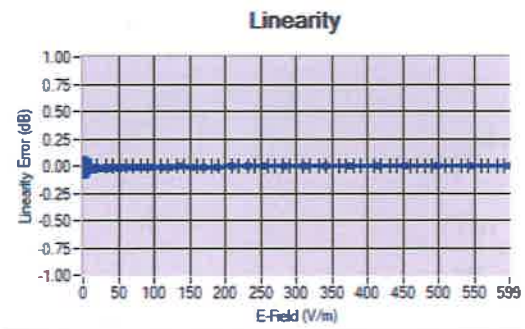

Linearity: +/-1.95% (+/-0.09dB)

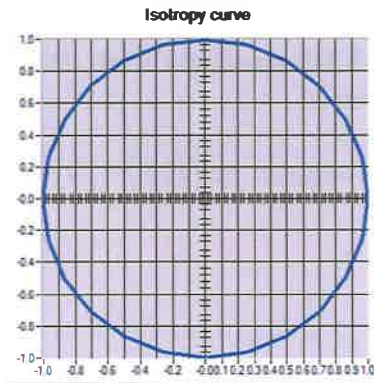

Isotropy: +/-0.17% (+/-0.01dB)



7 LIST OF EQUIPMENT

Equipment Summary Sheet				
Equipment Description	Manufacturer / Model	Identification No.	Current Calibration Date	Next Calibration Date
CALIPROBE Test Bench	Version 2	NA	Validated. No cal required.	Validated. No cal required.
Network Analyzer	Rohde & Schwarz ZVM	100203	08/2021	08/2024
Network Analyzer	Agilent 8753ES	MY40003210	10/2019	10/2023
Network Analyzer – Calibration kit	HP 85033D	3423A08186	06/2021	06/2027
Network Analyzer – Calibration kit	Rohde & Schwarz ZV-Z235	101223	07/2022	07/2025
Multimeter	Keithley 2000	4013982	02/2023	02/2026
Signal Generator	Rohde & Schwarz SMB	106589	03/2022	03/2025
Amplifier	MVG	MODU-023-C-0002	Characterized prior to test. No cal required.	Characterized prior to test. No cal required.
Power Meter	NI-USB 5680	170100013	06/2021	06/2024
Power Meter	NI-USB 5680	170100013	06/2021	06/2024
Directional Coupler	Krytar 158020	131467	Characterized prior to test. No cal required.	Characterized prior to test. No cal required.
Fluoroptic Thermometer	LumaSense Luxtron 812	94264	09/2022	09/2025
Coaxial cell	MVG	SN 32/16 COAXCELL_1	Validated. No cal required.	Validated. No cal required.
Waveguide	MVG	SN 32/16 WG2_1	Validated. No cal required.	Validated. No cal required.
Liquid transition	MVG	SN 32/16 WGLIQ_0G600_1	Validated. No cal required.	Validated. No cal required.
Waveguide	MVG	SN 32/16 WG4_1	Validated. No cal required.	Validated. No cal required.
Liquid transition	MVG	SN 32/16 WGLIQ_0G900_1	Validated. No cal required.	Validated. No cal required.
Waveguide	MVG	SN 32/16 WG6_1	Validated. No cal required.	Validated. No cal required.
Liquid transition	MVG	SN 32/16 WGLIQ_1G500_1	Validated. No cal required.	Validated. No cal required.
Waveguide	MVG	SN 32/16 WG8_1	Validated. No cal required.	Validated. No cal required.



Liquid transition	MVG	SN 32/16 WGLIQ_1G800B_1	Validated. No cal required.	Validated. No cal required.
Liquid transition	MVG	SN 32/16 WGLIQ_1G800H_1	Validated. No cal required.	Validated. No cal required.
Waveguide	MVG	SN 32/16 WG10_1	Validated. No cal required.	Validated. No cal required.
Liquid transition	MVG	SN 32/16 WGLIQ_3G500_1	Validated. No cal required.	Validated. No cal required.
Waveguide	MVG	SN 32/16 WG12_1	Validated. No cal required.	Validated. No cal required.
Liquid transition	MVG	SN 32/16 WGLIQ_5G000_1	Validated. No cal required.	Validated. No cal required.
Waveguide	MVG	SN 32/16 WG14_1	Validated. No cal required.	Validated. No cal required.
Liquid transition	MVG	SN 32/16 WGLIQ_7G000_1	Validated. No cal required.	Validated. No cal required.
Temperature / Humidity Sensor	Testo 184 H1	44225320	06/2021	06/2024



SAR Reference Dipole Calibration Report

Ref : ACR.45.17.23.BES.A

INTERTEK TESTING SERVICES HONG KONG LIMITED

**WORKSHOP NO. 3 G/F, WORLD-WIDE INDUSTRIAL
CENTRE, 43-47 SHAN MEI STREET,
FO TAN, SHA TIN, N.T. HONG KONG**

MVG COMOSAR REFERENCE DIPOLE

FREQUENCY: 2450 MHZ

SERIAL NO.: SN 22/16 DIP2G450-411

Calibrated at MVG

Z.I. de la pointe du diable

Technopôle Brest Iroise – 295 avenue Alexis de Rochon

29280 PLOUZANE - FRANCE

Calibration date: 02/14/2023



Accreditations #2-6789 and #2-6814
Scope available on www.cofrac.fr

The use of the Cofrac brand and the accreditation references is prohibited from any reproduction.

Summary:

This document presents the method and results from an accredited SAR reference dipole calibration performed in MVG using the COMOSAR test bench. All calibration results are traceable to national metrology institutions.



	<i>Name</i>	<i>Function</i>	<i>Date</i>	<i>Signature</i>
<i>Prepared by :</i>	Cyrille ONNEE	Measurement Responsible	2/14/2023	
<i>Checked & approved by:</i>	Jérôme Luc	Technical Manager	2/14/2023	
<i>Authorized by:</i>	Yann Toutain	Laboratory Director	2/14/2023	

Yann
Toutain ID

Signature numérique
de Yann Toutain ID
Date : 2023.02.14
17:36:33 +01'00'

	<i>Customer Name</i>
<i>Distribution :</i>	Intertek Testing Services Hong Kong Limited

<i>Issue</i>	<i>Name</i>	<i>Date</i>	<i>Modifications</i>
A	Cyrille ONNEE	2/14/2023	Initial release



TABLE OF CONTENTS

1 Introduction..... 4

2 Device Under Test 4

3 Product Description 4

 3.1 General Information 4

4 Measurement Method 5

 4.1 Mechanical Requirements 5

 4.2 S11 parameter Requirements 5

 4.3 SAR Requirements 5

5 Measurement Uncertainty 5

 5.1 Mechanical dimensions 5

 5.2 S11 Parameter 5

 5.3 SAR 5

6 Calibration Results..... 6

 6.1 Mechanical Dimensions 6

 6.2 S11 parameter 6

 6.3 SAR 7

7 List of Equipment 10

1 INTRODUCTION

This document contains a summary of the requirements set forth by the IEC/IEEE 62209-1528 and FCC KDB865664 D01 standards for reference dipoles used for SAR measurement system validations and the measurements that were performed to verify that the product complies with the fore mentioned standards.

2 DEVICE UNDER TEST

Device Under Test	
Device Type	COMOSAR 2450 MHz REFERENCE DIPOLE
Manufacturer	MVG
Model	SID2450
Serial Number	SN 22/16 DIP2G450-411
Product Condition (new / used)	Used

3 PRODUCT DESCRIPTION

3.1 GENERAL INFORMATION

MVG's COMOSAR Validation Dipoles are built in accordance to the IEC/IEEE 62209-1528 and FCC KDB865664 D01 standards. The product is designed for use with the COMOSAR test bench only.



Figure 1 – MVG COMOSAR Validation Dipole

4 MEASUREMENT METHOD

4.1 MECHANICAL REQUIREMENTS

The IEC/IEEE 62209-1528 and FCC KDB865664 D01 standards specify the mechanical components and dimensions of the validation dipoles, with the dimension's frequency and phantom shell thickness dependent. The COMOSAR test bench employs a 2 mm phantom shell thickness therefore the dipoles sold for use with the COMOSAR test bench comply with the requirements set forth for a 2 mm phantom shell thickness. A direct method is used with a ISO17025 calibrated caliper.

4.2 S11 PARAMETER REQUIREMENTS

The dipole used for SAR system validation measurements and checks must have a S11 of -20 dB or better. The S11 measurement shall be performed against a liquid filled flat phantom, with the phantom constructed as outlined in the fore mentioned standards. A direct method is used with a network analyser and its calibration kit, both with a valid ISO17025 calibration.

4.3 SAR REQUIREMENTS

The IEC/IEEE 62209-1528 and FCC KDB865664 D01 standards provide requirements for reference dipoles used for system validation measurements. The following measurements were performed to verify that the product complies with the fore-mentioned standards.

5 MEASUREMENT UNCERTAINTY

5.1 MECHANICAL DIMENSIONS

For the measurement in the range 0-300mm, the estimated expanded uncertainty (k=2) in calibration for the dimension measurement in mm is +/-0.20 mm with respect to measurement conditions.

For the measurement in the range 300-450mm, the estimated expanded uncertainty (k=2) in calibration for the dimension measurement in mm is +/-0.44 mm with respect to measurement conditions.

5.2 S11 PARAMETER

The estimated expanded uncertainty (k=2) in calibration for the S11 parameter in linear is +/-0.08 with respect to measurement conditions.

5.3 SAR

The guidelines outlined in the IEC/IEEE 62209-1528 and FCC KDB865664 D01 standards were followed to generate the measurement uncertainty for validation measurements.

The estimated expanded uncertainty (k=2) in calibration for the 1g and 10g SAR measurement in W/kg is +/-19% with respect to measurement conditions.

6 CALIBRATION RESULTS

6.1 MECHANICAL DIMENSIONS

L mm		h mm		d mm	
Measured	Required	Measured	Required	Measured	Required
-	51.50 +/- 2%	-	30.40 +/- 2%	-	3.60 +/- 2%

6.2 S11 PARAMETER

6.2.1 S11 parameter in Head Liquid

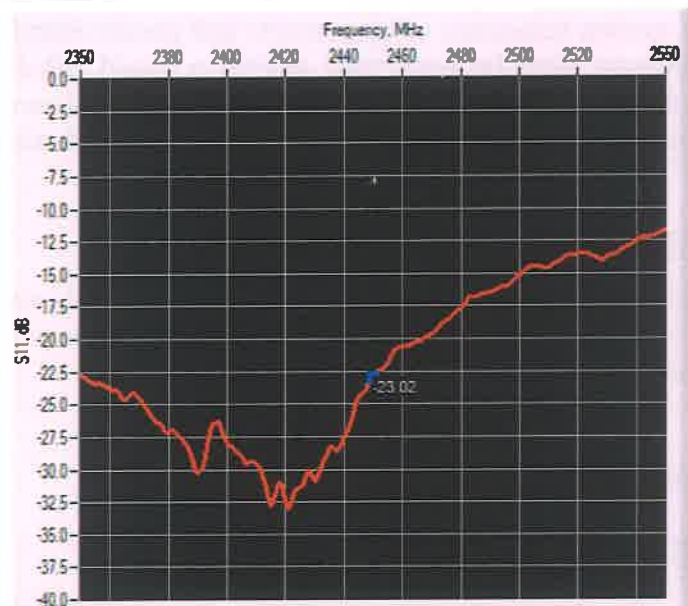

Frequency (MHz)	S11 parameter (dB)	Requirement (dB)	Impedance
2450	-23.02	-20	51.6Ω - 7.0jΩ

6.2.2 S11 parameter in Body Liquid

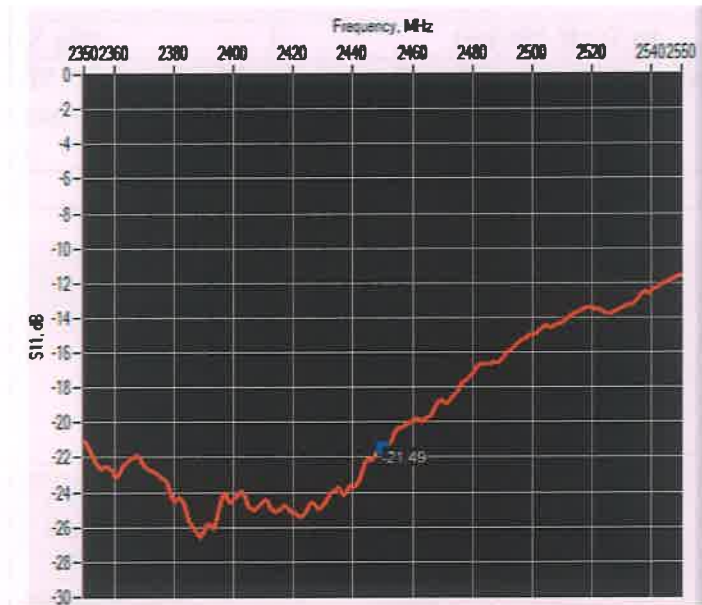

Frequency (MHz)	S11 parameter (dB)	Requirement (dB)	Impedance
2450	-21.49	-20	55.1Ω - 7.3jΩ

6.3 SAR

The IEC/IEEE 62209-1528 and FCC KDB865664 D01 standards state that the system validation measurements must be performed using a reference dipole meeting the fore mentioned return loss and mechanical dimension requirements. The validation measurement must be performed against a liquid filled flat phantom, with the phantom constructed as outlined in the fore mentioned standards. Per the standards, the dipole shall be positioned below the bottom of the phantom, with the dipole length centered and parallel to the longest dimension of the flat phantom, with the top surface of the dipole at the described distance from the bottom surface of the phantom.

6.3.1 SAR with Head Liquid

The IEC/IEEE 62209-1528 and FCC KDB865664 D01 standards state that the system validation measurements should produce the SAR values shown below (for phantom thickness of 2 mm), within the uncertainty for the system validation. All SAR values are normalized to 1 W forward power. In bracket, the measured SAR is given with the used input power.

Software	OPENSAR V5
Phantom	SN 13/09 SAM68
Probe	SN 41/18 EPGO333
Liquid	Head Liquid Values: eps' : 41.4 sigma : 1.83
Distance between dipole center and liquid	10.0 mm
Area scan resolution	dx=8mm/dy=8mm
Zoon Scan Resolution	dx=5mm/dy=5mm/dz=5mm
Frequency	2450 MHz
Input power	20 dBm
Liquid Temperature	20 +/- 1 °C
Lab Temperature	20 +/- 1 °C

Lab Humidity	30-70 %
--------------	---------

Frequency	1g SAR (W/kg)			10g SAR (W/kg)		
	Measured	Measured normalized to 1W	Target normalized to 1W	Measured	Measured normalized to 1W	Target normalized to 1W
2450 MHz	5.34	53.37	52.40	2.46	24.61	24.00

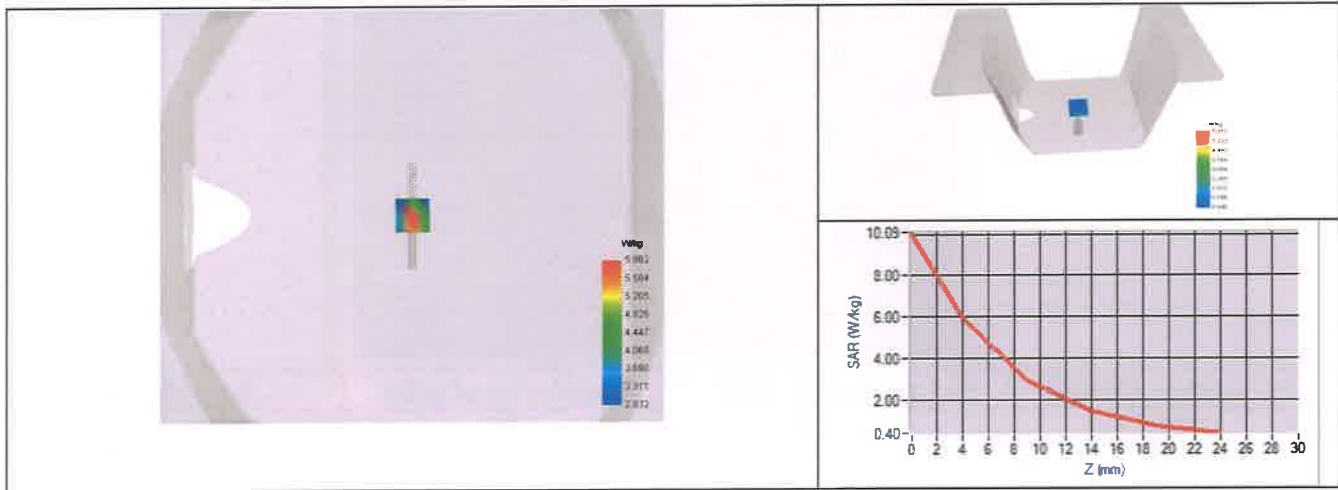

6.3.2 SAR with Body Liquid

Software	OPENSAR V5
Phantom	SN 13/09 SAM68
Probe	SN 41/18 EPGO333
Liquid	Body Liquid Values: eps' : 51.5 sigma : 2.12
Distance between dipole center and liquid	10.0 mm
Area scan resolution	dx=8mm/dy=8mm
Zoon Scan Resolution	dx=5mm/dy=5mm/dz=5mm
Frequency	2450
Input power	20 dBm
Liquid Temperature	20 +/- 1 °C
Lab Temperature	20 +/- 1 °C
Lab Humidity	30-70 %

Frequency	1g SAR (W/kg)			10g SAR (W/kg)		
	Measured	Measured normalized to 1W	Target normalized to 1W	Measured	Measured normalized to 1W	Target normalized to 1W
2450 MHz	5.28	52.78	51.20	2.37	23.75	23.70

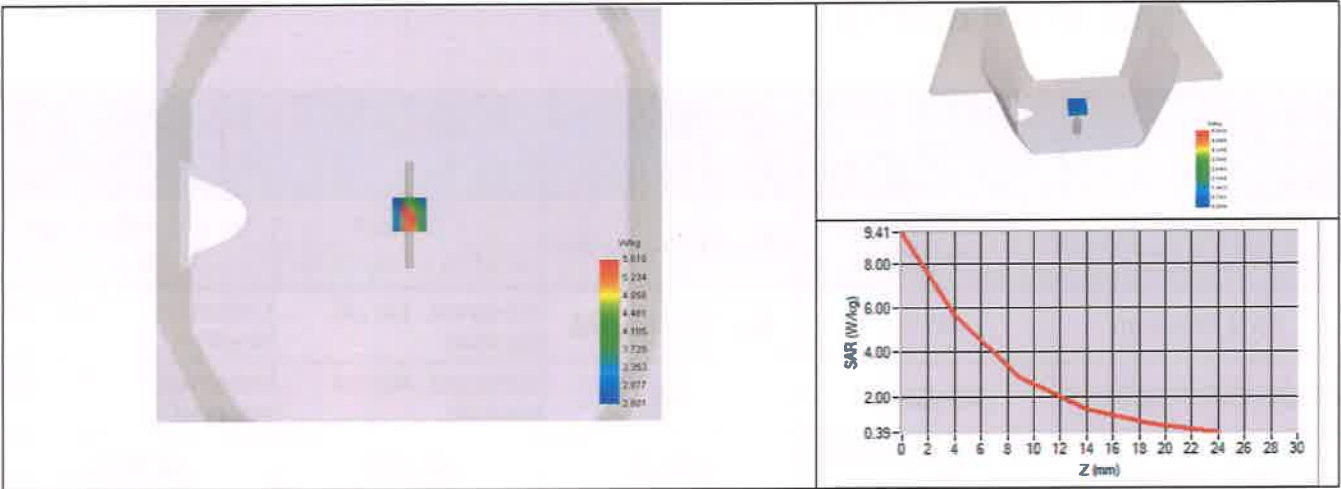



7 LIST OF EQUIPMENT

Equipment Summary Sheet				
Equipment Description	Manufacturer / Model	Identification No.	Current Calibration Date	Next Calibration Date
SAM Phantom	MVG	SN 13/09 SAM68	Validated. No cal required.	Validated. No cal required.
COMOSAR Test Bench	Version 3	NA	Validated. No cal required.	Validated. No cal required.
Network Analyzer	Rohde & Schwarz ZVM	100203	08/2021	08/2024
Network Analyzer	Agilent 8753ES	MY40003210	10/2019	10/2023
Network Analyzer – Calibration kit	Rohde & Schwarz ZV-Z235	101223	07/2022	07/2025
Network Analyzer – Calibration kit	HP 85033D	3423A08186	06/2021	06/2027
Calipers	Mitutoyo	SN 0009732	11/2022	11/2025
Reference Probe	MVG	SN 41/18 EPGO333	09/2022	09/2023
Multimeter	Keithley 2000	1160271	02/2020	02/2023
Signal Generator	Rohde & Schwarz SMB	106589	03/2022	03/2025
Amplifier	MVG	MODU-023-C-0002	Characterized prior to test. No cal required.	Characterized prior to test. No cal required.
Power Meter	NI-USB 5680	170100013	06/2021	06/2024
Power Meter	Keysight U2000A	SN: MY62340002	10/2022	10/2025
Directional Coupler	Krytar 158020	131467	Characterized prior to test. No cal required.	Characterized prior to test. No cal required.
Temperature / Humidity Sensor	Testo 184 H1	44225320	06/2021	06/2024

TEST REPORT

APPENDIX D – SAR SYSTEM VALIDATION

Per KDB 865664, SAR system validation status should be documented to confirm measurement accuracy. SAR measurement systems are validated according to procedures in KDB 865664. The validation status is documented according to the validation date(s), measurement frequencies, SAR probe and tissue dielectric parameters. When multiple SAR system is used, the validation status of each SAR system is needed to be documented separately according to the associated system components.

A tabulated summary of the system validation status including the validation date(s), measurement frequencies, SAR probe and tissue dielectric parameters are shown as below.

Date	Probe S/N	Tested Freq. (MHz)	Tissue Type	Perm	Cond	CW Validation			Mod. Validation		Peak to average power ratio
						Sensitivity	Probe Linearity	Probe Isotropy	Mod. Type	Duty Factor	
20/11/2021	EPGO 402	2450	Head	38.92	1.86	PASS	PASS	PASS	FHSS	PASS	PASS
20/11/2021	EPGO 402	2450	Body	51.64	1.99	PASS	PASS	PASS	FHSS	PASS	PASS
20/11/2021	EPGO 402	2450	Head	38.92	1.86	PASS	PASS	PASS	OFDM	N/A	PASS
20/11/2021	EPGO 402	2450	Body	51.64	1.99	PASS	PASS	PASS	OFDM	N/A	PASS
20/11/2021	EPGO 402	2450	Head	38.92	1.86	PASS	PASS	PASS	DSSS	PASS	N/A
20/11/2021	EPGO 402	2450	Body	51.64	1.99	PASS	PASS	PASS	DSSS	PASS	N/A