

Go to www.vtechphones.com to register your product for enhanced warranty support and the latest VTech product news.



DM1111 DM1111-2 Enhanced Range Digital Audio Monitor

For more support information



vtech®

User's manual

CONGRATULATIONS

on purchasing your new VTech product. Before using this product, please read **Important safety instructions**.

This manual has all the feature operations and troubleshooting necessary to install and operate your new VTech product. Please review this manual thoroughly to ensure proper installation and operation of this innovative and feature-rich VTech product.

For support, shopping, and everything new at VTech, visit our website at www.vtechphones.com.

WHAT'S IN THE BOX

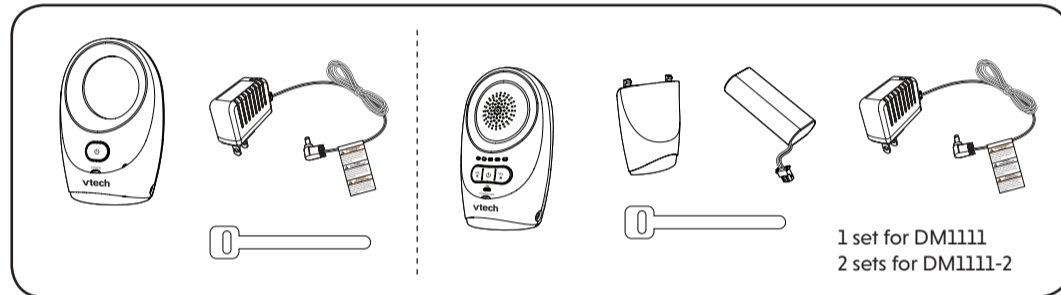

IMPORTANT SAFETY INSTRUCTIONS

The applied nameplate is located at the bottom of the baby unit's base.

When using your equipment, basic safety precautions should always be followed to reduce the risk of fire, electric shock and injury, including the following:

- Follow all warnings and instructions marked on the product.
- Adult setup is required.
- CAUTION:** Do not install the baby unit at a height above 2 meters.
- This product is not a substitute for adult supervision of the infant. Supervising the infant is the parent's or caregiver's responsibility. This product could cease operating, and therefore you should not assume it will continue working properly for any given period of time. Further, this is not a medical device and should not be used as such. This product is intended to assist you in supervising your baby.
- Do not use this product near water. For example, do not use it next to a bath tub, wash bowl, kitchen sink, laundry tub or swimming pool, or in a wet basement or shower.
- CAUTION:** Use only the battery provided. There may be a risk of explosion if a wrong type of battery is used for the parent unit. The battery cannot be subjected to high or low extreme temperature and low air pressure at high altitude during use, storage or transportation. Disposal of battery into fire or a hot oven, or mechanically crushing or cutting or the battery can result in an explosion. Leaving the battery in an extremely high temperature surrounding environment can result in an explosion or the leakage of flammable liquid of gas. Battery subjected to extremely low air pressure may result in an explosion or the leakage of flammable liquid or gas. Dispose of used battery according to the information in **The RBRC seal**.
- Use only the adapters included with this product. Incorrect adapter polarity or voltage can seriously damage the product.

Power adapter information:
Output: 6V DC 400mA
VTECH TELECOMMUNICATIONS LTD.
Model: VT05UUS06040

Rechargeable battery information:
2xAAA 2.4V 750mAh
YIYANG CORUN BATTERY CO LTD.
Model: NI-MH AAA750*2

- The power adapters are intended to be correctly oriented in a vertical or floor mount position. The prongs are not designed to hold the plug in place if it is plugged into a ceiling, under-the-table or cabinet outlet.
- For pluggable equipment, the socket-outlet shall be installed near the equipment and shall be easily accessible.
- Unplug this product from the wall outlet before cleaning. Do not use liquid or aerosol cleaners. Use a damp cloth for cleaning.
- Unplug the power cords before replacing battery.
- Do not cut off the power adapters to replace them with other plugs, as this causes a hazardous situation.
- Do not allow anything to rest on the power cords. Do not install this product where the cords may be walked on or crimped.
- This product should be operated only from the type of power source indicated on the marking label. If you are not sure of the type of power supply in your home, consult your dealer or local power company.
- Do not overload wall outlets or use an extension cord.
- Do not place this product on an unstable table, shelf, stand or other unstable surfaces.
- This product should not be placed in any area where proper ventilation is not provided. Slots and openings in the back or bottom of this product are provided for ventilation. To protect them from overheating, these openings must not be blocked by placing the product on a soft surface such as a bed, sofa or rug. This product should never be placed near or over a radiator or heat

- Never push objects of any kind into this product through the slots because they may touch dangerous voltage points or create a short circuit. Never spill liquid of any kind on the product.
- To reduce the risk of electric shock, do not disassemble this product, but take it to an authorized service facility. Opening or removing parts of the product other than specified access doors may expose you to dangerous voltages or other risks. Incorrect reassembling can cause electric shock when the product is subsequently used.
- You should test the sound reception every time you turn on the units or move one of the components.
- Periodically examine all components for damage.
- There is a very low risk of privacy loss when using certain electronic devices, such as baby monitors, cordless telephones, etc. To protect your privacy, make sure the product has never been used before purchase, reset the baby monitor periodically by powering off and then powering on the units, and power off the baby monitor if you will not use it for some time.
- Children should be supervised to ensure that they do not play with the product.
- The product is not intended for use by persons (including children) with reduced physical, sensory or mental capabilities, or lack of experience and knowledge, unless they have been given supervision or instruction concerning use of the appliance by a person responsible for their safety.

SAVE THESE INSTRUCTIONS

Cautions

- Use and store the product at a temperature between 32°F and 104°F.
- Do not expose the product to extreme cold, heat or direct sunlight. Do not put the product close to a heating source.
- Batteries should not be exposed to excessive heat such as bright sunshine or fire.
- Warning—Strangulation Hazard—** Children have STRANGLED in cords. Keep this cord out of the reach of children (more than 3 ft (0.9m) away). Do not remove this tag.
- Never place the baby unit(s) inside the baby's crib or playpen. Never cover the baby unit(s) or parent unit with anything such as a towel or a blanket.
- Other electronic products may cause interference with your baby monitor. Try installing your baby monitor as far away from these electronic devices as possible: wireless routers, radios, cellular telephones, intercoms, room monitors, televisions, personal computers, kitchen appliances and cordless telephones.

Precautions for users of implanted cardiac pacemakers
Cardiac pacemakers (applies only to turned cordless devices):
Wireless Technology Research, LLC (WTR), an independent research entity, led a multidisciplinary evaluation of the interference between portable wireless devices and implanted cardiac pacemakers. Supported by the U.S. Food and Drug Administration, WTR recommends to physicians that:

- Pacemaker patients**
- Should keep wireless devices at least six inches from the pacemaker.
- Should NOT place wireless devices directly over the pacemaker, such as in a breast pocket, when it is turned ON.

WTR's evaluation did not identify any risk to bystanders with pacemakers from other persons using wireless devices.
Electromagnetic fields (EMF)
This VTech product complies with all standards regarding electromagnetic fields (EMF). If handled properly and according to the instructions in this user's manual, the product is safe to be used based on scientific evidence available today.

1 CONNECT THE BABY MONITOR

Install the parent unit battery

The parent unit runs on rechargeable battery or AC power. To continuously monitor your baby, make sure you use both battery and AC power at the same time. With the battery alone, the parent unit can cordlessly run for a short time only.

NOTES

- Use only the battery supplied with this product.
- If the parent unit will not be used for a long time, disconnect and remove the battery to prevent possible leakage.

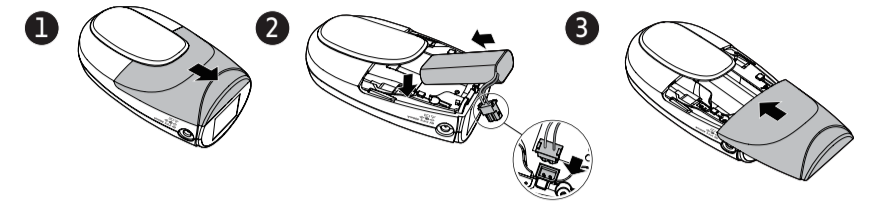

Replace the battery

To replace the battery, press down on the battery compartment cover and pull it out, then follow the steps above to install the battery.

Connect the baby monitor

NOTES

- Use only the power adapters supplied with this product.
- Make sure the baby monitor is not connected to a switch controlled electric outlet.
- Connect the power adapters in a vertical or floor mount position only. The adapters' prongs are not designed to hold the weight of baby monitor, so do not connect them to any ceiling, under-the-table, or cabinet outlets. Otherwise, the adapters may not properly connect to the outlets.
- Make sure the parent unit, the baby unit and the power adapter cords are out of reach of children.
- Make sure the **POWER** light is on after the power plug is fully inserted into the power jack of the baby unit.
- With audio reminder feature preset to on, the parent unit plays an audio reminder when it is connected to a baby unit.

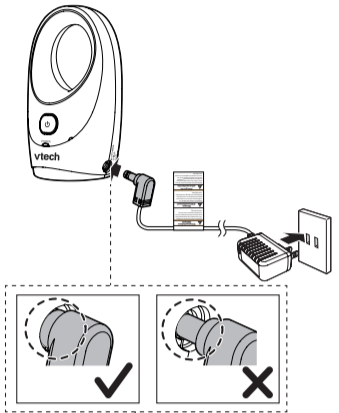

Charge the parent unit battery

When you have connected and turned on the baby unit and all the parent units, they will enter pairing mode automatically. It takes around 10 minutes for the pairing process to complete. When the parent unit and baby unit are successfully paired, both their power LEDs are on steadily. The baby monitor is ready to use.

NOTES

- Before using the baby monitor for the first time, charge the parent unit battery for 12 hours.
- It takes longer to charge the battery when the parent unit is turned on. To shorten the charging time, turn the parent unit off while charging.
- The standby time varies depending on the sensitivity level you set, your actual use and the age of the battery.
- The parent unit beeps twice every 10 minutes and the **POWER** light flashes in red when the battery is low. Charge the parent unit battery without interruption for at least 30 minutes.
- To keep the battery charged, connect it to AC power when not in use.

2 BEFORE USE

NOTE

- This baby monitor is intended as an aid. It is not a substitute for proper adult supervision, and should not be used as such.

Test your baby monitor

You may test the baby monitor before initial use, and at regular times thereafter.

CAUTION

- For hearing protection, make sure the parent unit is more than 6.5 feet (2 meters) away from the baby unit. If you hear any high-pitched noise, move the parent unit further until the noise stops. You can also press **▼** on the parent unit to lower or mute the noise.

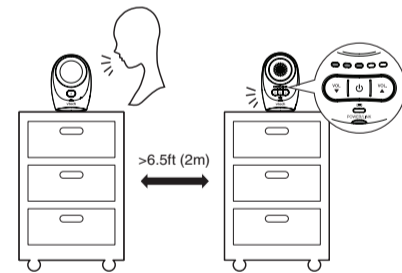

- Make sure your baby unit and parent unit are on.
- Speak towards the microphone of the baby unit. You will hear the sound at the parent unit, and see the visual sound indicators light up.

NOTE

- When the **POWER/LINK** LED light flashes, move the parent unit closer to the baby unit (observe the minimum distance of 6.5 feet / 2 meters). You can also check if the baby monitor is connected to a live power socket and switched on.

TIP

- Increase the speaker volume of the parent unit if you cannot hear the sounds transmitted from the baby units.

Positioning the baby monitor

CAUTION

- Keep the baby unit out of the reach of your baby. Never place or mount the baby unit inside the baby's crib or playpen.

NOTE

- To avoid interference from other electronic devices, place your baby monitor far away from devices such as wireless routers, microwaves, cell phones and computers.

- Place the baby units more than 3 feet (1 meter) away from your baby.
- Place the parent unit more than 6.5 feet (2 meters) away from the baby unit to avoid screeching noise.

CAUTION

- The default volume of your parent unit is **Level 3**, and the maximum volume is **level 5**. If you experience high-pitched screeching noise from your baby monitor while positioning:
 - Make sure your baby units and parent unit are more than 6.5 feet (2 meter) apart, OR
 - Turn down the volume of your parent unit.

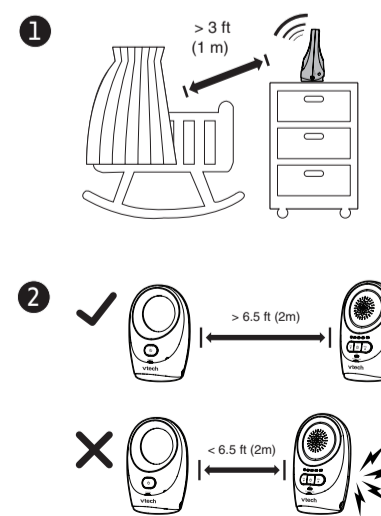

Operating range

The operating range of the baby monitor is up to 1,500 feet (450 meters) outdoors or 160 feet (50 meters) indoors. The actual operating range may vary depending on the environmental conditions and other interferences such as walls, doors and other obstructions.

3 USING THE BABY MONITOR

Power on or off the baby unit

- Press **⏻** until the **POWER** light turns on.
- Press **⏻** until the **POWER** light turns off.

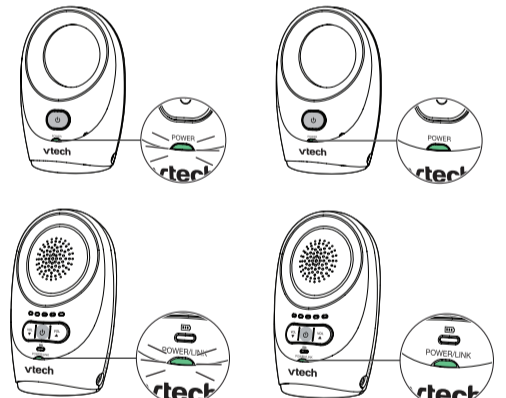

Power on or off the parent unit

- Press **⏻** until the **POWER / LINK** light turns on.
- Press **⏻** until the **POWER / LINK** light turns off.

Adjust parent unit speaker volume

The speaker volume is preset to **Level 3** on the parent unit. You can adjust to your preferred sound level.

- Press **▼** to decrease the volume, and **▲** to increase the volume.

NOTE

- If you continue to press **▼** or **▲** when the volume reaches the minimum or maximum setting, the parent unit will beep twice.

To mute the speaker volume

- Press **▼** repeatedly until the volume reaches the minimum.

NOTES

- When the parent unit is in mute, the visual sound indicator will still indicate the sound detected from the baby unit.
- To unmute, press **▲** repeatedly until it reaches your desired volume.

Turn on or off the audio reminder

With audio reminder feature preset to on, the parent unit plays an audio reminder when it is connected to a baby unit. It reminds you to place the baby unit at least 3 feet (1 meter) away from your baby, and keep the cords out of the reach of children.

- Press and hold **▼** for 8 seconds when the parent unit is not in use. The visual sound indicators flashes for 3 times. The audio reminder is disabled.
- Press and hold **▲** for 8 seconds when the parent unit is not in use. The visual sound indicators flashes for 3 times. The audio reminder is enabled.

NOTES

- You can press **▼** or **▲** to adjust or mute the volume when the parent unit is playing the reminder.
- If the speaker volume of the parent unit is turned off, it will resume to the default volume level when the parent unit plays the reminder.

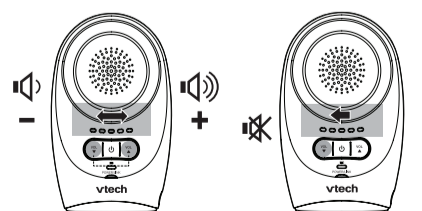

Specifications are subject to change without notice.
© 2022 VTech Communications, Inc.
All rights reserved. 07/22, DM1111-X-CB_V7



DISCLAIMER AND LIMITATION OF LIABILITY
VTech Communications, Inc. and its suppliers assume no responsibility for any damage or loss resulting from the use of this user's manual. VTech Communications, Inc. and its suppliers assume no responsibility for any loss or claims by third parties that may arise through the use of this product.
Company: VTech Communications, Inc.
Address: 9020 SW Washington Square Road - Ste 555 Tigard, OR 97223, United States
Phone: 1 (800) 595-9511 in the U.S. or 1 (800) 267-7377 in Canada

Frequency control	Crystal controlled PLL synthesizer
Transmit frequency <td>Baby unit: 902.7 MHz - 927.1 MHz Parent unit: 902.7 MHz - 927.1 MHz</td>	Baby unit: 902.7 MHz - 927.1 MHz Parent unit: 902.7 MHz - 927.1 MHz
Channels <td>62</td>	62
Nominal effective range <td>Maximum power allowed by FCC and IC. Actual operating range may vary according to environmental conditions at the time of use.</td>	Maximum power allowed by FCC and IC. Actual operating range may vary according to environmental conditions at the time of use.
Power requirements <td>Baby unit adapter: Input: 100-120V AC 60Hz; Output: 6V DC @ 400mA Parent unit adapter: Input: 100-120V AC 60Hz; Output: 6V DC @ 400mA</td>	Baby unit adapter: Input: 100-120V AC 60Hz; Output: 6V DC @ 400mA Parent unit adapter: Input: 100-120V AC 60Hz; Output: 6V DC @ 400mA
Parent unit battery <td>2.4V NIMH battery</td>	2.4V NIMH battery

TECHNICAL SPECIFICATIONS

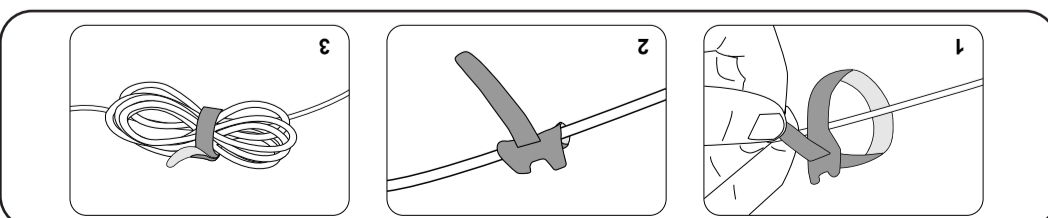

CABLE MANAGEMENT



