



# AT&T

## Quick start guide

DL72210/DL72310/DL72340/  
DL72350

DECT 6.0 cordless telephone/  
answering system with  
BLUETOOTH® wireless technology

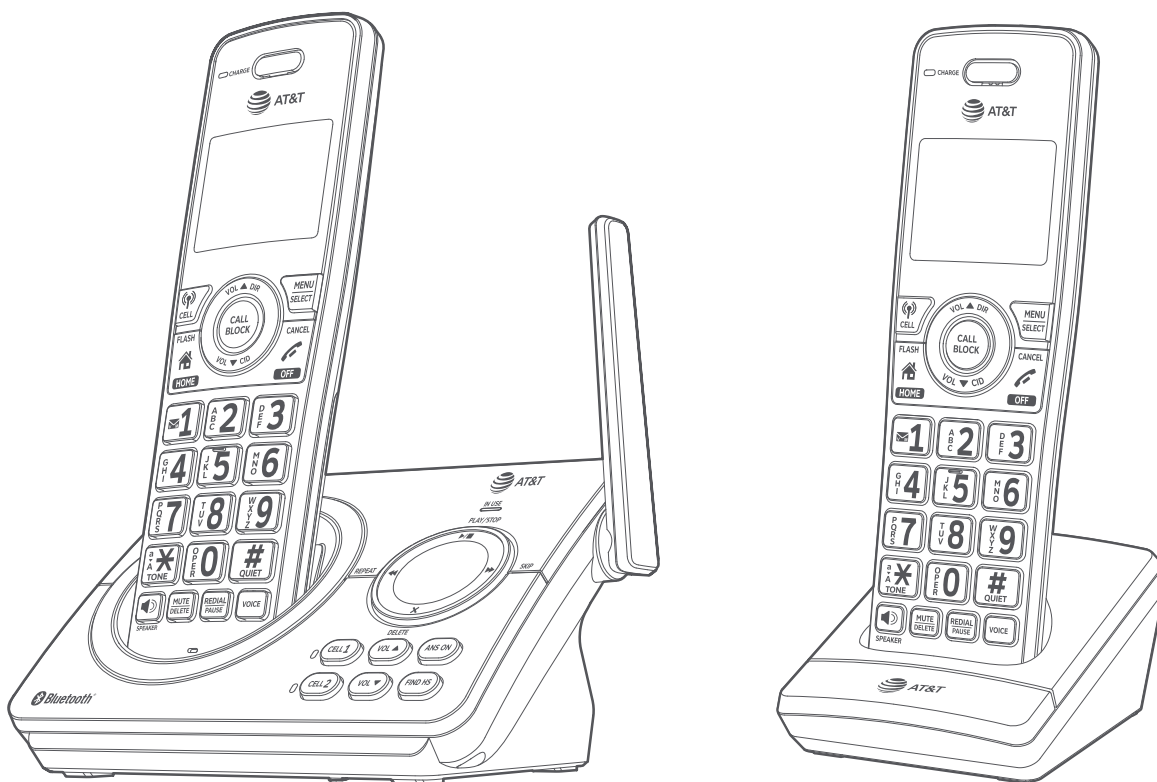

This Quick start guide provides you with basic installation and major operation instructions. A limited set of features are described in abbreviated form.

Before using this AT&T product, please read the Important safety information section on pages 98-100 of this manual. Please refer to the online **DL72210/DL72310/DL72340/DL72350 DECT 6.0 cordless telephone/answering system with BLUETOOTH® wireless technology** Complete user's manual for a full set of installation and operation instructions at **<https://telephones.att.com/manuals>**.

This telephone system is compatible with certain AT&T DECT 6.0 cordless headsets and speakerphones. Visit **<https://telephones.att.com/accessories>** for a list of compatible cordless headsets and speakerphones.

For customer service, visit our website at **<https://telephones.att.com>** or call **1 (800) 222-3111**. In Canada, dial **1 (866) 288-4268**.

Model number: DL72210 (two handsets)  
DL72310/DL72340/DL72350 (three handsets)

Type: DECT 6.0 cordless telephone/answering system with  
BLUETOOTH® wireless technology

Serial number: \_\_\_\_\_

Purchase date: \_\_\_\_\_

Place of purchase: \_\_\_\_\_

Both the model and serial numbers of your AT&T product can be found on the bottom of the telephone base.

Save your sales receipt and original packaging in case it is necessary to return your telephone for warranty service.



Telephones identified with this logo have reduced noise and interference when used with most T-coil equipped hearing aids and cochlear implants. The TIA-1083 Compliant Logo is a trademark of the Telecommunications Industry Association. Used under license.



The ENERGY STAR® program ([www.energystar.gov](http://www.energystar.gov)) recognizes and encourages the use of products that save energy and help protect our environment. We are proud to mark this product with the ENERGY STAR® label indicating it meets the latest energy efficiency guidelines.

The *Bluetooth*® word mark and logos are owned by Bluetooth SIG, Inc. and any use of such marks by Advanced American Telephones and its parent, VTech Holdings Limited, is under license. VTech Holdings Limited is a member of Bluetooth SIG, Inc. Other trademarks and trade names are those of their respective owners.

© 2020 Advanced American Telephones. All Rights Reserved. AT&T and the AT&T logo are trademarks of AT&T Intellectual Property licensed to Advanced American Telephones, San Antonio, TX 78219. Printed in China.

# Parts checklist

Your telephone package contains the following items. Save your sales receipt and original packaging in the event warranty service is necessary.

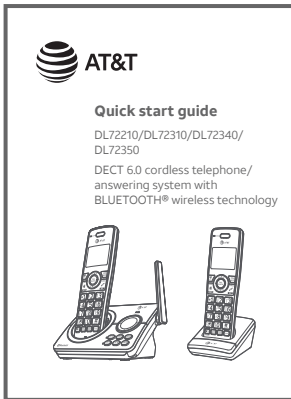

Quick start guide



Smart call blocker leaflet

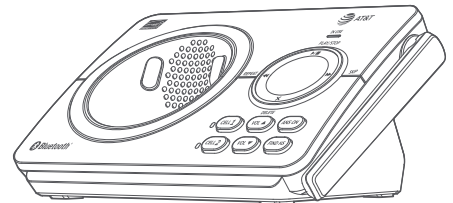

Telephone base



Cordless handset  
(2 for DL72210)  
(3 for DL72310/  
DL72340/DL72350)



Charger for cordless  
handset with power adapter  
installed  
(1 for DL72210)  
(2 for DL72310/DL72340/  
DL72350)



Battery for cordless  
handset  
(2 for DL72210)  
(3 for DL72310/  
DL72340/DL72350)



Battery compartment  
cover  
(2 for DL72210)  
(3 for DL72310/DL72340/  
DL72350)

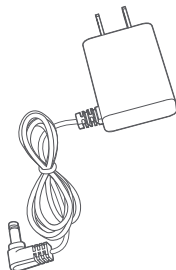

Power adapter for  
telephone base

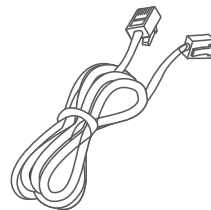

Telephone line cord

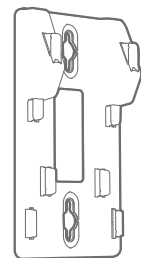

Wall-mount bracket

# Quick start guide

DL72210/DL72310/DL72340/  
DL72350

DECT 6.0 cordless telephone/  
answering system with  
BLUETOOTH® wireless technology

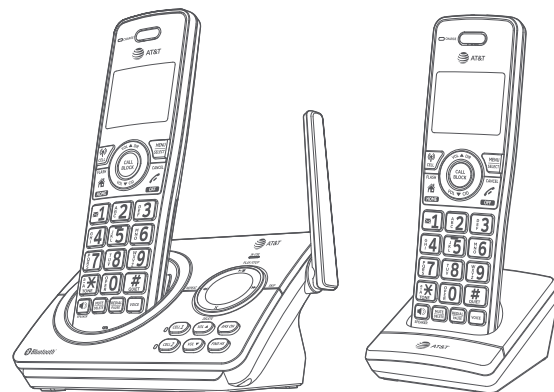

For more detailed instructions, refer to the online Complete user's manual at <https://telephones.att.com/manuals>.

## Table of contents

### Getting started

Quick reference guide - telephone base .....	1
Quick reference guide - handset.....	3
Telephone base and charger installation .....	6
Telephone base installation.....	6
Charger installation.....	7
Battery installation and charging .....	8
Installation options .....	11
Tabletop to wall-mount installation .....	11
Wall-mount to tabletop installation .....	12

### Bluetooth

Introducing Bluetooth .....	13
Connect to Cell™ application .....	15
Bluetooth setup .....	16
Add a cell phone .....	16
Add a headset .....	17
Download directory.....	18
Remote voice control.....	19
Activate remote voice control.....	20

### Telephone settings

Telephone settings .....	22
Ringer volume .....	22
Ringer tone.....	23
LCD language.....	23
Set date and time .....	24
Set speed dial voicemail number.....	24
Voicemail (visual message waiting) indicator .....	25
Clear voicemail indicator/indication.....	25
Key tone .....	25
Home area code .....	26
Dial mode .....	26
QUIET mode.....	27

### Telephone operation

Telephone operation .....	28
Make, answer or end a home call.....	28
Make, answer or end a cell call.....	28
Silencing the ringer .....	29
Call waiting on the home line .....	29
Call waiting on the cell line .....	30

Answer an incoming cell call while on a home call.....	30
Answer an incoming home call while on a cell call.....	30
Options while on calls .....	31
Handset speakerphone .....	31
Volume control .....	31
Mute .....	31
Temporary tone dialing .....	32
Chain dialing .....	32
Redial .....	33
Handset locator.....	33

## Multiple handset use

Join a call in progress .....	34
Intercom.....	35
Call transfer using intercom .....	36

## Directory

Directory .....	37
Create a new entry in the directory.....	37
Review the directory.....	38
Search by name .....	38
Dial a directory entry.....	38
Edit a directory entry .....	39
Delete a directory entry .....	39
Delete all directory entry.....	39

## Caller ID

Caller ID.....	40
Missed (new) call indicator .....	40
Review the caller ID log.....	40
View dialing options.....	40
Dial a caller ID log entry .....	41
Save a caller ID log entry to the directory.....	41
Save a caller ID log entry to the allow list.....	42
Save a caller ID log entry to the block list .....	43

Save a caller ID log entry to the star name list .....	43
Delete caller ID log entries .....	44

## Smart call blocker

About Smart call blocker* .....	45
Call categories .....	46
Call handling .....	47
Call block settings.....	49
Set Smart call blocker on/off .....	49
Set profile.....	49
Block list .....	50
Allow list .....	55
Star name list.....	59
Screening announcements.....	62
Voice guide to set Smart call blocker.....	65
Allowed calls .....	66
Blocked calls .....	66
Screen unknown home calls.....	67
Screened call options.....	68
Screen robocalls .....	70
Option while on a call .....	71

## Answering system

Answering system settings.....	72
Announcement.....	72
Answer on/off .....	73
Voice guide to set Answering system.....	74
Call screening.....	74
Number of rings.....	75
Remote access code.....	75
Message alert tone.....	76
About the answering system.....	77
Answering system and voicemail.....	77
Using the answering system and voicemail together.....	77
Message capacity .....	78
Voice prompts.....	78

Call screening.....	78
Call intercept.....	79
Temporarily turning off the message alert tone.....	79
Message playback.....	80
Options during playback.....	80
Delete all old messages.....	81
Recording and playing memos .....	82
Record a memo.....	82
Playback a memo.....	82
Remote access.....	83
To remotely access the answering system.....	83

## Appendix

Add and register handsets/ headsets/speakerphones .....	84
Register a handset to your telephone base.....	84
Deregister handsets.....	86
Deregister all handsets from the telephone base.....	86
Troubleshooting.....	87
Maintenance .....	97
Important safety information .....	98
Safety information.....	98
Especially about cordless telephones.....	99
Precautions for users of implanted cardiac pacemakers .....	100
ECO mode .....	100
Especially about telephone answering systems .....	100
For C-UL compliance.....	101
Mesures de sécurité importantes.....	101
FCC Part 68 and ACTA.....	104
FCC Part 15.....	106
Limited warranty .....	107

Technical specifications.....	109
DECT 6.0 digital technology.....	109
Telephone operating range .....	109
Redefining long range coverage and clarity.....	109
Simulated full-duplex handset and base speakerphones .....	109

## Index

Index.....	110
------------	-----

# Quick reference guide - telephone base

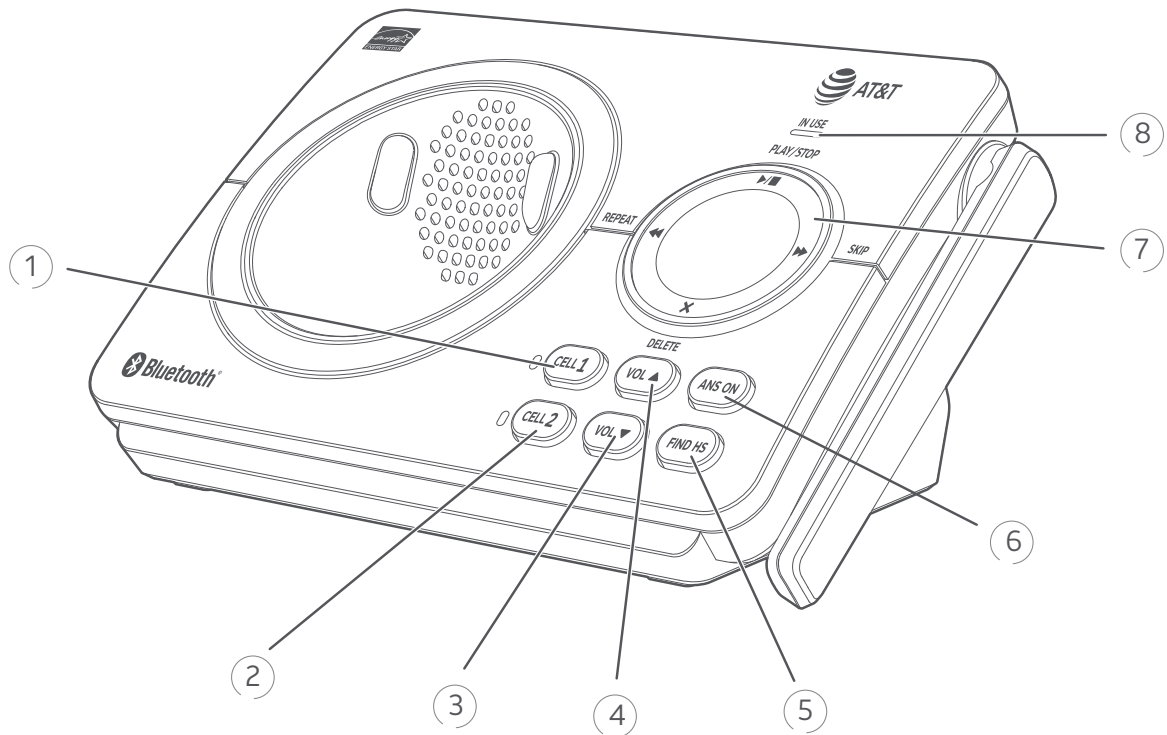

## ① CELL 1

- ▶ Light on when the telephone base is paired and connected with a Bluetooth device.
- ▶ Light flashes when the telephone base is in discoverable mode.
- ▶ Press to connect the paired cell Bluetooth device (page 16).
- ▶ Press and hold to add or replace a Bluetooth device.

## ② CELL 2

- ▶ Light on when the telephone base is paired and connected with a Bluetooth device.
- ▶ Light flashes when the telephone base is in discoverable mode.
- ▶ Press to connect the paired cell Bluetooth device (page 17).
- ▶ Press and hold to add or replace a Bluetooth device.

## ③ VOL ▼

- ▶ When the telephone is idle, press to decrease the telephone base ringer volume.
- ▶ During call screening or message playback, press to decrease the listening volume (page 80).

## ④ VOL ▲

- ▶ When the telephone is idle, press to increase the telephone base ringer volume.
- ▶ During call screening or message playback, press to increase the listening volume (page 80).

## ⑤ FIND HS

- ▶ Press to page all handsets (page 33).

## ⑥ ANS ON

- ▶ Press to turn the built-in answering system on or off (page 73).

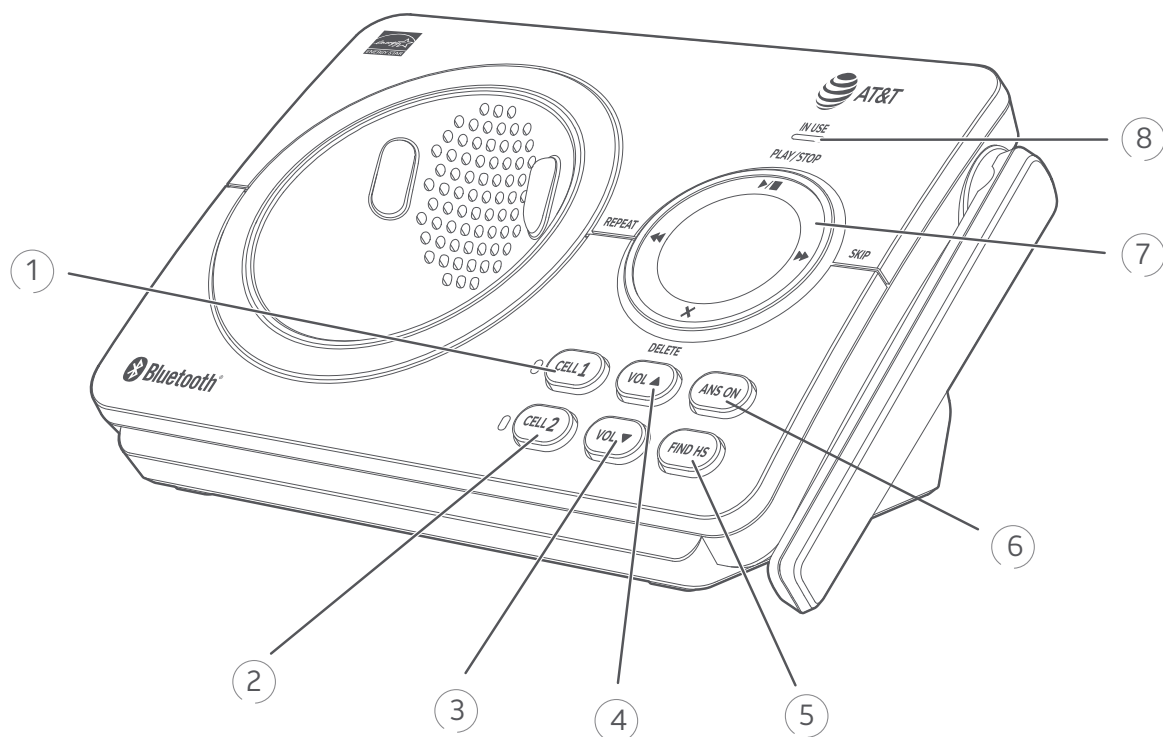

## 7 ◀◀ REPEAT

- ▶ Press to repeat a message (page 80).
- ▶ Press twice to play the previous message.

## X/DELETE

- ▶ Press to delete the message currently playing (page 80).
- ▶ Press twice to delete all old messages when the telephone is not in use.

## ▶▶ SKIP

- ▶ Press to skip a message (page 80).

## ▶/■ PLAY/STOP

- ▶ Press to start or stop message playback (page 80).
- ▶ During call screening, press to temporarily turn the call screening on or off (page 78).

## 8 IN USE light

- ▶ On when the handset is in use, or when the answering system is answering an incoming call.
- ▶ Flashes when there is an incoming call, or another telephone sharing the same line is in use.



# Quick reference guide - handset

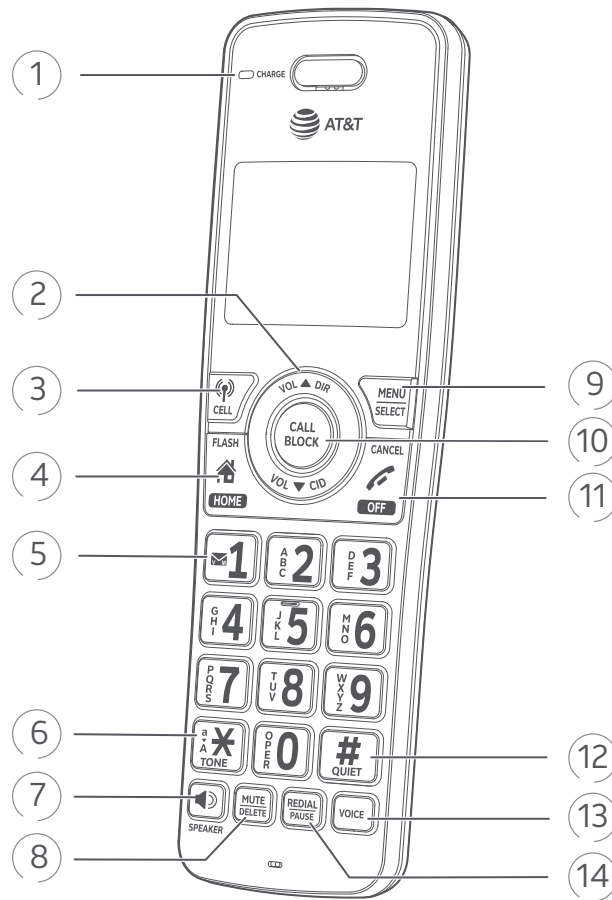

## ① CHARGE light

- ▶ On when the handset is charging in the telephone base or charger.

## ② VOL ▲ DIR

- ▶ Press to show directory entries when the telephone is not in use (page 38).
- ▶ Press to scroll up while in a menu.
- ▶ Press to increase the listening volume when on a call, or increase the message playback volume.
- ▶ While entering names or numbers, press to move the cursor to the right.

## VOL ▼ CID

- ▶ Press to review the caller ID log when the telephone is not in use (page 40).
- ▶ Press to scroll down while in a menu.

- ▶ Press to decrease the listening volume when on a call, or decrease the message playback volume.
- ▶ While entering names or numbers, press to move the cursor to the left.

## ③ CELL

- ▶ Press to make or answer a cell call (page 28).
- ▶ During a call, press to answer an incoming cell call when you hear a call waiting alert (page 30).

## ④ HOME/FLASH

- ▶ Press to make or answer a home call (page 28).
- ▶ During a call, press to answer an incoming home call when you receive a call waiting alert (page 29).

# Quick reference guide - handset

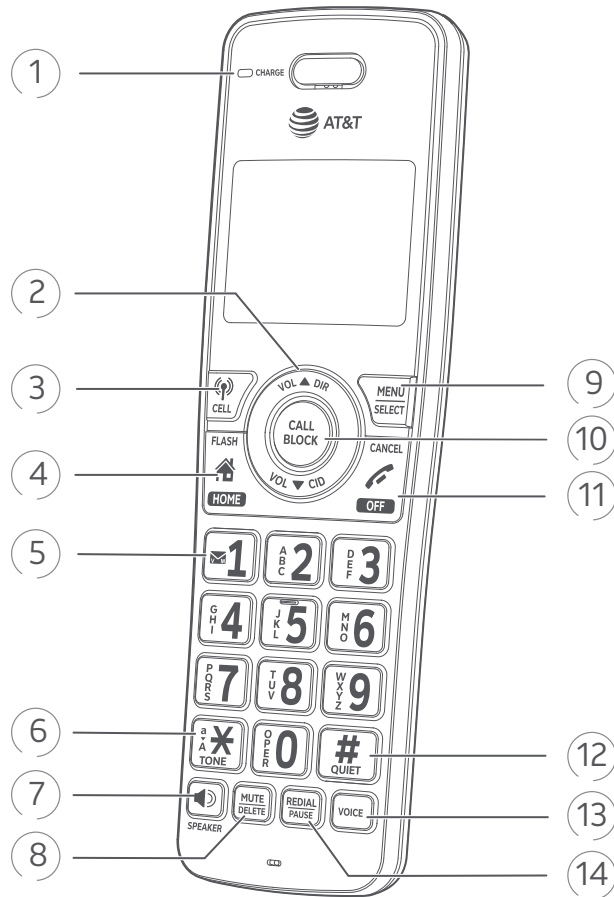

## 5 1

- ▶ While reviewing a caller ID log entry, press repeatedly to add or remove 1 in front of the telephone number before dialing or saving it in the directory (page 40).
- ▶ Press and hold to set or dial your voicemail number (page 24).

## 6 ~~TONE~~/a>A

- ▶ Press to switch to tone dialing temporarily during a call if you have pulse service (page 32).
- ▶ While entering names, press to change the next letter to upper or lower case (page 37).

## 7 /SPEAKER

- ▶ Press to make or answer a call using the speakerphone (page 28).
- ▶ Press to turn on the handset speakerphone, press again to resume normal handset use (page 31).

## 8 **MUTE/DELETE**

- ▶ During a call, press to mute the microphone (page 31).
- ▶ When the handset is ringing, press to mute the ringer temporarily (page 29).
- ▶ While reviewing the redial list, directory, caller ID log, allow list, block list, or the star name list, press to delete an individual entry.
- ▶ While predialing, press to delete digits.
- ▶ When entering names or numbers, press to delete a digit or character.
- ▶ When entering names or numbers, press and hold to erase all digits or characters.
- ▶ During message or announcement playback, press to delete the playing message or the recorded announcement (page 80).

# Quick reference guide - handset

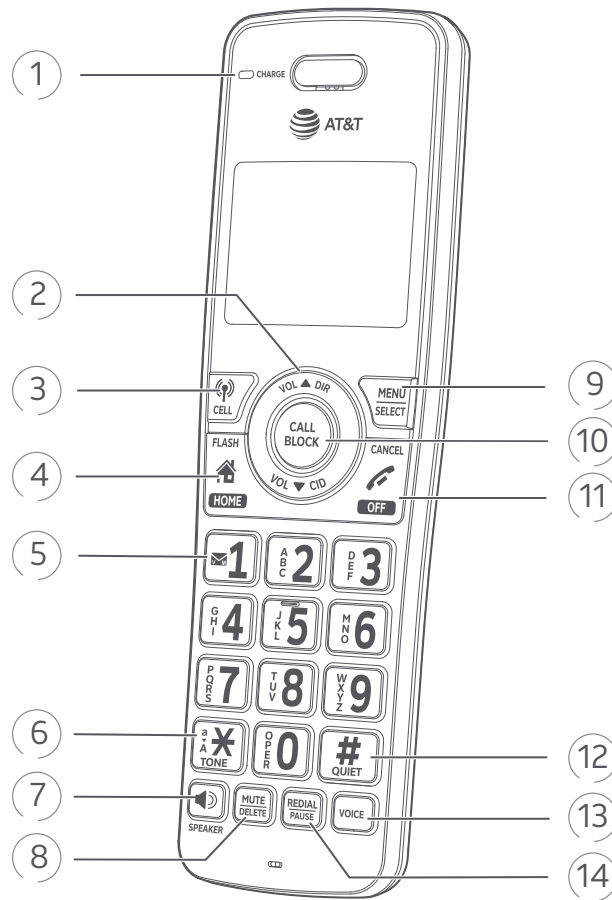

## 9 MENU/SELECT

- ▶ Press to display the menu.
- ▶ Once in the menu, press to select an item or save an entry or setting.

## 10 CALL BLOCK

- ▶ When the telephone is ringing, press to block the incoming home call or cell call (page 45).
- ▶ When on a home call or cell call, press to block the call (page 71).

## 11 OFF/CANCEL

- ▶ During a call, press to hang up (page 28).
- ▶ While in a menu, press to cancel an operation, back up to the previous menu, or exit the menu display; or press and hold this button to exit to idle mode.
- ▶ When the handset is ringing, press to mute the ringer temporarily (page 29).

- ▶ Press and hold while the handset is not in use to erase the missed call indicator (page 40).

## 12 QUIET #

- ▶ Press and hold to set and turn on the **QUIET** mode, or turn it off (page 27).
- ▶ When reviewing a caller ID log entry, press repeatedly to view other dialing options (page 40).

## 13 VOICE

- ▶ While connected to one or two cell phones, press to activate the voice-controlled application of one of the connected cell phones (page 19).

## 14 REDIAL/PAUSE

- ▶ Press repeatedly to view the last 10 numbers dialed (page 33).
- ▶ While entering numbers, press and hold to insert a dialing pause (page 37).

# Telephone base and charger installation

Install the telephone base and charger, as shown below.

The telephone base is ready for tabletop use. If you want to change to wall-mounting, see **Installation options** on page 11 for details.

## Telephone base installation

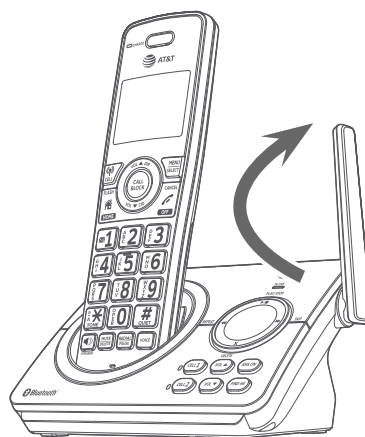
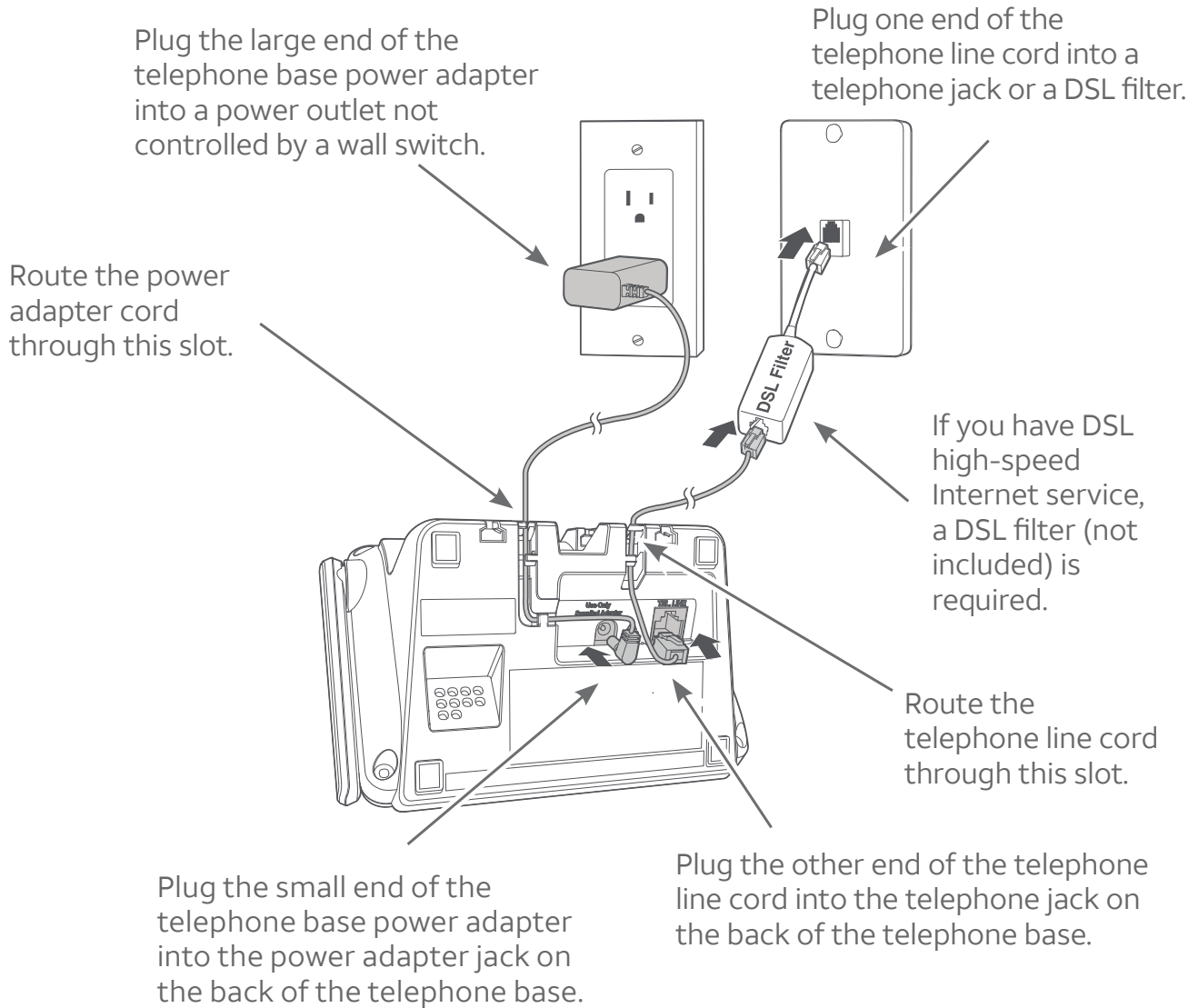

Raise the antenna.

# Telephone base and charger installation

## Charger installation

---

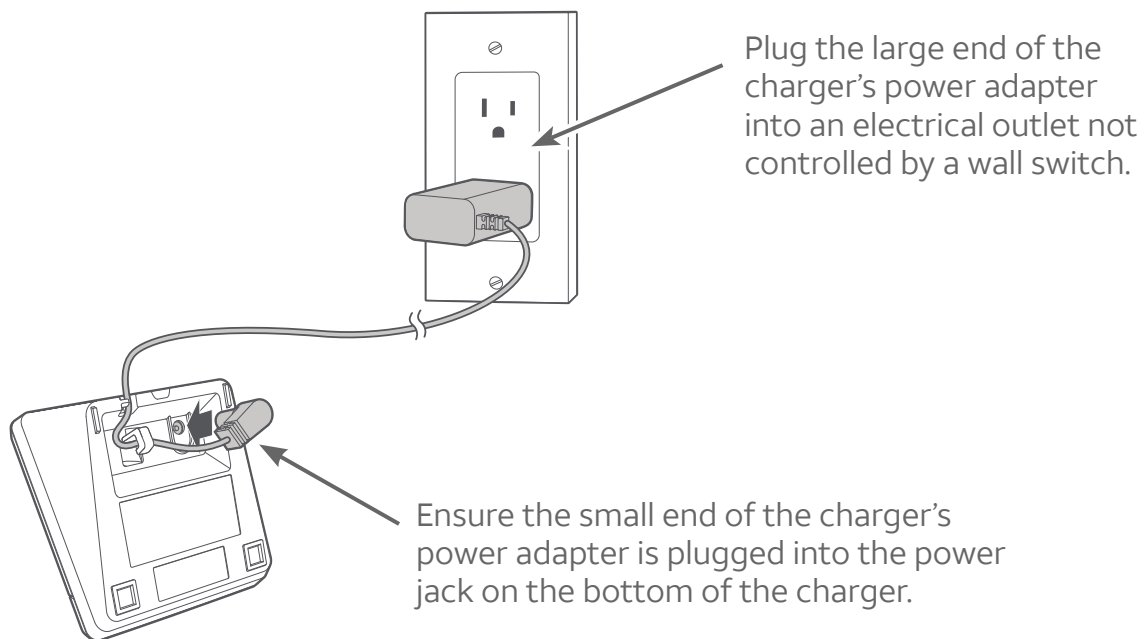



### IMPORTANT INFORMATION

- ▶ Use only the power adapter(s) provided with this product. To obtain a replacement, visit our website at <https://telephones.att.com> or call **1 (800) 222-3111**. In Canada, dial **1 (866) 288-4268**.
- ▶ The power adapters are intended to be correctly oriented in a vertical or floor mount position. The prongs are not designed to hold the plug in place if it is plugged into a ceiling, under-the-table or cabinet outlet.
- ▶ Avoid placing the telephone base and charger too close to:
  - ▶ Communication devices such as television sets, VCRs, or other cordless telephones.
  - ▶ Excessive heat sources.
  - ▶ Noise sources such as a window with traffic outside, motors, microwave ovens, refrigerators, or fluorescent lighting.
  - ▶ Excessive dust sources such as a workshop or garage.
  - ▶ Excessive moisture.
  - ▶ Extremely low temperature.
  - ▶ Mechanical vibration or shock such as on top of a washing machine or workbench.

## Battery installation and charging

Once you have installed the battery, the screen indicates the battery status (see the following table). For best performance, keep the handset in the telephone base or charger when not in use. The battery is fully charged after 16 hours of continuous charging. See the table in the **Technical specifications** section on page 109 for battery operating times.

Battery indicators	Battery status	Action
The screen is blank or shows <b>Put in charger</b> and  flashes.	The battery has no or very little charge. The handset cannot be used.	Charge without interruption (at least 30 minutes).
The screen shows <b>Low battery</b> and  flashes.	Battery has enough charge to be used for a short time.	Charge without interruption (at least 30 minutes).
The screen shows <b>HANDSET X.</b>	Battery is charged.	To keep the battery charged, place it in the telephone base or charger when not in use.

1. Plug the battery connector securely into the socket inside the handset battery compartment. Insert the supplied battery with the label **THIS SIDE UP** facing up, as indicated.

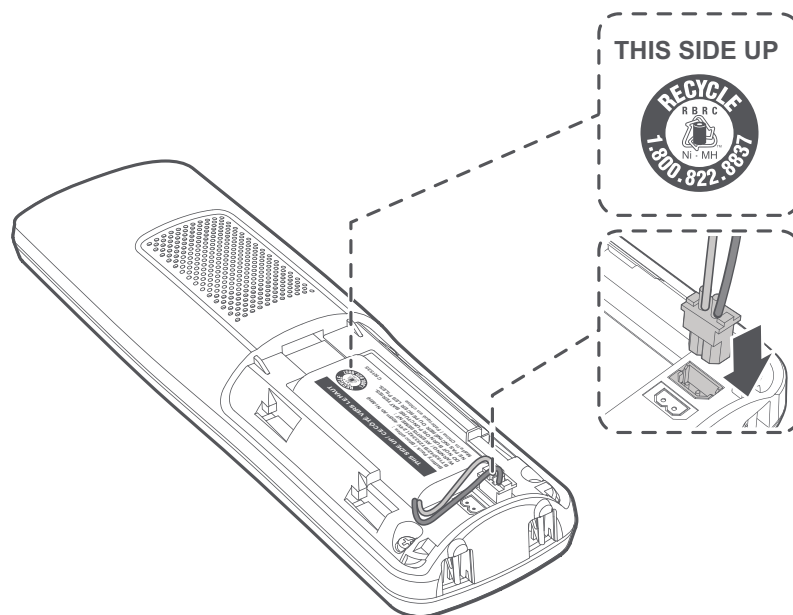

Getting started

## Battery installation and charging

- Align the cover flat against the battery compartment, then slide it upwards until it clicks into place.

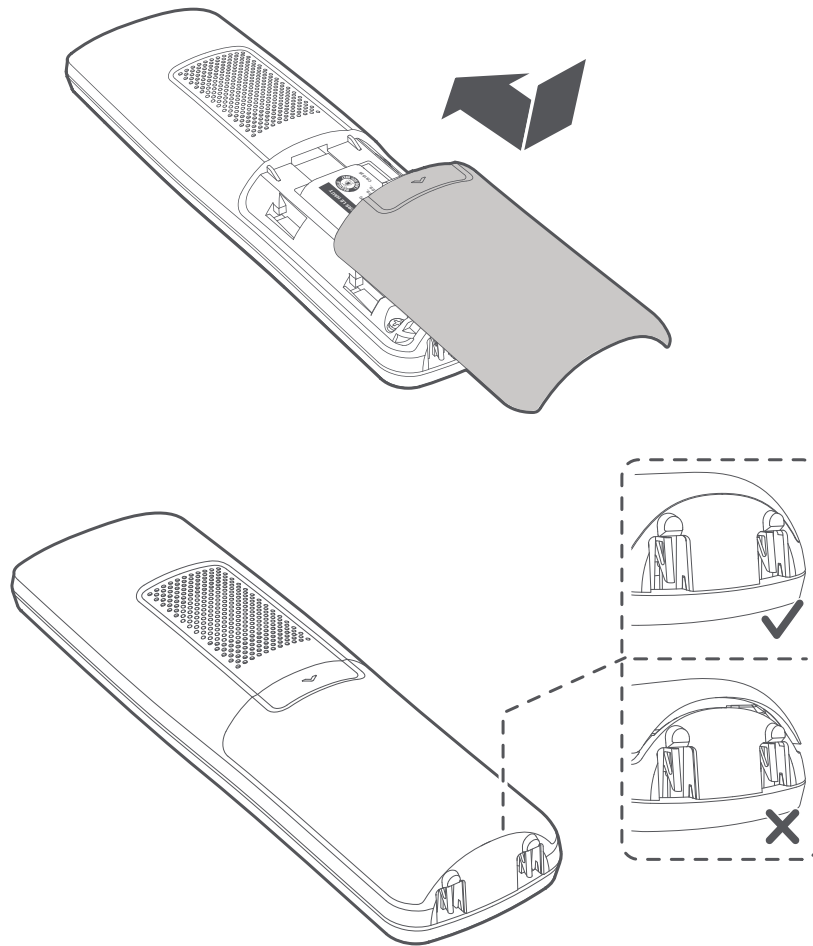

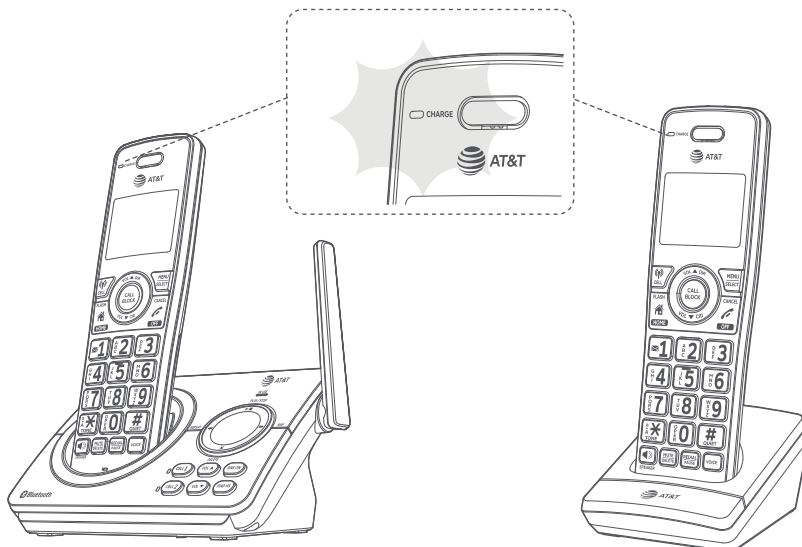

- Charge the handset by placing it face forward in the telephone base or charger. The **CHARGE** light on the top of the handset is on during charging.



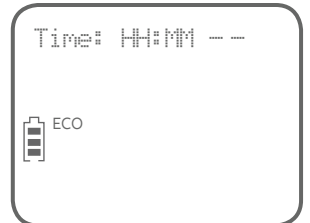

## Battery installation and charging

After you install your telephone or power returns following a power outage, the handset will prompt you to set the date and time. For instructions, see **Set date/time** on page 24. To skip setting the date and time, press  **OFF/CANCEL** on the handset.

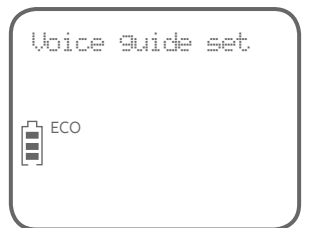

After the date and time setting is done or skipped, the handset will prompt if you want to set Smart call blocker. Press **MENU/SELECT** to start the Smart call blocker setup via voice guide. For more details, see **Voice guide to set Smart call blocker** on page 65. To skip the setup, press  **OFF/CANCEL** twice.



After the Smart call blocker setting is done or skipped, the handset will then prompt if you want to set up the answering system. Press **MENU/SELECT** to start the answering system setup via voice guide. For more details, see **Voice guide to set Answering system** on page 74. To skip the setup, press  **OFF/CANCEL**.

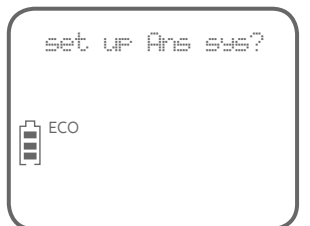
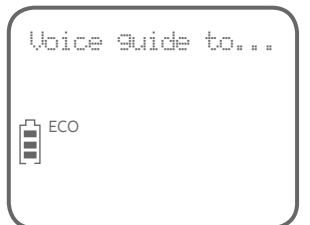

### IMPORTANT INFORMATION

- ▶ Use only the supplied rechargeable battery or replacement battery (model BT162342/BT262342). To order, visit our website at <https://telephones.att.com> or call **1 (800) 222-3111**. In Canada, dial **1 (866) 288-4268**.
- ▶ If you do not use the handset for a long time, disconnect and remove the battery to prevent possible leakage.



## Installation options

Your telephone base is ready for tabletop use. If you want to mount your telephone on a wall, use the provided wall-mount bracket to attach to a standard dual-stud telephone wall-mounting plate. If you do not have this wall-mounting plate, you can purchase one from many hardware or consumer electronics retailers. You may need a professional to install the wall-mounting plate.

### Tabletop to wall-mount installation

1. Plug the telephone line into the telephone base. If you are using a DSL filter, plug the other end of the telephone line into the filter. Route the telephone line cord (or DSL filter) through the wall-mount bracket hole.
2. Align the holes on the wall-mount bracket with the standard wall plate and slide the wall-mount bracket down until it locks securely.
3. Position the telephone base, as shown below. Insert the extended tabs (marked B) of the wall-mount bracket into the slots on the back of the telephone base. Push the telephone base down until it is securely in place.
4. Plug the power adapter into a power outlet not controlled by a wall switch. Plug the other end of the power adapter into the telephone base. Bundle the telephone line cord and power adapter cord neatly with twist ties.

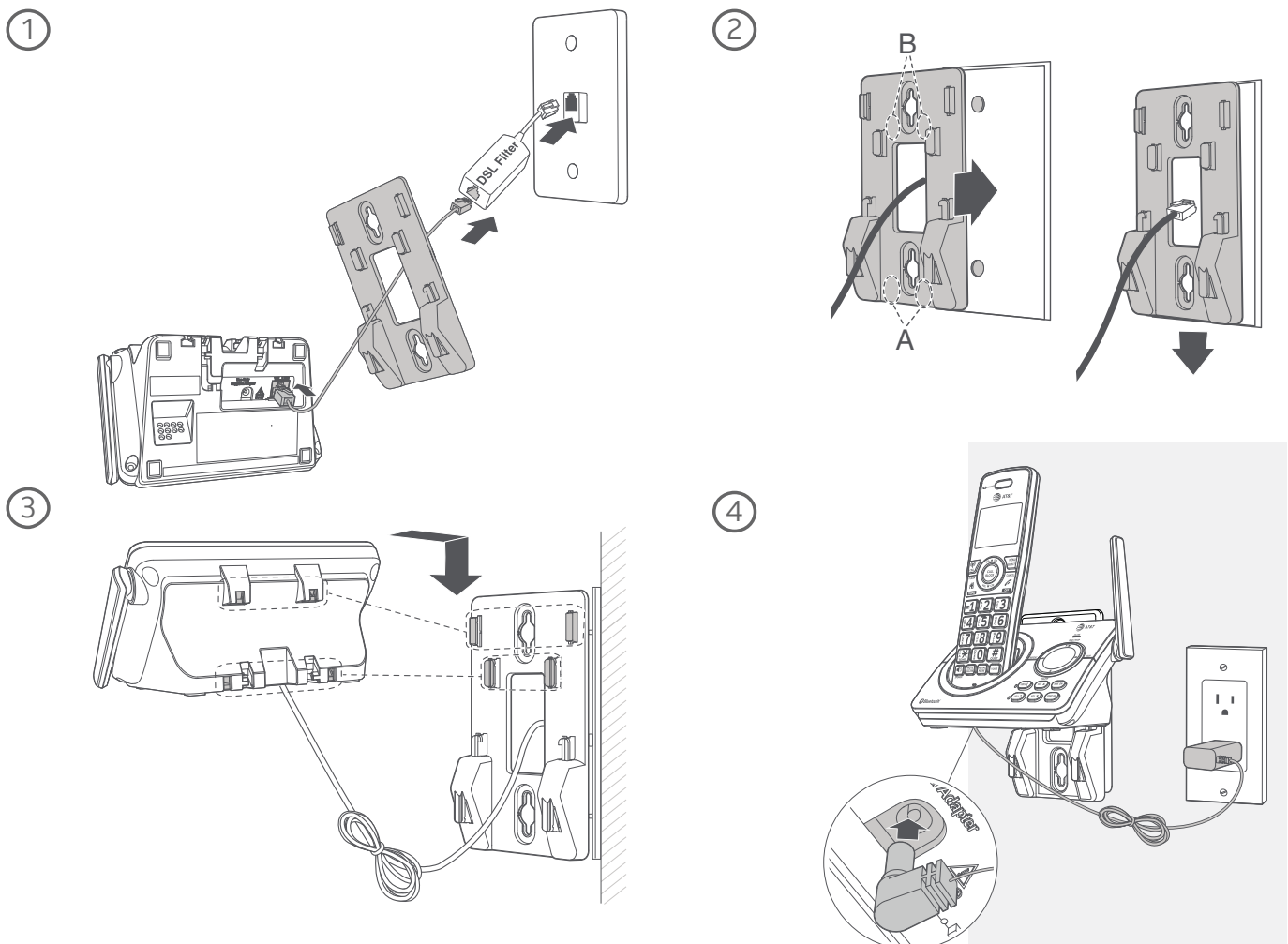

## Wall-mount to tabletop installation

---

To change the telephone base from the wall-mount position to tabletop position, follow the steps, as mentioned below.

1. Unplug the large end of the power adapter from the electrical outlet.
2. If the telephone line cord and power adapter cord are bundled, untie them first. Slide the wall-mount bracket up and remove it from the wall-mounting plate.

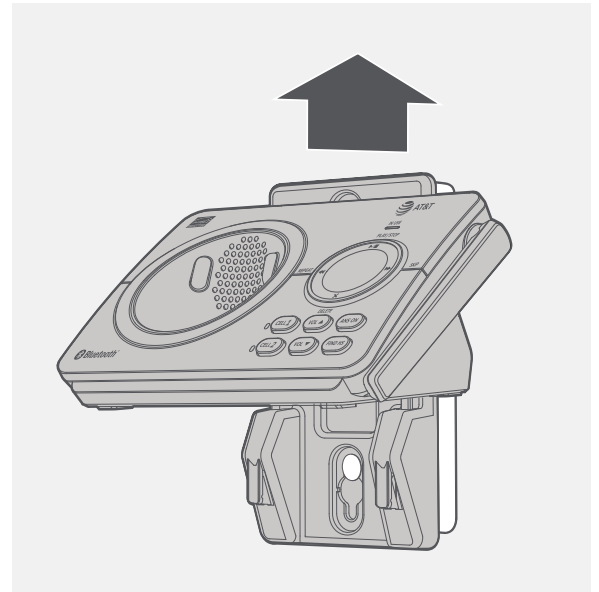

3. Unplug the telephone line cord or the DSL filter from the telephone wall jack. Push the telephone base up and away from the wall-mount bracket to detach it from the wall-mount bracket.

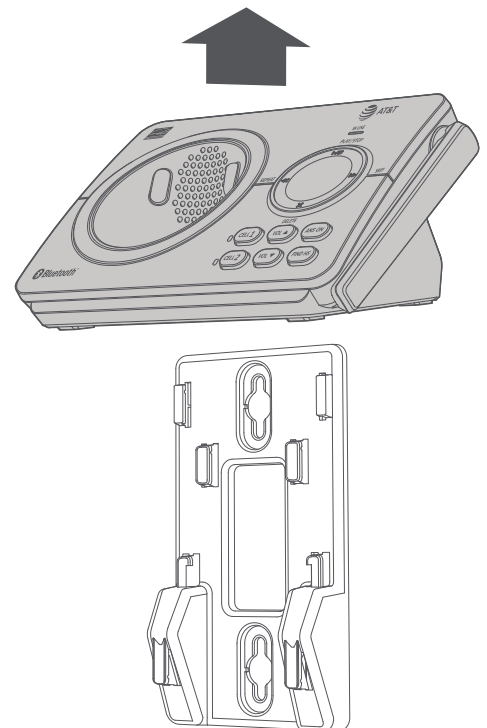

4. See **Telephone base installation** on page 6.

## Introducing Bluetooth

Your new AT&T **DL72210/DL72310/DL72340/DL72350** telephone system with Bluetooth wireless technology has the following features:

- ▶ Pair up to two Bluetooth enabled devices (two cell phones, or one cell phone and one headset) with the telephone base.
- ▶ Connect a maximum of two Bluetooth enabled devices to make and receive cell calls. Only one cell phone can be active on a call at a time.
- ▶ Connect a Bluetooth enabled headset for making and receiving home calls.
- ▶ Make and receive calls using your cell phone service with your telephone base or system handsets.
- ▶ Download phonebook entries from your cell phone.

### IMPORTANT INFORMATION

- ▶ Your **DL72210/DL72310/DL72340/DL72350** is compatible with Bluetooth version 2.0 or above devices.
- ▶ After plugging in the telephone base, wait at least 20 seconds before connecting a Bluetooth device.
- ▶ Refer to the user's manual of your Bluetooth enabled cell phone or headset for more information about how that device uses Bluetooth connectivity.
- ▶ Bluetooth wireless technology operates within a short range (a maximum of approximately 15 feet) from the telephone base. Keep connected cell phones and headsets within this range.
- ▶ If your cell phone has poor reception in your home, the **DL72210/DL72310/DL72340/DL72350** cannot improve the reception. However, if there is a location in your house with better reception, you can leave your cell phone at that location while you use the **DL72210/DL72310/DL72340/DL72350** cell line. For optimal performance, place your cell phone next to the telephone base while using the cell line.

## Introducing Bluetooth

- ▶ If you experience poor sound quality, it may be caused by the distance between your cell phone and the telephone base. To improve the performance, place your cell phone closer to the telephone base (within 15 feet) and make sure that there are no physical obstacles such as large furniture or thick wall in between.

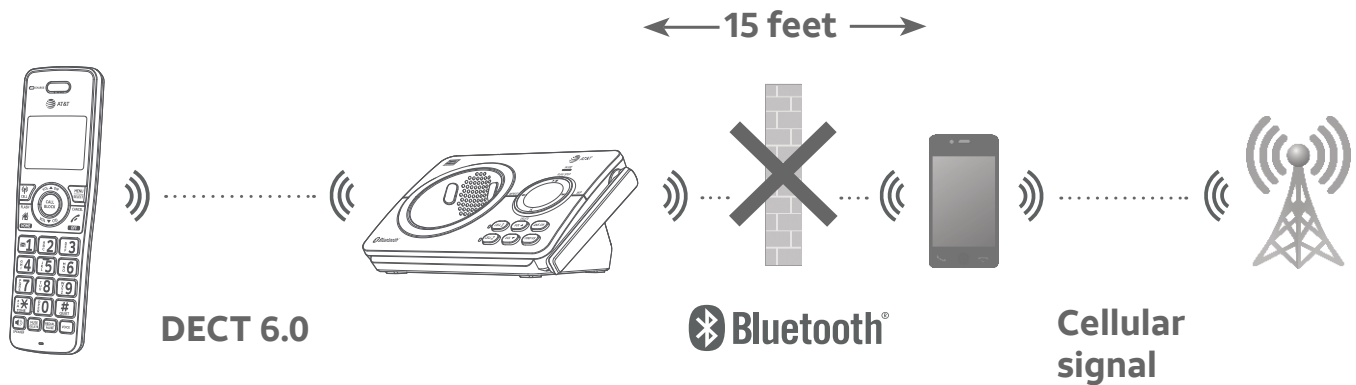

- ▶ Charge your cell phone while it is connected to the telephone base. Your cell phone's battery discharges faster while it is connected to the telephone base via Bluetooth wireless technology.
- ▶ Monitor your cell phone's usage, because minutes may be deducted from your cellular plan for the duration of all cell calls, depending on the terms of your plan.

This quick start guide only provides you with basic Bluetooth setup and major operation instructions. Please refer to the online **DL72210/DL72310/DL72340/DL72350** Complete user's manual for a full set of setup and operation instructions at <https://telephones.att.com/manuals>.

The *Bluetooth*® word mark and logos are owned by Bluetooth SIG, Inc. and any use of such marks by Advanced American Telephones and its parent, VTech Holdings Limited, is under license. VTech Holdings Limited is a member of Bluetooth SIG, Inc. Other trademarks and trade names are those of their respective owners.

## Introducing Bluetooth

### **Connect to Cell™ application**

---

If you are using Bluetooth-enabled cell phones with Android® OS 2.3 or above, you can further extend the flexibility of your telephone system with use of the free **Connect to Cell** application.

**Connect to Cell** comprises **Caller ID manager** and **Alerts manager** that help integrate your cell phone with the AT&T telephone system.

**Caller ID manager** (Caller ID share) allows you:

- ▶ To view your AT&T phone's caller ID log on your Android cell phone;
- ▶ To use your Android cell phone to call back or send messages to individuals who have called your home line on the AT&T telephone;
- ▶ To store callers' names and numbers to your Android phone's directory for future use.

**Alerts manager** (Mobile notification) allows you to extend your Android phone's alerts to your AT&T telephone system. Your AT&T telephone will notify you whenever you receive certain text messages, e-mails or social media updates on your Android phone, so you will always be kept up to date.

To use **Caller ID manager** and **Alerts manager**, you must first download **Connect to Cell** to your Android cell phone using the **Google Play® Store** app. Scan the QR code on the right to download the application.



## Bluetooth setup

To use a Bluetooth enabled cellular phone or headset with your telephone, you must first pair and connect your Bluetooth cellular phone or headset with the telephone base. Then, the **DL72210/DL72310/DL72340/DL72350** can be used to make or answer calls on the cell phone line.

Bluetooth wireless technology operates within a short range (up to 15 feet). When you pair a Bluetooth cell phone or Bluetooth headset to the telephone base, keep the device within 15 feet of the telephone base for optimal performance.

### **Add a cell phone**

---

Before you begin, make sure that you have cellular coverage and your Bluetooth enabled cell phone is not connected to any other Bluetooth device. Refer to your cell phone user's manual to learn how to search for or add new Bluetooth devices.

#### **To pair and connect a cell phone:**

1. Choose a slot to pair the cell phone. Press and hold **CELL 1** or **CELL 2** on the telephone base for about four seconds until the **CELL 1** or **CELL 2** light flashes.
  - If there is already a cell phone in the slot, the existing cell phone will be erased from cell devices list.
2. Turn on the Bluetooth feature of your cell phone and search for or add new devices. Once your cell phone finds your AT&T phone (**AT&T DECT 6.0**), press the appropriate key on your cell phone to continue the pairing process.
  - All cell phones that are connected to the telephone base are disconnected temporarily until the pairing process is complete.

When a device is successfully paired and connected, the corresponding status icon (📶<sup>1</sup> or 📶<sup>2</sup>) displays. The corresponding device light on the telephone base (**CELL 1** or **CELL 2**) turns on.

## Bluetooth setup

### Add a headset

---

Before you begin, make sure that your Bluetooth enabled headset is not connected to any other Bluetooth device. Refer to your headset user's manual to learn how to search for or add new Bluetooth devices.

#### To pair and connect a headset:

1. Press **MENU/SELECT** on the handset in idle mode.
2. Press **▼CID** or **▲DIR** to highlight **Bluetooth**, then press **MENU/SELECT**.
3. Press **▼CID** or **▲DIR** to highlight **Add BT headset**, then press **MENU/SELECT**.  
The handset displays **Search headset...**
4. Set your headset to discoverable mode (refer to the user's manual of your headset). When the screen displays the found devices, press **▼CID** or **▲DIR** to highlight your headset, if necessary, then press **MENU/SELECT**.

When a device is successfully paired and connected, the corresponding status icon () displays. The **CELL 2** light on the telephone base turns on.

**If you have trouble pairing your cell phone or headset, it may not be compatible with your DL72210/DL72310/DL72340/DL72350. Check the Bluetooth compatibility list at <https://telephones.att.com/bluetooth>.**

## Bluetooth setup

### **Download directory**

---

You can download cell phone directory (phonebook) entries to your **DL72210/DL72310/DL72340/DL72350** telephone system via Bluetooth wireless technology. Each downloaded cell phone directory entry are stored in the handset directory with up to 30 digits for each phone number and 15 characters for each name.

Before downloading the cell phone directory, make sure the cell phone is paired, active, and connected to your **DL72210/DL72310/DL72340/DL72350**. Make sure the handset battery is charged for at least 10 minutes.

Place your cell phone next to the telephone base when you download a cell phone directory to your **DL72210/DL72310/DL72340/DL72350**.

#### **To download a cell phone directory:**

1. Press **MENU/SELECT** on the handset in idle mode.
2. Press **▼CID** or **▲DIR** to highlight **Bluetooth**, then press **MENU/SELECT**.
3. Press **▼CID** or **▲DIR** to highlight **Download DIR**, then press **MENU/SELECT**. The handset displays **Select a device** briefly.
  - If there is no cell phone paired to the system, the handset displays **Pair cell first** and then returns to the previous menu.
4. Press **▼CID** or **▲DIR** to choose a desired device when necessary, and then press **MENU/SELECT**.
  - If the selected device is not available, the handset returns to the previous menu.

During the download, the handset flashes **Downloading...** All other idle system handsets display **Downloading...**

5. When the downloading process completes or when the memory is full, the handset displays **Entries added: XXX**. Then the handset returns to the **Bluetooth** menu.



## Bluetooth

### Remote voice control

If you have connected a cell phone to the **DL72210/DL72310/DL72340/DL72350** telephone system, you can activate the voice-controlled application (voice app) of the cell phone, such as Siri®, Google Now™ or S Voice®, using your handset.

The remote voice control feature works with:

Voice-controlled application	Siri	Google Now	S Voice
Operation System (Versions supported)	iOS (8 or above)	Android (4 or above)	Android (4 or above)

Before using the remote voice control feature, make sure you checked the following:

- ▶ Your cell phone is paired and connected to your telephone system via Bluetooth.
- ▶ No Bluetooth applications are running in the background of your cell phone.
- ▶ Keep your cell phone within 15 feet of the telephone base.
- ▶ Do not lock up your cell phone's screen or set passcode for activating the voice app.
- ▶ Make sure you have turned on or logged in to the applications on your cell phone that you will be sending your voice commands, such as GPS, e-mail and social networking accounts.
- ▶ Your cell phone's data or Wi-Fi signal is in full strength and your cell phone can connect to the Internet.
- ▶ Try to activate the voice app on your cell phone to ensure it is in place.

Siri® is a registered trademark of Apple Inc.

Google Now™ is a trademark of Google Inc.

S Voice® is a registered mark of Samsung Electronics Co., Ltd.

IOS is a trademark or registered trademark of Cisco in the U.S. and other countries and is used under license.

## Remote voice control

### Activate remote voice control

---

1. Press **VOICE** on the handset.
  - ▶ If you have connected one cell phone to the telephone, the handset shows the device name of the connected cell phone directly.
  - ▶ If you have connected two cell phones to the telephone, the handset shows **Select a device**, followed by the device name list of the connected cell phones. Scroll to choose the desired cell phone, and then press **MENU/SELECT**.
2. The handset then shows the remote voice control icon (📞).
  - ▶ If the activation fails, the handset displays **Not available**. When the screen returns to idle, try Step 1 again.
3. When the handset plays the confirmation tone as forwarded by the cell phone's voice app, start speaking toward the handset, and then wait for feedback. Make reply to the voice app's feedback, if necessary.
  - ▶ You can press **🔊/SPEAKER** on the handset to turn off the speakerphone and listen to the feedback through the handset earpiece.
4. To end the current remote voice control session, press **🔇/OFF/CANCEL** on the handset. You can restart by following Steps 1-3 mentioned above.

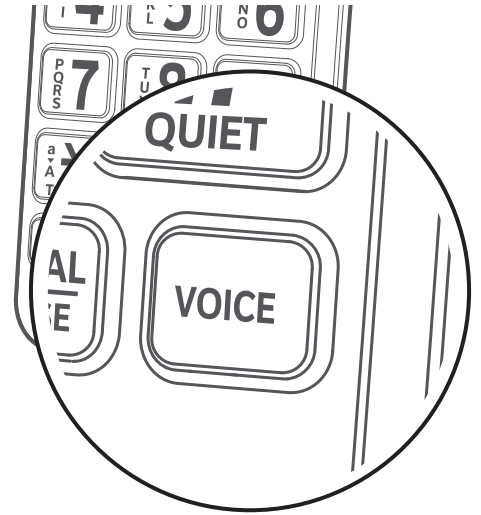

## Remote voice control



### Notes:

- ▶ Once you have activated the remote voice control feature, you are using your cell phone's voice app to operate your cell phone.
- ▶ Please check the cell phone user's manual and the voice app's help topics to find out what commands you can use and any limitations of the voice app.
- ▶ Some cell phone manufacturers or network carriers may customize the phone's operating system and implement their own voice app. If you want to use Google Now, you need to manually set it as your default voice app. For detailed instructions, refer to your cell phone user's manual, or contact your cell phone's manufacturer or network carrier. You may also go to "Google Product Forums" on the Internet and check the corresponding help topics.
- ▶ Due to the settings of certain cell phones and voice apps, your cell phone may not support the remote voice control feature. Contact your cell phone's manufacturer or network carrier, or check the voice app's help topics if you encounter any problems.
- ▶ During the remote voice control activation, if your Android cell phone comes with both a dedicated voice app and Google Now, it may prompt you to select which voice app to use, and whether use it for just once or always. Select the desired options. If you do not respond to your cell phone's prompt in time, the handset screen will return to idle, and the  icon will disappear. You can restart by following Steps 1-3 mentioned above.
- ▶ If you receive a landline or cell line incoming call when you have activated remote voice control on a connected cell phone, the remote voice control operation will be ended.
- ▶ The feature may be ended automatically by your cell phone. For example, a cell call has been established via the remote voice control feature and the call has just ended.
- ▶ If you need to press dialing keys (**0-9, TONEX, QUIET#**) during a cell call, please make the call using the cell lines of your telephone system instead of using the voice app via the remote voice control feature (see **Make, answer or end a cell call** on page 28).

## Telephone settings

Use the menu to change the cordless handset settings.

1. Press **MENU/SELECT** on the handset when it is not in use to enter the main menu.
2. Press **▼CID** or **▲DIR** to scroll to the feature to be changed. When scrolling through the menu, the selected menu item is highlighted.
3. Press **MENU/SELECT** to select the highlighted item.



Note: Press **OFF/CANCEL** on the handset to cancel an operation, back up to the previous menu or exit the menu display. Press and hold **OFF/CANCEL** to return to idle mode.

### Ringer volume

---

You can select the ringer volume for incoming calls on home and cell lines.

#### To set the ringer volume on home line:

1. Press **MENU/SELECT** in idle mode.
2. Press **▼CID** or **▲DIR** to highlight **Ringers**, then press **MENU/SELECT**.
3. Press **MENU/SELECT** to select **Home volume**.
4. Press **▼CID** or **▲DIR** to sample each ringer volume for home line.
5. Press **MENU/SELECT** to save.

#### To set the ringer volume on cell lines:

1. Press **MENU/SELECT** in idle mode.
2. Press **▼CID** or **▲DIR** to highlight **Ringers**, then press **MENU/SELECT**.
3. Press **▼CID** or **▲DIR** to select **Cell volume**, then press **MENU/SELECT**,
4. Press **▼CID** or **▲DIR** to sample each ringer volume for cell lines.
5. Press **MENU/SELECT** to save.

### Telephone base ringer volume

When the telephone base is idle, press **VOL ▲** or **VOL ▼** on the telephone base to adjust the ringer volume.

When you set the ringer volume to zero, the base ringer is off and the system announces, *“Base ringer is off.”*



Notes:

- ▶ Changing the ringer volume on a handset does not affect the ringer volume of other devices.
- ▶ The ringer volume level also determines the ringer levels of intercom calls.

## Telephone settings

### Ringer tone

---

You can select the ringer tones for incoming home and cell calls.

#### To set the ringer tone on home line:

1. Press **MENU/SELECT** in idle mode.
2. Press **▼CID** or **▲DIR** to highlight **Ringers**, then press **MENU/SELECT**.
3. Press **▼CID** or **▲DIR** to select **Home ringtone**, then press **MENU/SELECT**,
4. Press **▼CID** or **▲DIR** to sample each ring tone for home line.
5. Press **MENU/SELECT** to save.

#### To set the ringer tone on cell lines:

1. Press **MENU/SELECT** in idle mode.
2. Press **▼CID** or **▲DIR** to highlight **Ringers**, then press **MENU/SELECT**.
3. Press **▼CID** or **▲DIR** to select **Cell ringtone**, then press **MENU/SELECT**,
4. Press **▼CID** or **▲DIR** to sample each ring tone for cell lines.
5. Press **MENU/SELECT** to save.



Note: When you turn off the ringer volume, you will not hear ringer tone samples.

### LCD language

---

You can select English, French, or Spanish to be used for all screen displays.

#### To select the LCD language:

1. Press **MENU/SELECT** in idle mode.
2. Press **▼CID** or **▲DIR** to highlight **Settings**, then press **MENU/SELECT**.
3. Press **MENU/SELECT** to select **LCD language**.
4. Press **▼CID** or **▲DIR** to highlight **English**, **Français** or **Español**, then press **MENU/SELECT** to confirm.



Note: If you accidentally change the LCD language to French or Spanish, you can reset it back to English without going through the French or Spanish menus. Press **MENU/SELECT** in idle mode, then enter **\*364#**. There is a confirmation tone.

## Telephone settings

### Set date and time

---

The answering system announces the day and time of each message prior to playing it. Before using the answering system, set the date and time as follows. If you subscribe to caller ID service, the day, month and time are set automatically with each incoming call. However, the year must be correct so that the day of the week can be calculated from the caller ID information.

#### To set the date and time manually:

1. Press **MENU/SELECT** in idle mode.
2. Press **▼CID** or **▲DIR** to highlight **Set date/time**, then press **MENU/SELECT**.
3. Enter the month using the dialing keys.
4. Enter the day using the dialing keys.
5. Enter the year using the dialing keys, then press **MENU/SELECT** to move on to set the time.
6. Enter the hour using the dialing keys.
7. Enter the minute using the dialing keys.
8. Press **▼CID** or **▲DIR** to highlight **AM** or **PM**, then press **MENU/SELECT** to confirm.

### Set speed dial voicemail number

---

This feature lets you save your voicemail number for quick access when you press and hold the  **1** key.

#### To set your voicemail number:

1. Press **MENU/SELECT** in idle mode.
2. Press **▼CID** or **▲DIR** to highlight **Settings**, then press **MENU/SELECT**.
3. Press **▼CID** or **▲DIR** to highlight **Voicemail #**, then press **MENU/SELECT**.
4. Use the dialing keys to enter the voicemail access number (up to 30 digits) provided by your telephone service provider.
  - ▶ Press **▼CID** or **▲DIR** to move the cursor to the left or right.
  - ▶ Press **MUTE/DELETE** on the handset to erase a digit.
  - ▶ Press and hold **MUTE/DELETE** on the handset to erase all digits.
  - ▶ Press and hold **REDIAL/PAUSE** to enter a three-second dialing pause (a **P** appears).
5. Press **MENU/SELECT** to confirm.

## Telephone settings

### **Voicemail (visual message waiting) indicator**

---

If you subscribe to a voicemail service offered by your telephone service provider, **New voicemail** and the  icon appear on the handset screen when you have new voicemail messages. Contact your service provider for more information and assistance about using your voicemail service.

### **Clear voicemail indicator/indication**

---

Use this feature when the telephone indicates there is new voicemail but there is none. For example, when you have accessed your voicemail while away from home. This feature only turns off the displayed **New voicemail** and the  icon; it does not delete your voicemail messages. As long as you have new voicemail messages, your telephone service provider continues to send the signal to turn on the indicator.

#### **To manually turn off the new voicemail indicator:**

1. Press **MENU/SELECT** in idle mode.
2. Press **▼CID** or **▲DIR** to highlight **Settings**, then press **MENU/SELECT**.
3. Press **▼CID** or **▲DIR** to highlight **Clr voicemail**, then press **MENU/SELECT** to turn the voicemail indicator off.



Note: For information about using your voicemail service, contact your telephone service provider.

### **Key tone**

---

The handset is set to beep with each key press. You can adjust the key tone volume or turn it off.

#### **To set the key tone:**

1. Press **MENU/SELECT** in idle mode.
2. Press **▼CID** or **▲DIR** to highlight **Settings**, then press **MENU/SELECT**.
3. Press **▼CID** or **▲DIR** to highlight **Key tone**, then press **MENU/SELECT**.
4. Press **▼CID** or **▲DIR** to select **On** or **Off**.
5. Press **MENU/SELECT** to confirm.

## Telephone settings

### Home area code

---

If you dial seven digits to make a local call (no area code required), enter your area code into the telephone as the home area code. When you receive a call from within your home area code, the caller ID log only displays the seven digits of the telephone number.

This feature makes it easy for you to place a call from the caller ID log. If you dial 10 digits to make a local phone call, do not use this home area code feature. If you do, you cannot place local calls from your caller ID log, as they will have only seven digits.

#### To set the home area code:

1. Press **MENU/SELECT** in idle mode.
2. Press **▼CID** or **▲DIR** to highlight **Settings**, then press **MENU/SELECT**.
3. Press **▼CID** or **▲DIR** to highlight **Home area code**, then press **MENU/SELECT**.
4. Use the dialing keys to enter a three-digit home area code.
  - Press **▼CID** or **▲DIR** to move the cursor to the left or right.
  - Press **MUTE/DELETE** to erase a digit.
  - Press and hold **MUTE/DELETE** to erase all digits.
5. Press **MENU/SELECT** to confirm.

### Dial mode

---

The dial mode is preset to tone dialing. If you have pulse (rotary) service, you must change the dial mode to pulse dialing before using the telephone.

#### To set the dial mode:

1. Press **MENU/SELECT** in idle mode.
2. Press **▼CID** or **▲DIR** to highlight **Settings**, then press **MENU/SELECT**.
3. Press **▼CID** or **▲DIR** to highlight **Dial mode**, then press **MENU/SELECT**.
4. Press **▼CID** or **▲DIR** to choose **Touch-tone** or **Pulse**, then press **MENU/SELECT**.



## Telephone settings

### **QUIET mode**

---

When **QUIET** mode is turned on, the telephone silences all sounds during the set period of time (1-12 hours). However, the handset locator paging tone and any sound-generating operations initiated by users, such as making calls using the speakerphone or setting ringer volume, will sound as normal. After you turn on **QUIET** mode, this feature activates immediately and the answering system turns on automatically.

When **QUIET** mode is on, the answering system takes calls and records messages without broadcasting them.

#### **To turn QUIET mode on:**

1. Press and hold **QUIET #** in idle mode.
2. Use the dialing keys to enter the desired number of hours (1-12) you would like to turn on **QUIET** mode, then press **MENU/SELECT**.

#### **To turn QUIET mode off:**

- ▶ While **QUIET** mode is on, press and hold **QUIET #**.



Note: When QUIET mode is on, and Smart call blocker is on and in screening mode, all screened calls will be sent to the answering system after screening. For more information on Smart call blocker, see page 45.

## Telephone operation

### Make, answer or end a home call

---

#### To make a home call:

- ▶ Press **HOME/FLASH** or **SPEAKER** on the handset, then enter the telephone number.

#### To predial a home call:

- ▶ Enter the telephone number, and then press **HOME/FLASH** or **SPEAKER** to dial.

#### To answer a home call:

- ▶ Press **HOME/FLASH**, **SPEAKER** or any dialing key (**0-9, TONE X** or **QUIET#**).

#### To end a home call:

- ▶ Press **OFF/CANCEL**, or put the handset in the telephone base or charger.

### Using a Bluetooth headset to answer a home call:

You can use a Bluetooth headset to answer home calls. However, you need to keep the device within 15 feet of the telephone base for optimal performance. Please see the user's manual of your Bluetooth headset for more information.

### To answer or end a home call using a Bluetooth headset:

- ▶ Press the call key on your headset.

### Make, answer or end a cell call

---

The **DL72210/DL72310/DL72340/DL72350** can be used to make or answer calls on the cell line. You can connect a maximum of two Bluetooth enabled cell phones to the telephone base.

#### To make a cell call:



1. Press **CELL** on the handset. The handset displays **Select a device**.
  - ▶ If you have only one cell phone connected to the telephone base, press **MENU/SELECT** to select the only device.
  - ▶ If you have two cell phones connected to the telephone, press **CID** or **DIR** to select a cell phone and then press **MENU/SELECT**.
2. Enter the telephone number, then press **CELL** to dial.

## Telephone operation

### To predial a cell call:

1. Enter the telephone number.
2. Press  **CELL** on the handset to dial.
  - If you have only one cell phone connected to the telephone base, it is automatically selected to make cell calls.
  - If you have two cell phones connected to the telephone base, the handset displays **Select a device**. Press **▼CID** or **▲DIR** to select a cell phone and then press **MENU/SELECT**.

### To answer a cell call:

- Press  **CELL**,  **/SPEAKER**, or any dialing key (**0-9, TONE X** or **QUIET#**).

### To end a cell call:

- Press  **OFF/CANCEL**, or put the handset in the telephone base or charger.

## Silencing the ringer

---

When the telephone is ringing, you can temporarily silence the ringer of the handset without disconnecting the call. The next call rings normally at the preset volume.



### To silence the handset ringer:

- Press  **OFF/CANCEL** or **MUTE/DELETE** on the handset.

## Call waiting on the home line

---

If you subscribe to call waiting service from your telephone service provider, and someone calls while you are already on a call on the home line, the handset flashes , and you a beep.



- Press  **HOME/FLASH** on the handset to put your current call on hold and take the new call.
- Press  **HOME/FLASH** on the handset at any time to switch back and forth between calls.

## Telephone operation

### **Call waiting on the cell line**

---

If you subscribe to call waiting service from your cell phone service provider, and someone calls while you are already on a call on the cell line, the handset flashes , and you hear a beep.

- ▶ Press  **CELL** on the handset to put your current call on hold and take the new call.
- ▶ Press  **CELL** on the handset at any time to switch back and forth between calls.

### **Answer an incoming cell call while on a home call**

---

If you are on a home call and you receive an incoming cell call, you hear a beep and  displays on the handset. The telephone base and all other handsets ring.

#### **To answer the incoming cell call:**

- ▶ Press  **CELL** on the handset. The home call is automatically placed on hold.

#### **To end the cell call:**

- ▶ Press  **OFF/CANCEL**. The home line is still on hold.

#### **To resume the home call on hold:**

- ▶ Press  **HOME/FLASH** on the handset.

### **Answer an incoming home call while on a cell call**

---

If you are on a cell call and you receive an incoming home call, you hear a beep and  displays on the handset. The telephone base and all other handsets ring.

#### **To answer the incoming home call:**

- ▶ Press  **HOME/FLASH** on the handset. The cell call is automatically placed on hold.

#### **To end the home call:**

- ▶ Press  **OFF/CANCEL** on the handset. The cell line is still on hold.

#### **To resume the cell call on hold:**

- ▶ Press  **CELL** on the handset.

## Options while on calls

### Handset speakerphone

---

During a call, press **☎/SPEAKER** to switch between the speakerphone and normal handset use.

Press **🔌 OFF/CANCEL**, or return the handset to the telephone base or charger to hang up.

### Volume control

---

While on a call or message playback, you can adjust the listening volume on the handset or telephone base.

If it is a cell call and the volume is too loud, too quiet or drops out, try changing the volume on your cell phone. On some cell phones, changing the volume on the cell phone affects your cell call volume on the **DL72210/DL72310/DL72340/DL72350** handsets.

#### To adjust the listening volume of a handset:

- › Press **VOL ▼** or **VOL ▲** on the handset while on a call.

#### To adjust the listening volume of the telephone base:

- › Press **VOL ▼** or **VOL ▲** while listening to the message playback on the telephone base.

### Mute

---

Use the mute function to turn off the microphone. You can hear the caller, but the caller cannot hear you.

#### To mute a call:

- › While on a call, press **MUTE/DELETE** on the handset. The handset displays **Muted** until the mute function is turned off.

#### To end mute a call:

- › Press **MUTE/DELETE** on the handset again and resume speaking. The handset briefly displays **Microphone on**.

Mute is automatically canceled when you end the call.

## Options while on calls

### **Temporary tone dialing**

---

If you have pulse (rotary) service only, you can switch from pulse to touch-tone dialing temporarily during a call. This is useful if you need to send touch-tone signals to access your telephone banking or long distance services.

#### **During a call:**

1. Press **TONE X** on the handset.
2. Use the dialing keys to enter the relevant number. The telephone sends touch-tone signals.
3. The telephone automatically returns to pulse dialing after you end the call.

### **Chain dialing**

---

Use this feature to initiate a dialing sequence from numbers stored in the directory, caller ID log or redial list while you are on a call.

Chain dialing is useful if you wish to access other numbers (such as bank account numbers or access codes) from the directory, caller ID log or redial list.

#### **Using a handset:**

##### **To access a number in the directory while on a call:**

1. Press **MENU/SELECT**.
2. Press **MENU/SELECT** to select **Directory**.
3. Press **▼CID** or **▲DIR** to scroll to the desired entry or perform an alphabetical search (page 38), then press **MENU/SELECT** to dial the displayed number.

##### **To access a number in the caller ID log while on a call:**

1. Press **MENU/SELECT**.
2. Press **▼CID** or **▲DIR** to highlight **Caller ID log**, then press **MENU/SELECT**.
3. Press **▼CID** or **▲DIR** to scroll to the desired entry, then press **MENU/SELECT** to dial the displayed number.

##### **To access the redial list while on a call:**

1. Press **REDIAL/PAUSE**.
2. Press **▼CID**, **▲DIR**, or **REDIAL/PAUSE** until the desired number displays.
3. Press **MENU/SELECT** to dial the displayed number.

## Redial

Each handset stores the last 10 dialed numbers (up to 30 digits each) in the redial list. The list of dialed numbers include both dialed home calls and cell calls.

### To view the 10 most recently dialed numbers:

1. Press **REDIAL/PAUSE** in idle mode.
2. Press **▼CID**, **▲DIR** or **REDIAL/PAUSE** repeatedly to browse until the desired number displays. The handset beeps twice at the end of the list.
3. Press **OFF/CANCEL** on the handset to exit.

### To dial a redial entry:

- ▶ When the desired redial entry displays, press **HOME/FLASH** or **▶/SPEAKER** to dial using the home line, or press **CELL** to dial using the cell line.

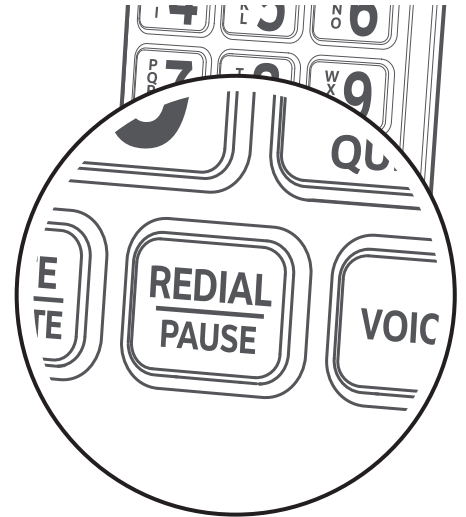

## Handset locator

This feature helps you find a misplaced handset.

### To start paging:

- ▶ Press **FIND HS** on the telephone base when it is not in use. All idle handsets ring and display **\*\* Paging \*\***.

### To end paging:

- ▶ Press **HOME/FLASH**, **CELL**, **OFF/CANCEL**, **▶/SPEAKER** or any dialing key (**0-9**, **TONE X** or **QUIET#**) on the handset.

**-OR-**

- ▶ Press **FIND HS** again on the telephone base.

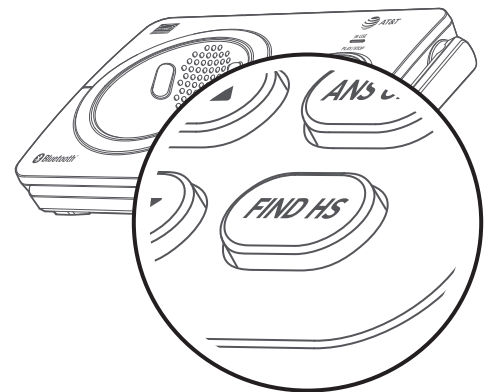

**-OR-**

- ▶ Place the handset in the telephone base or charger.



## Join a call in progress

Another handset can join you on home call. The call continues until all parties hang up. You can share an outside call with up to two system handsets.

- ▶ When a handset is already on a call, press  **HOME/FLASH** or  **SPEAKER** on another handset to join the call.
- ▶ Press  **OFF/CANCEL** or place the handset in the telephone base or handset charger to exit the call. The call continues on the other handset until both handsets hang up.



## Intercom

Use the intercom feature for conversations between two devices.

You can buy additional expansion handsets (AT&T model **DL70010**, sold separately), cordless headsets and speakerphones for this telephone system. You can register up to five handsets or cordless headsets/speakerphones to the telephone base.

### To initiate an intercom call:

1. Press **MENU/SELECT** on the handset in idle mode.
2. Press **▼CID** or **▲DIR** to highlight **Intercom**, then press **MENU/SELECT**.
3. The screen displays **Intercom to:**. Use the dialing keys to enter a device number (1-5). The handset shows **Calling HS X**. The destination handset rings and shows **HS X is calling**.

### To answer an intercom call:

- ▶ Press **HOME/FLASH**, **CELL**, **SPEAKER**, or any dialing key (**0-9**, **TONE X** or **QUIET#**) on the handset. Both handsets now show **Intercom**.

### To end an intercom call:

- ▶ Press **OFF/CANCEL** or place the handset back in the telephone base or charger.



Note: For cordless headsets and speakerphones, refer to the corresponding user's manual on how to answer and end an intercom call.

## Call transfer using intercom

Use the intercom feature to transfer an outside call to another system handset or device.

### To transfer or share an outside call using intercom:

1. When on an outside call, press **MENU/SELECT**.
2. Press **▼CID** or **▲DIR** to highlight **Intercom**, then press **MENU/SELECT**. The call is automatically put on hold.
3. Your handset shows **Intercom to:**. Use the dialing keys to enter a handset number (1-5). Your handset shows **Calling HS X**. The destination handset rings and shows **HS X is calling**.
4. To answer the intercom call on the other device, press **🏠HOME/FLASH**, **📶CELL**, **🔊/SPEAKER**, or any dialing key (**0-9**, **TONE X** or **QUIET#**) on the destination handset. The outside call is still on hold. Both handsets now show **Intercom**.
5. To transfer the call, press **🔌 OFF/CANCEL** or place the handset back in the telephone base or charger. The other handset automatically connects to the outside call.

**- OR -**

You can let the other device join you on the outside call in a three-way conversation. Press **🏠HOME/FLASH** on the originating or destination handset.

**- OR -**

The called party can end the intercom call by pressing **🔌 OFF/CANCEL** or by placing the other handset back in the telephone base or charger. The outside call continues with the originating handset.

## Directory

# Directory

The directory stores up to 1,000 entries, shared by all handsets.

Each entry may consist of a telephone number up to 30 digits, and a name up to 15 characters.

### **Create a new entry in the directory**

---

1. Press **MENU/SELECT** on the handset in idle mode.
2. Press **▼CID** or **▲DIR** to highlight **Directory**, then press **MENU/SELECT**.
3. Press **MENU/SELECT** again to choose **Add new entry**.
4. Use the dialing keys to enter a telephone number (up to 30 digits).
  - ▶ Press **▼CID** or **▲DIR** to move the cursor to the left or right.
  - ▶ Press **MUTE/DELETE** on the handset to erase a digit.
  - ▶ Press and hold **MUTE/DELETE** on the handset to erase all digits.
  - ▶ Press and hold **REDIAL/PAUSE** to insert a three-second dialing pause (a **P** appears).

#### **-OR-**

Press **REDIAL/PAUSE** to copy a number from the redial list. Press **▼CID** or **▲DIR**, or press **REDIAL/PAUSE** repeatedly to locate the desired number. Press **MENU/SELECT** to copy the displayed number.

5. Press **MENU/SELECT** to move on to the name.
6. Use the dialing keys to enter a name (up to 15 characters) when prompted. Press a key repeatedly until the desired character shows on the screen.
  - ▶ Press **▼CID** or **▲DIR** to move the cursor to the left or right.
  - ▶ Press **0** to add a space.
  - ▶ Press **MUTE/DELETE** on the handset to erase a character.
  - ▶ Press and hold **MUTE/DELETE** on the handset to erase all characters.
  - ▶ Press **-tone ✕** to change the next letter to upper or lower case.
7. Press **MENU/SELECT** to store your new directory entry.

## **Review the directory**

---

Entries are sorted alphabetically.

1. Press **▲DIR** in idle mode.
2. Press **▼CID** or **▲DIR** to to browse through the directory, or use the dialing keys to start a name search..

## **Search by name**

---

You can use the enhanced 3-character search to find your contacts quickly and efficiently.

1. Follow the steps in **Review the directory** to review the directory.
2. When an entry appears, use the dialing keys to enter the letters associated with the name. You can enter up to three letters for the search. The letters will show at the top left hand corner of the screen. After you have entered one to three letters, the system starts searching in the directory. If there is no name matching the letter(s) entered, the next closest match in alphabetical order appears. If necessary, press **▼CID** or **▲DIR** to browse.

## **Dial a directory entry**

---

You can dial a directory entry on either a home or cell line.

1. Search for the desired entry in the directory (see **Review the directory** and **Search by name** on this page).
2. When the desired directory entry appears, press **#** (pound key) repeatedly to show different dialing options, if necessary.
3. When the displayed number is in the correct format, press **🏠HOME/FLASH** or **🔊/SPEAKER** on the handset to dial with the home line; or press **📶CELL** on the handset to dial with the cell line.

## Edit a directory entry

---

1. Search for the desired entry in the directory (see **Review the directory** and **Search by name** on page 38).
2. When a desired directory entry displays, press **MENU/SELECT**. The handset displays **Enter number**.
3. Use the dialing keys to edit the number.
  - Press **▼CID** or **▲DIR** to move the cursor to the left or right.
  - Press **MUTE/DELETE** on the handset to erase a digit.
  - Press and hold **MUTE/DELETE** on the handset to erase all digits.
  - Press and hold **REDIAL/PAUSE** to insert a three-second dialing pause (a **P** appears).
4. Press **MENU/SELECT** to move on to the name. The handset displays **Enter name**.
5. Use the dialing keys to edit the name.
  - Press **▼CID** or **▲DIR** to move the cursor to the left or right.
  - Press **0** to add a space.
  - Press **MUTE/DELETE** on the handset to erase a character.
  - Press and hold **MUTE/DELETE** on the handset to erase all characters.
  - Press **-tone X** to change the next letter to upper or lower case.
6. Press **MENU/SELECT** to confirm.

## Delete a directory entry

---

1. Search for the desired entry in the directory (see **Review the directory** and **Search by name** on page 38).
2. When the desired entry displays, press **MUTE/DELETE** on the handset. The handset displays **Delete entry?**
3. Press **MENU/SELECT** to confirm. The handset displays **Deleting...** You hear a confirmation tone. You cannot retrieve a deleted entry.

## Delete all directory entry

---

1. Press **MENU/SELECT** when the handset is not in use.
2. Press **▼CID** or **▲DIR** to scroll to **Directory**, then press **MENU/SELECT**.
3. Press **▼CID** or **▲DIR** to highlight **Delete all**, then press **MENU/SELECT**.
4. The handset displays **Delete all?**. Press **MENU/SELECT** to confirm.

## Caller ID

# Caller ID

This product supports caller ID services provided by most telephone service providers. The telephone stores caller ID information about the last 50 incoming calls. This information is common to all handsets.

### **Missed (new) call indicator**

---

When a cordless handset is in idle mode and has new or missed calls, its screen shows **XX Missed calls**.

All new and missed entries are counted as missed calls. Each time you review a new caller ID log entry (indicated by **NEW** on the screen), the missed calls message goes away. When there is a new unanswered call, the missed calls message displays again. The number of missed calls includes all new and missed entries that have not been reviewed.

If you do not want to review the missed calls one by one, but still want to keep them in the caller ID log, you can press and hold  **OFF/CANCEL** on the handset for four seconds when the handset is not in use.

### **Review the caller ID log**

---

Review the caller ID log to find out who called, to easily return a call, or to copy the caller's name and number into your directory.

1. When a handset is in idle mode, press **▼CID** to review the caller ID log in reverse chronological order starting with the most recent call.
2. Press **▼CID** or **▲DIR** to scroll through the list.

### **View dialing options**

---

While reviewing the caller ID log, press **#** (pound key) repeatedly to show different dialing options for local and long distance numbers before dialing or saving the telephone number in the directory.

Press **1** repeatedly if you need to add or remove 1 in front of the telephone number before dialing or saving it in the directory.

When the number shows the correct format for dialing:

- › Press  **HOME/FLASH**, or  **SPEAKER** on the handset to call the number using the home line.

**- OR -**

- › Press  **CELL** on the handset to call the number using the cell line.

## Caller ID operation

### Dial a caller ID log entry

---

1. Search for the desired entry in the caller ID log (see **Review the caller ID log** on page 40).
2. When the desired entry is displayed and is in the correct format for dialing:
  - ▶ Press **HOME/FLASH** or **SPEAKER** on the handset to dial with the home line.
  - OR -
  - ▶ Press **CELL** on the handset to dial with the cell line.

### Save a caller ID log entry to the directory

---

1. Search for the desired entry in the caller ID log (see **Review the caller ID log** on page 40).
2. When the desired entry appears, press **#** (pound key) repeatedly to show different dialing options, if necessary.
3. When the number is in the correct format, press **MENU/SELECT**.
4. Press **MENU/SELECT** to select **To Directory**.
5. Use the dialing keys to edit the number, if necessary.
  - ▶ Press **▼CID** or **▲DIR** to move the cursor to the left or right.
  - ▶ Press **MUTE/DELETE** on the handset to erase a digit.
  - ▶ Press and hold **MUTE/DELETE** on the handset to erase all digits.
  - ▶ Press and hold **REDIAL/PAUSE** to insert a three-second dialing pause (a **P** appears).
6. Press **MENU/SELECT** to move to the name.
7. Use the dialing keys to edit the name.
  - ▶ Press **▼CID** or **▲DIR** to move the cursor to the left or right.
  - ▶ Press **MUTE/DELETE** on the handset to erase a character.
  - ▶ Press and hold **MUTE/DELETE** on the handset to erase all characters.
  - ▶ Press **0** to add a space.
  - ▶ Press **tone X** to change the next letter to upper or lower case.
8. Press **MENU/SELECT** to confirm.

## Caller ID operation

### **Save a caller ID log entry to the allow list**

---

1. Select a desired entry in the caller ID log (see **Review the caller ID log** on page 40).
2. When the desired entry appears, press **MENU/SELECT**.
3. Press **▼CID** or **▲DIR** to highlight **To Allow list**, and then press **MENU/SELECT**. The screen displays **Enter number**.
4. Use the dialing keys to edit the number, if necessary.
  - Press **▼CID** or **▲DIR** to move the cursor to the left or right.
  - Press **MUTE/DELETE** on the handset to backspace and erase a digit.
  - Press and hold **MUTE/DELETE** on the handset to erase the entire entry.
  - Press and hold **REDIAL/PAUSE** to insert a dialing pause (a **P** appears).
5. Press **MENU/SELECT**. The handset displays **Enter name**.
6. Use the dialing keys to edit the name.
  - Press **▼CID** or **▲DIR** to move the cursor to the left or right.
  - Press **0** to add a space.
  - Press **MUTE/DELETE** on the handset to erase a character.
  - Press and hold **MUTE/DELETE** on the handset to erase all characters.
  - Press **TONE X** to change the next letter to upper or lower case.
7. Press **MENU/SELECT** to confirm. You hear a confirmation tone.



## Caller ID operation

### **Save a caller ID log entry to the block list**

---

1. Select a desired entry in the caller ID log (see **Review the caller ID log** on page 40).
2. When the desired entry appears, press **MENU/SELECT**.
3. Press **▼CID** or **▲DIR** to highlight **To Block list**, and then press **MENU/SELECT**. The screen displays **Enter number**.
4. Use the dialing keys to edit the number, if necessary.
  - Press **▼CID** or **▲DIR** to move the cursor to the left or right.
  - Press **MUTE/DELETE** on the handset to backspace and erase a digit.
  - Press and hold **MUTE/DELETE** on the handset to erase the entire entry.
  - Press and hold **REDIAL/PAUSE** to insert a dialing pause (a **P** appears).
5. Press **MENU/SELECT**. The handset displays **Enter name**.
6. Use the dialing keys to edit the name.
  - Press **▼CID** or **▲DIR** to move the cursor to the left or right.
  - Press **0** to add a space.
  - Press **MUTE/DELETE** on the handset to erase a character.
  - Press and hold **MUTE/DELETE** on the handset to erase all characters.
  - Press **TONE X** to change the next letter to upper or lower case.
7. Press **MENU/SELECT** to confirm. You hear a confirmation tone.

### **Save a caller ID log entry to the star name list**

---

1. Select a desired entry in the caller ID log (see **Review the caller ID log** on page 40).
2. When the desired entry appears, press **MENU/SELECT**.
3. Press **▼CID** or **▲DIR** to highlight **To Star name**, and then press **MENU/SELECT**. The screen displays **Star the name?**.
4. Press **MENU/SELECT** to confirm. You hear a confirmation tone.

## Delete caller ID log entries

---

### To delete an entry:

1. Search for the desired entry in the caller ID log (see **Review the caller ID log** on page 40).
2. When the desired entry is displayed, press **MUTE/DELETE** on the handset. You hear a confirmation tone.

### To delete all entries:

1. Press **MENU/SELECT** on the handset in idle mode.
2. Press **▼CID** or **▲DIR** to highlight **Caller ID log**, then press **MENU/SELECT**.
3. Press **▼CID** or **▲DIR** to highlight **Delete all**, then press **MENU/SELECT**.
4. When the screen shows **Delete all?**, press **MENU/SELECT** to confirm. There is a confirmation tone and the screen returns to the previous menu.

## About Smart call blocker\*

If you have subscribed to caller ID service, then you can use Smart call blocker to screen robocalls, telemarketing calls and unwanted calls for you, while allowing welcome calls to get through.†

† The screening feature of Smart call blocker is applicable to home calls only. All incoming cell calls will get through and ring.

You can set up your lists of welcome callers and unwelcome callers. Smart call blocker allows calls from your welcome callers to get through, and it blocks calls from your unwelcome callers.

For other unknown home calls, you can allow these calls, block these calls, or forward these calls to the answering system.

With some easy configurations, you can set to only filter robocalls by asking the callers to press the pound key (#) before the calls are put through to you.

You can also set Smart call blocker to screen incoming home calls by asking the callers to record their names and press the pound key (#). After your caller completes the request, your telephone rings and announces the caller's name. You can then choose to block or answer the call, or you can forward the call to the answering system. If the caller does not respond or record his/her name, the call is blocked from ringing through. When you add your welcome callers to your directory or allow list, they will bypass all screening and ring directly to your handsets.



### Notes:

- ▶ Smart call blocker is on, once you install your telephone. It allows all incoming calls to get through and ring by default. You can change the Smart call blocker settings to screen incoming calls. For more details, see **Set profile** (page 49).
- ▶ With call screening active, Smart call blocker screens and filters all incoming home calls from numbers or names that are not yet saved in your directory, allow list, block list, or star name list. You can easily add incoming phone numbers to your allow list and block list. This allows you to build up your lists of allowed and blocked numbers, and Smart call blocker will know how to deal with these calls when they come in again.
- ▶ To turn off Smart call blocker, see **Set Smart call blocker on/off** on page 49.

\* Includes licenced Qaltel™ technology.

Qaltel™ is a trademark of Truecall Group Limited.

# About Smart call blocker

## Call categories

---

Calls are classified into four categories:

### Welcome calls

Welcome calls are calls with telephone numbers saved in your allow list or directory, and not in your block list. Welcome calls also include calls with caller names saved in your star name list.



Notes:

- ▶ All incoming calls on your cell line will get through and ring, unless the caller's numbers are saved in your block list. If you want to block a cell call, add the number to the block list. See **Block list** on page 50.
- ▶ There are many organizations like schools, medical offices, and pharmacies that use robocalls to communicate important information to you. Robocall uses an autodialer to deliver pre-recorded messages. By entering the name of the organizations into the star name list, it ensures these calls will ring through when you only know the caller names but not their numbers.

### Unwelcome calls

Unwelcome calls are calls with telephone numbers saved in your block list, and you want to block their calls.

### Calls without numbers (for home calls only)

Calls without numbers are calls that are “out of area” or with numbers set to “Private”.

### Uncategorized calls (for home calls only)

Uncategorized calls include calls with absent caller ID number, calls with numbers that are not in your directory, allow list, or block list, or calls with caller ID names that are not in your star name list.



Note: The allow list stores up to 200 entries, the block list stores up to 1,000 entries, and the star name list stores up to 10 names.

# About Smart call blocker

## Call handling

---

- ▶ Smart call blocker is set to on, and to allow all incoming calls by default. When Smart call blocker is on, the first ring of all incoming calls will be muted.
- ▶ If your directory, allow list, star name list and block list are empty when Smart call blocker is on, and you have set to screen calls, the telephone will screen all incoming home calls and asks callers to announce their names or press the pound key (#).
- ▶ If Smart call blocker is off, all incoming home and cell calls ring, including numbers saved in the block list.
- ▶ If **QUIET** mode is on, and Smart call blocker is on and in screening mode, all screened home calls will be sent to the answering system after screening.

Smart call blocker handles calls in the following ways:

Call category		Call handling / Set profile options
<b>Welcome calls</b>	<ul style="list-style-type: none"> <li>▶ Numbers saved in allow list.</li> <li>▶ Numbers saved in directory.</li> <li>▶ Numbers not found in block list.</li> <li>▶ Caller ID names saved in star name list.</li> </ul>	<ul style="list-style-type: none"> <li>▶ The telephone rings when there is an incoming home call with number saved in your allow list or directory, but not in your block list. Robocalls with caller names saved in your star name list will also ring.</li> <li>▶ All incoming calls on your cell line will get through and ring.</li> </ul>
<b>Unwelcome calls</b>	<ul style="list-style-type: none"> <li>▶ Numbers saved in block list.</li> </ul>	The telephone does not ring when there is an incoming call with number saved in your block list, and the call will be rejected.

# About Smart call blocker

Call category		Call handling / Set profile options
<b>Unknown calls (for home calls only)</b>	<ul style="list-style-type: none"> <li>▸ Calls without numbers                             <ul style="list-style-type: none"> <li>- Numbers that are “out of area” or set to “Private”.</li> </ul> </li> </ul>	<p>You can select one of the following five profile options for handling all unknown home calls.</p> <p><b>Screen unknown</b> The telephone plays the screening announcement, and then ask the caller to say his/her name before the call rings on your telephone. You can then answer the call, and hear the caller’s name announced. You can decide whether to accept or reject the call, or to forward the call to the answering system.</p> <p><b>Screen robot</b> The telephone plays the screening announcement, and then ask the caller to press the pound key (#) before the call rings on your telephone. You can then answer the call.</p> <p><b>Allow unknown</b> (default settings) The telephone allows these calls to get through and ring. The caller’s number, even if it is available, will not be saved to the allow list.</p> <p><b>Unknown to answering system</b> The telephone forwards these calls to the answering system without ringing.</p> <p><b>Block unknown</b> The telephone rejects these calls with block announcement without ringing. The caller’s number, even if it’s available, will not be saved to the block list.</p>
	<ul style="list-style-type: none"> <li>▸ Uncategorized calls                             <ul style="list-style-type: none"> <li>- With absent caller ID number.</li> <li>- Numbers not found in directory.</li> <li>- Numbers not found in allow list.</li> <li>- Numbers not found in block list.</li> <li>- With caller ID names not found in star name list</li> </ul> </li> </ul>	



Note: You can set to screen, allow, or block all unknown home calls without numbers, or unknown home calls with numbers not saved in your directory, allow list or star name list. You can also send these calls to the answering system. **Allow unknown** is the default profile setting. To change the setting, see **Set profile** on page 49.

## Call block settings

### Set Smart call blocker on/off

---

The Smart call blocker feature is set to on by default.

1. Press **CALL BLOCK** to enter the main menu when the handset is not in use.

**-OR-**

Press **MENU/SELECT** to enter the main menu when the handset is not in use. Press **▼CID** or **▲DIR** to scroll to **Smart call blk**, then press **MENU/SELECT**.

2. Press **MENU/SELECT** again to select **SCB On/Off**.
3. Press **▼CID** or **▲DIR** to highlight **On** or **Off**, then press **MENU/SELECT** to save the setting. You hear a confirmation tone.

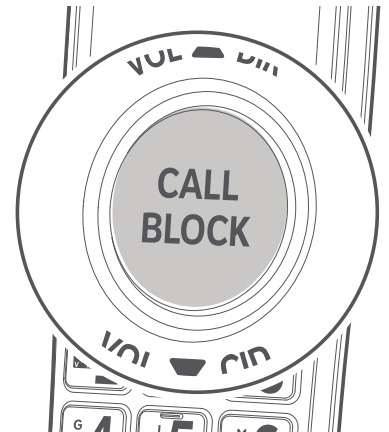

Note: If you set **SCB On/Off** to **Off**, all settings under **Set profile** (see below) will be invalid.

### Set profile

---

There are five profile setting options, which allows you to quickly set up Smart call blocker.

1. Press **CALL BLOCK** to enter the main menu when the handset is not in use.  
**-OR-**  
Press **MENU/SELECT** to enter the main menu when the handset is not in use. Press **▼CID** or **▲DIR** to scroll to **Smart call blk**, then press **MENU/SELECT**.
2. Press **▼CID** or **▲DIR** to scroll to **Set profile**, then press **MENU/SELECT**.
3. Press **▼CID** or **▲DIR** to select one of the following options, then press **MENU/SELECT**.
  - **Screen unknown** - screen any home calls without numbers or with numbers not saved in the directory, allow list, or star name list.
    - This profile setting sets the telephone to screen all unknown home calls and asks the callers to say their names before putting the calls through to you. See **Screen unknown home calls** on page 67.
  - **Screen robot** - screen robocalls.
    - This profile setting sets the telephone to screen all unknown home calls and asks the callers to press the pound key (**#**) before putting the calls through to you. See **Screen robocalls** on page 70.

## Call block settings

- ▶ **Allow unknown** (default setting) - allow all unknown home calls to ring, except calls with numbers saved in the block list.
  - This profile setting sets the telephone to allow all unknown home calls to get through and ring. Calls with numbers saved in the block list will be rejected.
- ▶ **UnknownToAns.S** - forward all unknown home calls to the answering system.
  - This profile setting sets the telephone to forward all unknown home calls to the answering system.
- ▶ **Block unknown** - block all unknown home calls.
  - This profile setting sets the telephone to block all unknown home calls.

After selecting a profile setting, make sure you have not turned off Smart call blocker. Refer to the **Set Smart call blocker on/off** section (page 49) to it on.



Notes:

- ▶ If you set **SCB On/Off** to **Off**, selected setting under **Set profile** will be invalid, and all incoming home and cell calls will ring, including calls with numbers in your block list.
- ▶ There may be robocalls that you do not want to miss. For example, robocalls with announcements or notices from schools or pharmacies. You can set up your star name list with these caller names to allow their calls to get through to you. See **Star name list** on page 59.

### Block list

---

Add numbers that you want to prevent their calls from ringing through. The block list stores up to 1,000 entries.



Note: Home or cell calls with numbers that have been added to your block list will be blocked.

### Add a block entry:

1. Press **CALL BLOCK** to enter the main menu when the handset is not in use.  
**-OR-**  
Press **MENU/SELECT** to enter the main menu when the handset is not in use.  
Press **▼CID** or **▲DIR** to scroll to **Smart call blk**, then press **MENU/SELECT**.
2. Press **▼CID** or **▲DIR** to scroll to **Block list**, and then press **MENU/SELECT**.
3. Press **▼CID** or **▲DIR** to scroll to **Add new entry**, then press **MENU/SELECT**.



## Call block settings

4. When the screen displays **Enter number**, use the dialing keys to enter a number (up to 30 digits).
  - Press **▼CID** or **▲DIR** to move the cursor to the left or right.
  - Press **MUTE/DELETE** on the handset to erase a digit.
  - Press and hold **MUTE/DELETE** on the handset to erase all digits.
  - Press and hold **REDIAL/PAUSE** to enter a three-second dialing pause (a **P** appears).

**-OR-**

Copy a number from the redial list by pressing **REDIAL/PAUSE**. Then, press **▼CID** or **▲DIR** or **REDIAL/PAUSE** repeatedly to find the desired number. Press **MENU/SELECT** to copy the number.
5. Press **MENU/SELECT** to move on to the name.
  - The screen shows **Number repeated** if the number is already in the block list. You cannot save the same number twice.
6. When the screen displays **Enter name**, use the dialing keys to enter a name (up to 15 characters). Press a key repeatedly until the desired character appears. The first character of every word is capitalized.
  - Press **▼CID** or **▲DIR** to move the cursor to the left or right.
  - Press **0** to add a space.
  - Press **MUTE/DELETE** on the handset to erase a character.
  - Press and hold **MUTE/DELETE** on the handset to erase all characters.
  - Press **TONE X** to change the next letter to upper or lower case.
7. Press **MENU/SELECT** to store your block entry.



### Notes:

- Numbers saved in your directory can also be saved to the block list.
- If you save a block entry that has already been saved to the allow list, the entry in the allow list will be removed.

## Smart call blocker

# Call block settings

### Review block list:

1. Press **CALL BLOCK** to enter the main menu when the handset is not in use.  
**-OR-**  
Press **MENU/SELECT** to enter the main menu when the handset is not in use.  
Press **▼CID** or **▲DIR** to scroll to **Smart call blk**, then press **MENU/SELECT**.
2. Press **▼CID** or **▲DIR** to scroll to **Block list**, and then press **MENU/SELECT**.
3. Press **MENU/SELECT** to choose **Review**.
4. Press **▼CID** or **▲DIR** to browse through the block entries.



Note: **List empty** appears if there are no block entries.

### Save a caller ID log entry to block list:

1. Search for the desired caller ID log entry (see **Review the caller ID log** on page 40).
2. When the desired entry displays, press **MENU/SELECT**.
3. Press **▼CID** or **▲DIR** to scroll to **To Block list**, then press **MENU/SELECT**.
4. The handset displays **Enter number**. Use the dialing keys to edit the number, when necessary.
  - ▶ Press **▼CID** or **▲DIR** to move the cursor to the left or right.
  - ▶ Press **MUTE/DELETE** on the handset to backspace and erase a digit.
  - ▶ Press and hold **MUTE/DELETE** to erase the entire entry.
  - ▶ Press and hold **REDIAL/PAUSE** to insert a three-second dialing pause (a **P** appears).
5. Press **MENU/SELECT** to move to the name. The screen displays **Enter name**.
6. Use the dialing keys to add or edit the name.
  - ▶ Press **▼CID** or **▲DIR** to move the cursor to the left or right.
  - ▶ Press **0** to add a space.
  - ▶ Press **MUTE/DELETE** to erase a character.
  - ▶ Press and hold **MUTE/DELETE** to erase all characters.
  - ▶ Press **TONE X** to change the next letter to upper or lower case.
7. Press **MENU/SELECT** when done.

## Call block settings

### Edit a block entry:

1. Search for the desired entry in the block list (see **Review block list** on page 52).
2. When the desired entry displays, press **MENU/SELECT**. The screen displays **Enter number** along with the phone number to be edited. If you only want to edit the name, skip to Step 4.
3. To edit the number:
  - Use the dialing keys to enter digits.
  - Press **▼CID** or **▲DIR** to move the cursor to the left or right.
  - Press **MUTE/DELETE** on the handset to erase a digit.
  - Press and hold **MUTE/DELETE** to erase all digits.
  - Press and hold **REDIAL/PAUSE** to enter a three-second dialing pause (a **P** appears).
4. Press **MENU/SELECT** to move on to the name. The screen displays **Enter name** along with the name to be edited.
5. To edit the name:
  - Use the dialing keys to enter characters.
  - Press **▼CID** or **▲DIR** to move the cursor to the left or right.
  - Press **0** to add a space.
  - Press **MUTE/DELETE** to erase a character.
  - Press and hold **MUTE/DELETE** to erase all characters.
  - Press **TONE X** to change the next letter to upper or lower case.
6. Press **MENU/SELECT** to save the entry.

## Call block settings

### Delete a block entry:

1. Search for the desired entry in the block list (see **Review block list** on page 52).
2. When the desired entry displays, press **MUTE/DELETE** on the handset. The screen shows **Delete entry?**.
3. Press **MENU/SELECT** to confirm. The screen show **Deleting...** You hear a confirmation tone. You cannot retrieve a deleted entry.

### Delete all block list entries:

1. Press **CALL BLOCK** to enter the main menu when the handset is not in use.  
**-OR-**  
Press **MENU/SELECT** to enter the main menu when the handset is not in use. Press **▼CID** or **▲DIR** to scroll to **Smart call blk**, then press **MENU/SELECT**.
2. Press **▼CID** or **▲DIR** to scroll to **Block list**, and then press **MENU/SELECT**.
3. Press **▼CID** or **▲DIR** to highlight **Delete all**, then press **MENU/SELECT**. The screen shows **Delete all?**.
4. Press **MENU/SELECT** again to confirm. The screen displays **Deleting...** There is a confirmation tone.

## Call block settings

### Allow list

---

Add numbers that you want to allow their calls to get through to you. The allow list stores up to 200 entries.

#### Add an allow entry:

1. Press **CALL BLOCK** to enter the main menu when the handset is not in use.  
**-OR-**  
Press **MENU/SELECT** to enter the main menu when the handset is not in use. Press **▼CID** or **▲DIR** to scroll to **Smart call blk**, then press **MENU/SELECT**.
2. Press **▼CID** or **▲DIR** to scroll to **Allow list**, and then press **MENU/SELECT**.
3. Press **▼CID** or **▲DIR** to scroll to **Add new entry**, then press **MENU/SELECT**.
4. When the screen displays **Enter number**, use the dialing keys to enter a number (up to 30 digits).
  - ▶ Press **▼CID** or **▲DIR** to move the cursor to the left or right.
  - ▶ Press **MUTE/DELETE** to erase a digit.
  - ▶ Press and hold **MUTE/DELETE** to erase all digits.
  - ▶ Press and hold **REDIAL/PAUSE** to enter a three-second dialing pause (a **P** appears).**-OR-**  
Copy a number from the redial list by pressing **REDIAL/PAUSE**. Then, press **▼CID**, **▲DIR** or **REDIAL/PAUSE** repeatedly to find the desired number. Press **MENU/SELECT** to copy the number.
5. Press **MENU/SELECT** to move on to the name.
  - ▶ The display shows **Number repeated** if the number is already in the allow list. You cannot save the same number twice.
6. When the screen displays **Enter name**, use the dialing keys to enter a name (up to 15 characters). Press a key repeatedly until the desired character appears. The first character of every word is capitalized.
  - ▶ Press **▼CID** or **▲DIR** to move the cursor to the left or right.
  - ▶ Press **0** to add a space.
  - ▶ Press **MUTE/DELETE** to erase a character.
  - ▶ Press and hold **MUTE/DELETE** to erase all characters.
  - ▶ Press **tone X** to change the next letter to upper or lower case.
7. Press **MENU/SELECT** to store your allow entry.

## Smart call blocker

# Call block settings



### Notes:

- ▶ Numbers saved in your directory can also be saved to the allow list.
- ▶ If you save an allow list entry that has already been saved to the block list, the entry in the block list will be removed.

### Review allow list:

1. Press **CALL BLOCK** to enter the main menu when the handset is not in use.  
**-OR-**  
Press **MENU/SELECT** to enter the main menu when the handset is not in use.  
Press **▼CID** or **▲DIR** to scroll to **Smart call blk**, then press **MENU/SELECT**.
2. Press **▼CID** or **▲DIR** to scroll to **Allow list**, and then press **MENU/SELECT**.
3. Press **MENU/SELECT** to choose **Review**.
4. Press **▼CID** or **▲DIR** to browse through the allow entries.



Note: **List empty** appears if there are no allow entries.

### Save a caller ID log entry to allow list:

1. Search for the desired caller ID log entry (see **Review the caller ID log** on page 40).
2. When the desired entry displays, press **MENU/SELECT**.
3. Press **▼CID** or **▲DIR** to scroll to **To Allow list**, then press **MENU/SELECT**.
4. The handset displays **Enter number**. Use the dialing keys to edit the number, when necessary.
  - ▶ Press **▼CID** or **▲DIR** to move the cursor to the left or right.
  - ▶ Press **MUTE/DELETE** on the handset to backspace and erase a digit.
  - ▶ Press and hold **MUTE/DELETE** to erase the entire entry.
  - ▶ Press and hold **REDIAL/PAUSE** to insert a three-second dialing pause (a **P** appears).
5. Press **MENU/SELECT** to move to the name. The screen displays **Enter name**.

## Call block settings

6. Use the dialing keys to add or edit the name.
  - Press **▼CID** or **▲DIR** to move the cursor to the left or right.
  - Press **0** to add a space.
  - Press **MUTE/DELETE** to erase a character.
  - Press and hold **MUTE/DELETE** to erase all characters.
  - Press **-tone X** to change the next letter to upper or lower case.
7. Press **MENU/SELECT** when done. You hear a confirmation tone.

### Edit an allow entry:

1. Search for the desired entry in the allow list (see **Review allow list** on page 56).
2. When the desired entry displays, press **MENU/SELECT**. The screen displays **Enter number** along with the phone number to be edited. If you only want to edit the name, skip to Step 4.
3. To edit the number:
  - Use the dialing keys to enter digits.
  - Press **▼CID** or **▲DIR** to move the cursor to the left or right.
  - Press **MUTE/DELETE** on the handset to erase a digit.
  - Press and hold **MUTE/DELETE** to erase all digits.
  - Press and hold **REDIAL/PAUSE** to enter a three-second dialing pause (a **P** appears).
4. Press **MENU/SELECT** to move on to the name. The screen displays **Enter name** along with the name to be edited.
5. To edit the name:
  - Use the dialing keys to enter characters.
  - Press **▼CID** or **▲DIR** to move the cursor to the left or right.
  - Press **0** to add a space.
  - Press **MUTE/DELETE** to erase a character.
  - Press and hold **MUTE/DELETE** to erase all characters.
  - Press **-tone X** to change the next letter to upper or lower case.
6. Press **MENU/SELECT** to save the entry. You hear a confirmation tone.

## Call block settings

### Delete an allow entry:

1. Search for the desired entry in the allow list (see **Review allow list** on page 56).
2. When the desired entry displays, press **MUTE/DELETE** on the handset. The screen shows **Delete entry?**
3. Press **MENU/SELECT** to confirm. The screen show **Deleting...**, and the next entry displays. You cannot retrieve a deleted entry.

### Delete all allow entries:

1. Press **CALL BLOCK** to enter the main menu when the handset is not in use.  
**-OR-**  
Press **MENU/SELECT** to enter the main menu when the handset is not in use. Press **▼CID** or **▲DIR** to scroll to **Smart call blk**, then press **MENU/SELECT**.
2. Press **▼CID** or **▲DIR** to scroll to **Allow list**, and then press **MENU/SELECT**.
3. Press **▼CID** or **▲DIR** to highlight **Delete all**, then press **MENU/SELECT**. The screen shows **Delete all?**
4. Press **MENU/SELECT** again to confirm. The screen displays **Deleting...** There is a confirmation tone.



## Call block settings

### **Star name list**

---

There are many organizations like schools, medical offices, and pharmacies that use robocalls to communicate important information to you. Robocall uses an autodialer to deliver pre-recorded messages. By entering the name of the organizations into the star name list, it ensures these calls will ring through when you only know the caller names but not their numbers.

If the first 15 characters of the incoming caller ID's name match a name saved in your star name list, the call will get through and ring. The star name list stores up to 10 names.

#### **Add a star name entry:**

1. Press **CALL BLOCK** to enter the main menu when the handset is not in use.  
**-OR-**  
Press **MENU/SELECT** to enter the main menu when the handset is not in use. Press **▼CID** or **▲DIR** to scroll to **Smart call blk**, then press **MENU/SELECT**.
2. Press **▼CID** or **▲DIR** to scroll to **Star name list**, and then press **MENU/SELECT**.
3. Press **▼CID** or **▲DIR** to scroll to **Add new entry**, then press **MENU/SELECT**.
4. When the screen displays **Enter name**, use the dialing keys to enter a name (up to 15 characters). Press a key repeatedly until the desired character appears. The first character of every word is capitalized.
  - Press **▼CID** or **▲DIR** to move the cursor to the left or right.
  - Press **0** to add a space.
  - Press **MUTE/DELETE** to erase a character.
  - Press and hold **MUTE/DELETE** to erase all characters.
  - Press **TONE X** to change the next letter to upper or lower case.
5. Press **MENU/SELECT** to store your star name entry. The display shows **Name repeated** if the name is already in the star name list. You cannot save the same name twice.

## Call block settings

### Review star name list:

1. Press **CALL BLOCK** to enter the main menu when the handset is not in use.  
**-OR-**  
Press **MENU/SELECT** to enter the main menu when the handset is not in use.  
Press **▼CID** or **▲DIR** to scroll to **Smart call blk**, then press **MENU/SELECT**.
2. Press **▼CID** or **▲DIR** to scroll to **Star name list**, and then press **MENU/SELECT**.
3. Press **MENU/SELECT** to choose **Review**.
4. Press **▼CID** or **▲DIR** to browse through the star name entries.



Note: **List empty** appears if there are no star name entries.

### Save a caller ID log entry to star name list:

1. Search for the desired caller ID log entry (see **Review the caller ID log** on page 40).
2. When the desired entry displays, press **MENU/SELECT**.
3. Press **▼CID** or **▲DIR** to scroll to **To Star name**, then press **MENU/SELECT**.
4. The handset displays **Star this name?**.
5. Press **MENU/SELECT** to confirm. You hear a confirmation tone.

### Edit a star name entry:

1. Search for the desired entry in the allow list (see **Review star name list** on this page).
2. When the desired entry displays, press **MENU/SELECT**. The screen displays **Enter name** along with the name to be edited.
3. To edit the name:
  - Use the dialing keys to enter characters.
  - Press **▼CID** or **▲DIR** to move the cursor to the left or right.
  - Press **0** to add a space.
  - Press **MUTE/DELETE** to erase a character.
  - Press and hold **MUTE/DELETE** to erase all characters.
  - Press **-tone X** to change the next letter to upper or lower case.
4. Press **MENU/SELECT** to save the entry. You hear a confirmation tone.

## Call block settings

### Delete a star name entry:

1. Search for the desired entry in the allow list (see **Review star name list** on page 60).
2. When the desired entry displays, press **MUTE/DELETE** on the handset. The screen shows **Delete entry?**.
3. Press **MENU/SELECT** to confirm. The screen show **Deleting...**, and the next entry displays. You cannot retrieve a deleted entry.

### Delete all star name entries:

1. Press **CALL BLOCK** to enter the main menu when the handset is not in use.  
**-OR-**  
Press **MENU/SELECT** to enter the main menu when the handset is not in use. Press **▼CID** or **▲DIR** to scroll to **Smart call blk**, then press **MENU/SELECT**.
2. Press **▼CID** or **▲DIR** to scroll to **Star name list**, and then press **MENU/SELECT**.
3. Press **▼CID** or **▲DIR** to highlight **Delete all**, then press **MENU/SELECT**. The screen shows **Delete all?**.
4. Press **MENU/SELECT** again to confirm. The screen displays **Deleting...** There is a confirmation tone.

## **Screening announcements**

---

If you have set profile to screen all unknown home calls (**Screen unknown**) or screen robocalls (**Screen robot**), the callers of the following incoming call categories will hear a screening announcement.

- ▶ Home calls that are “out of area“ or with numbers set to “Private“.
- ▶ Home calls with numbers that are not on your directory, allow list, or block list, or with absent caller ID number.
- ▶ Home calls with caller ID names that are not on your star name list.

There are two default screening announcements for screening unknown calls and screening robocalls on home line.

**Screening with caller name** - *“Hello. Calls to this number are being screened by Smart call blocker. Please say your name after the tone, then press pound.”*

- This default announcement is played if you have set profile to screen all unknown home calls.

-OR-

**Screening without caller name** - *“Hello. Calls to this number are being screened by Smart call blocker. If you’re a family member, friend or invited caller, please press pound to be connected. If you’re a solicitor, please hang up now.”*

- This default announcement is played if you have set profile to screen robocalls on home line.

You can use these announcements, or record your own name to replace “*this number*” in the announcements. Please refer to **Record your name for all screening announcements** on page 63.



Note: For details of Smart call blocker’s profile setting, see **Set profile** on page 49.

## Call block settings

### Play your current announcement of screening with caller name:

1. Press **CALL BLOCK** to enter the main menu when the handset is not in use.  
**-OR-**  
Press **MENU/SELECT** to enter the main menu when the handset is not in use.  
Press **▼CID** or **▲DIR** to scroll to **Smart call blk**, then press **MENU/SELECT**.
2. Press **▼CID** or **▲DIR** to scroll to **Screening annc**, then press **MENU/SELECT**.
3. Press **▼CID** or **▲DIR** to scroll to **Play annc**, then press **MENU/SELECT**.
4. Press **MENU/SELECT** again to select **w/ Caller name**.

### Play your current announcement of screening without caller name:

1. Press **CALL BLOCK** to enter the main menu when the handset is not in use.  
**-OR-**  
Press **MENU/SELECT** to enter the main menu when the handset is not in use.  
Press **▼CID** or **▲DIR** to scroll to **Smart call blk**, then press **MENU/SELECT**.
2. Press **▼CID** or **▲DIR** to scroll to **Screening annc**, then press **MENU/SELECT**.
3. Press **▼CID** or **▲DIR** to scroll to **Play annc**, then press **MENU/SELECT**.
4. Press **▼CID** or **▲DIR** to scroll to **w/o Caller name**, then press **MENU/SELECT**.

### Record your name for all screening announcements:

1. Press **CALL BLOCK** to enter the main menu when the handset is not in use.  
**-OR-**  
Press **MENU/SELECT** to enter the main menu when the handset is not in use.  
Press **▼CID** or **▲DIR** to scroll to **Smart call blk**, then press **MENU/SELECT**.
2. Press **▼CID** or **▲DIR** to scroll to **Screening annc**, then press **MENU/SELECT**.
3. Press **MENU/SELECT** to select **Rec your name**. The system announces,  
*“Record after the tone. Press 5 when you are done.”*
4. Speak towards the handset to record your name. Press **5** to end recording.

To listen to the announcement with your recorded name again, scroll to **Play annc** and press **MENU/SELECT**.

## Call block settings

### **Reset all your screening announcements:**

1. Press **CALL BLOCK** to enter the main menu when the handset is not in use.  
**-OR-**  
Press **MENU/SELECT** to enter the main menu when the handset is not in use.  
Press **▼CID** or **▲DIR** to scroll to **Smart call blk**, then press **MENU/SELECT**.
2. Press **▼CID** or **▲DIR** to scroll to **Screening annnc**, then press **MENU/SELECT**.
3. Press **▼CID** or **▲DIR** to scroll to **Reset annnc**, then press **MENU/SELECT**. The screen shows **Reset annnc?**. Press **MENU/SELECT** again to confirm. The screen shows **Annnc reset.** before returning to the previous menu.

Your name will be deleted from all the screening announcements, and the telephone will use the default screening announcements described on page 62.

## Call block settings

### **Voice guide to set Smart call blocker**

---

This feature is an easy and alternative way for you to do the basic setup of Smart call blocker. You can follow the voice guide to set your telephone system to allow or to screen all incoming home calls, or to screen home calls that do not display a phone number.

1. Press **CALL BLOCK** to enter the main menu when the handset is not in use.  
**-OR-**  
Press **MENU/SELECT** to enter the main menu when the handset is not in use. Press **▼CID** or **▲DIR** to scroll to **Smart call blk**, then press **MENU/SELECT**.
2. Press **▼CID** or **▲DIR** to scroll to **Voice guide**, then press **MENU/SELECT**.
3. You hear a voice prompt *“Hello! This voice guide will assist you with the basic setup of Smart call blocker...”*
4. Set up your Smart call blocker feature by inputting the designated numbers, as instructed in the voice guide.
  - ▶ Press **1** if you want to screen home calls with telephone numbers that are not saved in your directory, allow list or star name list; or
  - ▶ Press **2** if you do not want to screen calls, and want to allow all incoming calls to get through.



#### Notes:

- ▶ The screening feature of Smart call blocker is applicable to home calls only. All incoming cell calls will get through and ring. If you want to block a cell call, add the number to the block list. See **Block list** on page 50.
- ▶ You can press **OFF/CANCEL** to quit the voice guide at any time.
- ▶ After a power outage, the handset prompts you to set the date and time. After the date and time setting is done or skipped, the handset will prompt if you want to set up Smart call blocker via voice guide. Press **MENU/SELECT** to start the setup.

## Smart call blocker

# Allowed calls

If Smart call blocker is on, the following types of incoming calls can get through to you and ring on your telephone system:

- ▶ Home calls with numbers saved in your allow list.
- ▶ Home calls with numbers saved in your directory, but not on your block list.
- ▶ Home calls with caller ID names saved in your star name list.
- ▶ Cell calls with numbers not saved in your block list.



### Notes:

- ▶ When Smart call blocker is off, all incoming home and cell calls will ring on your telephone system, including calls with numbers saved in the block list.
- ▶ **Allow unknown** is the default profile setting. If you have not selected another profile, all unknown home calls will ring. However, the caller's numbers, if available, will not be saved to the allow list. If you want to save the caller's number to your allow list or block list, you can retrieve the number from caller ID log and save it to the allow list or block list. See **Save a caller ID log entry to the block list** on page 52 and **Save a caller ID log entry to the allow list** on page 56. If you want to retrieve the name from caller ID log and save it to the star name list. See **Save a caller ID log entry to the star name list** on page 60.

## Blocked calls

If Smart call blocker is on, incoming home or cell calls with numbers saved in your block list will not ring. The telephone plays the block announcement *"Calls to this number are being screened by Smart call blocker. The number you are calling is not accepting your call. Please hang up."* to the caller, and the call will be terminated.



### Notes:

- ▶ When Smart call blocker is off, all incoming home and cell calls will ring on your telephone system, including calls with numbers saved in the block list.
- ▶ If you have set profile to **Block unknown**, all unknown home calls will be rejected. However, the caller's numbers, if available, will not be saved to the block list. If you want to save the caller's number to the block list, you can retrieve the number from caller ID log and save it to the block list. See **Save a caller ID log entry to the block list** on page 52. You can also retrieve the number and save it to your allow list. See **Save a caller ID log entry to the allow list** on page 56. If you want to retrieve the name from caller ID log and save it to the star name list. See **Save a caller ID log entry to the star name list** on page 60.
- ▶ The telephone can respond to remote access code while it is playing the block announcement. This allows you to access your answering system from an unknown number remotely. See **Remote access** on page 83.



## Screen unknown home calls

If Smart call blocker is on, and you have set profile to screen unknown home calls, the telephone plays a screening announcement to the caller when receiving the following incoming home calls. It asks the caller to respond before putting the call through to you.

- ▶ Incoming home calls with numbers that are “out of area” or with numbers set to “Private“;
- ▶ Incoming home calls with absent caller ID numbers;
- ▶ Incoming home calls with numbers that are not in your directory, allow list, nor block list; or
- ▶ Incoming home calls with names that are not in your star name list.

### Screen calls and ask for caller names

When screening a home call, the telephone announces to the caller, *“Hello. Calls to this number are being screened by Smart call blocker. Please say your name after the tone, then press pound.”* After the caller completes the request, the telephone announces to the caller *“Please wait a moment while your call is connected.”*

The telephone starts ringing and the handset screen displays **Screened call**.

After you pick up the call, the telephone announces the caller’s name, and then asks whether you want to answer or reject the call, or to forward the call to the answering system.



#### Notes:

- ▶ You can set Smart call blocker to screen and filter all unknown home calls. You can easily add incoming phone numbers to your allow list and block list. This allows you to build up your lists of allowed and blocked numbers, and Smart call blocker will know how to deal with these calls when they come in again.
- ▶ The telephone announces to the caller with *“Hello. Calls to this number are being screened by Smart call blocker...”* If you have recorded your name in the screening announcements, your recorded name will replace *“this number”* in the announcements. See **Screening announcement** on page 62.
- ▶ The screening feature of Smart call blocker is applicable to home calls only.
- ▶ If the caller hangs up before the home call is screened, or without leaving his/her name while the call is being screened, the call will be logged as missed call in the caller ID log.
- ▶ While a home call is being screened, you can press **HOME/FLASH** or **SPEAKER** to stop screening and answer the call.
- ▶ After the telephone screened a home call, and is ringing and announcing the caller’s name, you can press **OFF/CANCEL** to mute the ringer, or press **CALL BLOCK** to reject the call directly.
- ▶ After you picked up a screened home call and the telephone is announcing the screening options, you can press **OFF/CANCEL** to hang up the call.

## Screen unknown home calls

- ▶ If Smart call blocker is on and you receive a call waiting home call:
  - Smart call blocker will not screen a call waiting home call without number while on a call. You can press **HOME/FLASH** or **CALL/SPEAKER** to take the new call.
  - After you have picked up a screened home call, the telephone checks whether the call waiting number is in the directory, block list or allow list. It also checks whether the caller name is in the star name list. After that, The telephone then displays the caller ID information or “Blocked call” accordingly. You can press **HOME/FLASH** or **CALL/SPEAKER** to take the new call, or press **CALL BLOCK** on the handset to block it.
  - While the telephone is screening a home call, the new call will be ignored and logged as missed call in the caller ID log.
- ▶ Robocalls are unable to respond to the screening announcement, and therefore, will not get through and ring. If you want to allow some robocalls to get through, save their names in the star name list. See page 59.
- ▶ The telephone can respond to remote access code while it is playing the screening announcement. This allows you to access your answering system from an unknown number remotely. See **Remote access** on page 83.

### Screened call options

---

After the telephone screen a home call and starts ringing, the handset screen displays **Screened call**. Press **HOME/FLASH** or **CALL/SPEAKER** to pick up the call.

After you picked up the call, the telephone announces “*Call from...*” and the caller’s name, and then announces, “*To answer the call, press 1. To answer and always allow this number, press 2. To block this number, press 3. To send this call to the answering system, press 4. To repeat these options, press \**”.

#### **Allow this call once:**

- ▶ Press **1** to answer the call. The telephone number will not be added to your allow list.

#### **Always allow this call:**

- ▶ Press **2** to answer the call. The telephone number will be added to your allow list.

#### **Block this call:**

- ▶ Press **3** or **CALL BLOCK** to block the call. The telephone plays the block announcement “*The number you are calling is not accepting your call. Please hang up.*” to the caller. The telephone number will be added to your block list.

#### **Send this call to the answering system:**

- ▶ Press **4** to forward the call to the answering system.

#### **End this call:**

- ▶ If you do not want to take the call, press **OFF/CANCEL** to end the call.

## Screen unknown home calls



### Notes:

- ▶ For home calls that are “out of area”, “Private”, or without caller ID, only options **1** and **4** will be available. The telephone announces “*To answer the call, press 1. To send this call to the answering system, press 4. To repeat these options, press \**”.
- ▶ If you select option **4** to send the call to the answering system, the caller can leave a message even if the answering system is off.
- ▶ When the telephone is ringing, you can press **MUTE/DELETE** to mute the ringer temporarily.

## Screen robocalls

If Smart call blocker is on, and you have set profile to screen robocalls, the telephone plays a screening announcement to the caller when receiving the following incoming home calls. It asks the caller to press the pound key (#) before putting the call through to you.

- ▶ Incoming home calls with numbers that are “out of area” or with numbers set to “Private”;
- ▶ Incoming home calls with absent caller ID numbers;
- ▶ Incoming home calls with numbers that are not in your directory, allow list, nor block list; or
- ▶ Incoming home calls with names that are not in your star name list.

### Screen calls without asking for caller names

When screening a home call, the telephone announces to the caller, *“Hello. Calls to this number are being screened by Smart call blocker. If you’re a family member, friend or invited caller, please press pound to be connected. If you’re a solicitor, please hang up now.”* After the caller presses the pound key (#), the telephone announces to the caller *“Please wait a moment while your call is connected.”* The telephone starts ringing, and you can answer the call.

This option is suitable for you to filter calls that uses autodialers to deliver pre-recorded messages, for example, robocalls and telemarketing calls.



#### Notes:

- ▶ The telephone announces to the caller with *“Hello. Calls to this number are being screened by Smart call blocker...”* If you have recorded your name in the screening announcements, your recorded name will replace *“this number”* in the announcements. See **Screening announcement** on page 62.
- ▶ The screening feature of Smart call blocker is applicable to home calls only.
- ▶ If the caller hangs up before the home call is screened, or without leaving his/her name while the call is being screened, the call will be logged as missed call in the caller ID log.
- ▶ While a home call is being screened, you can press **HOME/FLASH** or **SPEAKER** to stop screening and answer the call.
- ▶ If Smart call blocker is on and you receive a call waiting home call:
  - Smart call blocker will not screen a call waiting home call without number while on a call. You can press **HOME/FLASH** or **SPEAKER** to take the new call.
  - After you have picked up a screened home call, the telephone checks whether the call waiting number is in the directory, block list or allow list. It also checks whether the caller name is in the star name list. After that, The telephone then displays the caller ID information or “Blocked call” accordingly. You can press **HOME/FLASH** or **SPEAKER** to take the new call, or press **CALL BLOCK** on the handset to block it.
  - While the telephone is screening a home call, the new call will be ignored and logged as missed call in the caller ID log.
- ▶ Robocalls are unable to respond to the screening announcement, and therefore, will not get through and ring. If you want to allow some robocalls on the home line to get through, save their names in the star name list. See page 59.
- ▶ The telephone can respond to remote access code while it is playing the screening announcement. This allows you to access your answering system from an unknown number remotely. See **Remote access** on page 83.

## Option while on a call

When you are on a home or cell call and speaking to the caller, and you do not want to continue the call, you can press **CALL BLOCK** to end the call. The telephone plays the block announcement “*The number you are calling is not accepting your call. Please hang up.*” to the caller, and the call will be terminated. The caller’s number, if available, will be added to your block list.

- › Press **CALL BLOCK** on the handset. The screen displays **Block and end?** and the caller’s number, if available. Press **MENU/SELECT** to end the call.

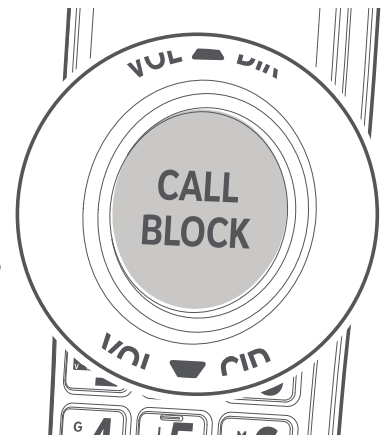

Notes: You can press **CALL BLOCK** on the handset to end the call even if Smart call blocker is turned off.

## Answering system settings

Use the answering system menu of a handset to set up the announcement message, turn on or off the answering system or message alert tone, activate call screening, or change the number of rings, remote access code or message recording time.

### **Announcement**

---

Your outgoing announcement plays when calls are answered by the answering system.

The telephone has a default outgoing announcement, *“Hello, please leave a message after the tone.”* You can use this announcement, or record your own.

#### **To record a new outgoing announcement:**

1. Press **MENU/SELECT** in idle mode.
2. Press **▼CID** or **▲DIR** to scroll to **Answering sys**, then press **MENU/SELECT**.
3. Press **MENU/SELECT** to select **Announcement**.
4. The screen displays **Play [2] Del [3] Rec [7]** and it announces, *“To play, press 2. To record, press 7.”* Press **7** to record. The handset announces, *“Record after the tone. Press 5 when you are done.”*
5. After the tone, speak towards the handset microphone. Press **5** to end recording. The newly recorded announcement automatically plays.

To listen to the recorded announcement again, wait after playback has completed, then press **2**.

#### **To reset your outgoing announcement:**

1. Press **MENU/SELECT** in idle mode.
2. Press **▼CID** or **▲DIR** to scroll to **Answering sys**, then press **MENU/SELECT**.
3. Press **MENU/SELECT** again to select **Announcement**.
4. The screen displays **Play [2] Del [3] Rec [7]** and it announces, *“To play, press 2. To record, press 7.”* Press **3** to delete your recorded announcement. The handset displays **Annc deleted** and announces, *“Announcement deleted.”*

When your announcement is reset, the system answers calls with the default announcement, as described above. You cannot delete the default announcement.

## Answering system settings

### **Answer on/off**

---

If you turn the answering system on, it answers calls and records messages only on the home line. If your paired cell phone has voicemail, callers can leave messages with that voicemail service.

If your answering system is turned off and you change any of its settings, the answering system automatically turns on again.

### **To turn the answering system on or off:**

#### **Using a handset:**

1. Press **MENU/SELECT** in idle mode.
2. Press **▼CID** or **▲DIR** to highlight **Answering sys**, then press **MENU/SELECT**.
3. Press **▼CID** or **▲DIR** to highlight **Answer on/off**, then press **MENU/SELECT**.
4. Press **▼CID** or **▲DIR** to highlight **On** or **Off**, then press **MENU/SELECT** to save.

#### **Using the telephone base:**

- Press **ANS ON** to turn the answering system on or off. When the answering system is turned on, it announces, *“Calls will be answered.”* When the answering system is turned off, it announces, *“Calls will not be answered.”*

## Answering system settings

### **Voice guide to set Answering system**

---

This feature is an alternative way for you to do the basic setup of the answering system. You can follow the voice guide to record your own announcement, set the number of rings, and set the message alert tone.

#### **To use the voice guide feature:**

1. Press **MENU/SELECT** in idle mode.
2. Press **▼CID** or **▲DIR** to highlight **Answering sys**, then press **MENU/SELECT**.
3. Press **▼CID** or **▲DIR** to highlight **Voice guide**, then press **MENU/SELECT**. You hear a voice prompt, *“This voice guide will assist you with the basic setup of your answering system.”*
4. Set up your answering system by inputting designated numbers, as instructed in the voice guide.



Notes:

- ▶ You can press **OFF/CANCEL** on the handset to quit the voice guide at any time.
- ▶ After a power outage, the handset prompts you to set the date and time, and Smart call blocker. After these settings are done or skipped, the handset then prompts if you want to set up the answering system via voice guide. Press **MENU/SELECT** to start the setup.

### **Call screening**

---

Use this feature to choose whether incoming messages can be heard over the telephone base when they are being recorded. If you turn call screening on, you hear the incoming message.

#### **To turn on or off the call screening feature:**

1. Press **MENU/SELECT** in idle mode.
2. Press **▼CID** or **▲DIR** to highlight **Answering sys**, then press **MENU/SELECT**.
3. Press **▼CID** or **▲DIR** to highlight **Ans sys setup**, then press **MENU/SELECT** twice to select **Call screening**.
4. Press **▼CID** or **▲DIR** to choose between **On** and **Off**, then press **MENU/SELECT** to save.



## Answering system settings

### Number of rings

---

You can set the answering system to answer an incoming call after two, three, four, five, or six rings. You can also select toll saver, which is explained below. By default, the answering system answers an incoming call after three rings.

#### To set the number of rings:

1. Press **MENU/SELECT** in idle mode.
2. Press **▼CID** or **▲DIR** to highlight **Answering sys**, then press **MENU/SELECT**.
3. Press **▼CID** or **▲DIR** to highlight **Ans sys setup**, then press **MENU/SELECT**.
4. Press **▼CID** or **▲DIR** to highlight **# of rings**, then press **MENU/SELECT**.
5. Press **▼CID** or **▲DIR** to choose from **6, 5, 4, 3, 2** or **Toll saver**.
  - ▶ Toll saver - the answering system answers a call after two rings when you have new messages, or after four rings when there is no new message. This feature allows you to check for new messages and avoid paying long distance charges when calling from out of your local area.
6. Press **MENU/SELECT** to save.

### Remote access code

---

To access your answering system remotely from any touch-tone phone, you need to enter a two-digit number (00-99). By default, the remote access code is 19.

#### To change the remote access code:

1. Press **MENU/SELECT** in idle mode.
2. Press **▼CID** or **▲DIR** to highlight **Answering sys**, then press **MENU/SELECT**.
3. Press **▼CID** or **▲DIR** to highlight **Ans sys setup**, then press **MENU/SELECT**.
4. Press **▼CID** or **▲DIR** to highlight **Remote code**, then press **MENU/SELECT**.
5. Use the dialing keys to enter a two-digit number.  
**-OR-**  
Press **▼CID** or **▲DIR** to scroll to a desired two-digit number.
6. Press **MENU/SELECT** to confirm.

## Answering system settings

### **Message alert tone**

---

When the message alert tone is set to **On**, and there is at least one new message, the telephone base beeps every 10 seconds. The tone stops when all new messages have been reviewed. By default, the message alert tone is **Off**.

#### **To turn on or off the message alert tone:**

1. Press **MENU/SELECT** in idle mode.
2. Press **▼CID** or **▲DIR** to highlight **Answering sys**, then press **MENU/SELECT**.
3. Press **▼CID** or **▲DIR** to highlight **Ans sys setup**, then press **MENU/SELECT**.
4. Press **▼CID** or **▲DIR** to highlight **Msg alert tone**, then press **MENU/SELECT**.
5. Press **▼CID** or **▲DIR** to choose **On** or **Off**, then press **MENU/SELECT**.

## About the answering system

### **Answering system and voicemail**

---

Your telephone has separate indicators for two different types of voice messages: those recorded on its built-in digital answering system and those recorded in your telephone service provider's voicemail (fees may apply). Your telephone's built-in digital answering system messages and voicemail messages are separate. Each alerts you to new messages differently.

- ▶ If **XX new messages** display on the handsets, there are new messages in the built-in answering system. To listen to messages recorded on your digital answering system, press ▶/■/**PLAY/STOP** on the telephone base. To listen to messages with a handset, see **To listen to messages on a cordless handset** on page 80.
- ▶ If  and **New voicemail** display on the handset, your telephone service provider is indicating that it has new voicemail for you. To listen to your voicemail, dial an access number provided by your telephone service provider, followed by a security code or PIN.

Some service providers bundle or combine multiple services like voicemail and call waiting, so you may not be aware that you have voicemail. To check what services you have and how to access them, contact your telephone service provider.

To use your voicemail service rather than the answering system, turn off the answering system. To use the answering system rather than your voicemail service, contact your telephone service provider to deactivate the voicemail service.

### **Using the answering system and voicemail together**

---

You can also use the telephone answering system and voicemail together by setting your built-in answering system to answer before voicemail answers, as described below. To learn how to program your voicemail settings, contact your telephone service provider. Then, if you are on a call, or if the answering system is busy recording a message and you receive another call, the second caller can leave a voicemail message.

Set your answering system to answer calls at least two rings earlier than your voicemail is set to answer. For example, if your voicemail answers after six rings, set your answering system to answer after four rings. Some voicemail providers may program the delay before answering calls in seconds instead of rings. In this case, allow six seconds per ring when determining the appropriate setting.

## About the answering system

### **Message capacity**

---

The answering system can record and store up to 99 messages. Each message can be up to 3 minutes in length. The total storage capacity for the announcement, messages and memos is approximately 22 minutes. The actual recording time depends on individual message characteristics. Messages remain available for replay until you delete them.

### **Voice prompts**

---

The system provides voice prompts to guide you through the setup procedures at the telephone base or handset, message playback, remote access and recording outgoing announcements.

### **Call screening**

---

#### **To screen calls at the telephone base:**

If the answering system and call screening are on, the announcement and the incoming message broadcast at the telephone base when a call is answered by the answering system.

#### **Options while a message is being recorded:**

- › Press **VOL ▼** or **VOL ▲** on the telephone base to adjust the call screening volume.
- › Press **VOL ▼** or **VOL ▲** to temporarily turn on or off the call screening.
- › Press **▶/■/PLAY/STOP** to temporarily turn on the call screening if the call screening is set to off.

#### **To screen calls at the cordless handset:**

If the answering system is on and a call is being answered by the answering system, the handset shows **To screen call press [SELECT]** at the same time. Press **MENU/SELECT** to screen the call on your handset. The handset shows the caller's information. If you do not subscribe to caller ID service, the handset shows **Screening...**

## About the answering system

### Options while a message is being recorded:

- ▶ Press **VOL ▼** or **VOL ▲** on the handset to adjust the call screening volume.
- ▶ Press **◀)/SPEAKER** to switch between speakerphone mode and handset mode.
- ▶ Press **⬆️HOME/FLASH** to answer the call.

### Call intercept

---

When a caller is leaving a message on your answering system, you can stop recording and talk to the caller by pressing **⬆️HOME/FLASH** or **◀)/SPEAKER** on the handset.

### Temporarily turning off the message alert tone

---

If the message alert tone is turned on, the telephone base beeps every ten seconds when there are new messages. Pressing any telephone base key (except **FIND HS**) temporarily silences the message alert tone.

If you press **X/DELETE** when in idle mode to temporarily turn off the message alert tone, there is a voice prompt directing you to press **X/DELETE** again to delete all old messages. The message alert tone is temporarily off. Only press **X/DELETE** a second time if you wish to erase all old messages in your answering system.

The message alert tone resumes when you receive another message.

## Message playback

### To listen to messages at the telephone base:

- ▶ Press **▶/■/PLAY/STOP** on the telephone base to listen to the messages. If you have new messages, the telephone plays only the new messages (oldest first). If there are no new messages, the telephone plays back all messages (oldest first).

### To listen to messages on a cordless handset:

1. Press **MENU/SELECT** in idle mode.
2. Press **MENU/SELECT** to select **Play messages**. If you have either new or old messages, the messages play automatically.

### Options during playback

---

#### When messages are playing on the telephone base:

- ▶ Press **VOL ▼** or **VOL ▲** to adjust the message playback volume.
- ▶ Press **▶/SKIP** to skip to the next message.
- ▶ Press **◀/REPEAT** to repeat the message currently playing. Press **◀/REPEAT** twice to listen to the previous message.
- ▶ Press **X/DELETE** to delete the current message. The system advances to the next message.
- ▶ Press **▶/■/PLAY/STOP** to stop the playback.

#### When messages are playing on a handset:

- ▶ Press **📎)/SPEAKER** to play the messages through the handset earpiece. Press **📎)/SPEAKER** again to return to playing messages through the speakerphone.
- ▶ Press **VOL ▼** or **VOL ▲** to adjust the message playback volume.
- ▶ Press **6** to skip to the next message.
- ▶ Press **4** to repeat the message currently playing. Press **4** twice to listen to the previous message.
- ▶ Press **3** or **MUTE/DELETE** to delete the current message.
- ▶ Press **🔌 OFF/CANCEL** to stop the playback.

## Delete all old messages

---

### Using the telephone base:

1. Press **X/DELETE** in idle mode. The telephone announces, *“To delete all old messages, press DELETE again.”*
2. Press **X/DELETE** again. All previously reviewed messages are erased and the telephone announces, *“All old messages deleted.”*

### Using a handset:

1. Press **MENU/SELECT** in idle mode.
2. Press **▼CID** or **▲DIR** to highlight **Answering sys**, then press **MENU/SELECT**.
3. Press **▼CID** or **▲DIR** to highlight **Delete all old**, then press **MENU/SELECT**.
4. Press **MENU/SELECT** to confirm. The handset displays **Deleting...**, then **No old messages** and then returns to the previous menu. You hear a confirmation tone.

## Recording and playing memos

Memos are your own recorded messages used as reminders for yourself or others using the same answering system. You can record your own memos using a system handset or the telephone base. Play and delete them the same way as incoming messages.

### Record a memo

---

1. Press **MENU/SELECT** in idle mode.
2. Press **▼CID** or **▲DIR** to highlight **Answering sys**, then press **MENU/SELECT**.
3. Press **▼CID** or **▲DIR** to highlight **Record memo**, then press **MENU/SELECT**. The system announces, *“Record after the tone. Press 5 when you are done.”* Speak towards the handset microphone.
4. Press **5** to stop recording. The system announces, *“Recorded.”* and then returns to the previous menu. The system does not save memos shorter than two seconds.

### Playback a memo

---

Play memos the same way as messages. See **Message playback** on pages 80-81.



## Remote access

You can reach your answering system remotely by dialing your home telephone number from any touch-tone telephone.

### **To remotely access the answering system**

---

1. Dial your telephone number from any touch-tone telephone.
2. Once the system plays your announcement, enter the two-digit remote access code (**19** is the default code, see page 75 to change it).
  - The system automatically announces the number of new or old messages (if any), and then begins to play them.
3. You can also enter the following remote commands.

#### **Remote commands**

<b>1</b>	Press to listen to all messages.
<b>2</b>	Press to listen to new messages only.
<b>3</b>	Press to delete the current message (during playback).
<b>33</b>	Press twice to delete all old messages.
<b>4</b>	Press to repeat the current message (during playback).
<b>44</b>	Press twice to listen to the previous message.
<b>5</b>	Press to stop.
<b>*5</b>	Press to listen to a list of remote commands.
<b>6</b>	Press to skip to the next message (during playback).
<b>*7</b>	Press to record a new announcement.
<b>8</b>	Press to hang up the call.
<b>0</b>	Press to turn the answering system on or off.

4. Hang up or press **8** to end the call.

Cut and carry the remote access wallet card at the back of this user's manual for quick reference.

## Add and register handsets/headsets/speakerphones

Your telephone can support up to five DECT 6.0 cordless handsets (AT&T model **DL70010**, sold separately), cordless headsets and speakerphones (sold separately). Visit <https://telephones.att.com/accessories> for a list of compatible DECT 6.0 cordless headsets and speakerphones. Each new handset, headset or speakerphone must be registered to the telephone base before use. You must register each handset, headset or speakerphone separately.

To register a cordless headset or speakerphone to this telephone system, please refer to the corresponding user's manual for more details. To register a cordless handset, see the following.

The handsets provided within your product box are already registered as **HANDSET 1**, and so forth. Additional handsets are assigned numbers in the sequential order they are registered (up to **HANDSET 5**).

### Register a handset to your telephone base

---

1. Before you begin registration, make sure the handset is out of the telephone base or charger and shows **To register HS...** and **...see manual** alternately.
2. Put the handset you wish to register on the telephone base cradle.

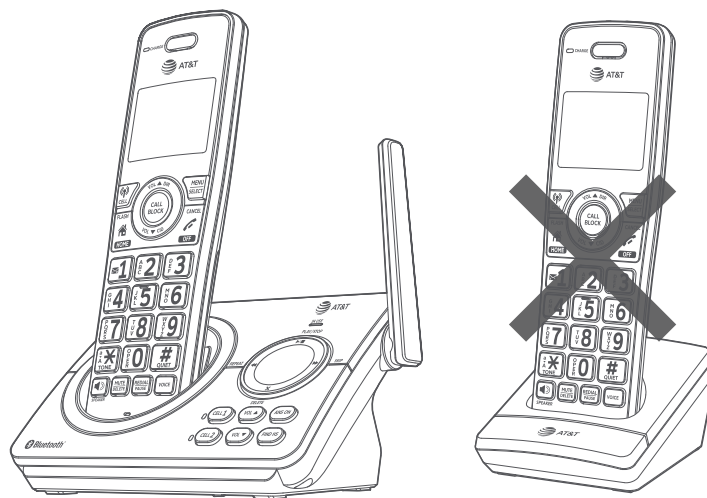

For registration, put the handset on the telephone base, not the handset charger.

3. The handset shows **Registering...** If the registration is successful, the handset screen displays **Registered** and beeps. The handset is now registered with the telephone base.

## Add and register handsets/headsets/speakerphones

If registration fails, the system will automatically try to register again. If registration fails after the third try, **Registration failed** appears on the handset screen. The handset shows **To register HS...** and **...see manual** alternately and the telephone base returns to idle mode. This may take up to five minutes to occur. Please start again from Step 1.



### Notes:

- ▶ You cannot register a handset if any other system handset is in use.
- ▶ If you try to register more than five handsets to the telephone base, the telephone base shows **Registration slots are full** and sounds two beeps.

## Deregister handsets

You may need to deregister your handsets if:

- ▶ You have five registered handsets and need to replace a handset.

**-OR-**

- ▶ You wish to change the designated handset number of your registered handsets.

You must first deregister ALL handsets, and then register each handset you wish to use again, one at a time.

**Please read carefully through all the instructions on this page before beginning the deregistration process.**

### Deregister all handsets from the telephone base

In addition to the cordless handsets, this operation will also deregister all cordless headsets and speakerphones registered to your telephone base.

1. Make sure that all handsets are out of the telephone base and chargers before you begin deregistration.
2. Press and hold **FIND HS** on the telephone base for about 10 seconds (until the **IN USE** light starts to flash). Release **FIND HS**.
3. Immediately press **FIND HS** again while the **IN USE** light is still flashing. (If the light stops flashing, start again with Step 1.)
4. It takes up to 10 seconds to complete the deregistration process. Before registering the handset again, wait for the cordless handset screen to display **To register HS...** and **...see manual** alternately.
5. After deregistering, register each handset again individually following the registration instructions on pages 84-85.



Notes:

- ▶ If the deregistration process fails, you may need to reset the system and try again. To reset, unplug the power from the telephone base and plug it back in.
- ▶ You cannot deregister the handsets if any other system handset is in use.
- ▶ Even if the battery is depleted, you can still deregister the handsets by following the steps. After the handset is charged for at least 10 minutes, the screen shows **To register HS...** and **... see manual** alternately.

## Troubleshooting

If you have difficulty with your telephone, please try the following suggestions. For customer service, or to purchase accessories or replacement parts, visit our website at **<https://telephones.att.com>**, or call **1 (800) 222-3111**. In Canada, dial **1 (866) 288-4268**.

For more detailed instructions, refer to the online Complete user's manual at **<https://telephones.att.com/manuals>**.

### **I cannot pair my cell phone to the telephone base.**

- ▶ Make sure you have cellular coverage.
- ▶ Make sure your cell phone is compatible with your **DL72210/DL72310/DL72340/DL72350**. Check the Bluetooth compatibility list at **<https://telephones.att.com/bluetooth>**.
- ▶ Make sure the Bluetooth function of your cell phone is turned on. See the user's manual of your cell phone for more information.
- ▶ Make sure that you set your cell phone to search for devices.
- ▶ If the **DL72210/DL72310/DL72340/DL72350** is in your cell phone device history list, delete it and try pairing again.
- ▶ Carefully follow the pairing instructions on page 13. Make sure that your cell phone is not connected to any other Bluetooth device.
- ▶ Turn off your cell phone, then turn it on again.
- ▶ Reset the telephone base. Unplug the unit's electrical power. Wait for approximately 15 seconds, then plug it back in. Repeat the suggestions mentioned above.

### **I cannot pair my headset to the telephone base.**

- ▶ Make sure that your Bluetooth headset is in discoverable mode when pairing with the telephone base. See the user's manual of your headset for more information on how to set your headset to discoverable mode.
- ▶ Make sure your headset is compatible with your **DL72210/DL72310/DL72340/DL72350**. Check the Bluetooth compatibility list at **<https://telephones.att.com/bluetooth>**.
- ▶ Carefully follow the pairing instructions on page 13. Make sure that your headset is not connected to any other Bluetooth device.
- ▶ Reset the telephone base. Unplug the unit's electrical power. Wait for approximately 15 seconds, then plug it back in. Repeat the suggestions mentioned above.

## Troubleshooting

### **I cannot connect my cell phone with the telephone base.**

- ▶ Make sure that the Bluetooth function of your cell phone is turned on. See the user's manual of your cell phone for more information.
- ▶ Make sure that your Bluetooth cell phone is not connected to any other Bluetooth device.
- ▶ Turn off your cell phone, then turn it on again.
- ▶ Make sure that your cell phone is on the active devices list.
- ▶ For some cell phones, you must authorize the **DL72210/DL72310/DL72340/DL72350** device in your cell phone's Bluetooth feature. See the user's manual of your cell phone for more information.
- ▶ Manually connect your cell phone to the **DL72210/DL72310/DL72340/DL72350**. Refer to the user's manual of your cell phone for more information.

### **I cannot connect my headset with the telephone base.**

- ▶ Make sure that your Bluetooth headset is not connected to any other Bluetooth device.
- ▶ Make sure that your headset is on the active devices list.

### **I cannot download contacts from my cell phone to my DL72210/DL72310/DL72340/DL72350.**

- ▶ Make sure that your cell phone is paired and connected to the base.
- ▶ Make sure you place your cell phone next to the base while downloading.
- ▶ If your cell phone does not support the download, you can send the directory from your cell phone. The system can receive the directory automatically. See the user's manual of your cell phone for more information.

## Troubleshooting

### **My phone doesn't work at all.**

- ▶ Make sure the power cord is securely plugged in.
- ▶ Make sure that the battery connector is securely plugged into the handset.
- ▶ Make sure the telephone line cord is securely and firmly plugged into the telephone base and the telephone wall jack.
- ▶ Charge the battery in the handset for at least 11 hours. For optimum daily performance, return the handset to the telephone base or charger when not in use.
- ▶ If the battery is depleted, charge the handset for at least 30 minutes before you use it. Refer to page 8 for details.
- ▶ Reset the telephone base. Unplug the electrical power. Wait for approximately 15 seconds, then plug it back in. Allow up to one minute for the handset and telephone base to reset.
- ▶ You may need to purchase a new battery. Please refer to **Battery installation and charging** (pages 8-10) in this user's manual.

### **The remote voice control feature does not work.**

- ▶ Make sure the operating system of your cell phone is iOS 8 or later, or Android 4 or later.
- ▶ Make sure your cell phone is paired and connected to your telephone system via Bluetooth.
- ▶ Make sure no Bluetooth applications are running in the background of your cell phone.
- ▶ Keep your cell phone within 15 feet of the telephone base.
- ▶ Do not lock up your cell phone's screen or set passcode for activating the voice-controlled application (voice app).
- ▶ Make sure you have turned on or logged in to the applications on your cell phone that you will be sending your voice commands, such as GPS, e-mail and social networking accounts.
- ▶ Make sure your cell phone's data or Wi-Fi signal is in full strength and your cell phone can connect to the Internet.
- ▶ Try to activate the voice app on your cell phone to ensure it is in place.

## Troubleshooting

- ▶ Once you have activated the remote voice control feature, you are using your cell phone's voice app to operate your cell phone. If the voice commands do not work, please check the cell phone user's manual and the voice app's help topics to find out what commands you can use and any limitations of the voice app.
- ▶ Some cell phone manufacturers or network carriers may customize the phone's operating system and implement their own voice app. If you want to use Google Now, you need to manually set it as your default voice app. For detailed instructions, refer to your cell phone user's manual, or contact your cell phone's manufacturer or network carrier. You may also go to "Google Product Forums" on the Internet and check the corresponding help topics.
- ▶ Due to the settings of certain cell phones and voice apps, your cell phone may not support the remote voice control feature. Contact your cell phone's manufacturer or network carrier, or check the voice app's help topics if you encounter any problems.

### **The remote voice control feature ends unexpectedly while it is in use.**

- ▶ The Bluetooth function of your cell phone may be off, or you may have moved your cell phone out of Bluetooth range of the telephone base. Make sure the Bluetooth function of your cell phone is turned on and keep your cell phone within 15 feet of the telephone base.
- ▶ The data or Wi-Fi connection of your cell phone may be lost. Make sure your cell phone's data or Wi-Fi signal is in full strength.
- ▶ The feature may be ended automatically by your cell phone. For example, a cell call has been established via the remote voice control feature and the call has just ended.
- ▶ If you receive a landline or cell line incoming call when you have activated remote voice control on a connected cell phone, the remote voice control operation will be ended.
- ▶ The voice-controlled application of your cell phone may be affected by other cell phone operations in the background. If the problem persists, contact your cell phone's network carrier.



## Troubleshooting

### **I cannot press any dialing keys (0-9, TONE X, QUIET #) when I am on a cell call using the remote voice control feature.**

- ▶ When you press the dialing keys on the handset or telephone base during a cell call using the remote voice control feature, the telephone system may have no response and the call may be ended. Please use the cell lines of your telephone system for calls that require using the dialing keys during the call (see **Make, answer or end a cell call** on page 28).

### **The display shows No home line. I cannot get a dial tone.**

- ▶ First try all the suggestions mentioned above.
- ▶ If the previous suggestions do not work, disconnect the telephone line cord from your telephone and connect the telephone line cord to another telephone.
  - ▶ If there is no dial tone on that other telephone either, your telephone line cord may be defective. Install a new telephone line cord.
  - ▶ If changing the telephone line cord does not help, the wall jack (or the wiring to this wall jack) may be defective. Try using a different wall jack in your home to connect your **DL72210/DL72310/DL72340/DL72350** telephone, or contact your telephone service provider (charges may apply).

### **I cannot dial out.**

- ▶ Try all the suggestions in **The display shows No home line. I cannot get a dial tone** mentioned above.
- ▶ Make sure you have a dial tone before dialing. The handset may take a second or two to find the telephone base and produce a dial tone. This is normal. Wait an extra second before dialing.
- ▶ Eliminate any background noise. Noise from a television, radio or other appliances may cause the phone to not dial out properly. If you cannot eliminate the background noise, first try muting the handset before dialing, or dialing from another room in your home with less background noise.
- ▶ Disconnect the telephone base from the telephone wall jack and plug in a working telephone. If the other phones in your home are having the same problem, the problem is in your wiring or telephone service. Contact your telephone service provider (charges may apply).

## Troubleshooting

### **My handset isn't performing normally.**

- ▶ Make sure the power cord is securely plugged into the telephone base. Plug the power adapter into a different working electrical outlet not controlled by a wall switch.
- ▶ Move the handset closer to the telephone base. You might have moved out of range.
- ▶ Reset the telephone base. Unplug the electrical power. Wait for 15 seconds, then plug it back in. Allow up to one minute for the handset and telephone base to reset.
- ▶ Other electronic products such as HAM radios and other DECT phones, can cause interference to your cordless telephone. Try installing your telephone as far away as possible from these types of electronic devices.

### **The batteries do not hold a charge.**

- ▶ If the handset is in the charger and the charge light does not turn on, refer to **The charge light is off** (page 93) in this **Troubleshooting** guide.
- ▶ Charge the battery in the handset for at least 11 hours. For optimum daily performance, return the handset to the telephone base or charger when not in use.
- ▶ If the battery is depleted, it may take approximately 30 minutes to charge the handset before it shows **Low battery**, refer to page 8 for details.
- ▶ You may need to purchase a new battery. Please refer to **Battery installation and charging** (pages 8-10) in this user's manual.

### **I get noise, static, or a weak signal even when I'm near the telephone base.**

- ▶ If you subscribe to high-speed Internet service (digital subscriber line - DSL) through your telephone lines, you must install a DSL filter between the telephone line cord and the telephone wall jack (see page 6). The filter prevents noise and caller ID problems caused by DSL interference. Please contact your DSL service provider for more information about DSL filters.
- ▶ You may be able to improve the performance of your cordless phone by installing your new telephone base as far as possible from any other existing cordless telephone system that may already be installed.
- ▶ Other electronic products such as HAM radios and other DECT phones, can cause interference to your cordless telephone. Try installing your telephone as far away as possible from these types of electronic devices.

## Troubleshooting

- ▶ Do not install this phone near a microwave oven or on the same electrical outlet. You may experience decreased performance while the microwave oven is operating.
- ▶ If your phone is plugged in with a modem or a surge protector, plug the phone (or modem/surge protector) into a different location. If this doesn't solve the problem, relocate your phone or modem farther apart from one another, or use a different surge protector.
- ▶ Relocate your phone to a higher location. The phone may have better reception when installed in a high area.
- ▶ Disconnect the telephone base from the telephone wall jack and plug in a working telephone. If the other phones in your home are having the same problem, the problem is in your wiring or telephone service. Contact your telephone service provider (charges may apply).

### **The charge light is off.**

- ▶ Make sure the power and line cords are plugged in correctly and securely.
- ▶ Unplug the electrical power. Wait for 15 seconds, then plug it back in. Allow up to one minute for the handset and telephone base to reset.
- ▶ Clean the handset and telephone base charging contacts each month using a pencil eraser or cloth.

### **My caller ID isn't working.**

- ▶ Caller ID is a subscription service. You must subscribe to this service from your telephone service provider for this feature to work on your phone.
- ▶ The caller may not be calling from an area that supports caller ID.
- ▶ Both your telephone service provider and your caller's telephone service provider must use caller ID compatible equipment.
- ▶ If you subscribe to high-speed Internet service (digital subscriber line - DSL) through your telephone lines, you must install a DSL filter between the telephone line cord and the telephone wall jack (see page 6). The filter prevents noise and caller ID problems caused by DSL interference. Please contact your DSL service provider for more information about DSL filters.

## **System screens all my incoming home calls.**

- You may have selected the **Screen unknown** or **Screen robot** profile setting for Smart call blocker (see page 49). The telephone asks callers to announce their names or press the pound key (#). We recommend that you add the phone numbers of your family members and friends, and desired businesses to your **Directory** (see page 37) or **Allow list** (see page 55), or add their names to the **Star name list** (see page 59). This will avoid Smart call blocker to screen their calls.
- To turn Smart call blocker off, see **Set Smart call blocker on/off** on page 49.

## **My telephone does not screen incoming cell calls.**

- The screening feature of Smart call blocker is applicable to home calls only. All incoming cell calls will get through and ring. You can block calls of a cell phone number by adding the number to the block list. See **Block list** on page 50.

## **I want to block a cell phone number.**

- If you want to block calls of a cell phone number, add the number to the block list. See **Block list** on page 50.

## **While screening a home call, the telephone suddenly stops screening and connects to the call.**

- Another handset may have picked up the screening call.
- If you have another telephone system sharing the same telephone line, and someone picks up the call on the other telephone system while the screening is in progress, the screening process will be terminated and connect you to the caller.

## **My telephone block calls from someone I know.**

- You may have saved the caller's number to your block list. To remove the number from the block list. See **Delete a block entry** on page 54.

## **Blocking all unknown calls.**

- If you want to block all unknown calls without numbers and calls with numbers or names that are not in your directory, allow list or star name list, select the **Block unknown** profile setting. See **Set profile** on page 49.

## **Forwarding all unknown calls to the answering system.**

- ▶ If you want to forward all unknown calls without numbers and calls with numbers or names that are not in your directory, allow list or star name list to the answering system, select the **UnknownToAns.S** profile setting. See **Set profile** on page 49.

## **I cannot retrieve voicemail messages.**

- ▶ Your telephone has both a built-in answering system and voicemail indication. They are independent features and each alerts you to new messages differently (page 77). If you subscribe to voicemail service from your telephone service provider (charges may apply), contact your telephone service provider for more information on how to access your voicemail.

## **I've set my LCD language to Spanish or French and I don't know how to change it back to English.**

- ▶ Press **MENU/SELECT** in idle mode, then enter **\*364#** using the dialing keys. You hear a confirmation tone.

## **The answering system does not answer after the correct number of rings.**

- ▶ Make sure the answering system is on. When the answering system is on, **ANS ON** should show on the handset. The **ANS ON** key light is lit on the telephone base.
- ▶ If toll saver is selected (page 75), the number of rings changes to two when there are new messages waiting.
- ▶ If the memory is full or the system is off, the system answers after 10 rings.
- ▶ In some cases, the answering system is affected by the ringing system used by the telephone service provider.
- ▶ If you subscribe to voicemail service, change the number of rings so that your answering system answers before your voicemail (page 75). To determine how many rings activate your voicemail, please contact your telephone service provider.
- ▶ If there is a fax machine connected to the same telephone line, try disconnecting the fax machine. If that solves the problem, consult your fax machine documentation for information on compatibility with answering systems.

## **The answering system does not record messages.**

- ▶ Make sure the answering system is on.
- ▶ Make sure the memory of the answering system is not full. When the answering machine memory is full, it does not record new messages until some old messages are deleted.
- ▶ If you subscribe to voicemail service, change the number of rings so that your answering system answers before your voicemail (page 75). To determine how many rings activate your voicemail, please contact your telephone service provider.
- ▶ If there is a fax machine connected to the same telephone line, try disconnecting the fax machine. If that solves the problem, consult your fax machine documentation for information on compatibility with answering systems.

## **Common cure for electronic equipment:**

If the telephone is not responding normally, try resetting the telephone. Do the following in the order listed:

1. Disconnect the power to the telephone base.
2. Disconnect the handset battery, and spare battery, if applicable.
3. Wait a few minutes.
4. Connect power to the telephone base.
5. Completely remove the battery. Replace the battery and place the handset into the telephone base.
6. Wait for the handset to reestablish its connection with the telephone base. Allow up to one minute for this to take place.

## Maintenance

### **Taking care of your telephone**

- ▶ Your cordless telephone contains sophisticated electronic parts, so it must be treated with care.
- ▶ Avoid rough treatment.
- ▶ Place the handset down gently.
- ▶ Save the original packing materials to protect your telephone if you ever need to ship it.

### **Avoid water**

- ▶ Your telephone can be damaged if it gets wet. Do not use the handset in the rain, or handle it with wet hands. Do not install the telephone base near a sink, bathtub or shower.

### **Electrical storms**

- ▶ Electrical storms can sometimes cause power surges harmful to electronic equipment. For your own safety, take caution when using electric appliances during storms.

### **Cleaning your telephone**

- ▶ Your telephone has a durable plastic casing that should retain its luster for many years. Clean it only with a soft cloth slightly dampened with water or mild soap.
- ▶ Do not use excess water or cleaning solvents of any kind.

Remember that electrical appliances can cause serious injury if used when you are wet or standing in water. If the telephone base should fall into water, **DO NOT RETRIEVE IT UNTIL YOU UNPLUG THE POWER CORD AND TELEPHONE LINE CORDS FROM THE WALL.** Pull the telephone out by the unplugged cords.

# Important safety information



This symbol is to alert you to important operating or servicing instructions that may appear in this user's manual. Always follow basic safety precautions when using this product to reduce the risk of injury, fire, or electric shock.

## Safety information

---

- ▶ Read and understand all instructions in the user's manual. Observe all markings on the product.
- ▶ Avoid using a telephone during a thunderstorm. There might be a slight chance of electric shock from lightning.
- ▶ Do not use a telephone in the vicinity of a gas leak. Under certain circumstances, a spark may be created when the adapter is plugged into the power outlet, or when the handset is replaced in its cradle. This is a common event associated with the closing of any electrical circuit. In an inadequately ventilated environment, the user should not plug the phone into a power outlet, nor put a charged handset into the cradle where there are concentrations of flammable or flame-supporting gases. A spark in such an environment could create a fire or explosion. Such environments might include: medical use of oxygen without adequate ventilation; industrial gases (cleaning solvents; gasoline vapors; etc.); a leak of natural gas; etc.
- ▶ Do not use this product near water or when you are wet. For example, do not use it in a wet basement or shower, nor next to a swimming pool, bathtub, kitchen sink, and laundry tub. Do not use liquids or aerosol sprays for cleaning. If the product comes in contact with any liquids, unplug any line or power cord immediately. Do not plug the product back in until it has dried thoroughly.
- ▶ Install this product in a protected location where no one can trip over any line or power cords. Protect cords from damage or abrasion.
- ▶ If this product does not operate normally, read the **Troubleshooting** section on pages 87-96 of this user's manual. If you cannot solve the problem, or if the product is damaged, refer to the **Limited warranty** section on pages 107-108. Do not open this product except as may be directed in your user's manual. Opening the product or reassembling it incorrectly may expose you to hazardous voltages or other risks.
- Replace batteries only as described in your user's manual (pages 8-10). Do not burn or puncture batteries — they contain caustic chemicals.
- ▶ The power adapters are intended to be correctly oriented in a vertical or floor mount position. The prongs are not designed to hold the plug in place if it is plugged into a ceiling, under-the-table or cabinet outlet.
- ▶ For pluggable equipment, the socket-outlet shall be installed near the equipment and shall be easily accessible.



### Cautions:

- ▶ Use only the power adapters provided with this product. To obtain a replacement, visit our website at **<https://telephones.att.com>**, or call **1 (800) 222-3111**. In Canada, dial **1 (866) 288-4268**.
- ▶ Use only the supplied rechargeable battery or replacement battery (model BT162342/BT262342). To order, visit our website at **<https://telephones.att.com>** or call **1 (800) 222-3111**. In Canada, dial **1 (866) 288-4268**.
- ▶ To prevent risk of fire or battery explosion, replace with the correct battery type. Dispose of used batteries according to the instructions.



# Important safety information

## **Especially about cordless telephones**

---

- ▶ **Privacy:** The same features that make a cordless telephone convenient create some limitations. Telephone calls are transmitted between the telephone base and the handset by radio waves, so there is a possibility that your cordless telephone conversations could be intercepted by radio receiving equipment within range of the cordless handset. For this reason, you should not think of cordless telephone conversations as being as private as those on corded telephones.
- ▶ **Electrical power:** The telephone base of this cordless telephone must be connected to a working electrical outlet which is not controlled by a wall switch. Calls cannot be made from the handset if the telephone base is unplugged, switched off or if the electrical power is interrupted.
- ▶ **Potential TV interference:** Some cordless telephones operate at frequencies that may cause interference to TVs and VCRs. To minimize or prevent such interference, do not place the telephone base of the cordless telephone near or on top of a TV or VCR. If interference is experienced, moving the cordless telephone farther away from the TV or VCR will often reduce or eliminate the interference.
- ▶ **Rechargeable batteries:** This product contains nickel-metal hydride rechargeable batteries. Exercise care in handling batteries in order not to create a short circuit with conductive material such as rings, bracelets, and keys. The battery or conductor may overheat and cause harm. Observe proper polarity between the battery and the battery charger.
- ▶ **Nickel-metal hydride rechargeable batteries:** Dispose of these batteries in a safe manner. Do not burn or puncture. Like other batteries of this type, if burned or punctured, they could release caustic material which could cause injury.



The RBRC® Seal means that the manufacturer is voluntarily participating in an industry program to collect and recycle nickel-metal hydride rechargeable batteries when taken out of service within the United States. These batteries may be taken to a participating local retailer of replacement batteries or recycling center. You may call 1-800-8-BATTERY® for locations accepting spent Ni-MH batteries.

RBRC® and 1-800-8-BATTERY® are registered trademarks of the Rechargeable Battery Recycling Corporation.

## Important safety information

### **Precautions for users of implanted cardiac pacemakers**

---

Cardiac pacemakers (applies only to digital cordless telephones):

Wireless Technology Research, LLC (WTR), an independent research entity, led a multidisciplinary evaluation of the interference between portable wireless telephones and implanted cardiac pacemakers. Supported by the U.S. Food and Drug Administration, WTR recommends to physicians that:

#### **Pacemaker patients:**

- ▶ Should keep wireless telephones at least six inches from the pacemaker.
- ▶ Should NOT place wireless telephones directly over the pacemaker, such as in a breast pocket, when it is turned ON.
- ▶ Should use the wireless telephone at the ear opposite the pacemaker.

WTR's evaluation did not identify any risk to bystanders with pacemakers from other persons using wireless telephones.

### **ECO mode**

---

This power conserving technology reduces power consumption for optimal battery performance. The ECO mode activates automatically whenever the handset is synchronized with the telephone base.

### **Especially about telephone answering systems**

---

Two-way recording: This unit does not sound warning beeps to inform the other party that the call is being recorded. To ensure that you are in compliance with any federal or state regulations regarding recording a telephone call, you should start the recording process and then inform the other party that you are recording the conversation.

## **SAVE THESE INSTRUCTIONS**

## For C-UL compliance

In compliance with the bilingual requirements for safety, caution, and warning markings of Canadian Federal and Provincial/Territorial statutes and regulations, the French version of Important safety information is included.

### Mesures de sécurité importantes

---

Ce symbole vous alertera d'informations importantes ou d'instructions d'entretien pouvant apparaître dans ce guide d'utilisation. Respectez toujours les mesures de sécurité et de sécurité de base lorsque vous utilisez ce produit, afin de réduire les risques de blessures, d'incendie, ou d'électrocution.

#### Information relative à la sécurité

---

- ▶ Veuillez lire et comprendre toutes les instructions de ce guide d'utilisation. Relectez toutes les inscriptions apparaissant sur le produit.
- ▶ Évitez d'utiliser le téléphone pendant un orage. Il pourrait y avoir un faible risque d'électrocution.
- ▶ N'utilisez pas un téléphone près d'une fuite de gaz. Dans certaines circonstances, une flammèche pourrait se produire lorsque l'adaptateur est branché à une prise de courant, ou lorsque le combiné est déposé sur son chargeur. Ceci est un événement fréquent associé avec la fermeture d'un circuit électrique. L'utilisateur ne devrait pas brancher un téléphone dans une prise de courant, et ne devrait pas déposer un combiné chargé dans le chargeur, si le téléphone se trouve dans un environnement comportant une concentration de gaz inflammables ou ignifuges, à moins de se trouver dans un endroit où la ventilation est adéquate. Une flammèche dans de tels environnements pourrait provoquer une explosion. De tels environnements peuvent comprendre : les endroits où de l'oxygène à des fins médicales est utilisé sans ventilation adéquate; des endroits où se trouvent des gaz industriels (dissolvants de nettoyage, des vapeurs de gazoline, etc.), une fuite de gaz naturel, etc.
- ▶ N'utilisez pas ce produit près de l'eau ou lorsque vous êtes mouillés. Par exemple, ne l'utilisez pas dans des sous-sols humides ou sous la douche, ou près d'une piscine, d'un bain, d'un évier de cuisine, ou d'une cuve de lavage. N'utilisez pas de liquides, ou de vaporisateurs aérosol de nettoyage. Si le produit entre en contact avec du liquide, débranchez immédiatement le fil téléphonique ou le cordon d'alimentation. Ne rebranchez pas le produit avant qu'il soit complètement sec.
- ▶ Installez cet appareil dans un endroit protégé où personne ne peut trébucher sur les cordons d'alimentation ou la ligne téléphonique. Protégez les câbles contre les dommages ou l'abrasion.
- ▶ Si le produit ne fonctionne pas correctement, consultez la section **Dépannage (Troubleshooting)** des pages 87-96 de ce guide d'utilisation. Si vous ne pouvez pas régler le problème, ou si le produit est endommagé, consultez la section **Garantie limitée (Limited warranty)** des pages 107-108. N'ouvrez pas ce produit, sauf tel qu'indiqué dans le guide d'utilisation. L'ouverture du produit ou le remontage inadéquat pourrait vous exposer à des tensions dangereuses ou autres dangers.
- ▶ Remplacez les piles uniquement tel que décrit dans votre guide d'utilisation (pages 8-10). N'incinerez pas et ne percez pas les piles — elles contiennent des produits chimiques caustiques.
- ▶ Les adaptateurs secteurs sont conçus pour être orientés verticalement ou installés sur le plancher. Les broches ne sont pas conçues pour se maintenir en place si la fiche est branchée dans une prise de courant au plafond, sous la table ou sous une armoire.
- ▶ Pour les produits à brancher à une prise de courant, la prise de courant doit être installée près du produit, afin d'assurer une accessibilité sécuritaire à la prise de courant.

## Appendix For C-UL compliance



### MISES EN GARDE:

- ▶ N'utilisez que les adaptateurs inclus avec ce produit. Pour obtenir une pièce de rechange, visitez notre site Web au **<https://telephones.att.com>** ou composez le **1-800-222-3111**. Au Canada, composez le **1-866-288-4268**.
- ▶ N'utilisez que la pile de rechargeable incluse ou une pile de recharge (modèle BT162342/ BT262342). Pour commander, visitez notre site Web **<https://telephones.att.com>** ou composez le **1-800-222-3111**. Au Canada, composez le **1-866-288-4268**.
- ▶ Afin de prévenir les risques d'incendie ou d'explosion de la pile, remplacez la pile avec une pile du même type. Jetez les piles épuisées en respectant les instructions.

### Spécifiquement en rapport avec les téléphones sans fil

- ▶ Confidentialité : Les mêmes caractéristiques qui rendent les téléphones sans fil si pratiques créent également des restrictions. Les appels téléphoniques sont transmis entre le socle du téléphone et le combiné par le biais d'ondes radio, et il se peut que vos conversations téléphoniques soient interceptées par d'autres équipements de réception d'ondes radio au sein de la portée du téléphone sans fil. Pour cette raison, vous ne devez pas considérer les conversations sur un téléphone sans fil comme étant aussi confidentielles que celles d'un téléphone à cordon.
- ▶ Alimentation électrique : La base de ce téléphone sans fil doit être branchée à une prise de courant électrique fonctionnelle. La prise électrique ne doit pas être contrôlée par un interrupteur mural. Les appels ne peuvent pas être effectués à partir du combiné si la base n'est pas branchée, si elle est hors fonction ou si le courant électrique est coupé.
- ▶ Interférences potentielles aux téléviseurs : Certains téléphones sans fil fonctionnent sur des fréquences pouvant causer des interférences aux téléviseurs et magnétoscopes. Pour réduire ou prévenir de tels parasites, ne pas déposer la base du téléphone sans fil à proximité d'un téléviseur ou magnétoscope, ni directement sur celui-ci. Si votre téléviseur affiche des interférences, éloignez le téléphone sans fil de celui-ci afin de réduire les parasites.
- ▶ Piles rechargeables : Ce produit comporte des piles rechargeables à l'hydrure métallique de nickel. Usez de prudence lorsque vous manipulez de telles piles et veillez à ne pas les court-circuiter avec des matériaux conducteurs, tels que des bagues, bracelets et clés. La pile ou le conducteur peut surchauffer et vous brûler. Respectez la polarité adéquate entre les piles et le chargeur de piles.
- ▶ Piles rechargeables à l'hydrure métallique de nickel : Jetez ces piles de manière sécuritaire. N'incinerez pas et ne percez pas les piles. Comme pour les autres piles du même type, si elles sont brûlées ou percées, des matières corrosives peuvent s'en échapper, ce qui risque de causer des brûlures ou autres blessures corporelles.



Le sceau de l'organisme de recyclage RBRC<sup>MD</sup> sur les piles à l'hydrure métallique de nickel signifie que le fabricant de cet appareil participe volontairement au programme industriel visant à reprendre et recycler ce type de piles lorsqu'elles ne servent plus, au sein du territoire des États-Unis et du Canada. Vous devez apporter ces piles chez un détaillant participant ou le centre de recyclage le plus près de chez vous. Ou vous pouvez composer le 1-800-8-BATTERY<sup>MD</sup> afin de connaître les endroits qui acceptent les piles à l'hydrure métallique de nickel mortes.

RBRC<sup>MD</sup> et 1-800-8-BATTERY<sup>MD</sup> sont des marques déposées de Rechargeable Battery Recycling Corporation.

## Appendix For C-UL compliance

### **Mesures préventives pour les utilisateurs de stimulateurs cardiaques implantés dans l'organisme**

---

Stimulateurs cardiaques (ne s'applique qu'aux téléphones sans fil numériques) :

L'organisme 'Wireless Technology Research, LLC (WTR)', une firme de recherche indépendante, a mené une évaluation pluridisciplinaire des interférences entre les téléphones sans fil portatifs et les stimulateurs cardiaques implantés dans l'organisme. Appuyée par l'Administration des aliments et drogues (FDA) des États-unis, la firme WTR recommande aux médecins :

#### **Avis aux détenteurs de stimulateurs cardiaques:**

- ▶ Ils doivent tenir le téléphone sans fil à une distance d'au moins six pouces du stimulateur cardiaque.
- ▶ Ils ne doivent PAS placer le téléphone sans fil directement sur le stimulateur cardiaque, tel que dans une poche de chemise, lorsque celui-ci est en fonction.
- ▶ Ils doivent utiliser le téléphone sans fil en l'appuyant sur l'oreille qui se trouve dans la direction opposée au stimulateur cardiaque.

L'étude effectuée par l'organisme WRS n'a pas identifié de risque pour les détenteurs de simulateurs cardiaques causé par les gens qui utilisent un téléphone sans fil à proximité de ceux-ci.

#### **Mode ECO**

---

Lorsque le socle communique avec le combiné, le mode ECO sera activé automatiquement. Ceci réduit la consommation d'énergie selon la distance entre le socle du téléphone et le combiné.

#### **Spécifiquement en rapport avec les répondeurs téléphoniques**

---

Enregistrement deux voies : Cet appareil n'émet pas de bips d'avertissement qui permettent de prévenir l'autre partie que vous enregistrez la conversation. Pour assurer votre conformité aux règlements fédéraux ou provinciaux en rapport avec les enregistrements des conversations téléphoniques, vous devriez informer l'autre partie lorsque vous activez l'enregistrement.

## **CONSERVEZ CES INSTRUCTIONS**

## FCC Part 68 and ACTA

This equipment complies with Part 68 of the FCC rules and with technical requirements adopted by the Administrative Council for Terminal Attachments (ACTA). The label on the back or bottom of this equipment contains, among other things, a product identifier in the format US:AAAEQ##TXXXX. This identifier must be provided to your telephone service provider upon request.

The plug and jack used to connect this equipment to premises wiring and the telephone network must comply with the applicable Part 68 rules and technical requirements adopted by ACTA. A compliant telephone cord and modular plug is provided with this product. It is designed to be connected to a compatible modular jack that is also compliant. An RJ11 jack should normally be used for connecting to a single line and an RJ14 jack for two lines. See Installation Instructions in the user's manual.

The Ringer Equivalence Number (REN) is used to determine how many devices you may connect to your telephone line and still have them ring when you are called. The REN for this product is encoded as the 6th and 7th characters following the US: in the product identifier (e.g., if ## is 03, the REN is 0.3). In most, but not all areas, the sum of all RENs should be five (5.0) or less. For more information, please contact your telephone service provider.

This equipment must not be used with Party Lines. If you have specially wired alarm dialing equipment connected to your telephone line, ensure the connection of this equipment does not disable your alarm equipment. If you have questions about what will disable the alarm equipment, consult your telephone service provider or a qualified installer.

If this equipment is malfunctioning, it must be unplugged from the modular jack until the problem has been corrected. Repairs to this telephone equipment can only be made by the manufacturer or its authorized agents. For repair procedures, follow the instructions outlined under the Limited Warranty.

If this equipment is causing harm to the telephone network, the telephone service provider may temporarily discontinue your telephone service. The telephone service provider is required to notify you before interrupting service. If advance notice is not practical, you will be notified as soon as possible. You will be given the opportunity to correct the problem and the telephone service provider is required to inform you of your right to file a complaint with the FCC. Your telephone service provider may make changes in its facilities, equipment, operation, or procedures that could affect the proper functioning of this product. The telephone service provider is required to notify you if such changes are planned.

If this product is equipped with a corded or cordless handset, it is hearing aid compatible.

If this product has memory dialing locations, you may choose to store emergency telephone numbers (e.g., police, fire, medical) in these locations. If you do store or test emergency numbers, please:

- ▶ Remain on the line and briefly explain the reason for the call before hanging up.
- ▶ Perform such activities in off-peak hours, such as early morning or late evening.

## FCC Part 68 and ACTA

### **Industry Canada**

This device contains licence-exempt transmitter(s)/receiver(s) that comply with Innovation, Science and Economic Development Canada's licence-exempt RSS(s). Operation is subject to the following two conditions:

(1) This device may not cause interference.

(2) This device must accept any interference, including interference that may cause undesired operation of the device.

Privacy of communications may not be ensured when using this telephone.

The term "IC:" before the certification/registration number only signifies that the Industry Canada technical specifications were met.

The Ringer Equivalence Number (REN) for this terminal equipment is 1.0. The REN indicates the maximum number of devices allowed to be connected to a telephone interface. The termination of an interface may consist of any combination of devices subject only to the requirement that the sum of the RENs of all the devices not exceed five.

This product meets the applicable Innovation, Science and Economic Development Canada technical specifications.

## Appendix FCC Part 15

NOTE: This equipment has been tested and found to comply with the requirements for a Class B digital device under Part 15 of the Federal Communications Commission (FCC) rules.

These requirements are intended to provide reasonable protection against harmful interference in a residential installation. This equipment generates, uses and can radiate radio frequency energy and, if not installed and used in accordance with the instructions, may cause harmful interference to radio communications. However, there is no guarantee that interference will not occur in a particular installation.

If this equipment does cause harmful interference to radio or television reception, which can be determined by turning the equipment off and on, the user is encouraged to try to correct the interference by one or more of the following measures:

- ▶ Reorient or relocate the receiving antenna.
- ▶ Increase the separation between the equipment and receiver.
- ▶ Connect the equipment into an outlet on a circuit different from that to which the receiver is connected.
- ▶ Consult the dealer or an experienced radio/TV technician for help.

WARNING: Changes or modifications to this equipment not expressly approved by the party responsible for compliance could void the user's authority to operate the equipment.

This device complies with Part 15 of the FCC rules. Operation is subject to the following two conditions: (1) this device may not cause harmful interference, and (2) this device must accept any interference received, including interference that may cause undesired operation. Privacy of communications may not be ensured when using this telephone.

To ensure safety of users, the FCC has established criteria for the amount of radio frequency energy that can be safely absorbed by a user or bystander according to the intended usage of the product. This product has been tested and found to comply with the FCC criteria. The handset may be safely held against the ear of the user. The telephone base shall be installed and used such that parts of the user's body other than the hands are maintained at a distance of approximately 20cm (8 inches) or more.

This Class B digital apparatus complies with Canadian requirement:  
CAN ICES-3 (B)/NMB-3(B)



## Limited warranty

The AT&T brand is used under license - any repair, replacement or warranty service, and all questions about this product should be directed to our website at

**<https://telephones.att.com>** or call **1 (800) 222-3111**. In Canada, dial **1 (866) 288-4268**.

### 1. What does this limited warranty cover?

The manufacturer of this AT&T branded product warrants to the holder of a valid proof of purchase (“CONSUMER” or “you”) that the product and all accessories provided in the sales package (“PRODUCT”) are free from defects in material and workmanship, pursuant to the following terms and conditions, when installed and used normally and in accordance with the PRODUCT operating instructions. This limited warranty extends only to the CONSUMER for products purchased and used in the United States of America and Canada.

### 2. What will be done if the PRODUCT is not free from defects in materials and workmanship during the limited warranty period (“materially defective PRODUCT”)?

During the limited warranty period, the manufacturer’s authorized service representative repairs or replaces at the manufacturer’s option, without charge, a materially defective PRODUCT. If the manufacturer repairs the PRODUCT, they may use new or refurbished replacement parts. If the manufacturer chooses to replace the PRODUCT, they may replace it with a new or refurbished PRODUCT of the same or similar design. The manufacturer will retain the defective parts, modules, or equipment. Repair or replacement of the PRODUCT, at the manufacturer’s option, is your exclusive remedy. The manufacturer returns the repaired or replacement products to you in working condition. You should expect the repair or replacement to take approximately 30 days.

### 3. How long is the limited warranty period?

The limited warranty period for the PRODUCT extends for ONE (1) YEAR from the date of purchase. If the manufacturer repairs or replaces a materially defective PRODUCT under the terms of this limited warranty, this limited warranty also applies to repaired or replacement PRODUCT for a period of either (a) 90 days from the date the repaired or replacement PRODUCT is shipped to you or (b) the time remaining on the original one-year limited warranty; whichever is longer.

### 4. What is not covered by this limited warranty?

This limited warranty does not cover:

- ▶ PRODUCT that has been subjected to misuse, accident, shipping or other physical damage, improper installation, abnormal operation or handling, neglect, inundation, fire, water, or other liquid intrusion; or
- ▶ PRODUCT that has been damaged due to repair, alteration, or modification by anyone other than an authorized service representative of the manufacturer; or
- ▶ PRODUCT to the extent that the problem experienced is caused by signal conditions, network reliability or cable or antenna systems; or
- ▶ PRODUCT to the extent that the problem is caused by use with non-AT&T accessories; or
- ▶ PRODUCT whose warranty/quality stickers, PRODUCT serial number plates or electronic serial numbers have been removed, altered or rendered illegible; or
- ▶ PRODUCT purchased, used, serviced, or shipped for repair from outside the United States of America or Canada, or used for commercial or institutional purposes (including but not limited to products used for rental purposes); or
- ▶ PRODUCT returned without a valid proof of purchase (see item 6); or
- ▶ Charges for installation or setup, adjustment of customer controls, and installation or repair of systems outside the unit.

## Limited warranty

### 5. How do you get warranty service?

To obtain warranty service in the United States of America, visit

**<https://telephones.att.com>** or call **1 (800) 222-3111**. In Canada, please dial **1 (866) 288-4268**.

NOTE: Before calling for service, please review the user's manual. A check of the PRODUCT's controls and features might save you a service call.

Except as provided by applicable law, you assume the risk of loss or damage during transit and transportation and are responsible for delivery or handling charges incurred in the transport of the PRODUCT(s) to the service location. The manufacturer will return repaired or replaced PRODUCT under this limited warranty. Transportation, delivery or handling charges are prepaid. The manufacturer assumes no risk for damage or loss of the PRODUCT in transit. If the PRODUCT failure is not covered by this limited warranty, or proof of purchase does not meet the terms of this limited warranty, the manufacturer notifies you and requests that you authorize the cost of repair prior to any further repair activity. You must pay for the cost of repair and return shipping costs for the repair of products that are not covered by this limited warranty.

### 6. What must you return with the PRODUCT to get warranty service?

You must:

- a. Return the entire original package and contents including the PRODUCT to the service location along with a description of the malfunction or difficulty; and
- b. Include "valid proof of purchase" (sales receipt) identifying the PRODUCT purchased (PRODUCT model) and the date of purchase or receipt; and
- c. Provide your name, complete and correct mailing address, and telephone number.

### 7. Other limitations

This warranty is the complete and exclusive agreement between you and the manufacturer of this AT&T branded PRODUCT. It supersedes all other written or oral communications related to this PRODUCT. The manufacturer provides no other warranties for this PRODUCT. The warranty exclusively describes all of the manufacturer's responsibilities regarding the PRODUCT. There are no other express warranties. No one is authorized to make modifications to this limited warranty and you should not rely on any such modification.

State/Provincial Law Rights: This warranty gives you specific legal rights, and you might also have other rights that vary from state to state or province to province.

Limitations: Implied warranties, including those of fitness for a particular purpose and merchantability (an unwritten warranty that the PRODUCT is fit for ordinary use) are limited to one year from date of purchase. Some states/provinces do not allow limitations on how long an implied warranty lasts, so the above limitation might not apply to you. In no event shall the manufacturer be liable for any indirect, special, incidental, consequential, or similar damages (including, but not limited to lost profits or revenue, inability to use the PRODUCT or other associated equipment, the cost of substitute equipment, and claims by third parties) resulting from the use of this PRODUCT. Some states/provinces do not allow the exclusion or limitation of incidental or consequential damages, so the above limitation or exclusion might not apply to you.

**Please retain your original sales receipt as proof of purchase.**

# Technical specifications

RF frequency band	1921.536MHz — 1928.448MHz
Channels	5
Telephone base voltage (AC voltage, 60Hz)	96 — 129 Vrms
Telephone base voltage (DC adapter output)	6VDC @400mA
Handset voltage	2.4 VDC, AAA x 2, Ni-MH
Charger voltage (AC adapter output)	6VDC @400mA
Operating times*	Talk time (handset): up to 10 hours Standby: up to 5 days

\* Operating times vary depending on your actual use and the age of the battery.

## **DECT 6.0 digital technology**

The AT&T DECT 6.0 products offer unsurpassed range performance and sound clarity. This is achieved through a unique antenna design and advances in noise-filtering technology. An independent laboratory has confirmed that AT&T DECT 6.0 products perform up to 45% better in range competitions against similarly equipped phones of the leading competition. Now, calls can be taken in the basement, backyard and garage with exceptional sound quality.

## **Telephone operating range**

This cordless telephone operates within the maximum power allowed by the Federal Communications Commission (FCC). Even so, this handset and telephone base can communicate over a certain distance — which can vary with the locations of the telephone base and handset, the weather, and the construction of your home or office.

## **Redefining long range coverage and clarity**

This telephone base comes with an antenna which gives much better clarity and covers a longer range than before.

## **Simulated full-duplex handset and base speakerphones**

The simulated full-duplex speakerphones on your handset and telephone base allow both ends of a call to speak and be heard at the same time. Optimal performance is subject to external factors and individual usage.

Index  
Index

---

**A**

Add a Bluetooth headset 17  
Add a cell phone 16  
Add a handset 84  
Alerts manager 15  
Allow list 55  
Announcement 72  
Answer a cell call 29  
Answer a home call 28  
Answering system and voicemail 77  
Answering system settings 72–76  
Answer on/off 73

---

**B**

Battery charging 8–9  
Battery installation 8–10  
Block list 50  
Bluetooth features 13–14  
Bluetooth setup 16–18

---

**C**

Call intercept 79  
Call screening 74, 78  
Call transfer 36–37  
Caller ID (CID)  
    add entries to phone directory 41  
    dial entries 41  
    review entries 40  
Caller ID manager 15  
Calls without numbers 46  
Cell call 28  
Cell phone download directory 18  
Charger installation 7  
Charging 8–9  
Clear voicemail indicator/  
    indication 25  
Clock 24  
Connect to Cell 15

---

**D**

Date 24  
Delete  
    a caller ID log entry 44  
    a directory entry 39  
Delete a message 80–81  
Directory  
    delete entries 39  
    dial entries 38  
    edit entries 39  
    name search 38  
    new entries 37  
    review entries 38  
DSL 6, 11

---

**E**

End a cell call 29  
End a home call 28  
Expand your telephone  
    system 84–85

---

**F**

Find handset 33  
Flash (switch hook flash) 29

---

**H**

Handset locator 33  
Headset 17, 28

---

**I**

Important safety information 98–100  
Intercom 35–36

---

**L**

LCD language 23  
Limited warranty 107–108  
Listening volume 31

Index  
Index

**M**

---

Maintenance 97  
Make a cell call 28, 29  
Make a home call 28  
Memos 82  
Message alert tone 76  
Message capacity 78  
Message playback 80–81  
Missed calls 40  
Mute 31

**N**

---

Number of rings 75

**O**

---

Operating range 109  
Outgoing announcement 72

**P**

---

Paging 33  
Pulse dialing 26

**Q**

---

Quick reference guide 1–5  
Quiet mode 27

**R**

---

Receive a cell call 29  
Receive a home call 28  
Record announcement 72  
Redial 33  
Remote access 75, 83  
Remote voice control 19–21  
Repeat messages 80–81  
Replace a handset 86  
Ringer tone 23  
Ringer volume 22

**S**

---

Safety information 98–100  
Save a caller ID log entry to the allow list 42  
Save a caller ID log entry to the block list 43  
Save a caller ID log entry to the directory 41  
Save a caller ID log entry to the star name list 43  
Set date/time 24  
Share an outside call 34, 36  
Silencing the ringer 29  
Skip messages 80  
Smart call blocker 45–83  
    allowed calls 66  
    allow list 55  
    blocked calls 66  
    block list 50  
    call controls 47  
    option while on a call 71  
    screening announcements 62  
    screen robocalls 70  
    screen unknown home calls 67–69  
    set profile 49–50  
    set Smart call blocker on/off 49  
    star name list 59  
Star name list 59  
Stop messages 80–81

## **T**

---

- Telephone base installation 6
- Telephone operating range 109
- Temporary tone dialing 32
- Time 24
- Transfer a call 36
- Troubleshooting 87–96
- Turn on or off the answering system 73

## **U**

---

- Uncategorized calls 46
- Unwelcome calls 46
- Use a Bluetooth headset 28

## **V**

---

- Voice control 19–21
- Voice guide 65, 74
- Voice guide to set Answering system 74
- Voice guide to set Smart call blocker 65
- Voicemail 77
- Volume 22, 31, 80–81

## **W**

---

- Wall-mounting 11–12
- Warranty 107–108
- Welcome calls 46

# Remote access wallet card

The wallet card lists the commands needed to control your answering system from any touch-tone telephone.

Cut along dotted line.



Call your telephone number, then enter your 2-digit remote access code (preset to **19**).

Action	Remote command
--------	----------------

Play all messages.....	<b>1</b>
Play new messages.....	<b>2</b>
Delete the message .....	<b>3</b> (during message playback)
Delete all old messages .....	<b>33</b>
Repeat or go back.....	<b>4</b>

Fold here.

Stop .....	<b>5</b>
Help menu.....	<b>*5</b>
Skip the message.....	<b>6</b>
Record announcement.....	<b>*7</b>
Turn system on or off.....	<b>0</b>
End remote access call.....	<b>8</b> (or hang up)

**DL72210/DL72310/DL72340/DL72350 DECT 6.0 cordless telephone/answering system with BLUETOOTH® wireless technology**

© 2020 Advanced American Telephones. All Rights Reserved.  
AT&T and the AT&T logo are trademarks of AT&T Intellectual Property licensed to Advanced American Telephones, San Antonio, TX 78219.  
Printed in China.



**For more detailed instructions, refer to the online Complete user's manual at  
<https://telephones.att.com/manuals>.**

**For customer service or product information, please visit our website at  
<https://telephones.att.com> or call 1 (800) 222-3111.  
In Canada, dial 1 (866) 288-4268.**

The *Bluetooth*® word mark and logos are owned by Bluetooth SIG, Inc. and any use of such marks by Advanced American Telephones and its parent, VTech Holdings Limited, is under license. VTech Holdings Limited is a member of Bluetooth SIG, Inc. Other trademarks and trade names are those of their respective owners.

© 2020 Advanced American Telephones. All Rights Reserved.

AT&T and the AT&T logo are trademarks of AT&T Intellectual Property licensed to  
Advanced American Telephones, San Antonio, TX 78219.

Siri® is a registered trademark of Apple Inc.

IOS is a trademark or registered trademark of Cisco in the U.S. and other countries and is used under license.

Connect to Cell™ is a trademark of Advanced American Telephones.

Android® and Google Play® are registered trademarks of Google Inc.

Google Now™ is a trademark of Google Inc.

Qaltel™ is a trademark of Truecall Group Limited.

S Voice® is a registered mark of Samsung Electronics Co., Ltd.

RBRC® and 1-800-8-BATTERY® are registered trademarks of the Rechargeable Battery Recycling Corporation.

Printed in China. Issue 1.0 AT&T 02/20.