



Valued Quality. Delivered.

TEST REPORT

Report Number: 17010545HKG-001

Application
for
Original Grant of 47 CFR Part 15 Certification
New Family of RSS-247 Issue 1 Equipment Certification

Video Monitor - Baby Unit

FCC ID: EW780-0621-00

IC: 1135B-80062100

Prepared and Checked by:

Approved by:

Signed on File
Yao Xin Lu, Josie
Engineer

Koo Wai Ip
Technical Supervisor
February 10, 2017

- Intertek's standard Terms and Conditions can be obtained at our website: <http://www.intertek.com/terms/>.
- The test report only allows to be revised within the retention period unless further standard or the requirement was noticed.
- This report is for the exclusive use of Intertek's Client and is provided pursuant to the agreement between Intertek and its Client. Intertek's responsibility and liability are limited to the terms and conditions of the agreement. Intertek assumes no liability to any party, other than to the Client in accordance with the agreement, for any loss, expense or damage occasioned by the use of this report. Only the Client is authorized to permit copying or distribution of this report and then only in its entirety. Any use of the Intertek name or one of its marks for the sale or advertisement of the tested material, product or service must first be approved in writing by Intertek. The observations and test results in this report are relevant only to the sample tested. This report by itself does not imply that the material, product, or service is or has ever been under an Intertek certification program.
- © 2016 Intertek

Intertek Testing Services Hong Kong Ltd.

2/F., Garment Centre, 576 Castle Peak Road, Kowloon, Hong Kong.
Tel: (852) 2173 8888 Fax: (852) 2785 5487 Website: www.hk.intertek-etlsemko.com

INTERTEK TESTING SERVICES

GENERAL INFORMATION

Applicant Name:	VTech Telecommunications Ltd.
Applicant Address:	23/F., Tai Ping Industrial Centre, Block 1, 57 Ting Kok Road, Tai Po, Hong Kong.
FCC Specification Standard:	FCC Part 15, October 1, 2015 Edition
FCC ID:	EW780-0621-00
FCC Model(s):	VM5271 BU, VM5271-2 BU, VM5x71-ab BU, VM5231, VM5231-ab
IC Specification Standard:	RSS-247 Issue 1, May 2015 RSS-Gen Issue 4, December 2014
IC:	1135B-80062100
HVIN:	VM5271 BU, VM5271-2 BU, VM5231
PMN:	Video monitor
Type of EUT:	Spread Spectrum Transmitter
Description of EUT:	Video Monitor - Baby Unit
Serial Number:	N/A
Sample Receipt Date:	January 13, 2017
Date of Test:	January 20 to February 09, 2017
Report Date:	February 10, 2017
Environmental Conditions:	Temperature: +10 to 40°C Humidity: 10 to 90%

INTERTEK TESTING SERVICES

Table of Contents

1.0 Test Results Summary & Statement of Compliance	4
1.1 Summary of Test Results	4
1.2 Statement of Compliance	4
2.0 General Description	6
2.1 Product Description	6
2.3 Test Methodology	6
2.4 Test Facility	6
3.0 System Test Configuration	8
3.1 Justification	8
3.2 EUT Exercising Software	9
3.3 Details of EUT and Description of Accessories	10
3.4 Measurement Uncertainty	10
4.0 Test Results	12
4.1 Maximum Conducted Output Power at Antenna Terminals	12
4.2 Maximum 20 dB RF Bandwidth	15
4.3 Minimum Number of Hopping Frequencies	18
4.4 Minimum Hopping Channel Carrier Frequency Separation	20
4.5 Average Channel Occupancy Time	22
4.6 Out of Band Conducted Emissions	26
4.7 Field Strength Calculation	31
4.8 Transmitter Radiated Emissions in Restricted Bands and Spurious Emissions	32
4.8.1 Radiated Emission Configuration Photograph	33
4.8.2 Radiated Emission Data	33
4.8.4 Radiated Emission Test Setup	34
4.8.3 Transmitter Duty Cycle Calculation	47
4.9 AC Power Line Conducted Emission	50
4.9.1 AC Power Line Conducted Emission Configuration Photograph	50
4.9.2 AC Power Line Conducted Emission Data	50
4.9.3 AC Line Conducted Emission Test Setup	59
5.0 Equipment List	61

INTERTEK TESTING SERVICES

**EXHIBIT 1
TEST RESULTS SUMMARY & STATEMENT OF COMPLIANCE**

INTERTEK TESTING SERVICES

1.0 Test Results Summary & Statement of Compliance

1.1 Summary of Test Results

Test Items	FCC Part 15 Section	RSS-247/ RSS-Gen# Section	Results	Details see section
Antenna Requirement	15.203	8.3 [#]	Pass	2.1
Max. Conducted Output Power	15.247(b)(1) & (4)	5.4(2)	Pass	4.1
Max. 20dB RF Bandwidth	N/A	5.1(1)	N/A	4.2
Min. No. of Hopping Frequencies	15.247(a)(1)(iii)	5.1(4)	Pass	4.3
Min. Hopping Channel Carrier Frequency Separation	15.247(a)(1)	5.1(2)	Pass	4.4
Average Time of Occupancy	15.247(a)(1)(iii)	5.1(4)	Pass	4.5
Out of Band Antenna Conducted Emission	15.247(d)	5.5	Pass	4.6
Radiated Emission in Restricted Bands and Spurious Emissions	15.247(d)	8.10 [#]	Pass	4.8
AC Power Line Conducted Emission	15.207 & 15.107	8.8 [#]	Pass	4.9

Note: Pursuant to FCC Part 15 Section 15.215(c), the 20dB bandwidth of the emission was contained within the frequency band designated (mentioned as above) which the EUT operated. The effects, if any, from frequency sweeping, frequency hopping, other modulation techniques and frequency stability over expected variations in temperature and supply voltage were considered.

1.2 Statement of Compliance

The equipment under test is found to be complying with the following standards:

FCC Part 15, October 1, 2015 Edition
RSS-247 Issue 1, May 2015
RSS-Gen Issue 4, November 2014

INTERTEK TESTING SERVICES

**EXHIBIT 2
GENERAL DESCRIPTION**

INTERTEK TESTING SERVICES

2.0 General Description

2.1 Product Description

The Equipment Under Test (EUT) is a Video Monitor - Baby Unit of Video Baby Monitor. It operates at frequency range of 2406MHz to 2475MHz. There are totally 24 non-overlapping channels with 3MHz channel separation and 17 active channels out of the 24 channels. The EUT is powered by a 100-240VAC 200mA to 6.0VDC 600mA AC adaptor.

The antenna used in the EUT is integral, and the test sample is a prototype.

For FCC, the Model(s) VM5271-2 BU, VM5x71-ab BU, VM5231 and VM5231-ab are the same as model VM5271 BU in electronics/electrical designs including software & firmware, PCB layout and construction design/physical design/enclosure. The only differences between these models are color and model number to be sold for marketing purpose. Suffix (a, b, x) indicates different type packaging, different number of baby unit and different color of enclosure.

For IC, the Model(s): VM5271-2 BU and VM5231 are the same as the Model: VM5271 BU in electronics/electrical designs including software & firmware, PCB layout and construction design/physical design/enclosure. The only differences between these models are color and model number to be sold for marketing purpose.

The circuit description and frequency hopping algorithm are attached in the Appendix and saved with filename: descri.pdf.

2.2 Test Methodology

Both AC power line-conducted and radiated emission measurements were performed according to the procedures in ANSI C63.4 (2014). Preliminary radiated scans and all radiated measurements were performed in radiated emission test sites. All Radiated tests were performed at an antenna to EUT distance of 3 meters, unless stated otherwise in the "**Justification Section**" of this Application. Antenna port conducted measurements were performed according to ANSI C63.10 (2013). All other measurements were made in accordance with the procedures in 47 CFR Part 2.

2.3 Test Facility

The radiated emission test site, AC power line conducted measurement facility and antenna port conducted measurement facility used to collect the radiated data, AC Power Line conducted data, and conductive data are at Intertek Testing Services Hong Kong Ltd., which is located at Workshop No. 3, G/F., World-Wide Industrial Centre, 43-47 Shan Mei Street, Fo Tan, Sha Tin, N.T., Hong Kong. This test facility and site measurement data have been fully placed on file with FCC and Industry Canada No. 2042V.

INTERTEK TESTING SERVICES

**EXHIBIT 3
SYSTEM TEST CONFIGURATION**

INTERTEK TESTING SERVICES

3.0 System Test Configuration

3.1 Justification

For radiated emissions testing, the equipment under test (EUT) was setup to transmit / receive continuously to simplify the measurement methodology. Care was taken to ensure proper power supply voltages during testing. During testing, all cables (if any) were manipulated to produce worst case emissions.

The EUT was powered by a 100-240VAC 200mA to 6.0VDC 600mA AC adaptor.

For the measurements, the EUT was attached to a plastic stand if necessary and placed on the wooden turntable. If the base unit attached to peripherals, they were connected and operational (as typical as possible). The parent unit was remotely located as far from the antenna and the base as possible to ensure full power transmission from the baby unit. Else, the base was wired to transmit full power with modulation.

The signal was maximized through rotation and placement in the three orthogonal axes. The antenna height and polarization were varied during the search for maximum signal level. The antenna height was varied from 1 to 4 meters. Radiated emissions were taken at three meters unless the signal level was too low for measurement at that distance. If necessary, a pre-amplifier was used and/or the test was conducted at a closer distance.

For any intentional radiator powered by AC power line, measurements of the radiated signal level of the fundamental frequency component of the emission was performed with the supply voltage varied between 85% and 115% of the nominal rated supply voltage.

For transmitter radiated measurement, the spectrum analyzer resolution bandwidth was 100 kHz for frequencies below 1000 MHz. The resolution bandwidth was 1 MHz for frequencies above 1000 MHz.

Radiated emission measurement for transmitter were performed from the lowest radio frequency signal generated in the device which is greater than 9 kHz to the tenth harmonic of the highest fundamental frequency or to 40 GHz, whichever is lower. Receiver was performed from 30MHz to the fifth harmonic of the highest frequency or 40GHz, whichever is lower.

INTERTEK TESTING SERVICES

3.1 Justification - Cont'd

Emission that are directly caused by digital circuits in the transmit path and transmitter portion were measured, and the limit are according to FCC Part 15 Section 15.109.

Detector function for radiated emissions was in peak mode. Average readings, when required, were taken by measuring the duty cycle of the equipment under test and subtracting the corresponding amount in dB from the measured peak readings. A detailed description for the calculation of the average factor can be found in Exhibit 4.8.3.

Determination of pulse desensitization was made according to *Hewlett Packard Application Note 150-2, Spectrum Analysis... Pulsed RF*. The effective period (Teff) was referred to Exhibit 4.8.3. With the resolution bandwidth 1MHz and spectrum analyzer IF bandwidth 3dB, the pulse desensitization factor was 0dB.

For AC line conducted emission test, the EUT along with its peripherals were placed on a 1.0m(W)x1.5m(L) and 0.8m in height wooden table and the EUT was adjusted to maintain a 0.4 meter space from a vertical reference plane. The EUT was connected to power mains through a line impedance stabilization network (LISN), which provided 50ohm coupling impedance for measuring instrument. The LISN housing, measuring instrument case, reference ground plane, and vertical ground plane were bounded together. The excess power cable between the EUT and the LISN was bundled.

All connecting cables of EUT and peripherals were manipulated to find the maximum emission.

All relevant operation modes have been tested, and the worst case data is included in this report.

3.2 EUT Exercising Software

The EUT exercise program used during radiated and conducted testing was designed to exercise the various system components in a manner similar to a typical use.

INTERTEK TESTING SERVICES

3.3 Details of EUT and Description of Accessories

Details of EUT:

An AC adaptor and/or a battery (provided with the unit) was used to power the device. Their description are listed below.

- (1) An AC adaptor (100-240VAC 200mA to 6.0VDC 600mA, Model: S006AKU0600060, Brand: Ten Pao) (Supplied by Client)
- (2) An AC adaptor (100-240VAC 200mA to 6.0VDC 600mA, Model: SSA-5WVI-09 US 060060, Brand: Sunstrong) (Supplied by Client)

Description of Accessories:

- (1) Parent Unit, Model: VM5271 PU, FCC ID: EW780-0621-01 (Supplied by Client)

3.4 Measurement Uncertainty

When determining of the test conclusion, the Measurement Uncertainty of test at a level of confidence of 95% has been considered. The values of the Measurement uncertainty for radiated emission test and RF conducted measurement test are $\pm 5.3\text{dB}$ and $\pm 0.99\text{dB}$ respectively. The value of the Measurement uncertainty for conducted emission test is $\pm 4.2\text{dB}$.

Uncertainty and Compliance - Unless the standard specifically states that measured values are to be extended by the measurement uncertainty in determining compliance, all compliance determinations are based on the actual measured value.

INTERTEK TESTING SERVICES

**EXHIBIT 4
TEST RESULTS**

INTERTEK TESTING SERVICES

4.0 Test Results

RF Conducted measurement Test Setup by a Spectrum Analyzer.

The figure below shows the test setup, which is utilized to make these measurements.

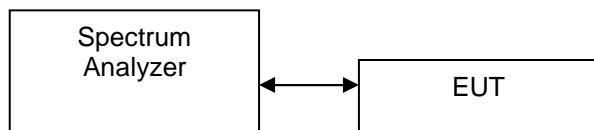

4.1 Maximum Conducted (peak) Output Power at Antenna Terminals

- The antenna power of the EUT was connected to the input of a power meter. Power was read directly and cable loss correction was added to the reading to obtain power at the EUT antenna terminals.
- The antenna port of the EUT was connected to the input of a spectrum analyzer. The analyzer was set for RBW>20dB bandwidth and power was read directly in dBm. External attenuation and cable loss were compensated for using the OFFSET function of the analyzer.

(Baby Unit) Antenna Gain = 2 dBi		
Frequency (MHz)	Output in dBm	Output in mWatt
Low Channel: 2406	18.48	70.469
Middle Channel: 2442	18.02	63.387
High Channel: 2475	18.02	63.387

Cable loss : 0.5 dB External Attenuation : 0 dB

Cable loss, external attenuation: included in OFFSET function
 added to SA raw reading

dBm max. output level = 18.48 dBm

Limits:

- 0.125W (21dBm) for antennas with gains of 6dBi or less
- 0.25W (24dBm) for antennas with gains of 6dBi or less
- 1W (30dBm) for antennas with gains of 6dBi or less
- ___W (___dBm) for antennas with gains more than 6dBi

The plots of conducted output power are saved as below.

INTERTEK TESTING SERVICES

Plots of conducted output power Lowest Channel

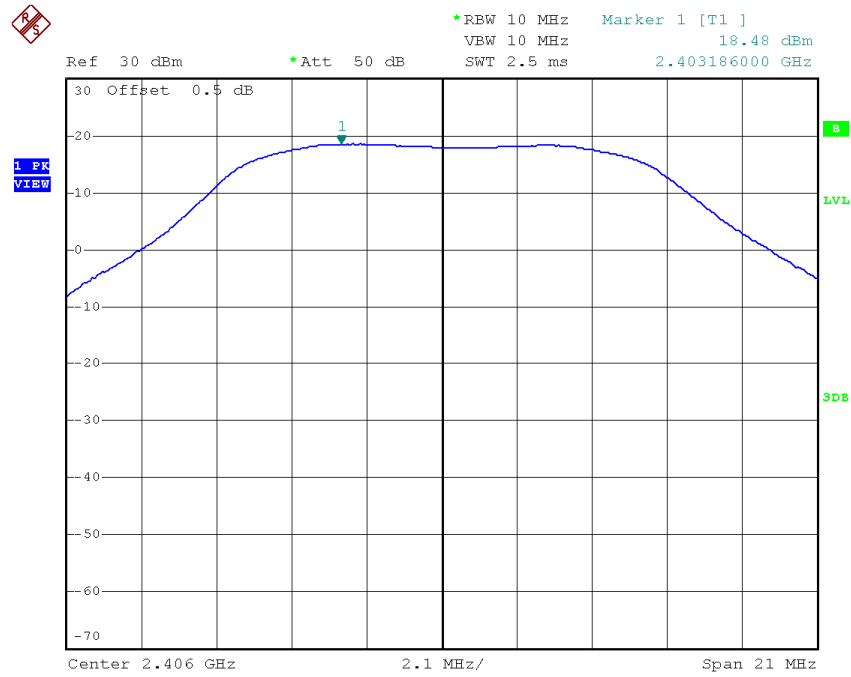

Middle Channel

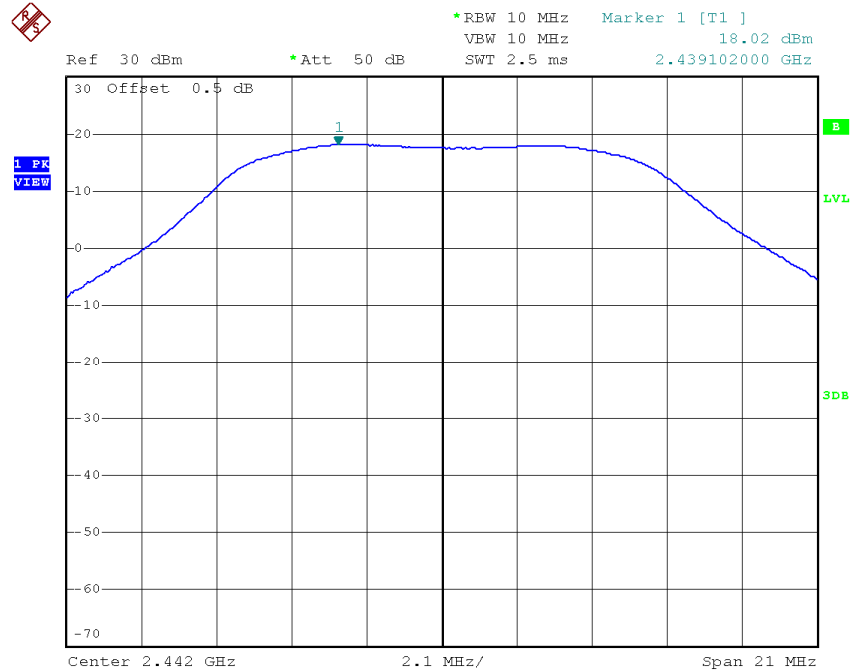

INTERTEK TESTING SERVICES

Plots of conducted output power Highest Channel

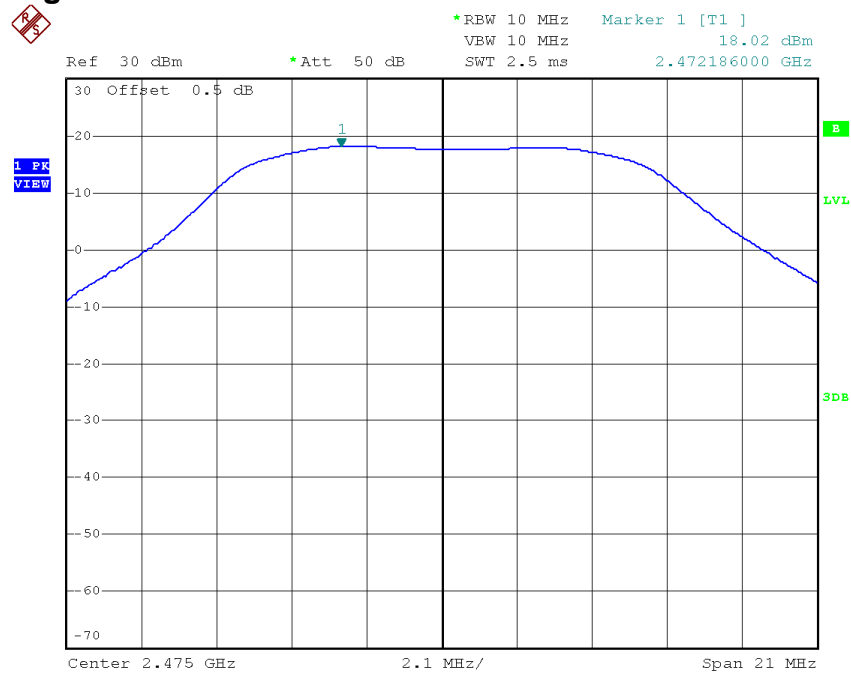

INTERTEK TESTING SERVICES

4.2 Maximum 20 dB RF Bandwidth

The antenna port of the EUT was connected to the input of a spectrum analyzer. Analyzer RES BW was chosen so that the display was a result of the hopping channel modulation. For each RF output channel investigated, the spectrum analyzer center frequency was set to the channel carrier. A PEAK output reading was taken, a DISPLAY line was drawn 20 dB lower than PEAK level. The 20 dB bandwidth was determined from where the channel output spectrum intersected the display line.

Baby Unit	
Frequency (MHz)	20 dB Bandwidth (kHz)
Low Channel: 2406	4312
Middle Channel: 2442	4378
High Channel: 2475	4290

Limits

- $\leq 500\text{kHz}$ for 902-928MHz
- N/A for 2400-2483.5MHz
- $\leq 1\text{MHz}$ for 5725-5850MHz

The plots of 20dB RF bandwidth are saved as below.

INTERTEK TESTING SERVICES

Plots of 20dB RF bandwidth Lowest Channel

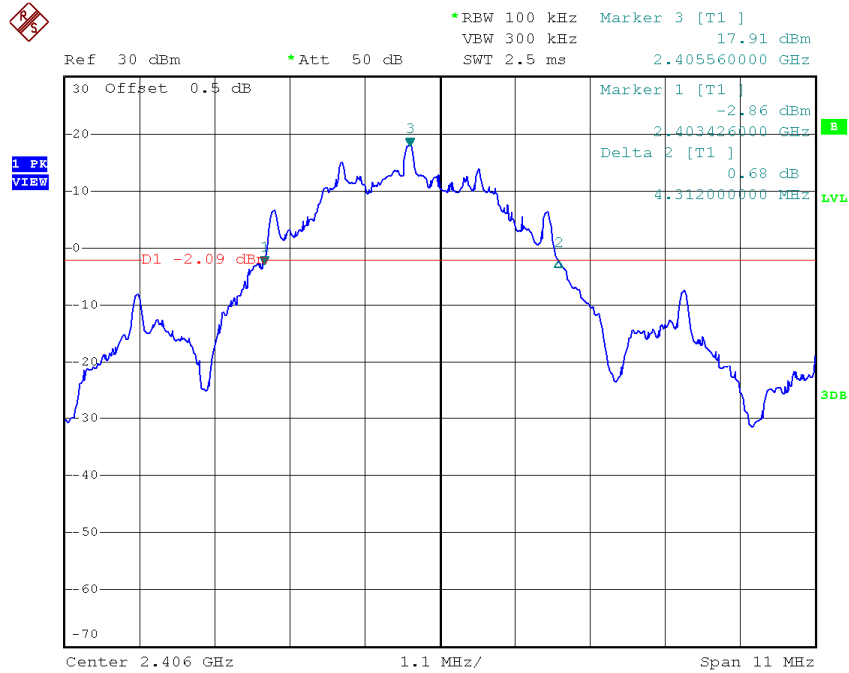

Middle Channel



INTERTEK TESTING SERVICES

Plots of 20dB RF bandwidth Highest Channel

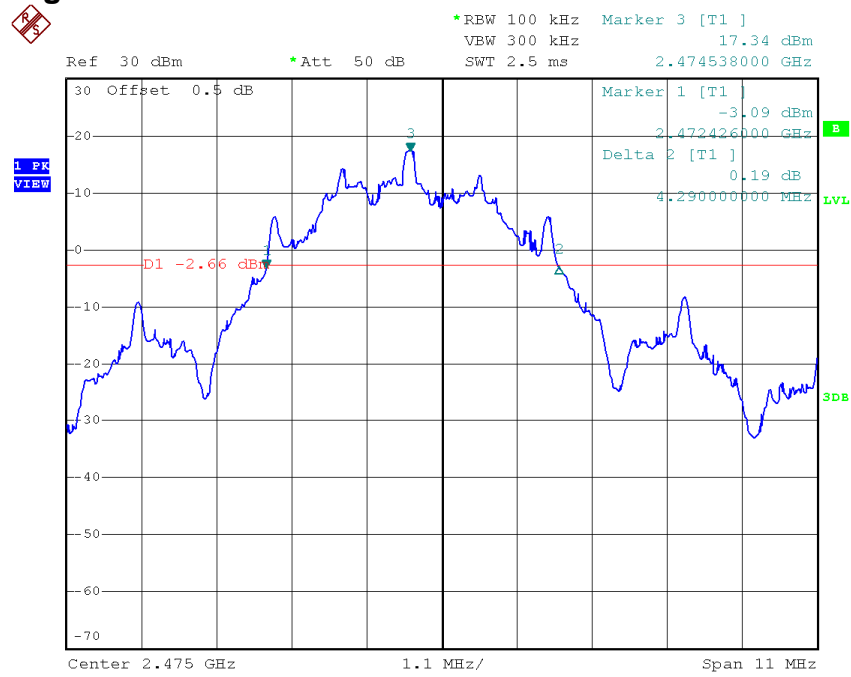

INTERTEK TESTING SERVICES

4.3 Minimum Number of Hopping Frequencies

With the analyzer set to MAX HOLD readings were taken for 2-3 minutes in each band. The channel peaks so recorded were added together, and the total number compared to the minimum number of channels required in the regulation.

Baby Unit	
No. of hopping channels	17

Minimum Requirements:

- at least 50 hopping channels for 902MHz-928MHz (20 dB bandwidth of hopping channel < 250kHz)
- at least 25 hopping channels for 902MHz-928MHz (20 dB bandwidth of hopping channel \geq 250kHz)
- at least 15 hopping channels for 2400MHz-2483.5MHz.
- at least 75 hopping channels for 5725MHz-5850MHz.

The plots of number of hopping frequencies are saved as below.

Plots of Number of Hopping Frequencies
Plot A

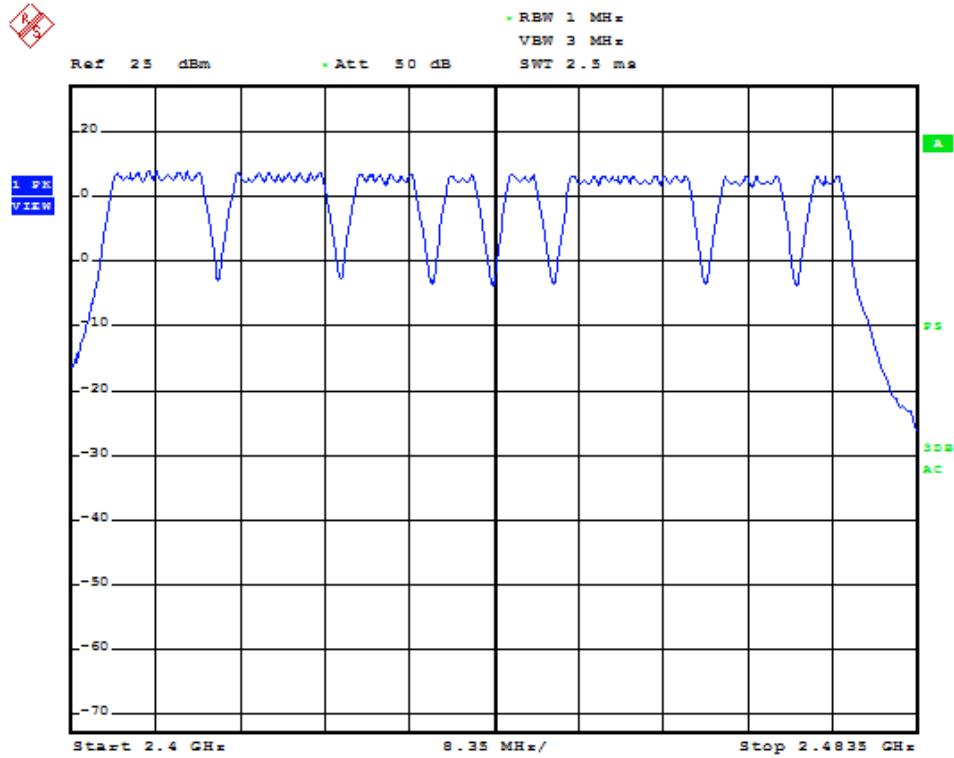

INTERTEK TESTING SERVICES

4.4 Minimum Hopping Channel Carrier Frequency Separation

Using the DELTA MARKER function of the analyzer, the frequency separation between two adjacent channels was measured and met the requirement.

Baby Unit	
Channel Separation (Channel 1 and Channel 2)	2980

Limits:

The channel separation must be larger than:

- 25 kHz
- 20 dB bandwidth of hopping channel: ____ Hz
- 2/3 of 20dB bandwidth of hopping channel: 2919 kHz

The plot(s) of hopping channel carrier frequency separation is saved as below.

Plots of Hopping Channel Carrier Frequency Separation

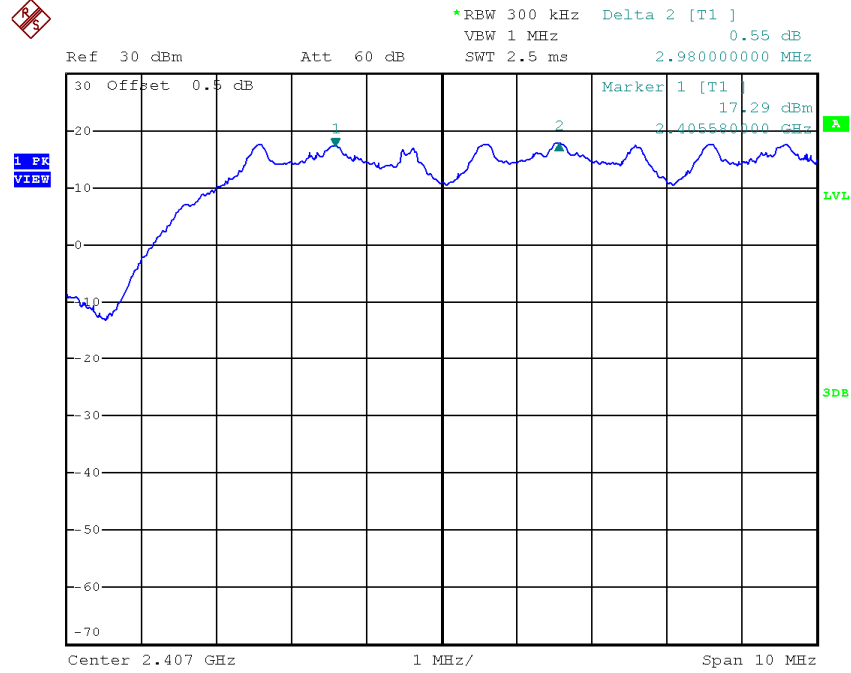

INTERTEK TESTING SERVICES

4.5 Average Channel Occupancy Time

The spectrum analyzer center frequency was set to one of the known hopping channels. The SWEEP was set to 1ms, the SPAN was set to ZERO SPAN, and the TRIGGER was set to VIDEO. The time duration of the transmission so captured was measured with the MARKER DELTA function.

The SWEEP was then set to the time required by the regulation (20 seconds for 902-928 MHz devices, if the 20dB bandwidth is less than 250kHz, 10 seconds for 902-928 MHz if the 20dB bandwidth is or greater than 250kHz, "0.4 seconds x Number of hopping channels employed" seconds for 2400-2483.5 MHz, 30 seconds for 5725-5850 MHz). The analyzer was set to SINGLE SWEEP, the total ON time was added and compared against the limit (0.4 seconds).

Baby Unit (worst-case: 1 parent unit operation)	
Average Occupancy Time (Traffic – in a clear RF environment) =	0.592ms x 7 x 12 x 6.8 = 338.15ms

Limits:

Average 0.4 seconds maximum occupancy in:

- 6.8 seconds (0.4 sec. x 17) for 2400MHz-2483.5MHz
(Traffic – in a clear RF environment)
- 20 seconds for 902MHz-928MHz \geq 50 hopping channels
- 10 seconds for 902MHz-928MHz \geq 25 hopping channels
- 30 seconds for 5725-5850MHz

The plots of average channel occupancy time are saved as below.

INTERTEK TESTING SERVICES

Plots Average Channel Occupancy Time

Plot A

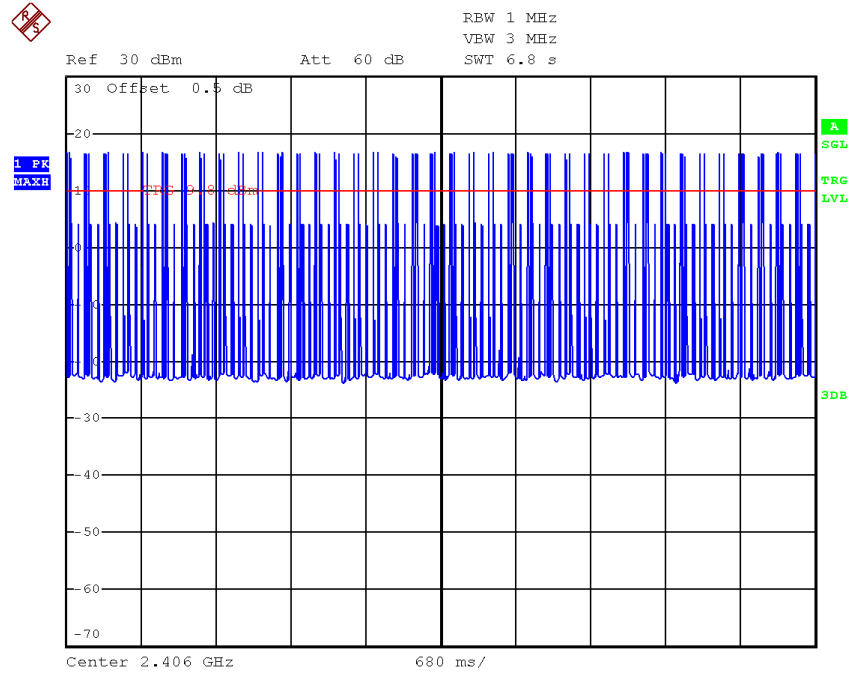

Plot B

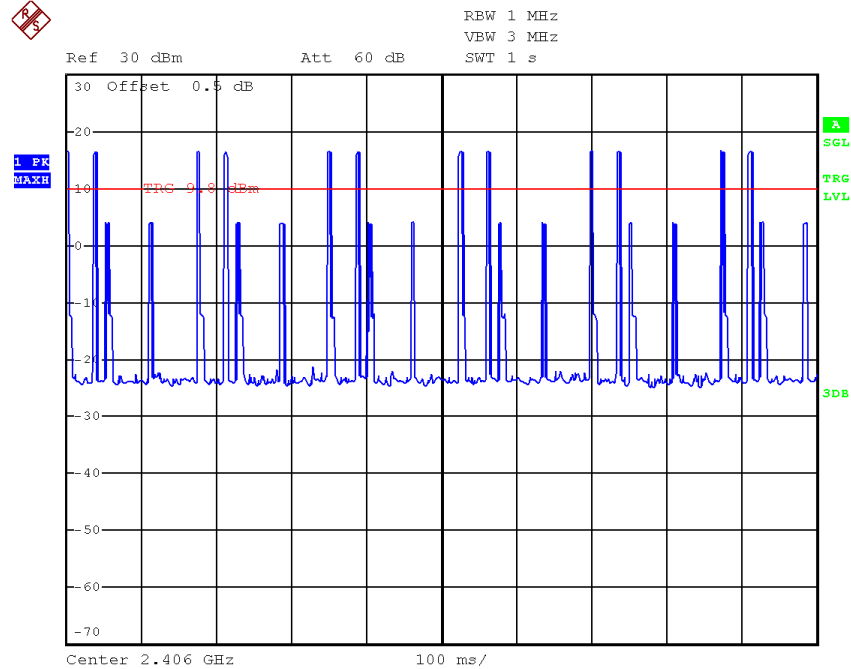

INTERTEK TESTING SERVICES

Plots Average Channel Occupancy Time

Plot C

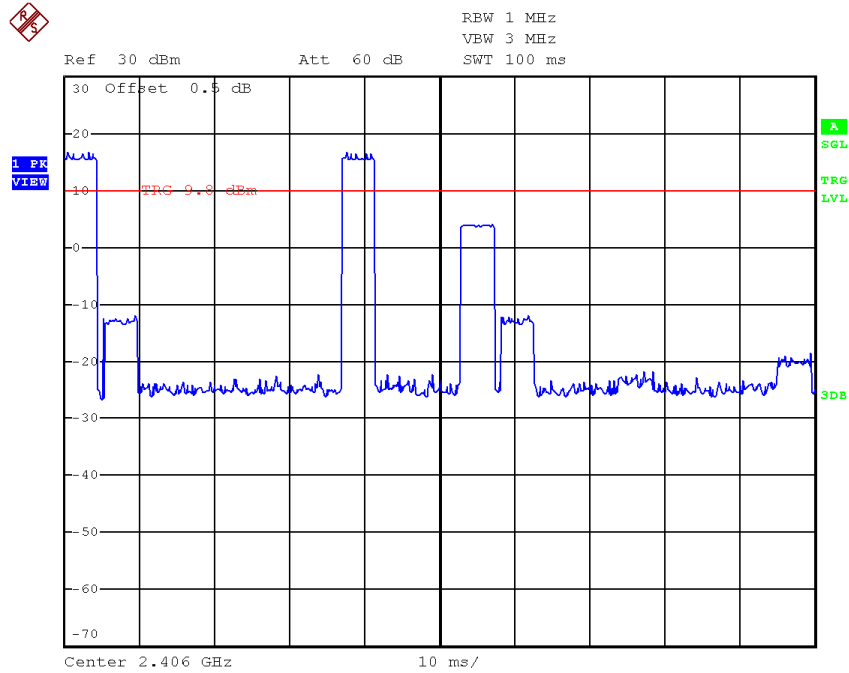

Plot D

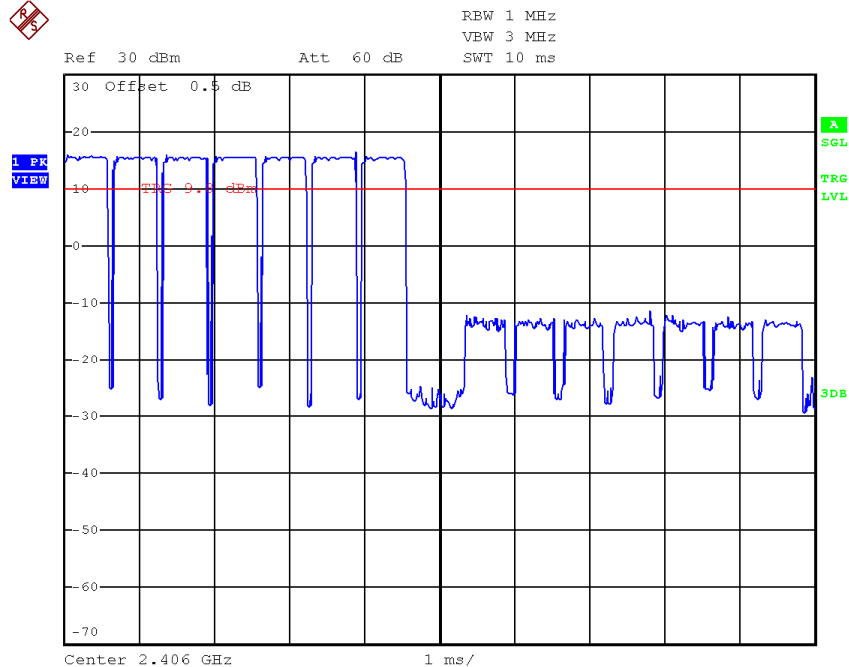

INTERTEK TESTING SERVICES

Plot E

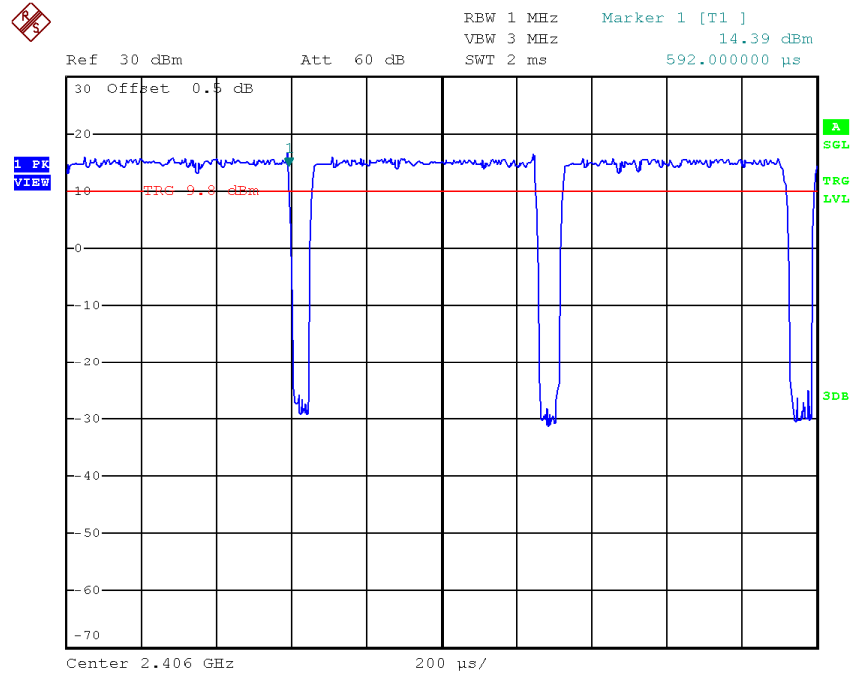

INTERTEK TESTING SERVICES

4.6 Out of Band Conducted Emissions

In any 100 kHz bandwidth outside the EUT passband, the RF power produced by the modulation products of the spreading sequence, the information sequence, and the carrier frequency shall be at least 20 dB below that of the maximum in-band 100 kHz emission.

The plot(s) of bandedge compliance is shown the worst-case which has been already considered between enable and disable the hopping function of the EUT.

Furthermore, delta measurement technique for measuring bandedge emissions was incorporated in the test of the edge at 2483.5MHz.

Limits:

All spurious emission and up to the tenth harmonic was measured and they were found to be at least 20 dB below the highest level of the desired power in the passband.

The plots of out of band conducted emissions are saved as below.

INTERTEK TESTING SERVICES

Plots of Out of Band Conducted Emissions Lowest Channel, Plot 1

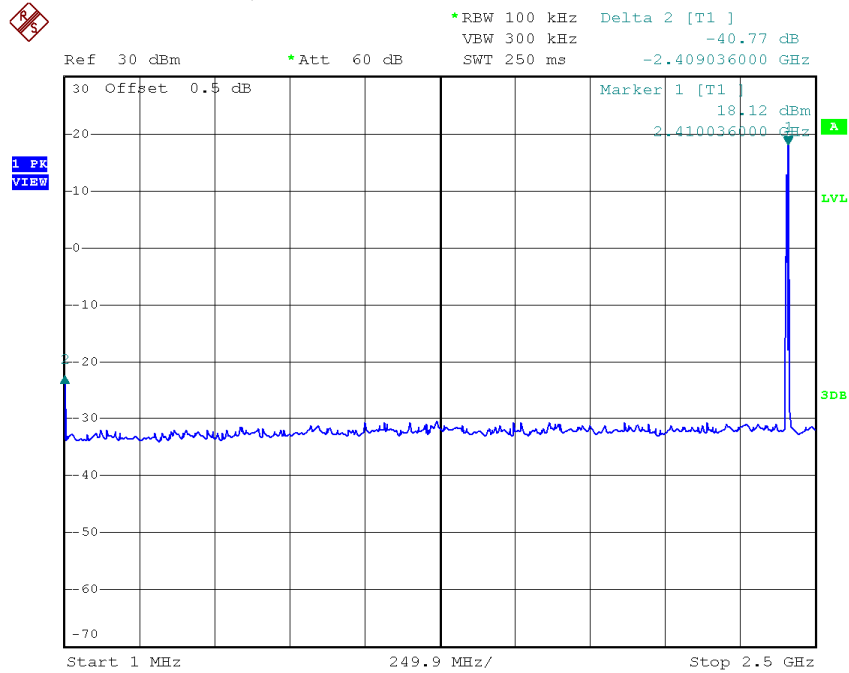

Lowest Channel, Plot 2

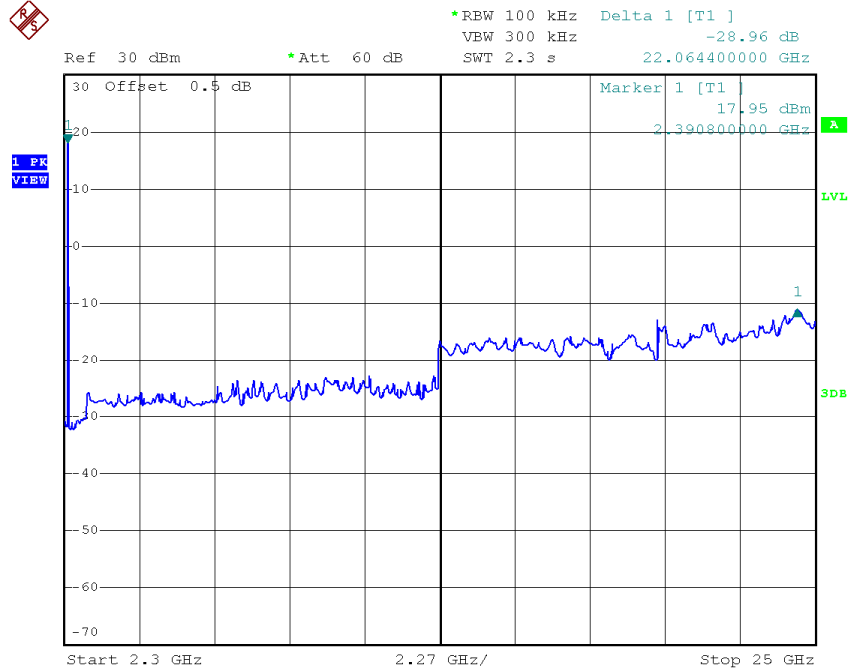

INTERTEK TESTING SERVICES

Plots of Out of Band Conducted Emissions Middle Channel, Plot 1

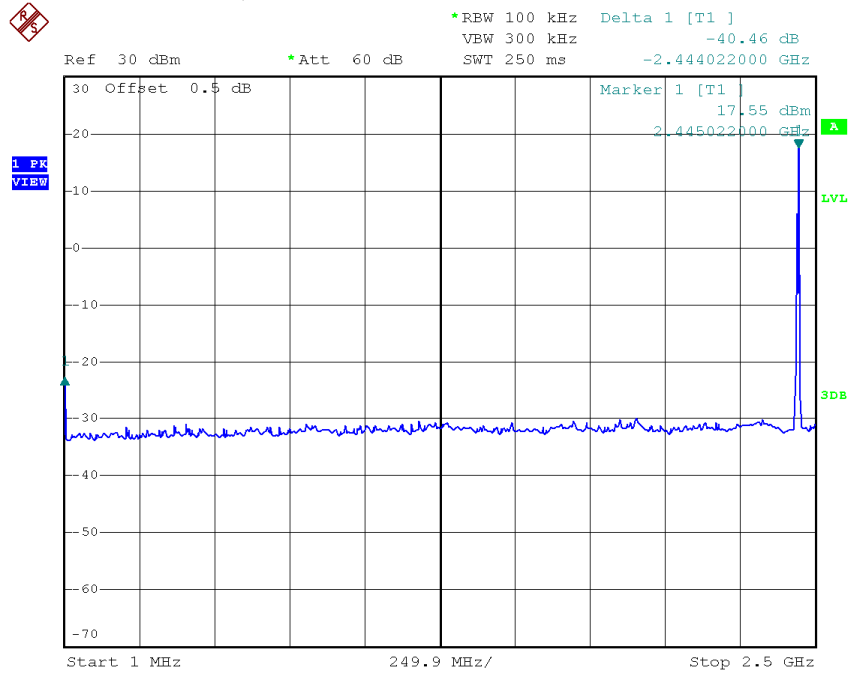

Middle Channel, Plot 2

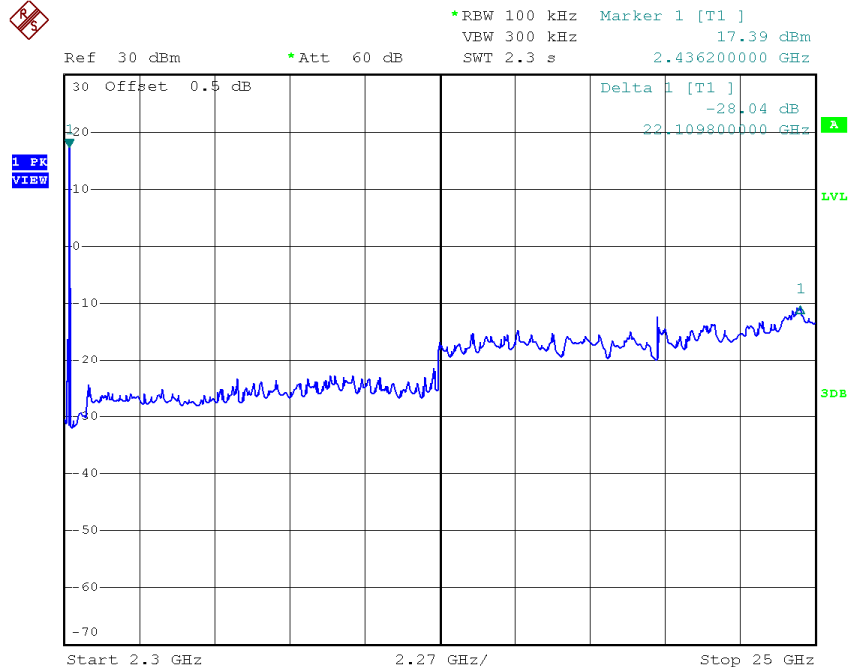

INTERTEK TESTING SERVICES

Plots of Out of Band Conducted Emissions Highest Channel, Plot 1

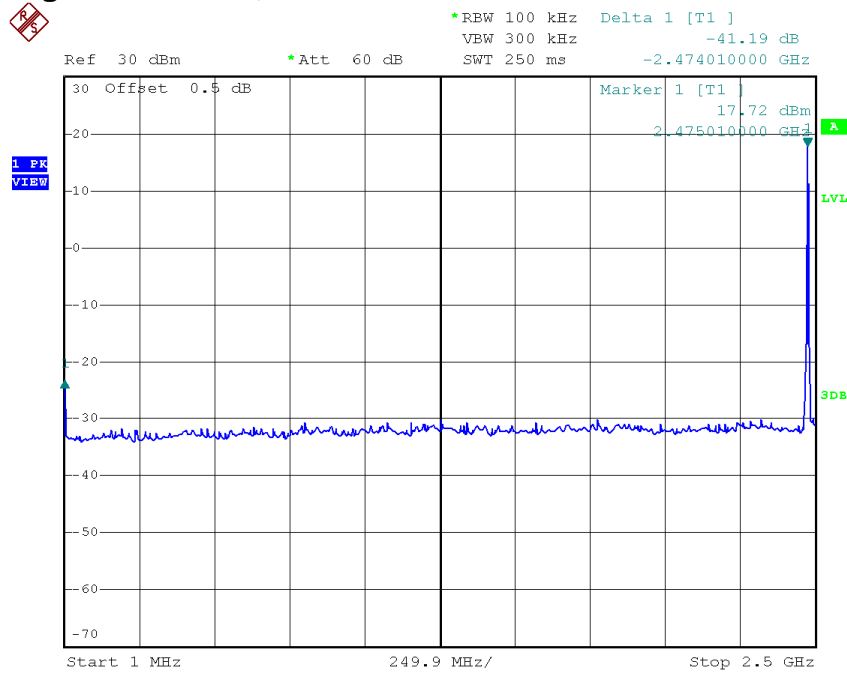

Highest Channel, Plot 2

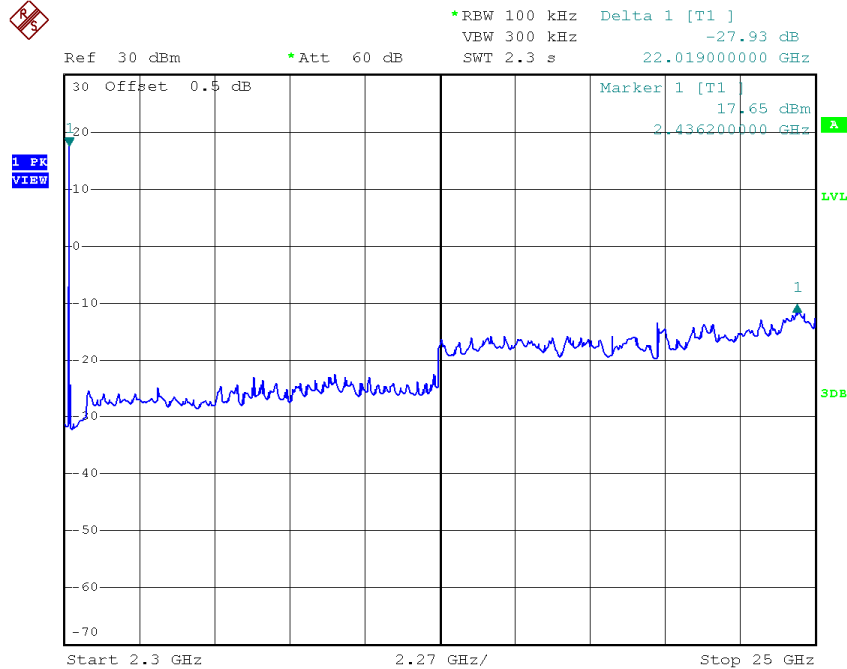

INTERTEK TESTING SERVICES

Plots of Bandedge

Lowest Bandedge

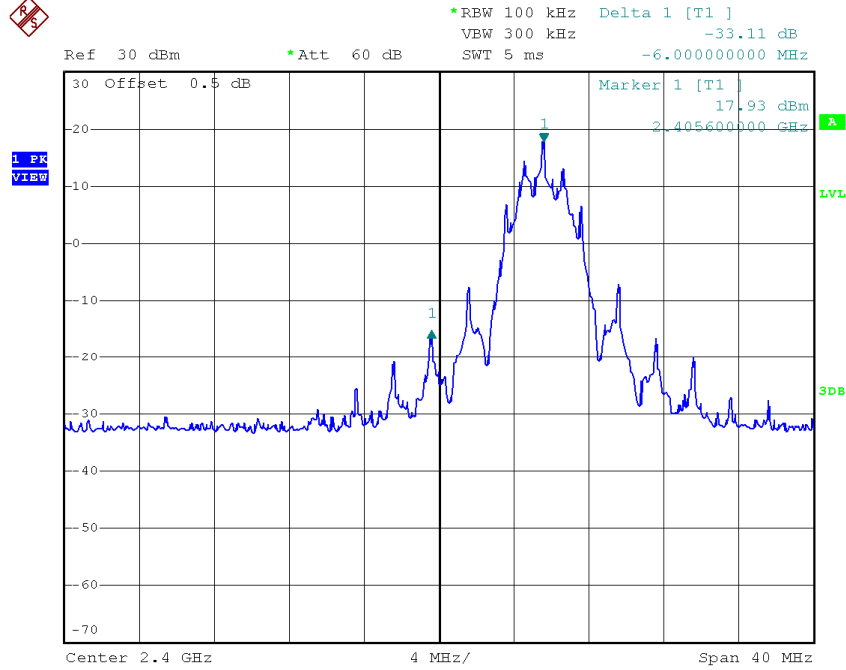

Highest Bandedge

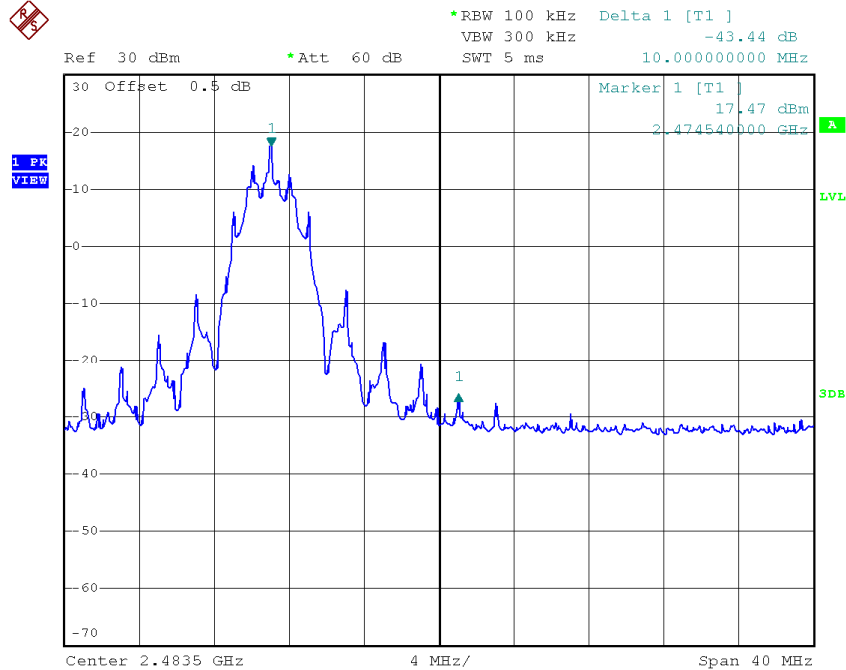

INTERTEK TESTING SERVICES

4.7 Field Strength Calculation

The field strength is calculated by adding the reading on the Spectrum Analyzer to the factors associated with preamplifiers (if any), antennas, cables, pulse desensitization and average factors (when specified limit is in average and measurements are made with peak detectors). A sample calculation is included below.

$$FS = RA + AF + CF - AG + PD + AV$$

where

- FS = Field Strength in dB μ V/m
- RA = Receiver Amplitude (including preamplifier) in dB μ V
- CF = Cable Attenuation Factor in dB
- AF = Antenna Factor in dB
- AG = Amplifier Gain in dB
- PD = Pulse Desensitization in dB
- AV = Average Factor in -dB

In the radiated emission table which follows, the reading shown on the data table may reflect the preamplifier gain. An example of the calculations, where the reading does not reflect the preamplifier gain, follows:

$$FS = RA + AF + CF - AG + PD + AV$$

Example

Assume a receiver reading of 62.0 dB μ V is obtained. The antenna factor of 7.4 dB and cable factor of 1.6 dB is added. The amplifier gain of 29 dB is subtracted. The pulse desensitization factor of the spectrum analyzer was 0 dB, and the resultant average factor was -10 dB. The net field strength for comparison to the appropriate emission limit is 32 dB μ V/m. This value in dB μ V/m was converted to its corresponding level in μ V/m.

$$\begin{aligned} RA &= 62.0 \text{ dB}\mu\text{V} \\ AF &= 7.4 \text{ dB} \\ CF &= 1.6 \text{ dB} \\ AG &= 29 \text{ dB} \\ PD &= 0 \text{ dB} \\ AV &= -10 \text{ dB} \\ FS &= 62 + 7.4 + 1.6 - 29 + 0 + (-10) = 32 \text{ dB}\mu\text{V/m} \end{aligned}$$

$$\text{Level in } \mu\text{V/m} = \text{Common Antilogarithm} [(32 \text{ dB}\mu\text{V/m})/20] = 39.8 \mu\text{V/m}$$

INTERTEK TESTING SERVICES

4.8 Transmitter Radiated Emissions in Restricted Bands and Spurious Emissions

Data is included of the worst case configuration (the configuration which resulted in the highest emission levels). A sample calculation, configuration photographs and data tables of the emissions are included.

The data on the following pages list the significant emission frequencies, the limit and the margin of compliance.

INTERTEK TESTING SERVICES

4.8.1 Radiated Emission Configuration Photograph

Worst Case Restricted Band Radiated Emission
at

Baby Unit with adaptor "Ten Pao": 240.005 MHz
Baby Unit with adaptor "Sunstrong": 408.100 MHz

The worst case radiated emission configuration photographs are attached in the Appendix and saved with filename: config photos.pdf

4.8.2 Radiated Emission Data

The data in tables 1-8 list the significant emission frequencies, the limit and the margin of compliance.

Judgement -

Baby Unit with adaptor "Ten Pao": Passed by 0.4 dB margin
Baby Unit with adaptor "Sunstrong": Passed by 0.3 dB margin

INTERTEK TESTING SERVICES

4.8.3 Radiated Emission Test Setup

The figure below shows the test setup, which is utilized to make these measurements.

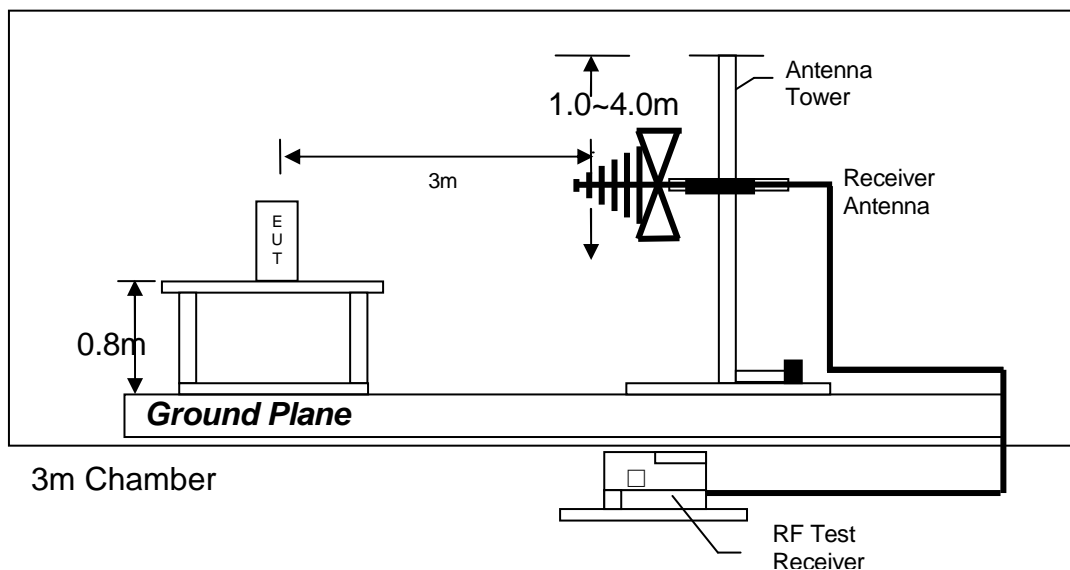

Test setup of radiated emissions up to 1GHz

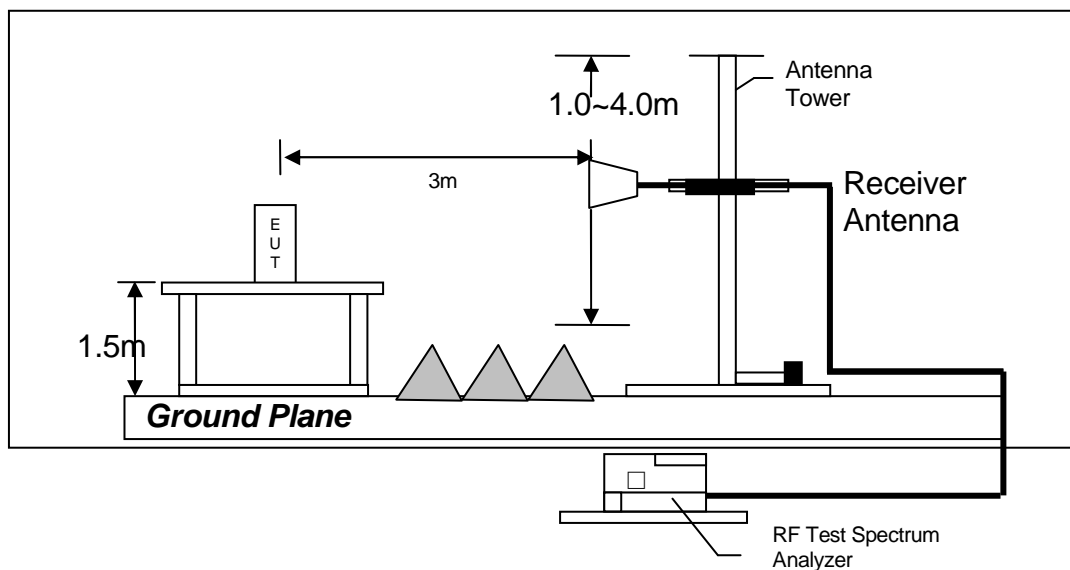

Test setup of radiated emissions above 1GHz

INTERTEK TESTING SERVICES

Mode: TX-Channel 1 with adaptor "Ten Pao"

Table 1, Baby Unit

Radiated Emission Data

Polarization	Frequency (MHz)	Reading (dB μ V)	Pre-Amp Gain (dB)	Antenna Factor (dB)	Net at 3m - Peak (dB μ V/m)	Average Factor (dB)	Calculated at 3m (dB μ V/m)	Average Limit at 3m (dB μ V/m)	Margin (dB)
H	2390.000	64.4	33	29.4	60.8	21.63	39.2	54.0	-14.8
H	4812.000	57.5	33	34.9	59.4	21.63	37.8	54.0	-16.2
V	12030.000	43.0	33	40.5	50.5	21.63	28.9	54.0	-25.1

Polarization	Frequency (MHz)	Reading (dB μ V)	Pre-Amp Gain (dB)	Antenna Factor (dB)	Net at 3m - Peak (dB μ V/m)	Peak Limit at 3m (dB μ V/m)	Margin (dB)
H	2390.000	64.4	33	29.4	60.8	74.0	-13.2
H	4812.000	57.5	33	34.9	59.4	74.0	-14.6
V	12030.000	43.0	33	40.5	50.5	74.0	-23.5

- NOTES:
1. Peak detector is used for the emission measurement.
 2. All measurements were made at 3 meters. Radiated emissions not detected at the 3-meter distance were measured at 0.3-meter and an inverse proportional extrapolation was performed to compare the signal level to the 3-meter limit. No other radiated emissions than those reported were detected at a test distance of 0.3-meter.
 3. Negative value in the margin column shows emission below limit.
 4. Horn antenna is used for the emission over 1000MHz.
 5. Emission (the row indicated by **bold italic**) within the restricted band meets the requirement of FCC Part 15 Section 15.205 / RSS-247 Section 2.2.
 6. For the measurement of radiated emission, summation method was used which numerical integrating (in terms of linear power) over the transmitter occupied bandwidth.

INTERTEK TESTING SERVICES

Mode: TX-Channel 13 with adaptor "Ten Pao"

Table 2, Baby Unit

Radiated Emission Data

Polarization	Frequency (MHz)	Reading (dB μ V)	Pre-Amp Gain (dB)	Antenna Factor (dB)	Net at 3m - Peak (dB μ V/m)	Average Factor (dB)	Calculated at 3m (dB μ V/m)	Average Limit at 3m (dB μ V/m)	Margin (dB)
<i>H</i>	<i>4884.000</i>	<i>57.0</i>	<i>33</i>	<i>34.9</i>	<i>58.9</i>	<i>21.63</i>	<i>37.3</i>	<i>54.0</i>	<i>-16.7</i>
<i>H</i>	<i>7326.000</i>	<i>40.3</i>	<i>33</i>	<i>37.9</i>	<i>45.2</i>	<i>21.63</i>	<i>23.6</i>	<i>54.0</i>	<i>-30.4</i>
<i>V</i>	<i>12210.000</i>	<i>43.1</i>	<i>33</i>	<i>40.5</i>	<i>50.6</i>	<i>21.63</i>	<i>29.0</i>	<i>54.0</i>	<i>-25.0</i>

Polarization	Frequency (MHz)	Reading (dB μ V)	Pre-Amp Gain (dB)	Antenna Factor (dB)	Net at 3m - Peak (dB μ V/m)	Peak Limit at 3m (dB μ V/m)	Margin (dB)
<i>H</i>	<i>4884.000</i>	<i>57.0</i>	<i>33</i>	<i>34.9</i>	<i>58.9</i>	<i>74.0</i>	<i>-15.1</i>
<i>H</i>	<i>7326.000</i>	<i>40.3</i>	<i>33</i>	<i>37.9</i>	<i>45.2</i>	<i>74.0</i>	<i>-28.8</i>
<i>V</i>	<i>12210.000</i>	<i>43.1</i>	<i>33</i>	<i>40.5</i>	<i>50.6</i>	<i>74.0</i>	<i>-23.4</i>

- NOTES:
1. Peak detector is used for the emission measurement.
 2. All measurements were made at 3 meters. Radiated emissions not detected at the 3-meter distance were measured at 0.3-meter and an inverse proportional extrapolation was performed to compare the signal level to the 3-meter limit. No other radiated emissions than those reported were detected at a test distance of 0.3-meter.
 3. Negative value in the margin column shows emission below limit.
 7. Horn antenna is used for the emission over 1000MHz.
 8. Emission (the row indicated by ***bold italic***) within the restricted band meets the requirement of FCC Part 15 Section 15.205 / RSS-247 Section 2.2.
 9. For the measurement of radiated emission, summation method was used which numerical integrating (in terms of linear power) over the transmitter occupied bandwidth.

INTERTEK TESTING SERVICES

Mode: TX-Channel 24 with adaptor "Ten Pao"

Table 3, Baby Unit

Radiated Emission Data

Polarization	Frequency (MHz)	Reading (dB μ V)	Pre-Amp Gain (dB)	Antenna Factor (dB)	Net at 3m - Peak (dB μ V/m)	Average Factor (dB)	Calculated at 3m (dB μ V/m)	Average Limit at 3m (dB μ V/m)	Margin (dB)
H	2483.500	69.3	33	29.4	65.7	21.63	44.1	54.0	-9.9
H	4950.000	56.6	33	34.9	58.5	21.63	36.9	54.0	-17.1
H	7425.000	40.5	33	37.9	45.4	21.63	23.8	54.0	-30.2
V	12375.000	42.9	33	40.5	50.4	21.63	28.8	54.0	-25.2

Polarization	Frequency (MHz)	Reading (dB μ V)	Pre-Amp Gain (dB)	Antenna Factor (dB)	Net at 3m - Peak (dB μ V/m)	Peak Limit at 3m (dB μ V/m)	Margin (dB)
H	2483.500	69.3	33	29.4	65.7	74.0	-8.3
H	4950.000	56.6	33	34.9	58.5	74.0	-15.5
H	7425.000	40.5	33	37.9	45.4	74.0	-28.6
V	12375.000	42.9	33	40.5	50.4	74.0	-23.6

- NOTES:
1. Peak detector is used for the emission measurement.
 2. All measurements were made at 3 meters. Radiated emissions not detected at the 3-meter distance were measured at 0.3-meter and an inverse proportional extrapolation was performed to compare the signal level to the 3-meter limit. No other radiated emissions than those reported were detected at a test distance of 0.3-meter.
 3. Negative value in the margin column shows emission below limit.
 4. Horn antenna is used for the emission over 1000MHz.
 5. Emission (the row indicated by **bold italic**) within the restricted band meets the requirement of FCC Part 15 Section 15.205 / RSS-247 Section 2.2.
 6. For the measurement of radiated emission, summation method was used which numerical integrating (in terms of linear power) over the transmitter occupied bandwidth.

INTERTEK TESTING SERVICES

Mode: TX Other with adaptor "Ten Pao"

Table 5, Baby Unit

Radiated Emission Data

Polarization	Frequency (MHz)	Reading (dB μ V)	Pre-amp (dB)	Antenna Factor (dB)	Net at 3m (dB μ V/m)	Limit at 3m (dB μ V/m)	Margin (dB)
V	42.489	33.9	16	10.0	27.9	40.0	-12.1
H	95.960	39.9	16	12.0	35.9	43.5	-7.6
V	143.975	44.0	16	14.0	42.0	43.5	-1.5
H	204.358	42.1	16	16.0	42.1	43.5	-1.4
H	240.005	42.6	16	19.0	45.6	46.0	-0.4
H	276.016	37.4	16	22.0	43.4	46.0	-2.6
V	336.035	34.6	16	24.0	42.6	46.0	-3.4
V	431.944	30.9	16	25.0	39.9	46.0	-6.1
V	575.989	28.1	16	28.0	40.1	46.0	-5.9
H	720.034	27.4	16	30.0	41.4	46.0	-4.6

- NOTES:
1. Peak detector is used for the emission measurement.
 2. All measurements were made at 3 meters. Radiated emissions not detected at the 3-meter distance were measured at 0.3-meter and an inverse proportional extrapolation was performed to compare the signal level to the 3-meter limit. No other radiated emissions than those reported were detected at a test distance of 0.3-meter.
 3. Negative value in the margin column shows emission below limit.
 4. Emission (the row indicated by **bold italic**) within the restricted band meets the requirement of FCC Part 15 Section 15.205 / RSS-247 Section 2.2.

INTERTEK TESTING SERVICES

Mode: Talk and Music Play with adaptor "Ten Pao"

Table 94 Baby Unit

Radiated Emission Data

Polarization	Frequency (MHz)	Reading (dB μ V)	Pre-amp (dB)	Antenna Factor (dB)	Net at 3m (dB μ V/m)	Limit at 3m (dB μ V/m)	Margin (dB)
V	35.941	42.6	16	10.0	36.6	40.0	-3.4
V	83.956	46.7	16	7.0	37.7	40.0	-2.3
V	119.967	37.9	16	14.0	35.9	43.5	-7.6
V	131.971	43.1	16	14.0	41.1	43.5	-2.4
V	179.865	36.7	16	20.0	40.7	43.5	-2.8
H	252.008	40.5	16	20.0	44.5	46.0	-1.5
V	256.131	39.0	16	21.0	44.0	46.0	-2.0
V	383.928	35.7	16	24.0	43.7	46.0	-2.3
V	407.936	33.4	16	24.0	41.4	46.0	-4.6
V	420.061	36.5	16	25.0	45.5	46.0	-0.5
V	431.943	34.0	16	25.0	43.0	46.0	-3.0
H	479.958	32.3	16	26.0	42.3	46.0	-3.7
V	575.988	30.4	16	28.0	42.4	46.0	-3.6
H	840.071	26.3	16	31.0	41.3	46.0	-4.7
V	984.116	25.8	16	33.0	42.8	54.0	-11.2

- NOTES:
1. Peak detector is used for the emission measurement.
 2. All measurements were made at 3 meters. Radiated emissions not detected at the 3-meter distance were measured at 0.3-meter and an inverse proportional extrapolation was performed to compare the signal level to the 3-meter limit. No other radiated emissions than those reported were detected at a test distance of 0.3-meter.
 3. Negative value in the margin column shows emission below limit.
 4. Emission (the row indicated by **bold italic**) within the restricted band meets the requirement of FCC Part 15 Section 15.205 / RSS-247 Section 2.2.

INTERTEK TESTING SERVICES

Mode: Talk Back with adaptor "Ten Pao"

Table 6, Baby Unit

Radiated Emission Data

Polarization	Frequency (MHz)	Reading (dB μ V)	Pre-amp (dB)	Antenna Factor (dB)	Net at 3m (dB μ V/m)	Limit at 3m (dB μ V/m)	Margin (dB)
V	35.941	40.5	16	10.0	34.5	40.0	-5.5
V	83.956	47.3	16	7.0	38.3	40.0	-1.7
V	131.971	38.4	16	14.0	36.4	43.5	-7.1
V	155.978	38.7	16	16.0	38.7	43.5	-4.8
V	179.986	38.0	16	20.0	42.0	43.5	-1.5
H	252.008	40.3	16	20.0	44.3	46.0	-1.7
V	383.928	35.3	16	24.0	43.3	46.0	-2.7
V	395.932	33.9	16	25.0	42.9	46.0	-3.1
V	408.057	36.8	16	24.0	44.8	46.0	-1.2
V	419.940	33.0	16	25.0	42.0	46.0	-4.0
V	431.943	34.3	16	25.0	43.3	46.0	-2.7
V	443.947	33.2	16	26.0	43.2	46.0	-2.8
V	479.958	31.8	16	26.0	41.8	46.0	-4.2
V	575.988	28.9	16	28.0	40.9	46.0	-5.1
V	984.116	26.2	16	33.0	43.2	54.0	-10.8

- NOTES: 1. Peak detector is used for the emission measurement.
2. All measurements were made at 3 meters. Radiated emissions not detected at the 3-meter distance were measured at 0.3-meter and an inverse proportional extrapolation was performed to compare the signal level to the 3-meter limit. No other radiated emissions than those reported were detected at a test distance of 0.3-meter.
3. Negative value in the margin column shows emission below limit.
4. Emission (the row indicated by **bold italic**) within the restricted band meets the requirement of FCC Part 15 Section 15.205 / RSS-247 Section 2.2.

INTERTEK TESTING SERVICES

Mode: TX-Channel 1 with adaptor "Sunstrong"

Table 7, Baby Unit

Radiated Emission Data

Polarization	Frequency (MHz)	Reading (dBμV)	Pre-Amp Gain (dB)	Antenna Factor (dB)	Net at 3m - Peak (dBμV/m)	Average Factor (dB)	Calculated at 3m (dBμV/m)	Average Limit at 3m (dBμV/m)	Margin (dB)
H	2390.000	64.5	33	29.4	60.9	21.63	39.3	54.0	-14.7
H	4812.000	57.7	33	34.9	59.6	21.63	38.0	54.0	-16.0
V	12030.000	42.6	33	40.5	50.1	21.63	28.5	54.0	-25.5

Polarization	Frequency (MHz)	Reading (dBμV)	Pre-Amp Gain (dB)	Antenna Factor (dB)	Net at 3m - Peak (dBμV/m)	Peak Limit at 3m (dBμV/m)	Margin (dB)
H	2390.000	64.5	33	29.4	60.9	74.0	-13.1
H	4812.000	57.7	33	34.9	59.6	74.0	-14.4
V	12030.000	42.6	33	40.5	50.1	74.0	-23.9

- NOTES:
1. Peak detector is used for the emission measurement.
 2. All measurements were made at 3 meters. Radiated emissions not detected at the 3-meter distance were measured at 0.3-meter and an inverse proportional extrapolation was performed to compare the signal level to the 3-meter limit. No other radiated emissions than those reported were detected at a test distance of 0.3-meter.
 3. Negative value in the margin column shows emission below limit.
 4. Horn antenna is used for the emission over 1000MHz.
 5. Emission (the row indicated by **bold italic**) within the restricted band meets the requirement of FCC Part 15 Section 15.205 / RSS-247 Section 2.2.

INTERTEK TESTING SERVICES

Mode: TX-Channel 13 with adaptor "Sunstrong"

Table 8, Baby Unit

Radiated Emission Data

Polarization	Frequency (MHz)	Reading (dBμV)	Pre-Amp Gain (dB)	Antenna Factor (dB)	Net at 3m - Peak (dBμV/m)	Average Factor (dB)	Calculated at 3m (dBμV/m)	Average Limit at 3m (dBμV/m)	Margin (dB)
<i>H</i>	<i>4884.000</i>	<i>56.5</i>	<i>33</i>	<i>34.9</i>	<i>58.4</i>	<i>21.63</i>	<i>36.8</i>	<i>54.0</i>	<i>-17.2</i>
<i>H</i>	<i>7326.000</i>	<i>40.8</i>	<i>33</i>	<i>37.9</i>	<i>45.7</i>	<i>21.63</i>	<i>24.1</i>	<i>54.0</i>	<i>-29.9</i>
<i>V</i>	<i>12210.000</i>	<i>42.7</i>	<i>33</i>	<i>40.5</i>	<i>50.2</i>	<i>21.63</i>	<i>28.6</i>	<i>54.0</i>	<i>-25.4</i>

Polarization	Frequency (MHz)	Reading (dBμV)	Pre-Amp Gain (dB)	Antenna Factor (dB)	Net at 3m - Peak (dBμV/m)	Peak Limit at 3m (dBμV/m)	Margin (dB)
<i>H</i>	<i>4884.000</i>	<i>56.5</i>	<i>33</i>	<i>34.9</i>	<i>58.4</i>	<i>74.0</i>	<i>-15.6</i>
<i>H</i>	<i>7326.000</i>	<i>40.8</i>	<i>33</i>	<i>37.9</i>	<i>45.7</i>	<i>74.0</i>	<i>-28.3</i>
<i>V</i>	<i>12210.000</i>	<i>42.7</i>	<i>33</i>	<i>40.5</i>	<i>50.2</i>	<i>74.0</i>	<i>-23.8</i>

- NOTES:
1. Peak detector is used for the emission measurement.
 2. All measurements were made at 3 meters. Radiated emissions not detected at the 3-meter distance were measured at 0.3-meter and an inverse proportional extrapolation was performed to compare the signal level to the 3-meter limit. No other radiated emissions than those reported were detected at a test distance of 0.3-meter.
 3. Negative value in the margin column shows emission below limit.
 10. Horn antenna is used for the emission over 1000MHz.
 11. Emission (the row indicated by ***bold italic***) within the restricted band meets the requirement of FCC Part 15 Section 15.205 / RSS-247 Section 2.2.

INTERTEK TESTING SERVICES

Mode: TX-Channel 24 with adaptor "Sunstrong"

Table 9, Baby Unit

Radiated Emission Data

Polarization	Frequency (MHz)	Reading (dB μ V)	Pre-Amp Gain (dB)	Antenna Factor (dB)	Net at 3m - Peak (dB μ V/m)	Average Factor (dB)	Calculated at 3m (dB μ V/m)	Average Limit at 3m (dB μ V/m)	Margin (dB)
H	2483.500	69.3	33	29.4	65.7	21.63	44.1	54.0	-9.9
H	4950.000	56.4	33	34.9	58.3	21.63	36.7	54.0	-17.3
H	7425.000	41.0	33	37.9	45.9	21.63	24.3	54.0	-29.7
V	12375.000	43.1	33	40.5	50.6	21.63	29.0	54.0	-25.0

Polarization	Frequency (MHz)	Reading (dB μ V)	Pre-Amp Gain (dB)	Antenna Factor (dB)	Net at 3m - Peak (dB μ V/m)	Peak Limit at 3m (dB μ V/m)	Margin (dB)
H	2483.500	69.3	33	29.4	65.7	74.0	-8.3
H	4950.000	56.4	33	34.9	58.3	74.0	-15.7
H	7425.000	41.0	33	37.9	45.9	74.0	-28.1
V	12375.000	43.1	33	40.5	50.6	74.0	-23.4

- NOTES:
1. Peak detector is used for the emission measurement.
 2. All measurements were made at 3 meters. Radiated emissions not detected at the 3-meter distance were measured at 0.3-meter and an inverse proportional extrapolation was performed to compare the signal level to the 3-meter limit. No other radiated emissions than those reported were detected at a test distance of 0.3-meter.
 3. Negative value in the margin column shows emission below limit.
 7. Horn antenna is used for the emission over 1000MHz.
 8. Emission (the row indicated by **bold italic**) within the restricted band meets the requirement of FCC Part 15 Section 15.205 / RSS-247 Section 2.2.

INTERTEK TESTING SERVICES

Mode: TX Other with adaptor "Sunstrong"

Table 11, Baby Unit

Radiated Emission Data

Polarization	Frequency (MHz)	Reading (dB μ V)	Pre-amp (dB)	Antenna Factor (dB)	Net at 3m (dB μ V/m)	Limit at 3m (dB μ V/m)	Margin (dB)
V	46.853	40.2	16	11.0	35.2	40.0	-4.8
V	119.967	44.0	16	14.0	42.0	43.5	-1.5
H	191.990	42.8	16	16.0	42.8	43.5	-0.7
H	240.005	36.6	16	19.0	39.6	46.0	-6.4
H	288.020	39.0	16	22.0	45.0	46.0	-1.0
H	383.928	30.9	16	24.0	38.9	46.0	-7.1
H	479.958	31.6	16	26.0	41.6	46.0	-4.4
H	720.033	24.9	16	30.0	38.9	46.0	-7.1
V	864.078	22.8	16	31.0	37.8	46.0	-8.2

- NOTES: 1. Peak detector is used for the emission measurement.
2. All measurements were made at 3 meters. Radiated emissions not detected at the 3-meter distance were measured at 0.3-meter and an inverse proportional extrapolation was performed to compare the signal level to the 3-meter limit. No other radiated emissions than those reported were detected at a test distance of 0.3-meter.
3. Negative value in the margin column shows emission below limit.
4. Emission (the row indicated by **bold italic**) within the restricted band meets the requirement of FCC Part 15 Section 15.205 / RSS-247 Section 2.2.

INTERTEK TESTING SERVICES

Mode: Talk and Music Play with adaptor “Sunstrong”

Table 10, Baby Unit

Radiated Emission Data

Polarization	Frequency (MHz)	Reading (dB μ V)	Pre-amp (dB)	Antenna Factor (dB)	Net at 3m (dB μ V/m)	Limit at 3m (dB μ V/m)	Margin (dB)
V	35.941	42.2	16	10.0	36.2	40.0	-3.8
V	83.956	46.6	16	7.0	37.6	40.0	-2.4
V	131.971	43.1	16	14.0	41.1	43.5	-2.4
V	179.986	34.5	16	20.0	38.5	43.5	-5.0
V	203.993	39.8	16	16.0	39.8	43.5	-3.7
H	252.008	39.9	16	20.0	43.9	46.0	-2.1
H	276.016	36.0	16	22.0	42.0	46.0	-4.0
H	383.928	33.6	16	24.0	41.6	46.0	-4.4
V	408.100	37.7	16	24.0	45.7	46.0	-0.3
V	420.061	36.3	16	25.0	45.3	46.0	-0.7
V	431.999	36.2	16	25.0	45.2	46.0	-0.8
V	443.947	34.7	16	26.0	44.7	46.0	-1.3
V	480.000	35.4	16	26.0	45.4	46.0	-0.6
V	575.988	30.1	16	28.0	42.1	46.0	-3.9
H	624.003	28.3	16	29.0	41.3	46.0	-4.7

- NOTES:
1. Peak detector is used for the emission measurement.
 2. All measurements were made at 3 meters. Radiated emissions not detected at the 3-meter distance were measured at 0.3-meter and an inverse proportional extrapolation was performed to compare the signal level to the 3-meter limit. No other radiated emissions than those reported were detected at a test distance of 0.3-meter.
 3. Negative value in the margin column shows emission below limit.
 4. Emission (the row indicated by **bold italic**) within the restricted band meets the requirement of FCC Part 15 Section 15.205 / RSS-247 Section 2.2.

INTERTEK TESTING SERVICES

Mode: Talk Back with adaptor "Sunstrong"

Table 10, Baby Unit

Radiated Emission Data

Polarization	Frequency (MHz)	Reading (dB μ V)	Pre-amp (dB)	Antenna Factor (dB)	Net at 3m (dB μ V/m)	Limit at 3m (dB μ V/m)	Margin (dB)
V	35.941	43.2	16	10.0	37.2	40.0	-2.8
V	83.956	47.2	16	7.0	38.2	40.0	-1.8
V	131.971	43.7	16	14.0	41.7	43.5	-1.8
V	179.986	34.5	16	20.0	38.5	43.5	-5.0
V	203.993	39.8	16	16.0	39.8	43.5	-3.7
H	252.008	38.5	16	20.0	42.5	46.0	-3.5
V	276.016	35.6	16	22.0	41.6	46.0	-4.4
V	395.932	33.7	16	25.0	42.7	46.0	-3.3
V	408.000	37.5	16	24.0	45.5	46.0	-0.5
V	420.000	36.3	16	25.0	45.3	46.0	-0.7
V	432.000	36.4	16	25.0	45.4	46.0	-0.6
V	444.068	35.5	16	26.0	45.5	46.0	-0.5
V	480.000	35.5	16	26.0	45.5	46.0	-0.5
V	575.988	30.6	16	28.0	42.6	46.0	-3.4
V	960.108	26.6	16	33.0	43.6	54.0	-10.4

- NOTES: 1. Peak detector is used for the emission measurement.
2. All measurements were made at 3 meters. Radiated emissions not detected at the 3-meter distance were measured at 0.3-meter and an inverse proportional extrapolation was performed to compare the signal level to the 3-meter limit. No other radiated emissions than those reported were detected at a test distance of 0.3-meter.
5. Negative value in the margin column shows emission below limit.
6. Emission (the row indicated by **bold italic**) within the restricted band meets the requirement of FCC Part 15 Section 15.205 / RSS-247 Section 2.2.

INTERTEK TESTING SERVICES

4.8.4 Transmitter Duty Cycle Calculation

$$\begin{aligned}\text{Duty Cycle (DC)} &= (\text{Maximum ON time in 100 ms}) / (100 \text{ ms}) \\ &= 0.592 \text{ ms} \times 14 / 100 \text{ ms}\end{aligned}$$

$$\begin{aligned}\text{Average Factor (AF)} &= 20 \log(\text{DC}) \\ &= 20 * \log(0.08288) \\ &= -21.63 \text{ dB}\end{aligned}$$

The plot(s) shows the bit timing is saved as below.

INTERTEK TESTING SERVICES

Plots of transmitter Duty Cycle

Plot A

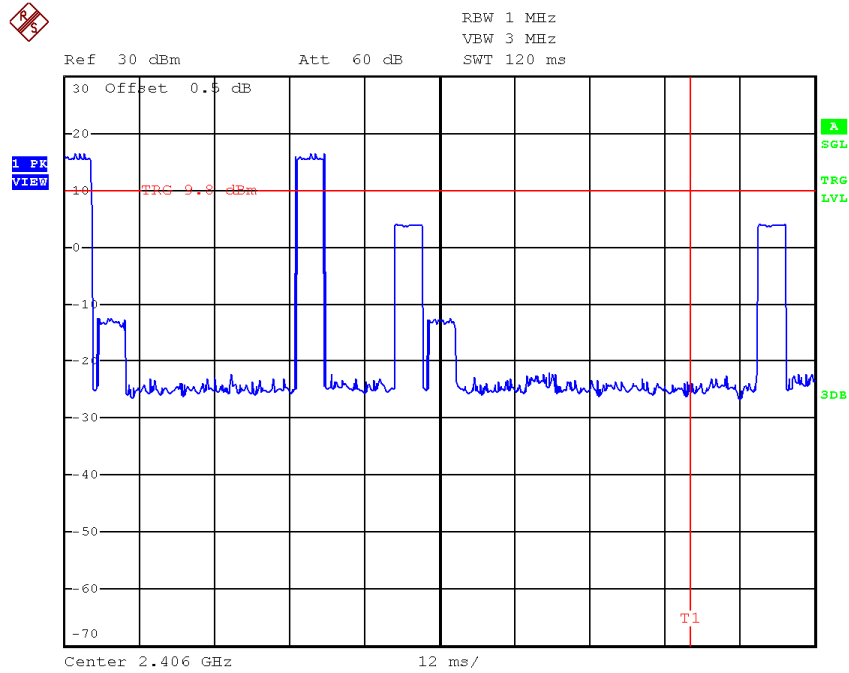

Plot B

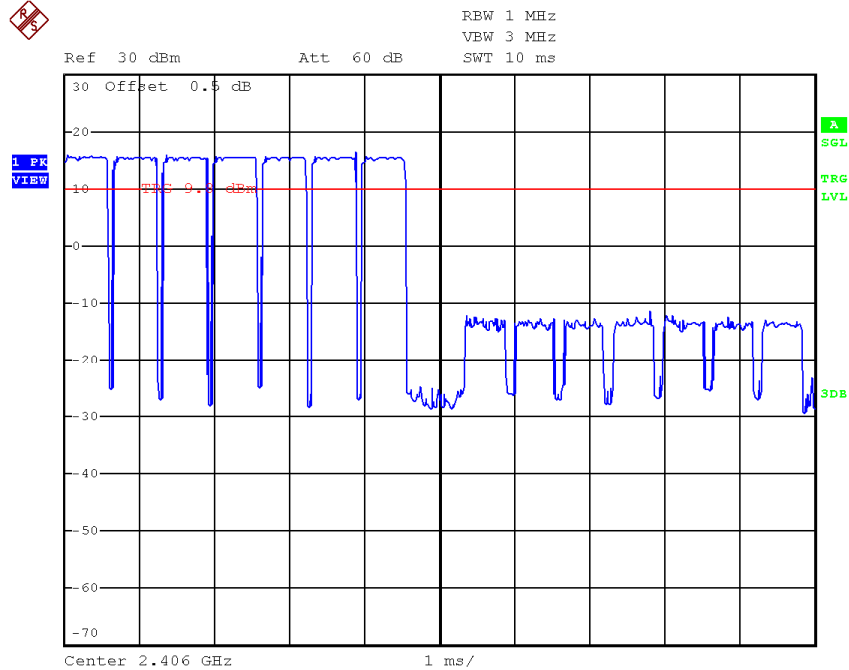

INTERTEK TESTING SERVICES

Plots of transmitter Duty Cycle

Plot C

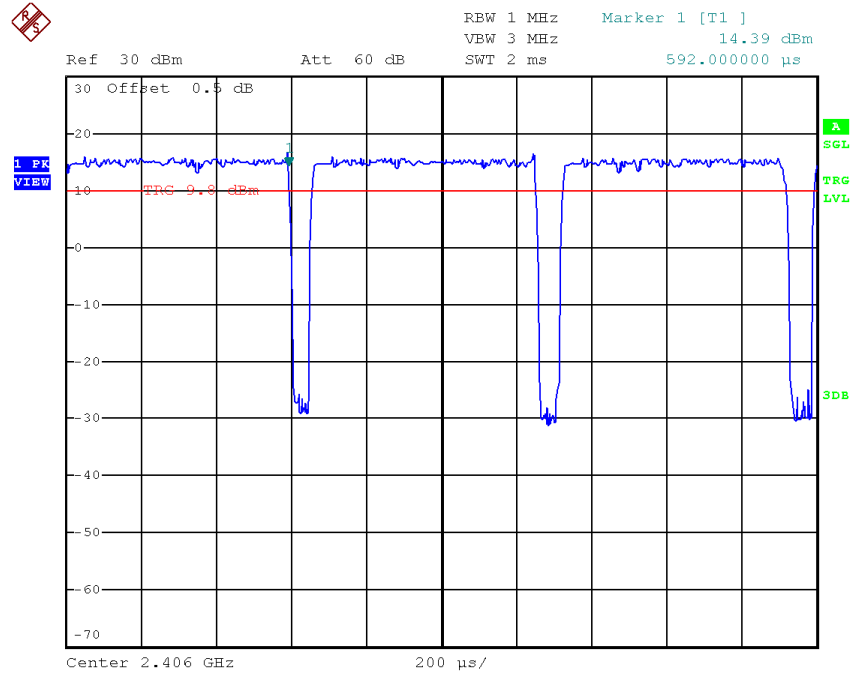

INTERTEK TESTING SERVICES

4.9 AC Power Line Conducted Emission

- Not applicable – EUT is only powered by battery for operation.
- EUT connects to AC power line. Emission Data is listed in following pages.
- Base Unit connects to AC power line and has transmission. Handset connects to AC power line but has no transmission. Emission Data of Base Unit is listed in following pages.

4.9.1 AC Power Line Conducted Emission Configuration Photograph

Worst Case Line-Conducted Configuration
at

Baby Unit with adaptor “Ten Pao”: 348.000 kHz
Baby Unit with adaptor “Sunstrong”: 361.500 kHz

The worst case line conducted configuration photographs are attached in the Appendix and saved with filename: config photos.pdf

4.9.2 AC Power Line Conducted Emission Data

The plot(s) and data in the following pages list the significant emission frequencies, the limit and the margin of compliance.

Baby Unit with adaptor “Ten Pao”: Passed by 13.58 dB margin compare with CISPR
Average limit

Baby Unit with adaptor “Sunstrong”: Passed by 16.26 dB margin compare with CISPR
Average limit

INTERTEK TESTING SERVICES

Worst Case: Talk and Music with adaptor "Ten Pao"

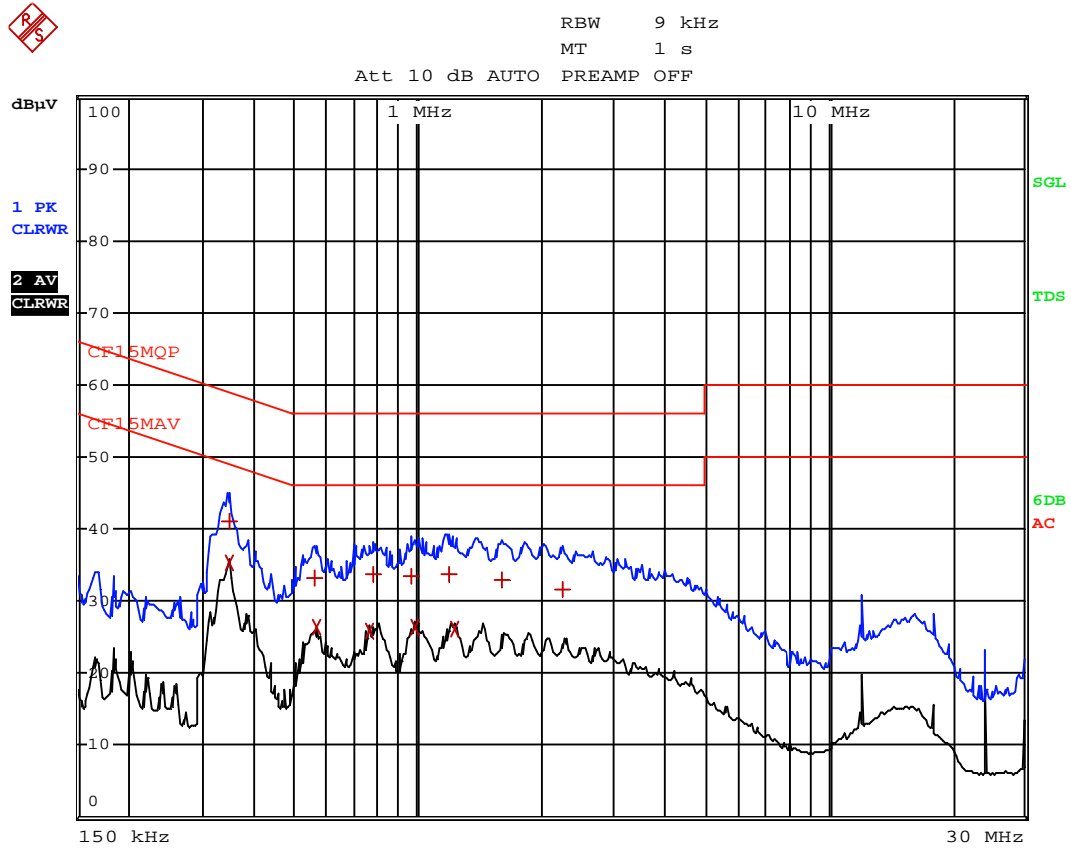

INTERTEK TESTING SERVICES

Worst Case: Talk and Music with adaptor "Ten Pao"

EDIT PEAK LIST (Final Measurement Results)

Trace1: CF15MQP

Trace2: CF15MAV

Trace3: ---

	TRACE	FREQUENCY	LEVEL	dB μ V		DELTA LIMIT	dB
1	Quasi Peak	348 kHz	41.00	N		-18.01	
2	CISPR Average	348 kHz	35.42	L1		-13.58	
1	Quasi Peak	559.5 kHz	33.28	N		-22.71	
2	CISPR Average	564 kHz	26.47	N		-19.52	
2	CISPR Average	762 kHz	25.93	N		-20.06	
1	Quasi Peak	780 kHz	33.74	L1		-22.25	
1	Quasi Peak	960 kHz	33.43	L1		-22.56	
2	CISPR Average	982.5 kHz	26.45	L1		-19.54	
1	Quasi Peak	1.194 MHz	33.64	L1		-22.35	
2	CISPR Average	1.23 MHz	26.23	N		-19.76	
1	Quasi Peak	1.6125 MHz	33.01	N		-22.98	
1	Quasi Peak	2.256 MHz	31.68	L1		-24.31	

INTERTEK TESTING SERVICES

Worst Case: Talk Back with adaptor "Ten Pao"



RBW 9 kHz

MT 1 s

Att 10 dB AUTO PREAMP OFF

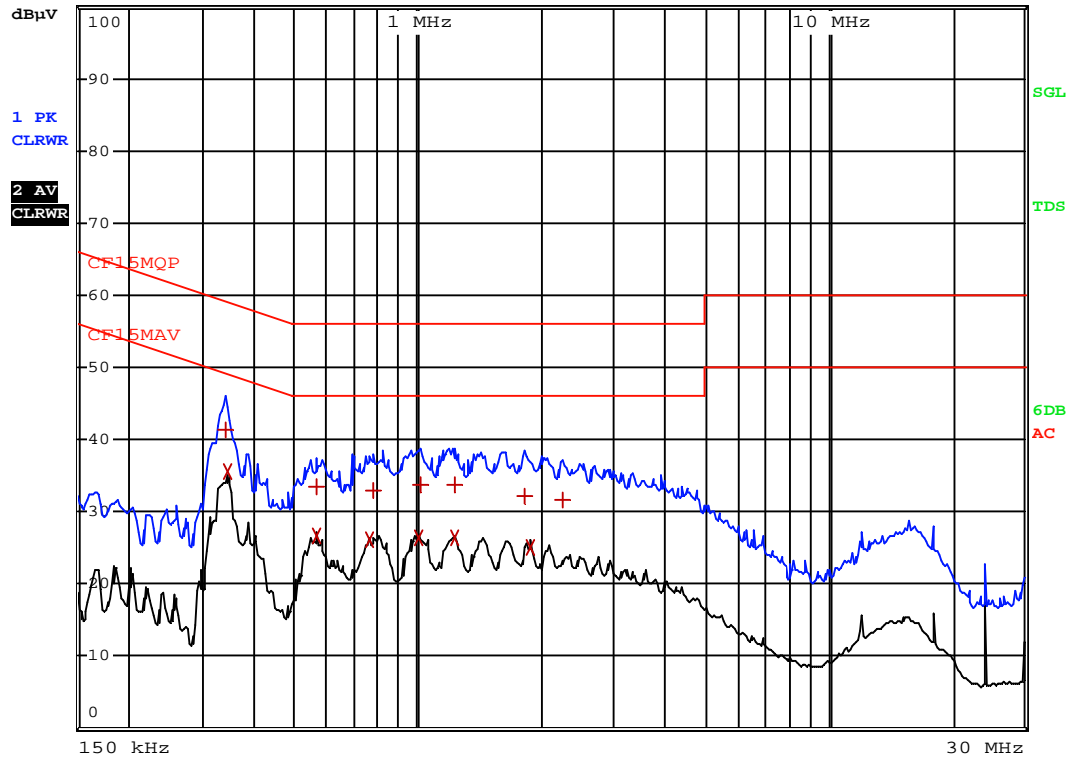

INTERTEK TESTING SERVICES

Worst Case: Talk Back with adaptor "Ten Pao"

EDIT PEAK LIST (Final Measurement Results)					
Trace1: CF15MQP					
Trace2: CF15MAV					
Trace3: ---					
	TRACE	FREQUENCY	LEVEL	dB μ V	DELTA LIMIT
1	Quasi Peak	339 kHz	41.22	N	-18.00
2	CISPR Average	343.5 kHz	35.47	L1	-13.64
1	Quasi Peak	564 kHz	33.39	L1	-22.60
2	CISPR Average	564 kHz	26.65	N	-19.34
2	CISPR Average	762 kHz	26.00	L1	-19.99
1	Quasi Peak	775.5 kHz	33.02	N	-22.97
2	CISPR Average	1.0005 MHz	26.37	L1	-19.62
1	Quasi Peak	1.0185 MHz	33.70	N	-22.29
1	Quasi Peak	1.23 MHz	33.72	N	-22.27
2	CISPR Average	1.2345 MHz	26.30	N	-19.69
1	Quasi Peak	1.815 MHz	32.10	N	-23.89
2	CISPR Average	1.8825 MHz	24.96	N	-21.03
1	Quasi Peak	2.2515 MHz	31.64	L1	-24.35

INTERTEK TESTING SERVICES

Worst Case: Talk and Music with adaptor "Sunstrong"

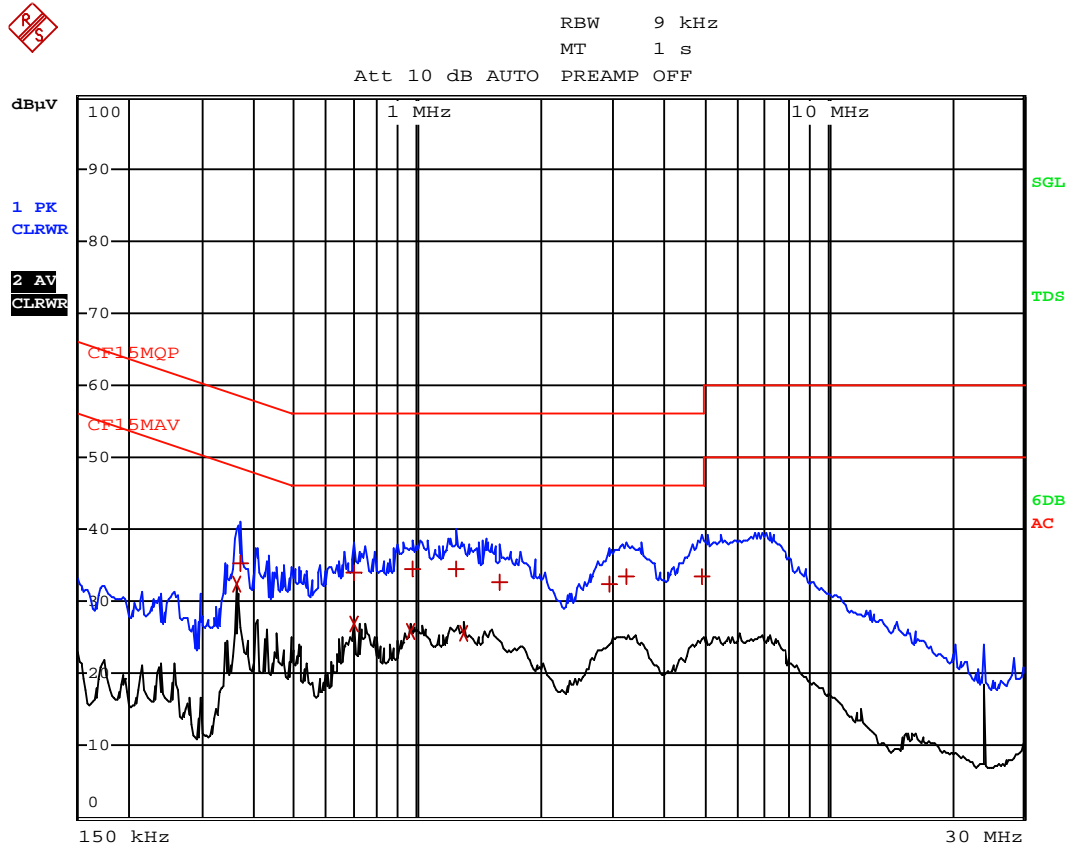

INTERTEK TESTING SERVICES

Worst Case: Talk and Music with adaptor "Sunstrong"

EDIT PEAK LIST (Final Measurement Results)

Trace1: CF15MQP

Trace2: CF15MAV

Trace3: ---

	TRACE	FREQUENCY	LEVEL	dB μ V		DELTA	LIMIT	dB
2	CISPR Average	361.5 kHz	32.42	N		-16.26		
1	Quasi Peak	370.5 kHz	35.19	L1		-23.29		
1	Quasi Peak	703.5 kHz	33.90	N		-22.09		
2	CISPR Average	703.5 kHz	26.90	N		-19.09		
2	CISPR Average	964.5 kHz	25.79	L1		-20.20		
1	Quasi Peak	978 kHz	34.40	N		-21.59		
1	Quasi Peak	1.239 MHz	34.41	L1		-21.59		
2	CISPR Average	1.293 MHz	25.66	N		-20.33		
1	Quasi Peak	1.59 MHz	32.55	N		-23.44		
1	Quasi Peak	2.931 MHz	32.50	L1		-23.50		
1	Quasi Peak	3.2505 MHz	33.41	N		-22.58		
1	Quasi Peak	4.9425 MHz	33.36	N		-22.63		

INTERTEK TESTING SERVICES

Worst Case: Talk Back with adaptor "Sunstrong"



RBW 9 kHz
MT 1 s

Att 10 dB AUTO PREAMP OFF

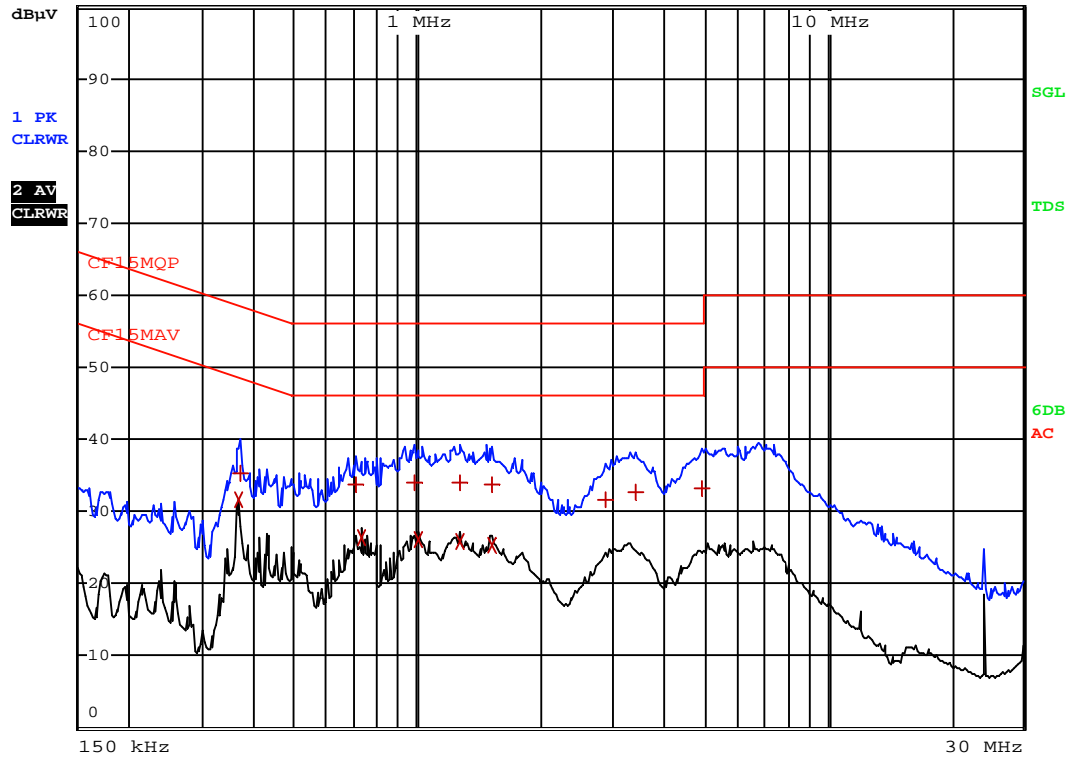

INTERTEK TESTING SERVICES

Worst Case: Talk Back with adaptor "Sunstrong"

EDIT PEAK LIST (Final Measurement Results)				
Trace1:	CF15MQP			
Trace2:	CF15MAV			
Trace3:	---			
	TRACE	FREQUENCY	LEVEL dB μ V	DELTA LIMIT dB
2	CISPR Average	366 kHz	31.65 N	-16.94
1	Quasi Peak	370.5 kHz	35.41 L1	-23.07
1	Quasi Peak	708 kHz	33.64 N	-22.35
2	CISPR Average	730.5 kHz	26.37 N	-19.63
1	Quasi Peak	987 kHz	34.05 L1	-21.94
2	CISPR Average	1.0095 MHz	26.06 N	-19.93
1	Quasi Peak	1.275 MHz	33.94 N	-22.05
2	CISPR Average	1.275 MHz	25.76 N	-20.23
1	Quasi Peak	1.527 MHz	33.71 L1	-22.28
2	CISPR Average	1.527 MHz	25.36 L1	-20.63
1	Quasi Peak	2.868 MHz	31.71 N	-24.28
1	Quasi Peak	3.4305 MHz	32.79 N	-23.20
1	Quasi Peak	4.938 MHz	33.19 N	-22.81

INTERTEK TESTING SERVICES

4.9.3 AC Line Conducted Emission Test Setup

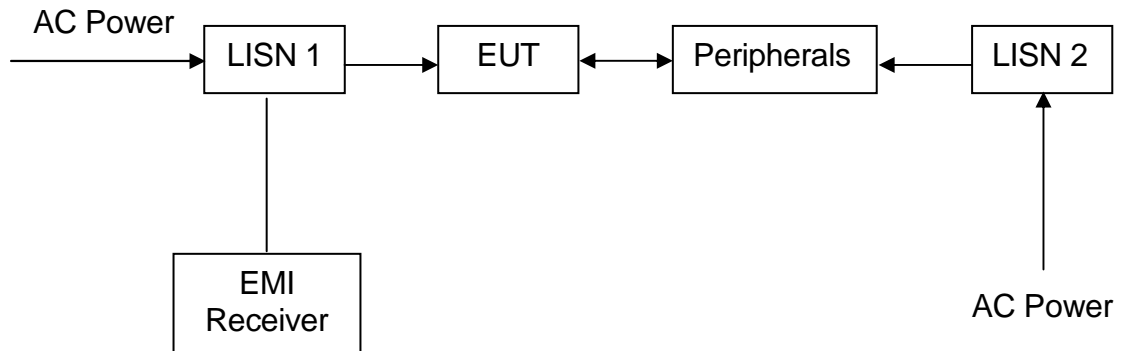

The EUT along with its peripherals were placed on a 1.0m(W)×1.5m(L) and 0.8m in height wooden table and the EUT was adjusted to maintain a 0.4 meter space from a vertical reference plane. The EUT was connected to power mains through a line impedance stabilization network (LISN), which provided 50 ohm coupling impedance for measuring instrument and the chassis ground was bounded to the horizontal ground plane of shielded room. The excess power cable between the EUT and the LISN was bundled.

All connecting cables of EUT and peripherals were moved to find the maximum emission.

INTERTEK TESTING SERVICES

**EXHIBIT 5
EQUIPMENT LIST**

INTERTEK TESTING SERVICES

5.0 Equipment List

1) Radiated Emissions Test

Equipment	Spectrum Analyzer	Biconical Antenna	EMI Test Receiver
Registration No.	EW-2253	EW-0571	EW-3095
Manufacturer	R&S	EMCO	R&S
Model No.	FSP40	3104C	ESCI
Calibration Date	Jun. 15, 2016	May 18, 2016	Oct. 25, 2016
Calibration Due Date	Jun. 15, 2017	Nov. 18, 2017	Oct. 25, 2017

Equipment	Log Periodic Antenna	Double Ridged Guide Antenna
Registration No.	EW-0447	EW-1133
Manufacturer	EMCO	EMCO
Model No.	3146	3115
Calibration Date	May 18, 2016	Nov. 05, 2015
Calibration Due Date	Nov. 18, 2017	May 05, 2017

2) Conducted Emissions Test

Equipment	EMI Test Receiver (9kHz to 26.5GHz)	Artificial Mains	Pulse Limiter
Registration No.	EW-3156	EW-0192	EW-3248
Manufacturer	R&S	R&S	R&S
Model No.	ESR26	ESH3-Z5	ESH3-Z2
Calibration Date	Dec. 06, 2016	Aug. 26, 2016	Oct. 12, 2016
Calibration Due Date	Dec. 06, 2017	Aug. 26, 2017	Oct. 12, 2017

3) Conductive Measurement Test

Equipment	Spectrum Analyzer
Registration No.	EW-2466
Manufacturer	R&S
Model No.	FSP30
Calibration Date	Oct. 03, 2016
Calibration Due Date	Aug. 20, 2017

END OF TEST REPORT