



Valued Quality. Delivered.

TEST REPORT

Report Number: 15111203HKG-001

Application

For

Original Grant of 47 CFR Part 15 Certification
New Family of RSS-213 Issue 3 Equipment Certification

Unlicensed Personal Communication Service Devices/
2 GHz License-exempt Personal Communications Service Devices

FCC ID: EW780-0051-00

IC: 1135B-80005100

Prepared and Checked by:

Approved by:

Signed on File

Leung Chiu Kuen, Stanley
Engineer

Nip Ming Fung, Melvin
Assistant Manager
February 15, 2016

- Intertek's standard Terms and Conditions can be obtained at our website: <http://www.intertek.com/terms/>.
- The test report only allows to be revised within the retention period unless further standard or the requirement was noticed.
- This report is for the exclusive use of Intertek's Client and is provided pursuant to the agreement between Intertek and its Client. Intertek's responsibility and liability are limited to the terms and conditions of the agreement. Intertek assumes no liability to any party, other than to the Client in accordance with the agreement, for any loss, expense or damage occasioned by the use of this report. Only the Client is authorized to permit copying or distribution of this report and then only in its entirety. Any use of the Intertek name or one of its marks for the sale or advertisement of the tested material, product or service must first be approved in writing by Intertek. The observations and test results in this report are relevant only to the sample tested. This report by itself does not imply that the material, product, or service is or has ever been under an Intertek certification program.

Intertek Testing Services Hong Kong Ltd.

2/F., Garment Centre, 576 Castle Peak Road, Kowloon, Hong Kong.
Tel: (852) 2173 8888 Fax: (852) 2785 5487 Website: www.hk.intertek-etlsemko.com

INTERTEK TESTING SERVICES

GENERAL INFORMATION

Applicant Name:	VTech Telecommunications Ltd.
Applicant Address:	23/F., Tai Ping Industrial Centre, Block 1, 57 Ting Kok Road, Tai Po, Hong Kong.
FCC Specification Standard:	FCC Part 15, October 1, 2014 Edition
FCC ID:	EW780-0051-00
FCC Model(s):	VC7004, VC71215, VC71214, VC71216, VC71217
IC Specification Standard:	RSS-213 Issue 3, March 2015 RSS-Gen Issue 4, November 2014
IC:	1135B-80005100
IC Model(s):	VC7004, VC71215, VC71214, VC71216, VC71217
Type of EUT:	Unlicensed Personal Communications Service Devices
Description of EUT:	Multi-Color Smart LED Light Bulb
Serial Number:	N/A
Sample Receipt Date:	November 27, 2015
Date of Test:	December 03, 2015 to January 26, 2016
Report Date:	February 15, 2016
Environmental Conditions:	Temperature: +10 to 40°C Humidity: 10 to 90%

INTERTEK TESTING SERVICES

Table of Contents

1.0 Test Results Summary & Statement of Compliance	5
1.1 Summary of Test Results	5
1.2 Statement of Compliance	7
2.0 General Description	9
2.1 Product Description	9
2.2 Technical Description	9
2.3 Test Methodology	9
2.4 Test Facility	9
3.0 System Test Configuration	11
3.1 Justification	11
3.2 Radiated Emission Test Setup.....	12
3.3 AC Line Conducted Emission Test Setup	12
3.4 Conducted Emission Test Configuration	13
3.5 Conducted Monitoring and Operational Test Configuration	13
3.6 EUT Exercising Software.....	13
3.7 Details of EUT and Description of Accessories	14
3.8 Measurement Uncertainty	14
4.0 Measurement Results	16
4.1 Antenna Requirement	16
4.2 Digital Modulation Techniques.....	16
4.3 Emission Bandwidth	17
4.4 Directional Gain of the Antenna	20
4.5 Peak Transmit Power	21
4.6 Power Spectral Density	24
4.7 Automatic Discontinuation of Transmission.....	27
4.8 Unwanted Emission Inside the Sub-Band	28
4.9 Emissions Outside the Sub-Band	32
4.9.1 Radiated Emissions Configuration Photographs	33
4.9.2 Radiated Emissions Data	33
4.9.3 Field Strength Calculation.....	37
4.9.4 Average Factor Calculation and Transmitter ON Time Measurements	38
4.10 AC Power Line Conducted Emissions.....	39
4.10.1 AC Power Line Conducted Emissions Configuration Photographs	40
4.10.2 AC Power Line Conducted Emissions Data	40
4.11 Frame Repetition Stability	43
4.12 Frame Period and Jitter	44
4.13 Carrier Frequency Stability	45

INTERTEK TESTING SERVICES

Table of Contents

4.14 Monitoring Threshold.....	46
4.14.1 Monitoring Threshold Limit.....	47
4.14.2 Least Interfered Channel	48
4.14.2.1 Least Interfered Channel (LIC) Selection	49
4.14.2.2 Least Interfered Channel (LIC) Confirmation.....	50
4.14.2.3 Maximum Spectrum Occupancy.....	50
4.15 Monitoring Time.....	51
4.16 Maximum Transmit Period.....	52
4.17 System Acknowledgement	53
4.18 Random Waiting.....	54
4.19 Monitoring Bandwidth	55
4.20 Maximum Reaction Time.....	56
4.21 Monitoring Antenna	57
4.22 Duplex Connections	57
4.23 Alternative Monitoring Interval for Co-located Device.....	59
4.24 Fair Access.....	59
5.0 Equipment List	61

INTERTEK TESTING SERVICES

**EXHIBIT 1
TEST RESULTS SUMMARY & STATEMENT OF COMPLIANCE**

INTERTEK TESTING SERVICES

1.0 Test Results Summary & Statement of Compliance

1.1 Summary of Test Results

General Technical Requirements					
Test Items	RSS-213 / RSS-Gen# Clause	FCC Part 15 Section	Test Procedure ANSI C63.17 / ANSI C63.4*	Results	Details see section
Antenna Requirement	8.3 [#]	15.317	---	Pass	4.1
Digital Modulation Techniques	5.1	15.319(b)	6.1.4	Pass	4.2
Occupied/Emission Bandwidth	5.5	15.323(a)	6.1.3	Pass	4.3
Directional Gain of the Antenna	4	15.319(e)	4.3.1	Pass	4.4
Peak Transmit Power	5.6	15.319(c)	6.1.2	Pass	4.5
Power Spectral Density	5.7	15.319(d)	6.1.5	Pass	4.6
Automatic Discontinuation of Transmission	5.2	15.319(f)	---	Pass	4.7
AC Power Line Conducted Emissions from EUT	5.4	15.315	7 *	Pass	4.10
Security Code Information	3.3	---	---	Pass	2.2

INTERTEK TESTING SERVICES

1.1 Summary of Test Results (continued)

Specific Requirements for UPCS Device					
Test Items	RSS-213 Clause	FCC Part 15 Section	Test Procedure ANSI C63.17	Results	Details see section
Unwanted Emission Inside the Sub-Band	5.8.2	15.323(d)	6.1.6.1	Pass	4.8
Emissions Outside the Sub-Band	5.8.1	15.323(d)	6.1.6.2	Pass	4.9
Frame Repetition Stability	5.2(13)	15.323(e)	6.2.2	Pass	4.11
Frame Period and Jitter	5.2(13)	15.323(e)	6.2.3	Pass	4.12
Carrier Frequency Stability	5.3	15.323(f)	6.2.1	Pass	4.13
Monitoring Threshold Limit	5.2(2&9)	15.323(c2&c9)	7.3.1	NA	4.14.1
Least Interfered Channel (LIC) Selection	5.2(5)	15.323(c)(5)	7.3.2	Pass	4.14.2.1
Least Interfered Channel (LIC) Confirmation	5.2(5)	15.323(c)(5)	7.3.2	Pass	4.14.2.2
Maximum Spectrum Occupancy	5.2(5)	15.323(c)(5)	---	Pass	4.14.2.3
Monitoring Time	5.2(1)	15.323(c)(1)	7.3.3	Pass	4.15
Maximum Transmit Period	5.2(3)	15.323(c)(3)	---	NA	4.16
System Acknowledgement	5.2(4)	15.323(c4)	8.1 or 8.2	Pass	4.17
Random Waiting	5.2(6)	15.323(c)(6)	8.1.2 or 8.1.3	NA	4.18
Monitoring Bandwidth	5.2(7)	15.323(c)(7)	7.4	Pass	4.19
Maximum Reaction Time	5.2(7)	15.323(c)(7)	7.5	Pass	4.20
Monitoring Antenna	5.2(8)	15.323(c)(8)	4	Pass	4.21
Duplex Connections	5.2(10)	15.323(c)(10)	8.3	Pass	4.22
Alternative Monitoring Interval for Co-located Device	5.2(11)	15.323(c)(11)	8.4	NA	4.23
Fair Access	5.2(12)	15.323(c)(12)	---	Pass	4.24

INTERTEK TESTING SERVICES

1.2 Statement of Compliance

The equipment under test is found to be complying with the following standards:

FCC Part 15, October 1, 2014 Edition
RSS-213 Issue 3, March 2015
RSS-Gen Issue 4, November 2014

INTERTEK TESTING SERVICES

EXHIBIT 2 GENERAL DESCRIPTION

INTERTEK TESTING SERVICES

2.0 General Description

2.1 Product Description

The VC7004 is a 1.9GHz DECT Multi-Color Smart LED Light Bulb. It operates at frequency range of 1921.536MHz to 1928.448MHz with 5 channels (1921.536MHz, 1923.264MHz, 1924.992MHz, 1926.720MHz and 1928.448MHz) The Light Bulb is powered by AC power 120VAC, 60Hz. When It is paired on a companion device, it allows user to remote control its light On/Off, dimming and change red/green/blue/white color via this companion device.

The antenna used in the light bulb is integral, and the test sample is a prototype.

Model(s): VC71214, VC71215, VC71216 and VC71217 are the same as the Model: VC7004 in electronics/electrical designs, including software & firmware, PCB layout and construction design/physical design/enclosure. The only differences between these models are color and model number. Different model number represents different number of RGB light bulb with different combinations of IP hub / (IP hub with wireless wall switch) in the bundle to be sold for marketing purpose.

2.2 Technical Description

The circuit description and digital modulation techniques description are saved with filename: descri.pdf.

2.3 Test Methodology

The radiated emission measurements for unintentional radiator (if any) and AC power line-conducted emission measurements were performed according to the test procedures specified in ANSI C63.4 (2014). The radiated emission measurements for intentional radiator contained in UPCS device, conducted emission measurements, Listen Before Transmit (LBT) tests, Time Frame and Frequency Stability tests were performed according to the test procedures specified in ANSI C63.17 (2013). All radiated measurements were performed in radiated emission test site. Preliminary scans were performed in the radiated emission test site only to determine worst case modes. All radiated tests were performed at an antenna to EUT distance of 3 meters, unless stated otherwise in the "Justification Section" of this Application. All other measurements were made in accordance with the procedures in 47 CFR Part 2 / RSS-Gen Issue 4 (2014).

2.4 Test Facility

The radiated emission test site, AC power line conducted measurement facility and antenna port conducted measurement facility used to collect the radiated data, AC Power Line conducted data, and conductive data are at Intertek Testing Services Hong Kong Ltd., which is located at Workshop No. 3, G/F., World-Wide Industrial Centre, 43-47 Shan Mei Street, Fo Tan, Sha Tin, N.T., Hong Kong. This test facility and site measurement data have been fully placed on file with FCC and Industry Canada.

INTERTEK TESTING SERVICES

**EXHIBIT 3
SYSTEM TEST CONFIGURATION**

INTERTEK TESTING SERVICES

3.0 System Test Configuration

3.1 Justification

For emissions testing, the equipment under test (EUT) was set up to transmit continuously in burst mode with pseudo-random data to simplify the measurement methodology. Care was taken to ensure proper power supply voltages during testing. During testing, all cables (if any) were manipulated to produce worst-case emissions.

The EUT was powered by a AC power 120V, 60Hz

For the measurements, the EUT was attached to a plastic stand if necessary and placed on the wooden turntable. If the EUT is attached to accessories, they were connected and operational (as typical as possible).

The signal was maximized through rotation and placement in the three orthogonal axes. The antenna height and polarization were varied during the search for maximum signal level. The antenna height was varied from 1 to 4 meters. Detector function was in peak mode. Radiated emissions are taken at three meters unless the signal level was too low for measurement at that distance. If necessary, a pre-amplifier was used and/or the test was conducted at a closer distance.

For UPCS transmitter radiated measurement, the spectrum analyzer resolution bandwidth was approximately 1% of EUT emission bandwidth, unless otherwise specified.

Radiated emission measurements for UPCS transmitter were performed from the lowest radio frequency signal generated in the device which is greater than 9 kHz to the tenth harmonic of the highest fundamental frequency or to 40 GHz, whichever is lower.

For AC line conducted emission test, the EUT along with its peripherals were placed on a 1.0m(W)x1.5m(L) and 0.8m in height wooden table and the EUT was adjusted to maintain a 0.4 meter space from a vertical reference plane. The EUT was connected to power mains through a line impedance stabilization network (LISN), which provided 50ohm coupling impedance for measuring instrument. The LISN housing, measuring instrument case, reference ground plane, and vertical ground plane were bounded together. The excess power cable between the EUT and the LISN was bundled.

All relevant operation modes have been tested, and the worst case data is included in this report.

INTERTEK TESTING SERVICES

3.2 Radiated Emission Test Setup

The figure below shows the test setup, which is utilized to make these measurements.

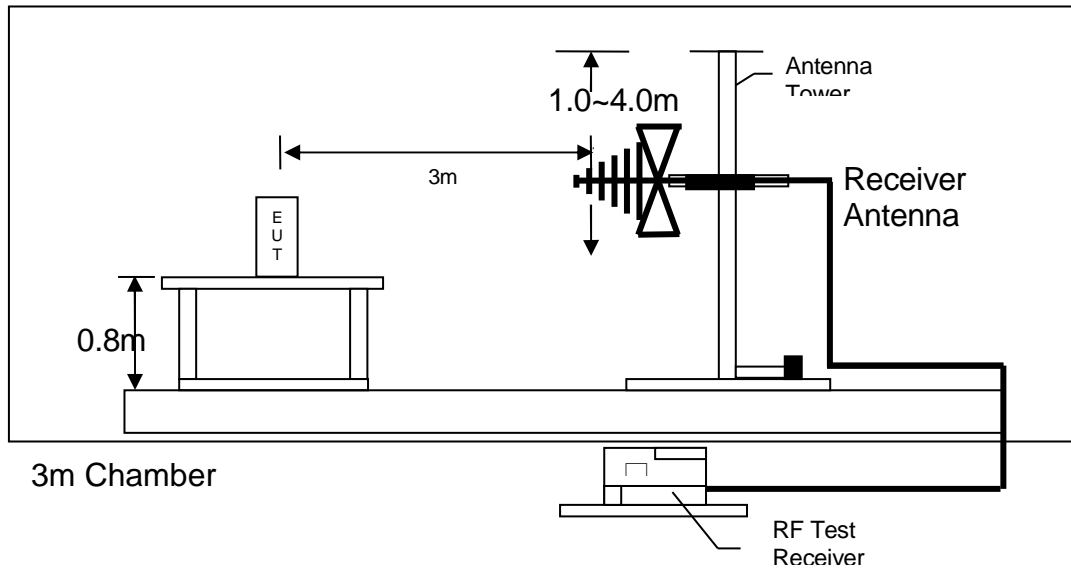

Figure 3.2.1

3.3 AC Line Conducted Emission Test Setup

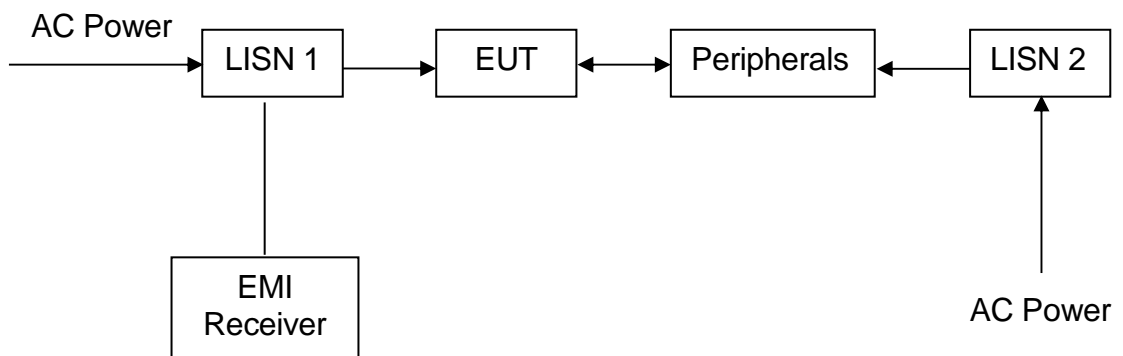

Figure 3.3.1

INTERTEK TESTING SERVICES

3.4 Conducted Emission Test Configuration

The setup and equipment setting were made in accordance with ANSI C63.17. The antenna of EUT transmitter was replaced by a coaxial cable. The impedance matching of connection, cable loss and external RF attenuator are taken into account. The EUT was arranged to communicate via a fixed carrier frequency between its transmitter and a companion device. The transmission was configured in burst mode with pseudo-random data as typical as normal operation.

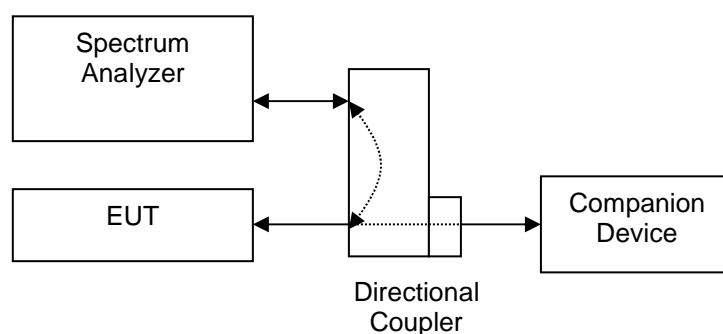

Figure 3.4.1

3.5 Conducted Monitoring and Operation Test Configuration

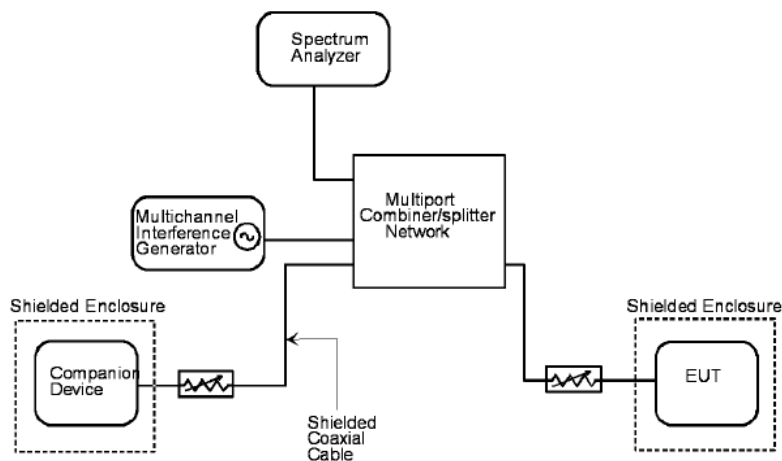

Figure 3.5.1

3.6 EUT Exercising Software

The EUT exercise program (if any) used during radiated and conducted testing was designed to exercise the various system components in a manner similar to a typical use.

INTERTEK TESTING SERVICES

3.7 Details of EUT and Description of Accessories

Details of EUT:

AC power 120VAC, 60Hz was used to power the device. Their descriptions are listed below.

- (1) AC power input: 120VAC, 60Hz.

Description of Accessories:

- (1) VTech Base Unit, Model: VC7151 (Supplied by Client)

3.8 Measurement Uncertainty

When determining of the test conclusion, the Measurement Uncertainty of test has been considered. The values of the Measurement uncertainty for radiated emission test, AC line conducted emission test and RF conducted test, frequency stability and timing jitter are $\pm 5.3\text{dB}$, $\pm 4.2\text{dB}$, $\pm 1\text{dB}$, $\pm 23\text{Hz}$, $0.1\mu\text{s}$ respectively.

INTERTEK TESTING SERVICES

**EXHIBIT 4
TEST RESULTS**

INTERTEK TESTING SERVICES

4.0 **Measurement Results**

4.1 Antenna Requirement, FCC Rule 15.317 / RSS-Gen Clause 7.1.2:

EUT must meet the antenna requirement of FCC Rule 15.203 / RSS-Gen Clause 7.1.2.

EUT uses permanently attached antenna(s) which is considered sufficient to comply with the provisions of this rule. Please refer to internal photos.pdf for more details.

EUT uses unique antenna jack(s) or electrical connector(s) which is considered sufficient to comply with the provisions of this rule. Please refer to internal photos.pdf for more details.

4.2 Digital Modulation Techniques, FCC Rule 15.319(b) / RSS-213 Clause 5.1:

All transmissions must use only digital modulation techniques.

The requirements are made in accordance with ANSI C63.17 sub-clause 6.1.4.

Attestation:

Please refer to the technical description(descr.pdf) or relevant DECT standards for more details.

INTERTEK TESTING SERVICES

4.3 Emission Bandwidth, FCC Rule 15.323(a) / Occupied Bandwidth, RSS-213 Clause 5.5:

Operation shall be contained within the 1920 – 1930 MHz band. The emission bandwidth (*B*) shall be less than 2.5 MHz and greater than 50 kHz.

Measurements are made in accordance with ANSI C63.17 sub-clause 6.1.3 and RSS-Gen clause 4.6.1. Test setup is shown in section 3.4 Figure 3.4.1.

Test Results:

I. Traffic Carrier

Channel	Channel Frequency (MHz)	Measuring Signal Level	Measured Emission Bandwidth (MHz)	Results
Lowest	1921.536	26 dB down	1.47	Pass
Middle	1924.992	99% Bandwidth	1.24	Pass
Highest	1928.448	26 dB down	1.45	Pass

The plots of emission bandwidth and occupied bandwidth are saved as below.

INTERTEK TESTING SERVICES

Plots of emission bandwidth

Lowest channel, Traffic carrier

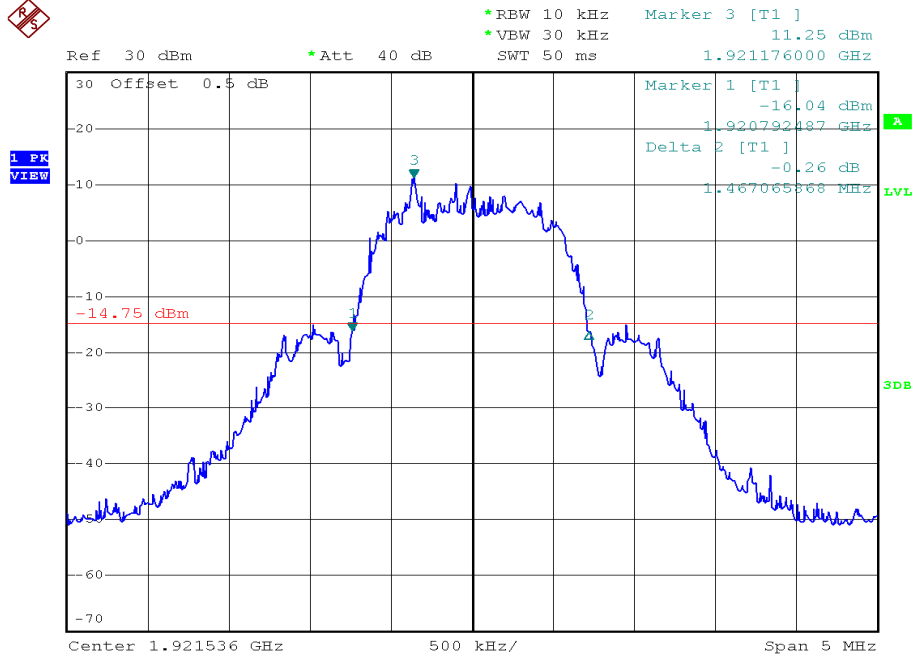

Highest channel, Traffic carrier

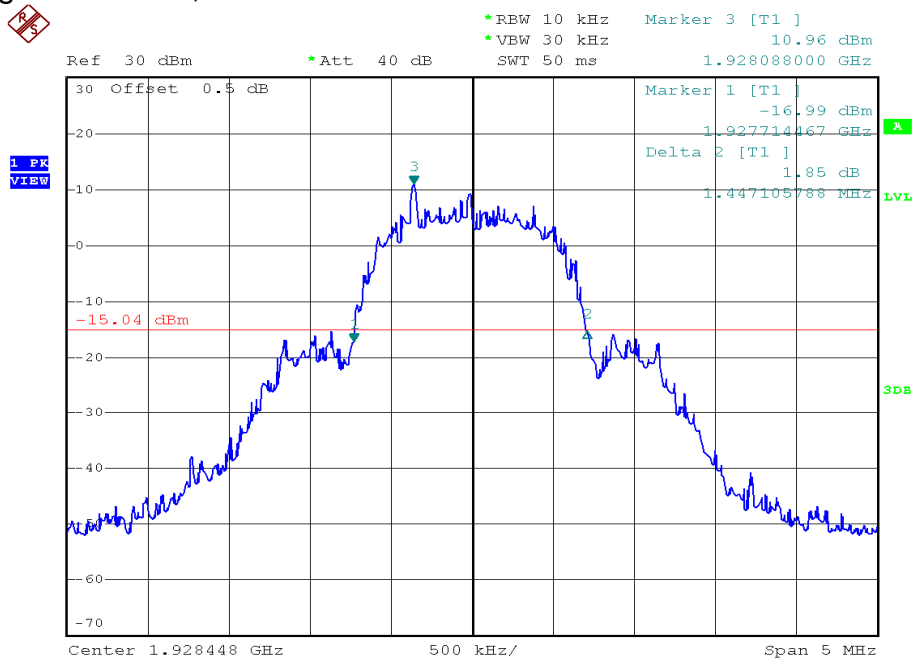

INTERTEK TESTING SERVICES

Plots of occupied bandwidth

Middle channel, Traffic carrier

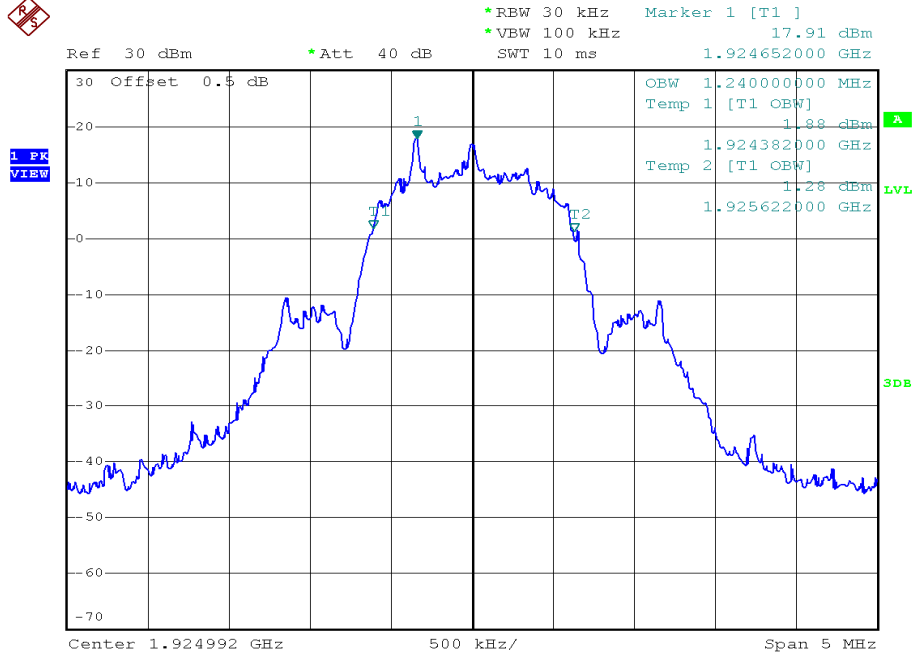

INTERTEK TESTING SERVICES

4.4 Directional Gain of the Antenna, FCC Rule FCC 15.319(e) / RSS-213 Clause 4:

The peak transmit power shall be reduced by the amount in dB that the maximum directional gain of the antenna exceeds 3 dBi.

The requirements are made in accordance with ANSI C63.17 sub-clause 4.3.1.

- Manufacturer declares that the directional gain of the antenna is less than or equal to 3dBi. No peak transmit power reduction is required.
- Manufacturer declares that the directional gain of the antenna is greater than 3dBi. The peak transmit power shall be reduced by ___ dB.

INTERTEK TESTING SERVICES

4.5 Peak Transmit Power, FCC Rule 15.319(c) / RSS-213 Clause 5.6:

The peak transmit power (P_{EUT}) shall not exceed $100\mu W$ multiplied by the square root of the emission bandwidth / occupied bandwidth (B) in Hz or $5 \log_{10} B - 10$ dBm. The peak transmit power shall be reduced by the amount in dB that the maximum directional gain of the antenna exceeds 3 dBi.

Measurements are made in accordance with ANSI C63.17 sub-clause 6.1.2. Test setup is shown in section 3.4 Figure 3.4.1. The cable loss and/or external attenuation are included in OFFSET function of spectrum analyzer.

Calculation of Peak Transmit Power Limit (P_{max}):

$$[\times] \quad P_{max} = 5 \log_{10} B - 10 \text{ dBm} \quad \text{when } G_A \leq 3\text{dBi}$$

$$[\] \quad P_{max} = 5 \log_{10} B - 10 \text{ dBm} - (G_A - 3\text{dBi}) \quad \text{when } G_A > 3\text{dBi}$$

Where G_A = EUT Antenna Gain: 0 dBi

B = Measured Emission Bandwidth / Occupied Bandwidth

Test Results:

Traffic Carrier

Channel	Channel Frequency (MHz)	Measured Peak Transmit Power (dBm)	Limit (dBm)	Results
Lowest	1921.536	19.47	20.84	Pass
Middle	1924.992	19.50	20.47	Pass
Highest	1928.448	19.59	20.81	Pass

The plots of peak transmit power are saved as below.

INTERTEK TESTING SERVICES

Plots of peak transmit power

Lowest channel, Traffic carrier

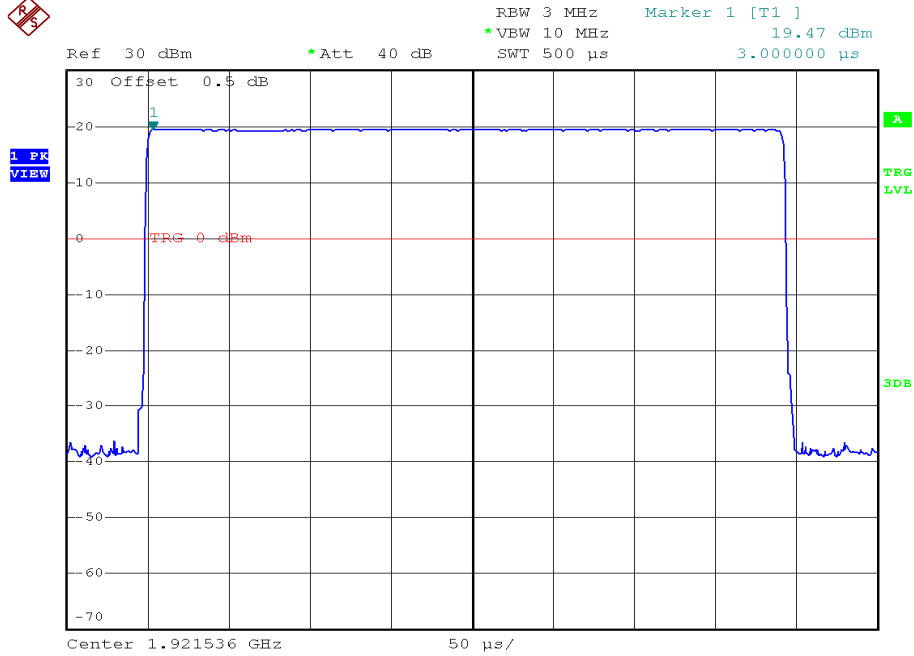

Middle channel, Traffic carrier

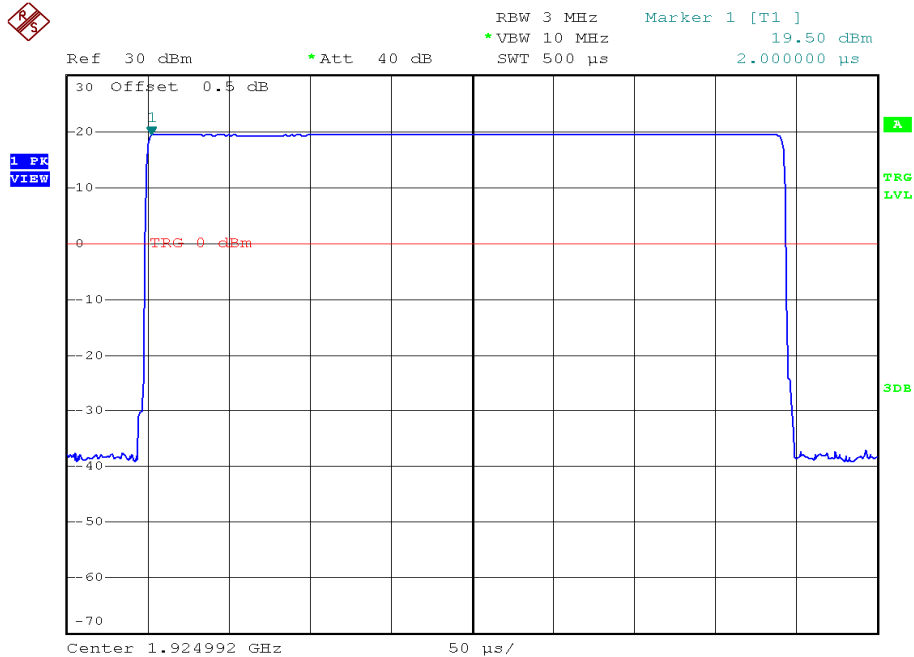

Plots of peak transmit power

Highest channel, Traffic carrier

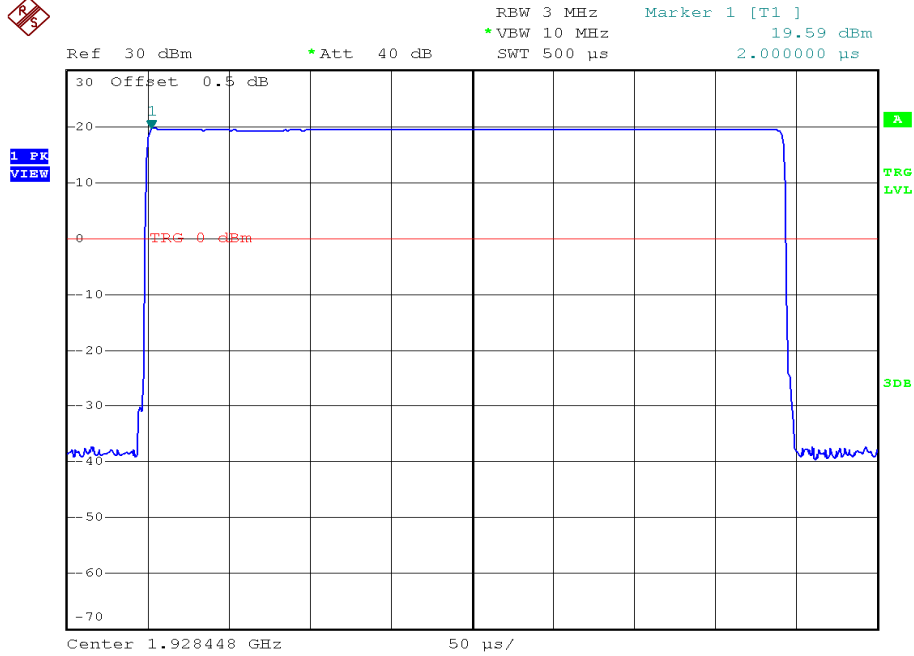

INTERTEK TESTING SERVICES

4.6 Power Spectral Density, FCC Rule 15.319(d) / RSS-213 Clause 5.7:

Power spectral density shall not exceed 3 mW (4.8dBm) in any 3 kHz bandwidth as measured with a spectrum analyzer having a resolution bandwidth of 3 kHz.

Measurements are made in accordance with ANSI C63.17 sub-clause 6.1.5. Test setup is shown in section 3.4 Figure 3.4.1.

Test Results:

Traffic Carrier

Channel	Channel Frequency (MHz)	Measured Power Spectral Density (dBm/3kHz)	Limit (dBm/3 kHz)	Results
Lowest	1921.536	-6.3	4.8	Pass
Middle	1924.992	-7.2	4.8	Pass
Highest	1928.448	-5.8	4.8	Pass

The plots of the power spectral density are as below.

Plots of the power spectral density (FCC)

Lowest channel, Traffic carrier

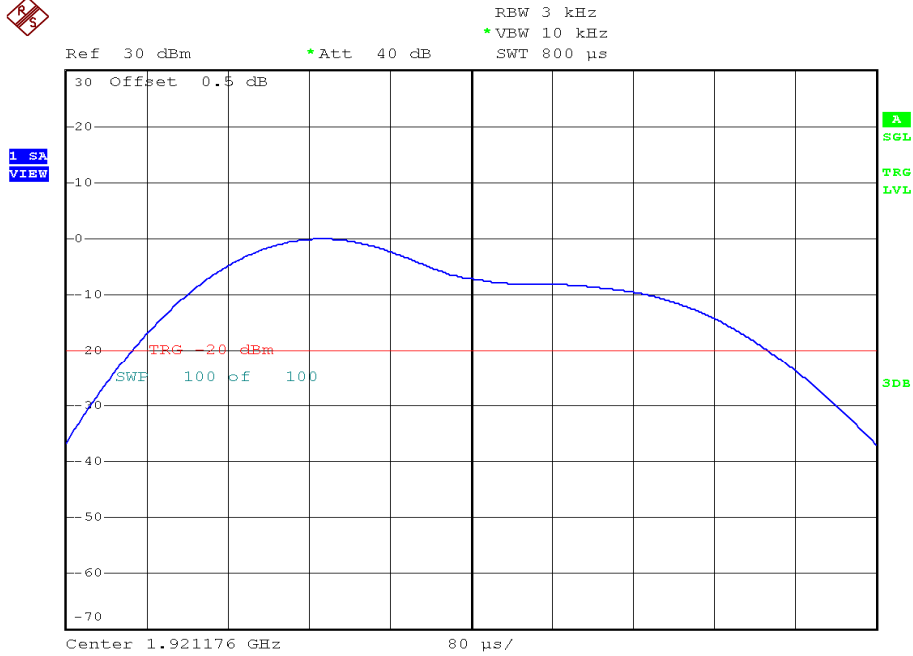

Highest channel, Traffic carrier

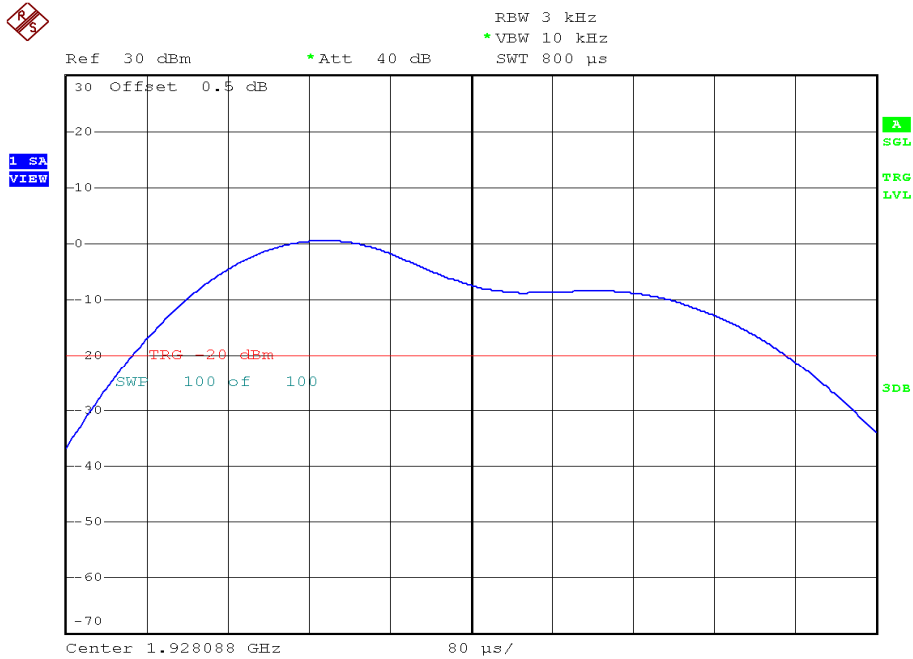

INTERTEK TESTING SERVICES

Plots of the power spectral density (IC)

Middle channel, Traffic carrier

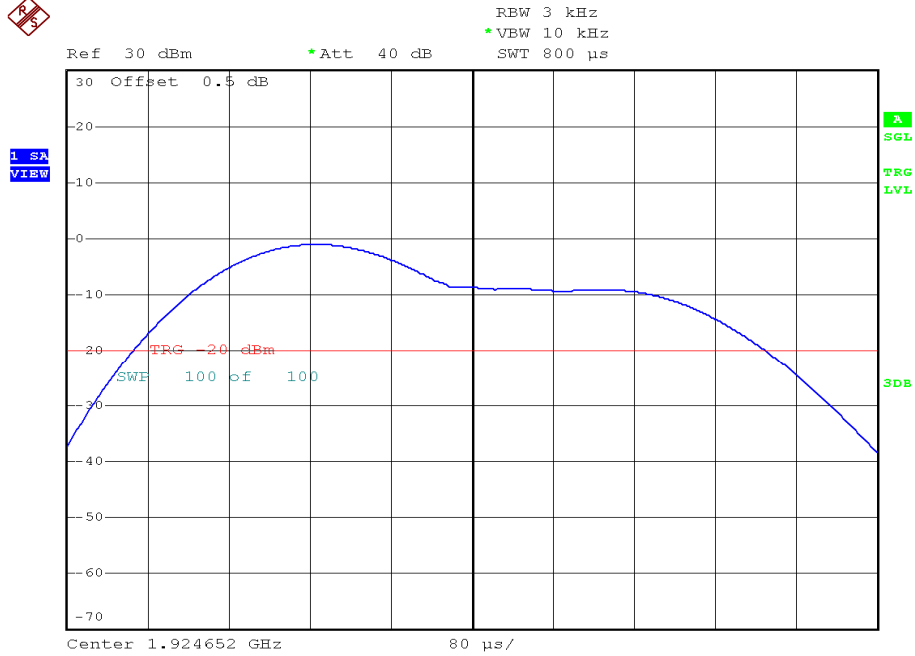

INTERTEK TESTING SERVICES

4.7 Automatic Discontinuation of Transmission, FCC Rule 15.319(f) / RSS-213 Clause 5.2:

The EUT shall automatically discontinue transmission in case of either absence of information to transmit or operational failure. These provisions are not intended to preclude transmission of control and signaling information or use of repetitive codes used by certain digital technologies to complete frame or burst intervals.

The manufacturer declares that the EUT can automatically discontinue transmission in case of either absent information to transmit or operational failure. Please refer to the declaration letter for details, which is saved with filename: declaration.pdf.

INTERTEK TESTING SERVICES

4.8 Unwanted Emission Inside the Sub-Band, FCC Rule 15.323(d) / RSS-213 Clause 5.8.2:

Emissions inside the sub-band must comply with the following emission mask:

1. In the bands between $1B$ and $2B$ measured from the center of the emission bandwidth, emission shall be at least 30 dB below the permitted peak transmit power.
2. In the bands between $2B$ and $3B$ measured from the center of the emission bandwidth, emission shall be at least 50 dB below the permitted peak transmit power.
3. In the bands between $3B$ and the band edge, emission shall be at least 60 dB below the permitted peak transmit power.

Where B = emission bandwidth or occupied bandwidth in Hz

Measurements are made in accordance with ANSI C63.17 sub-clause 6.1.6.1. Test setup is shown in section 3.4 Figure 3.4.1.

Test Results:

I. Traffic Carrier

Channel	Channel Frequency (MHz)	Results
Lowest	1921.536	Pass
Middle	1924.992	Pass
Highest	1928.448	Pass

The plots of the unwanted emission inside the sub-band are as below.

INTERTEK TESTING SERVICES

Plots of the unwanted emission inside the sub-band (FCC)

Lowest channel, Traffic carrier

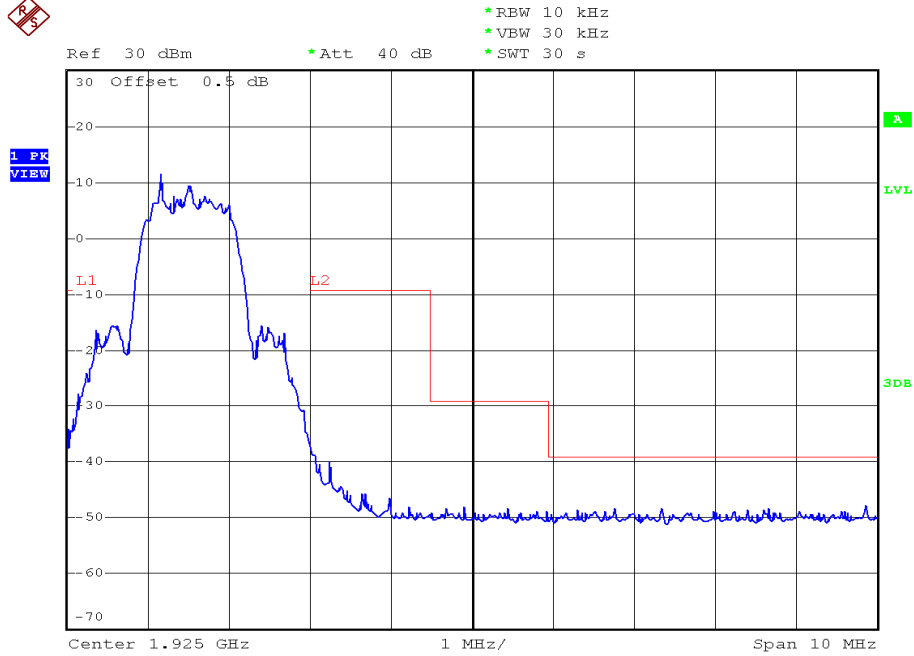

Highest channel, Traffic carrier

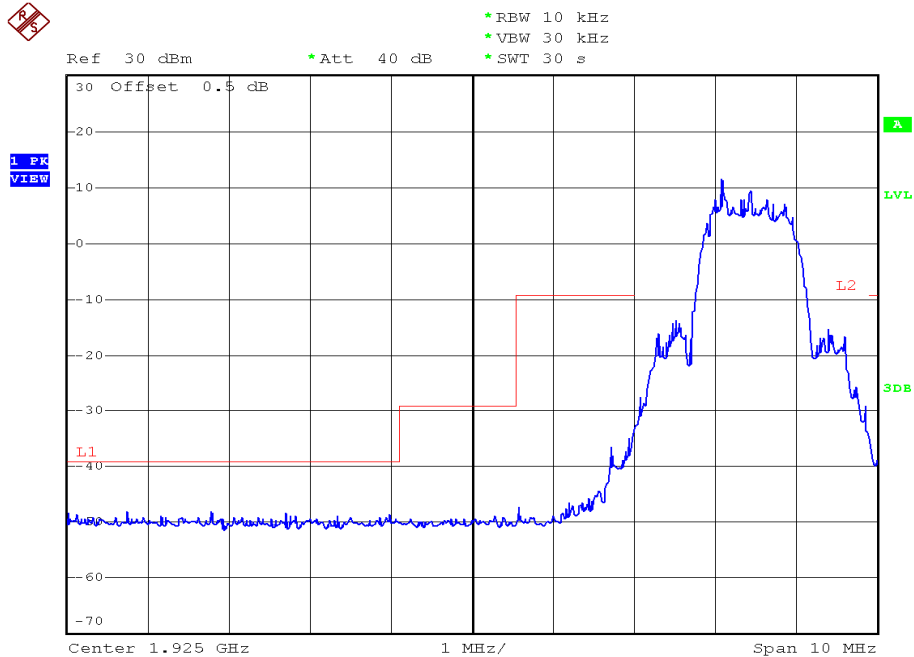

INTERTEK TESTING SERVICES

Plots of the unwanted emission inside the sub-band (IC)

Lowest channel, Traffic carrier

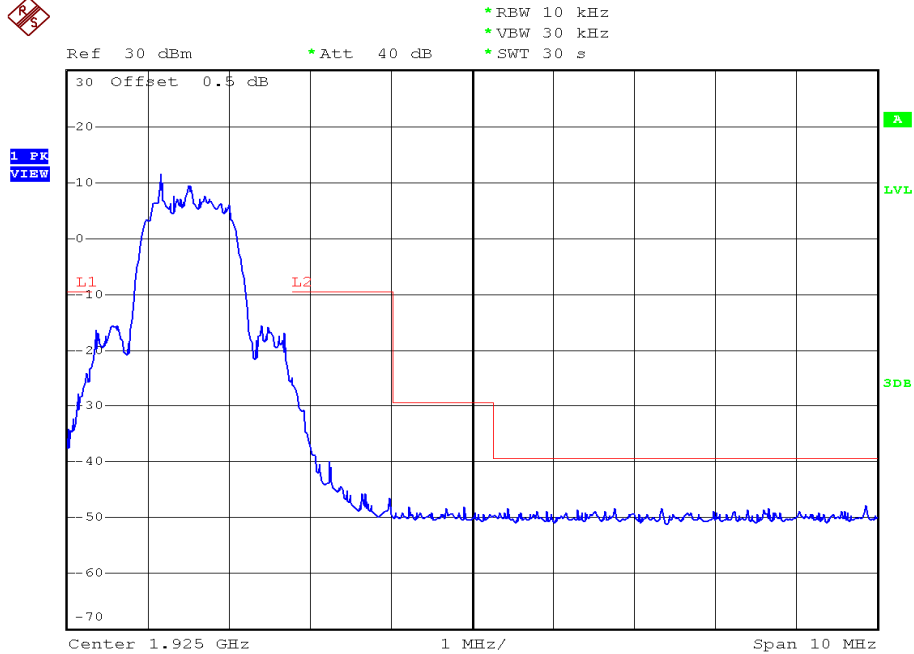

Middle channel, Traffic carrier

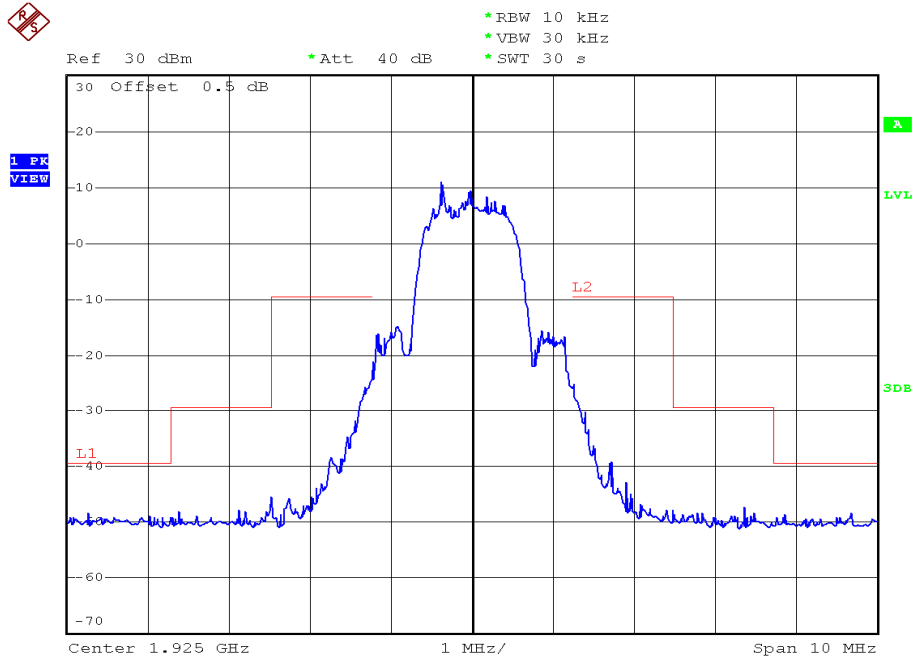

INTERTEK TESTING SERVICES

Plots of the unwanted emission inside the sub-band (IC)

Highest channel, Traffic carrier

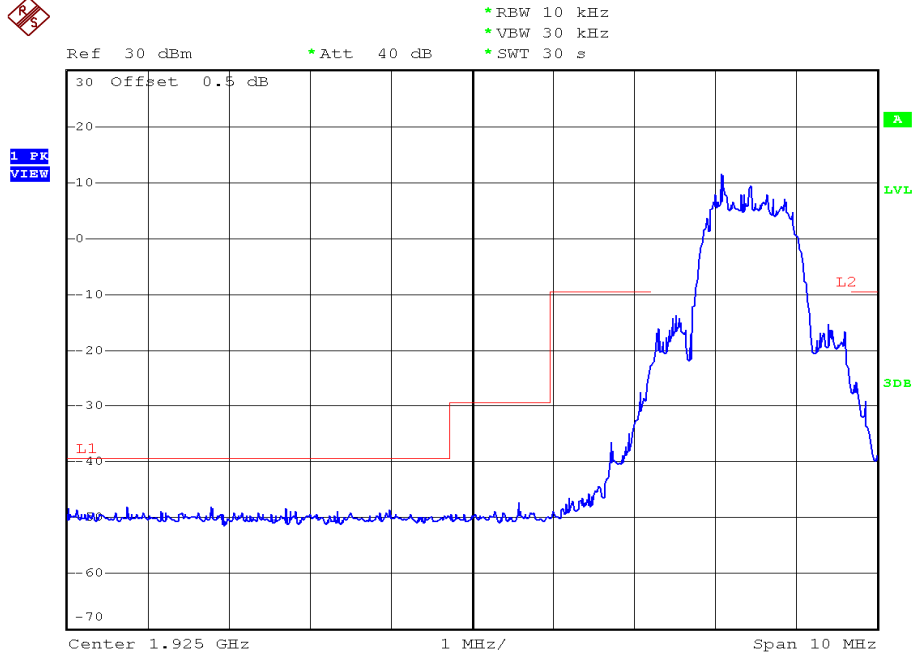

INTERTEK TESTING SERVICES

4.9 Emissions Outside the Sub-Band, FCC Rule 15.323(d) / RSS-213 Clause 5.8.1:

Emissions outside the sub-band shall be attenuated below a reference power of 112 mW (20.5 dBm) as follows:

1. 30 dB between the band edge and 1.25 MHz above or below the band;
2. 50 dB between 1.25 and 2.5 MHz above or below the band; and
3. 60 dB at 2.5 MHz or greater above or below the band, or shall meet the requirement of FCC Rule 15.319(g) which shall not exceed the limits of FCC Rule 15.209 / RSS-210 Clause 2.5.

Example: Calculation of Limit for emissions between the band edge and 1.25 MHz (1920.000 – 1918.750 MHz)

The emissions shall not exceed the Limit: 20.5 dBm – 30 dB = -9.5 dBm

Measurements are made in accordance with ANSI C63.17 sub-clause 6.1.6.2. Radiated emissions test method is used. Emissions that are directly caused by digital circuits in the transmit path and transmitter portion are measured.

Test setup is shown in section 3.2 Figure 3.2.1

Test Results:

Channel	Carrier Frequency (MHz)	Measured Band (MHz)	Limit (dBm)	Results
Lowest	1921.536	1920.000 - 1918.750	-9.5	Pass
		1918.750 - 1917.500	-29.5	Pass
		0.009 - 1917.500 & 1932.500 - 19300.000	-39.5 / RSS-210 Clause 2.5	Pass
Highest	1928.448	1930.000 - 1931.250	-9.5	Pass
		1931.250 - 1932.500	-29.5	Pass
		0.009 – 1917.500 & 1932.500 - 19300.000	-39.5 / RSS-210 Clause 2.5	Pass

INTERTEK TESTING SERVICES

4.9.1 Radiated Emissions Configuration Photographs:

Worst Case Radiated Emission
at

11529.216 MHz

The worst case radiated emission configuration photographs are saved with filename:
config photos.pdf

4.9.2 Radiated Emissions Data:

Data are included of the worst case configuration (the configuration which resulted in the highest emission levels). A sample calculation, configuration photographs and data tables of the emissions are included. All measurements were performed with peak detection unless otherwise specified.

The data in table 1-3 list the significant emission frequencies, the limit and the margin of compliance.

Judgement:

Passed by 11.3 dB margin

INTERTEK TESTING SERVICES

Mode: Transmission

Table 1

**Radiated Emissions Data
Pursuant To FCC Part 15 Section 15.323 (d) / RSS-213 Clause 5.8.1
Emissions Requirements**

Lowest Channel

Polarization	Frequency (MHz)	Measured Power (dBm)	Power Limit (dBm)	Margin (dB)
V	1917.002	-55.0	-39.5	-15.5
V	1917.904	-54.0	-29.5	-24.5
V	1919.820	-46.3	-9.5	-36.8
H	3843.072	-54.9	-39.5	-15.4
H	5764.608	-53.9	-39.5	-14.4
H	7686.144	-53.1	-39.5	-13.6
H	9607.680	-51.4	-39.5	-11.9
H	11529.216	-50.8	-39.5	-11.3

NOTES:

1. Peak detector is used for the emission measurement.
2. All measurements were made at 3 meters.
3. Negative value in the margin column shows emission below limit.

INTERTEK TESTING SERVICES

Mode: Transmission

Table 2

**Radiated Emissions Data
Pursuant To FCC Part 15 Section 15.323 (d) / RSS-213 Clause 5.8.1
Emissions Requirements**

Highest Channel

Polarization	Frequency (MHz)	Measured Power (dBm)	Power Limit (dBm)	Margin (dB)
V	1930.190	-44.8	-9.5	-35.3
V	1931.470	-53.3	-29.5	-23.8
V	1932.780	-55.2	-39.5	-15.7
H	3856.896	-55.2	-39.5	-15.7
H	5785.344	-54.0	-39.5	-14.5
H	7713.792	-52.9	-39.5	-13.4
H	9642.240	-52.0	-39.5	-12.5
H	11570.688	-51.2	-39.5	-11.7

NOTES:

1. Peak detector is used for the emission measurement.
2. All measurements were made at 3 meters.
3. Negative value in the margin column shows emission below limit.

INTERTEK TESTING SERVICES

Mode: Lamp ON

Table 3

**Radiated Emissions Data
Pursuant To FCC Part 15 Section 15.323 (d) / RSS-213 Clause 5.8.1
Emissions Requirements**

Polarization	Frequency (MHz)	Measured Power (dBm)	Power Limit (dBm)	Margin (dB)
V	58.493	-62.0	-39.5	-22.5
V	87.836	-66.3	-39.5	-26.8
V	99.113	-64.4	-39.5	-24.9
V	126.757	-70.5	-39.5	-31.0
H	160.344	-63.8	-39.5	-24.3
H	232.245	-61.6	-39.5	-22.1
V	246.068	-69.8	-39.5	-30.3
H	356.648	-73.8	-39.5	-34.3

NOTES:

1. Peak detector is used for the emission measurement.
2. All measurements were made at 3 meters.
3. Negative value in the margin column shows emission below limit.

INTERTEK TESTING SERVICES

4.9.3 Field Strength Calculation

The field strength is calculated by adding the reading on the Spectrum Analyzer to the factors associated with preamplifiers (if any), antennas, cables, pulse desensitization and average factors (when specified limit is in average and measurements are made with peak detectors). A sample calculation is included below.

$$FS = RA + AF + CF - AG + PD + AV$$

Where

- FS = Field Strength in dB μ V/m
- RA = Receiver Amplitude (including preamplifier) in dB μ V
- CF = Cable Attenuation Factor in dB
- AF = Antenna Factor in dB
- AG = Amplifier Gain in dB
- PD = Pulse Desensitization in dB
- AV = Average Factor in -dB

In the radiated emission table which follows, the reading shown on the data table may reflect the preamplifier gain. An example of the calculations, where the reading does not reflect the preamplifier gain, follows:

$$FS = RA + AF + CF - AG + PD + AV$$

Example

Assume a receiver reading of 62.0 dB μ V is obtained. The antenna factor of 7.4 dB and cable factor of 1.6 dB is added. The amplifier gain of 29.0 dB is subtracted. The pulse desensitization factor of the spectrum analyzer is 0.0 dB, and the resultant average factor is -10.0 dB. The net field strength for comparison to the appropriate emission limit is 32.0 dB μ V/m. This value in dB μ V/m is converted to its corresponding level in μ V/m.

RA = 62.0 dB μ V
AF = 7.4 dB
CF = 1.6 dB
AG = 29.0 dB
PD = 0.0 dB
AV = -10 dB

$$FS = 62.0 + 7.4 + 1.6 - 29.0 + 0.0 + (-10.0) = 32.0 \text{ dB}\mu\text{V/m}$$

$$\text{Level in } \mu\text{V/m} = \text{Common Antilogarithm} [(32.0 \text{ dB}\mu\text{V/m})/20] = 39.8 \mu\text{V/m}$$

INTERTEK TESTING SERVICES

4.9.4 Average Factor Calculation and Transmitter ON Time Measurements, FCC Rule 15.35(b, c) / RSS-Gen cl 4.5

- The EUT antenna output port was connected to the input of the spectrum analyzer. The analyzer center frequency was set to EUT RF channel carrier. The SPAN function on the analyzer was set to ZERO. The transmitter ON time was determined from the resultant time-amplitude display:

Please refer to the attached plots for more details:

The plots of Transmitter ON Time Measurements are as below.

- Please refer to the attached transmitter timing diagram that are provided by manufacturer
- Not applicable - No average factor is required.
- Please refer to Technical Description (descri.pdf) for more details

INTERTEK TESTING SERVICES

4.10 AC Power Line Conducted Emissions, FCC Rule 15.315 / RSS-213 Clause 5.4:

The AC power line conducted emission shall not exceed the limits of FCC Rule 15.207 / Table 4 in RSS-Gen Clause 7.2.4.

Measurements are made in accordance with ANSI C63.4 sub-clause 7. Emissions that are directly caused by digital circuits in the transmit path and transmitter portion are measured.

Test setup is shown in section 3.3 Figure 3.3.1.

Not applicable – EUT is only powered by battery for operation.

EUT connects to AC power line. Emission Data is listed in following pages.

Base Unit connects to AC power line and has transmission. Handset connects to AC power line (indirectly) but has no transmission. Emission Data of Base Unit is listed in following pages

Handset connects to AC power line (indirectly) only during charging. Emission Data is listed in following pages.

INTERTEK TESTING SERVICES

4.10.1 AC Power Line Conducted Emissions Configuration Photographs:

Worst Case AC Power Line Conducted Emission
at

208.5 kHz

The worst case AC power Line conducted emission configuration photographs are saved with filename: config photos.pdf

4.10.2 AC Power Line Conducted Emissions Data:

The plot(s) and data in the following pages list the significant emission frequencies, the limit and the worst case margin of compliance.

Judgment:

Base unit: Passed by 12.18 dB margin compared with quasi-peak limit

INTERTEK TESTING SERVICES

Worst Case: Light On



RBW 9 kHz
MT 1 s

Att 10 dB AUTO PREAMP OFF

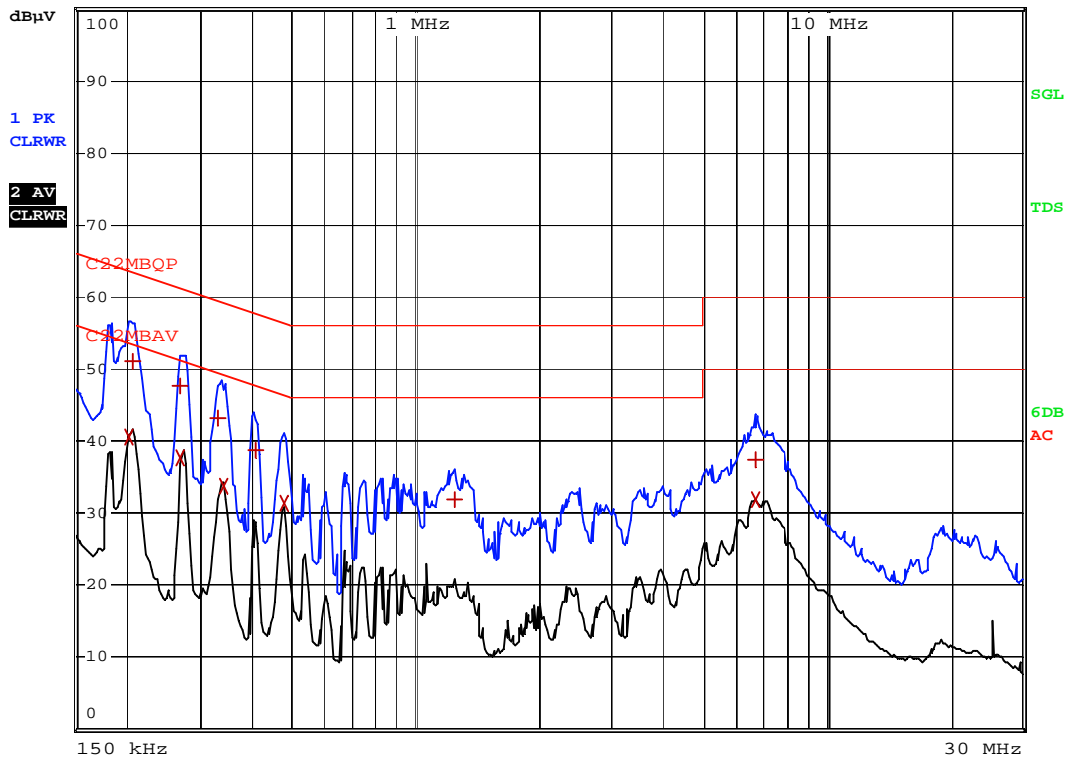

Date: 3.DEC.2015 14:49:14

INTERTEK TESTING SERVICES

Worst Case: Light On

EDIT PEAK LIST (Final Measurement Results)

Trace1: C22MBQP

Trace2: C22MBAV

Trace3: ---

	TRACE	FREQUENCY	LEVEL dB μ V		DELTA LIMIT dB
2	CISPR Average	204 kHz	40.64	L1	-12.80
1	Quasi Peak	208.5 kHz	51.08	L1	-12.18
1	Quasi Peak	271.5 kHz	47.75	N	-13.31
2	CISPR Average	271.5 kHz	37.66	N	-13.41
1	Quasi Peak	334.5 kHz	43.29	N	-16.04
2	CISPR Average	339 kHz	33.68	N	-15.54
1	Quasi Peak	406.5 kHz	38.69	N	-19.02
2	CISPR Average	478.5 kHz	31.49	N	-14.87
1	Quasi Peak	1.239 MHz	31.88	N	-24.11
2	CISPR Average	6.702 MHz	31.96	N	-18.04
1	Quasi Peak	6.7425 MHz	37.46	N	-22.53

Date: 3.DEC.2015 14:48:58

INTERTEK TESTING SERVICES

4.11 Frame Repetition Stability, FCC Rule 15.323(e) / RSS-213 Clause 5.2(13):

- EUT implements Time Division Duplex (TDD) (not include TDMA) in order to support duplex connection on a given frequency carrier shall maintain a frame repetition rate whereby 3 x standard deviation of the frequency stability shall not exceed 50 ppm, not including a shift of the mean.

- EUT uses Time Division Multiple Access (TDMA) in order to support multiple communication links on a given frequency carrier shall maintain a frame repetition rate whereby 3 x standard deviation of the frequency stability shall not exceed 10 ppm, not including a shift of the mean.

Measurements are made in accordance with ANSI C63.17 sub-clause 6.2.2. Test setup is shown in section 3.4 Figure 3.4.1. A spectrum analyzer measures the time duration between rising edges of two consecutive frames over a time period of at least 1000 frame periods. These measurement values are used to compute the 3 x standard deviation of the frequency stability.

Test Results:

Maximum Frame Repetition Stability (ppm)	Limit (ppm)	Results
>-0.0.001 or <0.0001	±10	Pass

INTERTEK TESTING SERVICES

4.12 Frame Period and Jitter, FCC Rule 15.323(e) / RSS-213 Clause 5.2(13):

The frame period (a set of consecutive time slots in which the position of each time slot can be identified by reference to a synchronizing source) of EUT operating in these sub-bands shall be 20 ms or 10 ms/X where X is a positive whole number.

The jitter (time-related, abrupt, spurious variations in the duration of the frame interval) introduced at the two ends of such a communication link shall not exceed 25 μ s for any two consecutive transmissions. Transmissions shall be continuous in every time and spectrum window during the frame period defined for EUT.

Measurements are made in accordance with ANSI C63.17 sub-clause 6.2.3. Test setup is shown in section 3.4 Figure 3.4.1. A spectrum analyzer measures the time duration between the rising edges of two consecutive frames. The measurements are taken over 100,000 frames. These measurement values are used to compute mean value and the difference between any two consecutive frame periods. The mean value is the frame period.

Test Results:

Measured Maximum Jitter (μ s)	Limit (μ s)	Result
-0.3006	± 25	Pass

INTERTEK TESTING SERVICES

4.13 Carrier Frequency Stability, FCC Rule 15.323(f) / RSS-213 Clause 5.3:

The carrier frequency stability of EUT shall be maintained within +/-10 ppm at the following conditions:

1. Over 1 hour at nominal supply voltage and a temperature of +20 °C;
2. Over a variation in the primary supply voltage of 85 % to 115 % of nominal supply voltage at a temperature of +20 °C. This test does not apply to an EUT that is only powered by battery for operation;
3. Over a temperature variation of -20 °C to +50 °C or at extreme temperatures as declared by manufacturer, and at nominal supply voltage.

The nominal supply voltage: 115 VAC and the extreme temperatures of -20°C to +50°C are declared by manufacturer.

Measurements are made in accordance with ANSI C63.17 sub-clause 6.2.1 The EUT and CMD60 is connected with shielded coaxial cable. The EUT is controlled by DECT Radio Communication Tester, CMD60, to use a fixed frequency channel during test as well as record the frequency offset. The transmission of EUT is in burst mode with pseudo-random data. Test setup is shown as follows.

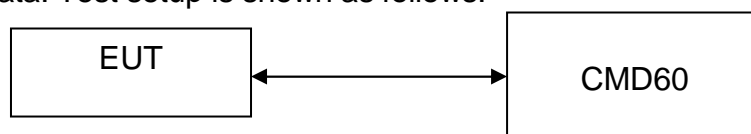

Test Results:

a. Carrier Frequency Stability over time

Supply Voltage	Temperature (°C)	Measured Frequency Offset Over an hour (ppm)		Limit (ppm)	Result
		Max.	Min.		
Nominal	+20°C	0.72	0.31	±10	Pass

b. Carrier Frequency Stability over Power Supply Voltage

Supply Voltage	Temperature (°C)	Measured Frequency Offset (ppm)	Limit (ppm)	Results
85%	+20°C	-6.55	±10	Pass
115%	+20°C	-6.55	±10	Pass

c. Carrier Frequency Stability over Temperature

Supply Voltage	Temperature (°C)	Measured Frequency Offset (ppm)	Limit (ppm)	Results
Nominal	-20°C	2.29	±10	Pass
Nominal	+50°C	-2.39	±10	Pass

INTERTEK TESTING SERVICES

4.14 Monitoring Threshold:

Monitoring threshold can be relaxed according to FCC Rule 15.323(c)(9) / RSS-213 Clause 5.2(9). EUT that has a power output lower than the maximum permitted under FCC Rule 15.319(c) / RSS-213 Clause 5.6 may increase their monitoring detection threshold by one decibel for each one decibel that the transmitter power is below the maximum permitted.

Calculation of Monitoring Threshold Limit:

$$\begin{aligned} \text{Monitoring Threshold } (T) &\leq -174 + 10 \log_{10} B + M_L + P_{\max} - P_{\text{EUT}} \text{ dBm} \\ &\leq 15 \log_{10} B - 184 + M_L - P_{\text{EUT}} \text{ dBm} \end{aligned}$$

Where B = Measured Emission Bandwidth or Occupied Bandwidth –
 FCC: 1.45 x10⁶Hz IC: 1.24 x10⁶Hz
 M_L = Specified by the manufacturer declared in declaration.pdf for
 Monitoring Threshold (T_L)
 P_{\max} = 5 log₁₀ B – 10 dBm
 P_{EUT} = Measured Peak Transmit Power - FCC: 19.59 dBm
 IC: 19.50 dBm

Calculated Monitoring Threshold Limits:

	FCC	IC
Monitoring Threshold ($T_L + U_M$) in dBm	-75.2	-76.1

NA - Not applicable

INTERTEK TESTING SERVICES

4.14.1 Monitoring Threshold Limit, FCC Rule 15.323(c)(2) / RSS-213 Clause 5.2(2):

- [×] Not applicable – EUT supports at least of 20 duplex system access channels and implements Least Interfered Channel (LIC) algorithm. Please refer to the section 4.14.2 for more details.

- [] The monitoring threshold must not be more than 30 dB above the thermal noise power for a bandwidth equivalent to the emission bandwidth used by EUT.

Measurements are made in accordance with ANSI C63.17 sub-clause 7.3.1. Test setup is shown in section 3.5 Figure 3.5.1. The test is performed on the carrier closest to center of the band. RF signal generators apply uniform CW interference on all EUT carriers each at level $T_L + U_M + 10$ dB. Then, the interference level is reduced uniformly on all carriers until the EUT can transmit. The interference level shall be lower than or equal to the threshold limit.

Test Results:

Measured Maximum Interference Level (dBm)	Monitoring Threshold Limit (dBm) ($T_L + U_M$)		Results
	FCC	IC	
NA	-75.2	-76.1	NA

NA - Not applicable

INTERTEK TESTING SERVICES

4.14.2 Least Interfered Channel, LIC, FCC Rule 15.323(c)(5) /
RSS-213 Clause 5.2(5):

- Not implemented – EUT met monitoring threshold requirements. Please refer to the section 4.14.1 for more details
- If access to spectrum is not available as determined by section 4.14.1 and a minimum of 20 duplex system access channels are defined for the EUT, the time and spectrum windows with the lowest power level may be accessed

Number of duplex channels per frequency channel = 12
Number of frequency channel = 5
Total Duplex Channels = 60

INTERTEK TESTING SERVICES

4.14.2.1 Least Interfered Channel (LIC) Selection, FCC Rule 15.323(c)(5) / RSS-213 Clause 5.2(5):

The criteria are specified in section 4.14.2. In addition, the power measurement resolution for this comparison must be accurate to within 6 dB.

Measurements are made in accordance with ANSI C63.17 sub-clause 7.3.2. Test setup is shown in section 3.5 Figure 3.5.1. RF signal generators apply uniform CW interference on all EUT carriers except two carriers (designated f_1 and f_2), each at level $T_L + U_M + 14\text{dB}$ (cases 1 and 2) and $T_L + U_M + 8\text{dB}$ (cases 3 and 4). EUT can only transmit on f_2 carrier (cases 1 and 3) and f_1 carrier (cases 2 and 4).

Test Descriptions and Results:

LIC Procedure

	Test Descriptions	EUT transmits on	Results
1	Apply interference on f_1 at level $T_L + U_M + 7\text{ dB}$. Apply interference on f_2 at level $T_L + U_M$. Initiate transmission. Verify transmission on f_2 . Terminate transmission. Repeat 5 times.	f_2	Pass
2	Apply interference on f_1 at level $T_L + U_M$. Apply interference on f_2 at level $T_L + U_M + 7\text{ dB}$. Initiate transmission. Verify transmission on f_1 . Terminate transmission. Repeat 5 times.	f_1	Pass
3	Apply interference on f_1 at level $T_L + U_M + 1\text{ dB}$. Apply interference on f_2 at level $T_L + U_M - 6\text{ dB}$. Initiate transmission. Verify transmission on f_2 . Terminate transmission. Repeat 5 times.	f_2	Pass
4	Apply interference on f_1 at level $T_L + U_M - 6\text{ dB}$. Apply interference on f_2 at level $T_L + U_M + 1\text{ dB}$. Initiate transmission. Verify transmission on f_1 . Terminate transmission. Repeat 5 times.	f_1	Pass

NA - Not applicable

INTERTEK TESTING SERVICES

4.14.2.2 Least Interfered Channel (LIC) Confirmation, FCC Rule 15.323(c)(5) / RSS-213 Clause 5.2(5):

EUT utilizing the provision of FCC Rule 15.323(c)(5) / RSS-213 Clause 5.2(5) must have monitored all access channels defined for its system within the last 10 s and must verify, within the 20 ms (40 ms for EUT designed to use a 20 ms frame period) immediately preceding actual channel access that the detected power of the selected time and spectrum windows is no higher than the previously detected value.

Measurements are made in accordance with ANSI C63.17 sub-clause 7.3.3. This test is performed in section 4.15 and 4.16.

Results:

The tests are reported in section 4.15 and 4.16.

4.14.2.3 Maximum Spectrum Occupancy, FCC Rule 15.323(c)(5) / RSS-213 Clause 5.2(5):

No EUT or group of co-operating EUTs located within 1 meter of each other shall during any frame period occupy more than 6 MHz of aggregate bandwidth, or alternatively, more than one third of the time and spectrum windows defined by the EUT.

Attestation:

According to the technical description provided, the total number of the time and spectrum windows defined by the system is $5 \times 12 = 60$.

During any frame period, the maximum number of time and spectrum windows occupied by the system will be 12, which is less than one third of the time and spectrum windows defined by the system.

INTERTEK TESTING SERVICES

4.15 Monitoring Time, FCC Rule 15.323(c)(1) / RSS-213 Clause 5.2(1):

Immediately prior to initiating transmission, EUT must monitor the combined time and spectrum windows in which they intend to transmit for a period of at least 10 ms for EUT designed to use a 10 ms or shorter frame period, or at least 20 ms for EUT designed to use a 20 ms frame period.

Measurements are made in accordance with ANSI C63.17 sub-clause 7.3.3. Test setup is shown in section 3.5 Figure 3.5.1. RF signal generators apply uniform CW interference on all system carriers except two carriers (designated f_1 and f_2), each at level $T_L + U_M + 20\text{dB}$. EUT can only transmit on these two carriers.

Test Descriptions and Results:

	Test Descriptions	EUT transmits on	Results
1	Apply interference on f_1 at level $T_L + U_M + 20\text{dB}$, and no interference on f_2 . Initiate transmission. Verify transmission on f_2 . Then, terminate transmission.	f_2	Pass
2	Apply interference on f_2 at level $T_L + U_M + 20\text{dB}$, and remove interference from f_1 immediately. Also immediately initiate transmission but is at least 20 ms after interference on f_2 is applied. Verify transmission on f_1 .	f_1	Pass

INTERTEK TESTING SERVICES

4.16 Maximum Transmit Period, FCC Rule 15.323(c)(3) / RSS-213 Clause 5.2(3):

If no signal above the threshold level is detected, transmission may commence and continue with the same emission bandwidth in the monitored time and spectrum windows without further monitoring. However, occupation of the same combined time and spectrum windows by a EUT or group of co-operating EUTs continuously over a period of time longer than 8 hours is not permitted without repeating the access criteria.

EUT establishes a communication channel with its companion device, which occupies the duplex pair combined time and spectrum windows. Reference RF signal generator synchronized with the sample and then generated a pulse as a time frame reference. The centre frequency of spectrum analyzer was set to the carrier frequency and the SPAN was set to ZERO. The spectrum analyzer was used to monitor the time (reference to the time signal) and spectrum of the communication channel. The occupied time or spectrum of the communication channel shall be changed over a period of time no longer than 8 hours. For a EUT with a frame period of 10/X ms, no more than 2,880,000 X frames should be transmitted without a break.

Test setup is shown as follows:

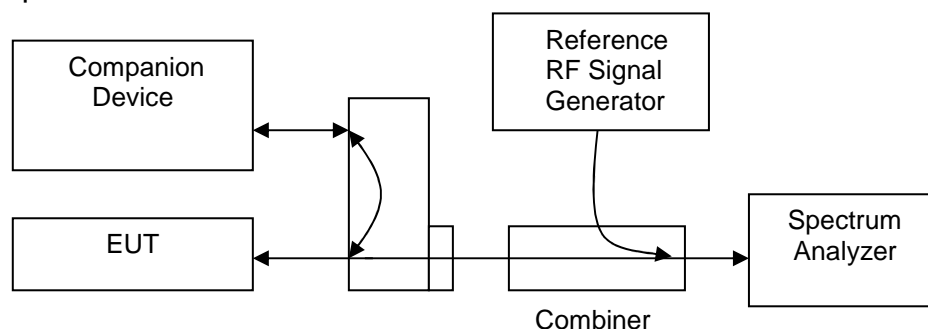

Test Results:

Measured Maximum Transmission Duration (minutes)	Limit (minutes)	Results
NA	480	NA

NA - Not applicable

INTERTEK TESTING SERVICES

4.17 System Acknowledgement, FCC Rule 15.323(c)(4) / RSS-213 Clause 5.2(4):

Once access to specific combined time and spectrum windows is obtained an acknowledgment from a system participant must be received by the initiating transmitter within one second or transmission must cease. Periodic acknowledgments must be received at least every 30 seconds or transmission must cease. Channels used exclusively for control and signaling information may transmit continuously for 30 seconds without receiving an acknowledgment, at which time the access criteria must be repeated.

Measurements are made in accordance with ANSI C63.17 sub-clause 8.1.1 and 8.2.1. Test setup is shown in section 3.5 Figure 3.5.1.

Test Results:

Timing for EUTs using control and signaling channel type transmissions:

Conditions	Transmission Duration (seconds)	Limit (seconds)	Results
Time needed to repeat access criteria	NA	30	NA

Timing for EUTs using communications channel type transmissions:

Conditions	Transmission Duration (seconds)	Limit (seconds)	Results
Activate EUT w/ companion device off	0	1	Pass
Time needed to cease Traffic Channel	5	30	Pass

NA - Not applicable

INTERTEK TESTING SERVICES

4.18 Random Waiting, FCC Rule 15.323(c)(6) / RSS-213 Clause 5.2(6):

If the selected combined time and spectrum windows are unavailable, the EUT may either monitor and select different windows or seek to use the same windows after waiting an amount of time, randomly chosen from a uniform random distribution between 10 and 150 ms, commencing when the channel becomes available.

Measurements are made in accordance with ANSI C63.17 sub-clause 8.1.2 or 8.1.3. Test setup is shown in section 3.5 Figure 3.5.1.

Test Results:

Random Waiting is not implemented in the EUT:

Conditions	Transmit Channel	Results
Interference applied at operating Channel, f_1	NA	NA

Random Waiting is implemented in the EUT:

Maximum time interval from the end of interference to the start of the control channel	The distribution of the measured time intervals	Results
NA	NA	NA

NA - Not applicable

INTERTEK TESTING SERVICES

4.19 Monitoring Bandwidth, FCC Rule 15.323(c)(7).1 / RSS-213 Clause 5.2(7).1:

The monitoring bandwidth must be equal to or greater than the emission bandwidth/occupied bandwidth of the intended transmission.

Measurements are made in accordance with ANSI C63.17 sub-clause 7.4. Test setup is shown in section 3.5 Figure 3.5.1.

Attestation:

Monitoring bandwidth of the EUT is equal to the occupied bandwidth of the intended transmission. Monitoring is made through the radio receiver used by the EUT for communication. Please refer to the section 2.2 Technical Description for more details. Designed bandwidth refers to section 4.3 Emission Bandwidth / Occupied Bandwidth.

Compliance is demonstrated by Monitoring Bandwidth Tests as shown below.

Test Results:

a. Simple Compliance Test Results

Interference from Carrier	Reaction of EUT	Results
-30% EBW / Occupied Bandwidth	NA	NA
+30% EBW / Occupied Bandwidth	NA	NA

b. Detailed Compliance Test Results - Base unit

CW Interference from Carrier	Reaction of EUT	Results
+ 6 dB	NA	NA
+ 12 dB	NA	NA
- 6 dB	NA	NA
- 12 dB	NA	NA

- A – Could Transmit
- B – Could not Transmit
- NA – Not applicable

*Remarks: Detailed Compliance Test was used to show the compliance of the EUT.

INTERTEK TESTING SERVICES

4.20 Maximum Reaction Time, FCC Rule 15.323(c)(7).2 / RSS-213 Clause 5.2(7).2:

The monitoring system bandwidth must have a maximum reaction time less than $50 \times \text{SQRT}(1.25/\text{emission bandwidth } B \text{ in MHz}) \mu\text{s}$ for signals at the applicable threshold level but shall not be required to be less than $50 \mu\text{s}$. If a signal is detected that is 6 dB or more above the applicable threshold level, the maximum reaction time shall be $35 \times \text{SQRT}(1.25/\text{emission bandwidth } B \text{ in MHz}) \mu\text{s}$ but shall not be required to be less than $35 \mu\text{s}$.

Measurements are made in accordance with ANSI C63.17 sub-clause 7.5. Test setup is shown in section 3.5 Figure 3.5.1.

Test Results:

	Test	Reaction of EUT	Results
1	Apply Interference Pulse $50\mu\text{s}$ on f_1 at pulsed level $T_L + U_m$, then apply a CW signal on f_2 at the level T_L	f_2	Pass
2	Change Interference Pulse to $35\mu\text{s}$ on f_1 at pulsed level $T_L + U_m + 6\text{dB}$,	f_2	Pass

INTERTEK TESTING SERVICES

4.21 Monitoring Antenna, FCC Rule 15.323(c)(8) / RSS-213 Clause 5.2(8):

The monitoring system shall use the same antenna used for transmission, or an antenna that yields equivalent reception at that location.

- EUT uses the same antenna used for transmission and monitoring that is in compliance meet above provision.
- EUT uses difference antenna used for transmission and monitoring. It must be verified that the monitoring antenna provides coverage equivalent to that of the transmitting antenna. Measurements are made in accordance with ANSI C63.17 sub-clause 4.

4.22 Duplex Connections, FCC 15.323(c)(10) / RSS-213 Clause 5.2(10):

An initiating device may attempt to establish a duplex connection by monitoring both its intended transmit (Tx) and receive (Rx) time and spectrum windows. If both the intended transmit and receive time and spectrum windows meet the access criteria, then the initiating device can initiate a transmission in the intended transmit time and spectrum window. If the power detected by the responding device can be decoded as a duplex connection signal from the initiating device, then the responding device may immediately begin transmitting on the receive time and spectrum window monitored by the initiating device.

Attestation:

- The Light Bulb is the initiating device of the duplex connection

Measurements are made in accordance with ANSI C63.17 sub-clause 8.3. Test setup is shown in section 3.5 Figure 3.5.1.

INTERTEK TESTING SERVICES

4.22 Duplex Connections, FCC 15.323(c)(10) / RSS-213 Clause 5.2(10): - Continued

a.

- Dual Access Criteria Check for EUT not implemented the LIC algorithm and do not offer at least 20 duplex communications channels

Interference	Reaction of EUT	Results
All Tx and Rx Window, except one for Rx Window	NA	NA
All Tx and Rx Window, except one for Tx Window	NA	NA

b.

- Dual Access Criteria Check for EUT implemented the LIC algorithm and offer at least 20 duplex communications channels:

Interference	Reaction of EUT	Results
All Tx windows with level $T_L + U_M$ & Rx windows with level $T_L + U_M + 7\text{dB}$, except one for Tx window & one for Rx window, which are not duplex.	A	Pass
All Tx windows with level $T_L + U_M + 7\text{dB}$ & Rx windows with level $T_L + U_M$, except one for Tx window & one for Rx, which are not duplex	B	Pass

- A – Could be connected on the target Rx window and its duplex mate
 B – Could be connected on the target Tx window and its duplex mate
 C – Connected on window which is not the target Tx/Rx window
 D – Could not be connected
- NA – Not applicable

INTERTEK TESTING SERVICES

4.23 Alternative Monitoring Interval for Co-located Device, FCC Rule 15.323(c)(11) / RSS-213 Clause 5.2(11):

An initiating device that is prevented from monitoring during its intended transmit window due to monitoring system blocking from the transmissions of a co-located (within one meter) transmitter of the same system, may monitor the portions of the time and spectrum windows in which they intend to receive over a period of at least 10 ms. The monitored time and spectrum window must total at least 50 % of the 10 ms frame interval and the monitored spectrum must be within the 1.25 MHz frequency channel(s) already occupied by that device or co-located co-operating devices. If the access criteria is met for the intended receive time and spectrum window under the above conditions, then transmission in the intended transmit window by the initiating device may commence.

Measurements are made in accordance with ANSI C63.17 sub-clause 8.4.

Attestation:

- [] Appropriate as it is co-located device, in which the monitoring system will be blocked from the transmissions of a co-located (Within one meter) transmitter of the same system. Please refer to attachment, 15.323(c)(11).pdf / RSS-213(b)(11).pdf, for details.
- [x] Not appropriate, as the system always monitor both the transmit and receive time/spectrum windows, it is not a co-located device.

4.24 Fair Access, FCC Rule 15.323(c)(12) / RSS-213 Clause 5.2(12):

The provisions of FCC Rule 15.323(c)(10) or (c)(11) / RSS-213 Clause 5.2(10) or (11) shall not be used to extend the range of spectrum occupied over space or time for the purpose of denying fair access to spectrum to other devices.

Attestation:

The manufacturer declares that the device does not use any mechanisms as provided by Part 15.323(c)(10) or (c)(11) / RSS-213 Clause 5.2(10) or (11) to extend the range of spectrum occupied over space or time for the purpose of denying fair access to spectrum to other devices.

Please refer to the declaration letter which is saved with filename: declaration.pdf.

INTERTEK TESTING SERVICES

**EXHIBIT 5
EQUIPMENT LIST**

INTERTEK TESTING SERVICES

5.0 Equipment List

1) Radiated Emissions Test

Equipment	BiConiLog Antenna	Double Ridged Guide Antenna	Broad-Band Horn Antenna
Registration No.	EW-3061	EW-0194	EW-1679
Manufacturer	EMCO	EMCO	SCHWARZBECK
Model No.	3412E	3115	BBHA9170
Calibration Date	Jul. 22, 2015	Jan. 29, 2015	Jun. 10, 2015
Calibration Due Date	Jul. 22, 2016	Jul. 29, 2016	Jun. 10, 2016

Equipment	EMI Test Receiver	Spectrum Analyzer
Registration No.	EW-3156	EW-2253
Manufacturer	R&S	R&S
Model No.	ESR26	FSP40
Calibration Date	Nov. 3, 2015	May. 27, 2015
Calibration Due Date	Nov. 3, 2016	May. 27, 2016

2) Conducted Emissions Test

Equipment	EMI Test Receiver	LISN	Pulse Limiter
Registration No.	EW-2500	EW-0192	EW-0698
Manufacturer	R&S	R&S	R&S
Model No.	ESCI	ESH3-Z5	ESH3-Z2
Calibration Date	Nov 6, 2015	Jul 18, 2015	Jul 14, 2015
Calibration Due Date	Nov 6, 2016	Jul 18, 2016	Jul 14, 2016

3) Conductive Measurement Test

Equipment	Coaxial directional coupler	Spectrum Analyzer	Digital Radiocommunication Tester for DECT
Registration No.	EW-2337	EW-3016	EW-1739
Manufacturer	MAGNA	R&S	ROHDESCHWARZ
Model No.	4222-16	FSP30	CMD60
Calibration Date	Nil*	Jun. 25, 2015	Aug. 10, 2015
Calibration Due Date	Nil*	Jun. 23, 2016	Aug. 10. 2016

Equipment	Vector Signal Generator	Temperature & Humidity Chamber	Digital Multimeter
Registration No.	EW-2411	EW-2134	EW-1020
Manufacturer	R&S	GIANT FORCE	FLUKE
Model No.	SMU200A	GTH-750-40-CP-SD	87-IV
Calibration Date	Aug. 10, 2015	Sep. 16, 2015	Jun. 22, 2015
Calibration Due Date	Aug. 10, 2016	Sep. 16. 2016	Jul. 22, 2016

END OF TEST REPORT