



SAR TEST REPORT

Test Report No. : 10645031H-R1

Applicant : MITSUMI ELECTRIC CO., LTD.
Type of Equipment : Wireless LAN + BT/BLE Module
Model No. : DWM-W314
FCC ID : EW4DWMW314
Test regulation : FCC47CFR 2.1093
Test Result : Complied
Reported SAR(1g) Value : **The highest reported SAR(1g)**
WLAN 11b/g/n Body : 0.234W/kg

1. This test report shall not be reproduced in full or partial, without the written approval of UL Japan, Inc.
2. The results in this report apply only to the sample tested.
3. This sample tested is in compliance with the limits of the above regulation.
4. The test results in this report are traceable to the national or international standards.
5. This test report must not be used by the customer to claim product certification, approval, or endorsement by NVLAP, NIST, or any agency of the Federal Government.
6. This test report covers SAR technical requirements. It does not cover administrative issues such as Manu or non-SAR test related Requirements. (if applicable)
7. This report is a revised version of 10645031H. 10645031H is replaced with this report.

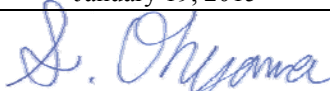
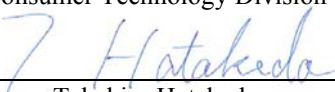
Date of test: January 19, 2015
Representative test engineer: 
Shuichi Ohyama
Engineer
Consumer Technology Division
Approved by : 
Takahiro Hatakeda
Leader
Consumer Technology Division

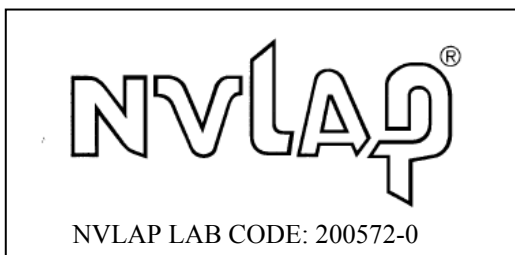

This laboratory is accredited by the NVLAP LAB CODE 200572-0, U.S.A. The tests reported herein have been performed in accordance with its terms of accreditation. *As for the range of Accreditation in NVLAP, you may refer to the WEB address, <http://www.ul.com/japan/jpn/pages/services/emc/about/mark1/index.jsp#nvlap>

CONTENTS	PAGE
SECTION 1: Customer information	4
SECTION 2: Equipment under test (E.U.T.)	4
2.1 Identification of E.U.T.....	4
2.2 Product description.....	4
SECTION 3: Test standard information	5
3.1 Test Specification.....	5
3.2 Procedure.....	5
3.3 Exposure limit.....	6
3.4 Test Location.....	6
SECTION 4: Test result	7
4.1 Stand-alone SAR result.....	7
SECTION 5: Description of the operating mode	8
5.1 Output power operating modes.....	8
5.2 Output power measurement results.....	9
5.3 SAR testing operating modes.....	11
5.4 Confirmation after SAR testing.....	12
SECTION 6 SAR test exclusion considerations	13
6.1 Standalone SAR test exclusion considerations.....	13
SECTION 7: Description of the Body setup	15
7.1 Test position for Body setup.....	15
SECTION 8: Test surrounding	16
8.1 Measurement uncertainty.....	16
SECTION 9: Measurement results	17
9.1 WLAN Body SAR (2.4G).....	17
SECTION 10 Test instruments	18
APPENDIX 1: SAR Measurement data	19
1. Evaluation procedure.....	19
2. Measurement data.....	20
APPENDIX 2: System Check	24
1. System check result Body 2450MHz.....	24
2. System Check Dipole (D2450V2,S/N:713).....	27
3. System check uncertainty.....	37
APPENDIX 3: System specifications	38
1. Configuration and peripherals.....	38
2. Specifications.....	39
3. Dosimetric E-Field Probe Calibration (EX3DV4, S/N: 3917).....	43
APPENDIX 4: Photographs of test setup	54
1. Information of host device.....	54
2. Antenna position.....	55
3. Photographs of setup.....	56

SECTION 1: Customer information

Company Name : MITSUMI ELECTRIC CO., LTD.
Address : 2-11-2, Tsurumaki, Tama-shi, Tokyo, 206-8567 JAPAN
Telephone Number : +81-42-310-5801
Facsimile Number : +81-42-310-5598
Contact Person : Yuki Takakura

SECTION 2: Equipment under test (E.U.T.)

2.1 Identification of E.U.T.

Type of Equipment : Wireless LAN + BT/BLE Module
Model No. : DWM-W314
Serial No. : No.1
Rating : DC 3.3V
Receipt Date of Sample : January 9, 2015
Country of Mass-production : Philippines
Condition of EUT : Engineering prototype
(Not for Sale: This sample is equivalent to mass-produced items.)
Modification of EUT : No Modification by the test lab

2.2 Product description

Clock frequency(ies) in the system : 32.768kHz, 26MHz
Antenna type : Monopole type chip antenna
Antenna gain : -9.2dBi
Antenna connector type : None (It exist the connector for only the tests of shipment.)
Operation temperature range : -20 to +70 deg.C

<Bluetooth part>

Equipment type : Transceiver
Frequency of operation : 2402-2480MHz
Bandwidth / channel spacing : 79MHz / 1MHz (BDR/EDR) & 2MHz (Low Energy)
Type of modulation : FHSS (GFSK, $\pi/4$ -DQPSK, 8DPSK), DSSS (GFSK)
ITU code : F1D, G1D

<Wireless LAN part>

Equipment type : Transceiver
Frequency of operation : 2412-2462MHz
Bandwidth / channel spacing : 20MHz / 5MHz
Type of modulation : DSSS, OFDM
ITU code : D1D, G1D

SECTION 3 : Test standard information

3.1 Test Specification

Title : **FCC47CFR 2.1093**
Radiofrequency radiation exposure evaluation: portable devices.
: **IEEE Std 1528-2003:**
IEEE Recommended Practice for Determining the Peak Spatial-Average Specific Absorption Rate (SAR) in the Human Head from Wireless Communications Devices.

: **Published RF exposure KDB procedures**

- KDB447498D01(v05r02)** Mobile and Portable Device RF Exposure Procedures and Equipment Authorization Policies
 - KDB447498D02(v02)** SAR Measurement Procedures for USB Dongle Transmitters
 - KDB648474D04(v01r02)** SAR Evaluation Considerations for Wireless Handsets
 - KDB941225D01(v02)** SAR Measurement Procedures for 3G Devices
 - KDB941225D02(v02r02)** 3GPP R6 HSPA and R7 HSPA+ SAR Guidance
 - KDB941225D03(v01)** Recommended SAR Test Reduction Procedures for GSM/GPRS/EDGE
 - KDB941225D04(v01)** Evaluating SAR for GSM/(E)GPRS Dual Transfer Mode
 - KDB941225D05(v02r03)** SAR for LTE Devices
 - KDB941225D06(v01r01)** SAR test procedures for devices incorporating SAR Evaluation Procedures for Portable Devices with Wireless Router Capabilities (Hot Spot SAR)
 - KDB941225D07(v01r01)*1** SAR Evaluation Procedures for UMPC Mini-Tablet Devices
 - KDB616217D04(v01r01)** SAR Evaluation Considerations for Laptop, Notebook, Netbook and Tablet Computers
 - KDB865664D01(v01r03)** SAR Measurement Requirements for 100MHz to 6 GHz
 - KDB248227D01(v01r02)** SAR Measurement Procedures for 802.11a//b/g Transmitters
- *1 Since host device was Digital Camera, KDB941225D07 was applied to this test report.

Reference

[1]SPEAG uncertainty document (AN 15-7/AN19-17) for DASY 5 System from SPEAG (Schmid & Partner Engineering AG).
[2] IEEE Std 1528-2013: IEEE Recommended Practice for Determining the Peak Spatial-Average Specific Absorption Rate (SAR) in the Human Head from Wireless Communications Devices: Measurement Techniques.
(The reference for Uncertainty in SAR correction for deviations in permittivity and conductivity, in clause E.3.2)

3.2 Procedure

Transmitter	WLAN
Test Procedure	Published RF exposure KDB procedures SAR
Category	FCC47CFR 2.1093
Note: UL Japan, Inc.'s SAR Work Procedures 13-EM-W0429 and 13-EM-W0430	

3.3 Exposure limit

(A) Limits for Occupational/Controlled Exposure (W/kg)

Spatial Average (averaged over the whole body)	Spatial Peak (averaged over any 1g of tissue)	Spatial Peak (hands/wrists/feet/ankles averaged over 10g)
0.4	8.0	20.0

(B) Limits for General population/Uncontrolled Exposure (W/kg)

Spatial Average (averaged over the whole body)	Spatial Peak (averaged over any 1g of tissue)	Spatial Peak (hands/wrists/feet/ankles averaged over 10g)
0.08	1.6	4.0

Occupational/Controlled Environments: are defined as locations where there is exposure that may be incurred by people who are aware of the potential for exposure, (i.e. as a result of employment or occupation).

General Population/Uncontrolled Environments: are defined as locations where there is the exposure of individuals who have no knowledge or control of their exposure.

<p style="text-align: center;">NOTE:GENERAL POPULATION/UNCONTROLLED EXPOSURE SPATIAL PEAK(averaged over any 1g of tissue) LIMIT 1.6 W/kg</p>

3.4 Test Location

*Shielded room for SAR testings

UL Japan, Inc. Ise EMC Lab. *NVLAP Lab. code: 200572-0

4383-326 Asama-cho, Ise-shi, Mie-ken 516-0021 JAPAN

Telephone : +81 596 24 8999 Facsimile : +81 596 24 8124

SECTION 4 : Test result

4.1 Stand-alone SAR result

Reported SAR

Measured SAR is scaled to the maximum tune-up tolerance limit by the following formulas.

Reported SAR= Maximum tune-up tolerance limit [mW] / Measured power [mW] · Measured SAR [W/kg]

Maximum tune-up tolerance limit is by the specification from a customer.

Mode	Frequency	Measured power [mW]*1	Maximum tune-up tolerance limit [mW]	Measured SAR [W/kg]	Reported SAR [W/kg]
WLAN 11g	2412MHz	24.10	28.18	0.200	0.234
WLAN 11b	2412MHz	22.44	28.18	0.181	0.227

Note

*1 The sample used by the SAR test is within the tune-up tolerance but not more than 2 dB lower than the maximum tune-up tolerance limit. That is, measured power is included the tune-up tolerance range.

WLAN / BT Maximum tune-up tolerance limit

Mode	Maximum tune-up tolerance limit [dBm]	Maximum tune-up tolerance limit [mW]
WLAN 11b	14.5	28.18
WLAN 11g	14.5	28.18
WLAN 11n (2.4G)	14.5	28.18
BT EDR	5.0	3.16
BT BDR LE	4.0	2.51

SECTION 5 : Description of the operating mode

5.1 Output power operating modes

Mode	Frequency Band	Test Frequency	Modulation
IEEE802.11b	2412-2462MHz	2412MHz (1ch) 2437MHz(6ch) 2462MHz(11ch)	DSSS (DBPSK.DQPSK.CCK)
IEEE802.11g IEEE802.11n20 (2.4G)	2412-2462MHz	2412MHz (1ch) 2437MHz(6ch) 2462MHz(11ch)	OFDM (BPSK.QPSK.16QAM,64QAM)
WLAN			
*Power of the EUT was set by the software as follows; Software / version: RF_TEST / Ver.01 Power setting: 12dBm *The above setting is the worst case. Any conditions under the normal use do not exceed the condition of setting. In addition, end users cannot change the settings of the output power of the product.			

5.2 Output power measurement results

Output power measurement for WLAN

1) WLAN (11b/g/n (2.4G))

[IEEE802.11b] Rate Check

Rate [Mbps]	Freq. [MHz]	P/M Reading [dBm] AVG	Cable Loss [dB]	Atten. [dB]	Result	
					[dBm] AVG	[mW] AVG
1.0	2437	2.19	0.67	10.06	12.92	19.59
2.0	2437	2.05	0.67	10.06	12.78	18.97
5.5	2437	2.13	0.67	10.06	12.86	19.32
11.0	2437	2.09	0.67	10.06	12.82	19.14

:Worst data rate

IEEE802.11b 1Mbps

Ch	Frequency [MHz]	Reading [dBm] AVG	Cable Loss [dB]	Atten. [dB]	Result	
					[dBm] AVG	[mW] AVG
1	2412	2.78	0.67	10.06	13.51	22.44
6	2437	2.19	0.67	10.06	12.92	19.59
11	2462	2.04	0.67	10.06	12.77	18.92

:SAR test channel

[IEEE802.11g] Rate Check

Rate [Mbps]	Frequency [MHz]	Reading [dBm] AVG	Cable Loss [dB]	Atten. [dB]	Result	
					[dBm] AVG	[mW] AVG
6	2437	2.70	0.67	10.06	13.43	22.03
9	2437	2.66	0.67	10.06	13.39	21.83
12	2437	2.57	0.67	10.06	13.30	21.38
18	2437	2.64	0.67	10.06	13.37	21.73
24	2437	2.45	0.67	10.06	13.18	20.80
36	2437	2.56	0.67	10.06	13.29	21.33
48	2437	2.64	0.67	10.06	13.37	21.73
54	2437	2.63	0.67	10.06	13.36	21.68

:Worst data rate

IEEE802.11g 6Mbps

Ch	Frequency [MHz]	Reading [dBm] AVG	Cable Loss [dB]	Atten. [dB]	Result	
					[dBm] AVG	[mW] AVG
1	2412	3.09	0.67	10.06	13.82	24.10
6	2437	2.70	0.67	10.06	13.43	22.03
11	2462	2.52	0.67	10.06	13.25	21.13

:SAR test channel

WLAN (11b/g/n (2.4G)) continued

[IEEE802.11n20] Rate Check

Rate [MCS]	Frequency [MHz]	Reading [dBm] AVG	Cable Loss [dB]	Atten. [dB]	Result	
					[dBm] AVG	[mW] AVG
0	2437	2.74	0.67	10.06	13.47	22.23
1	2437	2.71	0.67	10.06	13.44	22.08
2	2437	2.65	0.67	10.06	13.38	21.78
3	2437	2.66	0.67	10.06	13.39	21.83
4	2437	2.70	0.67	10.06	13.43	22.03
5	2437	2.40	0.67	10.06	13.13	20.56
6	2437	2.37	0.67	10.06	13.10	20.42
7	2437	2.36	0.67	10.06	13.09	20.37

:Worst data rate

IEEE802.11n-20 MCS0

Ch	Frequency [MHz]	Reading [dBm] AVG	Cable Loss [dB]	Atten. [dB]	Result	
					[dBm] AVG	[mW] AVG
1	2412	3.29	0.67	10.06	14.02	25.23
6	2437	2.74	0.67	10.06	13.47	22.23
11	2462	2.42	0.67	10.06	13.15	20.65

:SAR test channel

Output power(time average) of original test report : 10499187S-G

Mode	Frequency [MHz]	P/M Reading [dBm] AVG	Cable Loss [dB]	Atten. [dB]	Result [dBm] AVG
11b 1Mbps	2412	11.18	2.16	0.00	13.34
11g 54Mbps	2412	11.82	2.16	0.00	13.98
11n20 MCS5	2412	11.86	2.16	0.00	14.02

Output power(time average) of this report

Mode	Frequency [MHz]	P/M Reading [dBm] AVG	Cable Loss [dB]	Atten. [dB]	Result [dBm] AVG	Deviation [dB]
11b 1Mbps	2412	2.78	0.67	10.06	13.51	0.17
11g 6Mbps	2412	3.09	0.67	10.06	13.82	-0.16
11n20 MCS0	2412	3.29	0.67	10.06	14.02	0.00

Sample Calculation:

Result = Reading + Cable Loss + Attenuator

5.3 SAR testing operating modes

The operating mode for SAR testing was decided by the output power

1) SAR measurement for WLAN

Decision of SAR test channel

The operating mode for SAR testing was decided by the output power

Mode	GHz	Channel	"Default Test Channel"				
			FCC 15.247		UNII		
			802.11b	802.11g			
802.11 b/g/n20	2.412	1	√	Δ			
	2.437	6	√	Δ			
	2.462	11	√	Δ			
802.11a/n20	UNII	5.18	36			√	
		5.20	40				*
		5.22	44				*
		5.24	48			√	
		5.26	52			√	
		5.28	56				*
		5.30	60				*
		5.32	64			√	
		5.50	100				*
		5.52	104			√	
	5.54	108				*	
	5.56	112				*	
	5.58	116			√		
	5.60	120				*	
	5.62	124			√		
	5.64	128				*	
	5.66	132				*	
	5.68	136			√		
	5.70	140				*	
	FCC 15.247	UNII or FCC 15.247	5.745	149	√		√
5.765			153		*		*
5.785			157	√			*
5.805			161		*	√	
FCC 15.247		5.825	165	√			

√ = "default test channels"

* = Possible 802.11a channels with maximum average output > the "default test channels"

Δ = Possible 802.11g channels with maximum average output $\frac{1}{4}$ dB \geq the "default test channels"

= when output power is reduced for channel 1 and/or 11 to meet restricted band requirements the highest output channels closest to each of these channels should be tested

Mode	Test Frequency	Modulation	Crest factor	Note
IEEE802.11b	2412MHz(1ch)	DBPSK(1Mbps)	1	*1
IEEE802.11g	2412MHz(1ch)	BPSK(6Mbps)	1	*1
IEEE802.11n20 (2.4G)	2412MHz(1ch)	BPSK(MCS0)	1	*1

WLAN

*Power of the EUT was set by the software as follows;

Software / version: RF_TEST / Ver.01

Power setting: 12dBm

*The above setting is the worst case. Any conditions under the normal use do not exceed the condition of setting.

In addition, end users cannot change the settings of the output power of the product.

*1 The other channel was not required since maximum average output power channel SAR value is less than 0.8W/kg.

5.4 Confirmation after SAR testing

It was checked that the power drift [W] is within +/-5%.The verification of power drift during the SAR test is that DASY5 system calculates the power drift by measuring the e-filed at the same location at beginning and the end of the scan measurement for each test position.

DASY5 system calculation Power drift value[dB] =20log(Ea)/(Eb)

Before SAR testing : Eb[V/m]

After SAR testing : Ea[V/m]

Limit of power drift[W] =+/-5%

X[dB]=10log[P]=10log(1.05/1)=10log(1.05)-10log(1)=0.212dB

from E-filed relations with power.

$p = E^2 / \eta = E^2 /$

Therefore, The correlation of power and the E-filed

$X_{dB} = 10 \log(P) = 10 \log(E)^2 = 20 \log(E)$

Therefore,

The calculated power drift of DASY5 System must be the less than +/-0.212dB.

SECTION 6 SAR test exclusion considerations

6.1 Standalone SAR test exclusion considerations

WLAN and Bluetooth do not transmit simultaneously.

WLAN2.4GHz / Bluetooth

Based on KDB941225D07, UMPC mini-tablet devices must be tested for 1-g SAR on all surfaces and side edges with a transmitting antenna located at ≤ 25 mm from that surface or edge, at 5 mm separation from a flat phantom, for the data modes, wireless technologies and frequency bands supported by the device to determine SAR compliance.

No.	Position	WLAN / Bluetooth		
		Test required	Antenna	Separation of antenna to EUT's surfaces and edges [mm]
1	Front	<input checked="" type="checkbox"/>	Internal	2.60
2	Rear	<input checked="" type="checkbox"/>	Internal	11.24
3	Top	<input type="checkbox"/>	Internal	32.80
4	Bottom	<input type="checkbox"/>	Internal	28.00
5	Right	<input type="checkbox"/>	Internal	75.06
6	Left	<input type="checkbox"/>	Internal	49.44

Based on KDB 447498 D01

The 1-g and 10-g SAR test exclusion thresholds for 100 MHz to 6 GHz at test separation distances ≤ 50 mm are determined by:

$$[(\text{max. power of channel, including tune-up tolerance, mW}) / (\text{min. test separation distance, mm})] \cdot [\sqrt{f(\text{GHz})}] \leq 3.0$$

for 1-g SAR and ≤ 7.5 for 10-g extremity SAR, where

$f(\text{GHz})$ is the RF channel transmit frequency in GHz

Power and distance are rounded to the nearest mW and mm before calculation

The result is rounded to one decimal place for comparison

The test exclusions are applicable only when the minimum test separation distance is ≤ 50 mm and for transmission frequencies between 100 MHz and 6 GHz. When the minimum test separation distance is < 5 mm, a distance of 5 mm is applied to determine SAR test exclusion.

WLAN2.4GHz

Standalone SAR tested	Position	Mode	Upper frequency of band *1	Maximum tune-up tolerance limit *4	Min distance *2	Calculation of exclusion *3
<input checked="" type="checkbox"/>	Front	WLAN 11b	2462 [MHz]	14.5 [dBm] 28.18 [mW] 28 [mW]*5	5 [mm]	8.8
<input checked="" type="checkbox"/>	Rear	WLAN 11b	2462 [MHz]	14.5 [dBm] 28.18 [mW] 28 [mW]*5	5 [mm]	8.8

BT (EDR)

Standalone SAR tested	Position	Mode	Upper frequency of band *1	Maximum tune-up tolerance limit *4	Min distance *2	Calculation of exclusion *3
<input type="checkbox"/>	Front	BT	2480 [MHz]	5 [dBm] 3.16 [mW] 3 [mW]*5	5 [mm]	0.9
<input type="checkbox"/>	Rear	BT	2480 [MHz]	5 [dBm] 3.16 [mW] 3 [mW]*5	5 [mm]	0.9

UL Japan, Inc.

Ise EMC Lab.

4383-326 Asama-cho, Ise-shi, Mie-ken 516-0021 JAPAN

Telephone: +81 596 24 8999

Facsimile: +81 596 24 8124

BT (BDR/LE)

Standalone SAR tested	Position	Mode	Upper frequency of band *1	Maximum tune-up tolerance limit *4	Min distance *2	Calculation of exclusion *3
<input type="checkbox"/>	Front	BT	2480 [MHz]	4 [dBm] 2.51 [mW] 3 [mW]*5	5 [mm]	0.9
<input type="checkbox"/>	Rear	BT	2480 [MHz]	4 [dBm] 2.51 [mW] 3 [mW]*5	5 [mm]	0.9

*1 The upper frequency of the frequency band was used in order to calculate standalone SAR test exclusion considerations.

*2 When the minimum test separation distance is < 5 mm, a distance of 5 mm is applied to determine SAR test exclusion. Refer to Appendix 4.

*3 $[(\text{max. power of channel, including tune-up tolerance, mW}) / (\text{min. test separation distance, mm})] \cdot [\sqrt{f(\text{GHz})}] \leq 3.0$

If it is Calculation of exclusion ≤ 3.0 standalone SAR test is excluded.

*4 Maximum tune-up tolerance limit is by the specification from a customer.

*5 Maximum tune-up tolerance limit(mW) is rounded to one decimal place.

SECTION 7: Description of the Body setup

7.1 Test position for Body setup

i) Procedure for SAR testing

-The tested procedure was performed according to the KDB 941225 D07 (SAR Evaluation Procedures for UMPC Mini-Tablet Devices).

ii) Test mode

WLAN 2.4G	Data transmission mode (11b/g/n-20)
-----------	-------------------------------------

iii) Test position

No.	Position	WLAN		
		Tested	Antenna	Test separation distance (Separation of a flat phantom to EUT's surfaces and edges)* 1
1	Front	<input checked="" type="checkbox"/>	Internal	5mm
2	Rear	<input checked="" type="checkbox"/>	Internal	5mm
3	Top	<input type="checkbox"/>	Internal	-
4	Bottom	<input type="checkbox"/>	Internal	-
5	Right	<input type="checkbox"/>	Internal	-
6	Left	<input type="checkbox"/>	Internal	-

*1 Test separation distance is separation of a flat phantom to EUT's surfaces and edges.
Based on KDB941225D07, test separation distance is 5mm.

SECTION 8 : Test surrounding

8.1 Measurement uncertainty

This measurement uncertainty budget is suggested by IEEE Std 1528(2013)[2] and determined by Schmid & Partner Engineering AG (DASY5 Uncertainty Budget[1]). Per KDB 865664 D01 SAR Measurement 100 MHz to 6 GHz v01r01 Section 2.8.1., when the highest measured SAR(1g) within a frequency band is < 1.5W/kg, the extensive SAR measurement uncertainty analysis described in IEEE Std.1528 (2013) is not required in SAR reports submitted for equipment approval.

<0.3 – 3GHz range Body>

Error Description	Uncertai value ±	Probability distribution	divisor	(ci) lg	Standard (1g)	vi or veff
Measurement System						
Probe calibration	± 6.00	Normal	1	1	± 6.00	∞
Axial isotropy of the probe	± 4.7	Rectangular	√3	0.7	± 1.9	∞
Spherical isotropy of the probe	± 9.6	Rectangular	√3	0.7	± 3.9	∞
Boundary effects	± 2.0	Rectangular	√3	1	± 1.2	∞
Probe linearity	± 4.7	Rectangular	√3	1	± 2.7	∞
Detection limit	± 1.0	Rectangular	√3	1	± 0.6	∞
Modulation response	± 2.4	Rectangular	√3	1	± 1.4	∞
Readout electronics	± 0.3	Normal	1	1	± 0.3	∞
Response time	± 0.8	Rectangular	√3	1	± 0.5	∞
Integration time	± 2.6	Rectangular	√3	1	± 1.5	∞
RF ambient Noise	± 3.0	Rectangular	√3	1	± 1.7	∞
RF ambient Reflections	± 3.0	Rectangular	√3	1	± 1.7	∞
Probe Positioner	± 0.4	Rectangular	√3	1	± 0.2	∞
Probe positioning	± 2.9	Rectangular	√3	1	± 1.7	∞
MaxSAR Eval.	± 2.0	Rectangular	√3	1	± 1.2	∞
Test Sample Related						
Device positioning	± 2.9	Normal	1	1	± 2.9	1
Device holder uncertainty	± 3.6	Normal	1	1	± 3.6	3
Power drift	± 5.0	Rectangular	√3	1	± 2.9	∞
Power Scaling	+ 0.0	Rectangular	√3	1	± 0.0	∞
Phantom and Setup						
Phantom uncertainty	± 6.1	Rectangular	√3	1	± 3.5	∞
Liquid conductivity (target)	± 5.0	Rectangular	√3	0.78	± 2.3	∞
Liquid conductivity (meas.)	+ 0.7	Rectangular	1	0.78	+ 0.5	∞
Liquid permittivity (target)	± 5.0	Rectangular	√3	0.23	± 0.7	∞
Liquid permittivity (meas.)	- 0.5	Rectangular	1	0.23	- 0.1	∞
Liquid conductivity - temp.unc (below 2deg.C.)	± 5.2	Rectangular	√3	0.78	± 2.3	∞
Liquid permittivity - temp.unc (below 2deg.C.)	± 0.8	Rectangular	√3	0.23	± 0.1	∞
Combined Standard Uncertainty					± 11.403	
Expanded Uncertainty (k=2)					± 22.8	

*. Table of uncertainties are listed for ISO/IEC 17025.

UL Japan, Inc.

Ise EMC Lab.

4383-326 Asama-cho, Ise-shi, Mie-ken 516-0021 JAPAN

Telephone: +81 596 24 8999

Facsimile: +81 596 24 8124

SECTION 9 : Measurement results

9.1 WLAN Body SAR (2.4G)

(1)Method of measurement

- Step1. The searching for the worst position
The test was performed with 11g mode.
Step2. The changing to 11b / 11n-20 mode
The test was performed with the worst position of Step1.

Note:

1) According to KDB 447498 D01 General RF Exposure Guidance v05, testing of other required channels within the operating mode of a frequency band is not required when the reported 1-g or 10-g SAR for the mid-band or highest output power channel is

- ≤ 0.8 W/kg or 2.0 W/kg, for 1-g or 10-g respectively, when the transmission band is ≤ 100 MHz
- ≤ 0.6 W/kg or 1.5 W/kg, for 1-g or 10-g respectively, when the transmission band is between 100 MHz and 200 MHz
- ≤ 0.4 W/kg or 1.0 W/kg, for 1-g or 10-g respectively, when the transmission band is ≥ 200 MHz

2) Repeated measurement is not required when the original highest measured SAR is < 0.80 W/kg.

When the original highest measured SAR is ≥ 0.80 W/kg, repeat that measurement once.
Perform a second repeated measurement only if the ratio of largest to smallest SAR for the original and first repeated measurements is > 1.20 or when the original or repeated measurement is ≥ 1.45 W/kg (~ 10% from the 1-g SAR limit).

(2)Simulated Tissue Liquid Parameter confirmation

The dielectric parameters were checked prior to assessment using the R140 Reflectometer and DAKS-3.5 probe.
The dielectric parameters measurement is reported in each correspondent section.

DIELECTRIC PARAMETERS MEASUREMENT RESULTS											
Date	Ambient Temp. [deg.c]	Relative Humidity [%]	Liquid type	Liquid Temp. [deg.c]	Measured Frequency [MHz]	Parameters	Target Value	Measured	Deviation [%]	Limit [%]	Remark
-	-	-	-	-	2000	εr	53.3	-	-	-	*1
						σ [mho/m]	1.52	-	-	-	
19-Jan	24	36	MSL 2450	23.5	2412	εr	52.8	52.5	-0.5	+/-5	*2
						σ [mho/m]	1.91	1.92	0.7	+/-5	
-	-	-	-	-	2450	εr	52.7	-	-	-	*1
						σ [mho/m]	1.95	-	-	-	

εr: Relative Permittivity / σ : Conductivity

*1 The Target value is a parameter defined in KDB 865664D01.

*2 The dielectric parameters should be linearly interpolated between the closest pair of target frequencies to determine the applicable dielectric parameters corresponding to the device test frequency.

(3)Result of Body SAR

BODY SAR MEASUREMENT RESULTS												
Frequency		Modulation	Measured power		Maximum tune-up tolerance limit		Phantom Section	EUT Set-up Conditions		Measured SAR(1g) [W/kg]	Scaled factor	Reported SAR(1g) *1 [W/kg]
Channel	[MHz]		[dBm]	[mW]	[dBm]	[mW]		Position	Separation [mm]			
Step.1 Position search												
1	2412	11g 6Mbps	13.82	24.10	14.50	28.18	Flat	Front	5	0.200	1.169	0.234
1	2412	11g 6Mbps	13.82	24.10	14.50	28.18	Flat	Rear	5	0.000	1.169	0.000
Step.2 Mode change												
1	2412	11b 1Mbps	13.51	22.44	14.50	28.18	Flat	Front	5	0.181	1.256	0.227
1	2412	11n20 MCS0	14.02	25.23	14.50	28.18	Flat	Front	5	0.179	1.117	0.200

*1 Reported SAR= Maximum tune-up tolerance limit [mW] / Measured power [mW] · Measured SAR [W/kg]

UL Japan, Inc.

Ise EMC Lab.

4383-326 Asama-cho, Ise-shi, Mie-ken 516-0021 JAPAN

Telephone: +81 596 24 8999

Facsimile: +81 596 24 8124

SECTION 10 Test instruments

Control No.	Instrument	Manufacturer	Model No	Serial No	Test Item	Calibration Date * Interval(month)
MVNA-01	Vector Network Analyzer	Schmid&Partner Engineering AG	PLANAR R140	0030913	SAR	2014/01/09 * 12
MOS-37	Digital thermometer	LKM electronic	DTM3000	-	SAR	2014/07/06 * 12
MDPK-03	Dielectric assessment kit	Schmid&Partner Engineering AG	DAK-3.5 Probe	0008	SAR	2014/03/04 * 12
COTS-MSAR-04	Dielectric assessment kit	Schmid&Partner Engineering AG	DAK		SAR	-
MPM-15	Power Meter	Agilent	N1914A	MY53060017	SAR	2014/06/20 * 12
MPSE-20	Power sensor	Agilent	N8482H	MY53050001	SAR	2014/06/20 * 12
MPSE-21	Power sensor	Agilent	N8482H	MY52460010	SAR	2014/07/02 * 12
MHDC-22	Directional Coupler	Agilent	87300B	14893A	SAR	Pre Check
MRFA-24	Pre Amplifier	R&K	R&K CGA020M602-2633R	B30550	SAR	2014/06/19 * 12
MSG-13	Signal Generator	Rohde & Schwarz	SMA 100A	103764	SAR	2014/06/19 * 12
MDA-07	Dipole Antenna	Schmid&Partner Engineering AG	D2450V2	713	SAR	2013/09/10 * 24
MDAE-02	Data Acquisition Electronics	Schmid&Partner Engineering AG	DAE4	1369	SAR	2014/05/14 * 12
MPB-08	Dosimetric E-Field Probe	Schmid&Partner Engineering AG	EX3DV4	3917	SAR	2014/05/14 * 12
MPF-05	2mm Oval Flat Phantom	Schmid&Partner Engineering AG	QDOVA001BB	1095	SAR	2015/01/14 * 12
MDH-04	Device holder	Schmid&Partner Engineering AG	Mounting device for transmitter	-	SAR	Pre Check
MOS-30	Thermo-Hygrometer	Custom	CTH-201	3001	SAR	2014/07/06 * 12
MOS-35	Digital thermometer	HANNA	Checktemp 4	-	SAR	2014/07/06 * 12
COTS-MSAR-03	Dasy5	Schmid&Partner Engineering AG	DASY5	-	SAR	-
MRBT-03	SAR robot	Schmid&Partner Engineering AG	TX60 Lspeag	F13/5PP1D1/A/01	SAR	2014/06/24 * 12
MSL2450				Daily check Target value ± 5%		
SAR room				Daily check Ambient Noise<0.012W/kg		

The expiration date of the calibration is the end of the expired month.

All equipment is calibrated with valid calibrations. Each measurement data is traceable to the national or international standards.

As for some calibrations performed after the tested dates, those test equipment have been controlled by means of an unbroken chains of calibrations.

UL Japan, Inc.

Ise EMC Lab.

4383-326 Asama-cho, Ise-shi, Mie-ken 516-0021 JAPAN

Telephone: +81 596 24 8999

Facsimile: +81 596 24 8124

APPENDIX 1 : SAR Measurement data

1. Evaluation procedure

The evaluation was performed with the following procedure:

Step 1: Measurement of the E-field at a fixed location above the ear point or central position of flat phantom was used as a reference value for assessing the power drop.

Step 2: The SAR distribution at the exposed side of head or body position was measured at a distance of each device from the inner surface of the shell. The area covered the entire dimension of the antenna of EUT and the horizontal grid spacing was 15 mm x 15 mm, 12 mm x 12 mm or 10mm x 10mm. Based on these data, the area of the maximum absorption was determined by spline interpolation.

Step 3: Around this point found in the Step 2 (area scan), a volume of 30mm x 30mm x 30mm or more was assessed by measuring 7 x 7 x 7 points at least for below 3GHz and a volume of 28 mm x 28mm x 22.5mm or more was assessed by measuring 8 x 8 x 6(ratio step method (*1)) points at least for 5GHz band.

And for any secondary peaks found in the Step2 which are within 2dB of maximum peak and not with this Step3 (Zoom scan) is repeated. On the basis of this data set, the spatial peak SAR value was evaluated under the following procedure:

(1). The data at the surface were extrapolated, since the center of the dipoles is 1mm(EX3DV4) away from the tip of the probe and the distance between the surface and the lowest measuring point is 1.3 mm. The extrapolation was based on a least square algorithm [4]. A polynomial of the fourth order was calculated through the points in z-axes. This polynomial was then used to evaluate the points between the surface and the probe tip.

(2). The maximum interpolated value was searched with a straightforward algorithm. Around this maximum the SAR values averaged over the spatial volumes (1 g or 10 g) were computed by the 3D-Spline interpolation algorithm. The 3D-Spline is composed of three one-dimensional splines with the "Not a knot"-condition (in x, y and z-directions) [4], [5]. The volume was integrated with the trapezoidal-algorithm. One thousand points (10 x 10 x 10) were interpolated to calculate the average.

(3). All neighboring volumes were evaluated until no neighboring volume with a higher average value was found.

Step 4: Re-measurement of the E-field at the same location as in Step 1.

***1. Ratio step method parameters used;**

**The first measurement point: 2mm from the phantom surface, the initial grid separation: 2mm, subsequent graded grid ratio: 1.5
These parameters comply with the requirement of the KDB 865664D01.**

2. Measurement data

WLAN 11g 6Mbps Front 5mm 2412MHz

Communication System: UID 0, WLAN 2.4G 11b/g/n (0); Communication System Band: WLAN 2.4G 11b/g/n;
Frequency: 2412 MHz; Duty Cycle: 1:1

Medium parameters used: $f = 2412$ MHz; $\sigma = 1.924$ S/m; $\epsilon_r = 52.502$; $\rho = 1000$ kg/m³

Phantom section: Flat Section

Measurement Standard: DASY5 (IEEE/IEC/ANSI C63.19-2007)

DASY Configuration:

Probe: EX3DV4 - SN3917; ConvF(7.2, 7.2, 7.2); Calibrated: 2014/05/14;

Sensor-Surface: 2mm (Mechanical Surface Detection)

Electronics: DAE4 Sn1369; Calibrated: 2014/05/14

Phantom: ELI v4.0 (20deg probe tilt); Type: QDOVA001BB; Serial: TP:1095

DASY52 52.8.8(1222); SEMCAD X 14.6.10(7331)

Area Scan (61x131x1): Interpolated grid: dx=1.200 mm, dy=1.200 mm

Maximum value of SAR (interpolated) = 0.539 W/kg

Zoom Scan (7x7x7)/Cube 0: Measurement grid: dx=5mm, dy=5mm, dz=5mm

Reference Value = 11.76 V/m; Power Drift = 0.13 dB

Peak SAR (extrapolated) = 0.576 W/kg

SAR(1 g) = 0.200 W/kg; SAR(10 g) = 0.068 W/kg

Maximum value of SAR (measured) = 0.379 W/kg

Date: 2015/01/19

Ambient Temp. : 24.0 degree.C. Liquid Temp.; 23.5 degree.C.

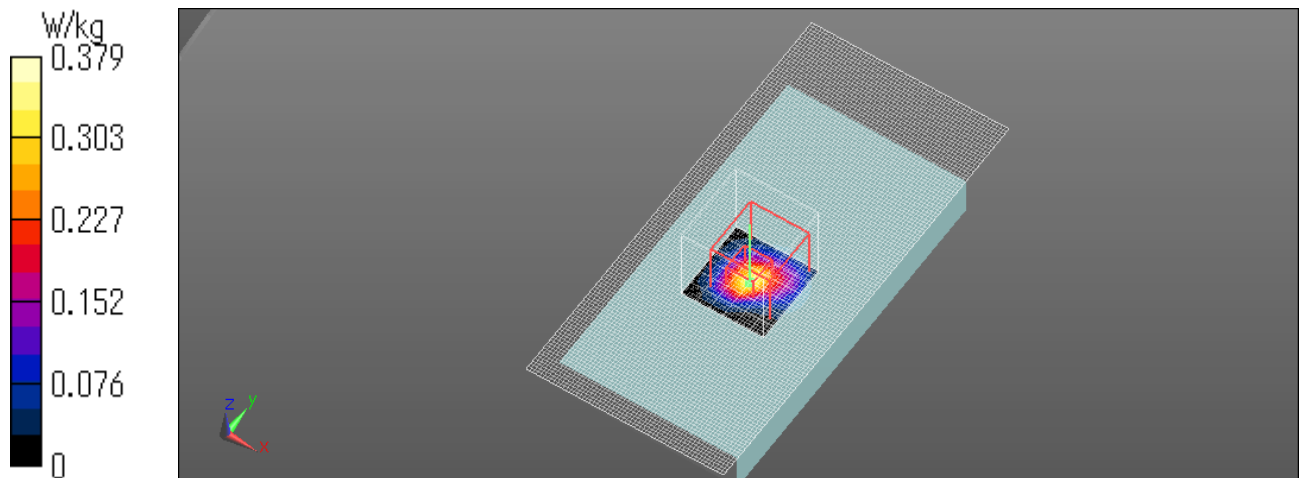

WLAN 11g 6Mbps Rear 5mm 2412MHz

Communication System: UID 0, WLAN 2.4G 11b/g/n (0); Communication System Band: WLAN 2.4G 11b/g/n;
Frequency: 2412 MHz; Duty Cycle: 1:1

Medium parameters used: $f = 2412$ MHz; $\sigma = 1.924$ S/m; $\epsilon_r = 52.502$; $\rho = 1000$ kg/m³

Phantom section: Flat Section

Measurement Standard: DASY5 (IEEE/IEC/ANSI C63.19-2007)

DASY Configuration:

Probe: EX3DV4 - SN3917; ConvF(7.2, 7.2, 7.2); Calibrated: 2014/05/14;

Sensor-Surface: 2mm (Mechanical Surface Detection)

Electronics: DAE4 Sn1369; Calibrated: 2014/05/14

Phantom: ELI v4.0 (20deg probe tilt); Type: QDOVA001BB; Serial: TP:1095

DASY52 52.8.8(1222); SEMCAD X 14.6.10(7331)

Area Scan (61x131x1): Interpolated grid: dx=1.200 mm, dy=1.200 mm
Maximum value of SAR (interpolated) = 0 W/kg

Date: 2015/01/19

Ambient Temp. : 24.0 degree.C. Liquid Temp.; 23.5 degree.C.

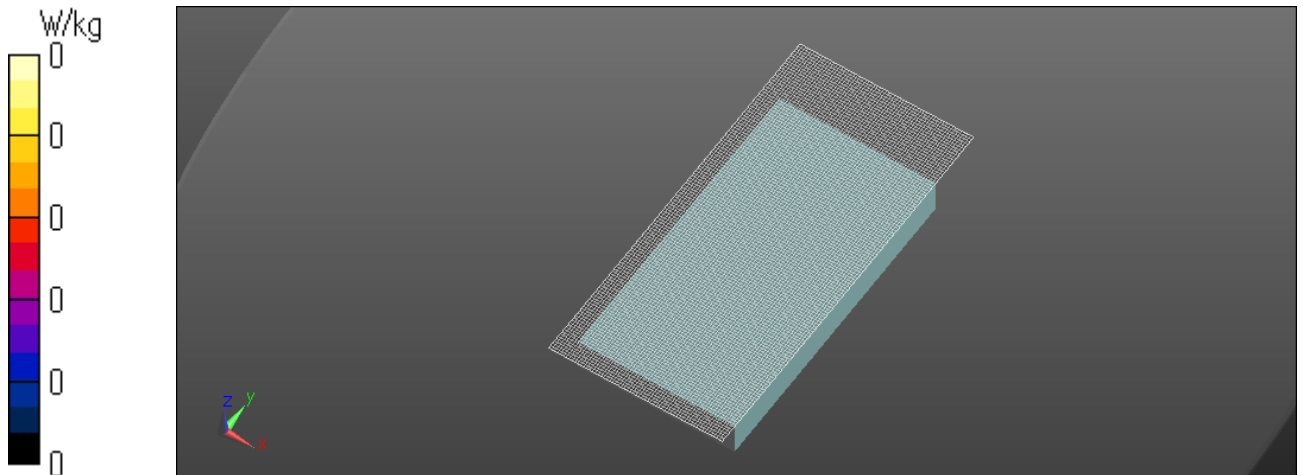

WLAN 11b 1Mbps Front 5mm 2412MHz

Communication System: UID 0, WLAN 2.4G 11b/g/n (0); Communication System Band: WLAN 2.4G 11b/g/n;

Frequency: 2412 MHz; Duty Cycle: 1:1

Medium parameters used: $f = 2412$ MHz; $\sigma = 1.924$ S/m; $\epsilon_r = 52.502$; $\rho = 1000$ kg/m³

Phantom section: Flat Section

Measurement Standard: DASY5 (IEEE/IEC/ANSI C63.19-2007)

DASY Configuration:

Probe: EX3DV4 - SN3917; ConvF(7.2, 7.2, 7.2); Calibrated: 2014/05/14;

Sensor-Surface: 2mm (Mechanical Surface Detection)

Electronics: DAE4 Sn1369; Calibrated: 2014/05/14

Phantom: ELI v4.0 (20deg probe tilt); Type: QDOVA001BB; Serial: TP:1095

DASY52 52.8.8(1222); SEMCAD X 14.6.10(7331)

Area Scan (61x131x1): Interpolated grid: dx=1.200 mm, dy=1.200 mm

Maximum value of SAR (interpolated) = 0.405 W/kg

Zoom Scan (7x7x7)/Cube 0: Measurement grid: dx=5mm, dy=5mm, dz=5mm

Reference Value = 11.19 V/m; Power Drift = -0.10 dB

Peak SAR (extrapolated) = 0.532 W/kg

SAR(1 g) = 0.181 W/kg; SAR(10 g) = 0.061 W/kg

Maximum value of SAR (measured) = 0.340 W/kg

Date: 2015/01/19

Ambient Temp. : 24.0 degree.C. Liquid Temp.; 23.5 degree.C.

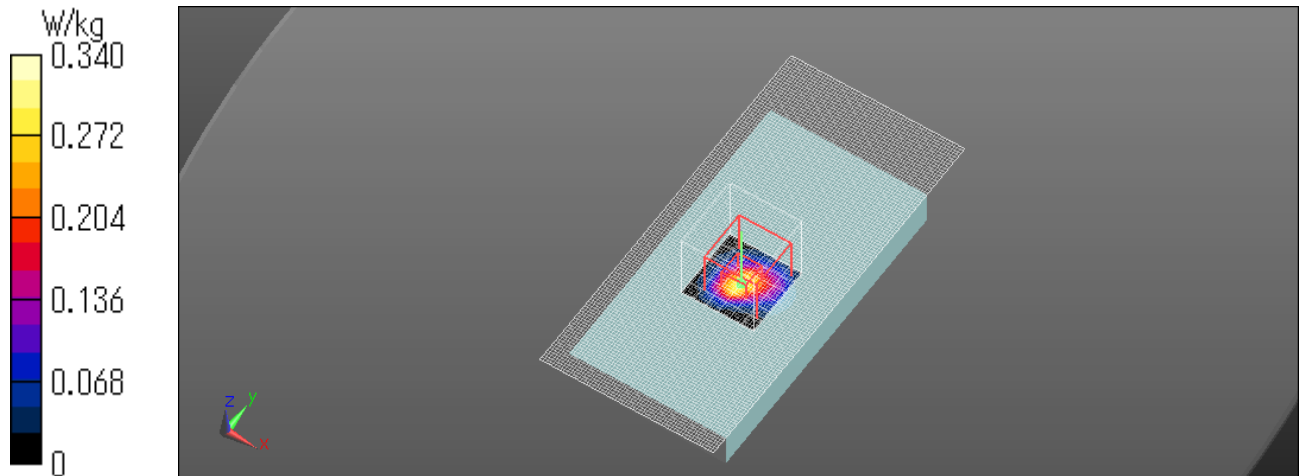

WLAN 11n20 MCS0 Front 5mm 2412MHz

Communication System: UID 0, WLAN 2.4G 11b/g/n (0); Communication System Band: WLAN 2.4G 11b/g/n;
Frequency: 2412 MHz; Duty Cycle: 1:1

Medium parameters used: $f = 2412$ MHz; $\sigma = 1.924$ S/m; $\epsilon_r = 52.502$; $\rho = 1000$ kg/m³

Phantom section: Flat Section

Measurement Standard: DASY5 (IEEE/IEC/ANSI C63.19-2007)

DASY Configuration:

Probe: EX3DV4 - SN3917; ConvF(7.2, 7.2, 7.2); Calibrated: 2014/05/14;

Sensor-Surface: 2mm (Mechanical Surface Detection)

Electronics: DAE4 Sn1369; Calibrated: 2014/05/14

Phantom: ELI v4.0 (20deg probe tilt); Type: QDOVA001BB; Serial: TP:1095

DASY52 52.8.8(1222); SEMCAD X 14.6.10(7331)

Area Scan (61x131x1): Interpolated grid: dx=1.200 mm, dy=1.200 mm
Maximum value of SAR (interpolated) = 0.534 W/kg

Zoom Scan (7x7x7)/Cube 0: Measurement grid: dx=5mm, dy=5mm, dz=5mm

Reference Value = 10.84 V/m; Power Drift = 0.02 dB

Peak SAR (extrapolated) = 0.512 W/kg

SAR(1 g) = 0.179 W/kg; SAR(10 g) = 0.061 W/kg

Maximum value of SAR (measured) = 0.320 W/kg

Date: 2015/01/19

Ambient Temp. : 24.0 degree.C. Liquid Temp.; 23.5 degree.C.

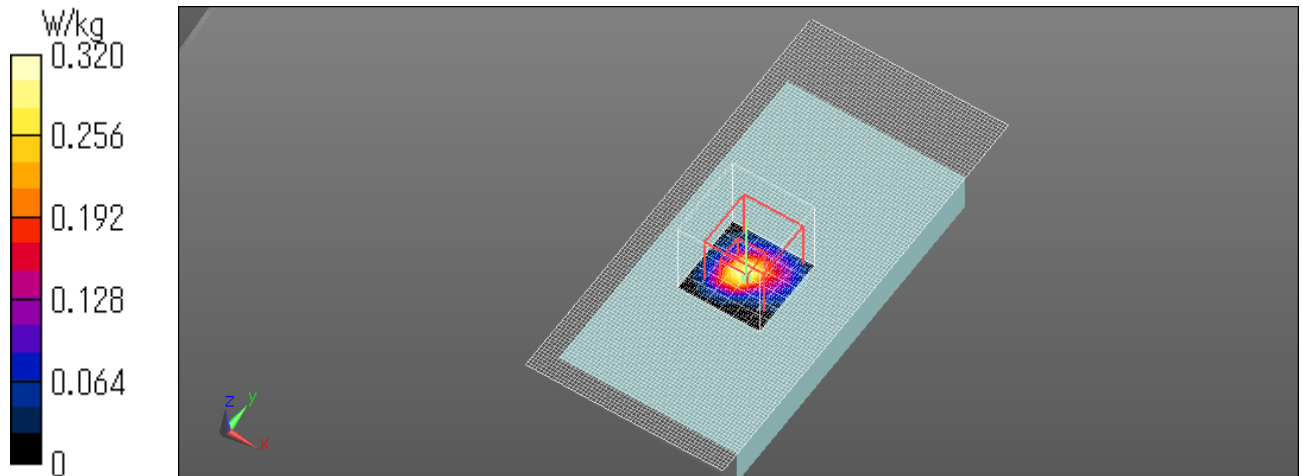

APPENDIX2 : System Check

1. System check result Body 2450MHz

(1) Simulated Tissue Liquid Parameter confirmation

DIELECTRIC PARAMETERS MEASUREMENT RESULTS											
Date	Ambient Temp. [deg.c]	Relative Humidity [%]	Liquid type	Liquid Temp. [deg.c]	Measured Frequency [MHz]	Parameters	Target Value	Measured	Deviation [%]	Limit [%]	Remark
19-Jan	24	36	MSL 2450	23.5	2450	ϵ_r	52.7	52.4	-0.5	+/-5	*1
						σ [mho/m]	1.95	1.98	1.5	+/-5	

ϵ_r : Relative Permittivity / σ : Conductivity

*1 The Target value is a parameter defined in KDB 865664D01.

DIELECTRIC PARAMETERS MEASUREMENT RESULTS											
Date	Ambient Temp. [deg.c]	Relative Humidity [%]	Liquid type	Liquid Temp. [deg.c]	Measured Frequency [MHz]	Parameters	Target Value	Measured	Deviation [%]	Limit [%]	Remark
19-Jan	24	36	MSL 2450	23.5	2450	ϵ_r	52.2	52.4	0.4	+/-6	*2 *3
						σ [mho/m]	2.00	1.98	-1.0	+/-6	

ϵ_r : Relative Permittivity / σ : Conductivity

*2 The target value is the calibrated dipole Body TSL parameters. (D2450V2 SN:713, Measured Body TSL parameters)

*3 The limit is for deviation provided by manufacture.

(2) System check result (for calibration by manufacture)

SYSTEM CHECK								
Date	Frequency [MHz]	SAR 1g [W/kg]				Deviation [%]	Limit [%]	Remark
		Forward Power	Conversion 1W	Target Value(1W)				
		Measured	Calculation					
19-Jan	2450.00	13.00	52.00	50.40	3.2	+/-10	*4	

*4 The target value is the parameter defined in SAR for SAR measured(12.6W/kg * 4) in manufacturer calibrated dipole (D2450V2 SN:713) Please refer to " SAR result with Body TSL of Appendix 2.2. System Check Dipole (D2450V2 SN:713)".

Body 2450MHz System Check DATA / Dipole2450MHz / Forward Conducted Power : 250mW

Communication System: UID 0, CW (0); Communication System Band: D2450 (2450.0 MHz); Frequency: 2450 MHz;Duty Cycle: 1:1

Medium parameters used: $f = 2450$ MHz; $\sigma = 1.98$ S/m; $\epsilon_r = 52.42$; $\rho = 1000$ kg/m³

Phantom section: Flat Section

Measurement Standard: DASYS (IEEE/IEC/ANSI C63.19-2007)

DASY Configuration:

Probe: EX3DV4 - SN3917; ConvF(7.2, 7.2, 7.2); Calibrated: 2014/05/14;

Sensor-Surface: 2mm (Mechanical Surface Detection)

Electronics: DAE4 Sn1369; Calibrated: 2014/05/14

Phantom: ELI v4.0 (20deg probe tilt); Type: QDOVA001BB; Serial: TP:1095

DASY52 52.8.8(1222); SEMCAD X 14.6.10(7331)

Area Scan (61x61x1): Interpolated grid: dx=1.500 mm, dy=1.500 mm

Maximum value of SAR (interpolated) = 19.3 W/kg

Zoom Scan (7x7x7)/Cube 0: Measurement grid: dx=5mm, dy=5mm, dz=5mm

Reference Value = 102.1 V/m; Power Drift = 0.07 dB

Peak SAR (extrapolated) = 28.2 W/kg

SAR(1 g) = 13 W/kg; SAR(10 g) = 5.81 W/kg

Maximum value of SAR (measured) = 20.4 W/kg

Date: 2015/01/19

Ambient Temp. : 24.0 degree.C. Liquid Temp.; 23.5 degree.C.

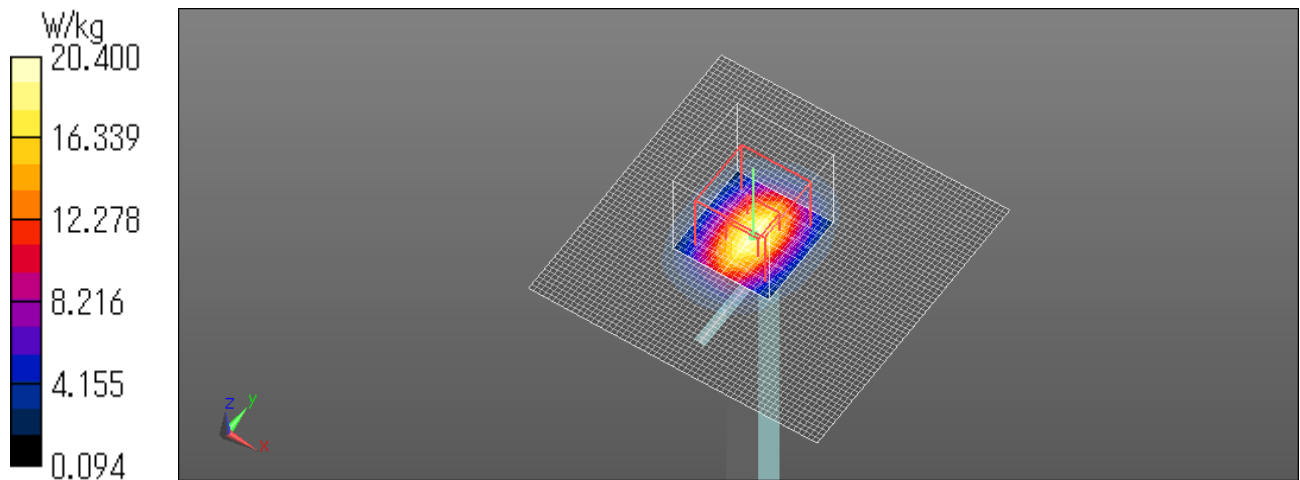

Body 2450MHz System Check DATA / Dipole2450MHz / Forward Conducted Power : 250mW

Communication System: UID 0, CW (0); Communication System Band: D2450 (2450.0 MHz); Frequency: 2450 MHz; Duty Cycle: 1:1

Medium parameters used: $f = 2450$ MHz; $\sigma = 1.98$ S/m; $\epsilon_r = 52.42$; $\rho = 1000$ kg/m³

Phantom section: Flat Section

Measurement Standard: DASYS (IEEE/IEC/ANSI C63.19-2007)

DASY Configuration:

Probe: EX3DV4 - SN3917; ConvF(7.2, 7.2, 7.2); Calibrated: 2014/05/14;

Sensor-Surface: 0mm (Fix Surface)

Electronics: DAE4 Sn1369; Calibrated: 2014/05/14

Phantom: ELI v4.0 (20deg probe tilt); Type: QDOVA001BB; Serial: TP:1095

DASY52 52.8.8(1222); SEMCAD X 14.6.10(7331)

Z Scan (1x1x31): Measurement grid: dx=20mm, dy=20mm, dz=5mm

Maximum value of SAR (measured) = 9.57 W/kg

Date: 2015/01/19

Ambient Temp. : 24.0 degree.C. Liquid Temp.; 23.5 degree.C.

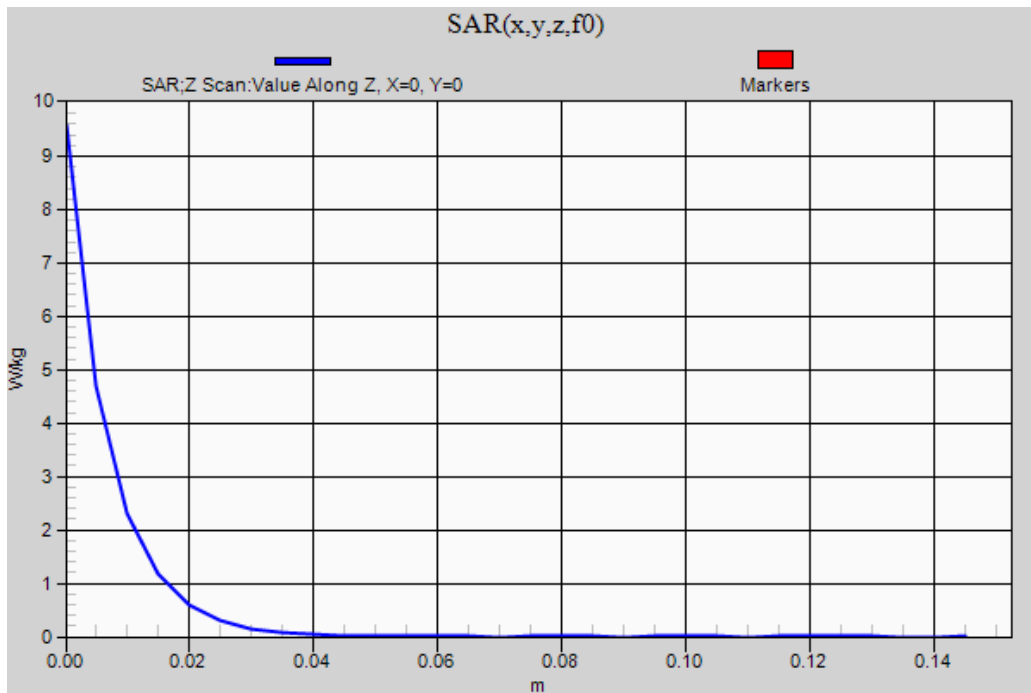

2. System Check Dipole (D2450V2,S/N:713)

**Calibration Laboratory of
Schmid & Partner
Engineering AG**
Zeughausstrasse 43, 8004 Zurich, Switzerland



S Schweizerischer Kalibrierdienst
S Service suisse d'étalonnage
C Servizio svizzero di taratura
S Swiss Calibration Service

Accredited by the Swiss Accreditation Service (SAS)
The Swiss Accreditation Service is one of the signatories to the EA
Multilateral Agreement for the recognition of calibration certificates

Accreditation No.: SCS 108

Client **UL Japan (PTT)**

Certificate No: D2450V2-713_Sep13

CALIBRATION CERTIFICATE			
Object	D2450V2 - SN: 713		
Calibration procedure(s)	QA CAL-05.v9 Calibration procedure for dipole validation kits above 700 MHz		
Calibration date:	September 10, 2013		
This calibration certificate documents the traceability to national standards, which realize the physical units of measurements (SI). The measurements and the uncertainties with confidence probability are given on the following pages and are part of the certificate.			
All calibrations have been conducted in the closed laboratory facility: environment temperature (22 ± 3)°C and humidity < 70%.			
Calibration Equipment used (M&TE critical for calibration)			
Primary Standards	ID #	Cal Date (Certificate No.)	Scheduled Calibration
Power meter EPM-442A	GB37480704	01-Nov-12 (No. 217-01640)	Oct-13
Power sensor HP 8481A	US37292783	01-Nov-12 (No. 217-01640)	Oct-13
Reference 20 dB Attenuator	SN: 5058 (20k)	04-Apr-13 (No. 217-01736)	Apr-14
Type-N mismatch combination	SN: 5047.3 / 06327	04-Apr-13 (No. 217-01739)	Apr-14
Reference Probe ES3DV3	SN: 3205	28-Dec-12 (No. ES3-3205_Dec12)	Dec-13
DAE4	SN: 601	25-Apr-13 (No. DAE4-601_Apr13)	Apr-14
Secondary Standards	ID #	Check Date (in house)	Scheduled Check
Power sensor HP 8481A	MY41092317	18-Oct-02 (in house check Oct-11)	In house check: Oct-13
RF generator R&S SMT-06	100005	04-Aug-99 (in house check Oct-11)	In house check: Oct-13
Network Analyzer HP 8753E	US37390585 S4206	18-Oct-01 (in house check Oct-12)	In house check: Oct-13
Calibrated by:	Name Israe El-Naouq	Function Laboratory Technician	Signature
Approved by:	Katja Pokovic	Technical Manager	
			Issued: September 10, 2013
This calibration certificate shall not be reproduced except in full without written approval of the laboratory.			

**Calibration Laboratory of
Schmid & Partner
Engineering AG**
Zeughausstrasse 43, 8004 Zurich, Switzerland



S Schweizerischer Kalibrierdienst
C Service suisse d'étalonnage
S Servizio svizzero di taratura
S Swiss Calibration Service

Accredited by the Swiss Accreditation Service (SAS)
The Swiss Accreditation Service is one of the signatories to the EA
Multilateral Agreement for the recognition of calibration certificates

Accreditation No.: **SCS 108**

Glossary:

TSL tissue simulating liquid
ConvF sensitivity in TSL / NORM x,y,z
N/A not applicable or not measured

Calibration is Performed According to the Following Standards:

- a) IEEE Std 1528-2003, "IEEE Recommended Practice for Determining the Peak Spatial-Averaged Specific Absorption Rate (SAR) in the Human Head from Wireless Communications Devices: Measurement Techniques", December 2003
- b) IEC 62209-1, "Procedure to measure the Specific Absorption Rate (SAR) for hand-held devices used in close proximity to the ear (frequency range of 300 MHz to 3 GHz)", February 2005
- c) KDB 865664, "SAR Measurement Requirements for 100 MHz to 6 GHz"

Additional Documentation:

- d) DASy4/5 System Handbook

Methods Applied and Interpretation of Parameters:

- *Measurement Conditions:* Further details are available from the Validation Report at the end of the certificate. All figures stated in the certificate are valid at the frequency indicated.
- *Antenna Parameters with TSL:* The dipole is mounted with the spacer to position its feed point exactly below the center marking of the flat phantom section, with the arms oriented parallel to the body axis.
- *Feed Point Impedance and Return Loss:* These parameters are measured with the dipole positioned under the liquid filled phantom. The impedance stated is transformed from the measurement at the SMA connector to the feed point. The Return Loss ensures low reflected power. No uncertainty required.
- *Electrical Delay:* One-way delay between the SMA connector and the antenna feed point. No uncertainty required.
- *SAR measured:* SAR measured at the stated antenna input power.
- *SAR normalized:* SAR as measured, normalized to an input power of 1 W at the antenna connector.
- *SAR for nominal TSL parameters:* The measured TSL parameters are used to calculate the nominal SAR result.

The reported uncertainty of measurement is stated as the standard uncertainty of measurement multiplied by the coverage factor $k=2$, which for a normal distribution corresponds to a coverage probability of approximately 95%.

Measurement Conditions

DASY system configuration, as far as not given on page 1.

DASY Version	DASY5	V52.8.7
Extrapolation	Advanced Extrapolation	
Phantom	Modular Flat Phantom	
Distance Dipole Center - TSL	10 mm	with Spacer
Zoom Scan Resolution	dx, dy, dz = 5 mm	
Frequency	2450 MHz ± 1 MHz	

Head TSL parameters

The following parameters and calculations were applied.

	Temperature	Permittivity	Conductivity
Nominal Head TSL parameters	22.0 °C	39.2	1.80 mho/m
Measured Head TSL parameters	(22.0 ± 0.2) °C	39.4 ± 6 %	1.83 mho/m ± 6 %
Head TSL temperature change during test	< 0.5 °C	----	----

SAR result with Head TSL

SAR averaged over 1 cm ³ (1 g) of Head TSL	Condition	
SAR measured	250 mW input power	13.0 W/kg
SAR for nominal Head TSL parameters	normalized to 1W	51.6 W/kg ± 17.0 % (k=2)

SAR averaged over 10 cm ³ (10 g) of Head TSL	condition	
SAR measured	250 mW input power	6.05 W/kg
SAR for nominal Head TSL parameters	normalized to 1W	24.1 W/kg ± 16.5 % (k=2)

Body TSL parameters

The following parameters and calculations were applied.

	Temperature	Permittivity	Conductivity
Nominal Body TSL parameters	22.0 °C	52.7	1.95 mho/m
Measured Body TSL parameters	(22.0 ± 0.2) °C	52.2 ± 6 %	2.00 mho/m ± 6 %
Body TSL temperature change during test	< 0.5 °C	----	----

SAR result with Body TSL

SAR averaged over 1 cm ³ (1 g) of Body TSL	Condition	
SAR measured	250 mW input power	12.6 W/kg
SAR for nominal Body TSL parameters	normalized to 1W	49.7 W/kg ± 17.0 % (k=2)

SAR averaged over 10 cm ³ (10 g) of Body TSL	condition	
SAR measured	250 mW input power	5.89 W/kg
SAR for nominal Body TSL parameters	normalized to 1W	23.4 W/kg ± 16.5 % (k=2)

Appendix

Antenna Parameters with Head TSL

Impedance, transformed to feed point	51.8 Ω + 0.7 j Ω
Return Loss	- 34.4 dB

Antenna Parameters with Body TSL

Impedance, transformed to feed point	48.7 Ω + 2.8 j Ω
Return Loss	- 30.0 dB

General Antenna Parameters and Design

Electrical Delay (one direction)	1.162 ns
----------------------------------	----------

After long term use with 100W radiated power, only a slight warming of the dipole near the feedpoint can be measured.

The dipole is made of standard semirigid coaxial cable. The center conductor of the feeding line is directly connected to the second arm of the dipole. The antenna is therefore short-circuited for DC-signals. On some of the dipoles, small end caps are added to the dipole arms in order to improve matching when loaded according to the position as explained in the "Measurement Conditions" paragraph. The SAR data are not affected by this change. The overall dipole length is still according to the Standard.

No excessive force must be applied to the dipole arms, because they might bend or the soldered connections near the feedpoint may be damaged.

Additional EUT Data

Manufactured by	SPEAG
Manufactured on	July 05, 2002

DASY5 Validation Report for Head TSL

Date: 10.09.2013

Test Laboratory: SPEAG, Zurich, Switzerland

DUT: Dipole 2450 MHz; Type: D2450V2; Serial: D2450V2 - SN: 713

Communication System: UID 0 - CW; Frequency: 2450 MHz

Medium parameters used: $f = 2450$ MHz; $\sigma = 1.83$ S/m; $\epsilon_r = 39.4$; $\rho = 1000$ kg/m³

Phantom section: Flat Section

Measurement Standard: DASY5 (IEEE/IEC/ANSI C63.19-2007)

DASY52 Configuration:

- Probe: ES3DV3 - SN3205; ConvF(4.52, 4.52, 4.52); Calibrated: 28.12.2012;
- Sensor-Surface: 3mm (Mechanical Surface Detection)
- Electronics: DAE4 Sn601; Calibrated: 25.04.2013
- Phantom: Flat Phantom 5.0 (front); Type: QD000P50AA; Serial: 1001
- DASY52 52.8.7(1137); SEMCAD X 14.6.10(7164)

Dipole Calibration for Head Tissue/Pin=250 mW, d=10mm/Zoom Scan (7x7x7)/Cube 0:

Measurement grid: dx=5mm, dy=5mm, dz=5mm

Reference Value = 94.095 V/m; Power Drift = 0.04 dB

Peak SAR (extrapolated) = 26.7 W/kg

SAR(1 g) = 13 W/kg; SAR(10 g) = 6.05 W/kg

Maximum value of SAR (measured) = 17.0 W/kg

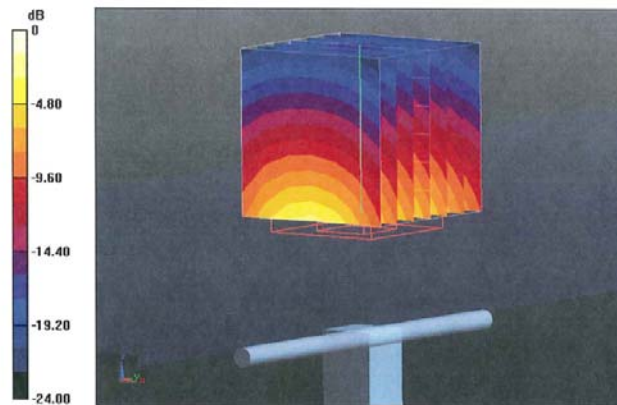

0 dB = 17.0 W/kg = 12.30 dBW/kg

Impedance Measurement Plot for Head TSL

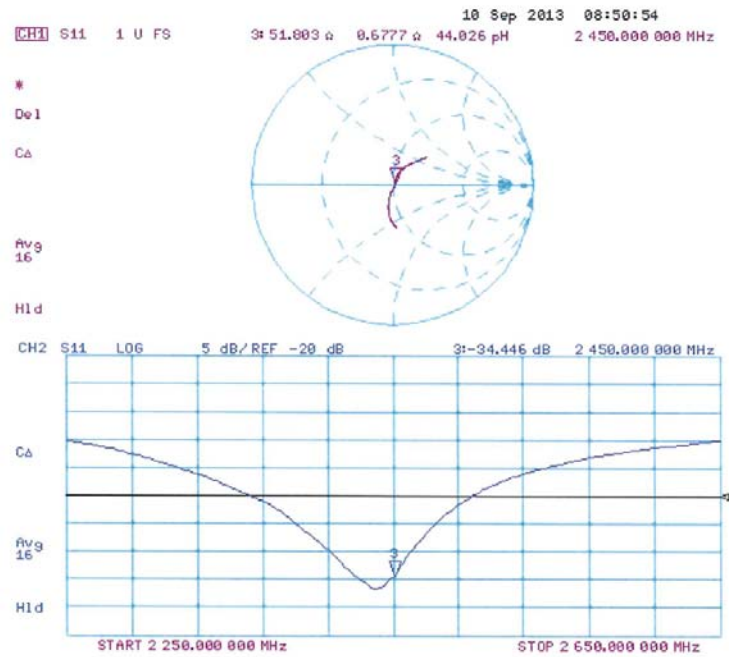

DASY5 Validation Report for Body TSL

Date: 10.09.2013

Test Laboratory: SPEAG, Zurich, Switzerland

DUT: Dipole 2450 MHz; Type: D2450V2; Serial: D2450V2 - SN: 713

Communication System: UID 0 - CW; Frequency: 2450 MHz

Medium parameters used: $f = 2450$ MHz; $\sigma = 2$ S/m; $\epsilon_r = 52.2$; $\rho = 1000$ kg/m³

Phantom section: Flat Section

Measurement Standard: DASY5 (IEEE/IEC/ANSI C63.19-2007)

DASY52 Configuration:

- Probe: ES3DV3 - SN3205; ConvF(4.42, 4.42, 4.42); Calibrated: 28.12.2012;
- Sensor-Surface: 3mm (Mechanical Surface Detection)
- Electronics: DAE4 Sn601; Calibrated: 25.04.2013
- Phantom: Flat Phantom 5.0 (back); Type: QD000P50AA; Serial: 1002
- DASY52 52.8.7(1137); SEMCAD X 14.6.10(7164)

Dipole Calibration for Body Tissue/Pin=250 mW, d=10mm/Zoom Scan (7x7x7)/Cube 0:

Measurement grid: dx=5mm, dy=5mm, dz=5mm

Reference Value = 94.095 V/m; Power Drift = 0.03 dB

Peak SAR (extrapolated) = 26.1 W/kg

SAR(1 g) = 12.6 W/kg; SAR(10 g) = 5.89 W/kg

Maximum value of SAR (measured) = 16.7 W/kg

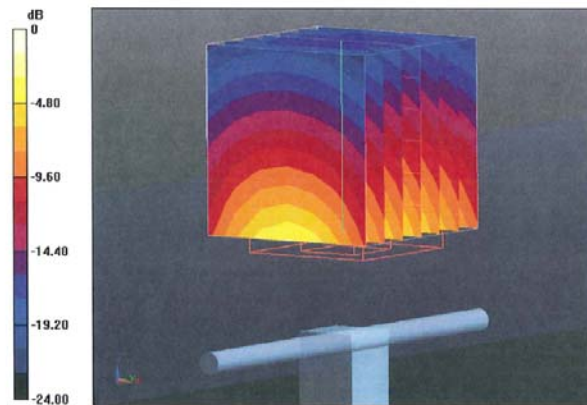

0 dB = 16.7 W/kg = 12.23 dBW/kg

Impedance Measurement Plot for Body TSL

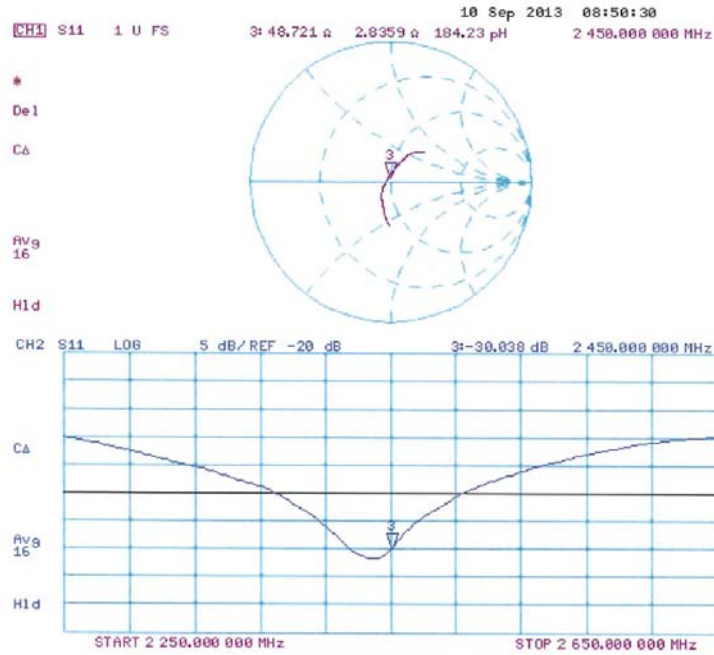

D2450V2 Calibration for Impedance and Return-loss

1. Test environment

Date	September 18, 2014		
Ambient Temperature	24.0 deg.C	Relative humidity	50%RH

2. Equipment used

Control No.	Instrument	Manufacturer	Model No	Serial No	Test Item	Calibration Date * Interval(month)
MNA-01	Network Analyzer	Agilent/HP	E8358A	US41080381	SAR	2014/08/21 * 12
MNCK-01	Type N Calibration Kit	Agilent	85032F	MY41495257	SAR	2014/08/18 * 12
EST-46	3.5mm ECONOMY CALIBRATION KIT	Agilent	85052D	MY43252869	SAR	2014/08/15 * 12
MPSAM-03	SAM Phantom	Schmid&Partner Engineering AG	QD000P40CD	1764	SAR	2014/06/03 * 12
MPF-03	2mmOval Flat Phantom ERI 5.0	Schmid&Partner Engineering AG	QDOVA001BB	1203	SAR	2014/06/03 * 12
MOS-30	Thermo-Hygrometer	Custom	CTH-201	3001	SAR	2014/07/06 * 12
MOS-35	Digital thermometer	HANNA	Checktemp 4	-	SAR	2014/07/06 * 12
HSL2450						Daily check
MSL2450						Daily check
SAR room1						Daily check

3. Test Result

Impedance, Transformed to feed point	Head	Deviation	Tolerance	Result
Calibration (SPEAG) 2013/09/10	51.8 Ω+0.7jΩ	-	-	-
Calibration(ULJ)2014/9/18	51.5Ω+0.9jΩ	-0.3Ω+0.2jΩ	+/-5Ω+/-5jΩ	Complied

Return loss	Head	Deviation	Tolerance	Result
Calibration (SPEAG) 2013/09/10	-34.4dB	-	-	-
Calibration(ULJ)2014/9/18	-35.3dB	-0.9dB	-34.4 *+/-20%	Complied

Impedance, Transformed to feed point	Body	Deviation	Tolerance	Result
Calibration (SPEAG) 2013/09/10	48.7Ω+2.8jΩ	-	-	-
Calibration(ULJ)2014/9/18	49.6Ω+2.8jΩ	+0.9Ω+/-0jΩ	+/-5Ω+/-5jΩ	Complied

Return loss	Body	Deviation	Tolerance	Result
Calibration (SPEAG) 2013/09/10	-30.0dB	-	-	-
Calibration(ULJ)2014/9/18	-31.0dB	-1.0dB	-30.0 *+/-20%	Complied

*Tolerance : According to the KDB450824D02

Measurement Plots

<Head Liquid>

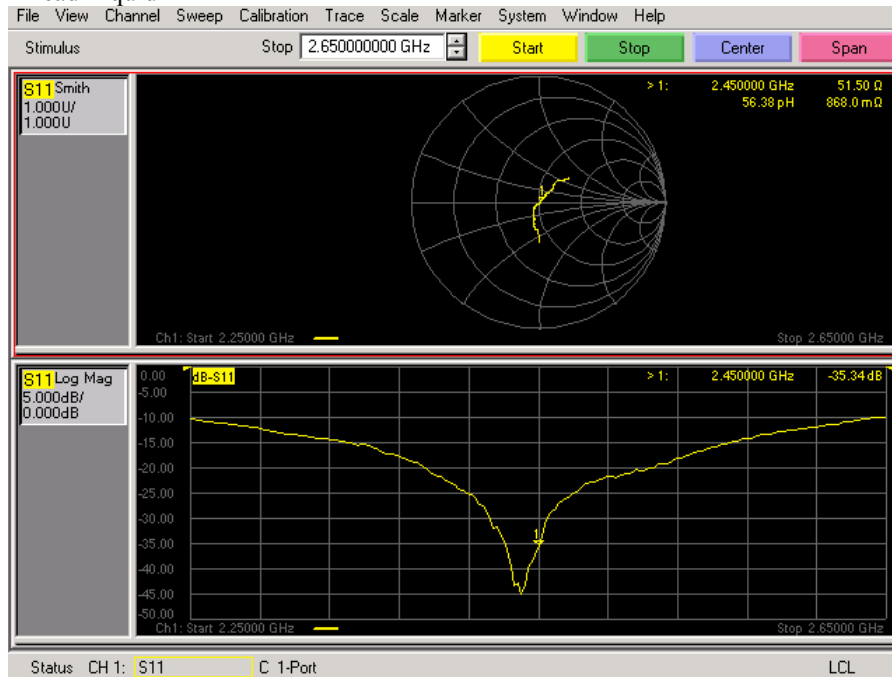

<Body Liquid>

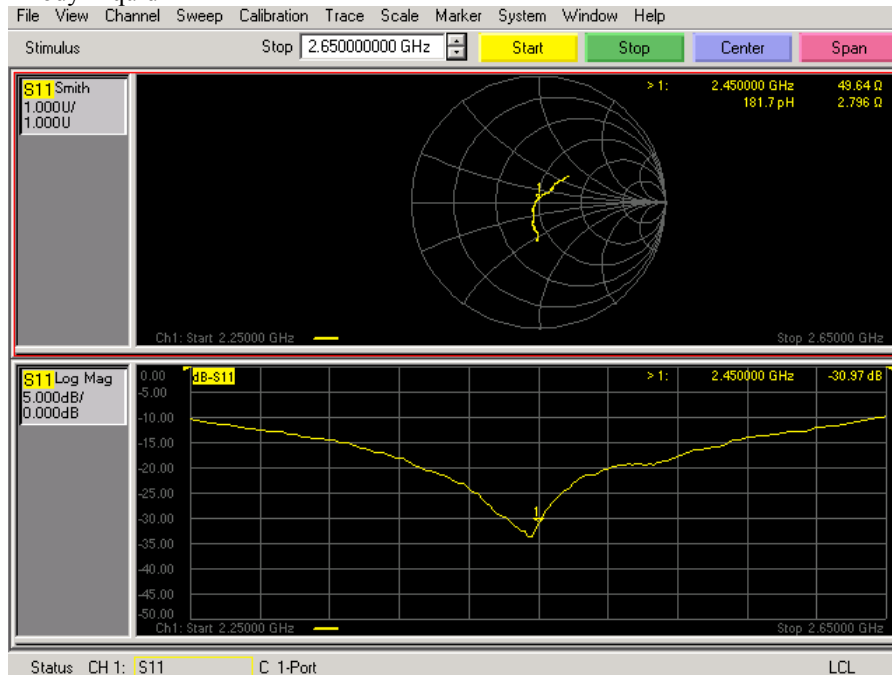

UL Japan, Inc.

Ise EMC Lab.

4383-326 Asama-cho, Ise-shi, Mie-ken 516-0021 JAPAN

Telephone: +81 596 24 8999

Facsimile: +81 596 24 8124

3. System check uncertainty

The uncertainty budget has been determined for the DASYS measurement system according to the SPEAG documents[1] and is given in the following Table.

Repeatability Budget for System Check

<0.3 – 3GHz range Body>

Error Description	Uncertainty value ± %	Probability distribution	divisor	(ci) 1g	Standard (1g)	vi or veff
Measurement System						
Probe calibration	± 1.8	Normal	1	1	± 1.8	∞
Axial isotropy of the probe	± 0.0	Rectangular	√3	1	± 0.0	∞
Spherical isotropy of the probe	± 0.0	Rectangular	√3	0	± 0.0	∞
Boundary effects	± 0.0	Rectangular	√3	1	± 0.0	∞
Probe linearity	± 0.0	Rectangular	√3	1	± 0.0	∞
Detection limit	± 0.0	Rectangular	√3	1	± 0.0	∞
Modulation response	± 0.0	Rectangular	√3	1	± 0.0	∞
Readout electronics	± 0.0	Normal	1	1	± 0.0	∞
Response time	± 0.0	Rectangular	√3	1	± 0.0	∞
Integration time	± 0.0	Rectangular	√3	1	± 0.0	∞
RF ambient Noise	± 0.0	Rectangular	√3	1	± 0.0	∞
RF ambient	± 0.0	Rectangular	√3	1	± 0.0	∞
Probe Positioner	± 0.4	Rectangular	√3	1	± 0.2	∞
Probe positioning	± 2.9	Rectangular	√3	1	± 1.7	∞
Max.SAR Eval.	± 0.0	Rectangular	√3	1	± 0.0	∞
Test Sample Related						
Deviation of	± 0.0	Normal	√3	1	± 0.0	∞
Dipole Axis to Liquid Distance	± 2.0	Normal	√3	1	± 1.2	∞
Input power and SAR drift meas.	± 3.4	Rectangular	√3	1	± 2.0	∞
Phantom and Setup						
Phantom uncertainty	± 4.0	Rectangular	√3	1	± 2.3	∞
Algorithm for correcting SAR for deviations in permittivity and conductivity	± 1.9	Normal	1	1	± 1.9	∞
Liquid conductivity (meas.)	± 5.0	Rectangular	1	0.78	+ 3.9	∞
Liquid permittivity (meas.)	± 5.0	Rectangular	1	0.26	- 1.3	∞
Liquid conductivity - temp.unc (below 2deg.C.)	± 1.7	Rectangular	√3	0.78	± 0.8	∞
Liquid permittivity - temp.unc (below 2deg.C.)	± 0.3	Rectangular	√3	0.23	± 0.0	∞
Combined Standard Uncertainty					± 6.144	
Expanded Uncertainty (k=2)					± 12.3	

UL Japan, Inc.

Ise EMC Lab.

4383-326 Asama-cho, Ise-shi, Mie-ken 516-0021 JAPAN

Telephone: +81 596 24 8999

Facsimile: +81 596 24 8124

APPENDIX 3 : System specifications

1. Configuration and peripherals

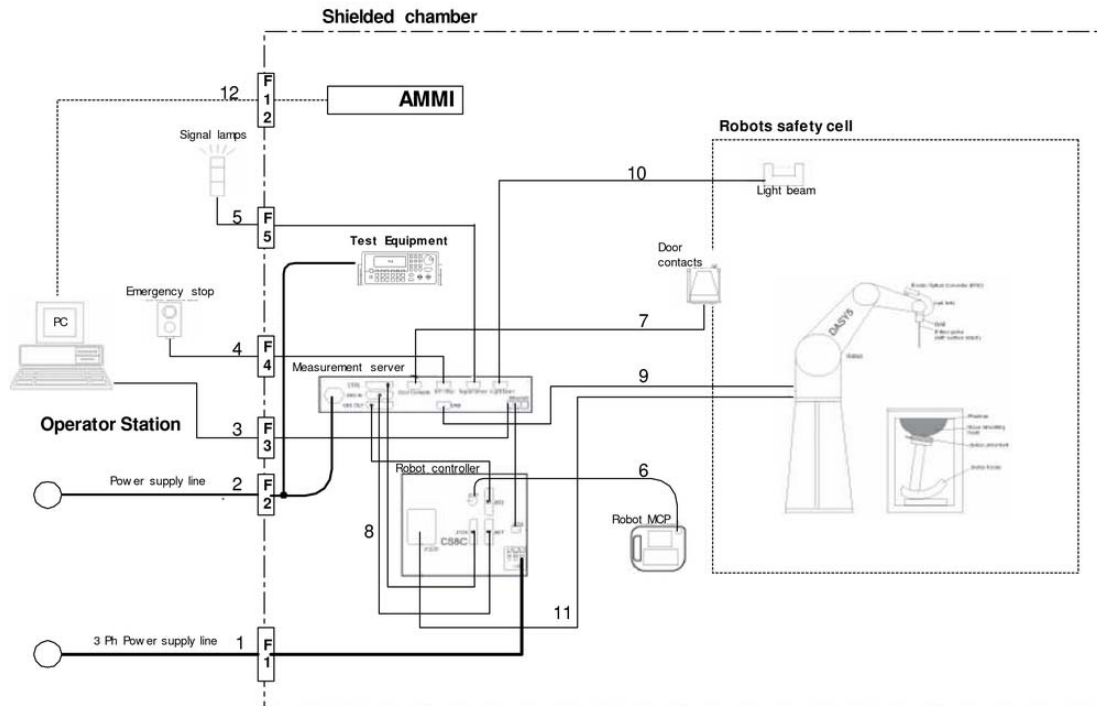

The DASYS5 system for performing compliance tests consist of the following items:

- a) A standard high precision 6-axis robot (Stäubli RX family) with controller and software.
An arm extension for accommodating the data acquisition electronics (DAE).
- b) An isotropic field probe optimized and calibrated for the targeted measurement.
- c) A data acquisition electronic (DAE), which performs the signal amplification, signal multiplexing, AD-conversion, offset measurements, mechanical surface detection, collision detection, etc. The unit is battery powered with standard or rechargeable batteries. The signal is optically transmitted to the EOC.
- d) The Electro-optical converter (EOC) performs the conversion between optical and electrical of the signals for the digital communication to the DAE and for the analog signal from the optical surface detection.
The EOC is connected to the measurement server.
- e) The function of the measurement server is to perform the time critical tasks such as signal filtering, control of the robot operation and fast movement interrupts.
- f) The Light Beam used is for probe alignment. This improves the (absolute) accuracy of the probe positioning.
- g) A computer running WinXP and the DASYS5 software.
- h) Remote control with teaches pendant and additional circuitry for robot safety such as warning lamps, etc.
- i) The phantom, the device holder and other accessories according to the targeted measurement.

UL Japan, Inc.

Ise EMC Lab.

4383-326 Asama-cho, Ise-shi, Mie-ken 516-0021 JAPAN

Telephone: +81 596 24 8999

Facsimile: +81 596 24 8124

2. Specifications

a) Robot TX60L

Number of Axes	:	6
Nominal Load	:	2 kg
Maximum Load	:	5kg
Reach	:	920mm
Repeatability	:	+/-0.03mm
Control Unit	:	CS8c
Programming Language	:	VAL3
Weight	:	52.2kg
Manufacture	:	Stäubli Robotics

b) E-Field Probe

Model	:	EX3DV4
Serial No.	:	3917
Construction	:	Symmetrical design with triangular core Built-in shielding against static charges PEEK enclosure material (resistant to organic solvents, e.g., glycol ether)
Frequency	:	10 MHz to > 6 GHz Linearity: ± 0.2 dB (30 MHz to 6 GHz)
Directivity	:	+/-0.3 dB in HSL (rotation around probe axis) +/-0.5 dB in tissue material (rotation normal probe axis)
Dynamic Range	:	10uW/g to > 100 mW/g; Linearity +/-0.2 dB(noise: typically < 1uW/g)
Dimensions	:	Overall length: 337 mm (Tip: 20 mm) Tip diameter: 2.5mm (Body: 12 mm) Typical distance from probe tip to dipole centers: 1 mm
Application	:	Highprecision dosimetric measurement in any exposure scenario (e.g., very strong gradient fields). Only probe which enables compliance testing for frequencies up to 6GHz with precision of better 30%.
Manufacture	:	Schmid & Partner Engineering AG



EX3DV4 E-field Probe

c)Data Acquisition Electronic (DAE4)

Features	:	Signal amplifier, multiplexer, A/D converter and control logic Serial optical link for communication with DASY5 embedded system (fully remote controlled) Two step probe touch detector for mechanical surface detection and emergency robot stop
Measurement Range	:	-100 to +300 mV (16 bit resolution and two range settings: 4mV, 400mV)
Input Offset voltage	:	< 5 μ V (with auto zero)
Input Resistance	:	200 M Ω
Input Bias Current	:	< 50 fA
Battery Power	:	> 10 h of operation (with two 9.6 V NiMH accus)
Dimension	:	60 x 60 x 68 mm
Manufacture	:	Schmid & Partner Engineering AG

d)Electro-Optic Converter (EOC)

Version	:	EOC 61
Description	:	for TX60 robot arm, including proximity sensor
Manufacture	:	Schmid & Partner Engineering AG

e)DASY5 Measurement server

Features	:	Intel ULV Celeron 400MHz 128MB chip disk and 128MB RAM 16 Bit A/D converter for surface detection system Vacuum Fluorescent Display Robot Interface Serial link to DAE (with watchdog supervision) Door contact port (Possibility to connect a light curtain) Emergency stop port (to connect the remote control) Signal lamps port Light beam port Three Ethernet connection ports Two USB 2.0 Ports Two serial links Expansion port for future applications
Dimensions (L x W x H)	:	440 x 241 x 89 mm
Manufacture	:	Schmid & Partner Engineering AG

f) Light Beam Switches

Version	:	LB5
Dimensions (L x H)	:	110 x 80 mm
Thickness	:	12 mm
Beam-length	:	80 mm
Manufacture	:	Schmid & Partner Engineering AG

g)Software

Item	:	Dosimetric Assessment System DASY5
Type No.	:	SD 000 401A, SD 000 402A
Software version No.	:	DASY52, Version 52.6 (1)
Manufacture / Origin	:	Schmid & Partner Engineering AG

h)Robot Control Unit

Weight	:	70 Kg
AC Input Voltage	:	selectable
Manufacturer	:	Stäubli Robotics

UL Japan, Inc.

Ise EMC Lab.

4383-326 Asama-cho, Ise-shi, Mie-ken 516-0021 JAPAN

Telephone: +81 596 24 8999

Facsimile: +81 596 24 8124

i) Phantom and Device Holder

Phantom

Type	:	SAM Twin Phantom V4.0
Description	:	The shell corresponds to the specifications of the Specific Anthropomorphic Mannequin (SAM) phantom defined in IEEE 1528 and IEC 62209-1. It enables the dosimetric evaluation of left and right hand phone usage as well as body mounted usage at the flat phantom region. A cover prevents evaporation of the liquid. Reference markings on the phantom allow the complete setup of all predefined phantom positions and measurement grids by teaching three points with the robot.
Material	:	Vinylester, glass fiber reinforced (VE-GF)
Shell Material	:	Fiberglass
Thickness	:	2.0 +/-0.2 mm
Dimensions	:	Length: 1000 mm Width: 500 mm Height: adjustable feet
Volume	:	Approx. 25 liters
Manufacture	:	Schmid & Partner Engineering AG

Type	:	2mm Flat phantom ERI4.0
Description	:	Phantom for compliance testing of handheld and body-mounted wireless devices in the frequency range of 30 MHz to 6 GHz. ELI4 is fully compatible with the latest draft of the standard IEC 62209 Part II and all known tissue simulating liquids. ELI4 has been optimized regarding its performance and can be integrated into our standard phantom tables. A cover prevents evaporation of the liquid. Reference markings on the phantom allow installation of the complete setup, including all predefined phantom positions and measurement grids, by teaching three points. The phantom is supported by software version DASY4.5 and higher and is compatible with all SPEAG dosimetric probes and dipoles.
Material	:	Vinylester, glass fiber reinforced (VE-GF)
Shell Thickness	:	2.0 ± 0.2 mm (sagging: <1%)
Filling Volume	:	approx. 30 liters
Dimensions	:	Major ellipse axis: 600 mm Minor axis: 400 mm
Manufacture	:	Schmid & Partner Engineering AG

Device Holder

In combination with the Twin SAM Phantom V4.0/V4.0c or ELI4, the Mounting Device enables the rotation of the mounted transmitter device in spherical coordinates. Rotation point is the ear opening point. Transmitter devices can be easily and accurately positioned according to IEC, IEEE, FCC or other specifications. The device holder can be locked for positioning at different phantom sections (left head, right head, flat).

Material	:	POM
-----------------	---	-----

Laptio Extensions kit

Simple but effective and easy-to-use extension for Mounting Device that facilitates the testing of larger devices according to IEC 62209-2 (e.g., laptops, cameras, etc.). It is lightweight and fits easily on the upper part of the Mounting Device in place of the phone positioner. The extension is fully compatible with the Twin-SAM, ELI4 Phantoms.

Material	:	POM, Acrylic glass, Foam
-----------------	---	--------------------------

Urethane

For this measurement, the urethane foam was used as device holder.

j) Simulated Tissues (Liquid)

The following tissue formulations are provided for reference only as some of the parameters have not been thoroughly verified. The composition of ingredients may be modified accordingly to achieve the desired target tissue parameters required for required for routine SAR evaluation.

Mixture (%)	Frequency (MHz)									
	450		900		1800		1950		2450	
Tissue Type	Head	Body	Head	Body	Head	Body	Head	Body	Head	Body
Water	38.91	46.21	40.29	50.75	55.24	70.17	55.41	69.79	55.0	68.64
Sugar	56.93	51.17	57.90	48.21	-	-	-	-	-	-
Cellulose	0.25	0.18	0.24	0.00	-	-	-	-	-	-
Salt (NaCl)	3.79	2.34	1.38	0.94	0.31	0.39	0.08	0.2	-	-
Preventol	0.12	0.08	0.18	0.10	-	-	-	-	-	-
DGMBE	-	-	-	-	44.45	29.44	44.51	30.0	45.0	31.37
Dielectric Constant	43.42	58.0	42.54	56.1	42.0	56.8	39.9	54.0	39.8	52.5
Conductivity (S/m)	0.85	0.83	0.91	0.95	1.0	1.07	1.42	1.45	1.88	1.78

Note: DGMBE (Diethylenglycol-monobutyl ether)

The simulated tissue (liquid) of 1800MHz was used for the test frequency of 1700MHz to 1800MHz.

Mixture (%)	Frequency (MHz)	
	650&750	1450
Tissue Type	Head and Body	Head and Body
Water	35-58%	52-75%
Sugar	40-60%	-
Cellulose	<0.3%	-
Salt (NaCl)	0-6%	<1%
Preventol	0.1-0.7%	-
DGMBE	-	25-48%

Mixture (%)	Frequency (MHz)	
	5800	
Tissue Type	Head	Body
Water	64.0	78.0
Mineral Oil	18.0	11.0
Emulsifiers	15.0	9.0
Additives and salt	3.0	2.0

3. Dosimetric E-Field Probe Calibration (EX3DV4, S/N: 3917)

**Calibration Laboratory of
 Schmid & Partner
 Engineering AG**
 Zeughausstrasse 43, 8004 Zurich, Switzerland



S Schweizerischer Kalibrierdienst
S Service suisse d'étalonnage
S Servizio svizzero di taratura
S Swiss Calibration Service

Accredited by the Swiss Accreditation Service (SAS)
 The Swiss Accreditation Service is one of the signatories to the EA
 Multilateral Agreement for the recognition of calibration certificates

Accreditation No.: **SCS 108**

Client **UL Japan (PTT)**

Certificate No: **EX3-3917_May14**

CALIBRATION CERTIFICATE	
Object	EX3DV4 - SN:3917
Calibration procedure(s)	QA CAL-01.v9, QA CAL-12.v9, QA CAL-14.v4, QA CAL-23.v5, QA CAL-25.v6 Calibration procedure for dosimetric E-field probes
Calibration date:	May 14, 2014
This calibration certificate documents the traceability to national standards, which realize the physical units of measurements (SI). The measurements and the uncertainties with confidence probability are given on the following pages and are part of the certificate.	
All calibrations have been conducted in the closed laboratory facility: environment temperature (22 ± 3)°C and humidity < 70%.	
Calibration Equipment used (M&TE critical for calibration)	

Primary Standards	ID	Cal Date (Certificate No.)	Scheduled Calibration
Power meter E4419B	GB41293874	03-Apr-14 (No. 217-01911)	Apr-15
Power sensor E4412A	MY41498087	03-Apr-14 (No. 217-01911)	Apr-15
Reference 3 dB Attenuator	SN: S5054 (3c)	03-Apr-14 (No. 217-01915)	Apr-15
Reference 20 dB Attenuator	SN: S5277 (20x)	03-Apr-14 (No. 217-01919)	Apr-15
Reference 30 dB Attenuator	SN: S5129 (30b)	03-Apr-14 (No. 217-01920)	Apr-15
Reference Probe ES3DV2	SN: 3013	30-Dec-13 (No. ES3-3013_Dec13)	Dec-14
DAE4	SN: 660	13-Dec-13 (No. DAE4-660_Dec13)	Dec-14
Secondary Standards	ID	Check Date (in house)	Scheduled Check
RF generator HP 8648C	US3642U01700	4-Aug-99 (in house check Apr-13)	In house check: Apr-16
Network Analyzer HP 8753E	US37390585	18-Oct-01 (in house check Oct-13)	In house check: Oct-14

Calibrated by:	Name Claudio Leubler	Function Laboratory Technician	Signature
Approved by:	Name Katja Pokovic	Function Technical Manager	Signature
			Issued: May 15, 2014
This calibration certificate shall not be reproduced except in full without written approval of the laboratory.			

**Calibration Laboratory of
Schmid & Partner
Engineering AG**
Zeughausstrasse 43, 8004 Zurich, Switzerland



S Schweizerischer Kalibrierdienst
C Service suisse d'étalonnage
S Servizio svizzero di taratura
S Swiss Calibration Service

Accredited by the Swiss Accreditation Service (SAS)
The Swiss Accreditation Service is one of the signatories to the EA
Multilateral Agreement for the recognition of calibration certificates

Accreditation No.: **SCS 108**

Glossary:

TSL	tissue simulating liquid
NORM _{x,y,z}	sensitivity in free space
ConvF	sensitivity in TSL / NORM _{x,y,z}
DCP	diode compression point
CF	crest factor (1/duty_cycle) of the RF signal
A, B, C, D	modulation dependent linearization parameters
Polarization φ	φ rotation around probe axis
Polarization ϑ	ϑ rotation around an axis that is in the plane normal to probe axis (at measurement center), i.e., $\vartheta = 0$ is normal to probe axis
Connector Angle	information used in DASY system to align probe sensor X to the robot coordinate system

Calibration is Performed According to the Following Standards:

- IEEE Std 1528-2013, "IEEE Recommended Practice for Determining the Peak Spatial-Averaged Specific Absorption Rate (SAR) in the Human Head from Wireless Communications Devices: Measurement Techniques", June 2013
- IEC 62209-1, "Procedure to measure the Specific Absorption Rate (SAR) for hand-held devices used in close proximity to the ear (frequency range of 300 MHz to 3 GHz)", February 2005

Methods Applied and Interpretation of Parameters:

- NORM_{x,y,z}**: Assessed for E-field polarization $\vartheta = 0$ ($f \leq 900$ MHz in TEM-cell; $f > 1800$ MHz: R22 waveguide). NORM_{x,y,z} are only intermediate values, i.e., the uncertainties of NORM_{x,y,z} does not affect the E²-field uncertainty inside TSL (see below ConvF).
- NORM(f)_{x,y,z} = NORM_{x,y,z} * frequency_response** (see Frequency Response Chart). This linearization is implemented in DASY4 software versions later than 4.2. The uncertainty of the frequency response is included in the stated uncertainty of ConvF.
- DCP_{x,y,z}**: DCP are numerical linearization parameters assessed based on the data of power sweep with CW signal (no uncertainty required). DCP does not depend on frequency nor media.
- PAR**: PAR is the Peak to Average Ratio that is not calibrated but determined based on the signal characteristics
- A_{x,y,z}; B_{x,y,z}; C_{x,y,z}; D_{x,y,z}; VR_{x,y,z}; A, B, C, D** are numerical linearization parameters assessed based on the data of power sweep for specific modulation signal. The parameters do not depend on frequency nor media. VR is the maximum calibration range expressed in RMS voltage across the diode.
- ConvF and Boundary Effect Parameters**: Assessed in flat phantom using E-field (or Temperature Transfer Standard for $f \leq 800$ MHz) and inside waveguide using analytical field distributions based on power measurements for $f > 800$ MHz. The same setups are used for assessment of the parameters applied for boundary compensation (alpha, depth) of which typical uncertainty values are given. These parameters are used in DASY4 software to improve probe accuracy close to the boundary. The sensitivity in TSL corresponds to NORM_{x,y,z} * ConvF whereby the uncertainty corresponds to that given for ConvF. A frequency dependent ConvF is used in DASY version 4.4 and higher which allows extending the validity from ± 50 MHz to ± 100 MHz.
- Spherical isotropy (3D deviation from isotropy)**: in a field of low gradients realized using a flat phantom exposed by a patch antenna.
- Sensor Offset**: The sensor offset corresponds to the offset of virtual measurement center from the probe tip (on probe axis). No tolerance required.
- Connector Angle**: The angle is assessed using the information gained by determining the NORM_x (no uncertainty required).

EX3DV4 – SN:3917

May 14, 2014

Probe EX3DV4

SN:3917

Manufactured: December 18, 2012
Calibrated: May 14, 2014

Calibrated for DASY/EASY Systems
(Note: non-compatible with DASY2 system!)

EX3DV4--SN:3917

May 14, 2014

DASY/EASY - Parameters of Probe: EX3DV4 - SN:3917

Basic Calibration Parameters

	Sensor X	Sensor Y	Sensor Z	Unc (k=2)
Norm ($\mu\text{V}/(\text{V}/\text{m})^2$) ^A	0.54	0.41	0.46	± 10.1 %
DCP (mV) ^B	97.9	104.3	102.6	

Modulation Calibration Parameters

UID	Communication System Name		A dB	B dB $\sqrt{\mu\text{V}}$	C	D dB	VR mV	Unc ^E (k=2)
0	CW	X	0.0	0.0	1.0	0.00	148.1	±3.0 %
		Y	0.0	0.0	1.0		148.4	
		Z	0.0	0.0	1.0		136.2	

The reported uncertainty of measurement is stated as the standard uncertainty of measurement multiplied by the coverage factor k=2, which for a normal distribution corresponds to a coverage probability of approximately 95%.

^A The uncertainties of NormX,Y,Z do not affect the E²-field uncertainty inside TSL (see Pages 5 and 6).

^B Numerical linearization parameter: uncertainty not required.

^E Uncertainty is determined using the max. deviation from linear response applying rectangular distribution and is expressed for the square of the field value.

EX3DV4- SN:3917

May 14, 2014

DASY/EASY - Parameters of Probe: EX3DV4 - SN:3917

Calibration Parameter Determined in Head Tissue Simulating Media

f (MHz) ^C	Relative Permittivity ^F	Conductivity (S/m) ^F	ConvF X	ConvF Y	ConvF Z	Alpha ^G	Depth ^G (mm)	Unct. (k=2)
650	42.5	0.89	10.31	10.31	10.31	0.11	1.10	± 13.3 %
750	41.9	0.89	10.11	10.11	10.11	0.36	0.93	± 12.0 %
835	41.5	0.90	9.75	9.75	9.75	0.27	1.10	± 12.0 %
900	41.5	0.97	9.57	9.57	9.57	0.25	1.05	± 12.0 %
1450	40.5	1.20	9.17	9.17	9.17	0.43	0.92	± 12.0 %
1640	40.3	1.29	8.63	8.63	8.63	0.80	0.57	± 12.0 %
1750	40.1	1.37	8.46	8.46	8.46	0.42	0.80	± 12.0 %
1810	40.0	1.40	8.21	8.21	8.21	0.42	0.81	± 12.0 %
1900	40.0	1.40	8.14	8.14	8.14	0.76	0.61	± 12.0 %
1950	40.0	1.40	7.84	7.84	7.84	0.59	0.67	± 12.0 %
2450	39.2	1.80	7.24	7.24	7.24	0.64	0.65	± 12.0 %
2600	39.0	1.96	6.91	6.91	6.91	0.46	0.77	± 12.0 %
5200	36.0	4.66	5.45	5.45	5.45	0.30	1.80	± 13.1 %
5300	35.9	4.76	5.27	5.27	5.27	0.30	1.80	± 13.1 %
5500	35.6	4.96	4.91	4.91	4.91	0.35	1.80	± 13.1 %
5600	35.5	5.07	4.71	4.71	4.71	0.35	1.80	± 13.1 %
5800	35.3	5.27	4.82	4.82	4.82	0.35	1.80	± 13.1 %

^C Frequency validity of ± 100 MHz only applies for DASY v4.4 and higher (see Page 2), else it is restricted to ± 50 MHz. Above 5 GHz frequency validity can be extended to ± 110 MHz. The uncertainty is the RSS of the ConvF uncertainty at calibration frequency and the uncertainty for the indicated frequency band.

^F At frequencies below 3 GHz, the validity of tissue parameters (ϵ and σ) can be relaxed to ± 10% if liquid compensation formula is applied to measured SAR values. At frequencies above 3 GHz, the validity of tissue parameters (ϵ and σ) is restricted to ± 5%. The uncertainty is the RSS of the ConvF uncertainty for indicated target tissue parameters.

^G Alpha/Depth are determined during calibration. SPEAG warrants that the remaining deviation due to the boundary effect after compensation is always less than ± 1% for frequencies below 3 GHz and below ± 2% for frequencies between 3-6 GHz at any distance larger than half the probe tip diameter from the boundary.

EX3DV4- SN:3917

May 14, 2014

DASY/EASY - Parameters of Probe: EX3DV4 - SN:3917

Calibration Parameter Determined in Body Tissue Simulating Media

f (MHz) ^C	Relative Permittivity ^F	Conductivity (S/m) ^F	ConvF X	ConvF Y	ConvF Z	Alpha ^G	Depth (mm) ^G	Unct. (k=2)
650	55.9	0.96	9.92	9.92	9.92	0.05	1.05	± 13.3 %
750	55.5	0.96	9.81	9.81	9.81	0.61	0.68	± 12.0 %
835	55.2	0.97	9.64	9.64	9.64	0.29	1.07	± 12.0 %
900	55.0	1.05	9.38	9.38	9.38	0.26	1.12	± 12.0 %
1450	54.0	1.30	8.35	8.35	8.35	0.37	0.88	± 12.0 %
1640	53.8	1.40	8.50	8.50	8.50	0.39	0.86	± 12.0 %
1750	53.4	1.49	7.88	7.88	7.88	0.45	0.85	± 12.0 %
1810	53.3	1.52	7.74	7.74	7.74	0.68	0.68	± 12.0 %
1900	53.3	1.52	7.68	7.68	7.68	0.30	1.02	± 12.0 %
1950	53.3	1.52	7.93	7.93	7.93	0.51	0.77	± 12.0 %
2450	52.7	1.95	7.20	7.20	7.20	0.76	0.57	± 12.0 %
2600	52.5	2.16	7.01	7.01	7.01	0.80	0.50	± 12.0 %
5200	49.0	5.30	5.02	5.02	5.02	0.35	1.90	± 13.1 %
5300	48.9	5.42	4.82	4.82	4.82	0.35	1.90	± 13.1 %
5500	48.6	5.65	4.46	4.46	4.46	0.35	1.90	± 13.1 %
5600	48.5	5.77	4.26	4.26	4.26	0.35	1.90	± 13.1 %
5800	48.2	6.00	4.52	4.52	4.52	0.40	1.90	± 13.1 %

^C Frequency validity of ± 100 MHz only applies for DASY v4.4 and higher (see Page 2), else it is restricted to ± 50 MHz. Above 5 GHz frequency validity can be extended to ± 110 MHz. The uncertainty is the RSS of the ConvF uncertainty at calibration frequency and the uncertainty for the indicated frequency band.

^F At frequencies below 3 GHz, the validity of tissue parameters (ϵ and σ) can be relaxed to ± 10% if liquid compensation formula is applied to measured SAR values. At frequencies above 3 GHz, the validity of tissue parameters (ϵ and σ) is restricted to ± 5%. The uncertainty is the RSS of the ConvF uncertainty for indicated target tissue parameters.

^G Alpha/Depth are determined during calibration. SPEAG warrants that the remaining deviation due to the boundary effect after compensation is always less than ± 1% for frequencies below 3 GHz and below ± 2% for frequencies between 3-6 GHz at any distance larger than half the probe tip diameter from the boundary.

EX3DV4-SN:3917

May 14, 2014

Frequency Response of E-Field (TEM-Cell:ifi110 EXX, Waveguide: R22)

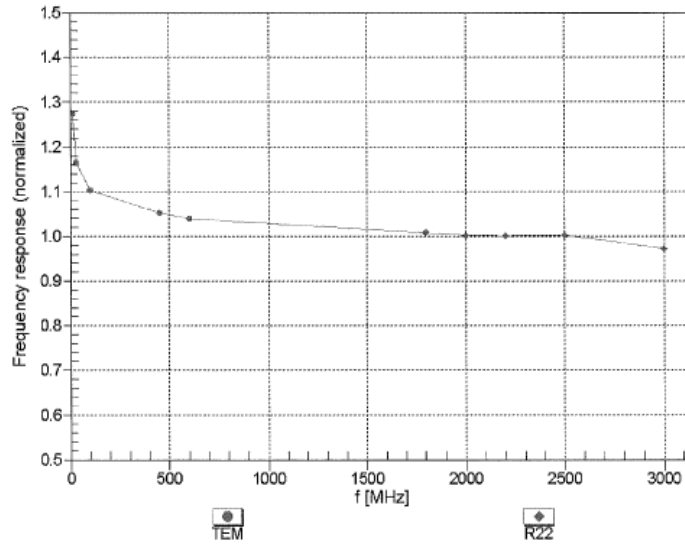

Uncertainty of Frequency Response of E-field: $\pm 6.3\%$ ($k=2$)

EX3DV4- SN:3917

May 14, 2014

Receiving Pattern (ϕ), $\theta = 0^\circ$

f=600 MHz,TEM

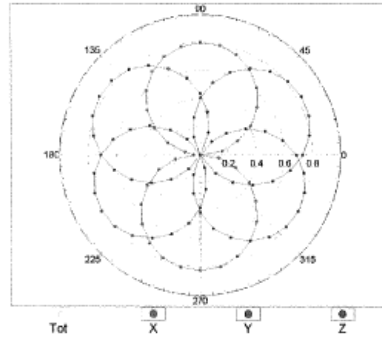

f=1800 MHz,R22

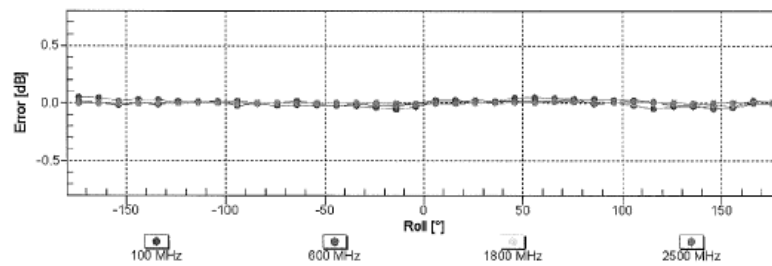
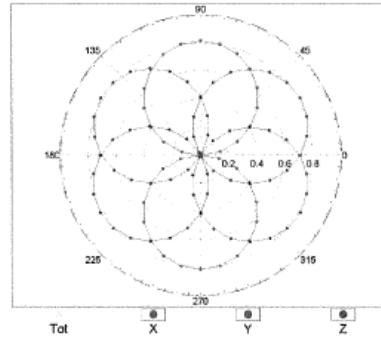

Uncertainty of Axial Isotropy Assessment: $\pm 0.5\%$ (k=2)

EX3DV4- SN:3917

May 14, 2014

Dynamic Range f(SAR_{head}) (TEM cell , f_{eval}= 1900 MHz)

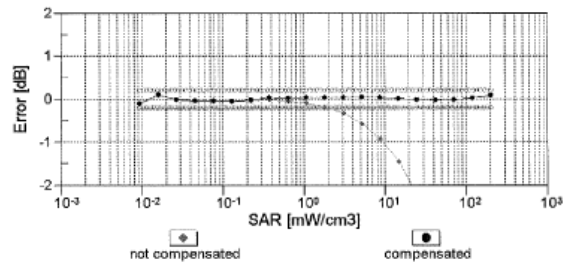
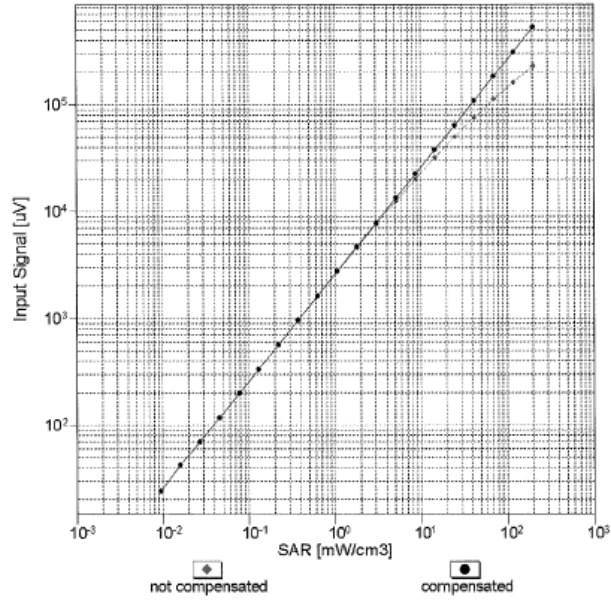

Uncertainty of Linearity Assessment: ± 0.6% (k=2)

EX3DV4-SN:3917

May 14, 2014

Conversion Factor Assessment

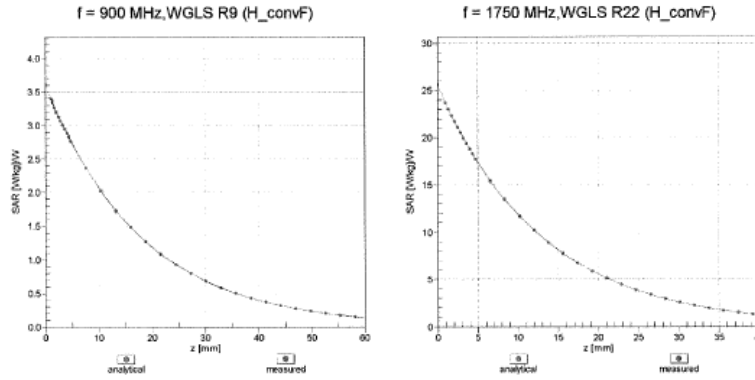

Deviation from Isotropy in Liquid Error (ϕ, θ), f = 900 MHz

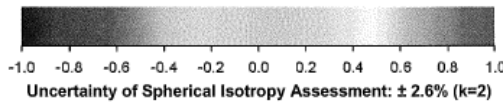
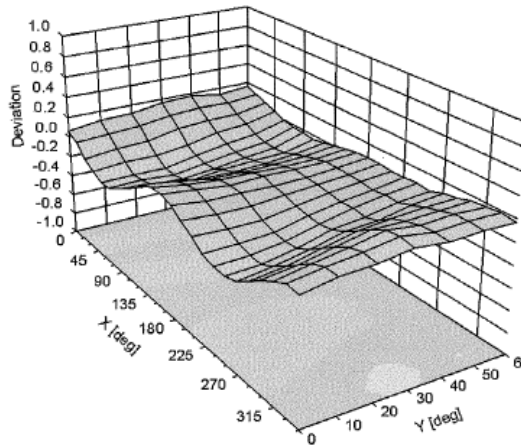

EX3DV4- SN:3917

May 14, 2014

DASY/EASY - Parameters of Probe: EX3DV4 - SN:3917

Other Probe Parameters

Sensor Arrangement	Triangular
Connector Angle (°)	-114
Mechanical Surface Detection Mode	enabled
Optical Surface Detection Mode	disabled
Probe Overall Length	337 mm
Probe Body Diameter	10 mm
Tip Length	9 mm
Tip Diameter	2.5 mm
Probe Tip to Sensor X Calibration Point	1 mm
Probe Tip to Sensor Y Calibration Point	1 mm
Probe Tip to Sensor Z Calibration Point	1 mm
Recommended Measurement Distance from Surface	2 mm