



**FCC CFR47 PART 15 SUBPART C
CERTIFICATION**

**CLASS II PERMISSIVE CHANGE
TEST REPORT**

FOR

MITSUMI ELECTRIC CO., LTD

EUT: WIRELESS ADAPTER FOR GAMEBOY ADVANCED

MODEL NUMBER: AGB-015

FCC ID: FCC ID: EW4-AGBWA

REPORT NUMBER: 04I2879-1

ISSUE DATE: JULY 30, 2004

Prepared for
MITSUMI ELECTRONIC CO., LTD
1601, SAKAI
ATSUGI
KANAGAWA 243-8533, JAPAN

Prepared by
COMPLIANCE CERTIFICATION SERVICES
561F MONTEREY ROAD,
MORGAN HILL, CA 95037, USA
TEL: (408) 463-0885
FAX: (408) 463-0888



TABLE OF CONTENTS

1. TEST RESULT CERTIFICATION	3
2. EUT DESCRIPTION	4
3. CLASS II PERMISSIVE CHANGE DESCRIPTION	4
4. TEST METHODOLOGY	4
5. FACILITIES AND ACCREDITATION	4
6. CALIBRATION AND UNCERTAINTY	5
6.1. <i>MEASURING INSTRUMENT CALIBRATION</i>	5
6.2. <i>MEASUREMENT UNCERTAINTY</i>	5
6.3. <i>TEST AND MEASUREMENT EQUIPMENT</i>	6
7. SETUP OF EQUIPMENT UNDER TEST	7
8. APPLICABLE LIMITS AND TEST RESULTS	9
8.1. <i>99% BANDWIDTH</i>	9
8.2. <i>Duty Cycle</i>	12
8.3. <i>RADIATED EMISSIONS</i>	15
8.3.1. <i>TRANSMITTER RADIATED SPURIOUS EMISSIONS</i>	15
8.3.2. <i>WORST-CASE RADIATED EMISSIONS BELOW 1 GHZ</i>	21
8.4. <i>POWERLINE CONDUCTED EMISSIONS</i>	23
9. SETUP PHOTOS	27

1. TEST RESULT CERTIFICATION

COMPANY NAME: MITSUMI ELECTRIC CO., LTD
1601, SAKAI
ATSUGI, KANAGAWA 243-8533, JAPAN

EUT DESCRIPTION: WIRELESS ADAPTER FOR GAMEBOY ADVANCED

MODEL: AGB-015

DATE TESTED: JULY 26, 2004 – JULY 28, 2004

APPLICABLE STANDARDS	
STANDARD	TEST RESULTS
FCC PART 15 SUBPART C	NO NON-COMPLIANCE NOTED

Compliance Certification Services, Inc. tested the above equipment in accordance with the requirements set forth in the above standards. The test results show that the equipment tested is capable of demonstrating compliance with the requirements as documented in this report.

Note: This document reports conditions under which testing was conducted and results of tests performed. This document may not be altered or revised in any way unless done so by Compliance Certification Services and all revisions are duly noted in the revisions section. Any alteration of this document not carried out by Compliance Certification Services will constitute fraud and shall nullify the document.

Approved & Released For CCS By:

Tested By:



THU CHAN
EMC SUPERVISOR
COMPLIANCE CERTIFICATION SERVICES

THANH NGUYEN
EMC TECHNICIAN
COMPLIANCE CERTIFICATION SERVICES

2. EUT DESCRIPTION

EUT Type	Wireless Adapter for Gameboy Advanced
Chassis Type	Plastic
Frequency Range	2426.248MHz and 2456.576MHz
Number of Channels	2
Channel Spacing	30.328MHz
Type of Modulation	ASK
Duty Cycle of Transmitter	6.82%
Antenna Type	Invert C
Antenna Gain	3.5dBi
No of External Connectors and Types	One; 6 pin plug
Power requirement	3.3 VDC

3. CLASS II PERMISSIVE CHANGE DESCRIPTION

This is a Class II permissive change for FCC ID: EW4-AGBWA, originally granted on 11/24/2003.

The major change filed under this application includes:

Change a component U70(MAX2644) to U72(BGA427).

4. TEST METHODOLOGY

The tests documented in this report were performed in accordance with ANSI C63.4/2001, FCC CFR 47 Part 2 and FCC CFR 47 Part 15.

5. FACILITIES AND ACCREDITATION

The open area test sites and conducted measurement facilities used to collect data are located at 561F Monterey Road, Morgan Hill, California, USA. The sites are constructed in conformance with the requirements of ANSI C63.4, ANSI C63.7 and CISPR Publication 22. All receiving equipment conforms to CISPR Publication 16-1, "Radio Interference Measuring Apparatus and Measurement Methods."

CCS is accredited by NVLAP, Laboratory Code 200065-0. The full scope of accreditation can be viewed at <http://www.ccsemc.com>.



No part of this report may be used to claim or imply product endorsement by NVLAP or any agency of the US Government.

6. CALIBRATION AND UNCERTAINTY

6.1. MEASURING INSTRUMENT CALIBRATION

The measuring equipment utilized to perform the tests documented in this report has been calibrated in accordance with the manufacturer's recommendations, and is traceable to recognized national standards.

6.2. MEASUREMENT UNCERTAINTY

Where relevant, the following measurement uncertainty levels have been estimated for tests performed on the apparatus:

Radiated Emission, 30 to 200 MHz	+/- 3.3 dB
Radiated Emission, 200 to 1000 MHz	+4.5 / -2.9 dB
Radiated Emission, 1000 to 2000 MHz	+4.5 / -2.9 dB
Power Line Conducted Emission	+/- 2.9 dB

Uncertainty figures are valid to a confidence level of 95%.

6.3. TEST AND MEASUREMENT EQUIPMENT

The following test and measurement equipment was utilized for the tests documented in this report:

TEST AND MEASUREMENT EQUIPMENT LIST				
Name of Equipment	Manufacturer	Model	Serial Number	Calibration Due Date
LISN, 10KHZ-30MHZ	Solar	8012-50-R-24-BNC	8379443	10/13/04
Line Filter	Linfren	LMF-3489	497	CNR
LISN, 10KHZ-30MHZ	FCC	50/250-25-2	114	10/13/04
EMI Test Receiver	R & S	ESHS-20	827129/006	4/17/05
Antenna, Horn 1-18GHz	EMCO	3115	2238	2/4/05
Preamplifier, 1300MHz	HP	8447D	2944A06833	8/22/04
Spectrum Analyzer	Agilent	E4440A	US41421507	5/8/05
RF Filter Section	HP	85420E	3705A00256	11/20/04
EMI Receiver, 9KHz-2.9GHz	HP	8542E	3942A00286	11/20/04
Antenna, Bilog, 25-2000MHz	ARA	LPB-2520A	1185	3/6/05
Preamplifier, 1-26GHz	Miteq	NSP2600-SP	924342	4/25/05

7. SETUP OF EQUIPMENT UNDER TEST

SUPPORT EQUIPMENT

PERIPHERAL SUPPORT EQUIPMENT LIST				
Device Type	Manufacturer	Model	Serial Number	FCC ID
AC Adapter	Mitsumi	AGB-009	N/A	N/A
Memory Card	Nintendo	N/A	N/A	N/A
Head Phone	WOODI	NA	N/A	N/A

I/O CABLES

Cable No.	Port	# of Identical Ports	Connector Type	Cable Type	Cable Length	Remarks
1	DC	1	DC	Shielded	2m	Bundled AC Cable for LC Test
2	Audio Out	1	Din	Un-Shielded	2m	Connected to head phones

TEST SETUP

The EUT is wireless adapter for gameboy advanced.

SETUP DIAGRAM FOR TESTS

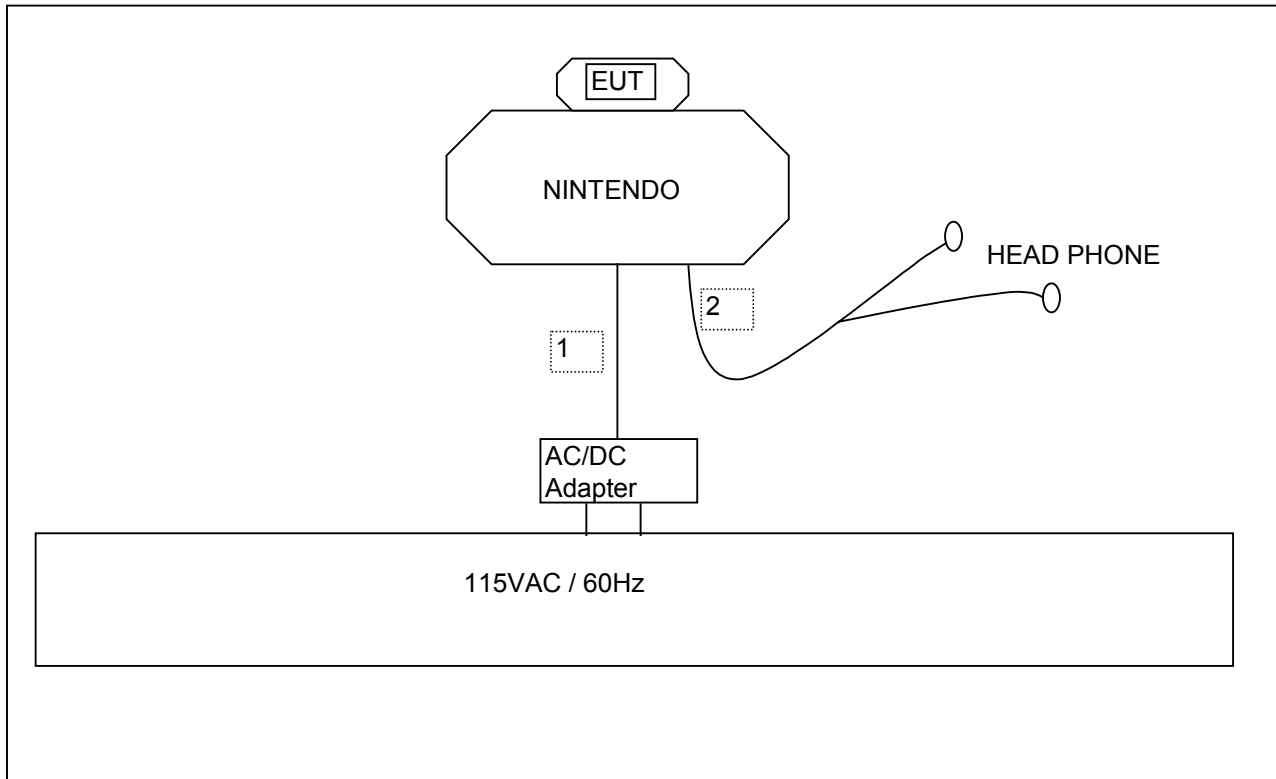

8. APPLICABLE LIMITS AND TEST RESULTS

8.1. 99% BANDWIDTH

LIMIT

None, for reporting purposes only.

TEST PROCEDURE

The transmitter output is connected to the spectrum analyzer. The RBW is set to 1% to 3% of the 99 % bandwidth. The VBW is set to 3 times the RBW. The sweep time is coupled. The spectrum analyzer internal 99% bandwidth function is utilized.

RESULTS

No non-compliance noted:

Channel	Frequency (MHz)	99% BW (MHz)
Low	2426.1	14.62926
High	2456	14.82966

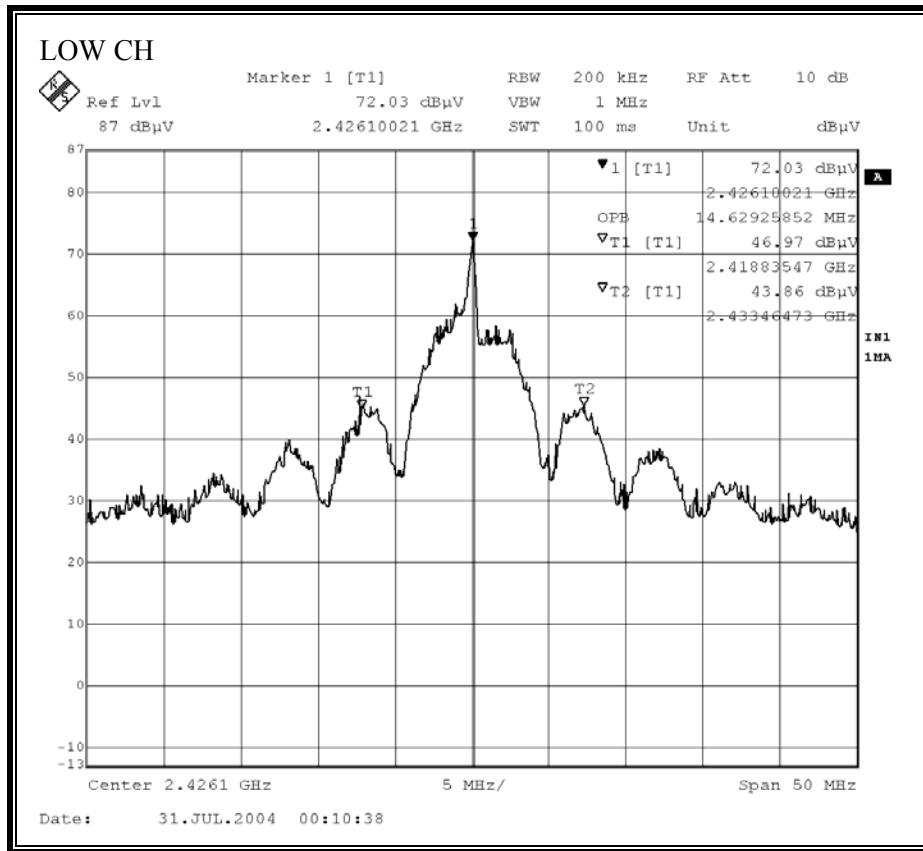

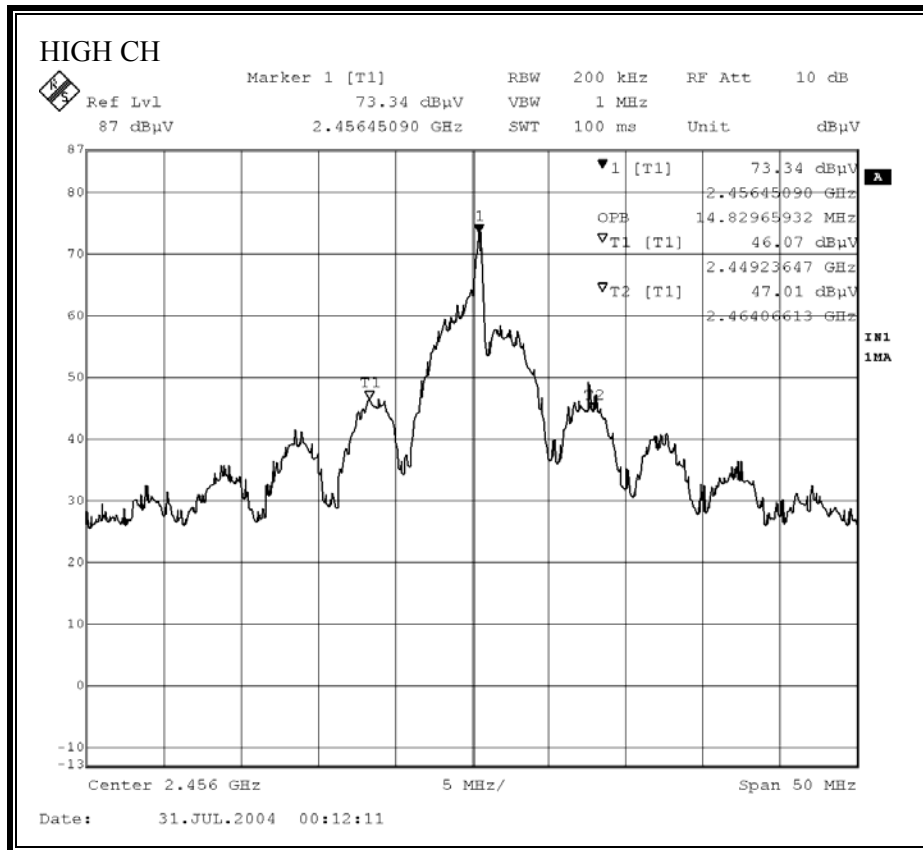

8.2. Duty Cycle

LIMIT

None, for reporting purposes only and a correction factor will apply to average readings.

TEST PROCEDURE

The transmitter output is connected to the spectrum analyzer. The sweep time is coupled and the span is set to 0Hz. The RBW & VBW is set to usual and enough to capture a good plot.

RESULTS

No non-compliance noted:

One Master Frame=2.42485msec
Master Frame is repeated continuously.

Transmit on = 165.43μs
 $165.43\mu\text{s}/2424.85\mu\text{s} = 0.0682 = 6.82\%$

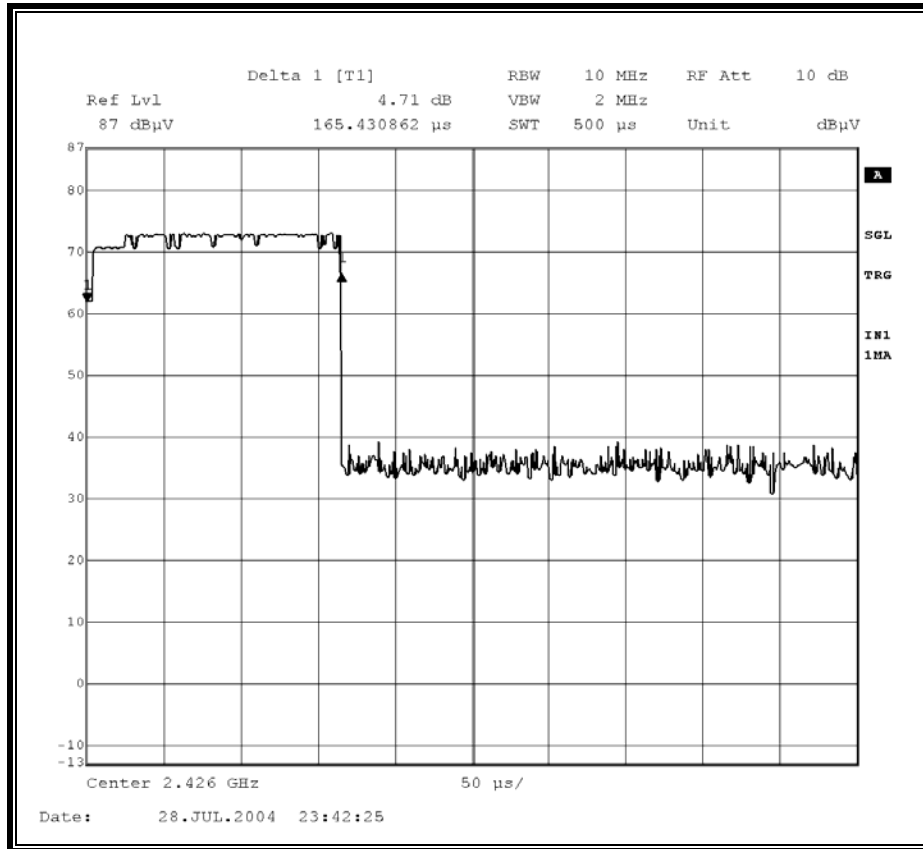

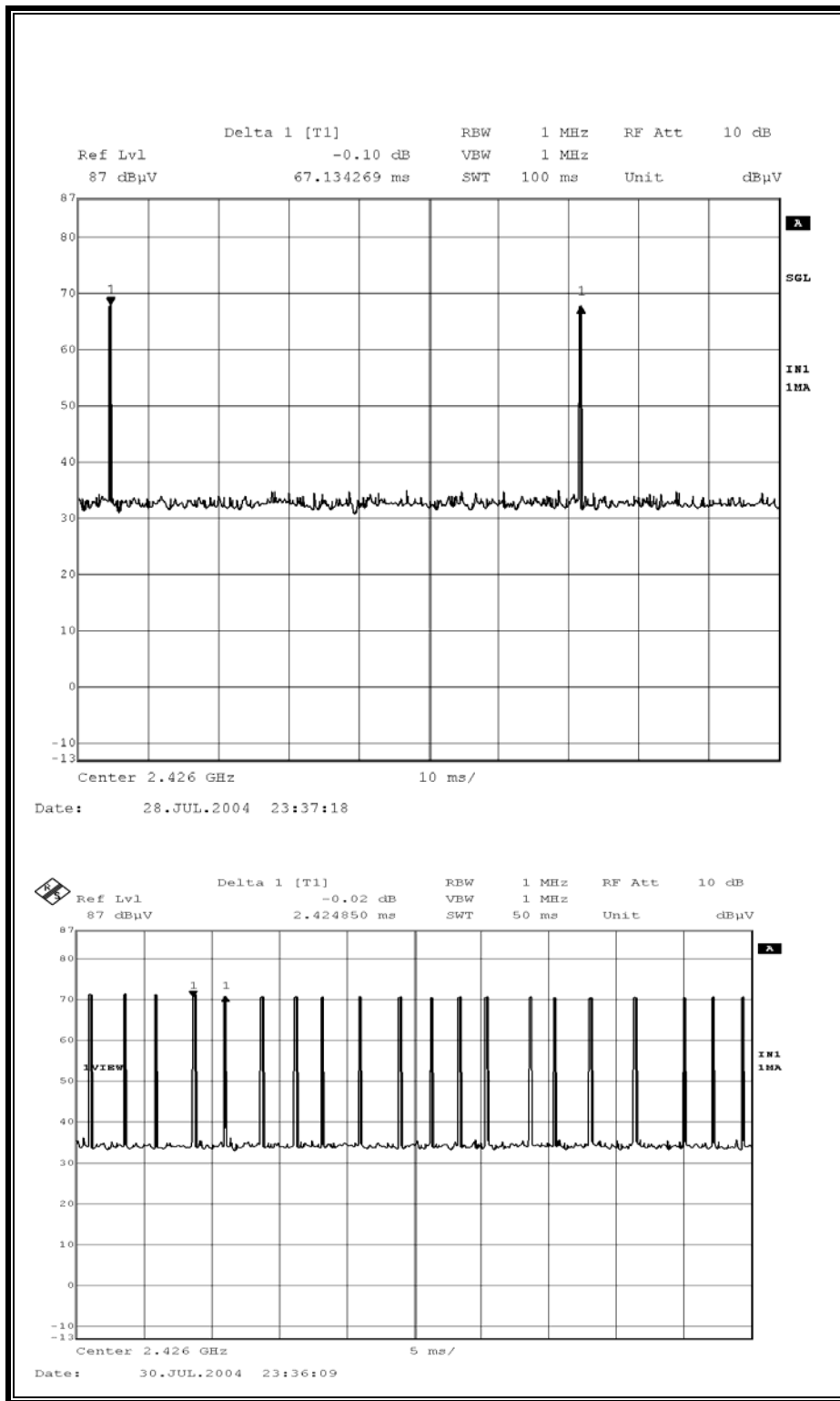

8.3. RADIATED EMISSIONS

8.3.1. TRANSMITTER RADIATED SPURIOUS EMISSIONS

LIMITS

The field strengths shall not exceed the following:

Fundamental Frequency	Field Strength of Fundamental (millivolts/meter)	Field Strength of Harmonics (microvolts/meter)
902 - 928 MHz	50	500
2400 - 2483.5 MHz	50	500
5725 - 5875 MHz	50	500
24.0 - 24.25 GHz	250	2500

Field strength limits are specified at a distance of 3 meters.

§15.205 (a) Except as shown in paragraph (d) of this section, only spurious emissions are permitted in any of the frequency bands listed below:

MHz	MHz	MHz	GHz
0.090 - 0.110	16.42 - 16.423	399.9 - 410	4.5 - 5.15
¹ 0.495 - 0.505	16.69475 - 16.69525	608 - 614	5.35 - 5.46
2.1735 - 2.1905	16.80425 - 16.80475	960 - 1240	7.25 - 7.75
4.125 - 4.128	25.5 - 25.67	1300 - 1427	8.025 - 8.5
4.17725 - 4.17775	37.5 - 38.25	1435 - 1626.5	9.0 - 9.2
4.20725 - 4.20775	73 - 74.6	1645.5 - 1646.5	9.3 - 9.5
6.215 - 6.218	74.8 - 75.2	1660 - 1710	10.6 - 12.7
6.26775 - 6.26825	108 - 121.94	1718.8 - 1722.2	13.25 - 13.4
6.31175 - 6.31225	123 - 138	2200 - 2300	14.47 - 14.5
8.291 - 8.294	149.9 - 150.05	2310 - 2390	15.35 - 16.2
8.362 - 8.366	156.52475 - 156.52525	2483.5 - 2500	17.7 - 21.4
8.37625 - 8.38675	156.7 - 156.9	2655 - 2900	22.01 - 23.12
8.41425 - 8.41475	162.0125 - 167.17	3260 - 3267	23.6 - 24.0
12.29 - 12.293	167.72 - 173.2	3332 - 3339	31.2 - 31.8
12.51975 - 12.52025	240 - 285	3345.8 - 3358	36.43 - 36.5
12.57675 - 12.57725	322 - 335.4	3600 - 4400	(²)
13.36 - 13.41			

¹ Until February 1, 1999, this restricted band shall be 0.490-0.510 MHz.

² Above 38.6

§15.205 (b) Except as provided in paragraphs (d) and (e), the field strength of emissions appearing within these frequency bands shall not exceed the limits shown in Section 15.209. At frequencies equal to or less than 1000 MHz, compliance with the limits in Section 15.209 shall be demonstrated using measurement instrumentation employing a CISPR quasi-peak detector. Above 1000 MHz, compliance with the emission limits in Section 15.209 shall be demonstrated based on the average value of the measured emissions. The provisions in Section 15.35 apply to these measurements.

§15.209 (a) Except as provided elsewhere in this Subpart, the emissions from an intentional radiator shall not exceed the field strength levels specified in the following table:

Frequency (MHz)	Field Strength (microvolts/meter)	Measurement Distance (meters)
30 - 88	100 **	3
88 - 216	150 **	3
216 - 960	200 **	3
Above 960	500	3

** Except as provided in paragraph (g), fundamental emissions from intentional radiators operating under this Section shall not be located in the frequency bands 54-72 MHz, 76-88 MHz, 174-216 MHz or 470-806 MHz. However, operation within these frequency bands is permitted under other sections of this Part, e.g., Sections 15.231 and 15.241.

§15.209 (b) In the emission table above, the tighter limit applies at the band edges.

TEST PROCEDURE

The EUT is placed on a non-conducting table 80 cm above the ground plane. The antenna to EUT distance is 3 meters. The EUT is configured in accordance with ANSI C63.4. The EUT is set to transmit in a continuous mode. The X, Y, and Z positions shall be tested and the worst case reported.

For measurements below 1 GHz the resolution bandwidth is set to 100 kHz for peak detection measurements or 120 kHz for quasi-peak detection measurements. Peak detection is used unless otherwise noted as quasi-peak.

For measurements above 1 GHz the resolution bandwidth is set to 1 MHz, then the video bandwidth is set to 1 MHz for peak measurements and 10 Hz for average measurements.

The spectrum from 30 MHz to 26 GHz is investigated with the transmitter set to the lowest, middle, and highest channels.

The frequency range of interest is monitored at a fixed antenna height and EUT azimuth. The EUT is rotated through 360 degrees to maximize emissions received. The antenna is scanned from 1 to 4 meters above the ground plane to further maximize the emission. Measurements are made with the antenna polarized in both the vertical and the horizontal positions.

RESULTS

No non-compliance noted:

NOTE: Worst Case Duty Cycle of 0.0682 or 6.82% (-23.32dB) is included to correct the peak reading to the average value of emissions.

Fundamental Measurement @ X, Y, & Z Positions:

07/27/04 High Frequency Measurement Compliance Certification Services, Morgan Hill Open Field Site																
Test Engr: Thanh Nguyen Project #: 04I2880-1 Company: NINTENDO EUT Descrip.: WIRELESS ADAPTER FOR GAMEBOY ADVANCED EUT M/N: AGB-015 Test Target: FCC 249 Mode Oper: TX_Modulation mode_X,Y,Z Position																
Test Equipment:																
EMCO Horn 1-18GHz		Spectrum Analyzer		Pre-amplifier 1-26GHz		Pre-amplifier 26-40GHz		Horn >18GHz								
T119; S/N: 29301 @3m		Agilent E4446A Analyzer														
Hi Frequency Cables																
<input type="checkbox"/> (2 ft)		<input type="checkbox"/> (2 ~ 3 ft)		<input type="checkbox"/> (4 ~ 6 ft)		<input checked="" type="checkbox"/> (12 ft)		Peak Measurements: 1 MHz Resolution Bandwidth 1MHz Video Bandwidth				Average Measurements: 1 MHz Resolution Bandwidth 10Hz Video Bandwidth				
f GHz	Dist feet	Read Pk dBuV	Read Avg. dBuV	AF dB/m	CL dB	Amp dB	D Corr dB	HPF	Peak dBuV/m	Avg dBuV/m	Pk Lim dBuV/m	Avg Lim dBuV/m	Pk Mar dB	Avg Mar dB	Notes	
Y Position																
LOW 2426MHz																
2.426	9.8	68.9	48.9	32.9	1.8	0.0	0.0	0.0	103.6	83.6	114.0	94.0	-10.4	-10.4	V	
2.426	9.8	67.3	47.3	32.9	1.8	0.0	0.0	0.0	101.9	81.9	114.0	94.0	-12.1	-12.1	H	
High 2456MHz																
2.456	9.8	66.8	46.8	32.9	1.9	0.0	0.0	0.0	101.5	81.5	114.0	94.0	-12.5	-12.5	V	
2.456	9.8	63.4	43.4	32.9	1.9	0.0	0.0	0.0	98.1	78.1	114.0	94.0	-15.9	-15.9	H	
X Position																
High 2456MHz																
2.426	9.8	55.7	35.7	32.9	1.8	0.0	0.0	0.0	90.4	70.4	114.0	94.0	-23.6	-23.6	V	
2.426	9.8	66.8	46.8	32.9	1.8	0.0	0.0	0.0	101.5	81.5	114.0	94.0	-12.5	-12.5	H	
LOW 2426MHz																
2.426	9.8	60.6	40.6	32.9	1.8	0.0	0.0	0.0	95.3	75.3	114.0	94.0	-18.7	-18.7	V	
2.426	9.8	66.6	46.6	32.9	1.8	0.0	0.0	0.0	101.2	81.2	114.0	94.0	-12.8	-12.8	H	
Z Position																
LOW 2426MHz																
2.426	9.8	67.6	47.6	32.9	1.8	0.0	0.0	0.0	102.3	82.3	114.0	94.0	-11.7	-11.7	V	
2.426	9.8	63.8	43.8	32.9	1.8	0.0	0.0	0.0	98.4	78.4	114.0	94.0	-15.6	-15.6	V	
High 2456MHz																
2.456	9.8	65.2	45.2	32.9	1.9	0.0	0.0	0.0	99.9	79.9	114.0	94.0	-14.1	-14.1	V	
2.456	9.8	62.8	42.8	32.9	1.9	0.0	0.0	0.0	97.5	77.5	114.0	94.0	-16.5	-16.5	V	
NOTE: The maximum duty cycle = -20dB is included to correct the peak reading to the average value of emissions.																
f	Measurement Frequency			Amp	Preamp Gain			Avg Lim	Average Field Strength Limit							
Dist	Distance to Antenna			D Corr	Distance Correct to 3 meters			Pk Lim	Peak Field Strength Limit							
Read	Analyzer Reading			Avg	Average Field Strength @ 3 m			Avg Mar	Margin vs. Average Limit							
AF	Antenna Factor			Peak	Calculated Peak Field Strength			Pk Mar	Margin vs. Peak Limit							
CL	Cable Loss			HPF	High Pass Filter											

HARMONICS AND SPURIOUS EMISSIONS

07/27/04 **High Frequency Measurement**
 Compliance Certification Services, Morgan Hill Open Field Site

Test Engr: Thanh Nguyen
 Project #: 04I2880-1
 Company: NINTENDO
 EUT Descip.: WIRELESS ADAPTER FOR GAMEBOY ADVANCED
 EUT M/N: AGB-015 (2nd Class II Change)
 Test Target: FCC 249
 Mode Oper: TX_Modulated Y Position Low and High Frequencies, Harmonics and Spurious Emissions

Test Equipment:

EMCO Horn 1-18GHz T119; S/N: 29301 @3m	Spectrum Analyzer Agilent E4446A Analyzer	Pre-amplifer 1-26GHz T63 Miteq 646456	Pre-amplifer 26-40GHz	Horn > 18GHz
---	--	--	-----------------------	--------------

Hi Frequency Cables
 (2 ft) (2 ~ 3 ft) (4 ~ 6 ft) (12 ft)

Peak Measurements:
 1 MHz Resolution Bandwidth
 1MHz Video Bandwidth

Average Measurements:
 1 MHz Resolution Bandwidth
 10Hz Video Bandwidth

f GHz	Dist feet	Read Pk dBuV	Read Avg. dBuV	AF dB/m	CL dB	Amp dB	D Corr dB	HPF	Peak dBuV/m	Avg dBuV/m	Pk Lim dBuV/m	Avg Lim dBuV/m	Pk Mar dB	Avg Mar dB	Notes
Y Position															
LOW 2426MHz															
4.852	9.8	51.3	31.3	35.0	3.2	-35.3	0.0	1.0	55.1	35.1	74.0	54.0	-18.9	-18.9	V
4.852	9.8	56.3	36.3	35.0	3.2	-35.3	0.0	1.0	60.1	40.1	74.0	54.0	-13.9	-13.9	H
7.277	9.8	47.3	27.3	36.7	3.9	-34.6	0.0	1.0	54.2	34.2	74.0	54.0	-19.8	-19.8	H
7.277	9.8	51.8	31.8	36.7	3.9	-34.6	0.0	1.0	58.7	38.7	74.0	54.0	-15.3	-15.3	H
9.705	9.8	42.9	22.9	37.9	4.5	-33.3	0.0	1.0	53.0	33.0	74.0	54.0	-21.0	-21.0	Noise floor
High 2456MHz															
4.913	9.8	54.6	34.6	35.0	3.2	-35.3	0.0	1.0	58.5	38.5	74.0	54.0	-15.5	-15.5	V
4.913	9.8	62.5	42.5	35.0	3.2	-35.3	0.0	1.0	66.4	46.4	74.0	54.0	-7.6	-7.6	H
7.367	9.8	45.8	25.8	36.7	3.9	-34.5	0.0	1.0	52.8	32.8	74.0	54.0	-21.2	-21.2	V
7.367	9.8	60.2	40.2	36.7	3.9	-34.5	0.0	1.0	67.2	47.2	74.0	54.0	-6.8	-6.8	H
9.824	9.8	41.9	21.9	38.0	4.6	-33.4	0.0	1.0	52.1	32.1	74.0	54.0	-21.9	-21.9	Noise floor
NOTE: The maximum duty cycle = -20dB is included to correct the peak reading to the average value of emissions.															
f	Measurement Frequency		Amp	Preamp Gain		Avg Lim	Average Field Strength Limit								
Dist	Distance to Antenna		D Corr	Distance Correct to 3 meters		Pk Lim	Peak Field Strength Limit								
Read	Analyzer Reading		Avg	Average Field Strength @ 3 m		Avg Mar	Margin vs. Average Limit								
AF	Antenna Factor		Peak	Calculated Peak Field Strength		Pk Mar	Margin vs. Peak Limit								
CL	Cable Loss		HPF	High Pass Filter											

8.3.2. WORST-CASE RADIATED EMISSIONS BELOW 1 GHZ

SPURIOUS EMISSIONS 30 TO 1000 MHz (WORST-CASE CONFIGURATION, HORIZONTAL)

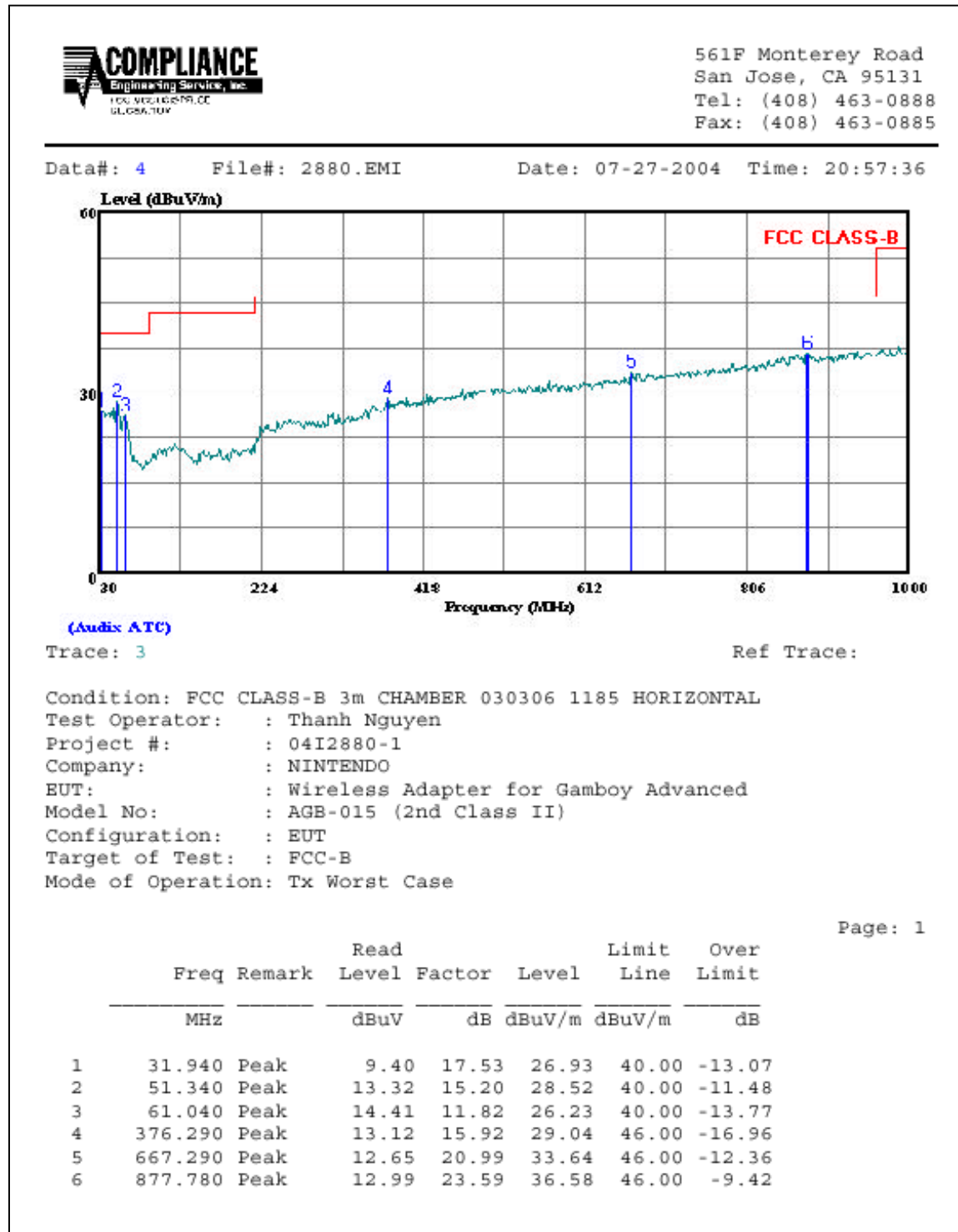

SPURIOUS EMISSIONS 30 TO 1000 MHz (WORST-CASE CONFIGURATION, VERTICAL)

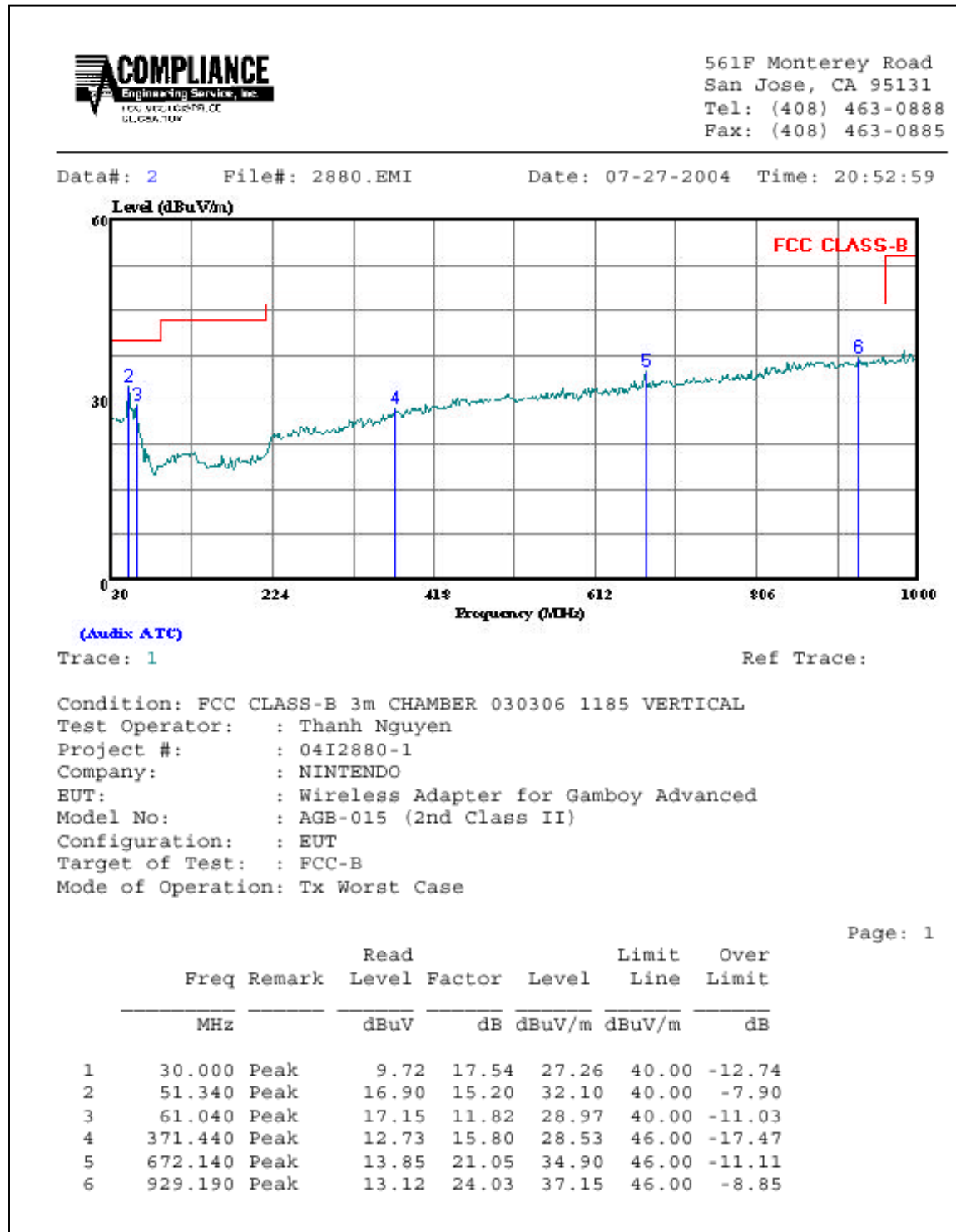

8.4. POWERLINE CONDUCTED EMISSIONS

LIMIT

§15.207 (a) Except as shown in paragraphs (b) and (c) of this section, for an intentional radiator that is designed to be connected to the public utility (AC) power line, the radio frequency voltage that is conducted back onto the AC power line on any frequency or frequencies within the band 150 kHz to 30 MHz shall not exceed the limits in the following table, as measured using a 50 μ H/50 ohms line impedance stabilization network (LISN). Compliance with the provisions of this paragraph shall be based on the measurement of the radio frequency voltage between each power line and ground at the power terminal.

The lower limit applies at the boundary between the frequency ranges.

Frequency of Emission (MHz)	Conducted Limit (dBuV)	
	Quasi-peak	Average
0.15-0.5	66 to 56*	56 to 46*
0.5-5	56	46
5-30	60	50

*Decreases with the logarithm of the frequency.

TEST PROCEDURE

The EUT is placed on a non-conducting table 40 cm from the vertical ground plane and 80 cm above the horizontal ground plane. The EUT is configured in accordance with ANSI C63.4.

The resolution bandwidth is set to 9 kHz for both peak detection and quasi-peak detection measurements. Peak detection is used unless otherwise noted as quasi-peak.

Line conducted data is recorded for both NEUTRAL and HOT lines.

RESULTS

No non-compliance noted:

6 WORST EMISSIONS

CONDUCTED EMISSIONS DATA (115VAC 60Hz)									
Freq.	Reading			Closs	Limit	EN B	Margin		Remark
(MHz)	PK (dBuV)	QP (dBuV)	AV (dBuV)	(dB)	QP	AV	QP (dB)	AV (dB)	L1 / L2
0.19	51.30	--	41.69	0.00	64.86	54.86	-13.56	-13.17	L1
0.58	40.52	--	35.03	0.00	56.00	46.00	-15.48	-10.97	L1
3.09	35.62	--	8.21	0.00	56.00	46.00	-20.38	-37.79	L1
0.19	48.32	--	45.24	0.00	64.77	54.77	-16.45	-9.53	L2
0.39	40.42	--	37.64	0.00	59.23	49.23	-18.81	-11.59	L2
1.73	36.38	--	23.87	0.00	56.00	46.00	-19.62	-22.13	L2
6 Worst Data									

LINE 1 RESULTS

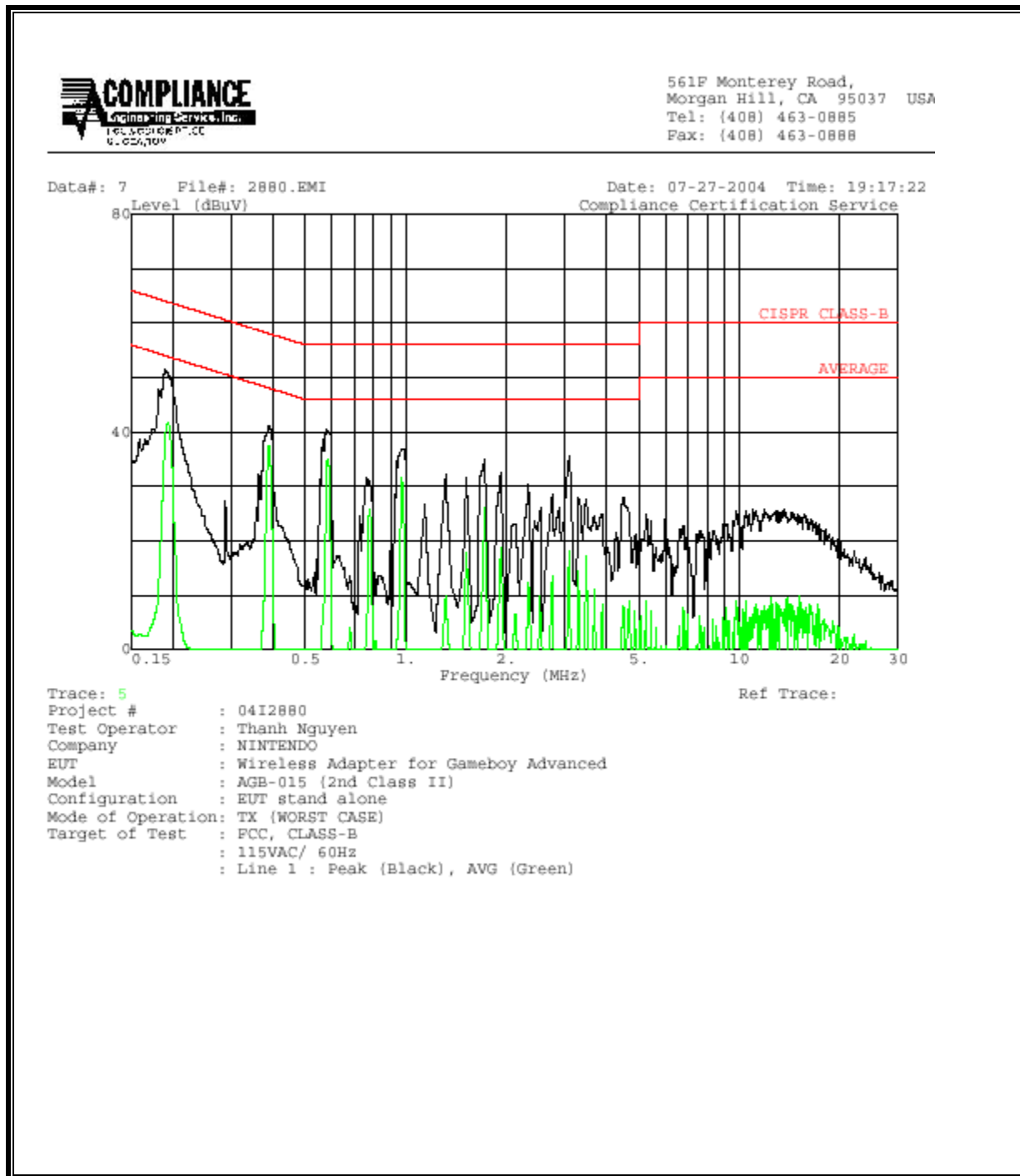

LINE 2 RESULTS

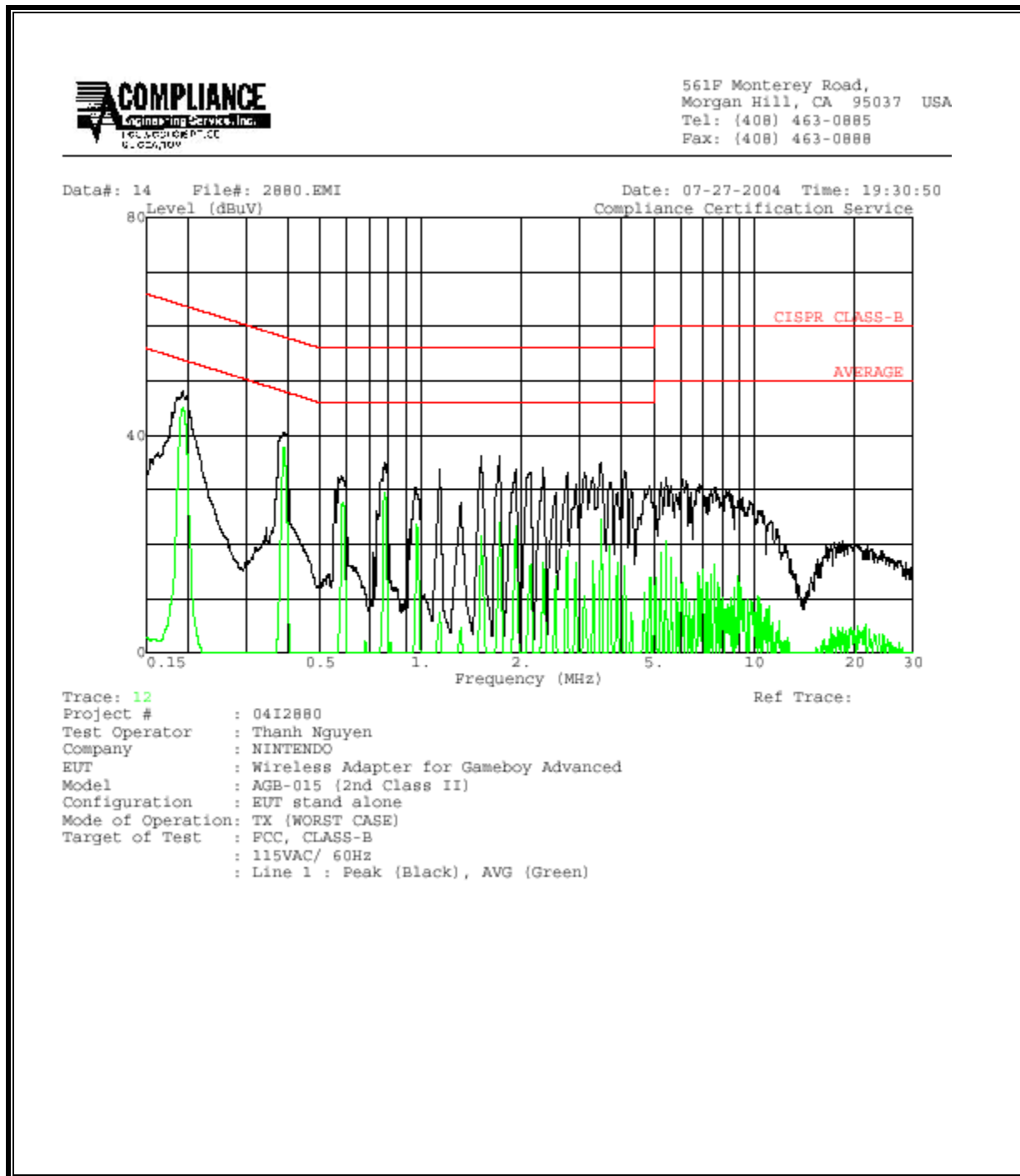

9. SETUP PHOTOS

RF MEASUREMENT SETUP



EUT Y POSITION



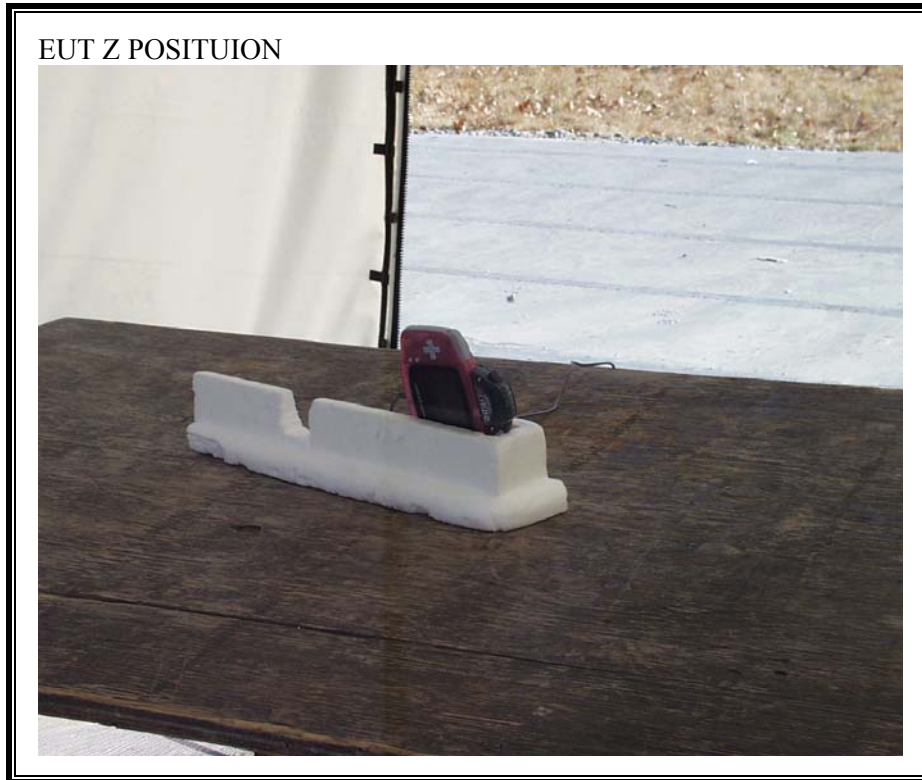

RADIATED EMISSIONS SETUP

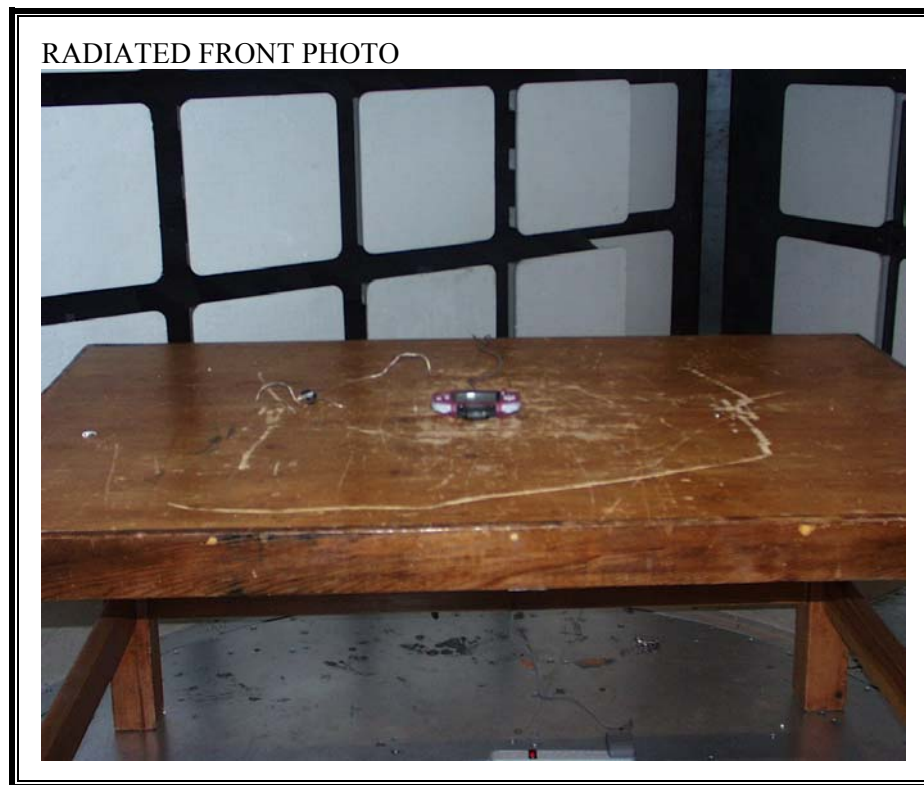



POWERLINE CONDUCTED EMISSIONS MEASUREMENT SETUP





END OF REPORT