

APPENDIX H
: USER'S MANUAL

LCD TV

LCD TV 32" 42"

User's Manual



KDS
Korea Data Systems



Safety Instructions

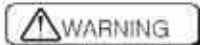

◆ Indoor Installation

- 1) Do not place the TV in direct sunlight or near heat sources such as radiators, fires and stove etc.
- 2) The violation of this instruction may cause serious injuries and even death.

◆ Outdoor Installation

- 1) Do not use the TV in a damp place such as a bathroom where it is likely to get wet.
- 2) In case of using a receiver(VCR, DVD), do not place an antenna in the vicinity of power lines.
- 3) In case of using a receiver(VCR, DVD), contact your service center to construct an antenna because it needs skilled man.
- 4) In case of using a receiver(VCR, DVD), bend antenna cable between inside and outside building to prevent rain from flowing in.

◆ Power

- 1) Earth wire should be connected.
 - If the earth wire is not connected, there is possible a danger of electric shock caused by the current leakage.
 - Do not connect ground to telephone wires, lightning rods or gas pipe.
- 2) The main plug should be inserted fully into the power outlet to avoid a fire hazard!

◆ Using

- 1) Do not place anything containing liquid on top of the TV such as flowerpot, cup, cosmetics or candle.
- 2) If water is spilt into the monitor unplug it from the main supply outlet immediately and consult your Service Agent.
- 3) Dispose of used batteries carefully and safely.
 - In the case of a battery being swallowed by a child please consult a doctor immediately.
- 4) In the event that an image does not appear on the screen please switch it off and unplug it from the main supply and contact your Service center.

◆ Cleaning

- 1) Do not use water while cleaning the TV.
- 2) In the unlikely event of smoke or a strange smell from the TV, switch it off, unplug it from the wall outlet and contact your dealer or service center.

◆ Others

- 1) Do not attempt to service the TV yourself. Contact your dealer or service center.
- 2) In the event of a lightning or thunder storm unplug the TV and aerial from the wall outlet.



Safety Instructions

NOTES

◆ Indoor Installation

- 1) Do not place inflammable materials beside the TV.
- 2) When unpacking or moving the TV two people will be necessary to lift it safely.
- 3) Do not place the TV where it might be exposed to dust.
- 4) Ensure good ventilation around the TV.
The distance between the TV and the wall should be more than 10cm.
- 5) Disconnect from the main and remove all connections before moving.
- 6) Do not place the TV close to sources of steam or oil such as a humidifier.
- 7) When installing the monitor on a table, be careful not to place it near the edge.
- 8) Only use the TV on a level and stable surface.
- 9) Do not place the TV directly on a carpet, rug or place where ventilation is restricted.

◆ Outdoor Installation

- 1) In case of using a receiver(VCR, DVD), there should be enough distance between an outside antenna and power lines to keep the former from touching the latter even when the antenna falls.

◆ Power

- 1) Hold the plug firmly when unplugging.
If you pull the cord the cord may be damaged.
- 2) Prevent dust collecting on the power plug pins or outlet.
- 3) Do not place heavy objects on the power cord.
- 4) Do not use too many plugs on the main multi-outlet.
- 5) Never touch the power plug with a wet hand.
- 6) Ensure the power cord does not come into contact with sharp or hot objects such as a heater.

◆ Using

- 1) In case of impact shock or damage to the monitor switch it off and unplug it from the outlet and contact your service center.
- 2) Do not allow any objects to fall into the TV.
- 3) Do not place heavy objects on the TV.

◆ Indoor Installation

- 1) Unplug this product from the wall outlet before cleaning. Do not use liquid cleaners or aerosol cleaners.
- 2) Contact the service center once a year to clean the internal part of the TV.

◆ Others

- 1) Unplug the TV from the wall outlet when it is left unattended and unused for long periods of time.
- 2) Only use the specified batteries.

Important Safety Instructions

Shock Hazard Marking and Associated Graphical Symbols



Explanation of Safety Related Symbols



This symbol is intended to alert the user to the presence of uninsulated "dangerous voltage" within the product's enclosure that may be of sufficient magnitude to constitute a risk of electric shock to persons.



This symbol is intended to alert the user to the presence of important operating and maintenance(servicing) instructions in the literature accompanying the appliance.

WARNING : To Reduce risk of fire or electric shock, do not expose this the TV to rain or moisture.

This equipment has been tested and found to comply with the limits for a Class B digital device, pursuant to Part 15 of the FCC Rules. These limits are designed to provide reasonable protection against harmful interference in a residential installation. The equipment generates, uses and can radiate radio frequency energy and, if not installed and used in accordance with the instructions, may cause harmful interference to radio communications. However, there is no guarantee that interference will not occur in a particular installation. If this equipment does not cause harmful interference to radio or television reception which can be determined by turning the equipment off and on, the user is encouraged to try to correct the interference by one or more of the following measures;

- Reorient or relocate the receiving antenna
- Increase the separation between the equipment and receiver
- Connect the equipment into an outlet on a circuit different from that to which the receiver is connected

Caution

Changes or modification not expressly approved by the party responsible for Compliance could void the user's authority to operate the equipmet.



Important Safety Instructions

- 1) Read these instructions.
- 2) Keep these instructions.
- 3) Heed all warnings.
- 4) Follow all instructions.
- 5) Do not use this apparatus near water.
- 6) Clean only with a dry cloth.
- 7) Do not block any of the ventilation openings. Install in accordance with the manufacturer's instructions.
- 8) Do not install near any heat sources such as radiators, heat registers, stoves, or other apparatus (including amplifiers) that produce heat.
- 9) Do not defeat the safety purpose of the polarized or grounding type plug. A polarized plug has two blades with one wider than the other. A grounding type plug has two blades and a third grounding prong. The wide blade or the third prong is provided for your safety. When the provided plug does not fit into your outlet, consult an electrician for replacement of the obsolete outlet.
- 10) Protect the power cord from being walked on or pinched particularly at plugs, convenience receptacles, and the point where they exit from the apparatus.
- 11) Only use the attachments/accessories specified by the manufacturer.
- 12) Use only with a cart, stand, tripod, bracket, or table specified by the manufacturer, or sold with the apparatus. When a cart is used, use caution when moving the cart/apparatus combination to avoid injury from tip-over.



- 13) Unplug this apparatus during lightning storms or when unused for long periods of time.
 - 14) Refer all servicing to qualified service personnel. Servicing is required when the apparatus has been damaged in any way, such as power supply cord or plug is damaged, liquid has been spilled or objects have fallen into the apparatus, the apparatus has been exposed to rain or moisture, does not operate normally, or has been dropped.
-

Contents

Safety Instructions	i
Important Safety Instructions	ii
Accessories	6
Local Key Controls(32")	7
Local Key Controls(42")	8
Connection Panel Overview	9
Remote Control	10
Remote Control Key Functions	11
VCR Setup	12
DVD Setup	13
I. TV Menu Options	
Ch. Scan (Channel Search)	14
Ch. Edit (Channel Edit)	15
Manual Add	16
Main Input	16
Sub Input	17
II. Picture Menu Options	
Picture	18
User Control	18
Color Temperature Control	19
Aspect Ratio	19
Video Recall	20
PC Menu	20
III. Sound Menu Options	
Audio Language	21
Digital Audio Output	21
Sound Mode	22
User Control	22
IV. Setup Menu Options	
DTV Caption	23
DTV Caption Style	23
Analog Caption	25
Menu Language	26
Clock	26
On Time	27
Off Time	28
Auto Off	28
V. Lock (Parental Control) Menu Options	
Lock System	29
Set Password	29
Block Ch. (Channel)	30
Movie Rating (MPPA)	30
TV Rating-Children	33
TV Rating-General	35
VI. Picture in Picture(PIP) function	
Picture in Picture(PIP) function	37
Twin picture function	38
Picture in Picture(SWAP) function	38
Supportable Timings	39
Troubleshooting	40
Product Specifications	41

Accessories

Accessories



Remote Control



User's Manual

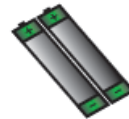

Batteries



A/V cable

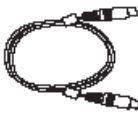

Antenna cable



D-sub 15 pin cable



Power cord



Audio cable

Option

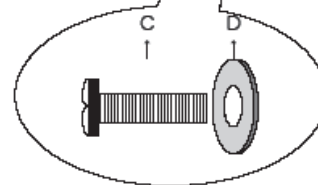
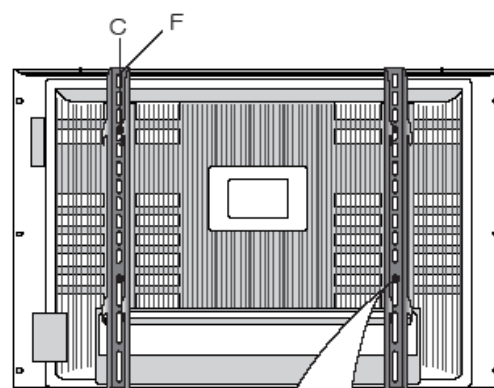
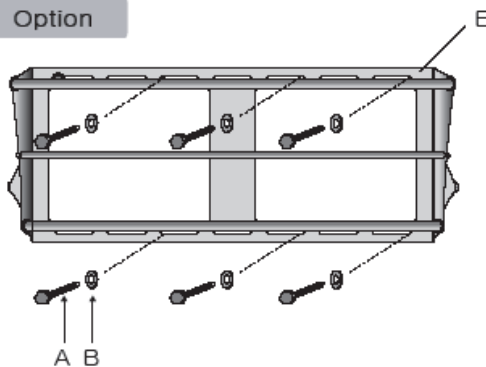

[Wall Mount Part List]

A	x6 Lead Anchor	C	x4 M5x12 Bolt
	x6 Lead Drywall Screw	D	x4 M5/M12 Washer
B	x6 Washer	E	BKT'
		F	x2 BKT'

Wall Mount is not supplied in default. Since our product is designed for being usable for wall-mount type, we strongly recommend, when customer opts to take wall-mount type model after purchasing it, to qualified engineer to be assigned for installing the product to ConcreteWall. Be advisable to use standard material for installation because discretionary installation of customer might cause safety issues.

Local Key Controls(32")

<LOCAL KEY Controls>



< Type A >

Ⓐ Ⓑ



< Type B >

Ⓐ Ⓑ

Ⓐ Remote control sensor

Ⓑ Power Standby indicator

Illuminates RED in stand-by mode, Illuminates green when the TV is turned on.



①CH - : Selects a program or menu item

②CH + : Selects a program or menu item

③VOL - : Adjusts the volume / Adjusts menu settings

④VOL + : Adjusts the volume / Adjusts menu settings

⑤SOURCE : Selects the A/V source

⑥MENU : Display a menu

⑦POWER : Switches TV set on or off

Local Key Controls(42")

<LOCAL KEY Controls>

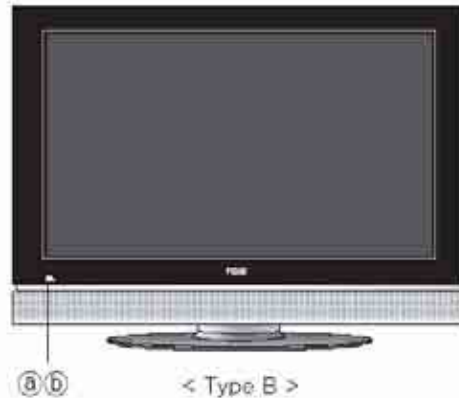
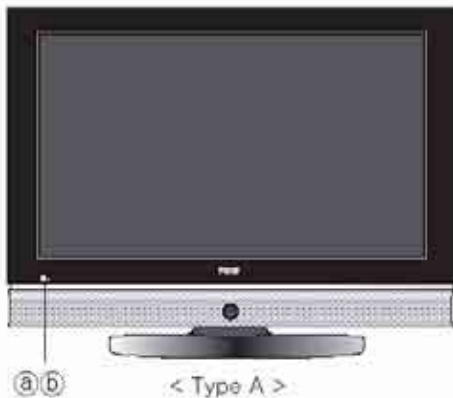

⑧ Remote control sensor

⑨ Power Standby indicator
Illuminates RED in stand-
by mode. Illuminates green
when the TV is turned on.

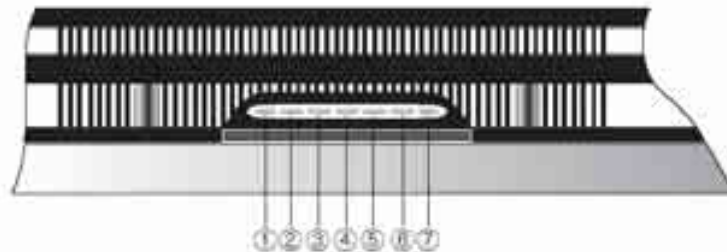

①POWER : Switches TV set on or off

②MENU : Display a menu

③SOURCE : Selects the A/V source

④VOL + : Adjusts the volume / Adjusts menu settings

⑤VOL - : Adjusts the volume / Adjusts menu settings

⑥CH + : Selects a program or menu item

⑦CH - : Selects a program or menu item.

Connection Panel Overview

<Back Panel>

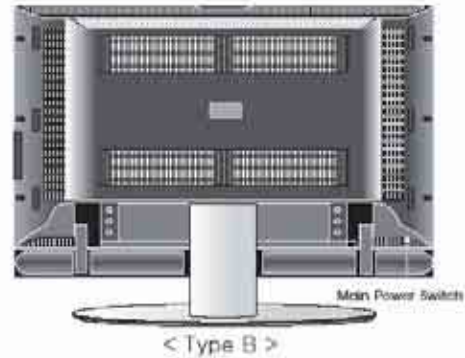
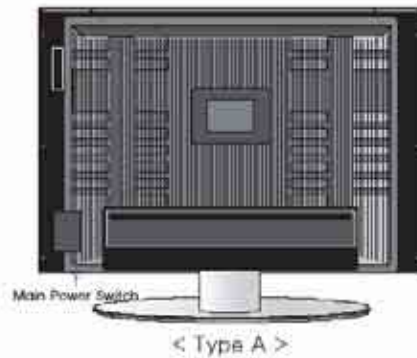

1. POWER : AC power input terminal
2. HDMI1 IN: High definition multimedia interface
3. HDMI2 IN : High definition multimedia interface
4. PC IN : Input terminal of simulation signal of PC
5. Component 1 : Input the Component video signal
6. AV OUT : Composite output of A/V source
7. S-VIDEO IN : Connect the output of the A/V source to the S-VIDEO input
8. VIDEO IN : Composite input of A/V source
9. Audio OUT : Output Sound
10. Audio IN : Input the PC sound
11. Optical : Output the Digital sound
12. RS232 : Being used when designing and repairing, and upgrading program
13. Component 2 : Input the Component video signal
14. VHF/UHF : RF Antenna Input

Remote Control

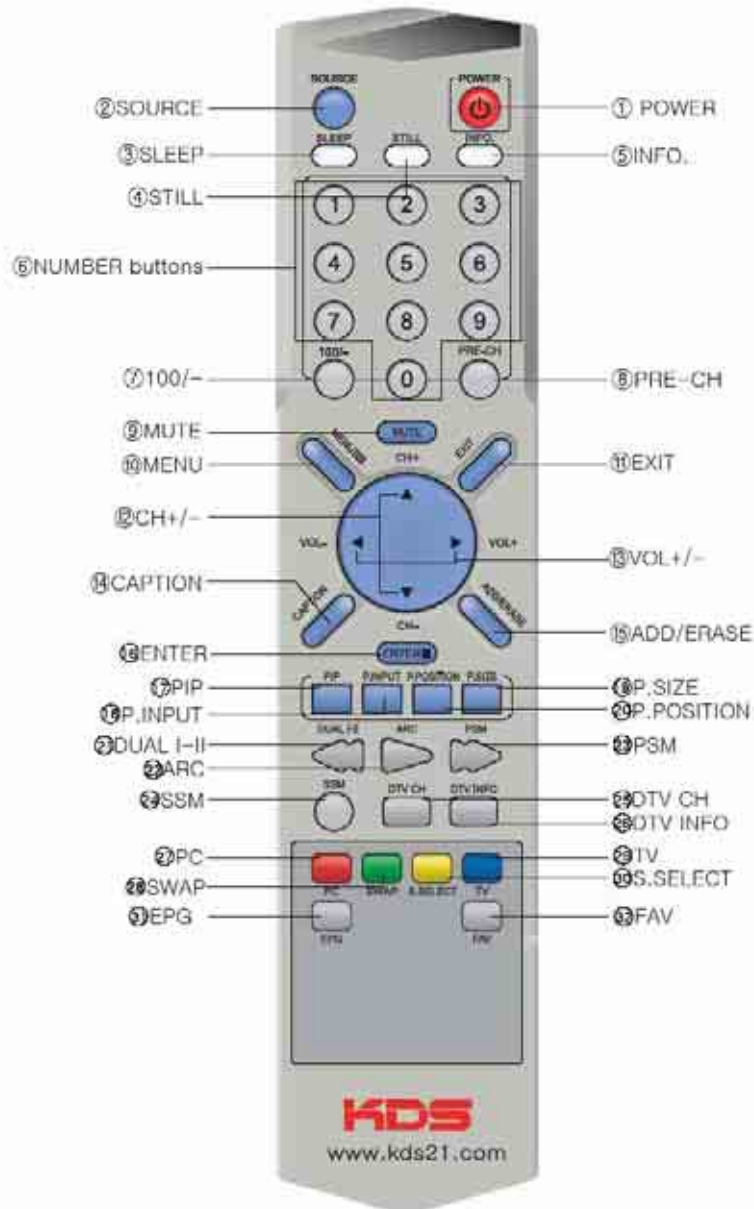

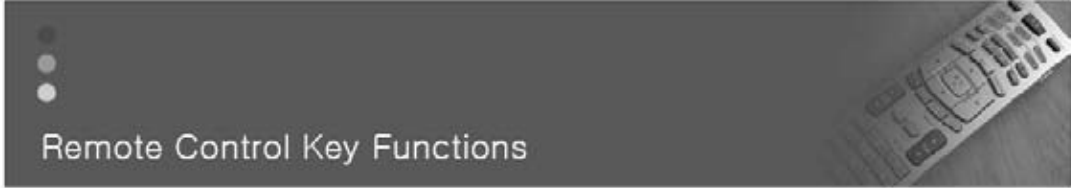

Remote Control Key Functions

When using the remote control aim it at the remote control sensor on the TV.

- 1. POWER**
Turns the TV on from standby or off to standby mode.
- 2. SOURCE**
Selects ATSC, NTSC, HDMI1, HDMI2, Component1, Component2, RGB, Video, S-Video mode.
- 3. SLEEP**
Sets the sleep timer.
- 4. STILL**
Displays the still main picture.
- 5. INFO.**
Displays input source information.
- 6. NUMBER buttons**
Selects program numbers.
- 7. 100/-**
Channel selection button, which allows the customer to select more than 100 TV channels.
- 8. PRE-CH**
Returns to the previously viewed program.
- 9. MUTE**
Turns the sound on or off.
- 10. MENU**
Displays a main menu.
- 11. EXIT**
Exit OSD previous layer.
- 12. CH+/-**
Selects next program or menu item.
- 13. VOL+/-**
Adjusts the sound level./ Adjusts the menu settings.
- 14. CAPTION**
If current input is Video/TV, display the caption and change the caption mode.
- 15. ADD/ERASE**
TV channel add or erase.
- 16. ENTER**
Select the menu functions.
- 17. PIP**
PIP on/off button, which allows the customer to turn on/off the PIP function of TV.
- 18. P.INPUT**
Changes PIP input sources.
- 19. P.SIZE**
Changes PIP image size.
- 20. P.POSITION**
Changes PIP image position.
- 21. DUAL I-II**
Activates/Deactivates OSD of sound format.
- 22. ARC**
Activates/Deactivates OSD of aspect ratio control.
- 23. PSM(Picture Standard Mode)**
Activates/Deactivates picture standard mode.
- 24. SSM(Sound Standard Mode)**
Activates/Deactivates OSD of sound standard.
- 25. DTV CH**
Analog TV or Digital TV source change
- 26. DTV INFO**
Digital TV signal strength
- 27. PC**
Selects input source of PC.
- 28. SWAP**
Swaps main input source and PIP input source.
- 29. TV**
Selects input source of TV.
- 30. S.SELECT**
Selects main and PIP sound source.
- 31. EPG**
Electronic Program Guide
- 32. FAV**
Favorite channel hot key

VCR Setup

- ▶ Connect an antenna or a coaxial cable between the ANTENNA jack on the rear of the TV and the ANTENNA OUT jack on the VCR.
- ▶ Connect the RCA jack of the VCR to the Video Jack of the set.
- ▶ Press the PLAY button on the VCR.
- ▶ When connecting the S-VIDEO VCR to the S-VIDEO socket, the picture quality will be further improved.
- ▶ Connect the S-video socket of the VCR to the S-VIDEO socket of the set.
- ▶ Connect the audio cable from the S-VIDEO VCR to the AUDIO sockets of the set.
- ▶ Select the S-VIDEO by pressing the SOURCE button repeatedly.
- ▶ Press the PLAY button on the VCR. The VCR playback picture appears on the screen.

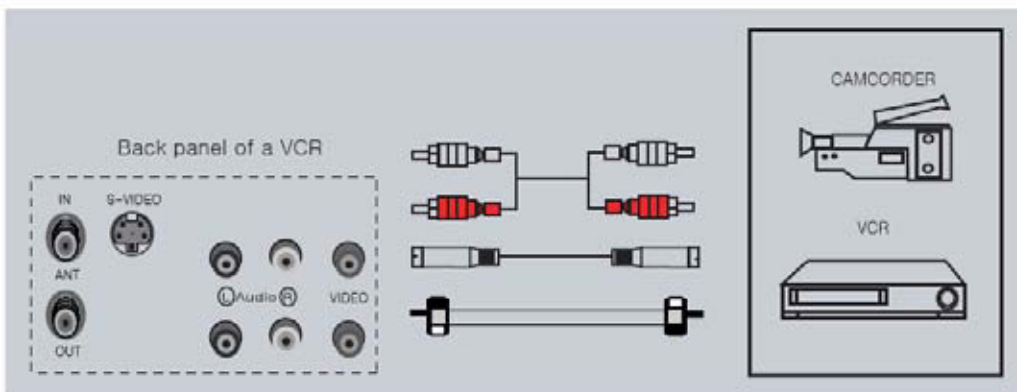

1. Press SOURCE button on the remote control and select Video or S-Video.
2. Insert a video tape into the VCR and press the PLAY button on the VCR.
See VCR owner's manual.

Tips

To avoid picture noise(interference), leave an adequate distance (20 inches or more) between the VCR and TV.

DVD Setup

How to connect a DVD(Digital Video Disk player)

- ▶ Connect DVD video inputs to Component1 or Component2.
- ▶ Component input is available to 480/576i, 480/576p, 720p, 1080i mode.

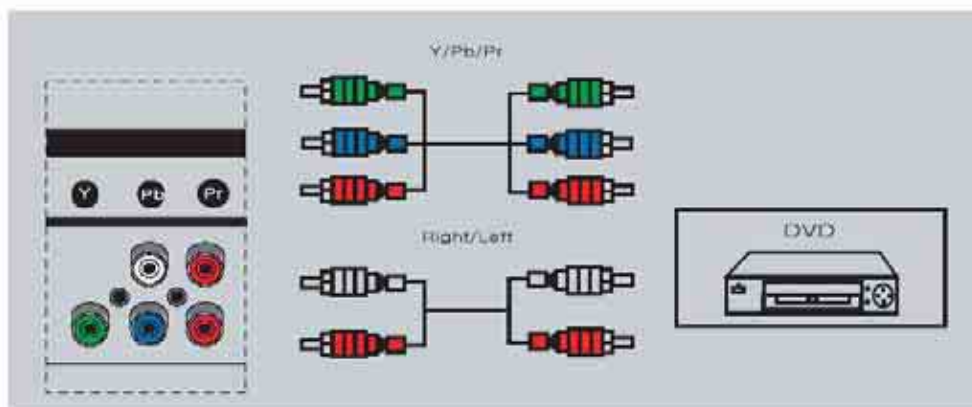

1. Press SOURCE button on the remote control and select Component.
Use the DVD player according to its owner's manual.
2. Turn on the DVD player, and insert a DVD.

I. TV Menu Options

Ch. Scan (Channel Search)

✳️ Automatically finds all channels (analog and digital) available through the 'ANT IN' source. The unit stores all the active channels found, on the channel list. Inactive or weak channels may not appear on the list. In that case, add missing channels manually with the Manual Add menu. The channel list created here can be seen in the Ch, Edit menu.



1. Press the MENU button and then use ▲/▼ button to select the TV icon.
2. Press the ► button and then use ▲/▼ button to select Ch. Scan menu.
3. Press the ► button and then use ▲/▼ button to select the desired option: AIR, CABLE.
 - AIR is for over-the-air antenna reception.
 - CABLE is for cable subscribers.
4. The channel search process begins.
 - You can skip the current scanning by pressing (ENTER).
 - You can stop the process by pressing MENU or EXIT.
5. After the channel search is complete, the lowest channel number found appears on the TV screen.
6. Press EXIT button to return to TV viewing or press MENU button to return to the previous menu.

Ch. Edit (Channel Edit)

✦ Channel Edit allows you to manually add or delete channels from the channel list in memory and create your own surf list of favorite channels. Press FAV (F) on the Remote Control when a channel is highlighted.



1. Press the MENU button and then use ▲/▼ button to select the TV icon.
2. Press the ► button and then use ▲/▼ button to select Ch. Edit menu.
3. Press the ► button and then use ▲/▼ button to edit channel:
 - To move one by one: Use ▲/▼ to move one step on the channel-editing menu.
 - To add/delete a channel: Press ENTER to add/delete the channel on the channel editing menu.
 - To create a Surf Channel list: Press FAV (F) to add the channel as a Surf channel.
4. Press MENU to return to the previous menu or press EXIT on the Remote Control to return to TV viewing.

[Note]

Deleted channels can not be selected with the ▲/▼ buttons.

Manual Add

- ✦ This feature manually adds or deletes channels.
- ✦ Shows how strong your DTV signal is and whether you need to adjust your antenna or digital cable input.
The higher the signal strength, the less likely you are to experience picture degradation.
- ✦ DTV Signals: Only when the input signal is DTV or CADTV, this function is available.

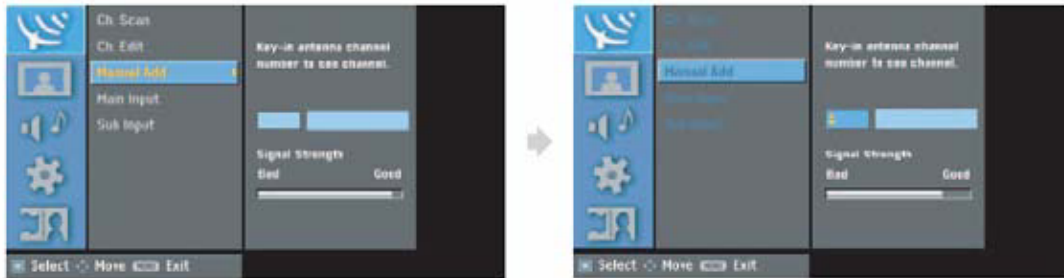

1. Press the MENU button and then use ▲/▼ button to select the TV icon.
2. Press the ► button and then use ▲/▼ button to select Manual Add menu.
3. Press the ► button and then use ▲/▼ button [or the numbered buttons] to add [or delete] channel
4. Press (ENTER) to confirm your selection.
5. Repeat steps 3-4 to add or delete additional channels with the Manual Add menu.
6. Press MENU to return to the previous menu or press EXIT on the Remote Control to return to TV viewing.

Main Input



1. Press the MENU button and then use ▲/▼ button to select the TV icon.
2. Press the ► button and then use ▲/▼ button to select Main Input menu.
3. Press the ► button and then use ▲/▼ button to select the source:
ATSC, NTSC, HDMI1, HDMI2, Component1, Component2, RGB, Video, S-Video.
4. Press EXIT button to return to TV viewing or press MENU button to return to the previous menu.

Sub Input



1. Press the MENU button and then use ▲/▼ button to select the TV icon.
2. Press the ► button and then use ▲/▼ button to select Sub Input menu.
3. Press the ► button and then use ▲/▼ button to select the source:
ATSC, NTSC, HDMI1, HDMI2, Component1, Component2, RGB, Video, S-Video.
4. Press EXIT button to return to TV viewing or press MENU button to return to the previous menu.

[Note]

Input Combination Table:

Main Input	Sub Input
ATSC, NTSC, Video, S-Video	HDMI1, HDMI2, Component1, Component2, RGB
HDMI1, HDMI2, Component1, Component2, RGB	ATSC, NTSC, Video, S-Video

II. Picture Menu Options

Picture

✦ Select the picture appearance to suit your preference and viewing situations.



1. Press the MENU button and then ▲/▼ button to select the PICTURE icon.
2. Press the ► button and then use ▲/▼ button to select the desired picture option:
User, Dynamic, Standard, Movie, Mild.
3. Press EXIT button to return to TV viewing or press MENU button to return to the previous menu.

User Control

✦ Adjust the picture appearance to suit your preference and viewing situations.



1. Press the MENU button and then ▲/▼ button to select the PICTURE icon.
2. Press the ► button and then use ▲/▼ button to select the desired picture option:
Contrast, Brightness, Color, Sharpness, Tint.
3. Press ► button and then use ◀/▶ button to make appropriate adjustments.
4. Press EXIT button to return to TV viewing or press MENU button to return to the previous menu.

Color Temperature Control

☄ Choose one of five automatic color adjustments. Set to warm to enhance hotter colors such as red, or set to cool to see less intense colors with more blue.



1. Press the MENU button and then use ▲/▼ button to select the PICTURE icon.
2. Press the ► button and then use ▲/▼ button to select Color Temperature menu.
3. Press the ► button and then use ▲/▼ button to select desired option:
Cool2, Cool1, Normal, Warm1, Warm2.
4. Press EXIT button to return to TV viewing or press MENU button to return to the previous menu.

Aspect Ratio

☄ Selects the screen format.



1. Press the MENU button and then use ▲/▼ button to select the PICTURE icon.
2. Press the ► button and then use ▲/▼ button to select Aspect Ratio menu.
3. Press the ► button and then use ▲/▼ button to select desired option:
Set By Program, Normal, Wide, Panorama, Zoom1, Zoom2.
4. Press EXIT button to return to TV viewing or press MENU button to return to the previous menu.

Video Recall

⚙️ For quickly reset of the Video menu options to their original factory preset values.

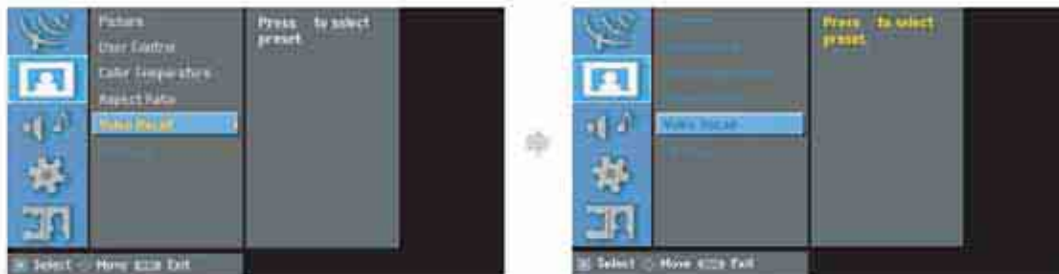

1. Press the MENU button and then use ▲/▼ button to select the PICTURE icon.
2. Press the ► button and then use ▲/▼ button to select Video Recall menu.
3. Press the ► button to reset the Video menu options to original values.
4. Press EXIT button to return to TV viewing or press MENU button to return to the previous menu.

PC Menu

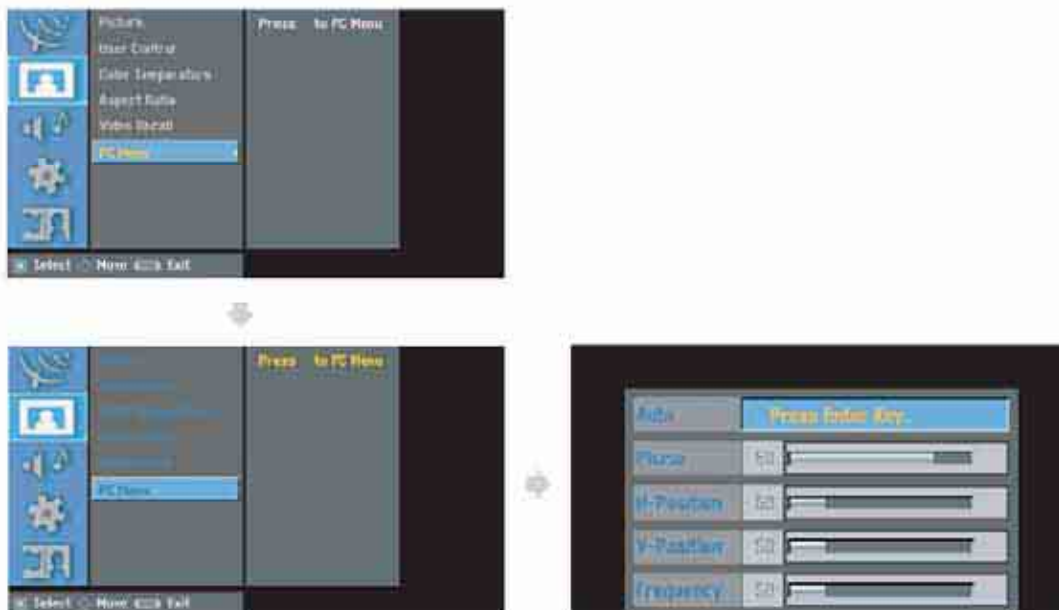

1. Press the MENU button and then use ▲/▼ button to select the PICTURE icon.
2. Press the ► button and then use ▲/▼ button to select PC Menu.
3. Press ► button and then use ◀/▶ button to make appropriate adjustments.
4. Press EXIT button to return to TV viewing or press MENU button to return to the previous menu.

III. Sound Menu Options

Audio Language



1. Press the MENU button and then use ▲/▼ button to select the SOUND icon.
2. Press the ► button and then use ▲/▼ button to select Audio Language menu.
3. Press the ► button and then use ▲/▼ button to select: English, French, and Spanish.
4. Press EXIT button to return to TV viewing or press MENU button to return to the previous menu.

Digital Audio Output

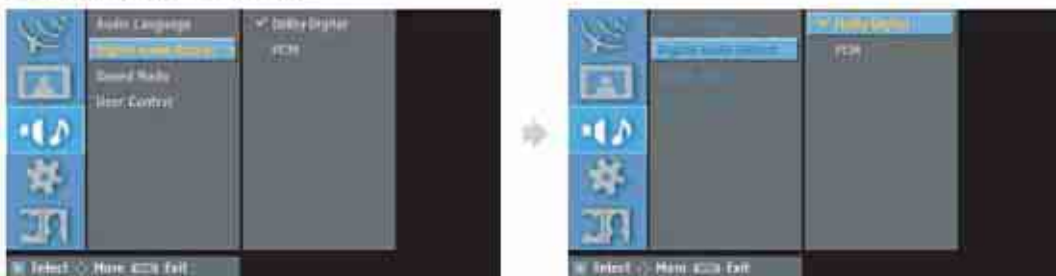

1. Press the MENU button and then use ▲/▼ button to select the SOUND icon.
2. Press the ► button and then use ▲/▼ button to select the Digital Audio Output menu.
3. Press the ► button and then use ▲/▼ button to select the desired sound option (Dolby Digital, PCM).
4. Press EXIT button to return to TV viewing or press MENU button to return to the previous menu.

Sound Mode

🔊 Adjust the sound to suit your taste and room situations.

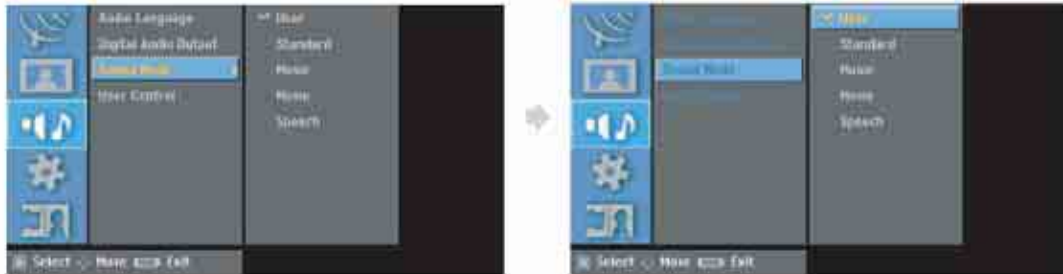

1. Press the MENU button and then use ▲/▼ button to select the SOUND icon.
2. Press the ► button and then use ▲/▼ button to select the Sound Mode menu.
2. Press the ► button and then use ▲/▼ button to select the desired sound option:
User, Standard, Music, Movie, Speech.
3. Press EXIT button to return to TV viewing or press MENU button to return to the previous menu.

User Control

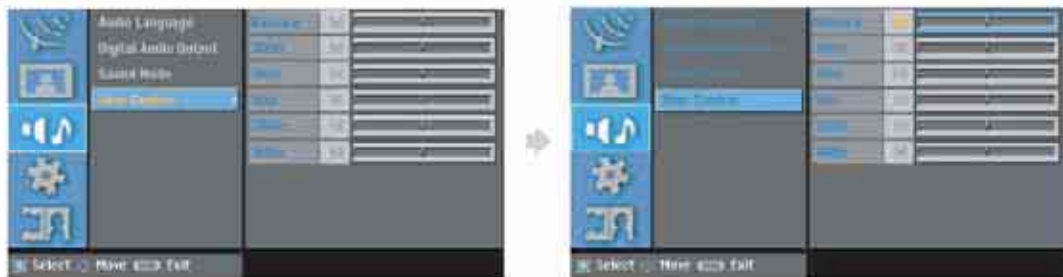

1. Press the MENU button and then use ▲/▼ button to select the SOUND icon.
2. Press the ► button and then use ▲/▼ button to select the User Control menu.
3. Press the ► button and then use ◀/▶ button to make appropriate adjustments:
Balance, 10 KHz, 3 KHz, 1 KHz, 300 Hz, 100 Hz
4. Press EXIT button to return to TV viewing or press MENU button to return to the previous menu.

IV. Setup Menu Options

DTV Caption

Select a default Caption language.



1. Press the MENU button and then use ▲/▼ button to select the SETUP icon.
2. Press the ► button and then use ▲/▼ button to select the DTV Caption menu.
3. Press the ► button and then use ▲/▼ button to select the desired option :
 - Off: DTV Caption is not displayed.
 - English: English is selected for DTV captions.
 - French: French is selected for DTV captions.
 - Spanish: Spanish is selected for DTV captions.
4. Press EXIT button to return to TV viewing or press MENU button to return to the previous menu.

[Note]

- o DTV Caption (Standard EIA /CEA 708) will appear only if provided by the broadcaster.
- o If DTV and Analog Captions are received simultaneously, you can only select DTV Caption.

DTV Caption Style

Select DTV Captions appearance menu options.



1. Press the MENU button and then use ▲/▼ button to select the SETUP icon.
2. Press the ► button and then use ▲/▼ button to select the DTV Caption Style menu.
3. Press the ► button and then use ▲/▼ button to make appropriate adjustments:
 - Style, Size, Font, Text Color, Text Opacity, Edge Color, Bg Color, Bg Opacity.
4. Press EXIT button to return to TV viewing or press MENU button to return to the previous menu.

 **Explain**

1) **Style:** Use caption feature defaults as provided by the program or customize caption appearance with the Custom menu options.

- **Set By Program:** Default text provided by a broadcaster is shown when captions appear.
- **Custom:** Customized text is shown when captions appear.

2) **Size:** Selects the font size for captions.

- **Standard:** The standard text size is used for the caption display (15 pixels).
- **Large:** The large text size is used for the caption display (21 pixels).
- **Small:** The small text size is used for the caption display (11 pixels).

3) **Font:** Selects the font type for captions.

4) **Text Color:** Selects the font color for captions.

5) **Text Opacity:** Selects the font opacity for captions.

- **Solid:** The text is solid (without any transparency).
- **Flash:** The text blinks twice a second.
- **Translucent:** The text is translucent.
- **Transparent:** The text is transparent (In this case, whatever the color is, the color does not affect the captions display).

6) **Edge Color**

Selects the edge color for captions (if the edge type is selected as None, the edge color does not have any effect on the captions display).

7) **Edge Type:** Selects the edge type for captions.

- **None:** the text has any edge.
- **Raised:** The text is raised.
- **Depressed:** The text is depressed.
- **Uniform:** The text has a uniform edge.
- **Left Shadow:** The text has a left-shadow edge.
- **Right Shadow:** The text has a right-shadow edge.

8) **Bg. (Background) Color:** Selects the background color for captions.

9) **Bg. (Background) Opacity:** Selects the background opacity for captions.

- **Solid:** The text background color is solid (without any transparency).
- **Flash:** The text background color blinks twice a second.
- **Translucent:** The text background color is translucent.
- **Transparent:** The text background color is transparent (In this case, whatever the background color is, the color does not affect the captions.).

Analog Caption

Allow you to select a mode for displaying Analog Caption Data. In the Analog Caption Service, Caption 1-4 display program's dialog, and Text 1-4 display data service information.

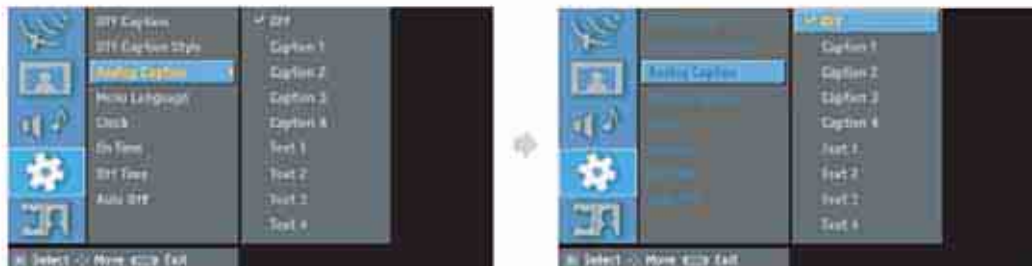

1. Press the MENU button and then use ▲/▼ button to select the SETUP icon.
2. Press the ► button and then use ▲/▼ button to select the Analog Caption menu.
3. Press the ► button and then use ▲/▼ button to select the desired option:
Off, Caption1, Caption2, Caption3, Caption4, Text1, Text2, Text3, or Text4.
4. Press EXIT button to return to TV viewing or press MENU button to return to the previous menu.

Explain

- 1) **Off:** Analog Caption is not displayed.
- 2) **Caption 1:** Caption 1 is the primary caption service that synchronizes the captioning language with the sound, used by most broadcasters. Captioning is displayed in the same language as the program's dialog.
- 3) **Caption 2:** Caption 2 is the special non-synchronous caption service that does not need to be in sync with the sound and may provide simplified captioning, which is usually delayed.
- 4) **Caption 3:** Caption 3 serves as an alternate captioning service channel. Captioning is often a secondary language translation such as French, Spanish, simplified English or displayed at a slower rate.
- 5) **Caption 4:** Caption 4 is another special non-synchronous caption service that does not need to be in sync with the sound and may provide simplified captioning, usually delayed.
- 6) **Text 1 - 4:** Text 1-4 usually displays information on the lower portion of the screen and is used for a data service, generally not program related.

[Note]

If DTV and Analog Caption are received simultaneously, you can only select DTV Captions, analog captions will not appear.

Menu Language

Select a language for the menus to appear in.



1. Press the MENU button and then use ▲/▼ button to select the SETUP icon.
2. Press the ► button and then use ▲/▼ button to select the Menu Language menu.
3. Press the ► button and then use ▲/▼ button to select the desired option:
English, French, Spanish.
4. Press EXIT button to return to TV viewing or press MENU button to return to the previous menu.

Clock

Enable the user to set up the clock information. Normally, your clock is set using signals transmitted by DTV stations. Choosing your Time Zone sets the current time automatically. But if the Ant In jack on the connection panel is connected to a cable service, you must set the clock manually.

1) Auto Clock Setup

- The time is set automatically from a digital channel signal.
- The digital channel signal includes information for the current time provided by the broadcasting station.
- Set the clock manually, if the current time is set incorrectly by the auto clock function.



1. Press the MENU button and then use ▲/▼ button to select the SETUP icon.
2. Press the ► button and then use ▲/▼ button to select Clock menu.
3. Press the ► button and then use ▲/▼ button to select Time Zone.
 - U.S.A: Eastern, Central, Mountain, Pacific, Alaska, or Hawaii.
 - Canada: Eastern, Central, Mountain, Pacific, New F.land, or Atlantic.
4. Press EXIT button to return to TV viewing or press MENU button to return to the previous menu.

2) Manual Clock Setup

- If current time setting is wrong, reset the clock manually.

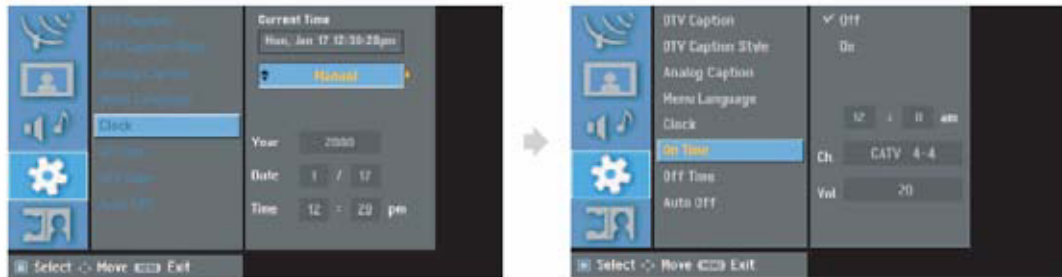

1. Press the MENU button and then use ▲/▼ button to select the SETUP icon.
2. Press the ► button and then use ▲/▼ button to select Clock menu.
3. Press the ► button and then use ▲/▼ button to select Manual.
4. Press the ► button and then use ◀/▶ button to select the year, date, or time option.
Once selected, use the ▲/▼ button to set the year, date, and time options.
5. Press EXIT button to return to TV viewing or press MENU button to return to the previous menu.

On Time

⚠️ Timer function operates only if current time has been set.



1. Press the MENU button and then use ▲/▼ button to select the SETUP icon.
2. Press the ► button and then use ▲/▼ button to select On Time menu.
3. Press the ► button and then use ▲/▼ button to set the hour.
4. Press the ► button and then use ▲/▼ button to set the minutes.
5. Press the ► button and then use ▲/▼ button to select the channel at turn-on.
6. Press the ► button and then use ▲/▼ button to set the Volume level at turn-on.
7. Press EXIT button to return to TV viewing or press MENU button to return to the previous menu.

Off Time

⚠ Off-Time function overrides On-Time function if they are set both set to the same time.

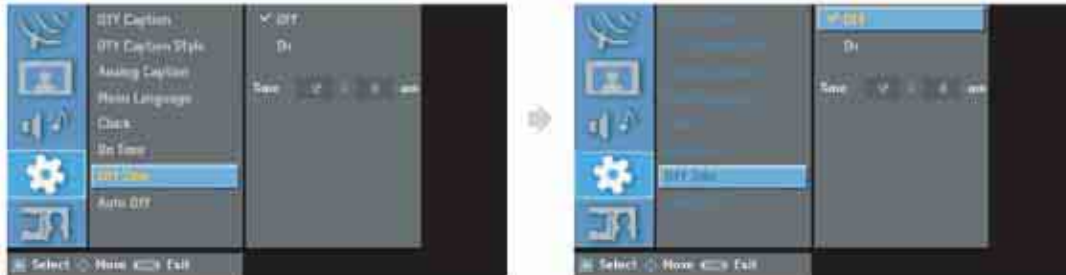

1. Press the MENU button and then use ▲/▼ button to select the SETUP icon.
2. Press the ► button and then use ▲/▼ button to select Off Time menu.
3. Press the ► button and then use ▲/▼ button to set the hour.
4. Press the ► button and then use ▲/▼ button to set the minutes.
6. Press EXIT button to return to TV viewing or press MENU button to return to the previous menu.

Auto Off

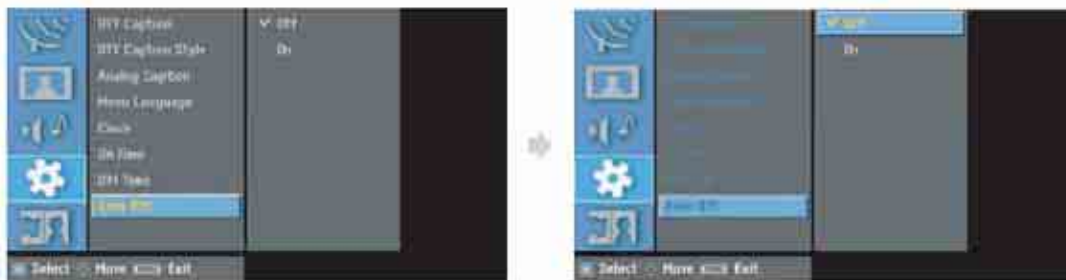

1. Press the MENU button and then use ▲/▼ button to select the SETUP icon.
2. Press the ► button and then use ▲/▼ button to select Auto Off menu.
3. Press the ► button and then use ▲/▼ button to select Off or On.
4. Press EXIT button to return to TV viewing or press MENU button to return to the previous menu.

- If set to on and there is no input signal, the TV turns off automatically after 10 minutes.

V. Lock(Parental Control) Menu Options

Lock System

☞: Allow you to set up specific channels and ratings through blocking schemes. Also allows you to activate or disable all of the lock schemes previously set up. A password is required to gain access to the LOCK menus. If the Lock System is set to Off, the Channel and Program Ratings are not functional.

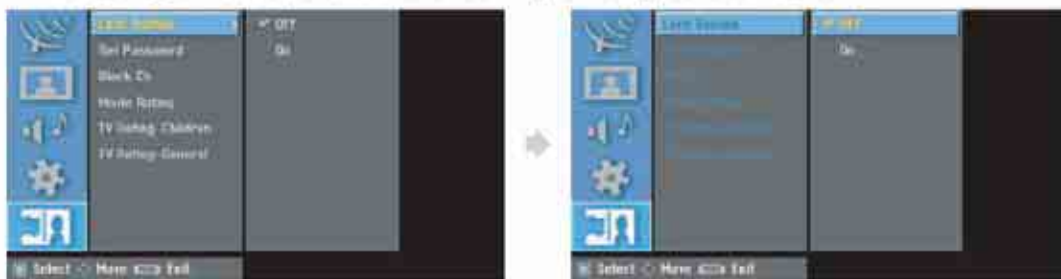

1. Press the MENU button and then use ▲/▼ button to select the LOCK icon.
2. Press the ► button and then use ▲/▼ button to select Lock System menu.
3. Press the ► button and then use ▲/▼ button to select Off or On.
4. Press EXIT button to return to TV viewing or press MENU button to return to the previous menu.
 - If Lock is already set, enter the password as requested.
 - The TV is set up with the initial password "0-0-0-0".

Set Password

☞: Changes the password.

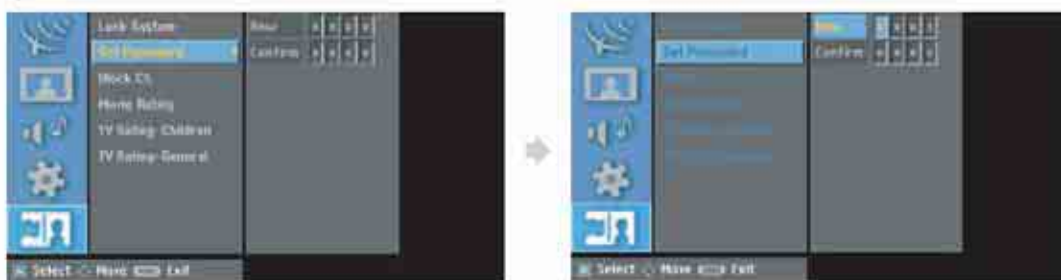

1. Press the MENU button and then use ▲/▼ button to select the LOCK icon.
2. Press the ► button and then use ▲/▼ button to select Set Password menu.
3. Enter the new 4-digit password.
4. Enter the same password again for confirmation.
5. Press EXIT button to return to TV viewing or press MENU button to return to the previous menu.

Block Ch. (Channel)

Blocks any channel that you do not want to view or that you do not want your children to watch. If you tune in a blocked channel, a black screen with a pop-up box will appear. Block Ch can override Channel Edit menu settings.

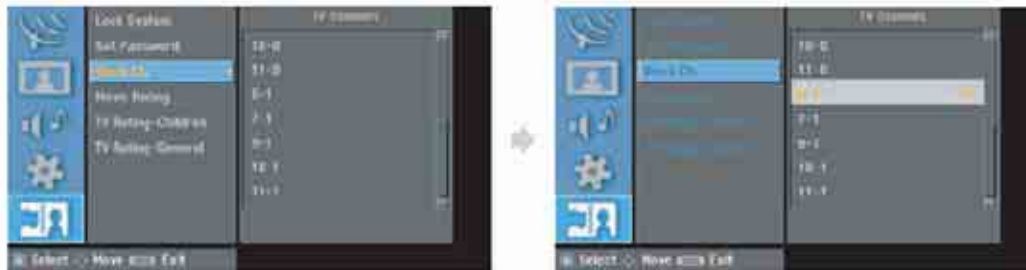

1. Press the MENU button and then use ▲/▼ button to select the LOCK icon.
2. Press the ► button and then use ▲/▼ button to select Block Ch menu.
3. Press the ► button and then select a channel number that you wish to block.
4. Press EXIT button to return to TV viewing or press MENU button to return to the previous menu.

- If Lock is already set, enter the password as requested.
- The TV is set up with the initial password *0-0-0-0*.

Movie Rating (MPPA)

Block movies according to the movie ratings restrictions so children cannot view certain movies. You can set the ratings to block out all the movies with ratings above a specified level. Keep in mind that the movie ratings apply only to movies shown on TV, not TV programs such as soap operas.



1. Press the MENU button and then use ▲/▼ button to select the LOCK icon.
2. Press the ► button and then use ▲/▼ button to select Movie Rating menu.
3. Press the ► button and then select a Movie Rating level that you wish to block.
4. Press EXIT button to return to TV viewing or press MENU button to return to the previous menu.

- If Lock is already set, enter the password as requested.
- The TV is set up with the initial password *0-0-0-0*.

 **Explain**

All Block: All programs with a rating are blocked.

G (General Audiences): Content is not offensive to most viewers. This is a film which contains nothing in theme, language, nudity and sex, violence, etc. which would be offensive to parents whose younger children view the film. The G rating is not a "certificate of approval," nor does it signify a children's film. Some snippets of language may go beyond polite conversation but they are common everyday expressions. No stronger words are present in G-rated films. The violence is at a minimum. Nudity and sex scenes are not present; nor is there any drug use content.

PG: "Parental Guidance Suggested. Some Material May Not Be Suitable For Children." The PG rating, suggesting parental guidance, is an alert for examination of a film by parents before deciding on its viewing by their children. This is a film which clearly needs to be examined or inquired into by parents before they let their children see it. The label PG plainly states that parents may consider some material unsuitable for their children, but the parent must make the decision. Parents are warned against allowing their children to see PG-rated movies. The theme of a PG-rated film may itself call for parental guidance. There may be some profanity in these films. There may be some violence or brief nudity. But these elements are not deemed so intense as to require that parents be strongly cautioned beyond the suggestion of parental guidance. There is no drug use content in a PG-rated film.

PG-13: PG-13 Parents Strongly Cautioned. Some Material May Be Inappropriate For Children Under 13. PG-13 is a stern warning to parents to determine for themselves the attendance in particular of their younger children as they might consider some material not suited for them. Parents, by the rating, are alerted to be very careful about viewing by their under-teenage children.

A PG-13 film is one which leaps beyond the boundaries of the PG rating in theme, violence, nudity, sensuality, language, or other contents, but does not quite fit within the restricted R category. Any drug use content will initially require at least a PG-13 rating. In effect, the PG-13 cautions parents with more stringency than usual to give special attention to this film before they allow their 12-year olds and younger to see it. PG-13 places larger responsibilities on parents for their children's movie viewing. The rating system is not a surrogate parent, nor should it be. It cannot, and should not, insert itself in family decisions that only parents can, and should, make. Its purpose is to give prescreening advance informational warnings, so that parents can form their own judgments. PG-13 is designed to make these parental decisions easier for films between PG and R.

R (Restricted viewing): Not for children under age 17. Strong elements of sex and/or violence. Requires Accompanying Parent Or Adult Guardian. The film definitely contains some adult material. Parents are strongly urged to find out more about the film before they allow their children to see it. An R-rated film may include hard language, or tough violence, or nudity within sensual scenes, or drug abuse or other elements, or a combination of some of the above, so that parents are counseled, in advance, to take this advisory rating very seriously. Parents must find out more about an R-rated movie before they allow their teenagers to view it.

 **Explain**

NC-17 (Restricted Viewing): Not for children under age 17 under any circumstances. Strong sexual content. This rating declares that this is a film that most parents will consider patently too adult for their youngsters under 17. No children should see the film. NC-17 does not necessarily mean "obscene or pornographic" in the oft-accepted or legal meaning of those words. The reasons for the application of an NC-17 rating can be violence or sex or aberrational behavior or drug abuse or any other elements which, when present, most parents would consider too strong and therefore off-limits for viewing by their children.

X (Hard Core Films): Same as NC-17 rating.

TV Rating—Children

⚠: Prevent children from watching certain children's TV programs according to the ratings limit set. This rating applies only to TV programs for children. Unless you block TV programs intended for mature audiences in the TV Rating—General menu, your children could view those programs.

1) Age

– Selection applies regardless of content category of rating.



1. Press the MENU button and then use ▲/▼ button to select the LOCK icon.
2. Press the ► button and then use ▲/▼ button to select Movie Rating menu.
3. Press the ► button and then select a Movie Rating level that you wish to block.
4. Press EXIT button to return to TV viewing or press MENU button to return to the previous menu:
 - If Lock is already set, enter the password as requested.
 - The TV is set up with the initial password "0-0-0-0".

2) Fantasy Violence

- Selection applies if TV programs include rating for Fantasy Violence.



1. Press the MENU button and then use ▲/▼ button to select the LOCK icon.
2. Press the ► button and then use ▲/▼ button to select TV Rating-Children menu.
3. Press the ► button and then select a TV Rating-Children level that you wish to block.
4. Press EXIT button to return to TV viewing or press MENU button to return to the previous menu.
 - If Lock is already set, enter the password as requested.
 - The TV is set up with the initial password "0-0-0-0".

Explain

All Block: All programs with a rating are blocked.

TV-Y: All Children.

This program is designed to be appropriate for all children. Whether animated or live-action, the themes and elements in this program are specifically designed for a very young audience, including children from ages 2 – 6. This program is not expected to frighten younger children.

TV-Y7: Directed toward children age 7 and older.

This program is designed for children age 7 and older. It may be more appropriate for children who have acquired the developmental skills needed to distinguish between make-believe and reality. Themes and elements in this program may include mild fantasy violence or comedic violence, or may frighten children under the age of 7. Therefore, parents may wish to consider the suitability of this program for their very young children.

[Note] For these programs where fantasy violence may be more intense or more combative than other programs in this category, such programs will be designated TV-Y7-FV.

TV Rating—General

⚠: Blocks TV programs that you or your family may not wish to watch, based on the rating scheme set.

1) Age: Selection applies regardless of content category of rating.



2) Dialogue: Selection applies if TV programs have rating for Dialogue.

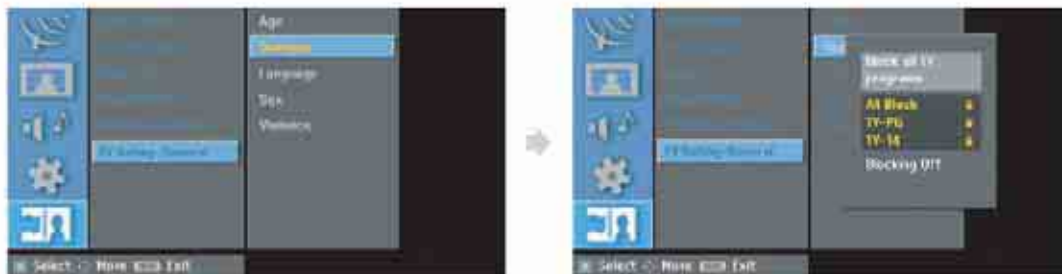

3) Language: Selection applies if TV programs have rating for Language.



4) Sex: Selection applies if TV programs have rating for Sex.



5) Violence: Selection applies if TV programs have rating for Violence.



Explain

All Block: All programs with a rating are blocked.

TV-G: General Audience.

Most parents would find this program suitable for all ages. Although this rating does not signify a program designed specifically for children, most parents may let younger children watch this program unattended.

It contains little or no violence, no strong language and little or no sexual dialogue or situations.

TV-PG: Parental Guidance Suggested.

This program contains material that parents may find unsuitable for younger children. Many parents may want to watch it with their younger children. The theme itself may call for parental guidance and/or the program contains one or more of the following: moderate violence (V), some sexual situations (S), infrequent coarse language (L), or some suggestive dialogue (D).

TV-14: Parents Strongly Cautioned.

This program contains some material that many parents would find unsuitable for children under 14 years of age. Parents are strongly urged to exercise greater care in monitoring this program and are cautioned against letting children under the age of 14 watch unattended. This program contains one or more of the following: intense violence (V), intense sexual situations (S), strong coarse language (L), or intensely suggestive dialogue (D).

TV-MA: Mature Audience Only.

This program is specifically designed to be viewed by adults and therefore may be unsuitable for children under 17. This program contains one or more of the following: graphic violence (V), explicit sexual activity (S), or crude indecent language (L).

VI. Picture in picture(PIP) function

Picture in picture(PIP) function

- PIP picture will let you view two separate inputs on your TV screen at the same time.
- Color of main picture may be different from PIP's in PIP picture.
- When the main picture is ATSC/NTSC/Video/S-Video, the sub picture is input /HDMI1/HDMI2/Component1/Component2/RGB.

How to use the PIP

1. Press the PIP button.
 - If you press the PIP button again, the function is off.



Moving the sub picture

1. Press the P.POSITION button in PIP.
 - Each time you press the P.POSITION button, sub picture position is changed as follows.

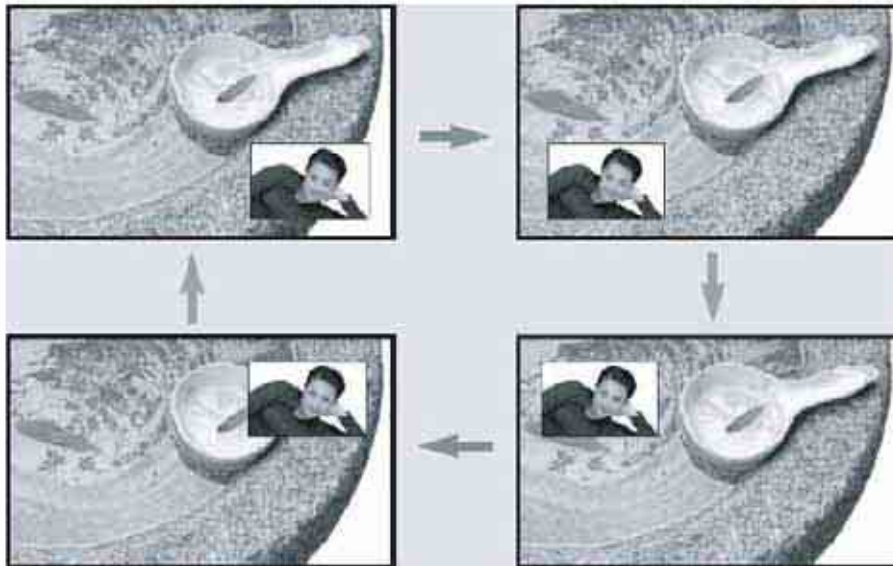

Twin picture function

How to use twin picture

1. Press the P.SIZE button to select twin picture.
2. Each time you press P.SIZE button, you can select TWIN or PIP alternatively.



3. TWIN picture let you view different inputs on your TV screen at the same time.
 - Color of main picture may be different from PIP's in PIP/TWIN picture.
 - When the main picture is ATSC/NTSC/Video/S-Video, the sub picture input is HDMI1/HDMI2/Component1/Component2/RGB.

Input select of the sub picture

1. Press the P.Input button to select the input of sub picture.



Picture in picture(SWAP) function

- ✧ Change the main picture and the sub picture
- ✧ When the main picture is ATSC/NTSC/Video/S-Video, the sub picture is input /HDMI1/HDMI2/Component1/Component2/RGB.

1. Press the SWAP button in PIP mode.

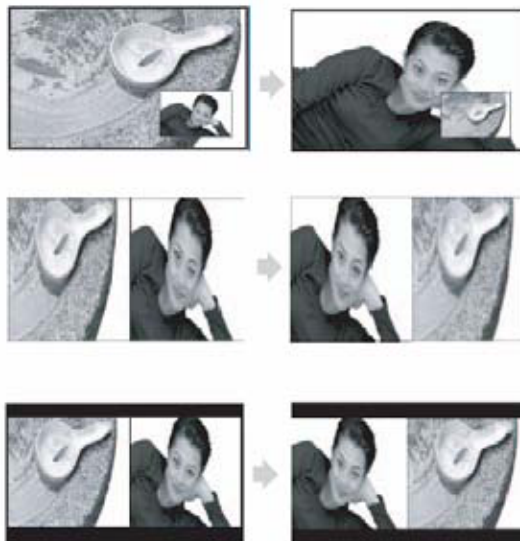

Supportable Timings

Section	Resolution	H.Frequency (kHz)	V.Frequency (Hz)
PC	640*350	25.862	59.866
	640*400	31.469	59.941
	640*480	31.469	59.94
	640*480	31.5	60
	640*480	37.861	72.809
	640*480	37.500	75.0
	720*400	31.469	59.941
	800*600	35.156	56.25
	800*600	37.879	60.317
	800*600	43.764	70.02
	800*600	46.875	75.0
	832*624	49.107	75.087
	1024*768	48.780	60.001
	1024*768	48.363	60.004
	1024*768	56.476	70.069
	1024*768	57.703	72.039
	1024*768	60.241	74.927
	1024*768	60.030	75.029

Troubleshooting

Problem	Check item
No picture on screen and no sound from speakers.	<ul style="list-style-type: none"> * Insert the AC power cord plugt secrely in AC power outlet. * Make sure the remote control is not in the standby mode (The Power/Standby indicator is red.) * Turn on the Main Power button.
No picture/No picture from AV terminal.	<ul style="list-style-type: none"> * Check the brightness setting of the display. * Lamp may have malfunction. * Make sure a cable with no VIDEO input signal is connected to the S-Video input terminal.
Picture is displayed, but no sound from the speakers.	<ul style="list-style-type: none"> * Check the sound setting. * Make sure the sound is not muted. * Make sure a pair of headphones is not connected. * Make sure the connectors of the optional speaker system are securely inserted. * Make sure the setting of AV output terminal.
Picture is too light.	<ul style="list-style-type: none"> * Make sure COLOR and CONTRAST settings.
Picture is too dark	<ul style="list-style-type: none"> * Make sure BRIGHTNESS setting is not set too low. * Check to see if BRIGHTNESS setting * Lamp may have malfunction.
Remote control does not work.	<ul style="list-style-type: none"> * Change the batteries. * Make sure the infrared transmitter window is not receiving strong light such as light from fluorescent lamps.
No picture from AV OUT terminal.	<ul style="list-style-type: none"> * Make sure AV input is not set. * Make sure the input source other than AV
The picture is not sharp. The picture moves.	<ul style="list-style-type: none"> * The reception may be weak. * The state of the broadcast may also be bad. * Make sure the antenna is facing the right direction. * Make sure the outside antenna is not disconnected.
The picture is doubled or tripled.	<ul style="list-style-type: none"> * Make sure the antenna is facing the right direction. * There may be reflected electric waves from mountains or buildings.
The picture is spotted.	<ul style="list-style-type: none"> * There may be interference from automobiles, trins, high voltage lines, neon lights, etc. * There may be interference between the antenna cable and power cable. Try positioning them further apart.
There are stripes on the screen or colors fade.	<ul style="list-style-type: none"> * Is the unit receiving interference from other devices? Transmission antennas of radio broadcasting stations and transmission antennas of amateur radios and cellular phones may also cause interference. * Use the unit as far apart as possible from devices that may cause possible interference.



Product Specifications

◆ Product name : Color LCD TV

◆ Power Supply : AC 100~240V

◆ Speaker : 20W(10W+10W)

	Dimension(mm)	Consumption power(w)
32"	815x250x610	150
42"	1070x315x850	250

※ The specifications shown above may be changed without prior notice for quality improvement.