

**ELECTROMAGNETIC EMISSIONS COMPLIANCE REPORT
INTENTIONAL RADIATOR CERTIFICATION TO
FCC PART 15 SUBPART C REQUIREMENT**

OF

Notebook with wireless LAN 802.11b module

**MODEL No.: MB02 / NEC VERSA P600 /
NEC VERSA FP600 / Easy Note / FIM2000 / Mecer**

FCC ID: EUNMB02W3Bb

REPORT NO: 030024-RF-ID

ISSUE DATE: Mar. 13, 2003

Prepared for

**First International Computer Inc.
8F, No. 300 , Yang Guang St., Taipei, Taiwan, R.O.C**

Prepared by

**C&C LABORATORY, CO., LTD.
#B1, 1st Fl., Universal Center,
No. 183, Sec. 1, Tatung Rd., Hsi Chih,
Taipei Hsien, Taiwan, R.O.C.**

TEL: (02)8642-2071~3

FAX: (02)8642-2256



VERIFICATION OF COMPLIANCE

| | |
|-----------------------------|---|
| Applicant: | First International Computer Inc. 8F, No. 300, Yang Guang St., Taipei, Taiwan, R.O.C |
| Product Description: | Notebook with wireless LAN 802.11b module |
| Model No.: | MB02 / NEC VERSA P600 / NEC VERSA FP600 / Easy Note / FIM2000 / Mecer |
| Serial Number: | N/A |
| File Number: | 030024-RF-ID |
| Date of test: | Fed 20 2003 ~Mar 05, 2003 |

We hereby certify that:

The above equipment was tested by C&C Laboratory Co., Ltd. The test data, data evaluation, test procedures, and equipment configurations shown in this report were made in accordance with the procedures given in ANSI C63.4 (1992) and the energy emitted by the sample EUT tested as described in this report is in compliance with conducted and radiated emission limits of FCC Rules Part 15.247.

The test results of this report relate only to the tested sample identified in this report.

Approved By



Vincent Su / Vice Manager
C&C Laboratory Co., Ltd..

Table of Contents

| | | |
|-----------|---|-----------|
| 1. | GENERAL INFORMATION..... | 5 |
| 1.1 | PRODUCT DESCRIPTION..... | 5 |
| 1.2 | RELATED SUBMITTAL(S) / GRANT (S)..... | 5 |
| 1.3 | TEST METHODOLOGY..... | 5 |
| 1.4 | TEST FACILITY..... | 5 |
| 1.5 | SPECIAL ACCESSORIES..... | 5 |
| 1.6 | EQUIPMENT MODIFICATIONS..... | 5 |
| 2. | SYSTEM TEST CONFIGURATION..... | 6 |
| 2.1 | EUT CONFIGURATION..... | 6 |
| 2.2 | EUT EXERCISE..... | 6 |
| 2.3 | TEST PROCEDURE..... | 6 |
| 2.4 | CONFIGURATION OF TESTED SYSTEM..... | 7 |
| 3. | SUMMARY OF TEST RESULTS..... | 8 |
| 4. | DESCRIPTION OF TEST MODES..... | 8 |
| 5. | SPURIOUS EMISSION TEST..... | 9 |
| 5.1 | STANDARD APPLICABLE..... | 9 |
| 5.2 | EUT SETUP..... | 9 |
| 5.3 | MEASUREMENT PROCEDURE..... | 9 |
| 5.4 | TEST SET-UP (BLOCK DIAGRAM OF CONFIGURATION)..... | 10 |
| 5.5 | MEASUREMENT EQUIPMENT USED:..... | 11 |
| 5.6 | MEASUREMENT RESULT..... | 11 |
| 6. | AC POWER LINE CONDUCTED EMISSION TEST..... | 23 |
| 6.1 | STANDARD APPLICABLE..... | 23 |
| 6.2 | EUT SETUP..... | 23 |
| 6.3 | MEASUREMENT PROCEDURE..... | 23 |
| 6.4 | MEASUREMENT EQUIPMENT USED:..... | 24 |
| 6.5 | MEASUREMENT RESULT..... | 24 |
| 7. | 6 DB BANDWIDTH MEASUREMENT..... | 27 |
| 7.1 | STANDARD APPLICABLE..... | 27 |
| 7.2 | MEASUREMENT EQUIPMENT USED:..... | 27 |
| 7.3 | TEST SETUP:..... | 27 |
| 7.4 | MEASUREMENT PROCEDURE..... | 28 |
| 7.5 | MEASUREMENT RESULT..... | 28 |
| 8. | PEAK OUTPUT POWER MEASUREMENT..... | 31 |
| 8.1 | STANDARD APPLICABLE..... | 31 |
| 8.2 | TEST SETUP..... | 31 |
| 8.3 | MEASUREMENT EQUIPMENT USED:..... | 31 |
| 8.4 | TEST RESULTS:..... | 31 |



| | | |
|-------------------|---|-----------|
| 9. | 100KHZ BANDWIDTH OF BAND EDGES MEASUREMENT | 32 |
| 9.1 | STANDARD APPLICABLE | 32 |
| 9.2 | MEASUREMENT PROCEDURE | 32 |
| 9.3 | MEASUREMENT RESULT | 32 |
| 9.4 | MEASUREMENT EQUIPMENT USED:..... | 32 |
| 10. | PEAK POWER SPECTRAL DENSITY | 34 |
| 10.1 | STANDARD APPLICABLE | 34 |
| 10.2 | MEASUREMENT PROCEDURE | 34 |
| 10.3 | MEASUREMENT RESULT | 34 |
| 10.4 | MEASUREMENT EQUIPMENT USED:..... | 34 |
| 11. | ANTENNA REQUIREMENT | 37 |
| 11.1 | STANDARD APPLICABLE | 37 |
| 11.2 | ANTENNA CONNECTED CONSTRUCTION | 37 |
| 12. | RF EXPOSURE | 38 |
| 12.1 | STANDARD APPLICABLE | 38 |
| 12.2 | MEASUREMENT RESULT | 39 |
| APPENDIX 1 | | |
| | PHOTOGRPHS OF SET UP | 40 |
| APPENDIX 2 | | |
| | PHOTOGRPHS OF EUT | 43 |



1. GENERAL INFORMATION

1.1 Product Description

The First International Computer Inc. Model: MB02 / NEC VERSA P600 / NEC VERSA FP600 / Easy Note / FIM2000 / Mecer (referred to as the EUT in this report) is a Notebook with wireless LAN module. The EUT is compliance with IEEE802.11b Standard.

A major technical descriptions of EUT is described as following:

- A). Operation Frequency: 2.412GHz – 2.462GHz; 11 channels;
- B). Transmit Power: 16dBm
- C). Modulation type: Direct Sequence spread Spectrum, (CCK; DQPSK; DBPSK)
- D). Transition Speed: 1/2/5.5/11Mbps
- E). Antenna Designation: PIFA Antenna; Non-User Embedded, two provided.
one for Tx, another for Rx.
- F). Power Supply: MODEL:ADP-60DB REV.B
INPUT: AC 100~240V, 1.5A, 50-60Hz
OUTPUT:DC +19V,3.16A

1.2 Related Submittal(s) / Grant (s)

This submittal(s) (test report) is intended for FCC ID: EUNMB02W3Bb filing to comply with Section 15.247 of the FCC Part 15, Subpart C Rules. The composite system (digital device) is compliance with Subpart B is authorized under a DoC procedure.

1.3 Test Methodology

Both conducted and radiated testing was performed according to the procedures in ANSI C63.4 (1992). Radiated testing was performed at an antenna to EUT distance 3 meters..

1.4 Test Facility

The open area test site and conducted measurement facility used to collect the radiated data is located on the address of C&C Laboratory, Co., Ltd. No. 81-1, 210 Lane, Pa-de 2nd Road, Lu-Chu Hsiang, Taoyuan, Taiwan, R.O.C.. The Open Area Test Sites and the Line Conducted labs are constructed and calibrated to meet the FCC requirements in documents ANSI C63.4: 1992 and CISPR 22/EN 55022 requirements.

1.5 Special Accessories

Not available for this EUT intended for grant.

1.6 Equipment Modifications

Not available for this EUT intended for grant.



2. SYSTEM TEST CONFIGURATION

2.1 EUT Configuration

The EUT configuration for testing is installed on RF field strength measurement to meet the Commissions requirement and operating in a manner that intends to maximize its emission characteristics in a continuous normal application.

2.2 EUT Exercise

The EUT (Transmitter) was operated in the engineering mode to fix the Tx frequency that was for the purpose of the measurements.

2.3 Test Procedure

2.3.1 Conducted Emissions

The EUT is a placed on as turn table which is 0.8 m above ground plane. According to the requirements in Section 13.1.4.1 of ANSI C63.4-1992. Conducted emissions from the EUT measured in the frequency range between 0.15 MHz and 30MHz using CISPR Quasi-Peak detector mode.

2.3.2 Radiated Emissions

The EUT is a placed on as turn table which is 0.8 m above ground plane. The turn table shall rotate 360 degrees to determine the position of maximum emission level. EUT is set 3m away from the receiving antenna which varied from 1m to 4m to find out the highest emission. And also, each emission was to be maximized by changing the polarization of receiving antenna both horizontal and vertical. In order to find out the max. emission, the relative positions of this hand-held transmitter(EUT) was rotated through three orthogonal axes according to the requirements in Section 13.1.4.1 of ANSI C63.4-1992.

2.4 Configuration of Tested System

Fig. 2-1 Configuration of Tested System

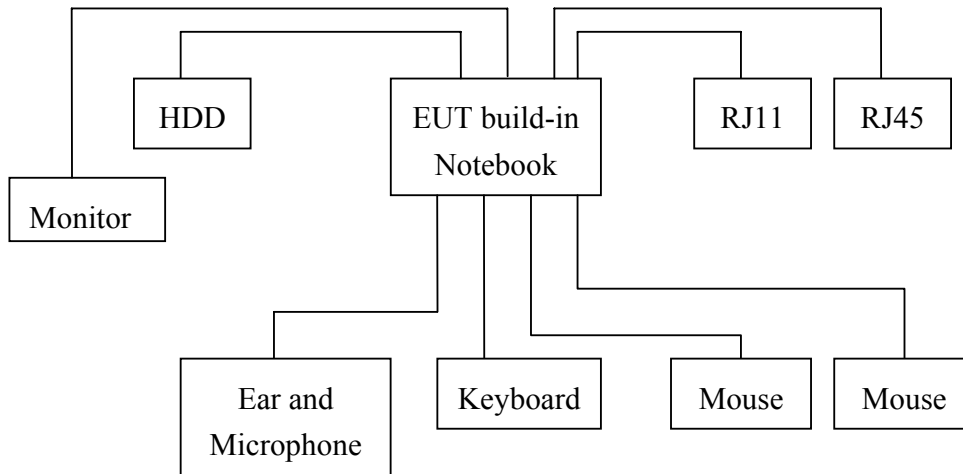

Table 2-1 Equipment Used in Tested System

| Item | Equipment | Mfr/Brand | Model/ Type No. | FCC ID | Series No. | Data Cable | Power Cord |
|------|-----------------|-----------|--------------------|------------------|------------|-------------------------------|------------------|
| 1. | External HDD | IBM | N/A | N/A | DCAS-34330 | Shielded, 1.8m | Unshielded, 1.8m |
| 2. | Ear/Microp hone | GITON | N/A | N/A | GT-2004V | Unshielded, 1.25m | N/A |
| 3. | Keyboard | BTC | 3872B597 | G91400266 | 7932M | Shielded, 1.8m | N/A |
| 4. | Mouse | Logitech | 4872A221 | LZE92250102 | M-BB48 | Shielded, 1.8m | N/A |
| 5. | Mouse | Logitech | 4872A221 | LZE94115056 4 | M-BB48 | Shielded, 1.8m | N/A |
| 6. | Monitor | SONY | 3882B102 | 2716043 | CPD-G200 | Shielded, 1.8m With a core | Shielded, 1.8m |

3. SUMMARY OF TEST RESULTS

| FCC Rules | Description Of Test | Result |
|---------------------|---|-----------|
| §15.209(a) (f) | Spurious Emission | Compliant |
| §15.207(a) | AC Power Port Conducted Emission | Compliant |
| §15.247(a)(2) | 6dB Bandwidth | Compliant |
| §15.247(b) | Peak Output Power | Compliant |
| §15.247(c) | 100 KHz Bandwidth Of Frequency Band Edges | Compliant |
| §15.247(d) | Power Density | Compliant |
| §15.203 | Antenna Requirement | Compliant |
| §1.1310 and §2.1093 | RF exposures | Compliant |

4. DESCRIPTION OF TEST MODES

The EUT has been tested under operating condition.

Software used to control the EUT for staying in continuous transmitting and receiving mode is programmed.

Channel 1(2412MHz) 、6(2437MHz) and 11(2462MHz) with 11Mbps highest data rate are chosen for full testing.



5. SPURIOUS EMISSION TEST

5.1 Standard Applicable

According to §15.247(c), all other emissions outside these bands shall not exceed the general radiated emission limits specified in §15.209(a). And according to §15.33(a)(1), for an intentional radiator operates below 10GHz, the frequency range of measurements: to the tenth harmonic of the highest fundamental frequency or to 40GHz, whichever is lower.

5.2 EUT Setup

1. The radiated emission tests were performed in the 3 meter open-test site, using the setup in accordance with the ANSI C63.4-1992.
2. The EUT was put in the front of the test table. The host PC system was placed on the center of the back edge on the test table. The peripherals like modem, monitor printer, K/B, and mouse were placed on the side of the host PC system. The rear of the EUT and peripherals were placed flushed with the rear of the tabletop.
3. The keyboard was placed directly in the front of the monitor, flushed with the front tabletop. The mouse was placed next to the Keyboard, flushed with the back of keyboard.
4. The spacing between the peripherals was 10 centimeters.
5. External I/O cables were draped along the edge of the test table and bundle when necessary.
6. The host PC system was connected with 110Vac/60Hz power source.

5.3 Measurement Procedure

1. The EUT was placed on a turn table which is 0.8m above ground plane.
2. The turn table shall rotate 360 degrees to determine the position of maximum emission level.
3. EUT is set 3m away from the receiving antenna which varied from 1m to 4m to find out the highest emissions.
4. Maximum procedure was performed on the six highest emissions to ensure EUT compliance.
5. And also, each emission was to be maximized by changing the polarization of receiving antenna both horizontal and vertical.
6. Repeat above procedures until all frequency measured were complete.

5.4 Test SET-UP (Block Diagram of Configuration)

(A) Radiated Emission Test Set-Up, Frequency Below 1000MHz

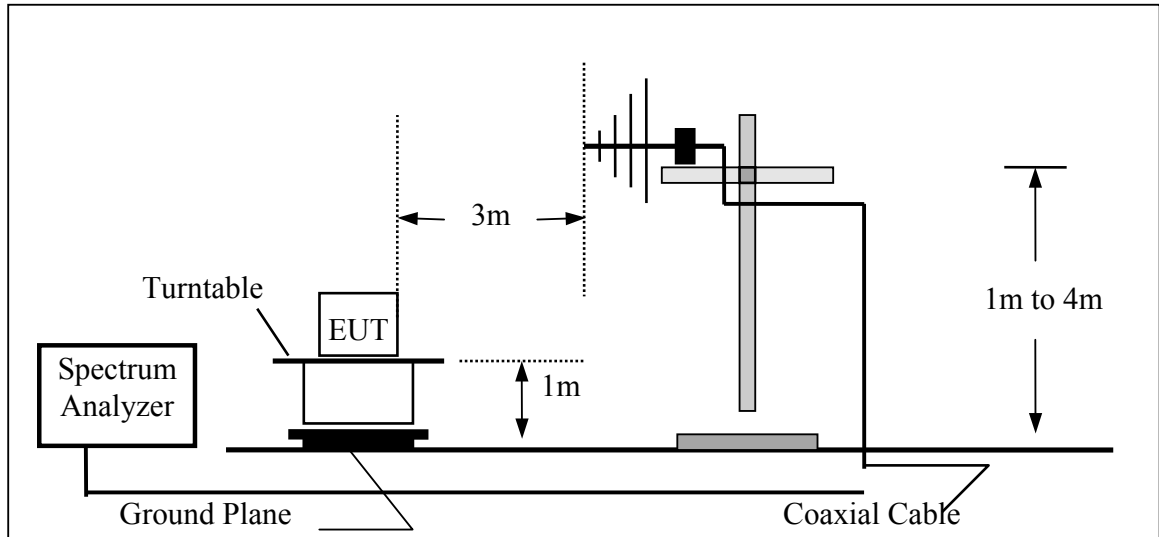

(B) Radiated Emission Test Set-UP Frequency Over 1 GHz

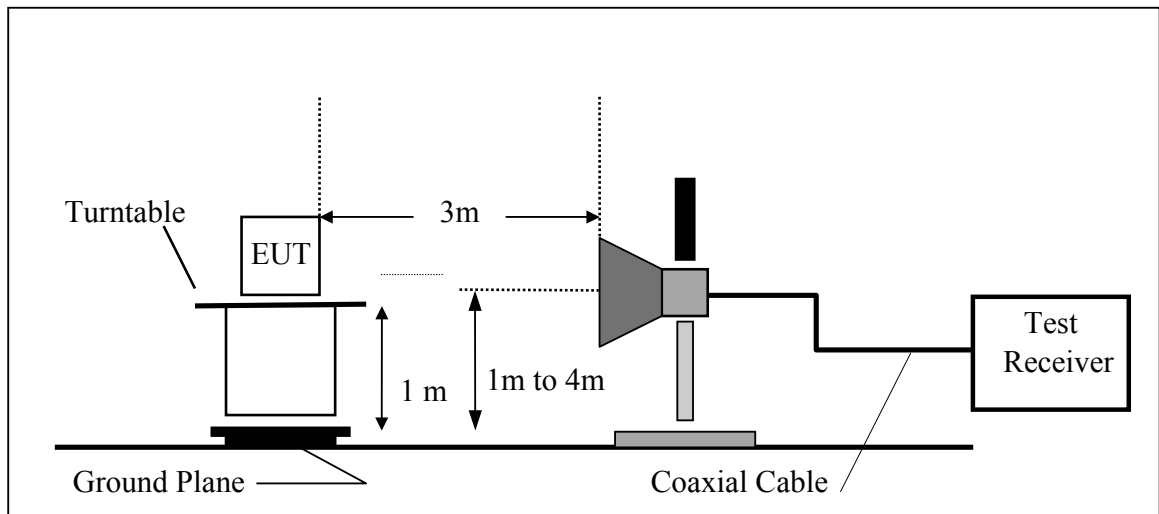

5.5 Measurement Equipment Used:

| Open Area Test Site # 3 | | | | | |
|-------------------------|------------|--------------|---------------|------------|------------|
| EQUIPMENT TYPE | MFR | MODEL NUMBER | SERIAL NUMBER | LAST CAL. | CAL DUE. |
| Spectrum Analyzer | ADVANTEST | R3261A | N/A | N/A | N/A |
| EMI Test Receiver | R&S | ESVS20 | 838804/004 | 01/09/2003 | 01/08/2004 |
| Pre-Amplifier | HP | 8447D | 2944A09173 | 03/04/2002 | 03/03/2003 |
| Bilog Antenna | SCHWAZBECK | VULB9163 | 145 | 07/06/2002 | 07/05/2003 |
| Turn Table | EMCO | 2081-1.21 | 9709-1885 | N.C.R | N.C.R |
| Antenna Tower | EMCO | 2075-2 | 9707-2060 | N.C.R | N.C.R |
| Controller | EMCO | 2090 | 9709-1256 | N.C.R | N.C.R |
| RF Switch | ANRITSU | MP59B | M53867 | N.C.R | N.C.R |
| Site NSA | C&C | N/A | N/A | 09/07/2002 | 09/06/2003 |

Field Strength Calculation

The field strength is calculated by adding the Antenna Factor and Cable Factor and subtracting the Amplifier Gain and Duty Cycle Correction Factor(if any) from the measured reading. The basic equation with a sample calculation is as follows:

$$FS = RA + AF + CL - AG$$

| | | |
|-------|------------------------|--|
| Where | FS = Field Strength | CL = Cable Attenuation Factor (Cable Loss) |
| | RA = Reading Amplitude | AG = Amplifier Gain |
| | AF = Antenna Factor | |

5.6 Measurement Result

Refer to attach tabular data sheets.

NOTE:

The resolution bandwidth and video bandwidth of test receiver/spectrum analyzer is 100kHz for Peak detection (PK) and Quasi-peak detection (QP) at frequency below 1GHz.

Conducted Spurious Emission Measurement Result

Ch Low

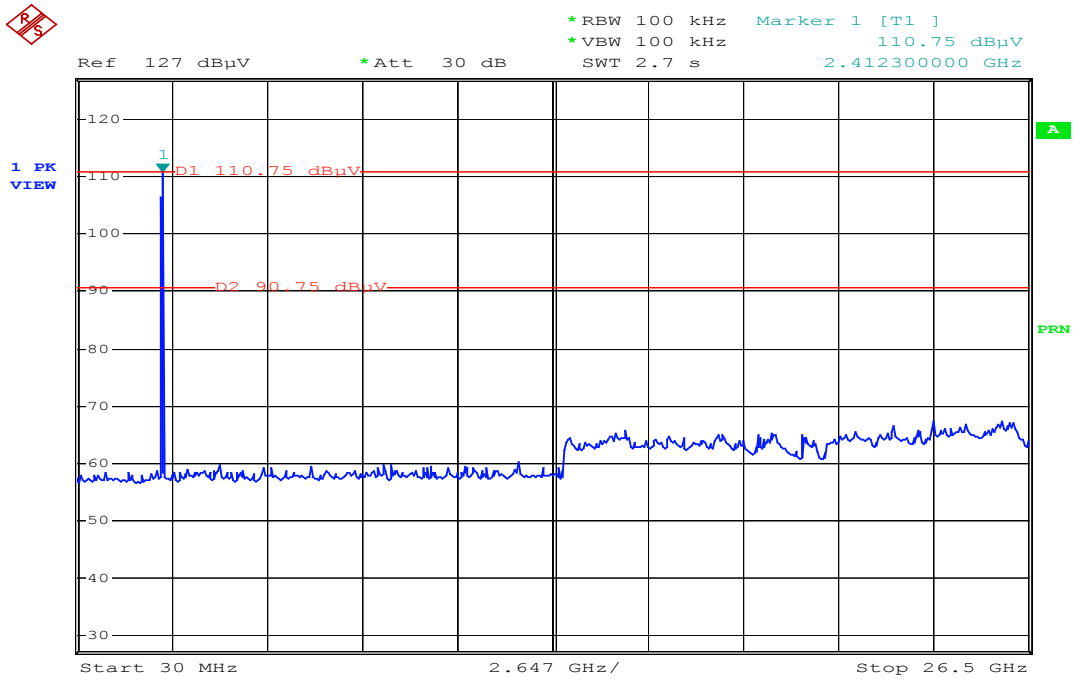

Date: 7.MAR.2003 10:56:12

Ch Mid

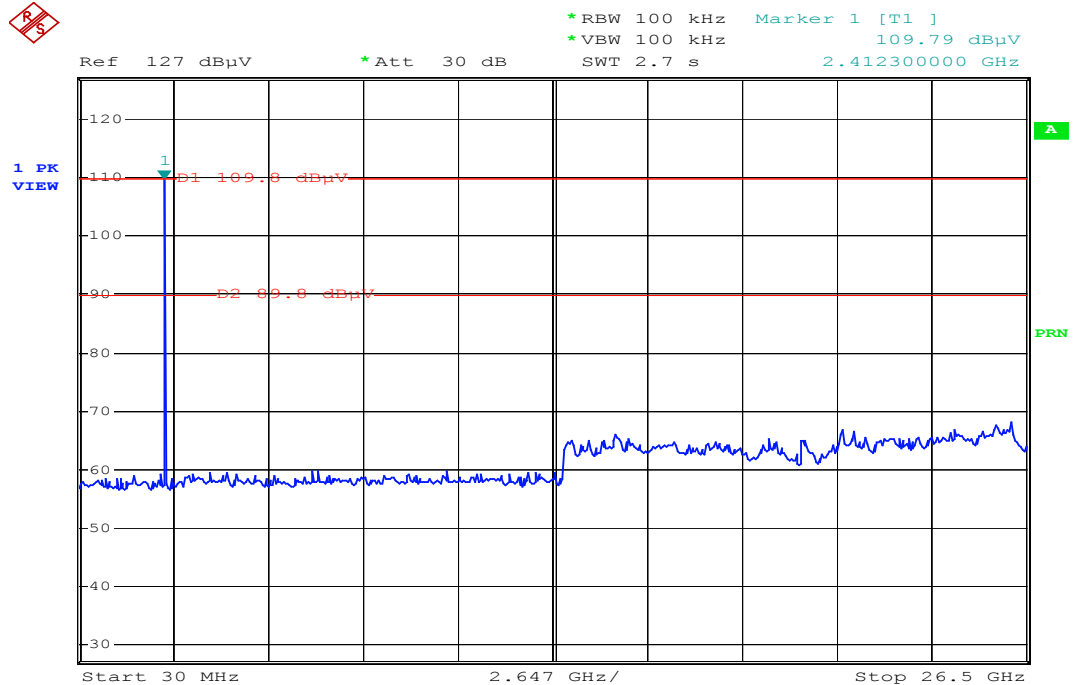

Date: 7.MAR.2003 10:54:55

Ch High



*RBW 100 kHz Marker 1 [T1]
*VBW 100 kHz 106.11 dBμV
SWT 2.7 s 2.465240000 GHz

Ref 127 dBμV *Att 30 dB

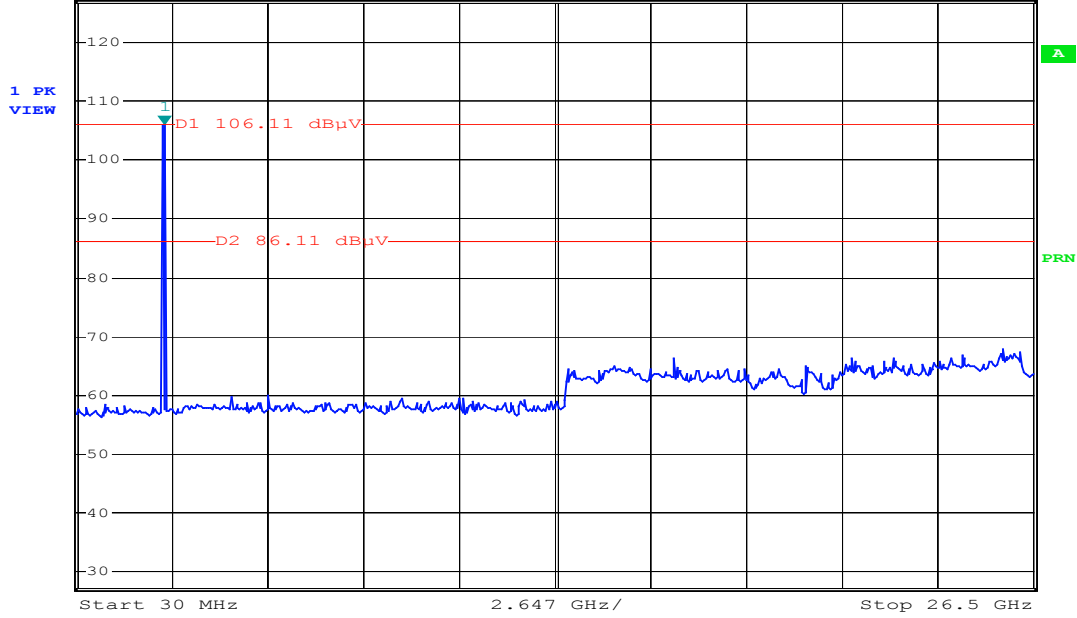

Date: 7.MAR.2003 10:57:27

Radiated Spurious Emission Measurement Result (below 1GHz)

| | | | |
|-----------------|----------------|-------------|--------------|
| Operation Mode: | TX CH Low Mode | Test Date : | Feb. 20 2003 |
| Temperature : | 23 °C | Test By: | Devin |
| Humidity : | 65 % | Pol: | Ver./Hor |

| Freq. | Ant.Pol. | Detector Mode | Reading | Actual FS | Limit 3m | Safe Margin |
|--------|----------|---------------|---------|-----------|----------|-------------|
| (MHz) | H/V | (PK/QP) | (dBuV) | (dBuV/m) | (dBuV/m) | (dB) |
| 106.95 | V | Peak | 7.47 | 13.24 | 43.50 | -22.79 |
| 228.45 | V | Peak | 7.90 | 15.46 | 46.00 | -22.64 |
| 260.85 | V | Peak | 8.18 | 16.05 | 46.00 | -21.77 |
| 521.67 | V | Peak | 7.67 | 23.28 | 46.00 | -15.05 |
| 587.00 | V | Peak | 4.71 | 25.09 | 46.00 | -16.20 |
| 652.33 | V | Peak | 5.01 | 24.92 | 46.00 | -16.07 |
| 912.50 | V | Peak | 1.74 | 28.33 | 46.00 | -15.93 |
| | | | | | | |
| 104.70 | H | Peak | 4.86 | 13.53 | 43.50 | -25.11 |
| 228.45 | H | Peak | 4.90 | 15.46 | 46.00 | -25.64 |
| 260.85 | H | Peak | 7.68 | 16.05 | 46.00 | -22.27 |
| 587.00 | H | Peak | 0.88 | 25.09 | 46.00 | -20.03 |
| 652.33 | H | Peak | 6.84 | 24.92 | 46.00 | -14.24 |
| 716.50 | H | Peak | 7.57 | 25.81 | 46.00 | -12.62 |
| 912.50 | H | Peak | 4.91 | 28.33 | 46.00 | -12.76 |

Remark :

- (1) Measuring frequencies from 30 MHz to the 1GHz °
- (2) Radiated emissions measured in frequency range from 30 MHz to 1000MHz were made with an instrument using Peak detector mode.
- (3) Datas of measurement within this frequency range shown “ - ” in the table above means the reading of emissions are attenuated more than 20dB below the permissible limits or the field strength is too small to be measured.
- (4) The IF bandwidth of SPA between 30MHz to 1GHz was 100KHz.

Radiated Spurious Emission Measurement Result (below 1GHz)

| | | | |
|-----------------|----------------|-------------|--------------|
| Operation Mode: | TX CH Mid Mode | Test Date : | Feb. 20 2003 |
| Temperature : | 23 °C | Test By: | Devin |
| Humidity : | 65 % | Pol: | Ver./Hor |

| Freq. | Ant.Pol. | Detector Mode | Reading | Actual FS | Limit3m | Safe Margin |
|--------|----------|---------------|---------|-----------|----------|-------------|
| (MHz) | H/V | (PK/QP) | (dBuV) | (dBuV/m) | (dBuV/m) | (dB) |
| 55.65 | V | Peak | 6.70 | 14.33 | 40.00 | -18.97 |
| 228.00 | V | Peak | 6.59 | 15.44 | 46.00 | -23.97 |
| 260.85 | V | Peak | 9.02 | 16.05 | 46.00 | -20.93 |
| 358.33 | V | Peak | 6.43 | 18.48 | 46.00 | -21.09 |
| 587.00 | V | Peak | 6.88 | 25.09 | 46.00 | -14.03 |
| 652.33 | V | Peak | 5.01 | 24.92 | 46.00 | -16.07 |
| 912.50 | V | Peak | 2.57 | 28.33 | 46.00 | -15.10 |
| 106.95 | H | Peak | 5.71 | 13.24 | 43.50 | -24.55 |
| 260.85 | H | Peak | 4.18 | 16.05 | 46.00 | -25.77 |
| 358.33 | H | Peak | 2.59 | 18.48 | 46.00 | -24.93 |
| 587.00 | H | Peak | 0.88 | 25.09 | 46.00 | -20.03 |
| 651.17 | H | Peak | 5.86 | 24.90 | 46.00 | -15.24 |
| 716.50 | H | Peak | 6.07 | 25.81 | 46.00 | -14.12 |
| 911.33 | H | Peak | 6.74 | 28.31 | 46.00 | -10.95 |

Remark :

- (1) Measuring frequencies from 30 MHz to the 1GHz ◦
- (2) Radiated emissions measured in frequency range from 30 MHz to 1000MHz were made with an instrument using Peak detector mode.
- (3) Datas of measurement within this frequency range shown “ - ” in the table above means the reading of emissions are attenuated more than 20dB below the permissible limits or the field strength is too small to be measured.
- (4) The IF bandwidth of SPA between 30MHz to 1GHz was 100KHz.

Radiated Spurious Emission Measurement Result (below 1GHz)

| | | | |
|-----------------|-----------------|-------------|--------------|
| Operation Mode: | TX CH High Mode | Test Date : | Feb. 20 2003 |
| Temperature : | 23 °C | Test By: | Devin |
| Humidity : | 65 % | Pol: | Vertical |

| Freq. | Ant.Pol. | Detector Mode | Reading | Actual FS | Limit3m | Safe Margin |
|--------|----------|---------------|---------|-----------|----------|-------------|
| (MHz) | H/V | (PK/QP) | (dBuV) | (dBuV/m) | (dBuV/m) | (dB) |
| 56.10 | V | Peak | 6.67 | 14.24 | 40.00 | -19.09 |
| 231.60 | V | Peak | 1.70 | 15.58 | 46.00 | -28.72 |
| 358.33 | V | Peak | 4.76 | 18.48 | 46.00 | -22.76 |
| 521.67 | V | Peak | 4.10 | 23.28 | 46.00 | -18.62 |
| 585.83 | V | Peak | 3.87 | 25.06 | 46.00 | -17.07 |
| 651.17 | V | Peak | 4.20 | 24.90 | 46.00 | -16.90 |
| 781.83 | V | Peak | 0.98 | 26.05 | 46.00 | -18.97 |
| 103.80 | H | Peak | 4.57 | 13.64 | 43.50 | -25.29 |
| 260.85 | H | Peak | 0.35 | 16.05 | 46.00 | -29.60 |
| 358.33 | H | Peak | 2.09 | 18.48 | 46.00 | -25.43 |
| 521.67 | H | Peak | 1.84 | 23.28 | 46.00 | -20.88 |
| 651.17 | H | Peak | 4.03 | 24.90 | 46.00 | -17.07 |
| 912.50 | H | Peak | 0.43 | 28.33 | 46.00 | -17.24 |

Remark :

- (1) Measuring frequencies from 30 MHz to the 1GHz ◦
- (2) Radiated emissions measured in frequency range from 30 MHz to 1000MHz were made with an instrument using Peak detector mode.
- (3) Datas of measurement within this frequency range shown “ - ” in the table above means the reading of emissions are attenuated more than 20dB below the permissible limits or the field strength is too small to be measured.
- (4) The IF bandwidth of SPA between 30MHz to 1GHz was 100KHz.

Radiated Spurious Emission Measurement Result (Above 1GHz)

| | | | |
|-----------------|----------------|-------------|--------------|
| Operation Mode: | TX CH Low Mode | Test Date : | Feb. 20 2003 |
| Temperature : | 23 °C | Test By: | Devin |
| Humidity : | 65 % | Pol: | Vertical |

| Freq. (MHz) | Peak | AV | Ant./CL CF(dB) | Actual FS | | Peak | AV | Margin (dB) |
|----------------|-------------------|-------------------|-------------------|------------------|----------------|-------------------|-------------------|----------------|
| | Reading (dBuV) | Reading (dBuV) | | Peak (dBuV/m) | AV (dBuV/m) | Limit (dBuV/m) | Limit (dBuV/m) | |
| 4824 | -- | | | | | 74.00 | 54.00 | |
| 7236 | -- | | | | | 74.00 | 54.00 | |
| 9648 | -- | | | | | 74.00 | 54.00 | |
| 12060 | -- | | | | | 74.00 | 54.00 | |
| 14472 | -- | | | | | 74.00 | 54.00 | |
| 16884 | -- | | | | | 74.00 | 54.00 | |
| 19296 | -- | | | | | 74.00 | 54.00 | |
| 21708 | -- | | | | | 74.00 | 54.00 | |
| 24120 | -- | | | | | 74.00 | 54.00 | |

Remark :

- (1) Measuring frequencies from 1 GHz to the 10th harmonic of highest fundamental frequency °
- (2) Datas of measurement within this frequency range shown “ - ” in the table above means the reading of emissions are attenuated more than 20dB below the permissible limits or the field strength is too small to be measured.
- (3) Radiated emissions measured in frequency above 1000MHz were made with an instrument using Peak detector mode and average detector mode of the emission shown in Actual FS column °
- (4) Spectrum Peak Setting 1GHz- 26GHz, RBW= 1MHz, VBW= 1MHz, Sweep time= 200 ms.
Spectrum AV Setting 1GHz- 26GHz, RBW= 1MHz, VBW= 10Hz, Sweep time= 200 ms.

Radiated Spurious Emission Measurement Result (Above 1GHz)

| | | | |
|-----------------|----------------|-------------|--------------|
| Operation Mode: | TX Low Mode | Test Date : | Feb. 20 2003 |
| Temperature : | 22 °C | Test By: | Devin |
| Humidity : | 65% | Pol: | Horizontal |
| Power Adaptor | ADP-60DB REV.B | | |

| Freq. (MHz) | Peak | AV | Ant./CL CF(dB) | Actual FS | | Peak | AV | Margin (dB) |
|----------------|-------------------|-------------------|-------------------|------------------|----------------|-------------------|-------------------|----------------|
| | Reading (dBuV) | Reading (dBuV) | | Peak (dBuV/m) | AV (dBuV/m) | Limit (dBuV/m) | Limit (dBuV/m) | |
| 4824 | -- | | | | | 74.00 | 54.00 | |
| 7236 | -- | | | | | 74.00 | 54.00 | |
| 9648 | -- | | | | | 74.00 | 54.00 | |
| 12060 | -- | | | | | 74.00 | 54.00 | |
| 14472 | -- | | | | | 74.00 | 54.00 | |
| 16884 | -- | | | | | 74.00 | 54.00 | |
| 19296 | -- | | | | | 74.00 | 54.00 | |
| 21708 | -- | | | | | 74.00 | 54.00 | |
| 24120 | -- | | | | | 74.00 | 54.00 | |

Remark :

- (1) Measuring frequencies from 1 GHz to the 10th harmonic of highest fundamental frequency °
- (2) Datas of measurement within this frequency range shown “ - ” in the table above means the reading of emissions are attenuated more than 20dB below the permissible limits or the field strength is too small to be measured.
- (3) Radiated emissions measured in frequency above 1000MHz were made with an instrument using Peak detector mode and average detector mode of the emission shown in Actual FS column °
- (4) Spectrum Peak Setting 1GHz- 26GHz, RBW= 1MHz, VBW= 1MHz, Sweep time= 200 ms.
Spectrum AV Setting 1GHz- 26GHz, RBW= 1MHz, VBW= 10Hz, Sweep time= 200 ms.

Radiated Spurious Emission Measurement Result (Above 1GHz)

| | | | |
|-----------------|-------------|-------------|--------------|
| Operation Mode: | TX Mid Mode | Test Date : | Feb. 20 2003 |
| Temperature : | 22 °C | Test By: | Devin |
| Humidity : | 65% | Pol: | Vertical |

| Freq. (MHz) | Peak | AV | Ant./CL CF(dB) | Actual FS | | Peak | AV | Margin (dB) |
|----------------|-------------------|-------------------|-------------------|------------------|----------------|-------------------|-------------------|----------------|
| | Reading (dBuV) | Reading (dBuV) | | Peak (dBuV/m) | AV (dBuV/m) | Limit (dBuV/m) | Limit (dBuV/m) | |
| 4888 | -- | | | | | 74.00 | 54.00 | |
| 7332 | -- | | | | | 74.00 | 54.00 | |
| 9776 | -- | | | | | 74.00 | 54.00 | |
| 12220 | -- | | | | | 74.00 | 54.00 | |
| 14664 | -- | | | | | 74.00 | 54.00 | |
| 17108 | -- | | | | | 74.00 | 54.00 | |
| 19552 | -- | | | | | 74.00 | 54.00 | |
| 21996 | -- | | | | | 74.00 | 54.00 | |
| 24440 | -- | | | | | 74.00 | 54.00 | |

Remark :

- (1) Measuring frequencies from 1 GHz to the 10th harmonic of highest fundamental frequency ◦
- (2) Datas of measurement within this frequency range shown “ - ” in the table above means the reading of emissions are attenuated more than 20dB below the permissible limits or the field strength is too small to be measured.
- (3) Radiated emissions measured in frequency above 1000MHz were made with an instrument using Peak detector mode and average detector mode of the emission shown in Actual FS column ◦
- (4) Spectrum Peak Setting 1GHz- 26GHz, RBW= 1MHz, VBW= 1MHz, Sweep time= 200 ms.
Spectrum AV Setting 1GHz- 26GHz, RBW= 1MHz, VBW= 10Hz, Sweep time= 200 ms.

Radiated Spurious Emission Measurement Result (Above 1GHz)

| | | | |
|-----------------|-------------|-------------|--------------|
| Operation Mode: | TX Mid Mode | Test Date : | Feb. 20 2003 |
| Temperature : | 22 °C | Test By: | Devin |
| Humidity : | 65% | Pol: | Horizontal |

| Freq. (MHz) | Peak | AV | Ant./CL CF(dB) | Actual FS | | Peak | AV | Margin (dB) |
|----------------|-------------------|-------------------|-------------------|------------------|----------------|-------------------|-------------------|----------------|
| | Reading (dBuV) | Reading (dBuV) | | Peak (dBuV/m) | AV (dBuV/m) | Limit (dBuV/m) | Limit (dBuV/m) | |
| 4888 | -- | | | | | 74.00 | 54.00 | |
| 7332 | -- | | | | | 74.00 | 54.00 | |
| 9776 | -- | | | | | 74.00 | 54.00 | |
| 12220 | -- | | | | | 74.00 | 54.00 | |
| 14664 | -- | | | | | 74.00 | 54.00 | |
| 17108 | -- | | | | | 74.00 | 54.00 | |
| 19552 | -- | | | | | 74.00 | 54.00 | |
| 21996 | -- | | | | | 74.00 | 54.00 | |
| 24440 | -- | | | | | 74.00 | 54.00 | |

Remark :

- (1) Measuring frequencies from 1 GHz to the 10th harmonic of highest fundamental frequency ◦
- (2) Datas of measurement within this frequency range shown “ - ” in the table above means the reading of emissions are attenuated more than 20dB below the permissible limits or the field strength is too small to be measured.
- (3) Radiated emissions measured in frequency above 1000MHz were made with an instrument using Peak detector mode and average detector mode of the emission shown in Actual FS column ◦
- (4) Spectrum Peak Setting 1GHz- 26GHz, RBW= 1MHz, VBW= 1MHz, Sweep time= 200 ms.
Spectrum AV Setting 1GHz- 26GHz, RBW= 1MHz, VBW= 10Hz, Sweep time= 200 ms.

Radiated Spurious Emission Measurement Result (Above 1GHz)

| | | | |
|-----------------|--------------|-------------|--------------|
| Operation Mode: | TX High Mode | Test Date : | Feb. 20 2003 |
| Temperature : | 22 °C | Test By: | Devin |
| Humidity : | 65% | Pol: | Vertital |

| Freq. (MHz) | Peak | AV | Ant./CL CF(dB) | Actual FS | | Peak | AV | Margin (dB) |
|----------------|-------------------|-------------------|-------------------|------------------|----------------|-------------------|-------------------|----------------|
| | Reading (dBuV) | Reading (dBuV) | | Peak (dBuV/m) | AV (dBuV/m) | Limit (dBuV/m) | Limit (dBuV/m) | |
| 4924 | -- | | | | | 74.00 | 54.00 | |
| 7386 | -- | | | | | 74.00 | 54.00 | |
| 9848 | -- | | | | | 74.00 | 54.00 | |
| 12310 | -- | | | | | 74.00 | 54.00 | |
| 14772 | -- | | | | | 74.00 | 54.00 | |
| 17234 | -- | | | | | 74.00 | 54.00 | |
| 19696 | -- | | | | | 74.00 | 54.00 | |
| 22158 | -- | | | | | 74.00 | 54.00 | |
| 24620 | -- | | | | | 74.00 | 54.00 | |

Remark :

- (1) Measuring frequencies from 1 GHz to the 10th harmonic of highest fundamental frequency °
- (2) Datas of measurement within this frequency range shown “ - ” in the table above means the reading of emissions are attenuated more than 20dB below the permissible limits or the field strength is too small to be measured.
- (3) Radiated emissions measured in frequency above 1000MHz were made with an instrument using Peak detector mode and average detector mode of the emission shown in Actual FS column °
- (4) Spectrum Peak Setting 1GHz- 26GHz, RBW= 1MHz, VBW= 1MHz, Sweep time= 200 ms.
Spectrum AV Setting 1GHz- 26GHz, RBW= 1MHz, VBW= 10Hz, Sweep time= 200 ms.

Radiated Spurious Emission Measurement Result (Above 1GHz)

| | | | |
|-----------------|--------------|-------------|--------------|
| Operation Mode: | TX High Mode | Test Date : | Feb. 20 2003 |
| Temperature : | 22 °C | Test By: | Devin |
| Humidity : | 65% | Pol: | Horizontal |

| Freq. (MHz) | Peak | AV | Ant./CL CF(dB) | Actual FS | | Peak | AV | Margin (dB) |
|----------------|-------------------|-------------------|-------------------|----------------|--------------|-------------------|-------------------|----------------|
| | Reading (dBuV) | Reading (dBuV) | | Peak dBuV/m | AV dBuV/m | Limit (dBuV/m) | Limit (dBuV/m) | |
| 4924 | -- | | | | | 74.00 | 54.00 | |
| 7386 | -- | | | | | 74.00 | 54.00 | |
| 9848 | -- | | | | | 74.00 | 54.00 | |
| 12310 | -- | | | | | 74.00 | 54.00 | |
| 14772 | -- | | | | | 74.00 | 54.00 | |
| 17234 | -- | | | | | 74.00 | 54.00 | |
| 19696 | -- | | | | | 74.00 | 54.00 | |
| 22158 | -- | | | | | 74.00 | 54.00 | |
| 24620 | -- | | | | | 74.00 | 54.00 | |

Remark :

- (1) Measuring frequencies from 1 GHz to the 10th harmonic of highest fundamental frequency °
- (2) Datas of measurement within this frequency range shown “ - ” in the table above means the reading of emissions are attenuated more than 20dB below the permissible limits or the field strength is too small to be measured.
- (3) Radiated emissions measured in frequency above 1000MHz were made with an instrument using Peak detector mode and average detector mode of the emission shown in Actual FS column °
- (4) Spectrum Peak Setting 1GHz- 26GHz, RBW= 1MHz, VBW= 1MHz, Sweep time= 200 ms.
Spectrum AV Setting 1GHz- 26GHz, RBW= 1MHz, VBW= 10Hz, Sweep time= 200 ms.

6. AC POWER LINE CONDUCTED EMISSION TEST

6.1 Standard Applicable

According to §15.207. frequency within 150KHz to 30MHz shall not exceed

| Frequency range MHz | Limits dB(uV) | |
|------------------------|------------------|----------|
| | Quasi-peak | Average |
| 0.15 to 0.50 | 66 to 56 | 56 to 46 |
| 0.50 to 5 | 56 | 46 |
| 5 to 30 | 60 | 50 |

Note

- 1.The lower limit shall apply at the transition frequencies
- 2.The limit decreases linearly with the logarithm of the frequency in the range 0.15 MHz to 0.50 MHz.

6.2 EUT Setup

1. The conducted emission tests were performed in the test site, using the setup in accordance with the ANSI C63.4-1992.
2. The EUT was plug-in the host PC via USB port. The host PC system was placed on the center of the back edge on the test table. The peripherals like modem, monitor printer, K/B, and mouse were placed on the side of the host PC system. The rear of the EUT and peripherals were placed flushed with the rear of the tabletop.
3. The keyboard was placed directly in the front of the monitor, flushed with the front tabletop. The mouse was placed next to the Keyboard, flushed with the back of keyboard.
4. The spacing between the peripherals was 10 centimeters.
5. External I/O cables were draped along the edge of the test table and bundle when necessary.
6. The host PC system was connected with 110Vac/60Hz power source.

6.3 Measurement Procedure

1. The EUT was placed on a table which is 0.8m above ground plane.
2. Maximum procedure was performed on the six highest emissions to ensure EUT compliance.
3. Repeat above procedures until all frequency measured were complete.

6.4 Measurement Equipment Used:

| Conducted Emission Test Site # 3 | | | | | |
|----------------------------------|-----------|--------------|---------------|------------|------------|
| EQUIPMENT TYPE | MFR | MODEL NUMBER | SERIAL NUMBER | LAST CAL. | CAL DUE. |
| EMI Test Receiver | R&S | ESCS30 | 847793/012 | 12/21/2002 | 12/20/2003 |
| LISN | R&S | ESH2-Z5 | 843285/010 | 12/16/2002 | 12/15/2003 |
| LISN | EMCO | 3825/2 | 9003-1628 | 07/26/2002 | 07/25/2003 |
| Spectrum Analyzer | ADVANTEST | R3261A | 91720031 | N/A | N/A |
| 2X2 WIRE ISN | R&S | ENY22 | 100020 | 06/20/2002 | 06/19/2003 |
| FOUR WIRE ISN | R&S | ENY41 | 100006 | 06/20/2002 | 06/19/2003 |

6.5 Measurement Result

The initial step in collecting conducted data is a spectrum analyzer peak scan of the measurement range. Significant peaks are then marked as shown on the following data page, and these signals are then quasi-peaked.

AC POWER LINE CONDUCTED EMISSION TEST

| | | | | | |
|-----------------|--------------|------------|-----|-------------|--------------|
| Operation Mode: | TX + RX Mode | | | Test Date : | Feb. 20 2003 |
| Temperature : | 24 °C | Humidity : | 62% | Test By: | Devin |

| FREQ | P.K. | Q.P. | AVG | Q.P. | AVG | Q.P. | AVG | NOTE |
|-------|-------|-------|-------|-------|-------|--------|--------|------|
| | Raw | Raw | Raw | Limit | Limit | Margin | Margin | |
| MHz | dBuV | dBuV | dBuV | dBuV | dBuV | dB | dB | |
| 0.153 | 66.50 | 47.30 | 39.40 | 65.84 | 55.84 | -18.54 | -16.44 | L1 |
| 0.220 | 51.70 | 40.20 | 33.50 | 62.82 | 52.82 | -22.62 | -19.32 | L1 |
| 0.291 | 42.50 | --- | --- | 60.50 | 50.50 | --- | --- | L1 |
| 0.417 | 36.20 | --- | --- | 57.51 | 47.51 | --- | --- | L1 |
| 0.774 | 27.80 | --- | --- | 56.00 | 46.00 | --- | --- | L1 |
| 0.971 | 29.00 | --- | --- | 56.00 | 46.00 | --- | --- | L1 |
| 0.155 | 66.30 | 48.10 | 40.20 | 65.73 | 55.73 | -17.63 | -15.53 | L2 |
| 0.220 | 52.30 | 41.60 | 33.80 | 62.82 | 52.82 | -21.22 | -19.02 | L2 |
| 0.290 | 40.50 | --- | --- | 60.52 | 50.52 | --- | --- | L2 |
| 0.410 | 36.20 | --- | --- | 57.65 | 47.65 | --- | --- | L2 |
| 0.969 | 27.70 | --- | --- | 56.00 | 46.00 | --- | --- | L2 |
| 2.029 | 25.90 | --- | --- | 56.00 | 46.00 | --- | --- | L2 |

Remark :

- (1) Measuring frequencies from 0.15 MHz to 30MHz °
The emissions measured in frequency range from 0.15 MHz to 30MHz were made with an
- (2) instrument using Qusia-Peak detector and Average detector.
“---” denotes the emission level was or more than 2dB below the Average limit,
- (3) so no re-check anymore.
The IF bandwidth of SPA between 0.15MHz to 30MHz was 10KHz;
- (4) The IF bandwidth of Test Receiver between 0.15MHz to 30MHz was 9KHz;
- (5) L1 = Line One (Hot side) / L2 = Line Two (Neutral side)

Conducted Test Data

C&C Lab. Co. Shielded Room3
EN 55022 - Class B QP/AV Limit

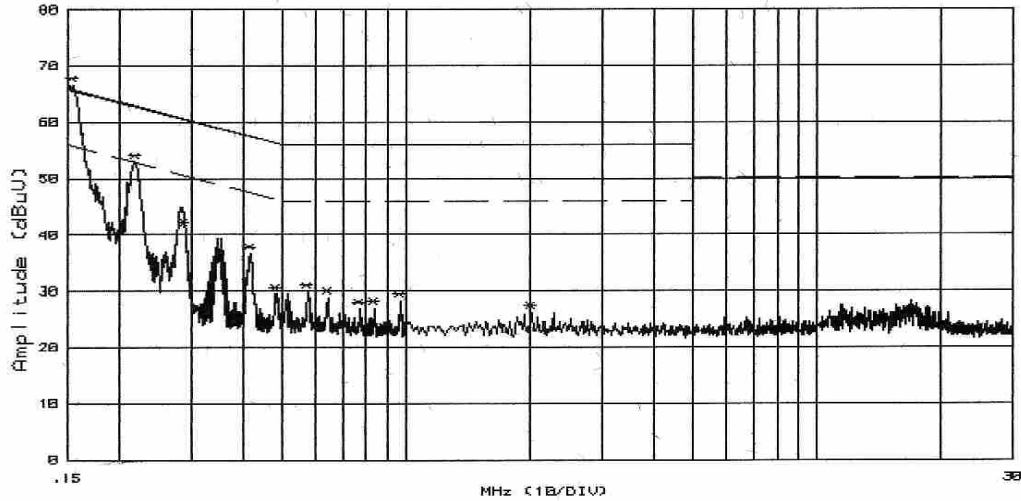

| | | |
|------------------------------|--------------|----------------------------|
| Customer:First | File#: 1258 | Date :21 Feb 2003 08:13:38 |
| Model :MB02 | Humd.:65 (%) | Temp. :17 (C) |
| Mode :110V | Port :L2 | Tested by:DEVIN |
| Reading :Peak(R3261C SPA) | | |
| Remark :Bluetooth USB Dongle | | |

LINE 2

C&C Lab. Co. Shielded Room3
EN 55022 - Class B QP/AV Limit

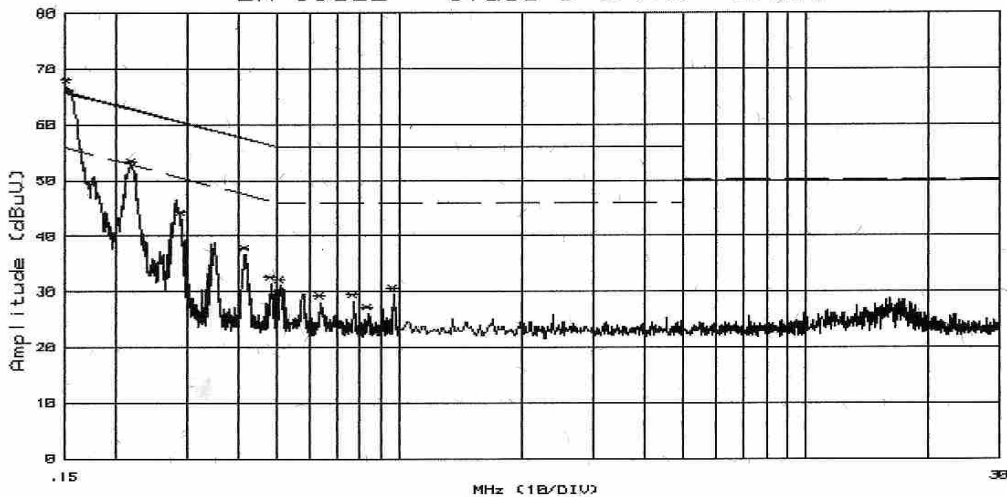

| | | |
|------------------------------|--------------|----------------------------|
| Customer:First | File#: 1257 | Date :21 Feb 2003 08:10:26 |
| Model :MB02 | Humd.:65 (%) | Temp. :17 (C) |
| Mode :110V | Port :L1 | Tested by:DEVIN |
| Reading :Peak(R3261C SPA) | | |
| Remark :Bluetooth USB Dongle | | |

7. 6 dB Bandwidth Measurement

7.1 Standard Applicable

According to § 15.247(a)(2), DSSS Systems operating in the 2400MHz-2483.5MHz and 5725MHz – 5850MHz bands. The Minimum 6dB bandwidth shall be at least 500KHz.

7.2 Measurement Equipment Used:

| EQUIPMENT TYPE | MFR | Model No. | Serial No. | LAST CAL. | Cal. Due. |
|-------------------|----------------|--------------|--------------|------------|------------|
| Spectrum Analyzer | Advantest | R3182 | 110600647 | 11/16/2002 | 11/15/2003 |
| Spectrum Analyzer | R&S | FSP30 | 1093.4495.30 | 07/23/2002 | 07/22/2003 |
| low loss cable | Huber + Suhner | Sucoflex 104 | N/A | N/A | N/A |

7.3 Test Setup:

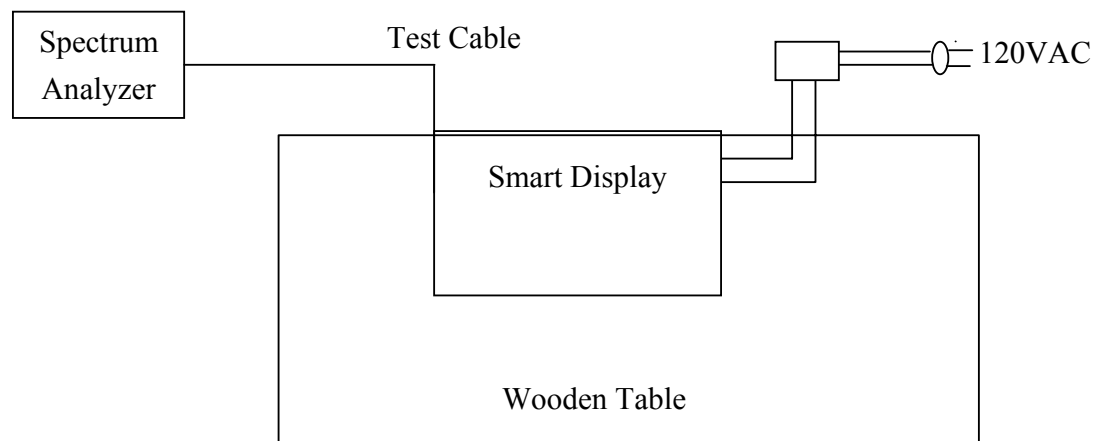

Fig. 4

Fig. 4 : Measurement setup for testing on Antenna connector



7.4 Measurement Procedure

1. Place the EUT on the table and set it in transmitting mode.
2. Remove the antenna from the EUT and then connect a low loss RF cable from the antenna port to the spectrum analyzer.
3. Set the spectrum analyzer as RBW=100KHz, VBW = RBW, Span= 20MHz, Sweep=auto
4. Mark the peak frequency and -6dB (upper and lower) frequency.
5. Repeat above procedures until all frequency measured were complete.

7.5 Measurement Result

| Channel | Bandwidth(MHz) | Bandwidth (MHz) | Result |
|---------|----------------|-----------------|--------|
| Low | 12.04 | > 500 | PASS |
| Mid | 11.96 | > 500 | PASS |
| High | 12.24 | > 500 | PASS |



6dB Band Width Test Data CH-LOW

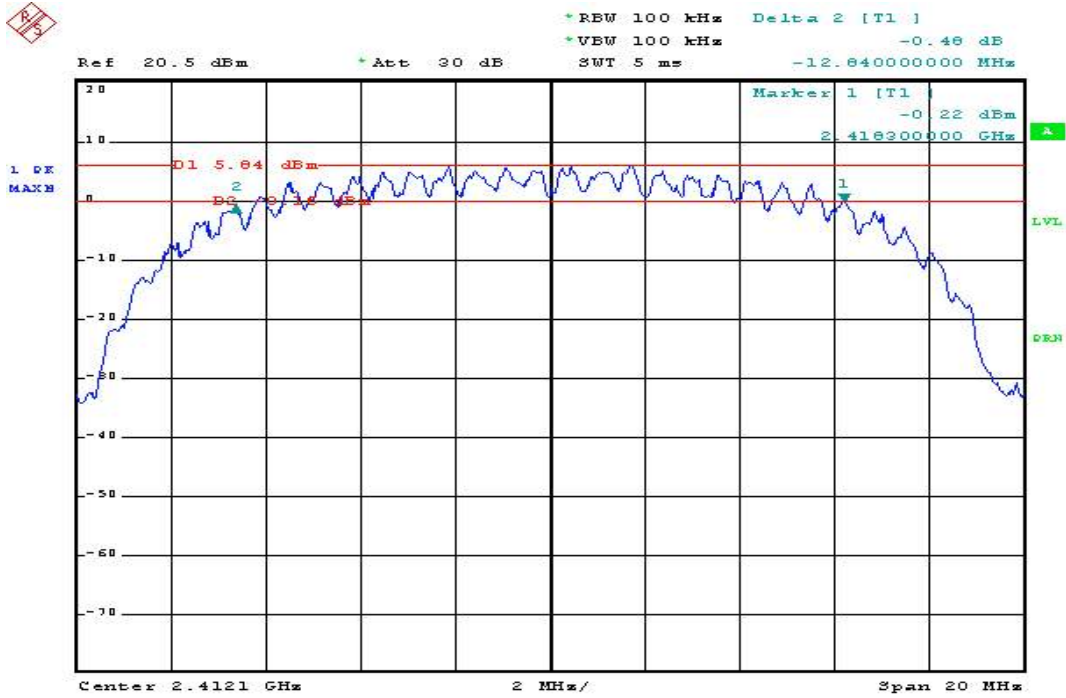

Date: 21.FEB.2003 03:36:25

6dB Band Width Test Data CH-MID

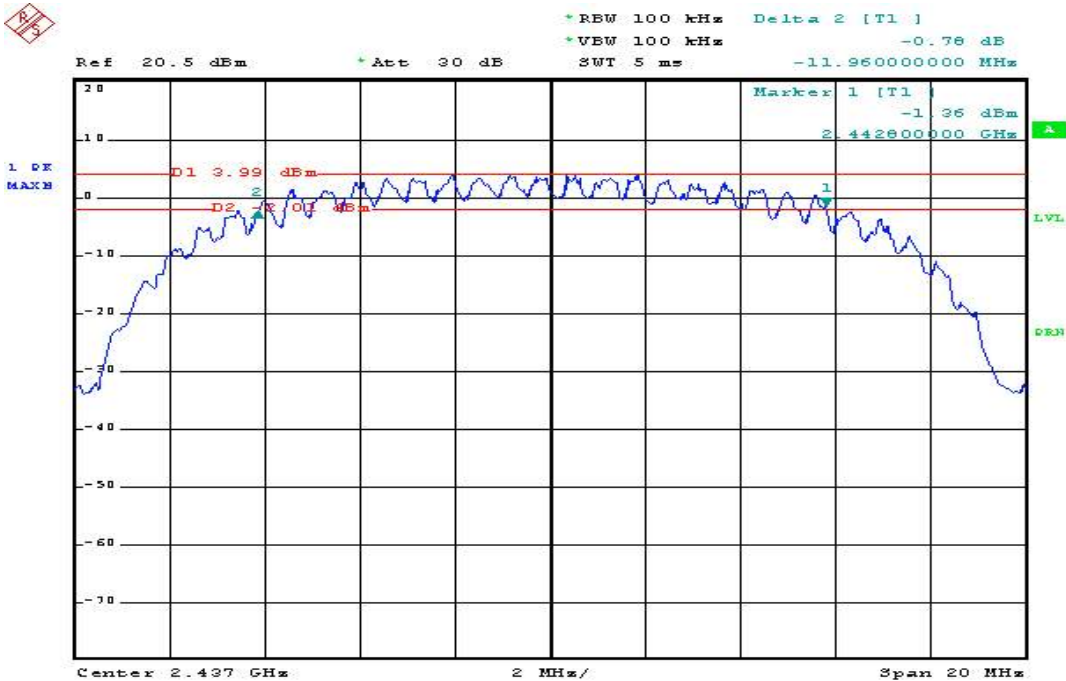

Date: 21.FEB.2003 03:39:01

6dB Band Width Test Data CH-HIGH

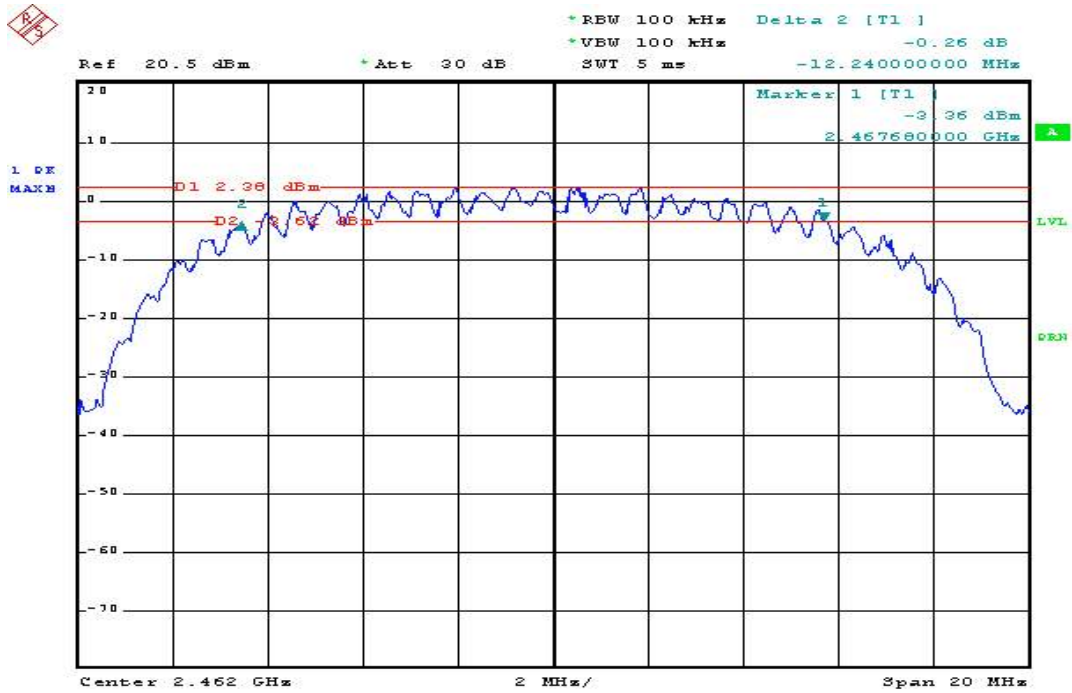

Date: 21.FEB.2003 03:41:28

8. PEAK OUTPUT POWER MEASUREMENT

8.1 Standard Applicable

According to §15.247(b)(2), for direct sequence systems, the maximum peak output power of the intentional radiator shall not exceed 1 Watt.

8.2 Test Setup

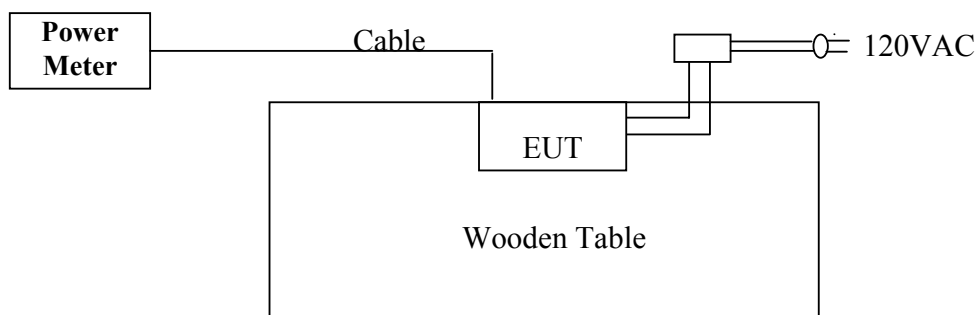

8.3 Measurement Equipment Used:

| EQUIPMENT TYPE | MFR | Model No. | Serial No. | LAST CAL. | Cal. Due. |
|----------------|----------------|--------------|------------|------------|------------|
| RF Power Meter | BOONTON | 4531 | 130601 | 01/11/2003 | 01/10/2004 |
| low loss cable | Huber + Suhner | Sucoflex 104 | N/A | N/A | N/A |

8.4 Test Results:

| Channel | Reading Power (dBm) | Cable Loss (dB) | Output Power (dBm) | Output Power (W) | Limit (W) | Result |
|---------|---------------------|-----------------|--------------------|------------------|-----------|--------|
| Low | 16.08 | 0.30 | 16.38 | 0.04345 | 1 | PASS |
| Mid | 15.32 | 0.30 | 15.62 | 0.03648 | 1 | PASS |
| High | 13.76 | 0.30 | 14.06 | 0.02547 | 1 | PASS |

9. 100KHz BANDWIDTH OF BAND EDGES MEASUREMENT

9.1 Standard Applicable

According to §15.247(c), in any 100 KHz bandwidth outside the frequency bands in which the spread spectrum intentional radiator is operating, the radio frequency power that is produced by the intentional radiator shall be at least 20dB below that in the 100KHz bandwidth within the band that contains the highest level of the desired power, In addition, radiated emissions which fall in the restricted bands, as defined in §15.205(a), must also comply with the radiated emission limits specified in 15.209(a).

9.2 Measurement Procedure

1. Place the EUT on the table and set it in transmitting mode.
2. Remove the antenna from the EUT and then connect a low loss RF cable from the antenna port to the spectrum analyzer.
3. Set center frequency of spectrum analyzer = operating frequency.
4. Set the spectrum analyzer as RBW, VBW=100KHz, Center Freq. 2.39GHz, 2.4835GHz, Span=100MHz, Sweep = auto.
5. Mark Peak ,2.4GHz and 2.4835GHz and record the max. level.
6. Repeat above procedures until all frequency measured were complete.

9.3 Measurement Result

Refer to attach spectrum analyzer data chart.

9.4 Measurement Equipment Used:

| EQUIPMENT TYPE | MFR | Model No. | Serial No. | LAST CAL. | Cal. Due. |
|-------------------|----------------|--------------|--------------|------------|------------|
| Spectrum Analyzer | Advantest | R3182 | 110600647 | 11/16/2002 | 11/15/2003 |
| Spectrum Analyzer | R&S | FSP30 | 1093.4495.30 | 07/23/2002 | 07/22/2003 |
| low loss cable | Huber + Suhner | Sucoflex 104 | N/A | N/A | N/A |



Out of Band Test Data CH-LOW

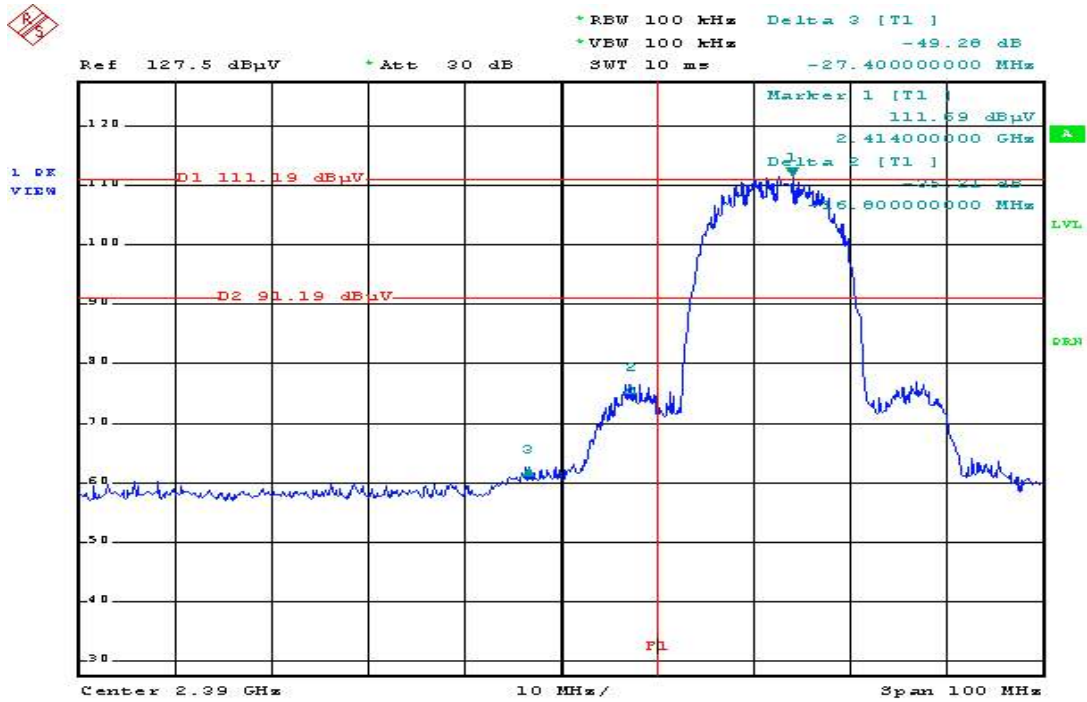

Date: 21.FEB.2003 04:12:39

Out of Band Test Data CH-HIGH

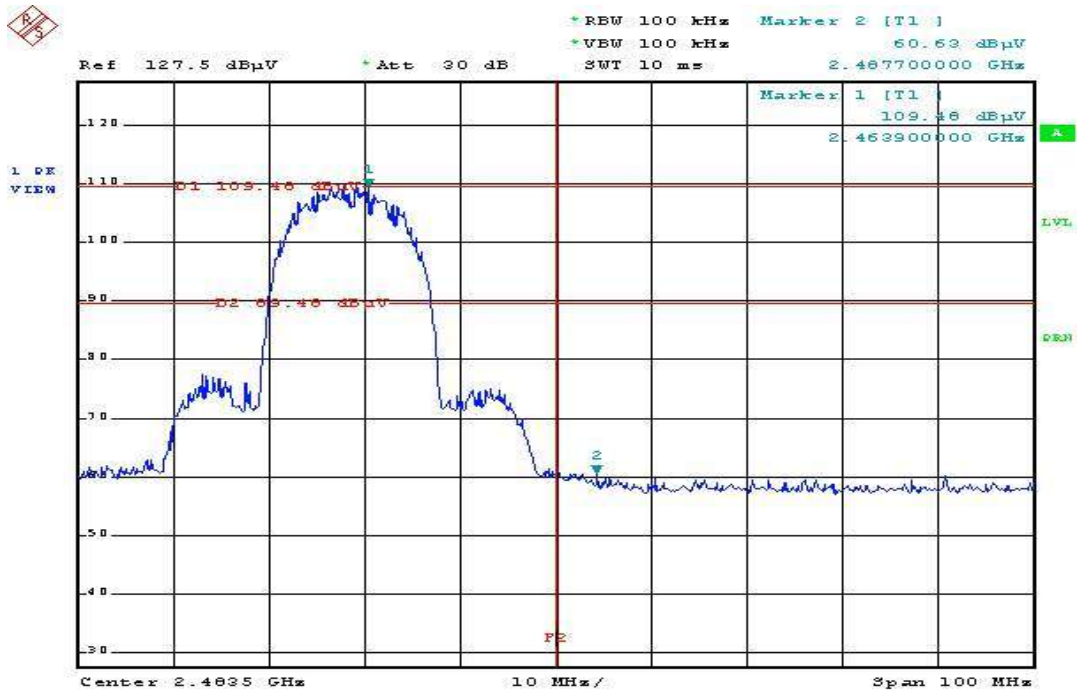

Date: 21.FEB.2003 04:09:56

10. Peak Power Spectral Density

10.1 Standard Applicable

According to §15.247(d), for direct sequence systems, the peak power spectral density conducted from the intentional radiator to the antenna shall not be greater than 8 dBm in any 3kHz band during any time interval of continuous transmission.

10.2 Measurement Procedure

1. Place the EUT on the table and set it in transmitting mode.
2. Remove the antenna from the EUT and then connect a low loss RF cable from the antenna port to the spectrum analyzer.
3. Set the spectrum analyzer as RBW = 3KHz, VBW = 10KHz, Span = 300KHz, Sweep=100s
4. Record the max. reading.
5. Repeat above procedures until all frequency measured were complete.

10.3 Measurement Result

| CHANNE L | Reading dBm | Cable Loss dB | Density dBm | Limint dBm | Result |
|-------------|----------------|------------------|----------------|---------------|--------|
| Low | -3.36 | 0.30 | -3.06 | 8 | PASS |
| Mid | -3.82 | 0.30 | -3.52 | 8 | PASS |
| High | -5.23 | 0.30 | -4.93 | 8 | PASS |

10.4 Measurement Equipment Used:

| EQUIPMENT TYPE | MFR | Model No. | Serial No. | LAST CAL. | Cal. Due. |
|-------------------|----------------|--------------|--------------|------------|------------|
| Spectrum Analyzer | Advantest | R3182 | 110600647 | 11/16/2002 | 11/15/2003 |
| Spectrum Analyzer | R&S | FSP30 | 1093.4495.30 | 07/23/2002 | 07/22/2003 |
| low loss cable | Huber + Suhner | Sucoflex 104 | N/A | N/A | N/A |

Power Density Test Data CH-LOW

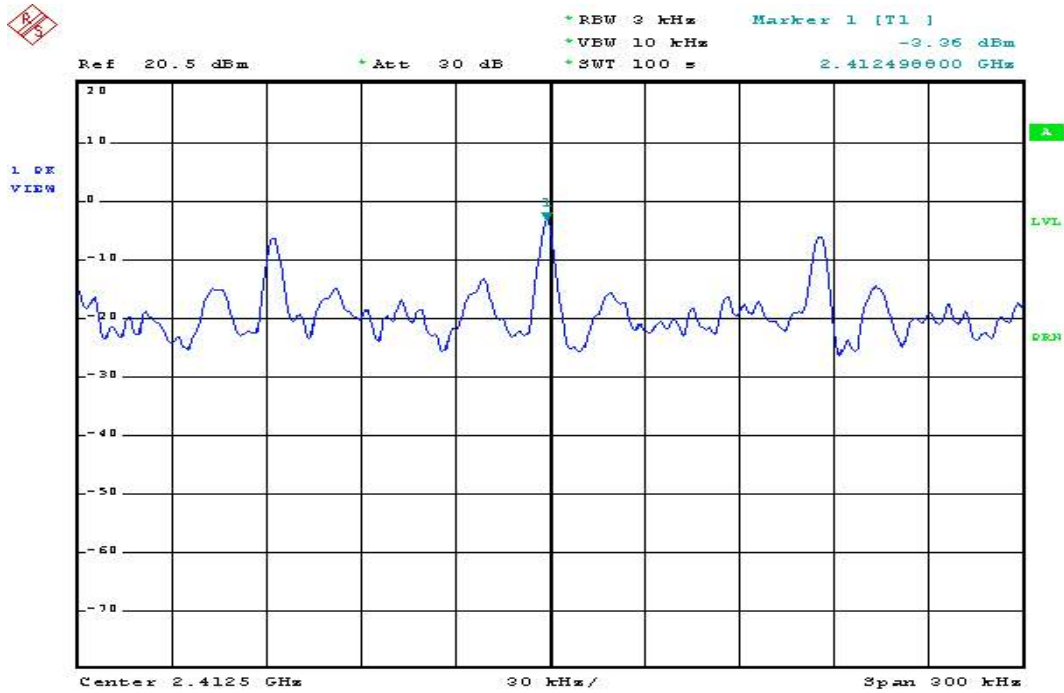

Date: 21.FEB.2003 04:17:37

Power Density Test Data CH-MID

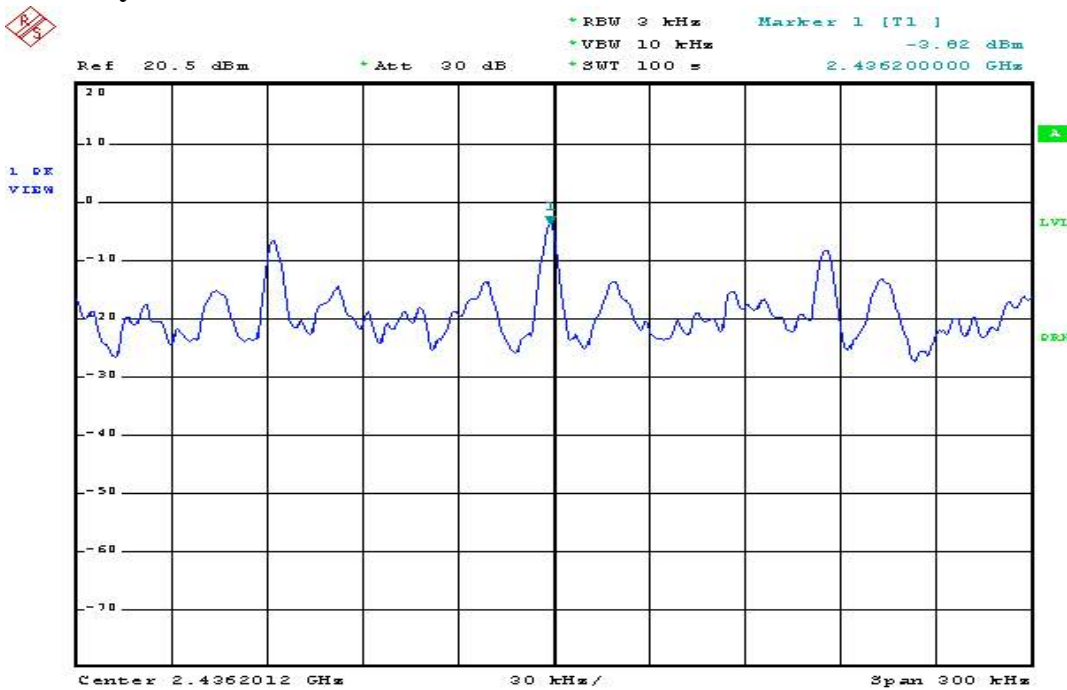

Date: 21.FEB.2003 03:56:17

Power Density Test Data CH-HIGH

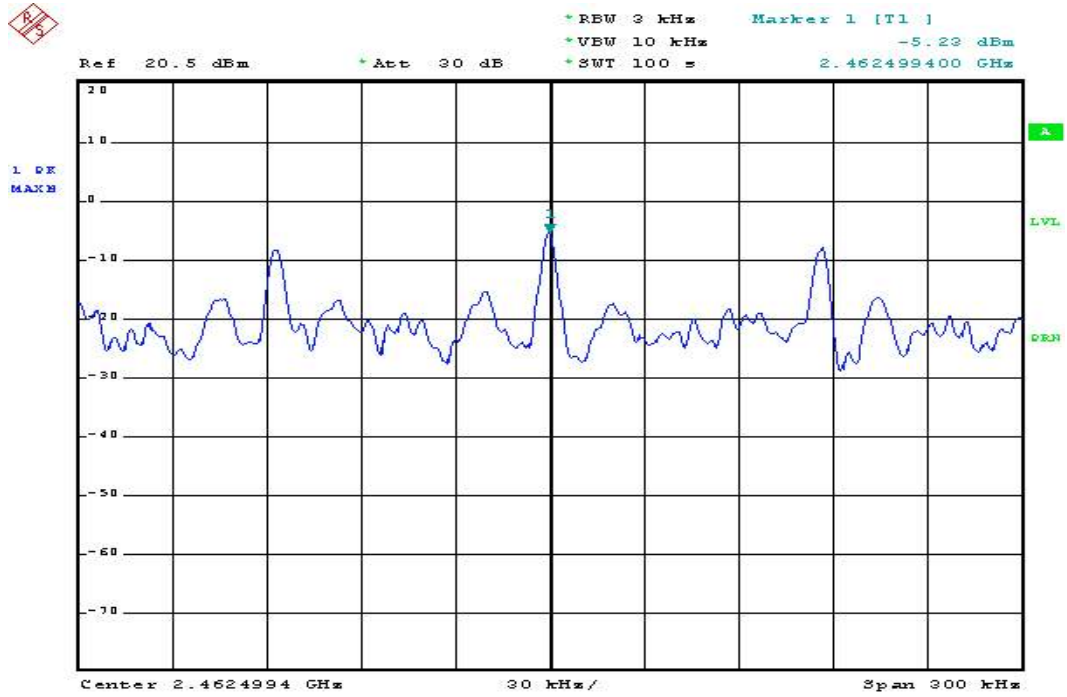

Date: 21.FEB.2003 03:52:00



11. ANTENNA REQUIREMENT

11.1 Standard Applicable

For intentional device, according to §15.203, an intentional radiator shall be designed to ensure that no antenna other than furnished by the responsible party shall be used with the device.

And according to §15.247(i), if transmitting antennas of directional gain greater than 6dBi are used the power shall be reduced by the amount in 1dB that the directional gain of the antenna exceeds 6 dBi.

11.2 Antenna Connected Construction

The directional gains of antenna used for transmitting is 2.57 dBi, and the antenna connector is designed with permanent attachment and no consideration of replacement. Please see EUT photo for details.

12. RF Exposure

12.1 Standard Applicable

According to §15.247(b)(4) and §1.1307(b)(1), systems operating under the provisions of this section shall be operated in a manner that ensure that the public is not exposed to radio frequency energy level in excess of the Commission's guideline.

The device is class as a Mobile device.

According to §1.1310 and §2.1093 RF exposure is calculated.

Limits for Maximum Permissible Exposure (MPE)

| Frequency Range (MHz) | Electric Field Strength (V/m) | Magnetic Field Strength (A/m) | Power Density (mW/cm ²) | Averaging Time (minute) |
|---|-------------------------------|-------------------------------|-------------------------------------|-------------------------|
| Limits for General Population/Uncontrolled Exposure | | | | |
| 0.3-1.34 | 614 | 1.63 | *(100) | 30 |
| 1.34-30 | 824/f | 2.19/f | *(180/f ²) | 30 |
| 30-300 | 27.5 | 0.073 | 0.2 | 30 |
| 300-1500 | / | / | F/1500 | 30 |
| 1500-15000 | / | / | 1.0 | 30 |

F = frequency in MHz

* = Plane-wave equipment power density



MPE Prediction

Prediction of MPE limit at a given distance

Equation from page 18 of OET Bulletin 65, Edition 97-01

$$S = \frac{PG}{4\pi R^2}$$

Where: S = Power density

P = Power input to antenna

G = Power gain of the antenna in the direction of interest relative to an isotropic radiator

R = Distance to the center of radiation of the antenna

Maximum peak output power at antenna input terminal: 16.38 (dBm)

Maximum peak output power at antenna input terminal: 43.451 (mW)

Antenna gain (typical): 2.57 (dBi)

Maximum antenna gain: 1.807 (numeric)

Prediction distance: 20 (cm)

Prediction frequency: 2412 (MHz)

MPE limit for uncontrolled exposure at prediction frequency:

1 (mW/cm²)

Power density at predication frequency at 20 (cm) distance

0.015629 (mW/cm²)

| S | P | P | G | G | R |
|--------------------|-------------|-------|------|-----------|----|
| mW/cm ² | mW | dBm | dBi | (numeric) | cm |
| 0.01562969 | 43.45102242 | 16.38 | 2.57 | 1.807174 | 20 |

12.2 Measurement Result

The predicted power density level at 20 cm is 0.015629 mW/cm². This is below the uncontrolled exposure limit of 1 mW/cm² at 2412MHz.