



# FCC Test Report

for

## 47 CFR Part 15 Subpart C

**Equipment** : Neo 1973  
**Trade Name** : FIC  
**Model No.** : GTA02  
**FCC ID** : EUNGTA02  
**Filing Type** : Certification  
**Applicant** : **FIC (First International Computer, Inc.)**  
1-9F., No. 300, Yang Guang, NeiHu, Taipei, Taiwan, 114

- The test result refers exclusively to the test presented test model / sample.
- Without written approval of SPORTON International Inc., the test report shall not be reproduced except in full.
- **Certificate or Test Report must not be used by the applicant to claim the product in this test report endorsement by NVLAP or any agency of U.S. government.**
- The data shown in this test report were carried out on Dec. 24, 2007 at **Sporton International Inc. LAB.**
- Report No.: FR832514, Report Version: Rev. 01.

Roy Wu  
Manager

### **SPORTON International Inc.**

No. 52, Hwa Ya 1<sup>st</sup> Rd., Hwa Ya Technology Park, Kwei-Shan Hsiang, Tao Yuan Hsien, Taiwan, R.O.C.



## Table of Contents

<b>History of this test report .....</b>	<b>ii</b>
<b>1. General Description of Equipment under Test.....</b>	<b>1</b>
1.1 Applicant.....	1
1.2 Manufacturer .....	1
1.3 Basic Description of Equipment under Test.....	2
1.4 Feature of Equipment under Test.....	3
<b>2. Test Configuration of Equipment under Test.....</b>	<b>4</b>
2.1 Test Manner .....	4
2.2 Test Mode .....	4
2.3 Ancillary Equipment List.....	5
2.4 Connection Diagram of Test System.....	5
<b>3. RF Utility.....</b>	<b>7</b>
<b>4. General Information of Test .....</b>	<b>8</b>
4.1 Test Voltage .....	8
4.2 Standard for Methods of Measurement .....	8
4.3 Test Compliance .....	8
4.4 Frequency Range.....	8
4.5 Test Distance .....	8
<b>5. Test Data and Test Result.....</b>	<b>9</b>
5.1 List of Measurements and Examinations.....	9
5.2 Band Edges Measurement.....	10
5.3 Hopping Channel Separation .....	18
5.4 Number of Hopping Frequency .....	29
5.5 Hopping Channel Bandwidth.....	34
5.6 Dwell Time of Each Frequency.....	45
5.7 Peak Output Power Measurement .....	65
5.8 Conducted Emission.....	76
5.9 Radiated Emission Measurement.....	85
5.10 Antenna Requirements.....	103
<b>6. List of Measuring Equipments.....</b>	<b>104</b>
<b>7. Uncertainty Evaluation.....</b>	<b>105</b>
<b>Appendix A. External Photographs of EUT</b>	
<b>Appendix B. Internal Photographs of EUT</b>	
<b>Appendix C. Setup Photographs</b>	



### History of this test report

Report Issue Date: Apr. 01, 2008

Report No.	Description



## **1. General Description of Equipment under Test**

### **1.1 Applicant**

**FIC (First International Computer, Inc.)**

1-9F., No. 300, Yang Guang, NeiHu, Taipei, Taiwan, 114

### **1.2 Manufacturer**

**First International Computer (Suzhou) Inc.**

No. 200, Central uhong Road, SuZhou Industrial Park, China

**1.3 Basic Description of Equipment under Test**

<b>Equipment</b>		Neo 1973
<b>Trade Name</b>		FIC
<b>Model Name</b>		GTA02
<b>FCC ID :</b>		EUNGTA02
<b>AC Adapter</b>	<b>Manufacture</b>	AKII TECHNOLOGY CO., LTD.
	<b>Brand Name</b>	AKII Technology
	<b>Model Name</b>	A10P1-05MP
	<b>Power Rating</b>	I/P: 100-240Vac, 47-63 Hz, 0.3A; O/P: 5Vdc, 2.0A
	<b>AC Power Cord Type</b>	1.49 meter non-shielded cable without ferrite core
<b>Battery A</b>	<b>Manufacture</b>	WELLDONE COMPANY
	<b>Brand Name</b>	FIC
	<b>Model Name</b>	GTC-01 / GTA-01
	<b>Rating</b>	3.7Vdc, 1200mAh
	<b>Type</b>	Li-ion
<b>Battery B</b>	<b>Brand Name</b>	FIC
	<b>Model Name</b>	GTA02
	<b>Rating</b>	3.7Vdc, 1200mAh
	<b>Type</b>	Li-ion
<b>Earphone A</b>	<b>Brand Name</b>	Xport
	<b>Model Name</b>	Ko-11-1020a
	<b>Signal line Type</b>	1.42 meter non-shielded cable without ferrite core
<b>Earphone B</b>	<b>Brand Name</b>	SEMDITECH
	<b>Model Name</b>	HP-GTA01-MP3JS-G
	<b>Signal line Type</b>	1.6 meter non-shielded cable without ferrite core
<b>USB Cable</b>	<b>Brand Name</b>	Golden Bridge
	<b>Model Name</b>	AS52-0607007
	<b>Signal Line Type</b>	1.29 meter non-shielded cable without ferrite core

Remark: Above EUT's information was declared by manufacturer. Please refer to the specifications of manufacturer or User's Manual for more detailed features description.

**1.4 Feature of Equipment under Test**

Product Feature & Specification	
<b>DUT Type :</b>	Neo 1973
<b>Trade Name :</b>	FIC
<b>Model Name :</b>	GTA02
<b>FCC ID :</b>	EUNGTA02
<b>Tx Frequency :</b>	GSM850 : 824 ~ 849 MHz PCS1900 : 1850 ~ 1910 MHz Bluetooth : 2400 ~ 2483.5 MHz WLAN : 2400 ~ 2483.5 MHz
<b>Rx Frequency :</b>	GSM850 : 869 ~ 894 MHz PCS1900 : 1930 ~ 1990 MHz Bluetooth : 2400 ~ 2483.5 MHz WLAN : 2400 ~ 2483.5 MHz GPS : 1575.42 MHz
<b>Maximum Output Power to Antenna :</b>	GSM850 : 32.20 dBm (GSM) PCS1900 : 29.27 dBm (GSM) Bluetooth : 2.25 dBm (1Mbps) Bluetooth EDR : 2.4 dBm (2Mbps) / 2.53 dBm (3Mbps) WLAN : 14.02 dBm (802.11b) / 14.89 dBm (802.11g)
<b>Type of Antenna Connector</b>	N/A
<b>Antenna Type :</b>	GSM : Monopole Antenna GPS : Ceramic Antenna Bluetooth : Chip Antenna WLAN : Chip Antenna
<b>Antenna Gain :</b>	GSM : 0.07 dBi GPS : 0.5 dBi Bluetooth : -4.84 dBi WLAN : -3 dBi
<b>HW Version :</b>	A5
<b>SW Version :</b>	Moko5
<b>Type of Modulation :</b>	GSM / GPRS : GMSK Bluetooth (1Mbps) : GFSK Bluetooth EDR (2Mbps) : $\pi/4$ -DQPSK Bluetooth EDR (3Mbps) : 8-DPSK WLAN : DSSS / OFDM
<b>DUT Stage :</b>	Identical Prototype



## 2. Test Configuration of Equipment under Test

### 2.1 Test Manner

- a. The EUT has been associated with peripherals pursuant to ANSI C63.4-2003 and configuration operated in a manner tended to maximize its emission characteristics in a typical application.
- b. The data rate, 3Mbps, was chosen to being tested, due to the highest RF output power.

Channel	Frequency	Data Rate/ Modulation		
		GFSK	/4-DQPSK	8-DPSK
		1Mbps	2Mbps	3Mbps
Ch00	2400MHz	2.25 dBm	2.40 dBm	2.53 dBm
Ch39	2441MHz	2.14 dBm	2.03 dBm	2.22 dBm
Ch78	2480MHz	1.62 dBm	1.33 dBm	1.50 dBm

Bluetooth uses frequency hopping spread spectrum (FHSS) operation which also facilitates Bluetooth multiple access and coexistence among other types of wireless systems. The basic frequency-hopping pattern is a pseudo-random ordering of 79 channel frequencies in the ISM band and the hopping rate is nominally 1600 hops per second. The EDR modulation format uses one of two types of DPSK (Pi/4-DQPSK or 8-DPSK) in the payload section of the packet. As shown in figure, the EDR packet begins using GFSK modulation during the access code and header portions of the packet but changes to DPSK modulation after the guard time. Changing to a DPSK format allows increased data rates of 2 Mb/s or 3 Mb/s.

- c. The EUT is programmed to transmit signal continuously for all testings.
- d. Frequency range investigated: conduction 150 kHz to 30 MHz, radiation 30 MHz to 25000MHz.

### 2.2 Test Mode

Application	
<b>Radiated Emission</b>	<b>BT Tx (EDR 3Mbps)</b>
	Mode 1: CH00_2402 MHz
	Mode 2: CH39_2441 MHz
	Mode 3: CH78_2480 MHz
	Mode 4: BT CH78 + 802.11b CH01
<b>Conducted Emission</b>	Mode 1: BT Link + PCS1900 Idle + GPS Rx + Earphone + MP3 + Adapter
	Mode 2: BT Link + WLAN Link + GPS Rx + Earphone + MP3 + Adapter
	Mode 3: BT Link + PCS1900 Idle + GPS Rx + Earphone + MP3 + USB Link
	Mode 4: BT Link + GSM850 Idle + GPS Rx + Earphone + MP3 + USB Link

### 2.3 Ancillary Equipment List

Item	Equipment	Trade Name	Model Name	FCC ID	Data Cable / Power Cord
1.	NOTEBOOK	DELL	D400	E2K24GBRL	1.2m
2.	Base Station	Agilent	E5515C	N/A	Unshielded, 1.8 m
3.	BT Base Station	Anritus	8852A	N/A	Unshielded, 1.8 m
4.	WLAN AP	SMC	SMC-100	HEDWG4005ACC	Unshielded, 1.8 m
5.	BT Dongle	Engotech	ET-BD201	PQY-4710874203662	N/A
6.	iPod	Apple	A1199	DoC	Shielded, 1.2m

### 2.4 Connection Diagram of Test System

<Radiated Emission>

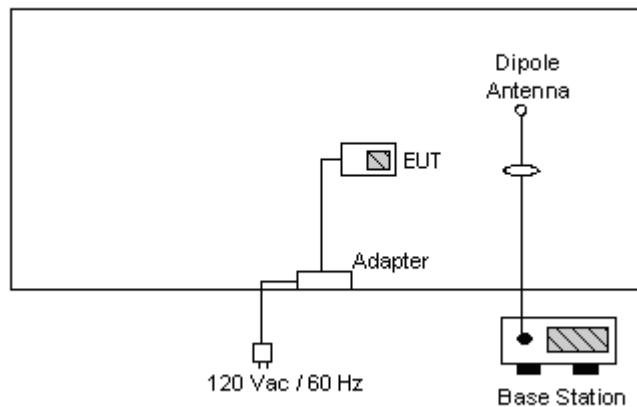



<Conducted Emission>

Mode 1

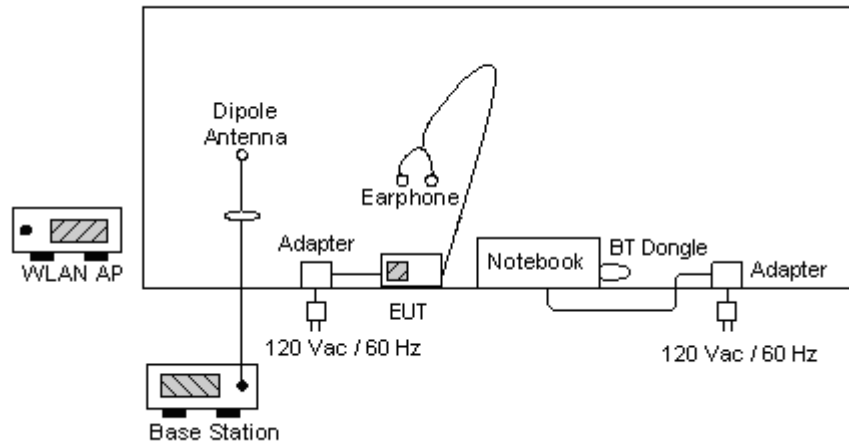

Mode 2

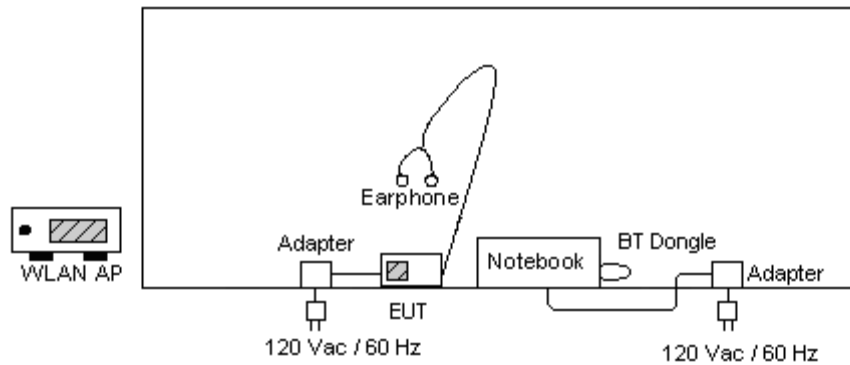

Mode 3 and 4

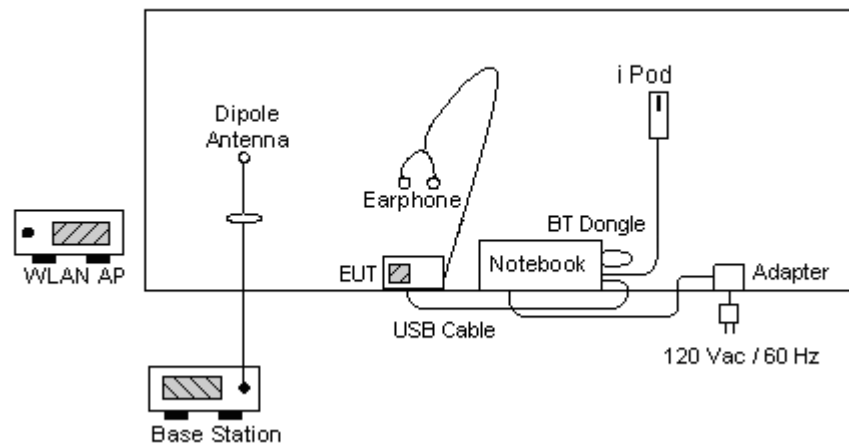



### **3. RF Utility**

The programmed RF Utility is installed in EUT to provide channel selection, power level, data rate and the application type. RF Utility can send transmitting signal for all testings.



## **4. General Information of Test**

Test Site Location : No. 52, Hwa Ya 1<sup>st</sup> Rd., Hwa Ya Technology Park,  
Kwei-Shan Hsiang, Tao Yuan Hsien, Taiwan, R.O.C.  
TEL : 886-3-327-3456  
FAX : 886-3-328-4978

Test Site No : CO04-HY, 03CH04-HY

### **4.1 Test Voltage**

AC 120V / 60Hz

### **4.2 Standard for Methods of Measurement**

ANSI C63.4-2003

### **4.3 Test Compliance**

47 CFR Part 15 Subpart C

### **4.4 Frequency Range**

- a. Conduction: from 150 kHz to 30 MHz
- b. Radiation: from 30 MHz to 25000 MHz

### **4.5 Test Distance**

The test distance of radiated emission from antenna to EUT is 3 m.



## 5. Test Data and Test Result

### 5.1 List of Measurements and Examinations

The Emission Mode: Bluetooth

FCC Rule	Description of Test	Result
15.207	Conducted Emission	Pass
15.247(a)(1)(iii)	Hopping Channel Bandwidth	Pass
15.247(a)(1)	Hopping Channel Separation	Pass
15.247(a)(1)(iii)	Number of Hopping Frequency	Pass
15.247(a)(1)(iii)	Dwell Time of Each Frequency	Pass
15.247(b)(1)	Output Power	Pass
15.247(d)	100 KHz Bandwidth of Frequency Band Edges	Pass
15.209(a) 15.247(d)	Radiated Emission	Pass
15.203 15.247(b)(4)	Antenna Requirement	Pass



## 5.2 Band Edges Measurement

### 5.2.1 Measuring Instruments

As described in chapter 6 of this test report.

### 5.2.2 Test Procedure

1. The transmitter output was connected to the spectrum analyzer via a low lose cable.
2. Set both RBW and VBW of spectrum analyzer to 100kHz with suitable frequency span including 100 kHz bandwidth from band edge.
3. The band edges was measured and recorded.

### 5.2.3 Test Result

- Application Type : Bluetooth
- Temperature : 24~27
- Relative Humidity : 49~51%
- Test Enginner : Ken
  
- Test Result in BT lower band : PASS
- Test Result in BT higher band : PASS
- Test Result in BT EDR(2Mbps) lower band : PASS
- Test Result in BT EDR(2Mbps) higher band : PASS
- Test Result in BT EDR(3Mbps) lower band : PASS
- Test Result in BT EDR(3Mbps) higher band : PASS



5.2.4 Note on Band Edge Emission

➤ **BT(1Mbps)**

CH00 (Horizontal)

Frequency ( MHz )	Level ( dBuV/m )	Over Limit ( dB )	Limit Line ( dBuV/m )	Read Level ( dBuV )	Antenna Factor ( dB )	Cable Loss ( dB )	Preamp Factor ( dB )	Ant Pos ( cm )	Table Pos ( deg )	Remark
2389.42	46.99	-27.01	74.00	44.49	32.54	3.74	33.78	100	0	Peak
2389.42	34.66	-19.34	54.00	32.16	32.54	3.74	33.78	160	101	Average

CH00 (Vertical)

Frequency ( MHz )	Level ( dBuV/m )	Over Limit ( dB )	Limit Line ( dBuV/m )	Read Level ( dBuV )	Antenna Factor ( dB )	Cable Loss ( dB )	Preamp Factor ( dB )	Ant Pos ( cm )	Table Pos ( deg )	Remark
2349.14	50.33	-23.67	74.00	47.90	32.51	3.69	33.77	100	0	Peak
2349.14	33.08	-20.92	54.00	30.65	32.51	3.69	33.77	101	68	Average

CH78 (Horizontal)

Frequency ( MHz )	Level ( dBuV/m )	Over Limit ( dB )	Limit Line ( dBuV/m )	Read Level ( dBuV )	Antenna Factor ( dB )	Cable Loss ( dB )	Preamp Factor ( dB )	Ant Pos ( cm )	Table Pos ( deg )	Remark
2483.50	63.73	-10.27	74.00	61.10	32.59	3.84	33.80	100	0	Peak
2483.50	50.60	-3.40	54.00	47.97	32.59	3.84	33.80	102	94	Average

CH78 (Vertical)

Frequency ( MHz )	Level ( dBuV/m )	Over Limit ( dB )	Limit Line ( dBuV/m )	Read Level ( dBuV )	Antenna Factor ( dB )	Cable Loss ( dB )	Preamp Factor ( dB )	Ant Pos ( cm )	Table Pos ( deg )	Remark
2483.50	65.00	-9.00	74.00	62.37	32.59	3.84	33.80	100	0	Peak
2483.50	51.31	-2.69	54.00	48.68	32.59	3.84	33.80	150	99	Average



5.2.5 20dB Band Edge

BT

CH00

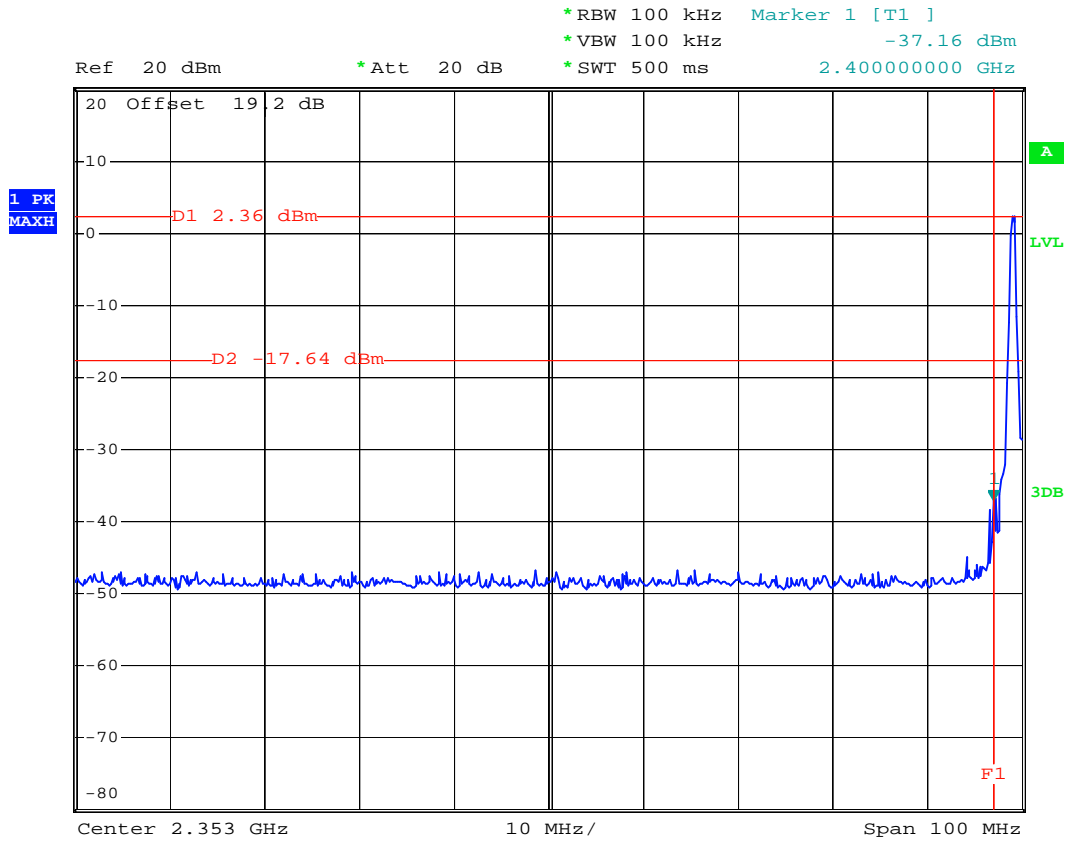

Date: 12.DEC.2007 01:27:00



CH78

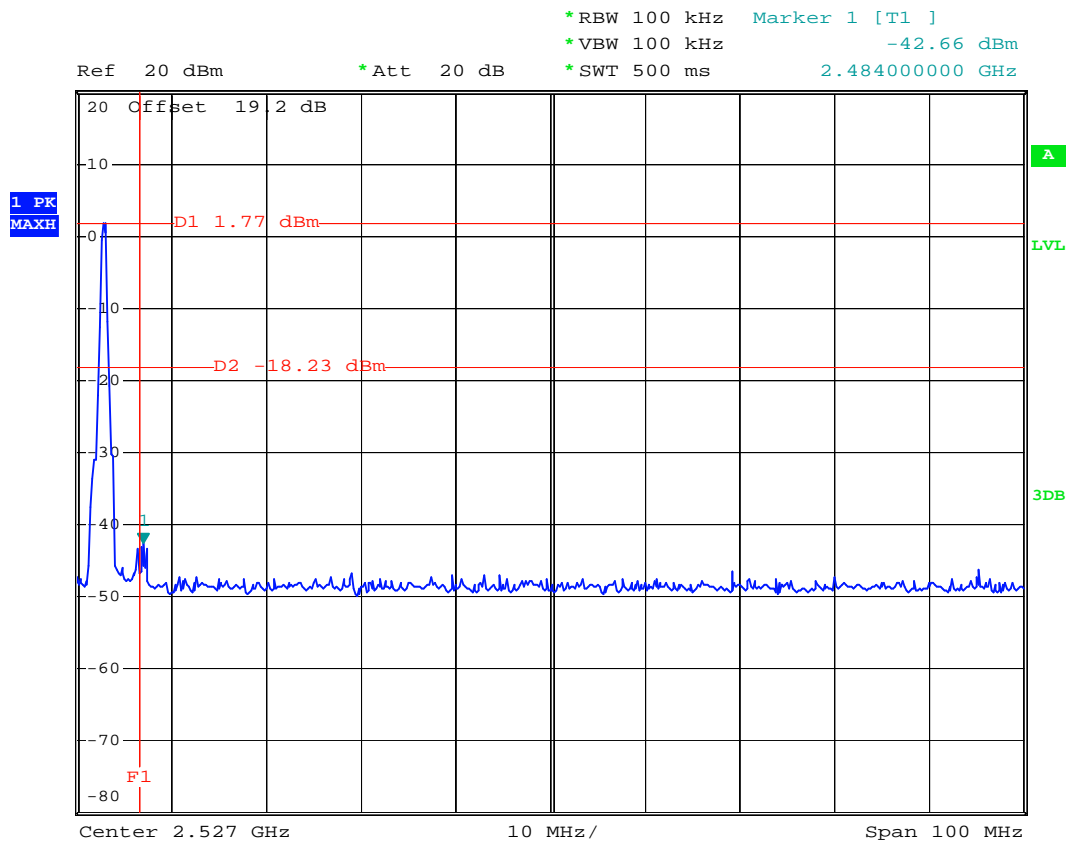

Date: 12.DEC.2007 01:27:48





BT EDR(2Mbps)

CH00

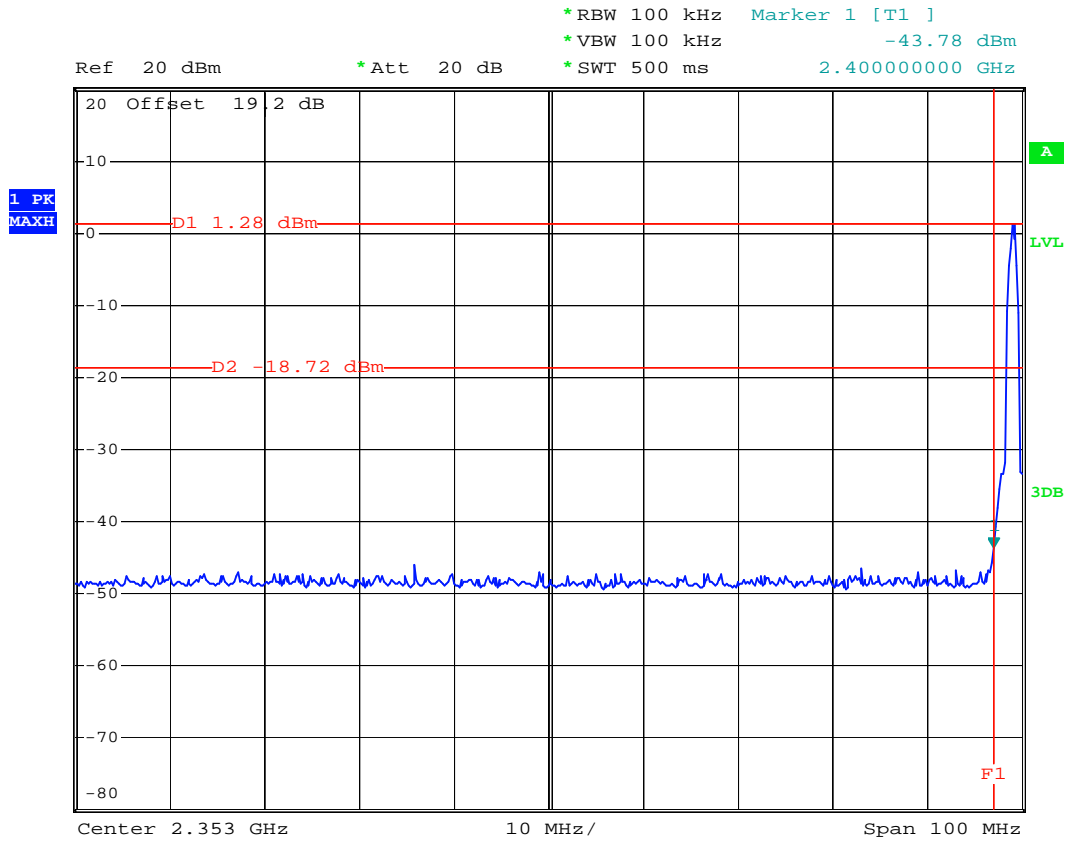

Date: 12.DEC.2007 01:52:31



CH78

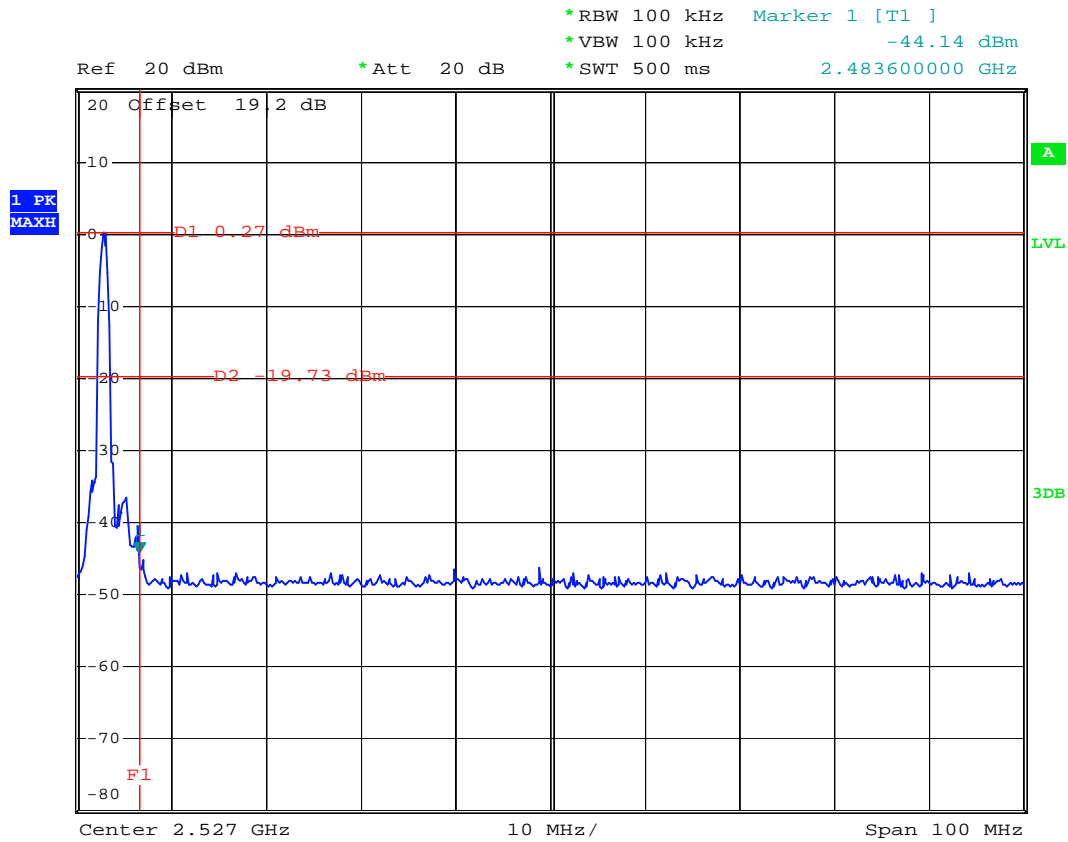

Date: 12.DEC.2007 01:55:00



BT EDR(3Mbps)

CH00

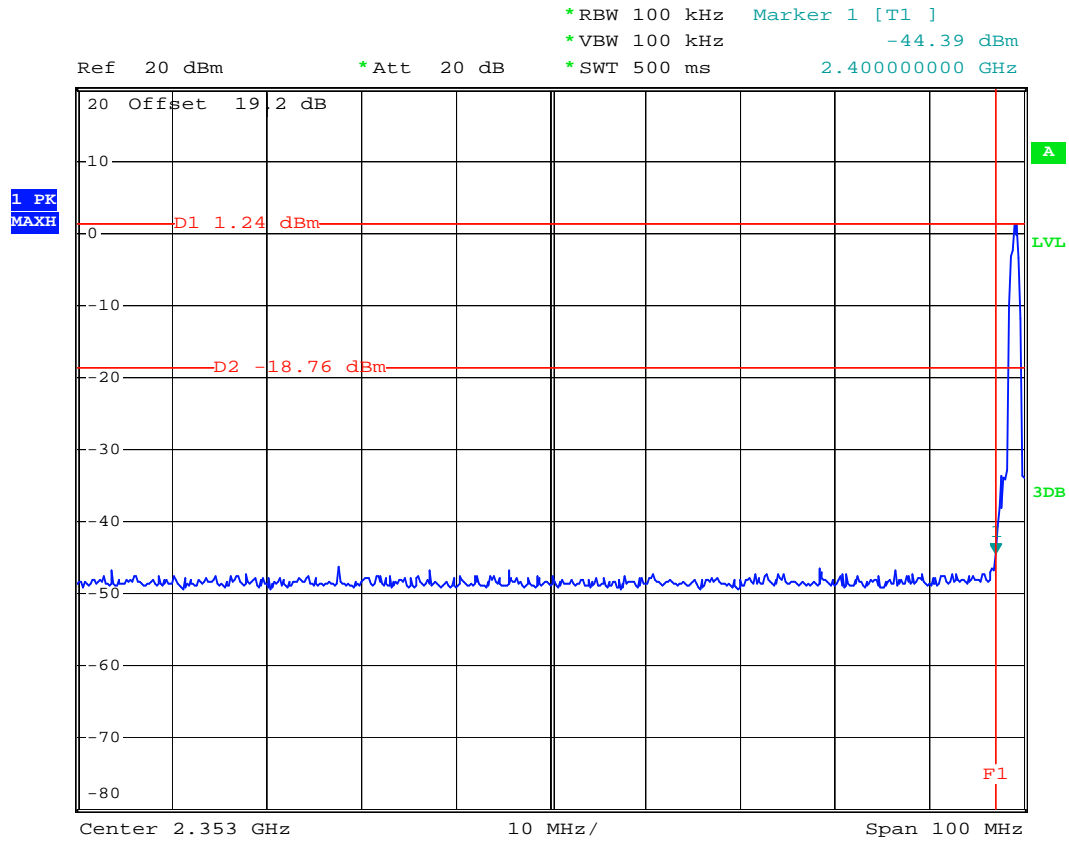

Date: 12.DEC.2007 01:53:25



CH78

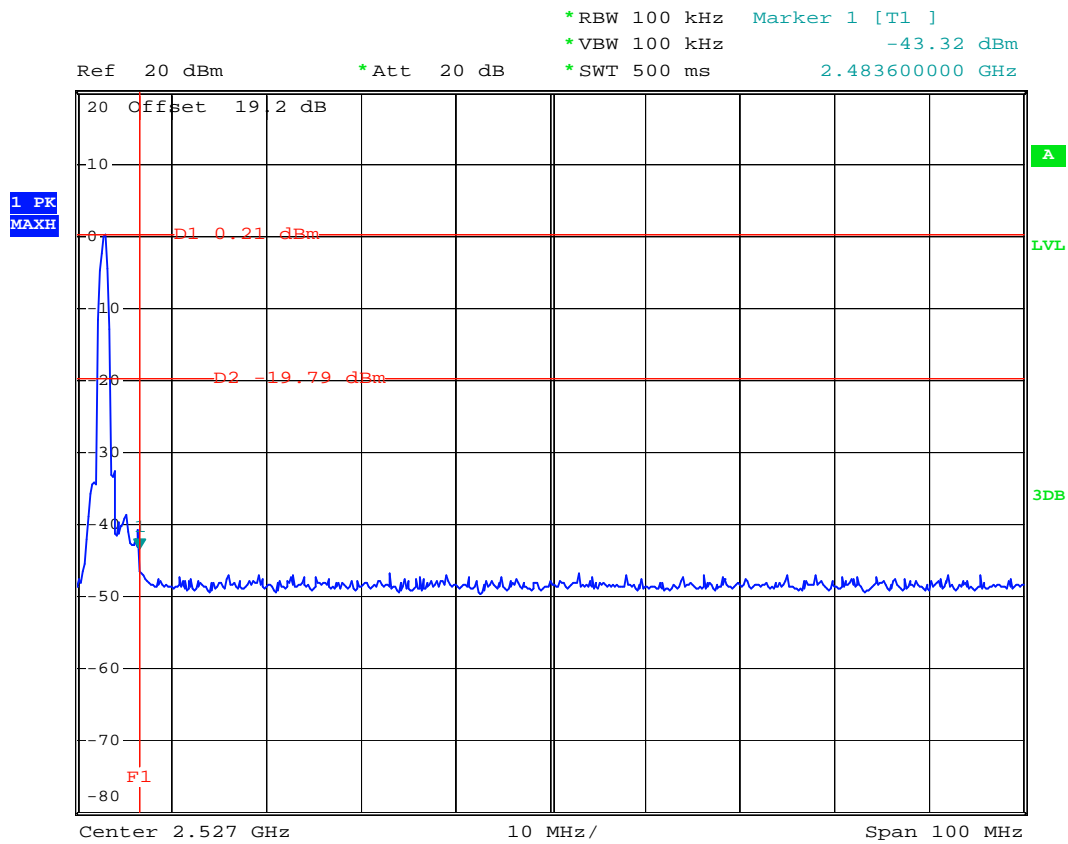

Date: 12.DEC.2007 01:56:51

### 5.3 Hopping Channel Separation

#### 5.3.1 Measuring Instruments

As described in chapter 9 of this test report.

#### 5.3.2 Test Procedure

1. The output of EUT was connected to the spectrum analyzer by a low loss cable..
2. Set RBW of spectrum analyzer to 30kHz and VBW to 100kHz.
3. The Hopping Channel Separation is defined as the channel is separated with the next channel.

#### 5.3.3 Test Setup Layout

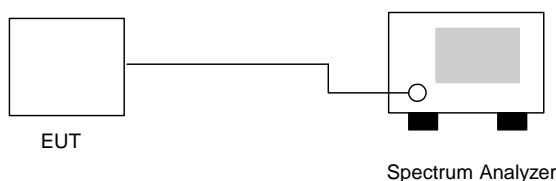

#### 5.3.4 Test Result : The spectrum analyzer plots are attached as below

- Application Type : BT
- Temperature : 24~27
- Relative Humidity : 49~51%
- Test Engineer : Ken

Channel	Frequency (MHz)	Carrier Frequency Separation ( MHz )	Limits ( MHz )	Plot Ref. No.
00	2402	1.004	0.551	Mode 1
39	2441	1.000	0.559	Mode 2
78	2480	1.000	0.555	Mode 3

Note: Hopping Channel Separation shall be greater 2/3 of 20dB bandwidth. Refer the result of 20dB bandwidth to section 5.7.



- Application Type : BT EDR(2Mbps)
- Temperature : 24~27
- Relative Humidity : 49~51%
- Test Enginner : Ken

Channel	Frequency (MHz)	Carrier Frequency Separation ( MHz )	Limits ( MHz )	Plot Ref. No.
00	2402	1.008	0.821	Mode 4
39	2441	1.008	0.819	Mode 5
78	2480	1.008	0.816	Mode 6

Note: Hopping Channel Separation shall be greater 2/3 of 20dB bandwidth. Refer the result of 20dB bandwidth to section 5.7.

- Application Type : BT EDR(3Mbps)
- Temperature : 24~27
- Relative Humidity : 49~51%
- Test Enginner : Ken

Channel	Frequency (MHz)	Carrier Frequency Separation ( MHz )	Limits ( MHz )	Plot Ref. No.
00	2402	1.000	0.837	Mode 7
39	2441	1.000	0.840	Mode 8
78	2480	1.000	0.837	Mode 9

Note: Hopping Channel Separation shall be greater 2/3 of 20dB bandwidth. Refer the result of 20dB bandwidth to section 5.7.



5.3.5 Hopping Channel Separation

Mode 1

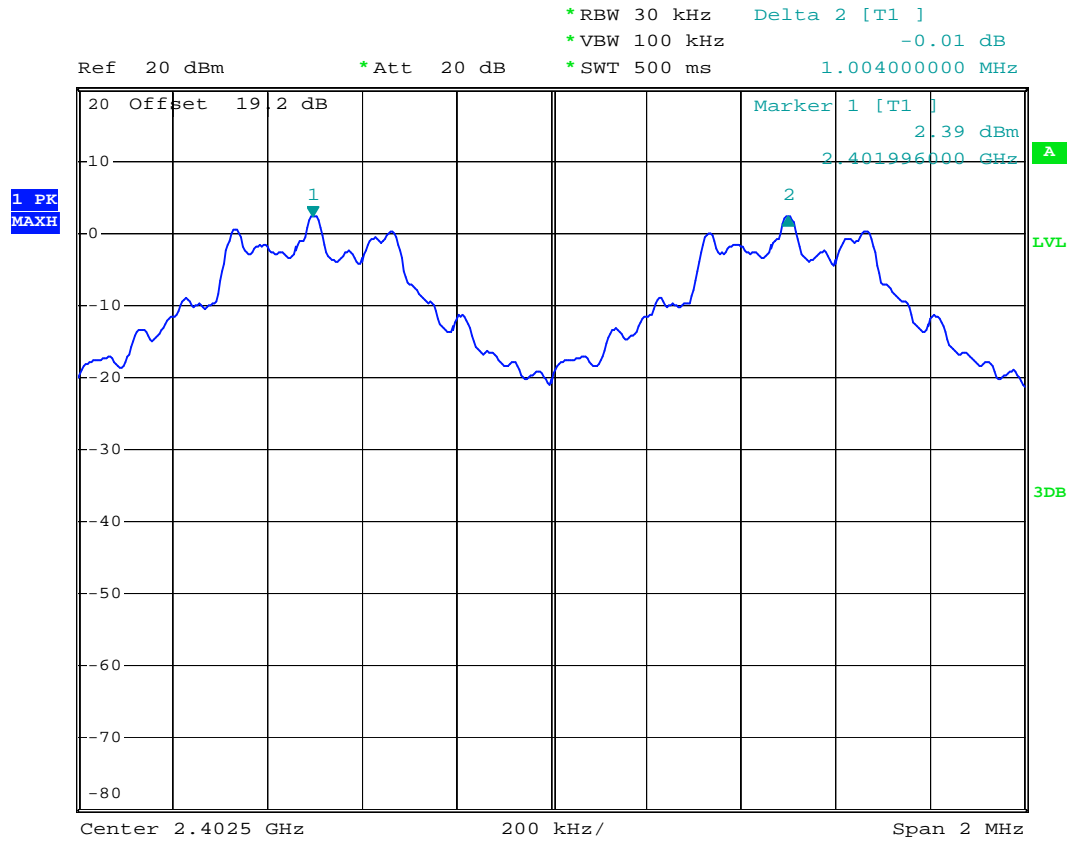

Date: 12.DEC.2007 01:29:28



Mode 2

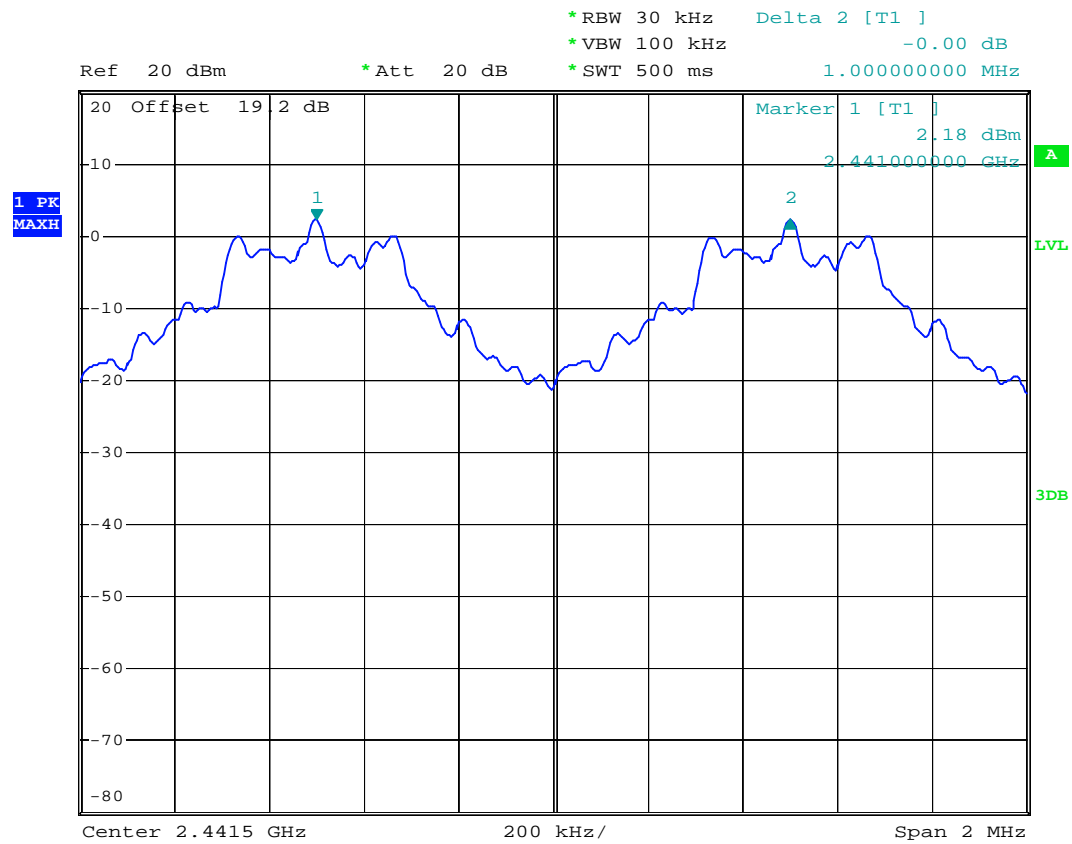

Date: 12.DEC.2007 01:30:55





Mode 3

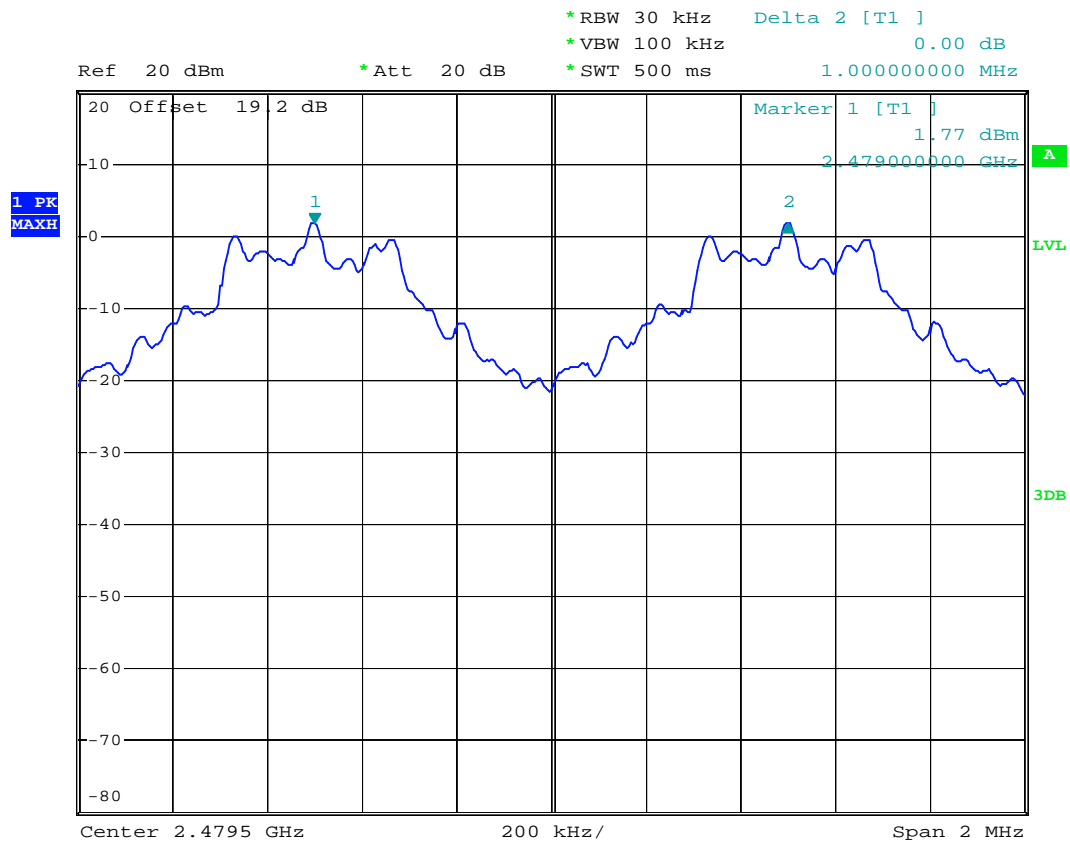

Date: 12.DEC.2007 01:32:17



Mode 4

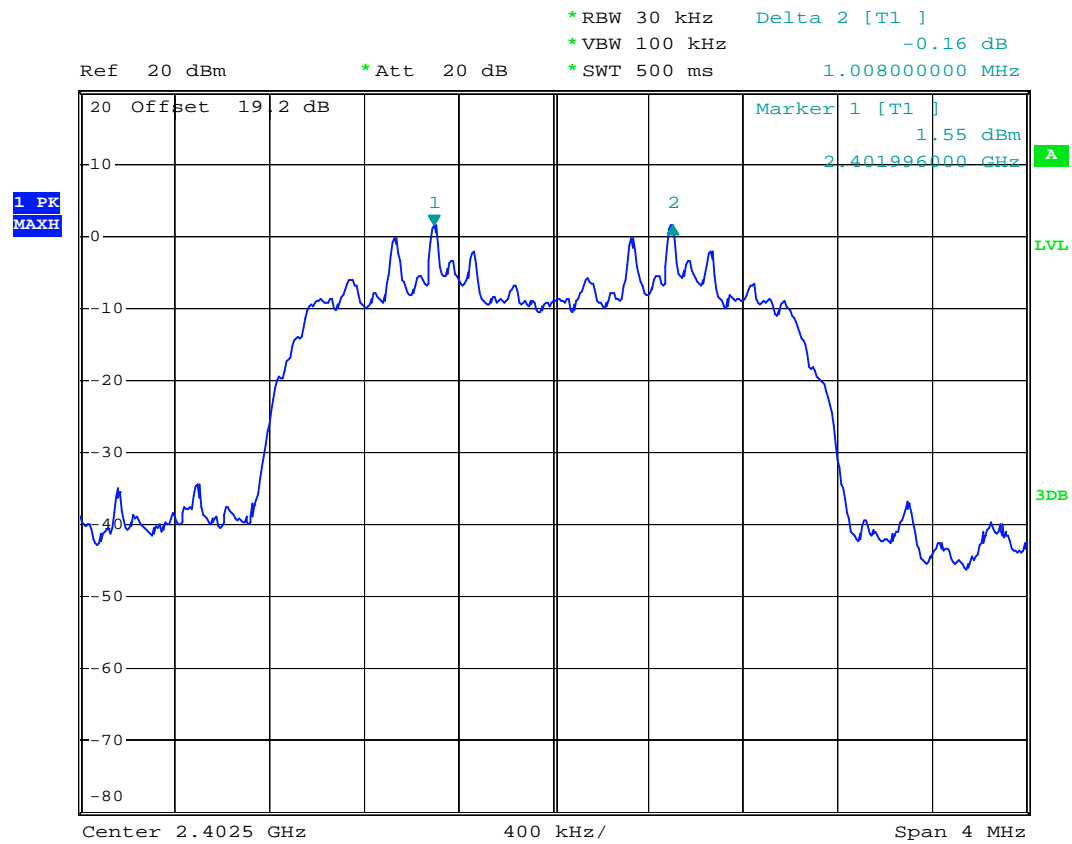

Date: 12.DEC.2007 01:58:23



Mode 5

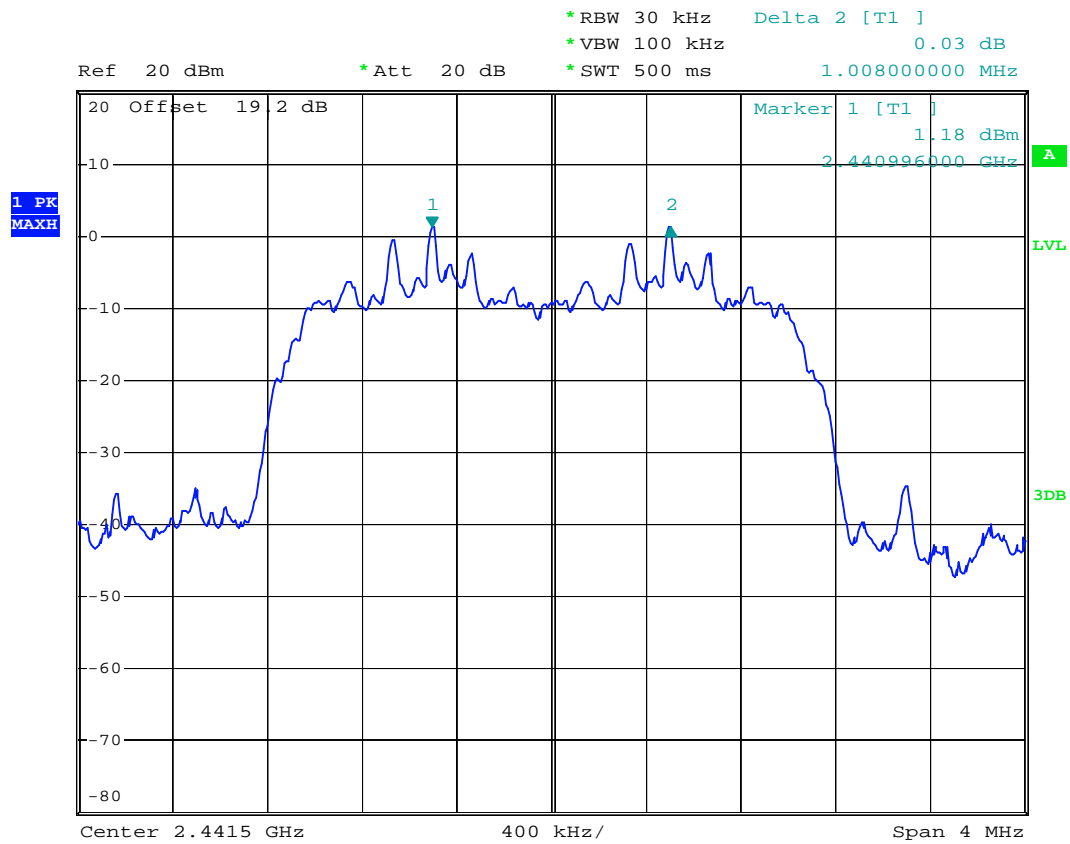

Date: 12.DEC.2007 01:59:16



Mode 6

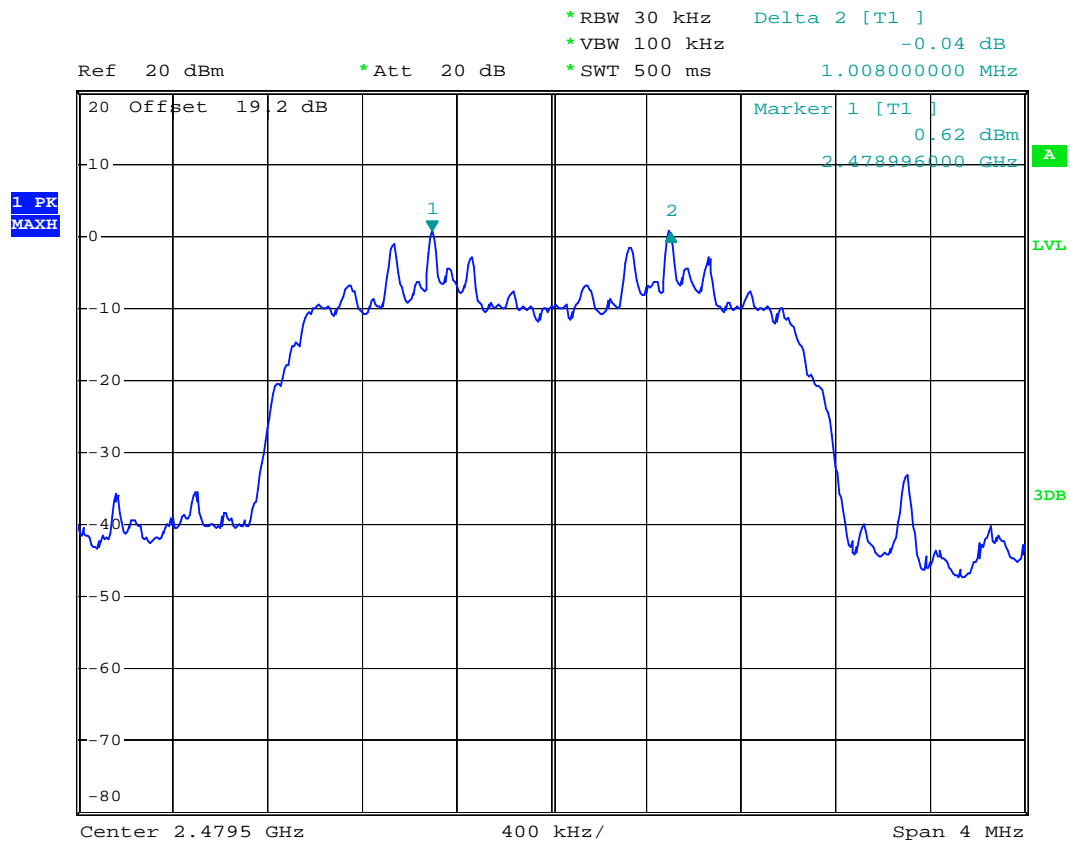

Date: 12.DEC.2007 02:00:25



Mode 7

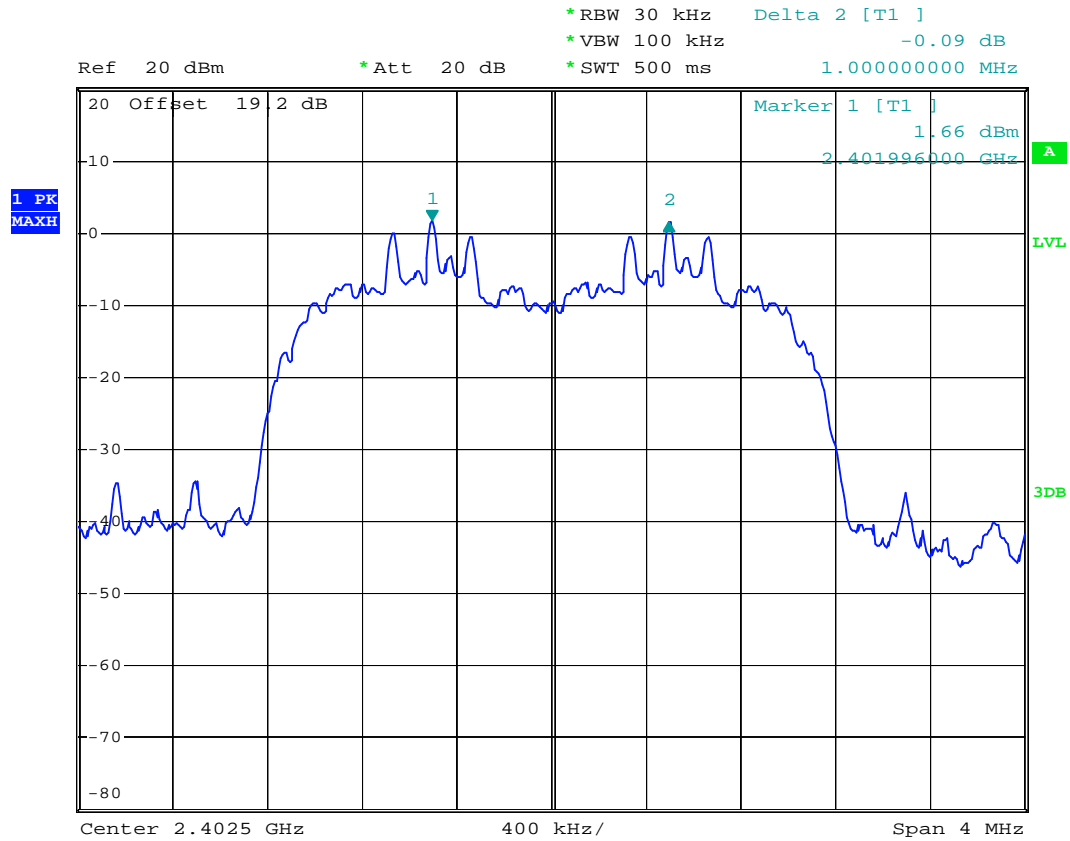

Date: 12.DEC.2007 02:01:57



Mode 8

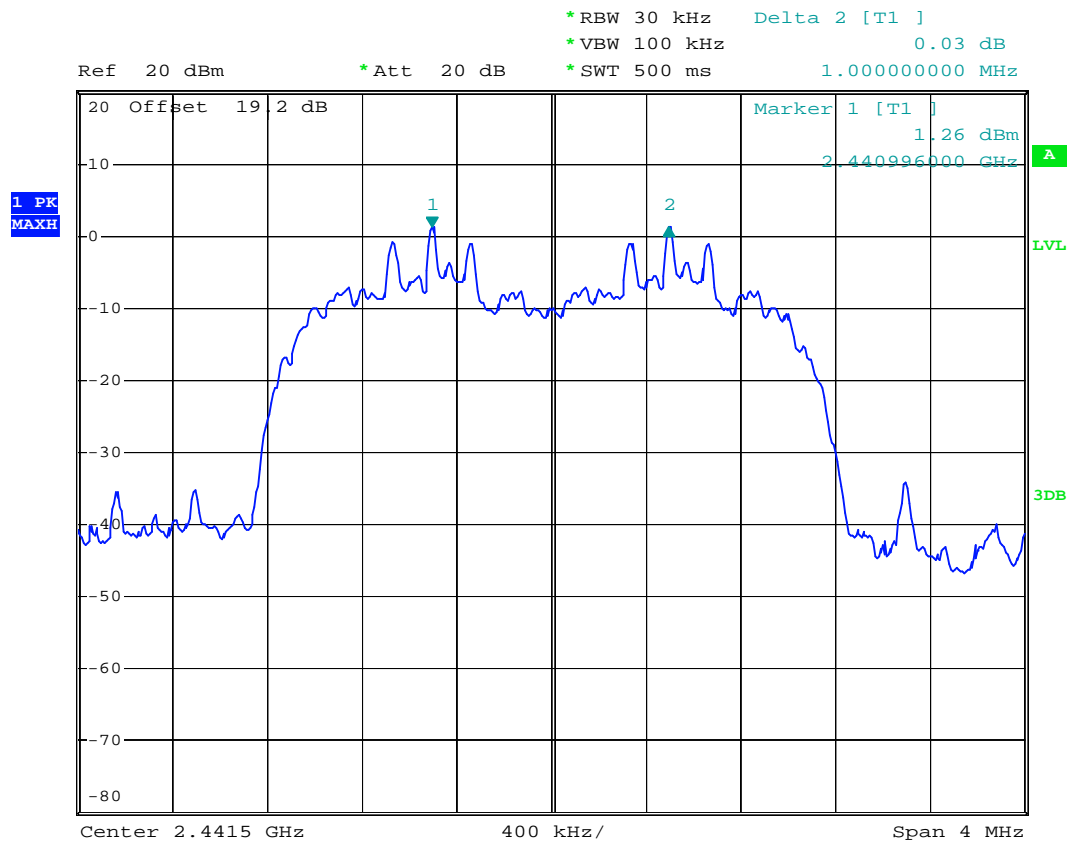

Date: 12.DEC.2007 02:03:01



Mode 9

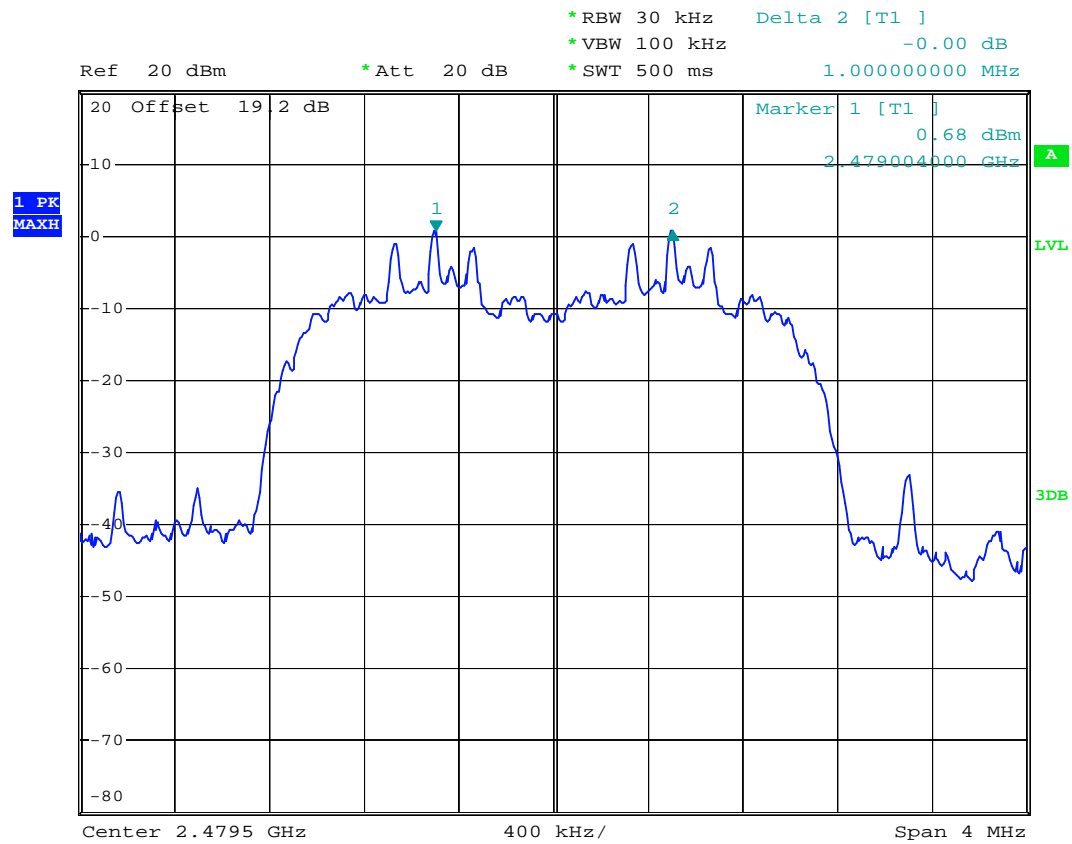

Date: 12.DEC.2007 02:04:09

## 5.4 Number of Hopping Frequency

### 5.4.1 Measuring Instruments

As described in chapter 9 of this test report.

### 5.4.2 Test Procedure

1. The output of EUT was connected to the spectrum analyzer by a low loss cable.
2. Set RBW of spectrum analyzer to 100kHz and VBW to 100kHz.
3. The number of hopping frequency used is defined as the device has the numbers of total channel.

### 5.4.3 Test Setup Layout

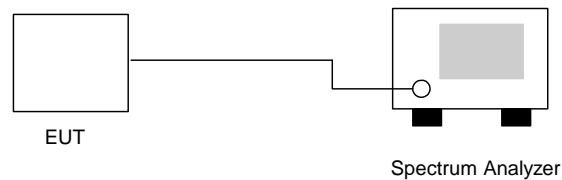





5.4.4 Test Result : See spectrum analyzer plots below

- Application Type : BT
- Temperature : 24~27
- Relative Humidity : 49~51%
- Test Engineer : Ken

Number of Hopping Frequency (Channel)	Limits (Channel)
79	15

- Application Type : BT EDR(2Mbps)
- Temperature : 24~27
- Relative Humidity : 49~51%
- Test Engineer : Ken

Number of Hopping Frequency (Channel)	Limits (Channel)
79	15

- Application Type : BT EDR(3Mbps)
- Temperature : 24~27
- Relative Humidity : 49~51%
- Test Engineer : Ken

Number of Hopping Frequency (Channel)	Limits (Channel)
79	15



5.4.5 Number of Hopping Frequency

BT

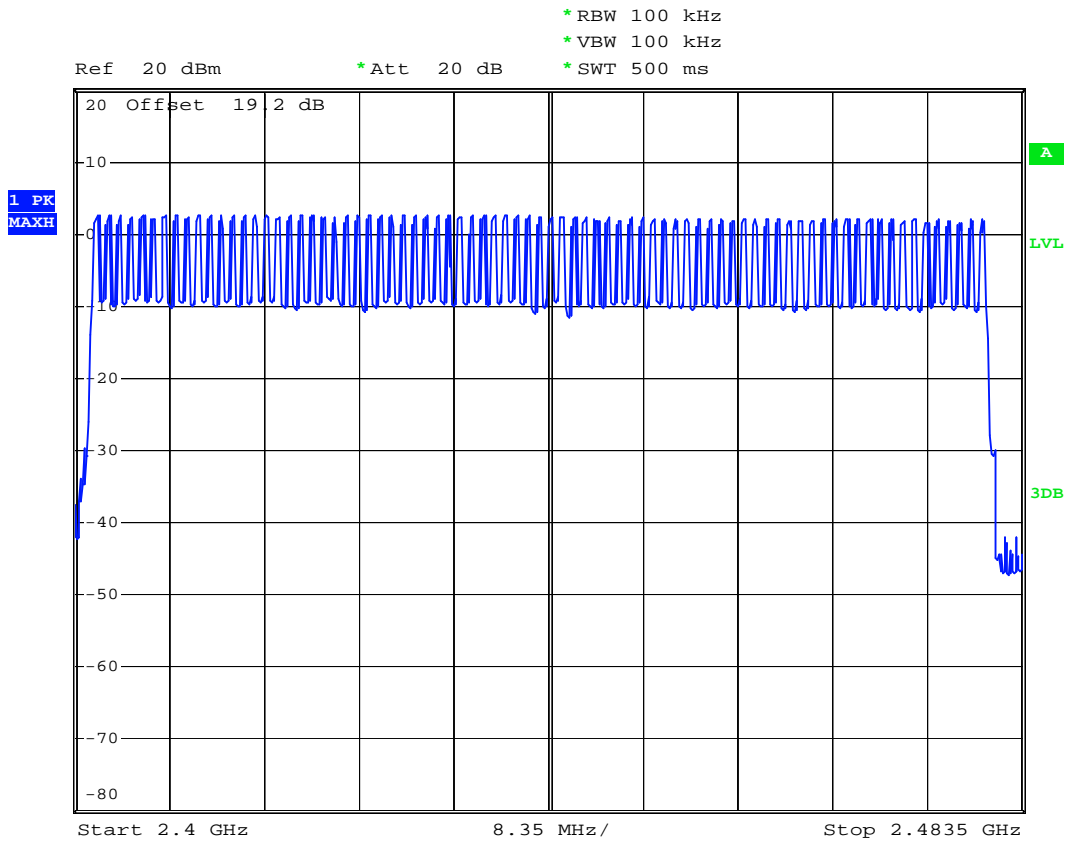

Date: 12.DEC.2007 02:42:34



BT EDR(2Mbps)

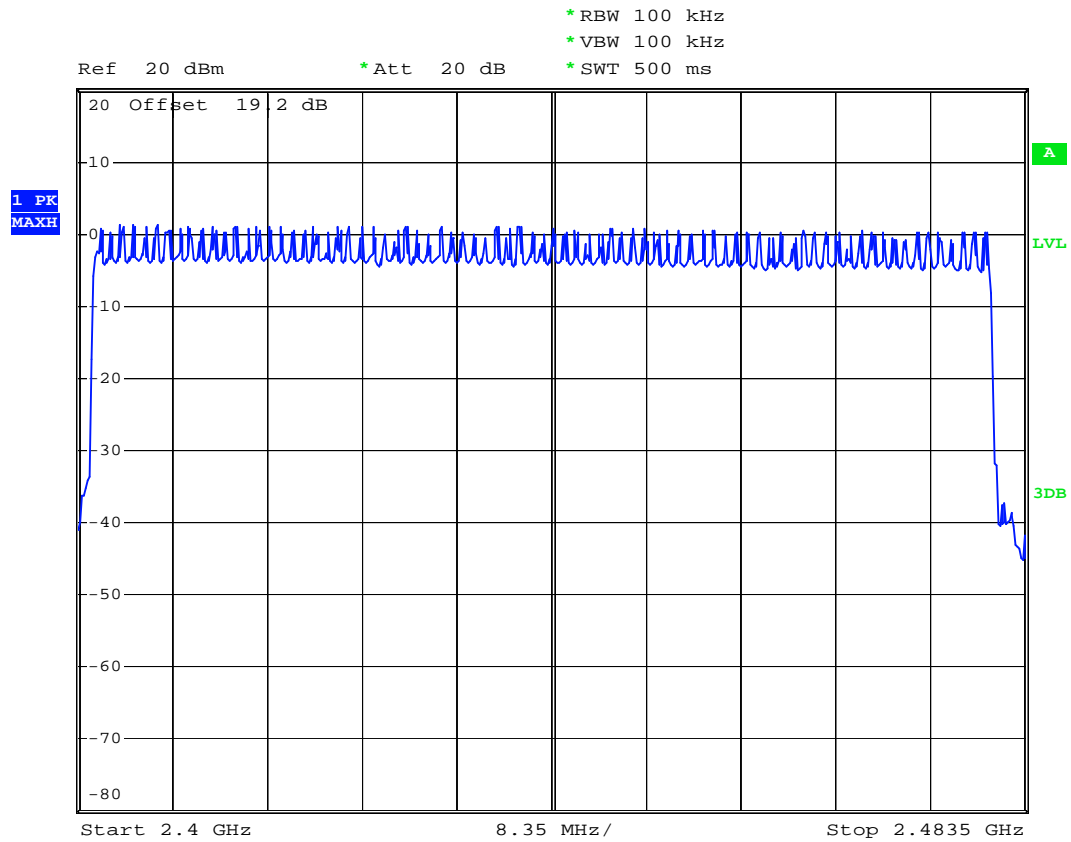

Date: 12.DEC.2007 02:26:31



BT EDR(3Mbps)

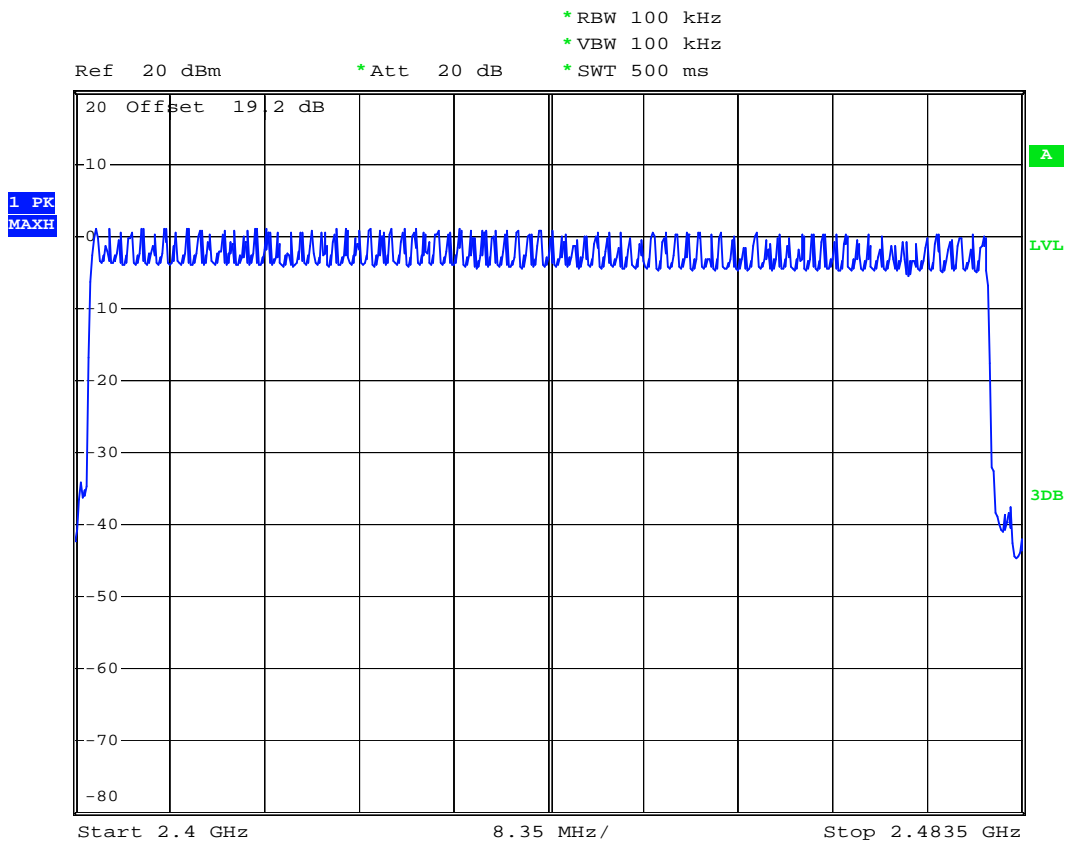

Date: 12.DEC.2007 02:32:01

## 5.5 Hopping Channel Bandwidth

### 5.5.1 Measuring Instruments

As described in chapter 9 of this test report.

### 5.5.2 Test Procedure

1. The transmitter output was connected to the spectrum analyzer by a low loss cable.
2. Set RBW of spectrum analyzer to 30kHz and VBW to 300kHz.
3. The Hopping Channel bandwidth is defined as the total spectrum the power of which is higher than peak power minus 20 dB.

### 5.5.3 Test Setup Layout

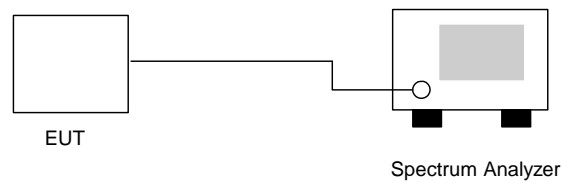



5.5.4 Test Result : See spectrum analyzer plots below

- Application Type : BT
- Temperature : 24~27
- Relative Humidity : 49~51%
- Test Enginner : Ken

Channel	Frequency (MHz)	Hopping Channel Bandwidth (MHz)	Plot Ref. No.
00	2402	0.826	Mode 1
39	2441	0.838	Mode 2
78	2480	0.832	Mode 3

- Application Type : BT EDR(2Mbps)
- Temperature : 24~27
- Relative Humidity : 49~51%
- Test Enginner : Ken

Channel	Frequency (MHz)	Hopping Channel Bandwidth (MHz)	Plot Ref. No.
00	2402	1.232	Mode 4
39	2441	1.228	Mode 5
78	2480	1.224	Mode 6

- Application Type : BT EDR(3Mbps)
- Temperature : 24~27
- Relative Humidity : 49~51%
- Test Enginner : Ken

Channel	Frequency (MHz)	Hopping Channel Bandwidth (MHz)	Plot Ref. No.
00	2402	1.256	Mode 7
39	2441	1.260	Mode 8
78	2480	1.256	Mode 9



5.5.5 Hopping Channel Bandwidth

Mode 1

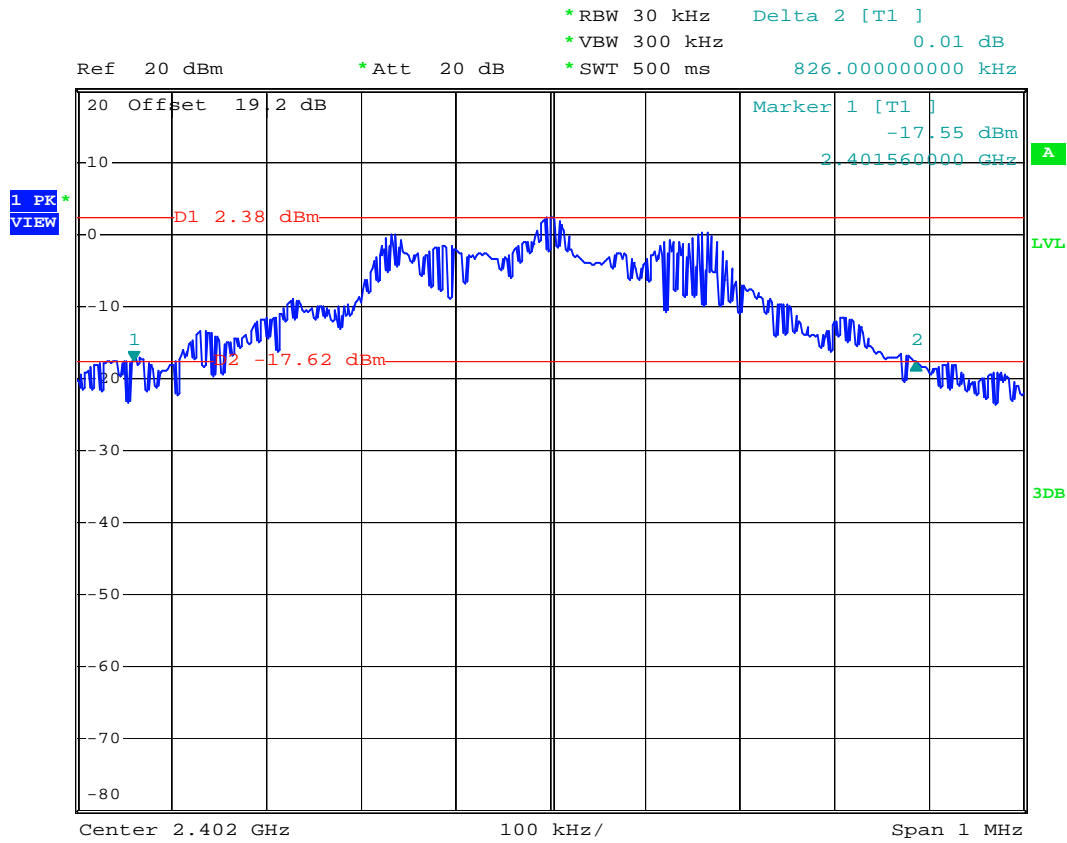

Date: 12.DEC.2007 01:23:15



Mode 2

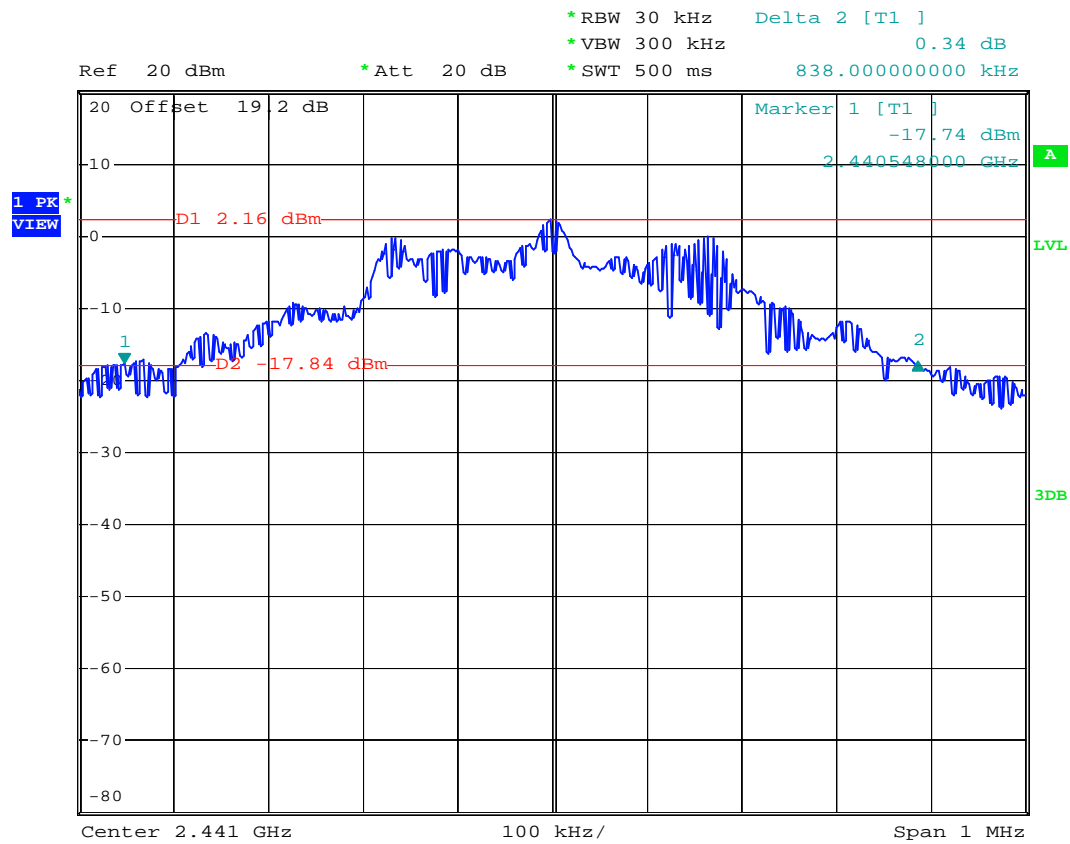

Date: 12.DEC.2007 01:24:36





Mode 3

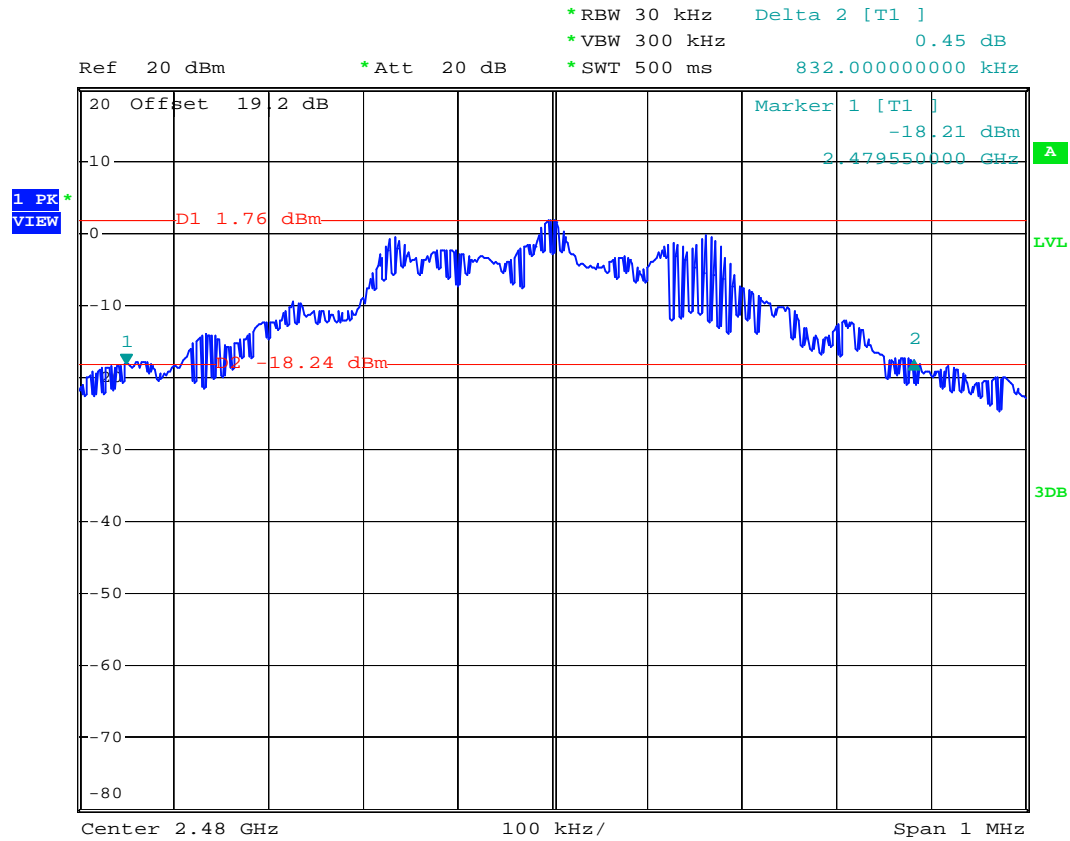

Date: 12.DEC.2007 01:25:55



Mode 4

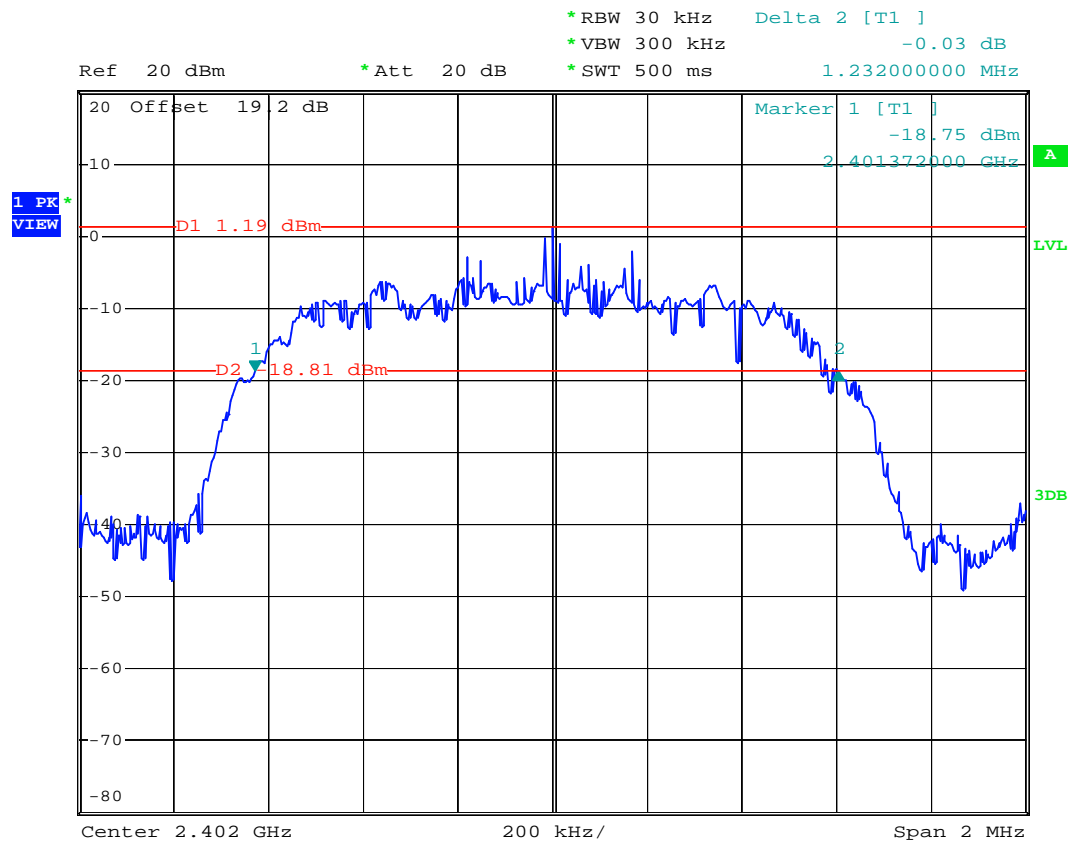

Date: 12.DEC.2007 01:45:28



Mode 5

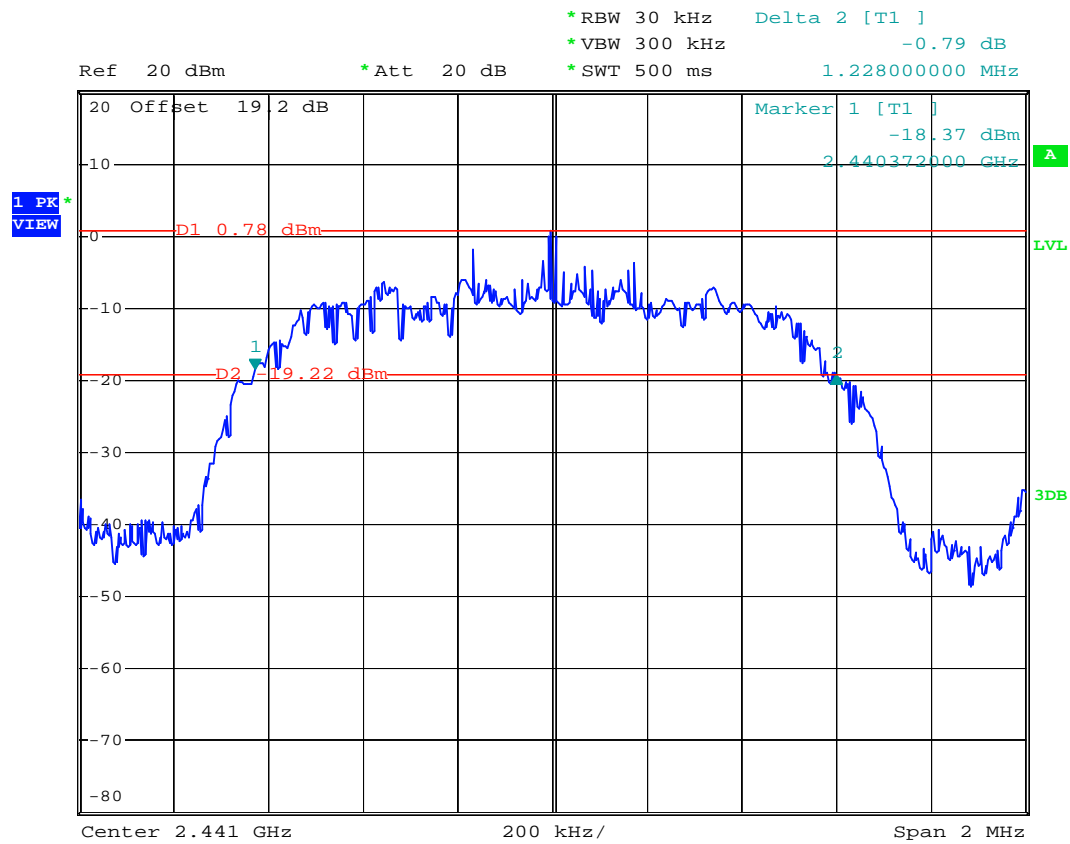

Date: 12.DEC.2007 01:47:03



Mode 6

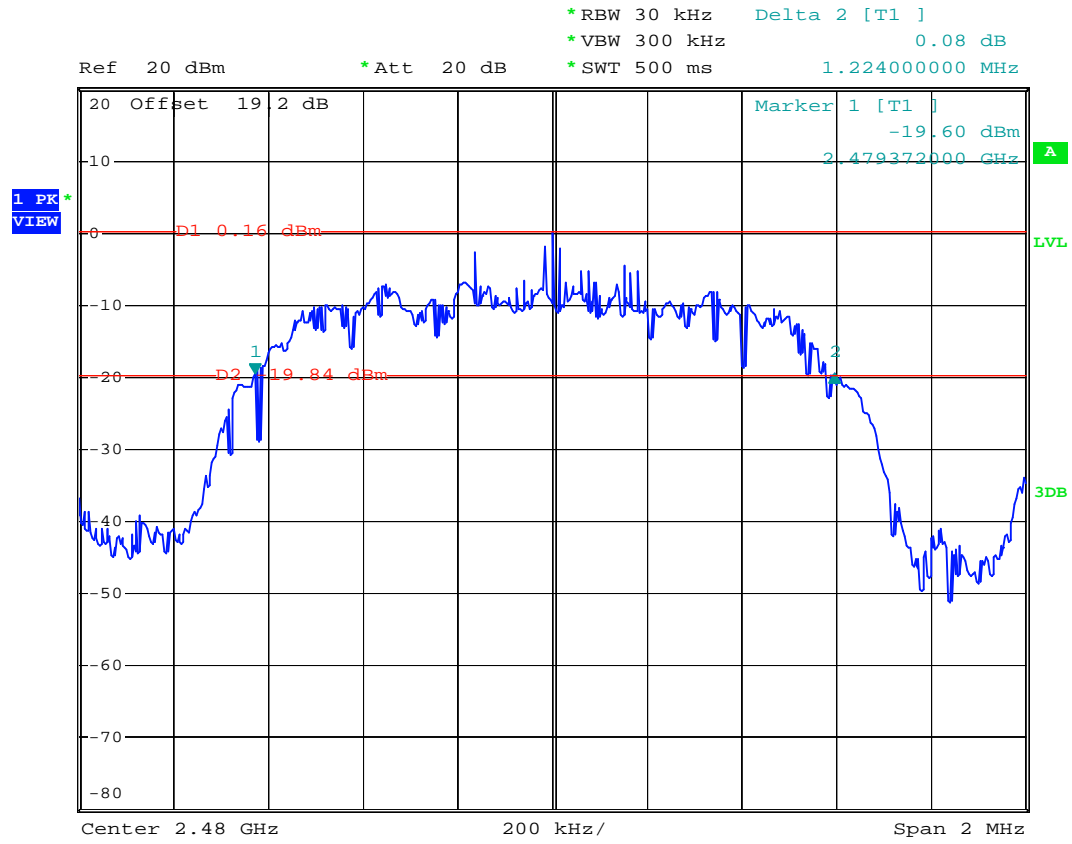

Date: 12.DEC.2007 01:48:08



Mode 7

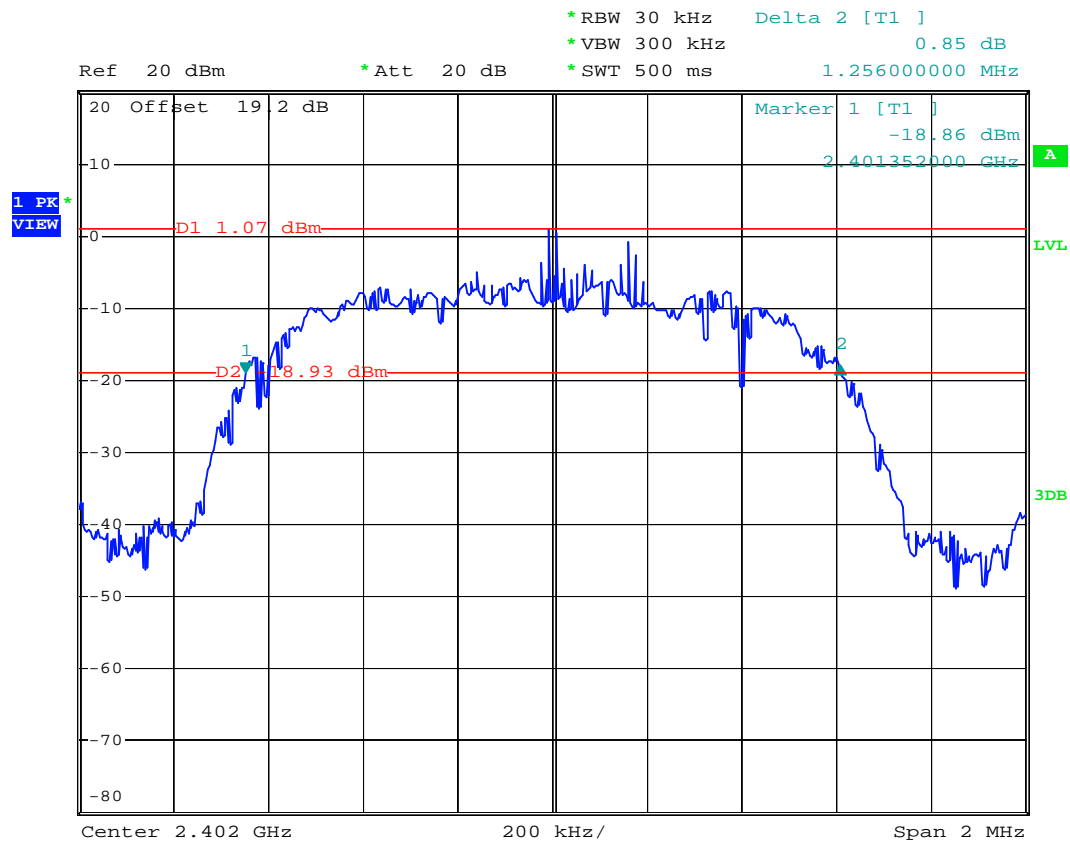

Date: 12.DEC.2007 01:51:23



Mode 8

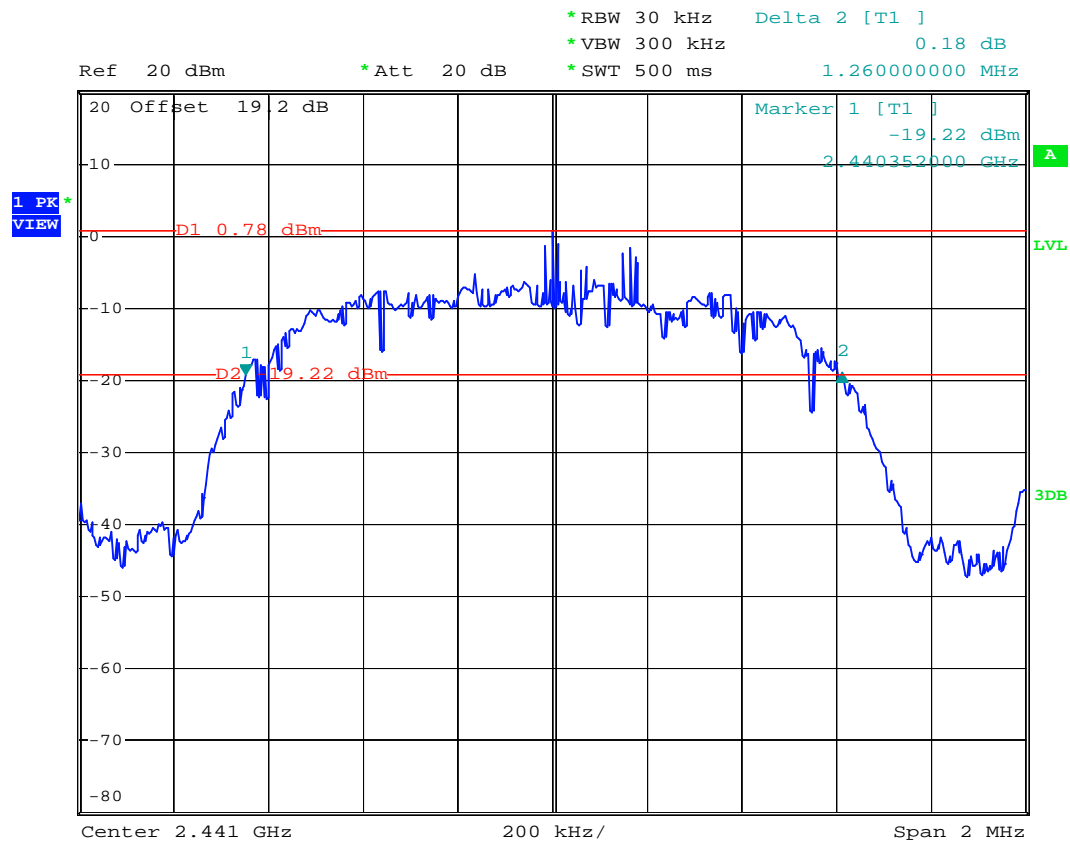

Date: 12.DEC.2007 01:50:07



Mode 9

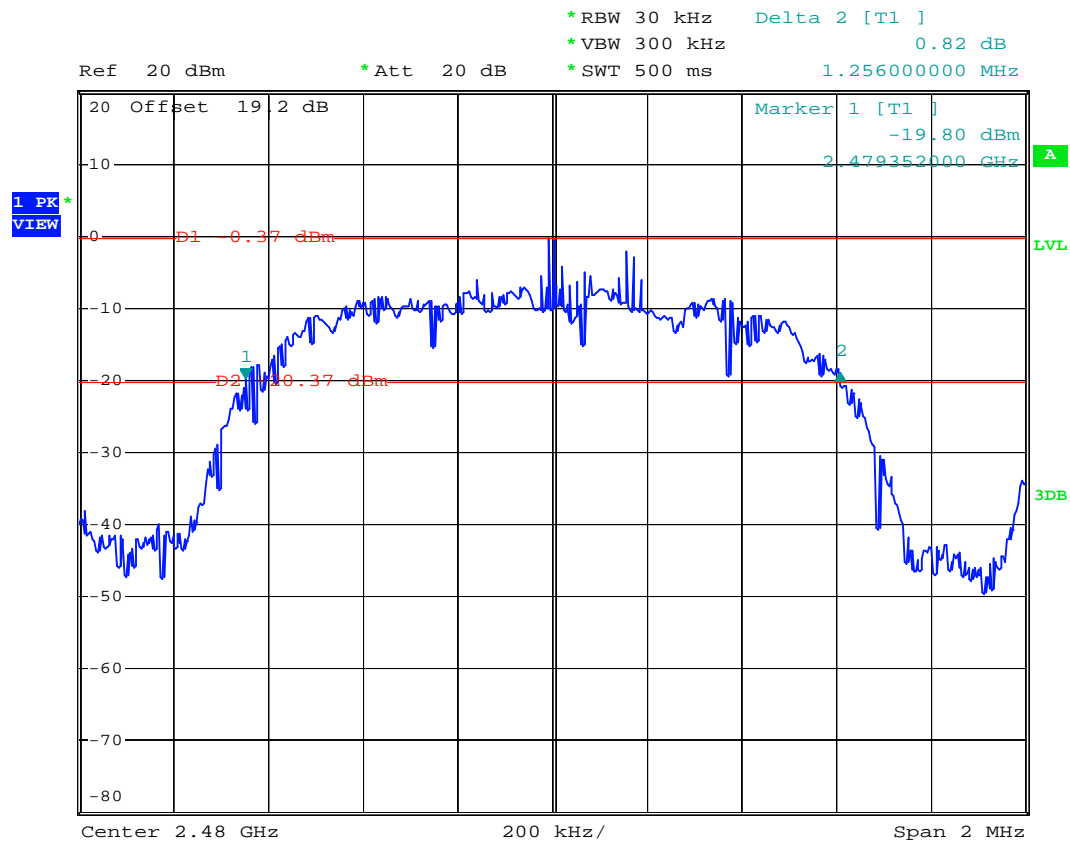

Date: 12.DEC.2007 01:48:55

## 5.6 Dwell Time of Each Frequency

### 5.6.1 Measuring Instruments

As described in chapter 9 of this test report.

### 5.6.2 Test Procedure

1. The transmitter output was connected to the spectrum analyzer by a low loss cable.
2. Set RBW of spectrum analyzer to 1MHz and VBW to 1MHz.
3. Set the center frequency on any frequency would be measure and set the frequency span to zero span.
4. The calculate  $=79 * 0.4 * (1600/79) * t$  (t = the time duration of one single pulse )

### 5.6.3 Test Setup Layout

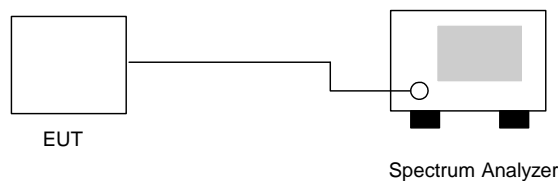

### 5.6.4 Test Result : See spectrum analyzer plots below

- Application Type : BT
- Temperature : 24~27
- Relative Humidity : 49~51%
- Test Enginner : Ken

CH39

Package Mode	Average Hopping Channel	Package Transfer Time (us)	Dwell Time (s)	Limit (s)
DH1	8.7	464	0.128	0.4
DH3	4.9	1740	0.269	0.4
DH5	3.4	3040	0.327	0.4





- Application Type : BT EDR(2Mbps)
- Temperature : 24~27
- Relative Humidity : 49~51%
- Test Enginner : Ken

CH39

Package Mode	Average Hopping Channel	Package Transfer Time (us)	Dwell Time (s)	Limit (s)
DH1	8.2	500	0.130	0.4
DH3	4.3	1740	0.236	0.4
DH5	3.2	3040	0.307	0.4

- Application Type : BT EDR(3Mbps)
- Temperature : 24~27
- Relative Humidity : 49~51%
- Test Enginner : Ken

CH39

Package Mode	Average Hopping Channel	Package Transfer Time (us)	Dwell Time (s)	Limit (s)
DH1	9.2	492	0.143	0.4
DH3	4.5	1740	0.247	0.4
DH5	3	3050	0.289	0.4

※ Remark:

1. Dwell Time=79(channels) x 0.4(s) x average hopping channel x package transfer time
2. 79 channels come from the Hopping Channel number.
3. Average Hopping Channel = hops/sweep time
4. t: Package Transfer Time(us)



5.6.5 Dwell Time

DH1 (CH39)

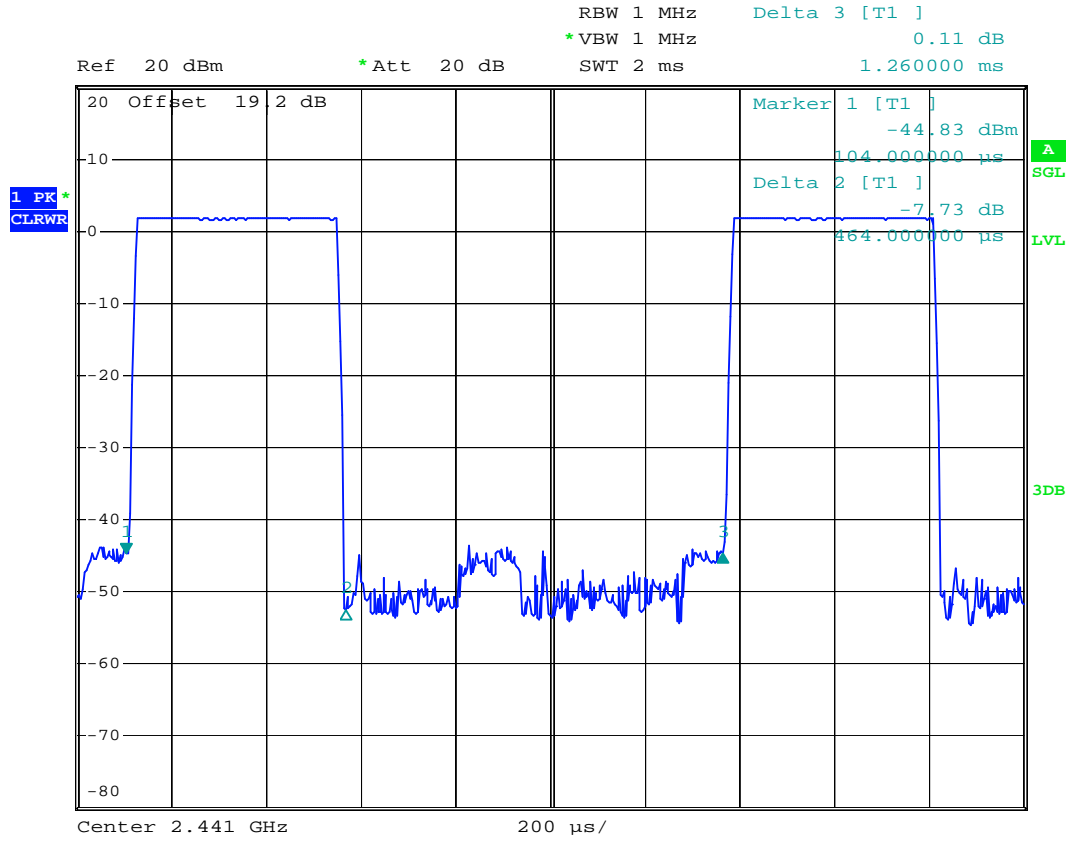

Date: 12.DEC.2007 01:34:18

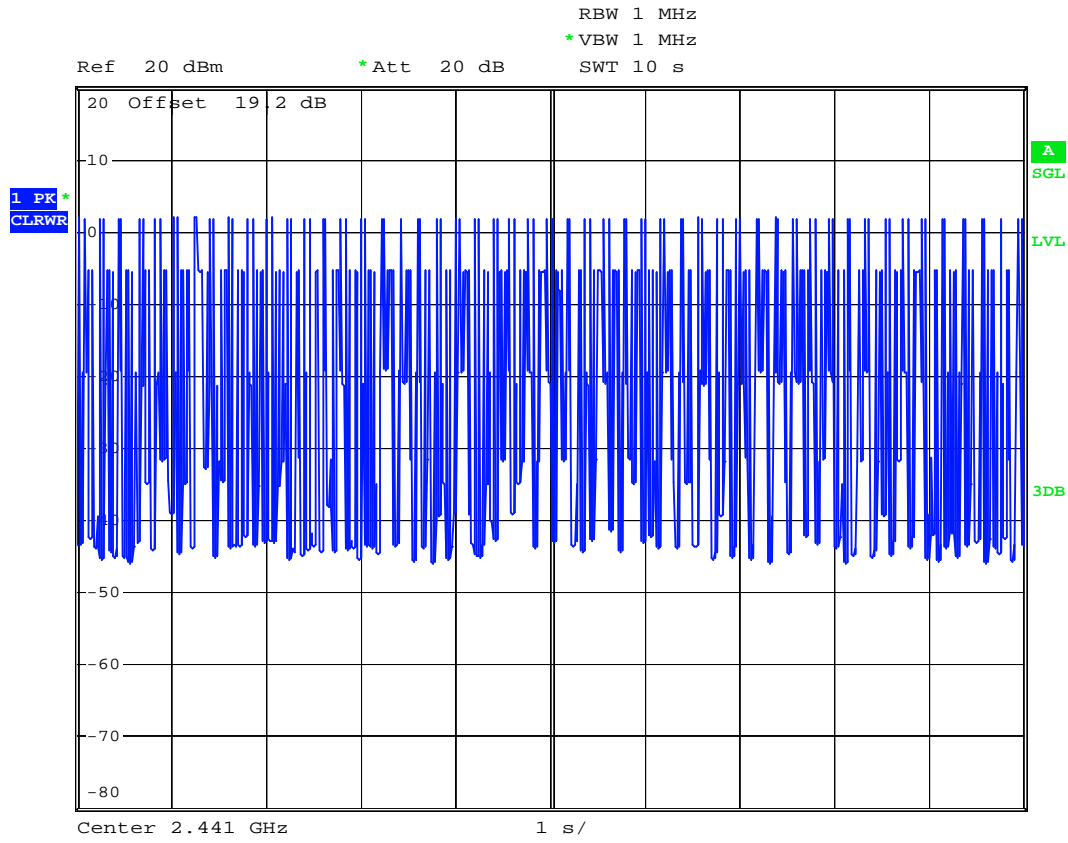

Date: 12.DEC.2007 01:37:18



DH3 (CH39)

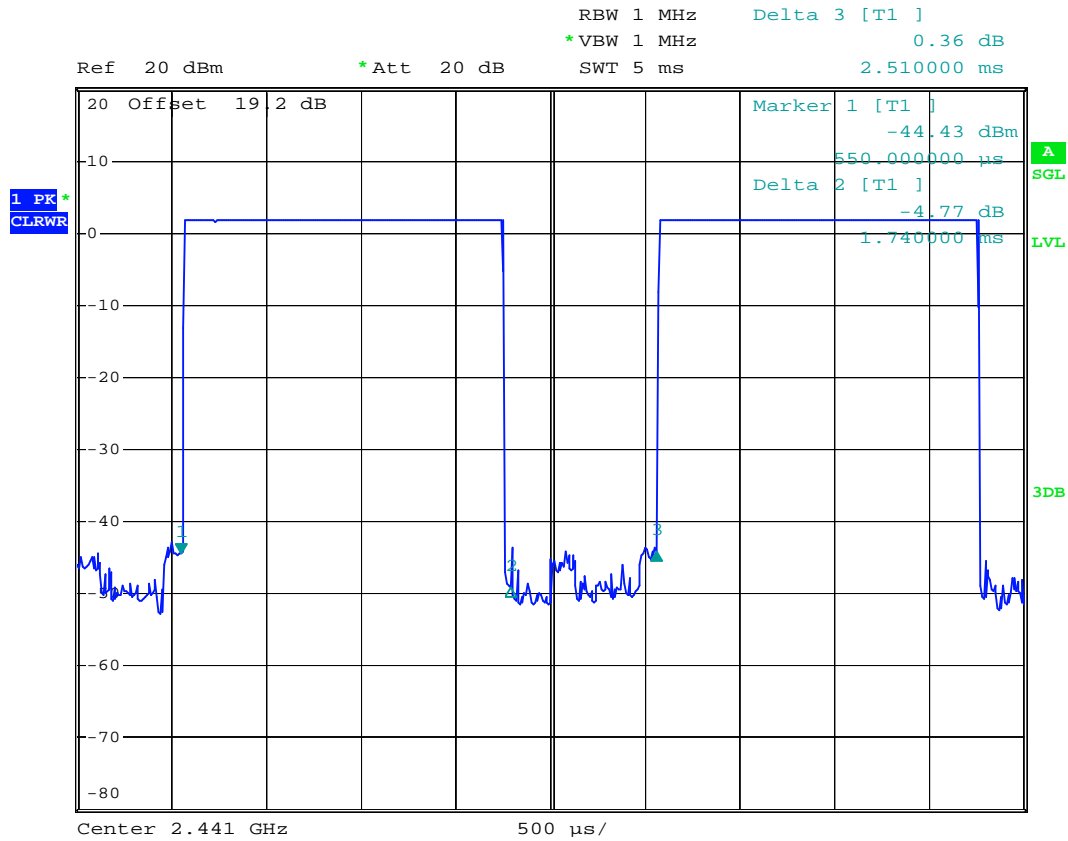

Date: 12.DEC.2007 01:35:08

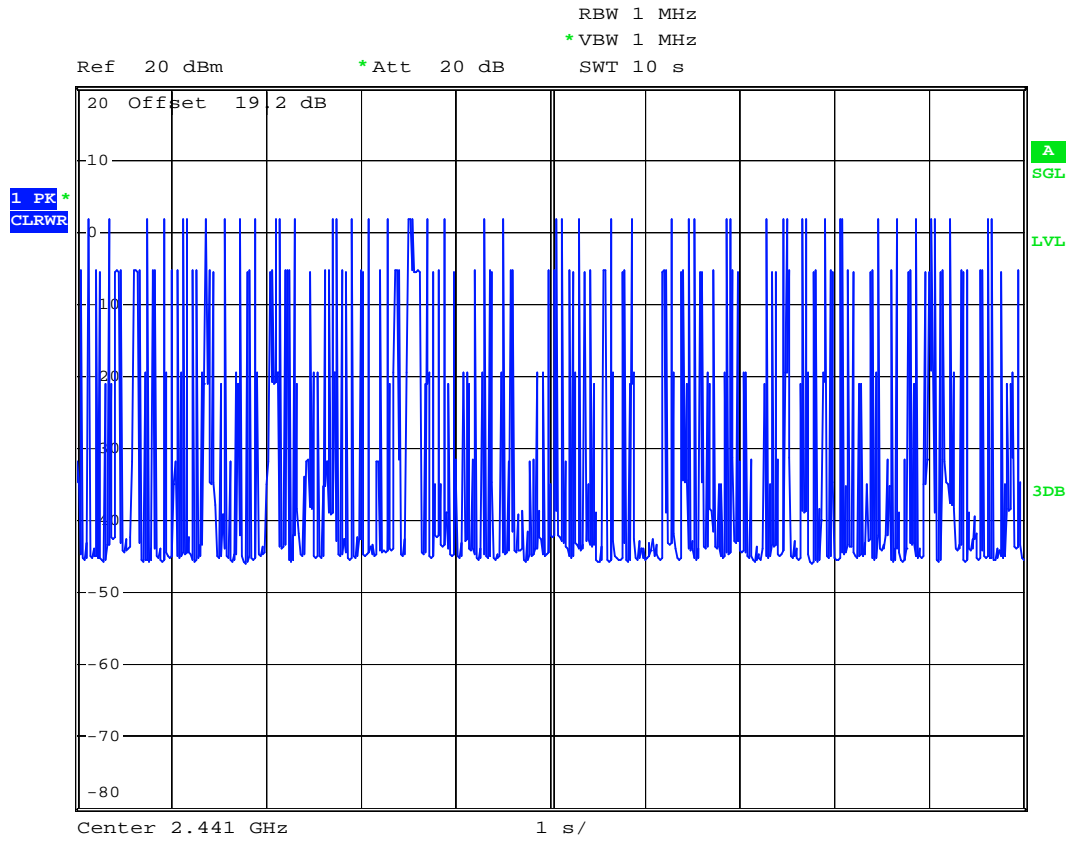

Date: 12.DEC.2007 01:39:39



DH5 (CH39)

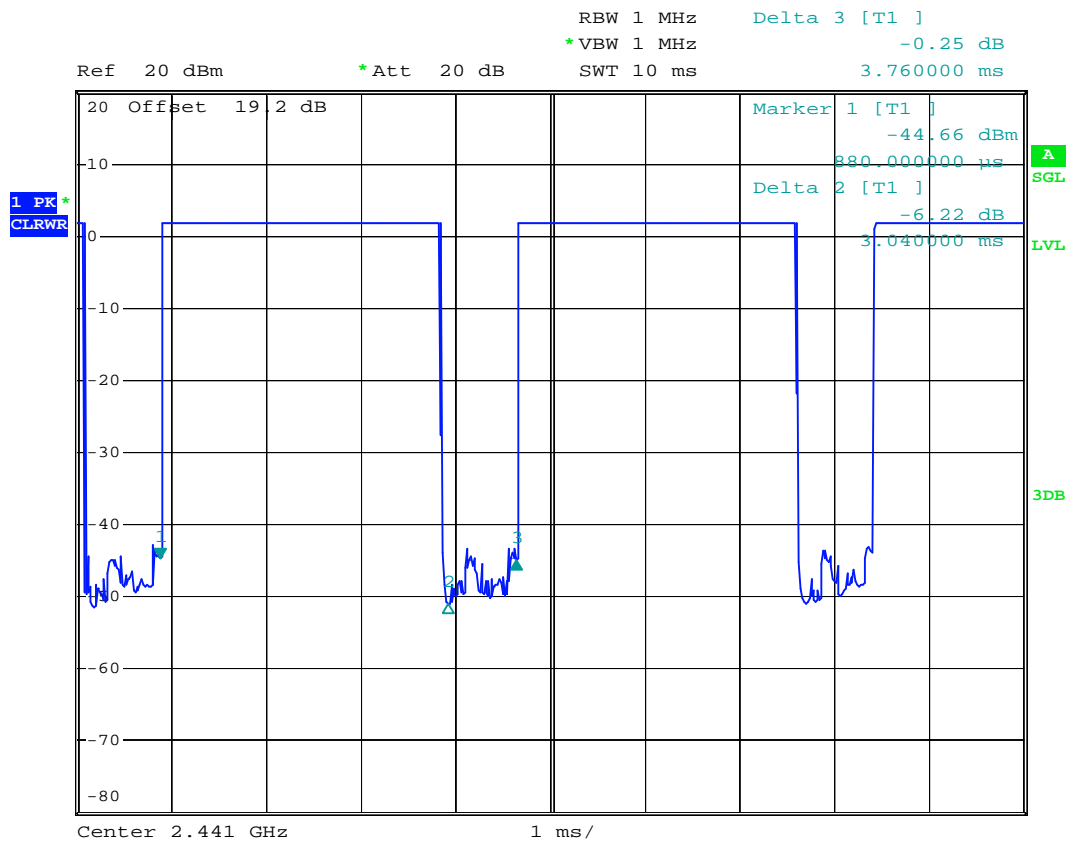

Date: 12.DEC.2007 01:35:52

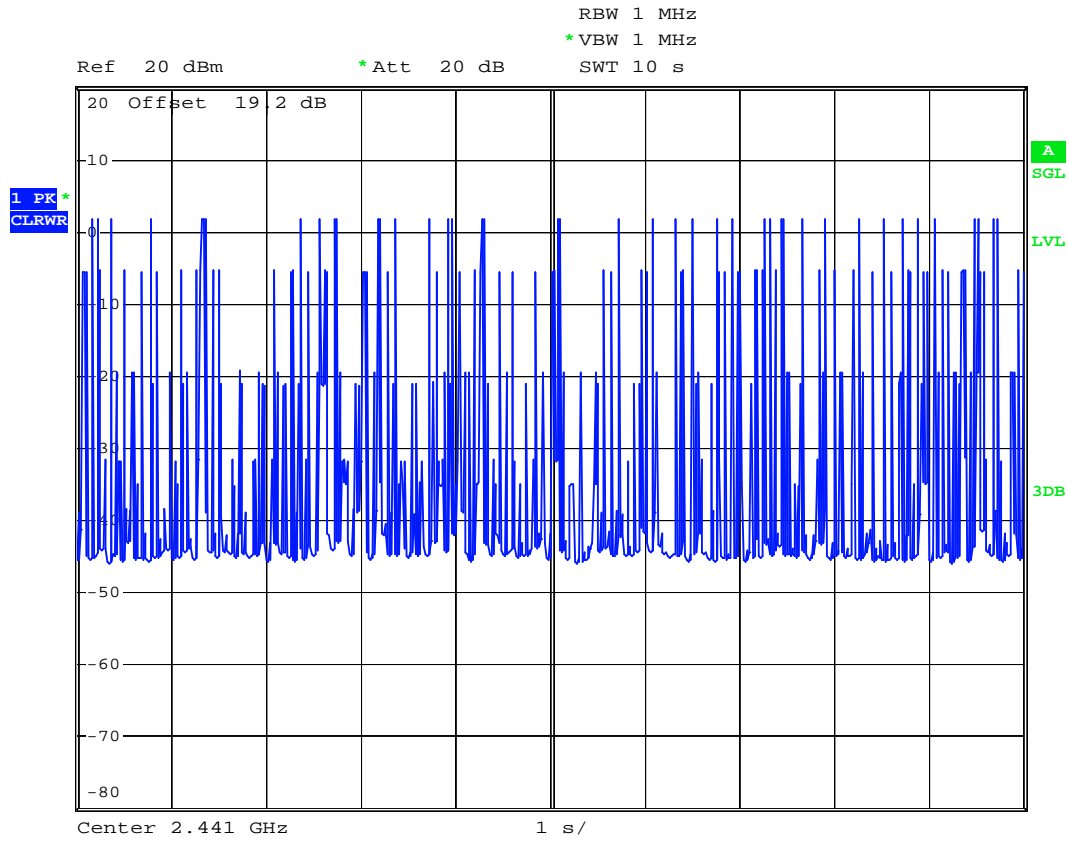

Date: 12.DEC.2007 01:40:13



2DH1 (CH39)

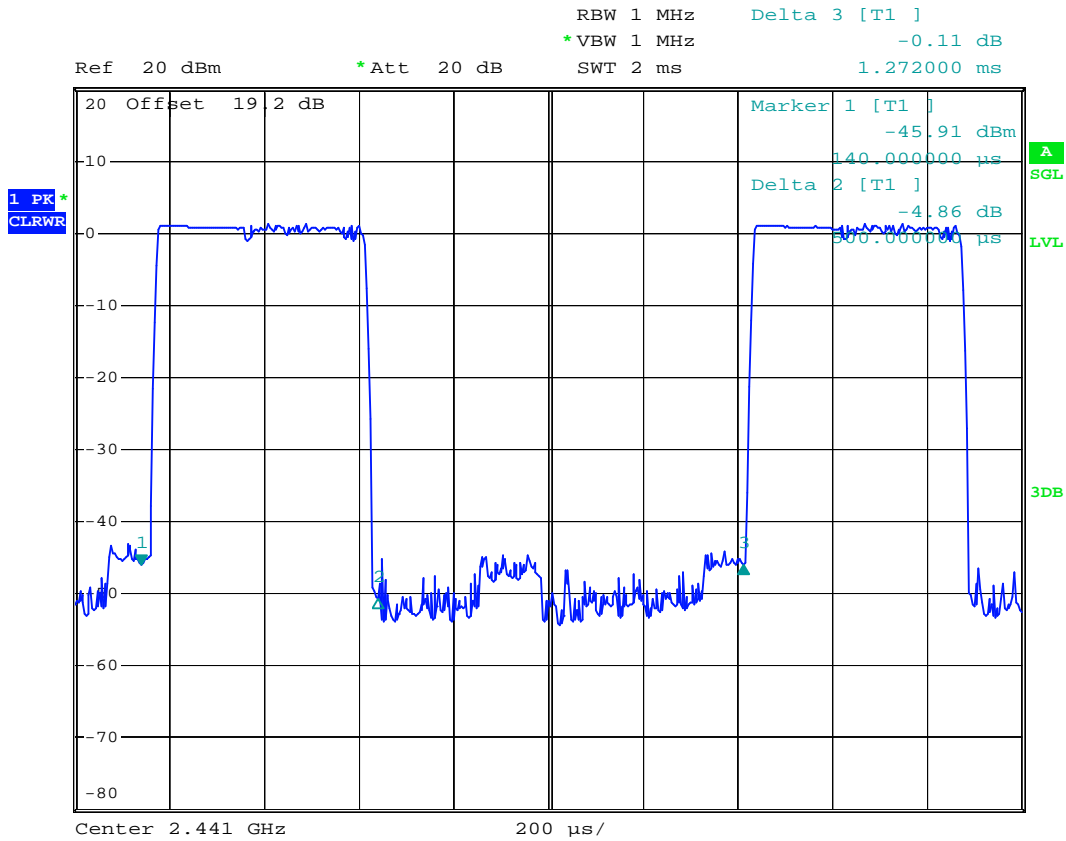

Date: 12.DEC.2007 02:05:21



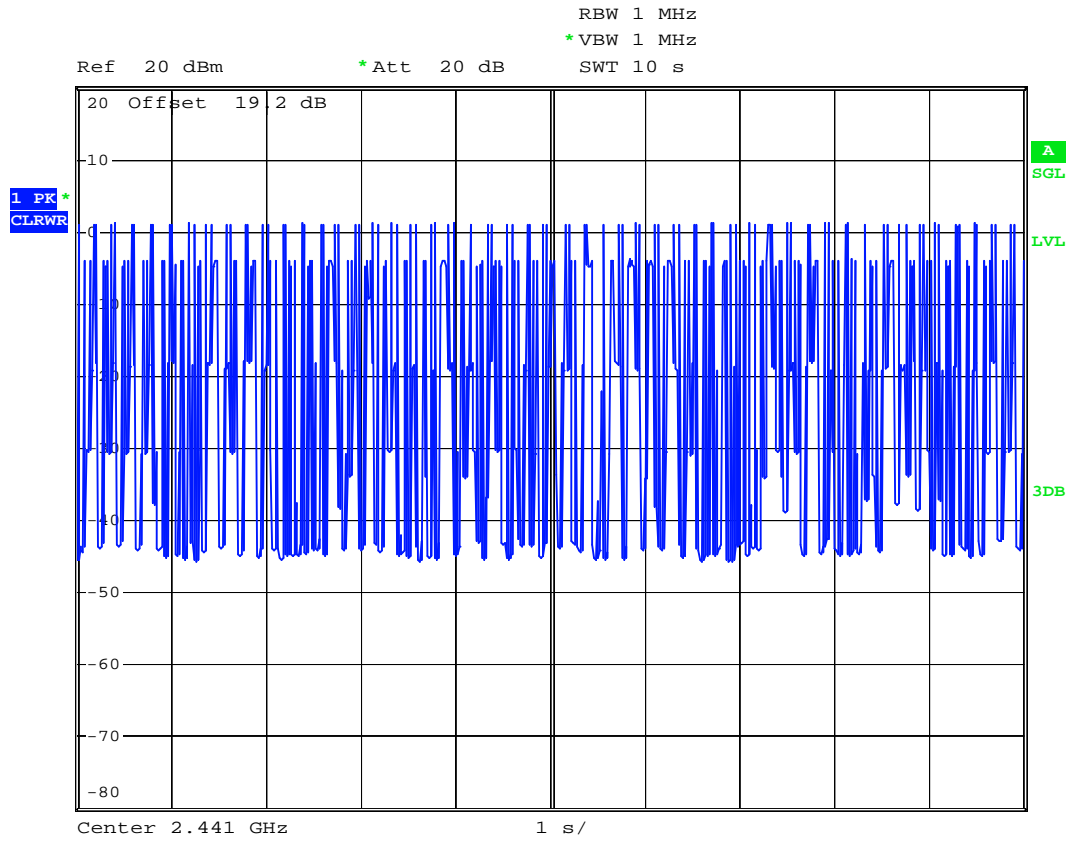

Date: 12.DEC.2007 02:14:32



2 DH3 (CH39)

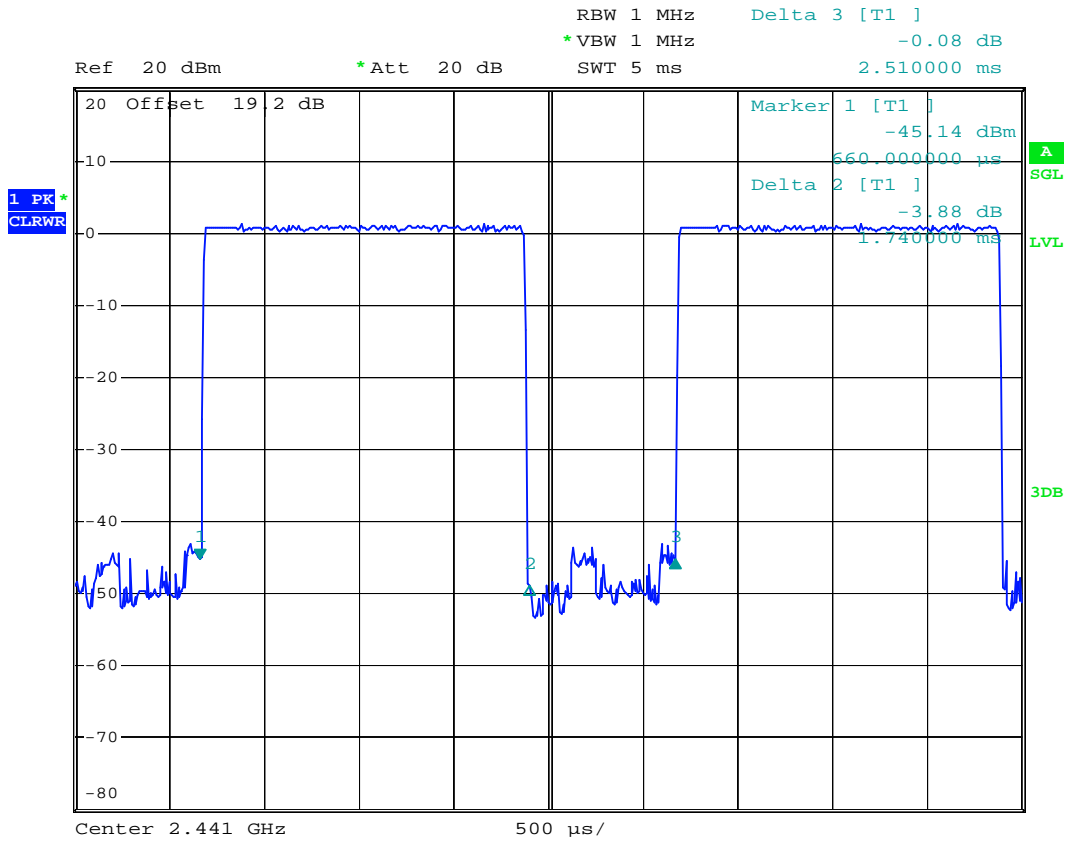

Date: 12.DEC.2007 02:06:46

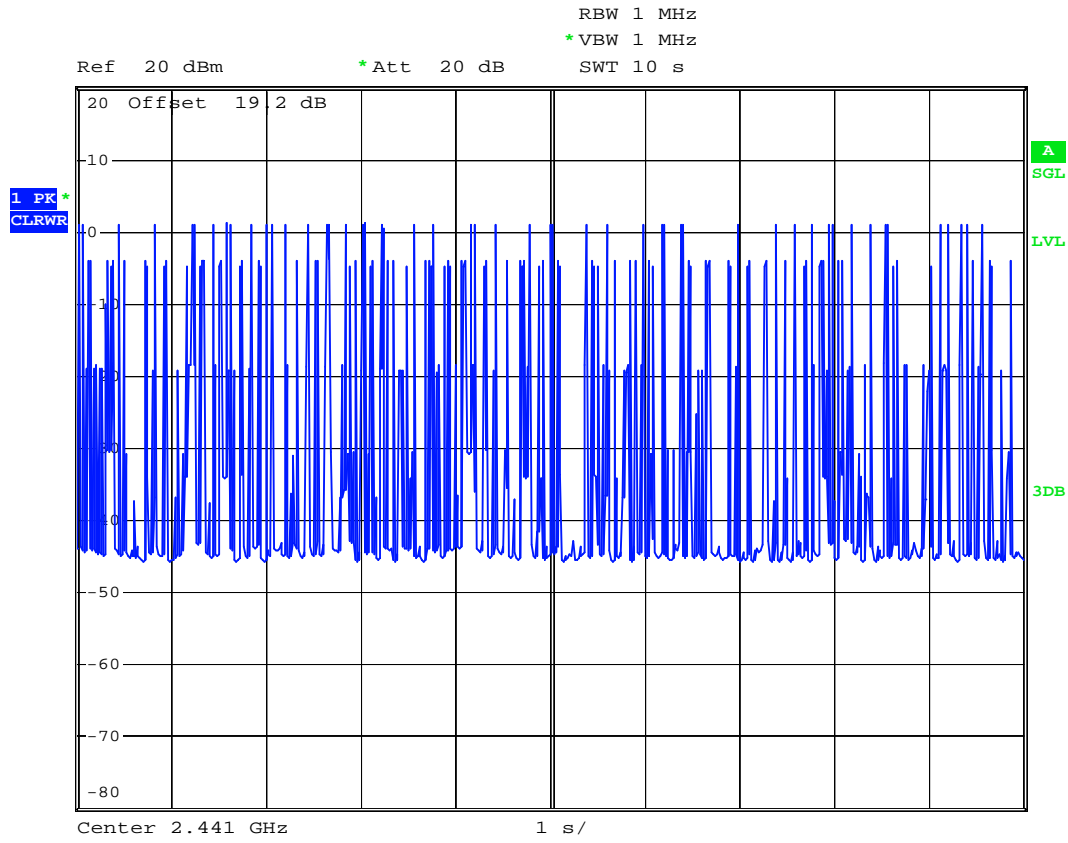

Date: 12.DEC.2007 02:15:15



2 DH5 (CH39)

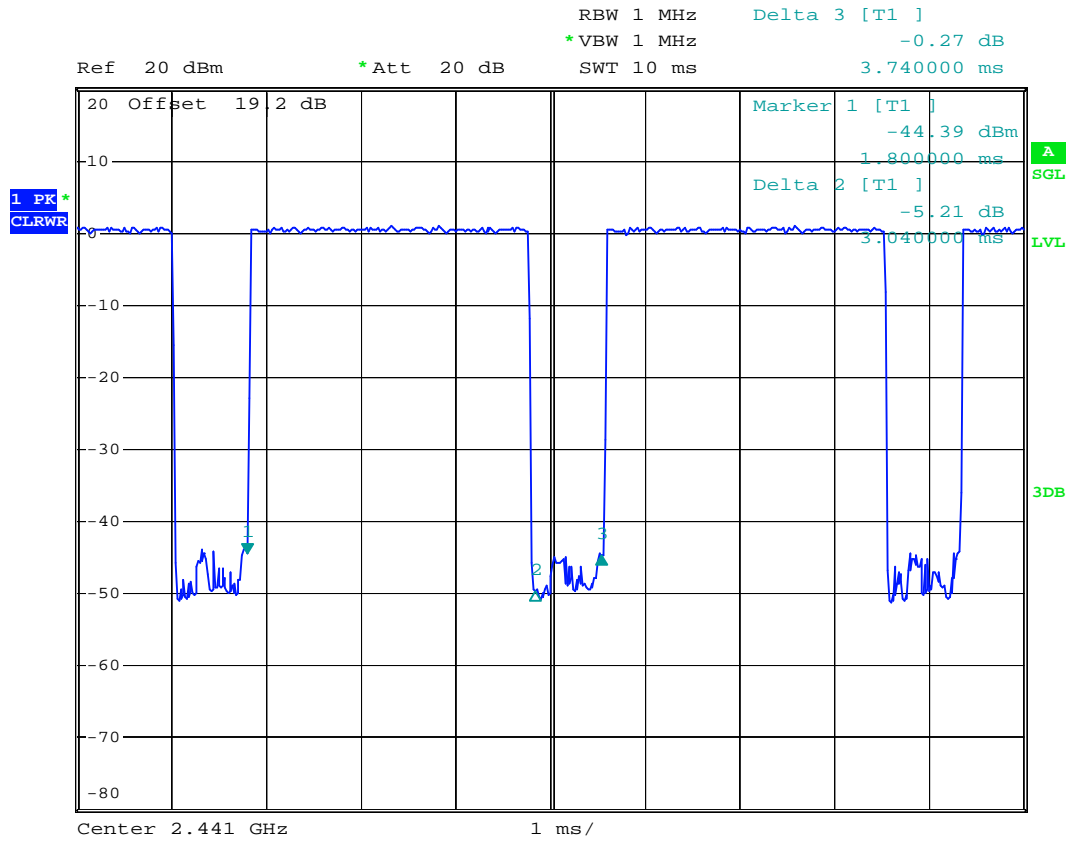

Date: 12.DEC.2007 02:10:39

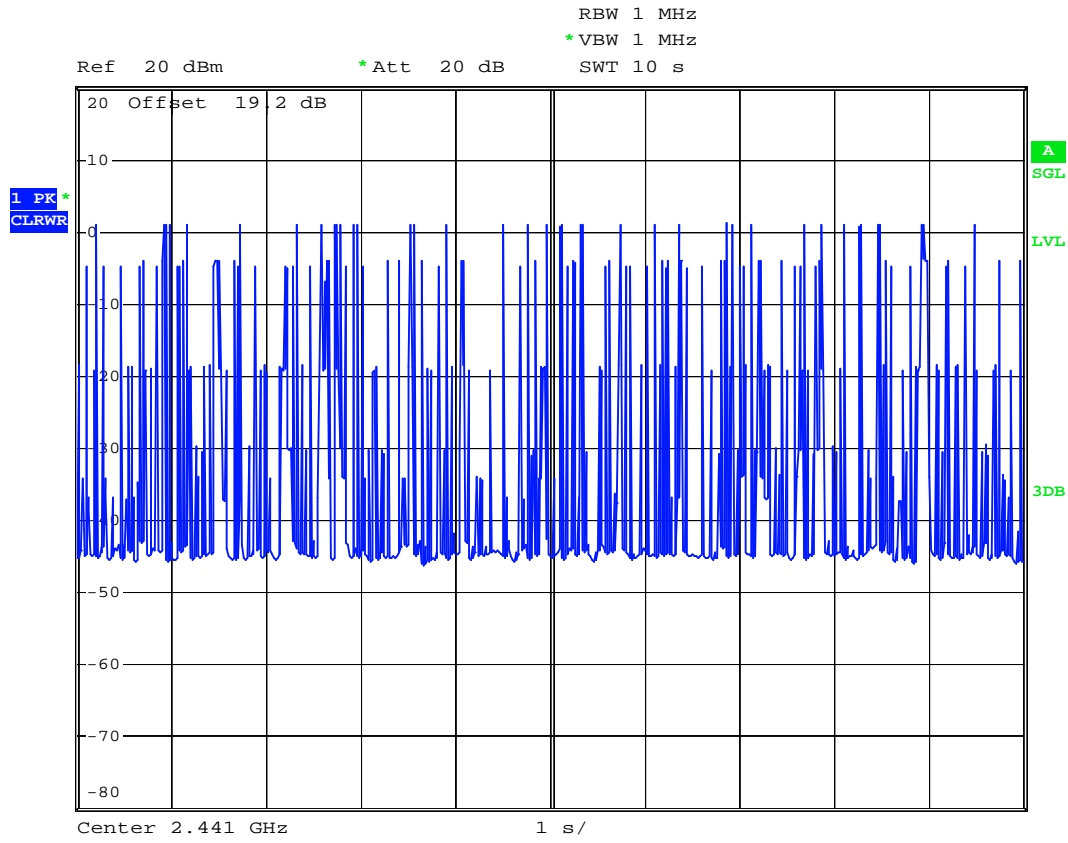

Date: 12.DEC.2007 02:15:43



3DH1 (CH39)

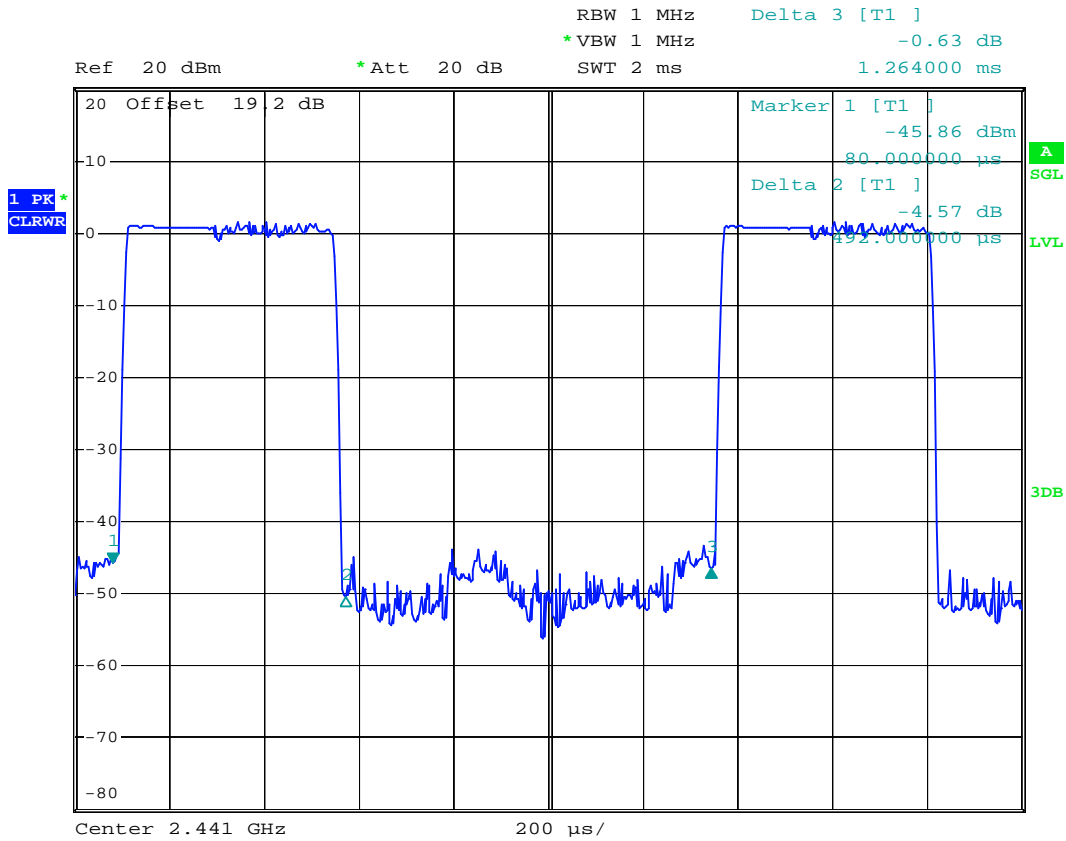

Date: 12.DEC.2007 02:12:07

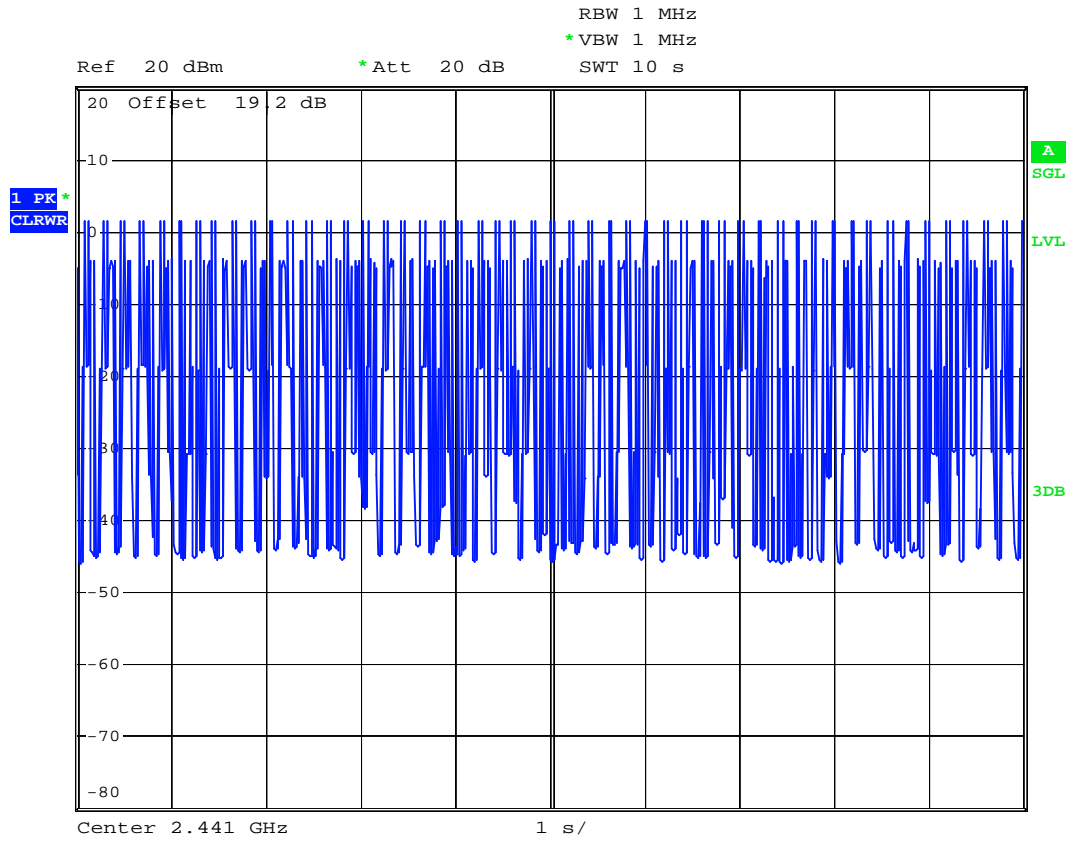

Date: 12.DEC.2007 02:16:26



3DH3 (CH39)

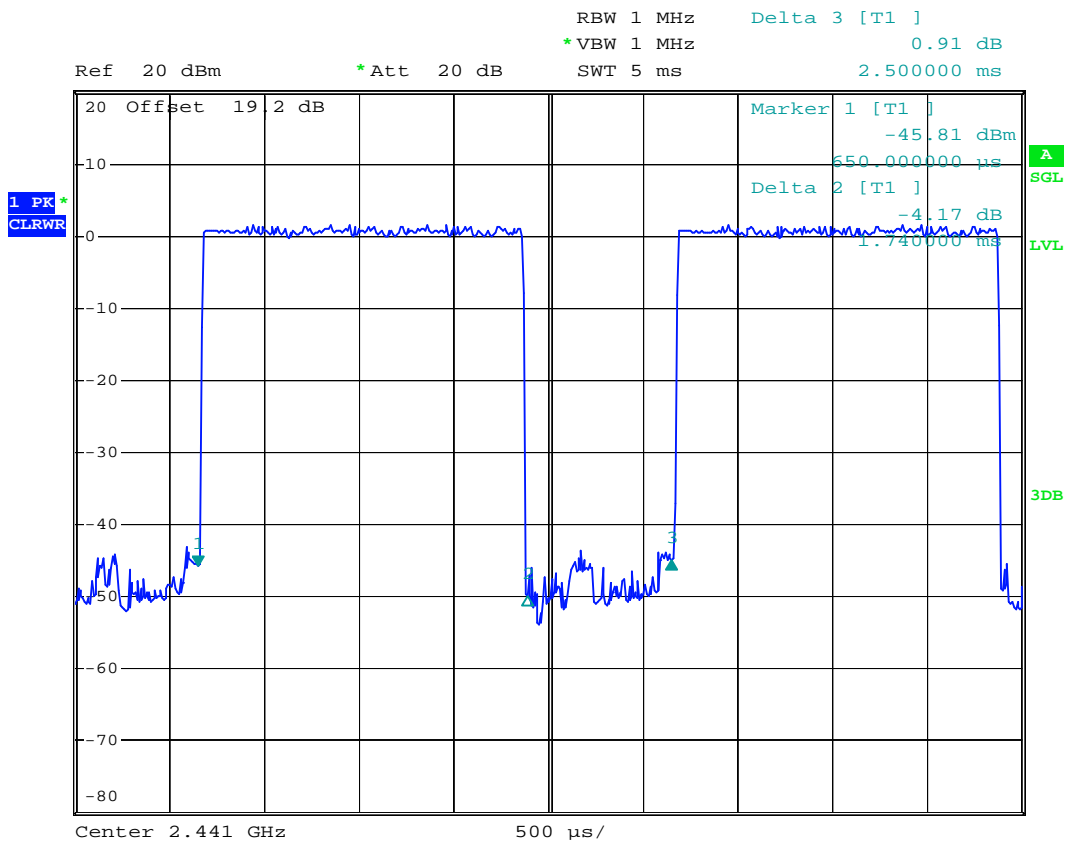

Date: 12.DEC.2007 02:13:12



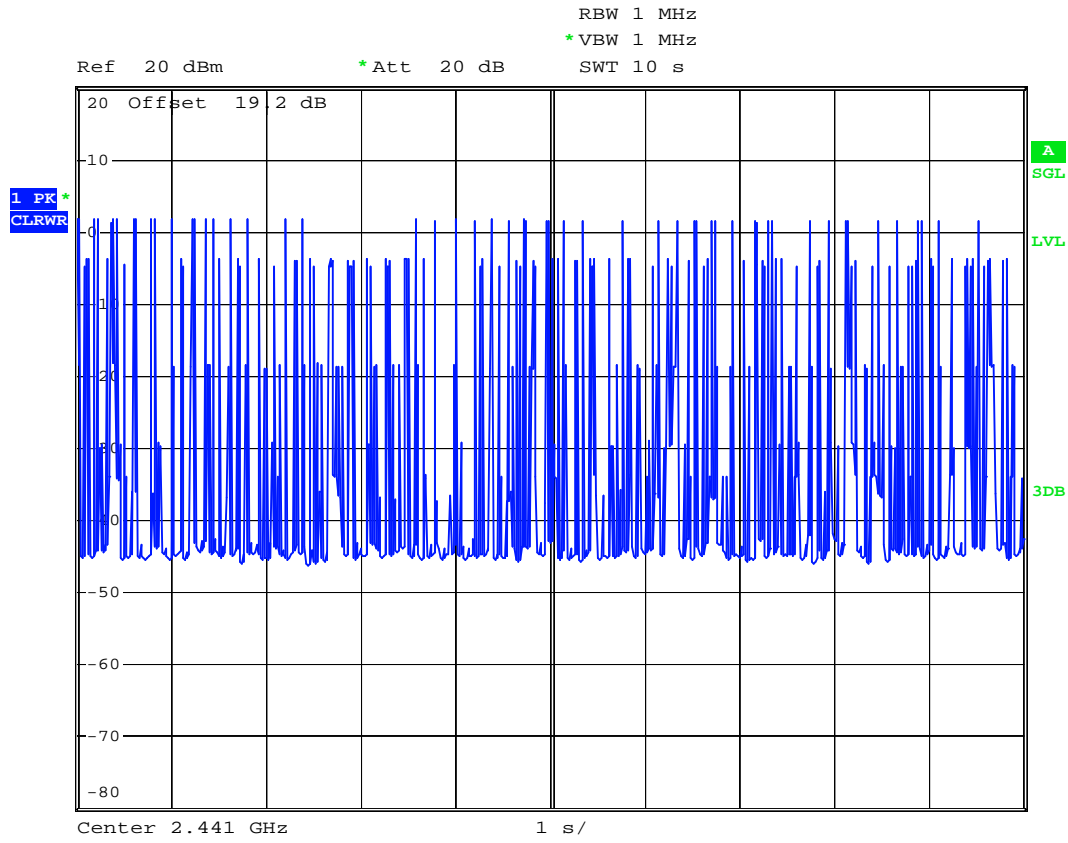

Date: 12.DEC.2007 02:20:04



3DH5 (CH39)

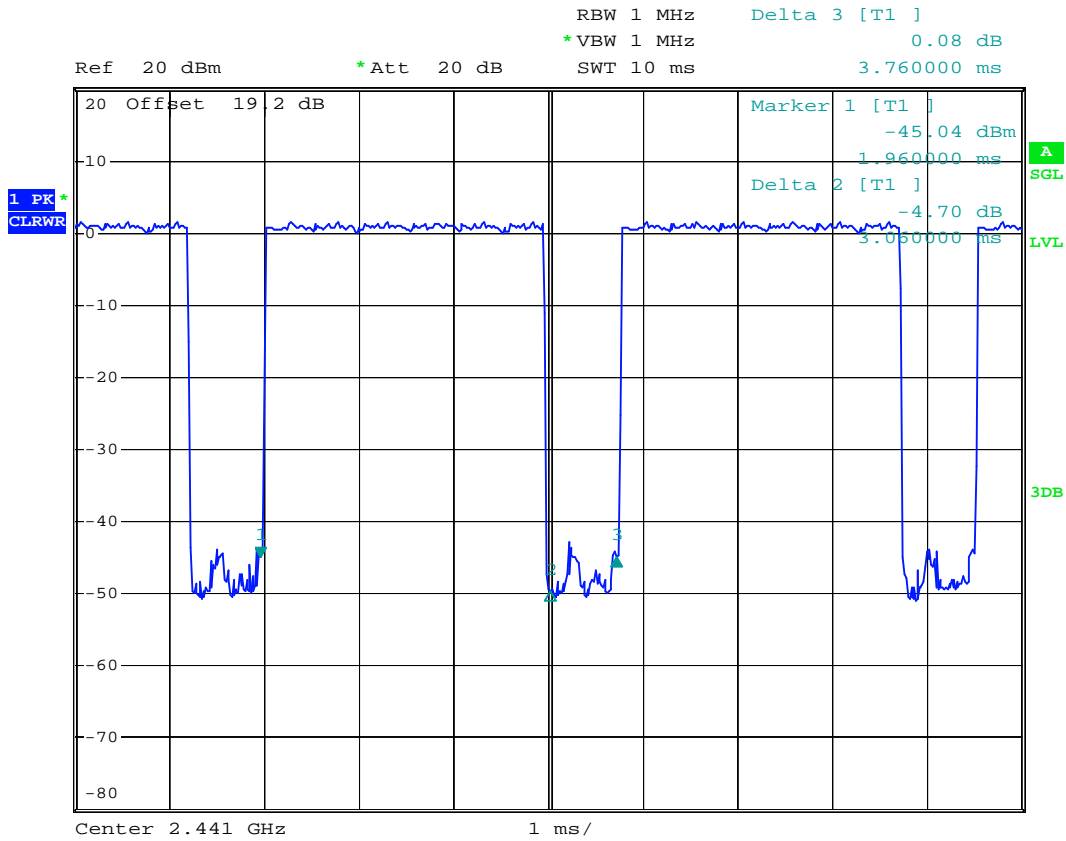

Date: 12.DEC.2007 02:13:53

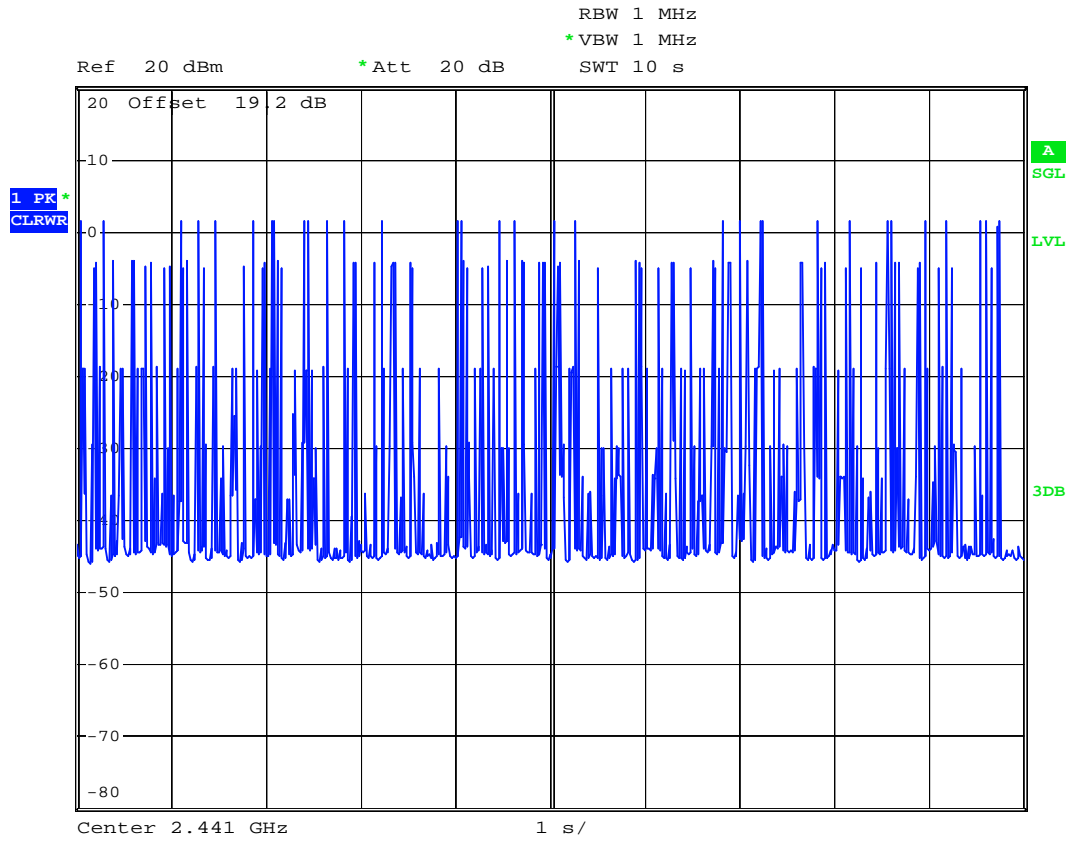

Date: 12.DEC.2007 02:20:32

## 5.7 Peak Output Power Measurement

### 5.7.1 Measuring Instruments

As described in chapter 6 of this test report.

### 5.7.2 Test Procedure

The antenna port (RF output) of the EUT was connected to the input (RF input) of a spectrum analyzer for BT measurement. RBW and VBW are set to 3MHz. The cable loss has been offset before testing.

### 5.7.3 Test Setup Layout

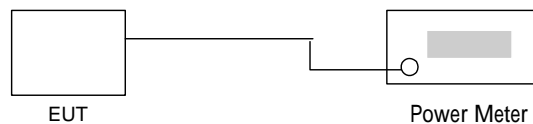



5.7.4 Test Result

- Application Type : BT
- Temperature : 24~27
- Relative Humidity : 49~51%
- Test Engineer : Ken

▪ BT(1Mbps)

Channel	Frequency (MHz)	Measured Output Power (dBm)	Limits (Watt/dBm )
00	2402	2.25	1W/30 dBm
39	2441	2.14	1W/30 dBm
78	2480	1.62	1W/30 dBm

▪ BT EDR(2Mbps)

Channel	Frequency (MHz)	Measured Output Power (dBm)	Limits (Watt/dBm )
00	2402	2.40	1W/30 dBm
39	2441	2.03	1W/30 dBm
78	2480	1.33	1W/30 dBm

▪ BT EDR(3Mbps)

Channel	Frequency (MHz)	Measured Output Power (dBm)	Limits (Watt/dBm )
00	2402	2.53	1W/30 dBm
39	2441	2.22	1W/30 dBm
78	2480	1.50	1W/30 dBm



5.7.5 Output Power

Bluetooth (1Mbps)

Mode : CH00 (2402MHz)

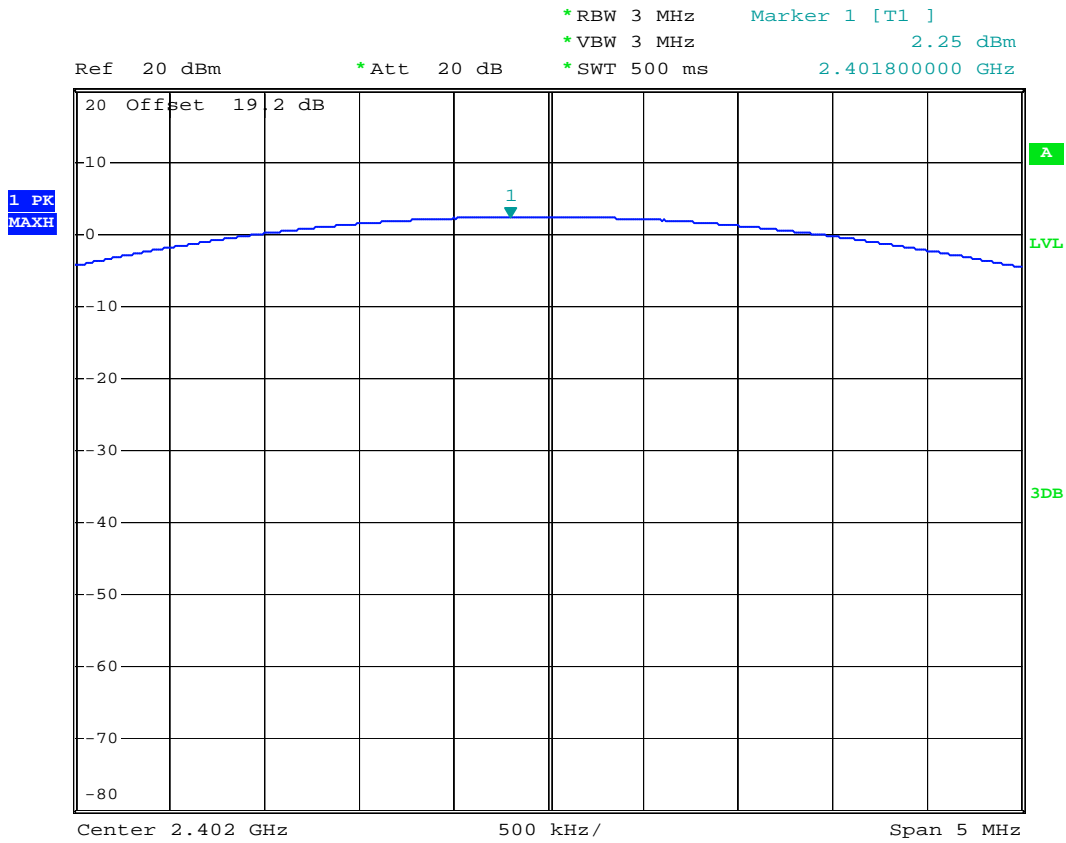

Date: 12.DEC.2007 01:16:45



Bluetooth (1Mbps)

Mode : CH39 (2441MHz)

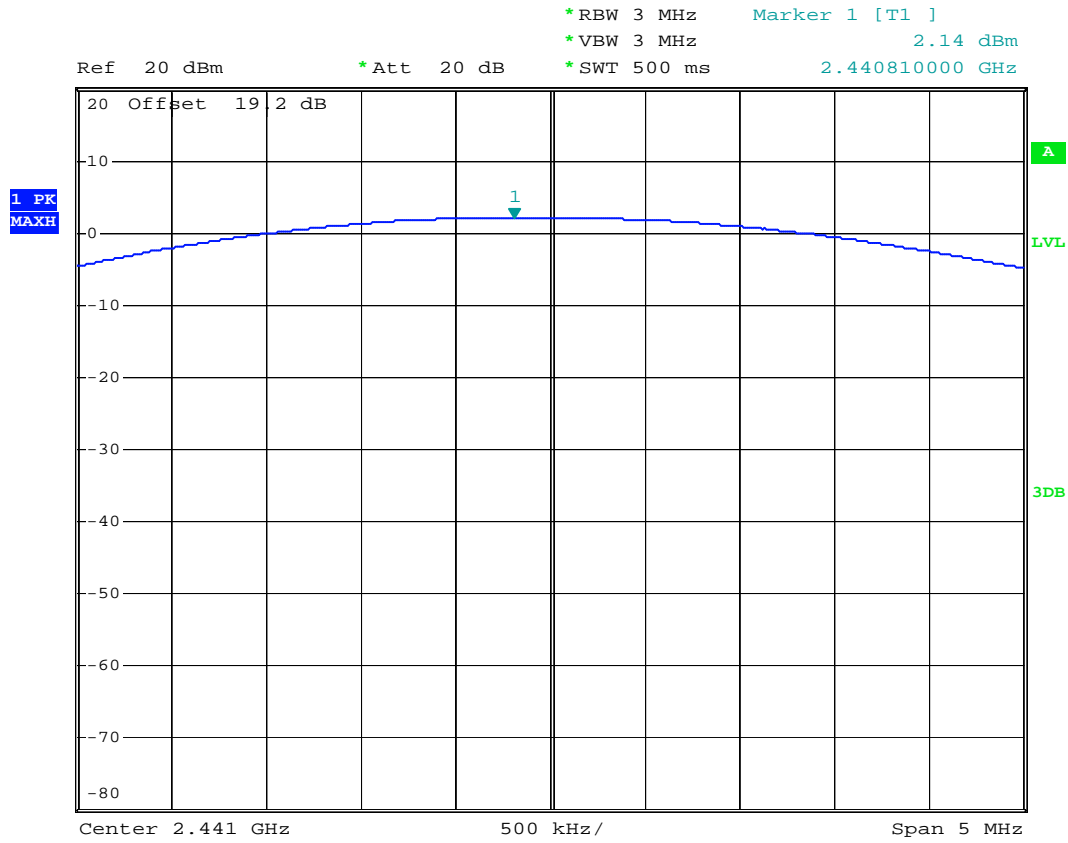

Date: 12.DEC.2007 01:17:09



Bluetooth (1Mbps)

Mode : CH78 (2480MHz)

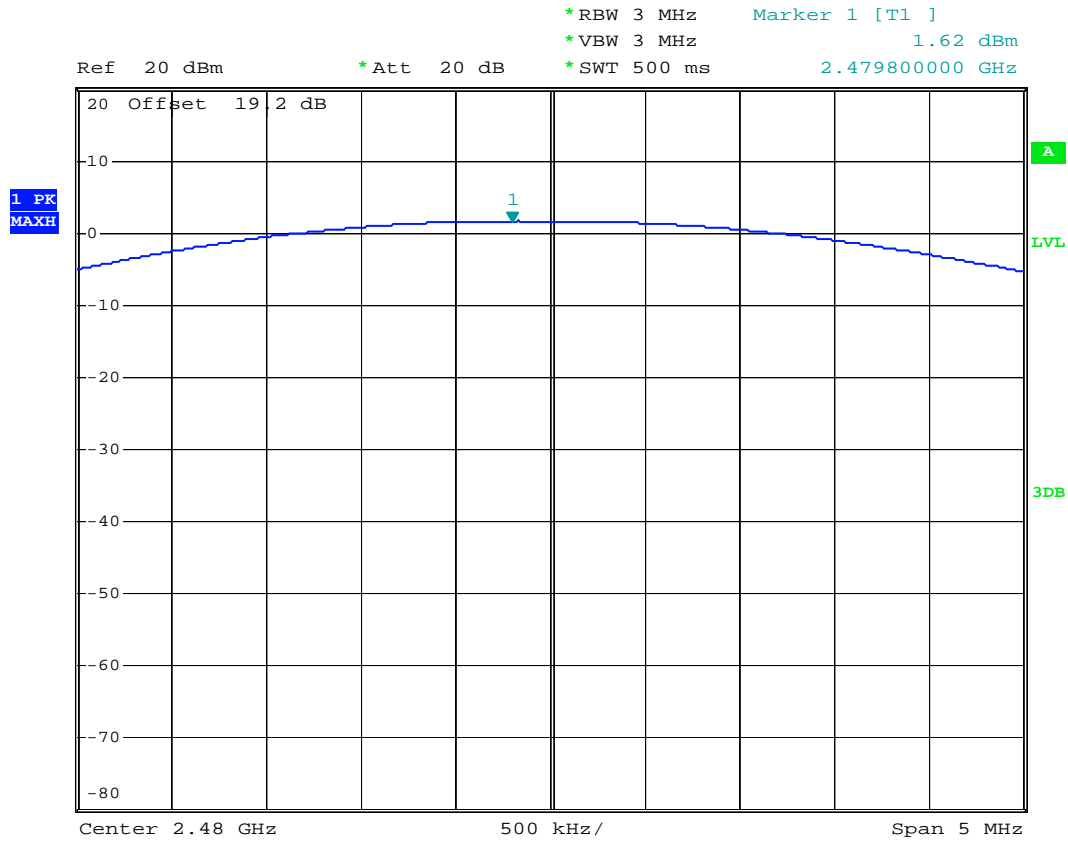

Date: 12.DEC.2007 01:17:29





Bluetooth (2Mbps)

Mode : CH00 (2402MHz)

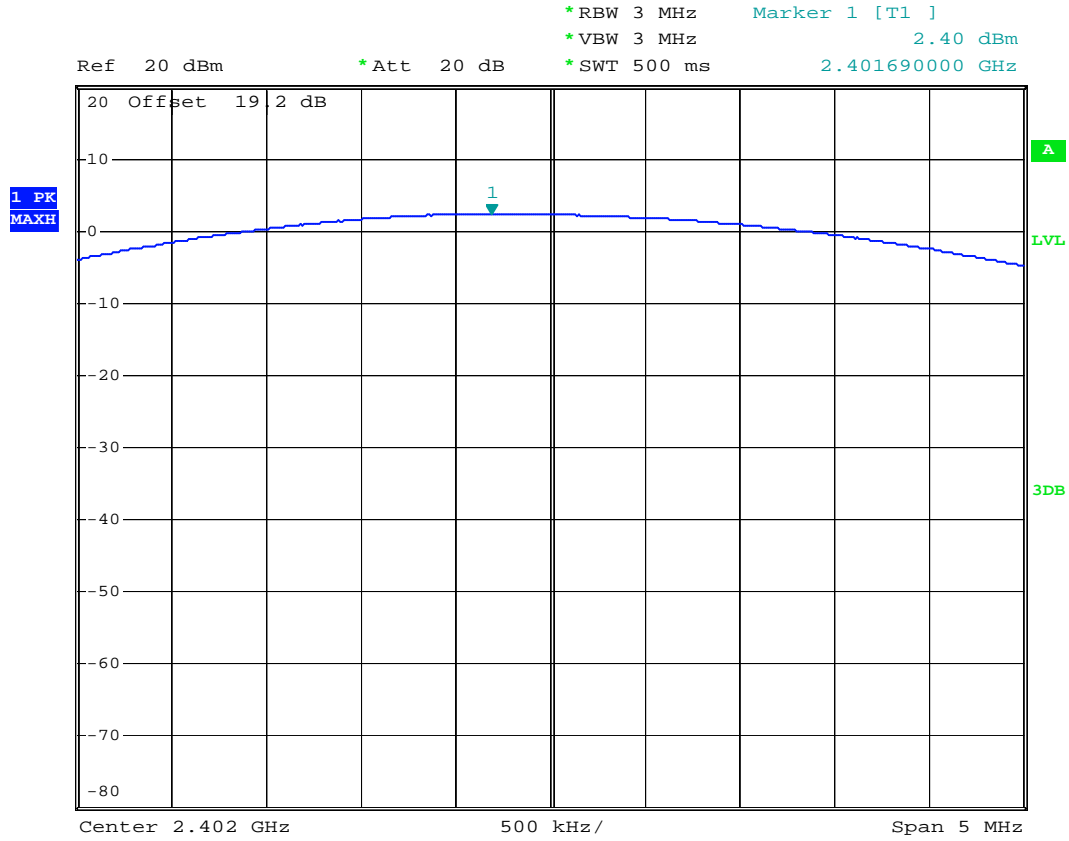

Date: 12.DEC.2007 01:41:51



Bluetooth (2Mbps)

Mode : CH39 (2441MHz)

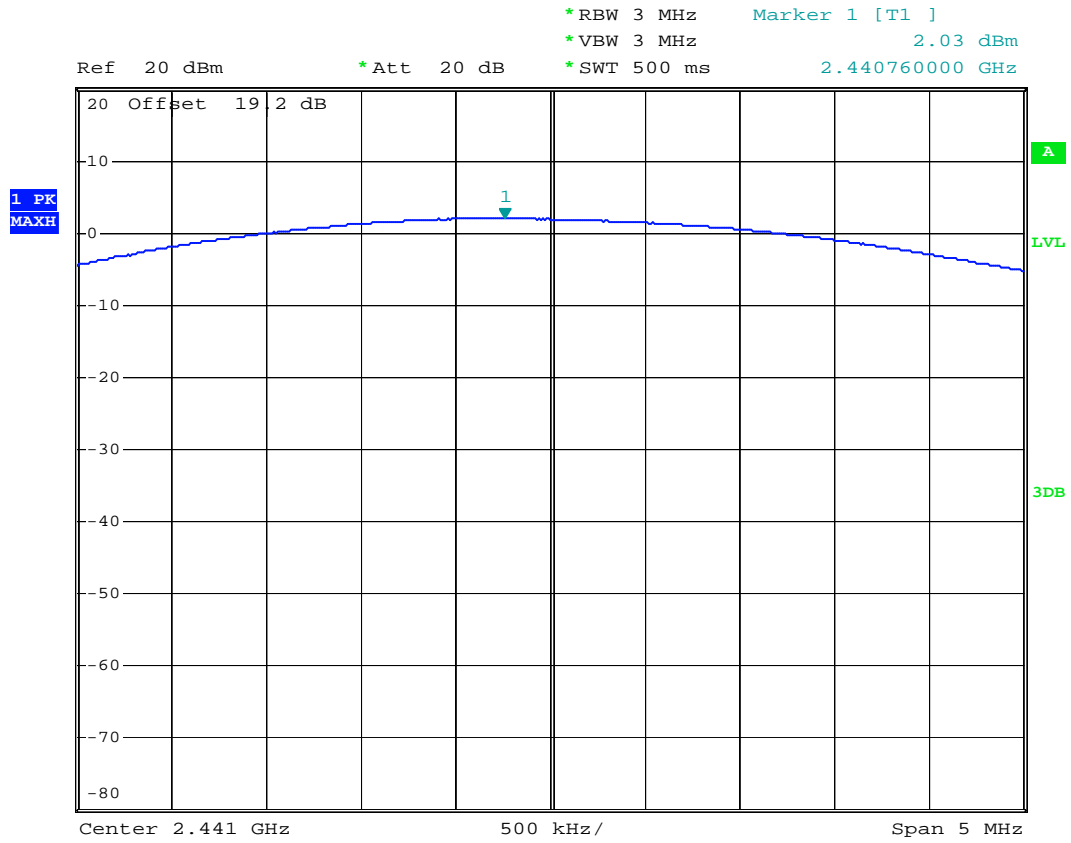

Date: 12.DEC.2007 01:42:16



Bluetooth (2Mbps)

Mode : CH78 (2480MHz)

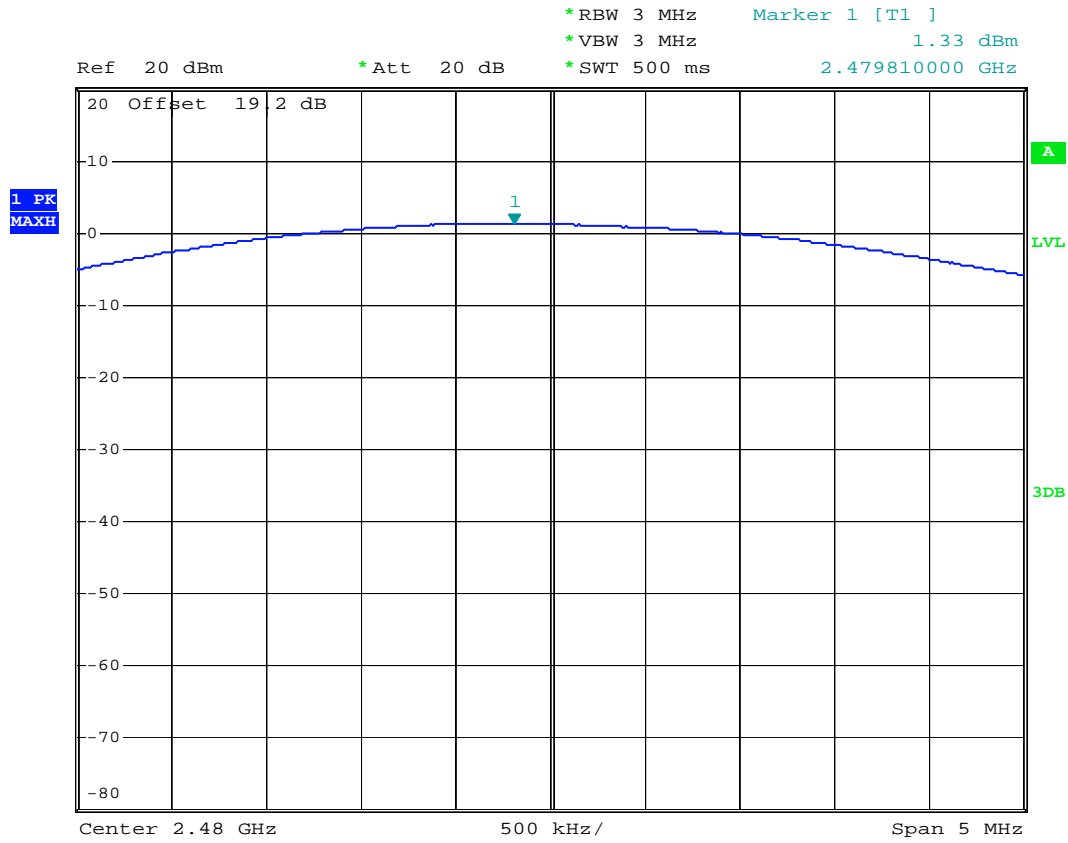

Date: 12.DEC.2007 01:42:38



Bluetooth (3Mbps)

Mode : CH00 (2402MHz)

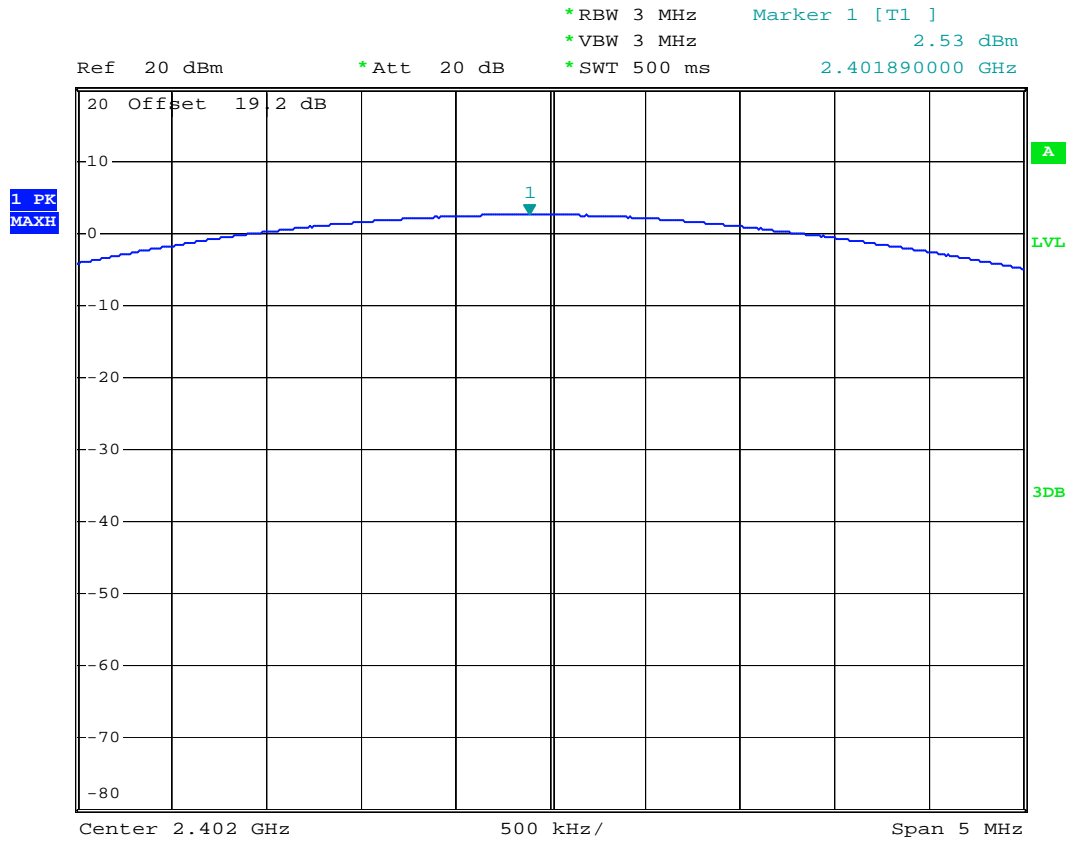

Date: 12.DEC.2007 01:43:07



Bluetooth (3Mbps)

Mode : CH39 (2441MHz)

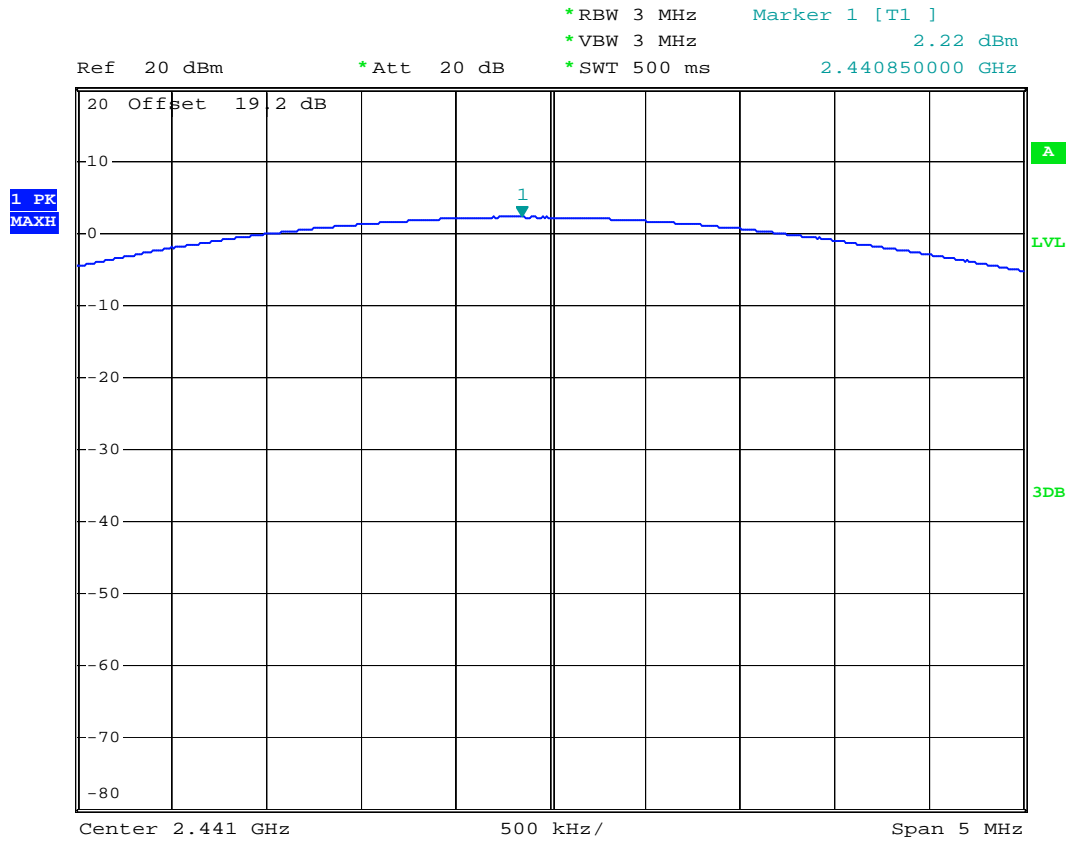

Date: 12.DEC.2007 01:43:31



Bluetooth (3Mbps)

Mode : CH78 (2480MHz)

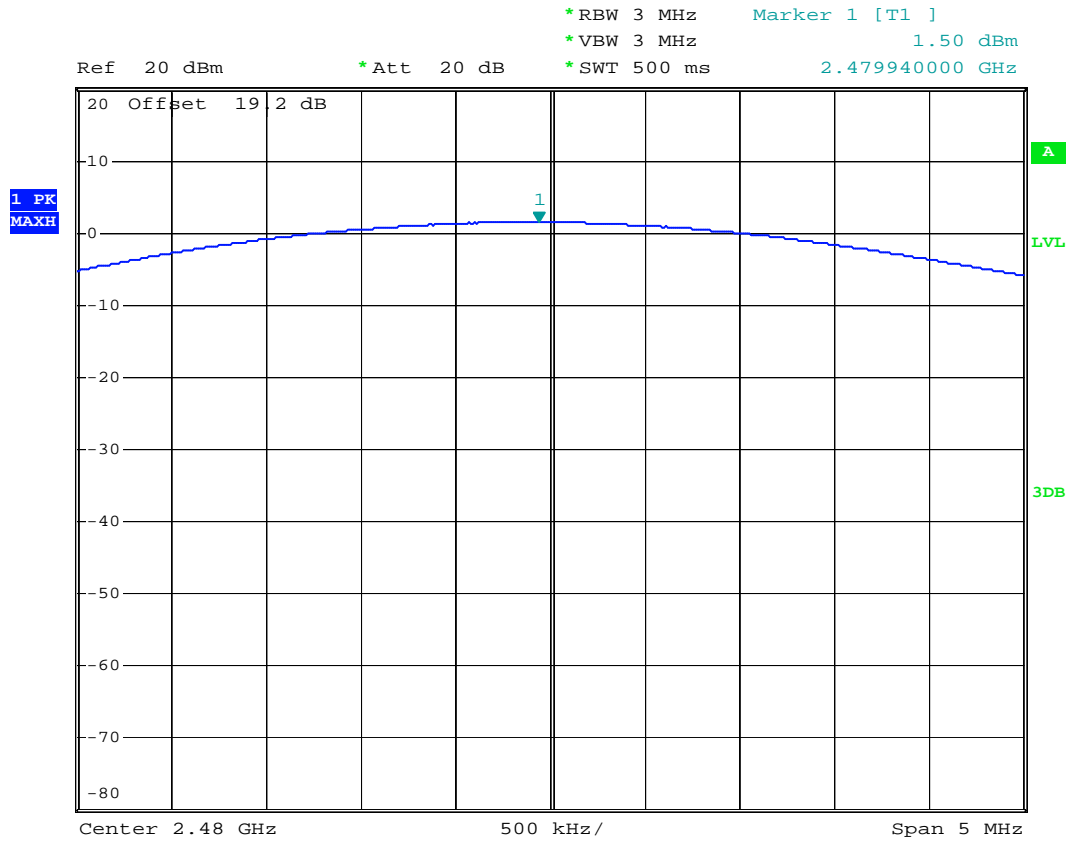

Date: 12.DEC.2007 01:43:56



## **5.8 Conducted Emission**

### 5.8.1 Measuring Instruments

As described in chapter 6 of this test Report.

### 5.8.2 Test Procedures

- a. The EUT was placed 0.4 meter from the conducting wall of the shielding room was kept at least 80 centimeters from any other grounded conducting surface.
- b. Connect EUT to the power port of a line impedance stabilization network (LISN).
- c. All the support units are connected to the other LISN.
- d. The LISN provides 50 ohm coupling impedance for the measuring instrument.
- e. The FCC states that a 50 ohm, 50 microhenry LISN should be used.
- f. Both sides of AC line were checked for maximum conducted interference.
- g. The frequency range from 150 kHz to 30 MHz was searched.
- h. Set the test-receiver system to Peak Detect Function and specified bandwidth with Maximum Hold Mode.



5.8.3 Test Data

- Temperature : 24~27
- Relative Humidity : 49~51%
- Test Enginner : Sun
- Test Mode : Mode 1

The test that passed at minimum margin was marked by the frame in the following table.

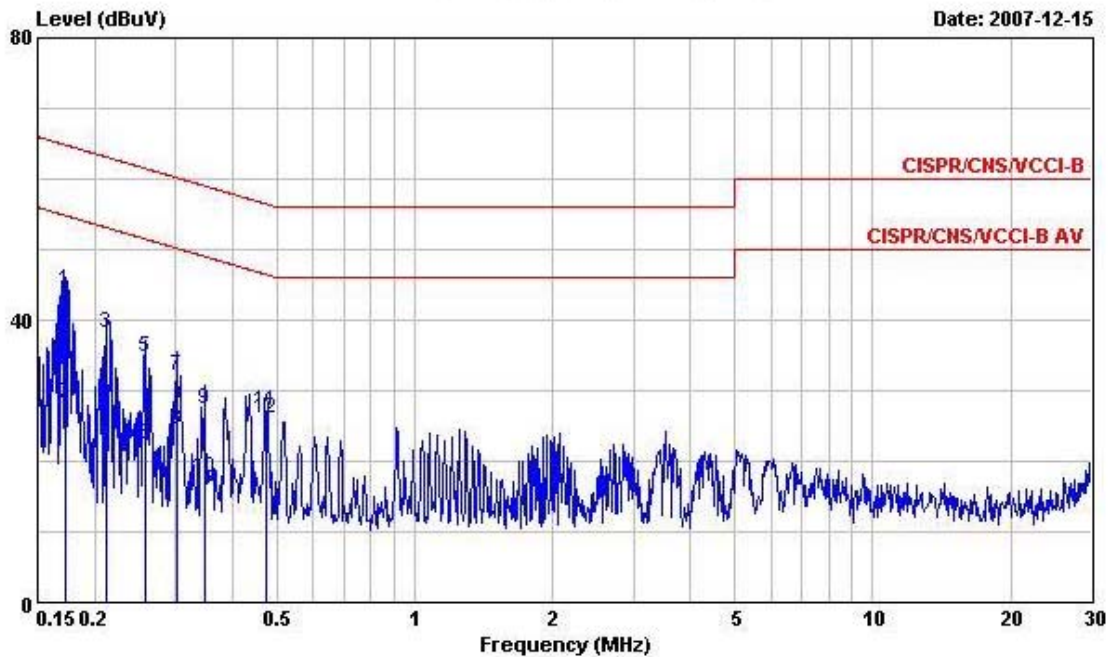

Site : CO04-HY  
 Condition : CISPR/CNS/VCCI-B LISN 200704 99041 LINE  
 EUT : Smart Phone  
 POWER: 120Vac/60Hz  
 Model : FR 701101  
 Memo : PCS1900 Idle + BT Link  
 Memo : + Earphone + Adaptor + MP3 + GPS Rx

	Freq	Level	Over Limit	Limit Line	Read Level	LISN Factor	Cable Loss	Remark
	MHz	dBuV	dB	dBuV	dBuV	dB	dB	
1	0.1721540	44.13	-20.73	64.86	43.89	0.10	0.14	QP
2	0.1721540	28.18	-26.68	54.86	27.94	0.10	0.14	Average
3	0.2127940	38.26	-24.84	63.10	37.97	0.10	0.19	QP
4	0.2127940	23.75	-29.35	53.10	23.46	0.10	0.19	Average
5	0.2588790	34.69	-26.78	61.47	34.23	0.10	0.36	QP
6	0.2588790	22.24	-29.23	51.47	21.78	0.10	0.36	Average
7	0.3018750	32.03	-28.16	60.19	31.44	0.10	0.49	QP
8	0.3018750	24.50	-25.69	50.19	23.91	0.10	0.49	Average
9	0.3464610	27.43	-31.62	59.05	26.72	0.10	0.61	QP
10	0.3464610	17.70	-31.35	49.05	16.99	0.10	0.61	Average
11	0.4736030	27.20	-29.25	56.45	26.42	0.10	0.68	QP
12	0.4736030	26.08	-20.37	46.45	25.30	0.10	0.68	Average



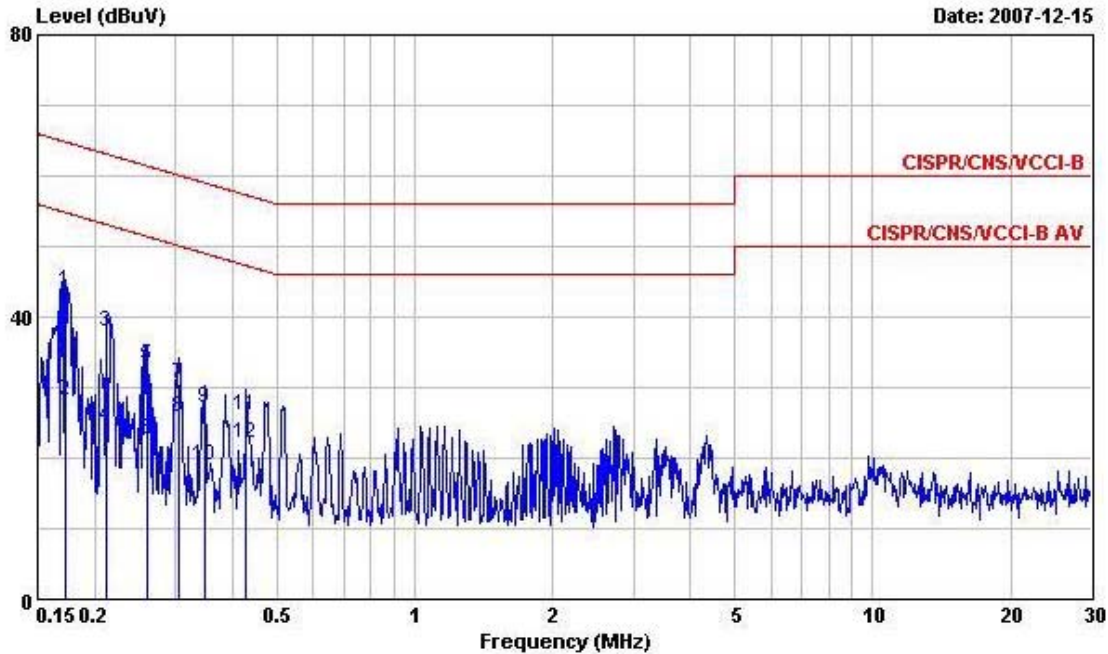

Date: 2007-12-15

Site : CO04-HY  
 Condition : CISPR/CNS/VCCI-B LISN 200704 99041 NEUTRAL  
 EUT : Smart Phone  
 POWER: 120Vac/60Hz  
 Model : FR 701101  
 Memo : PCS1900 Idle + BT Link  
 Memo : + Earphone + Adaptor + MP3 + GPS Rx

	Freq	Level	Over Limit	Limit Line	Read Level	LISN Factor	Cable Loss	Remark
	MHz	dBuV	dB	dBuV	dBuV	dB	dB	
1	0.1721540	43.75	-21.11	64.86	43.51	0.10	0.14	QP
2	0.1721540	28.04	-26.82	54.86	27.80	0.10	0.14	Average
3	0.2127940	37.86	-25.24	63.10	37.57	0.10	0.19	QP
4	0.2127940	24.48	-28.62	53.10	24.19	0.10	0.19	Average
5	0.2602550	33.17	-28.25	61.42	32.70	0.10	0.37	QP
6	0.2602550	22.69	-28.73	51.42	22.22	0.10	0.37	Average
7	0.3050910	30.43	-29.67	60.10	29.83	0.10	0.50	QP
8	0.3050910	25.91	-24.19	50.10	25.31	0.10	0.50	Average
9	0.3464610	27.21	-31.84	59.05	26.50	0.10	0.61	QP
10	0.3464610	18.89	-30.16	49.05	18.18	0.10	0.61	Average
11	0.4282480	26.11	-31.18	57.29	25.30	0.10	0.71	QP
12	0.4282480	22.21	-25.08	47.29	21.40	0.10	0.71	Average



- Temperature : 24~27
- Relative Humidity : 49~51%
- Test Enginner : Sun
- Test Mode : Mode 2

The test that passed at minimum margin was marked by the frame in the following table.

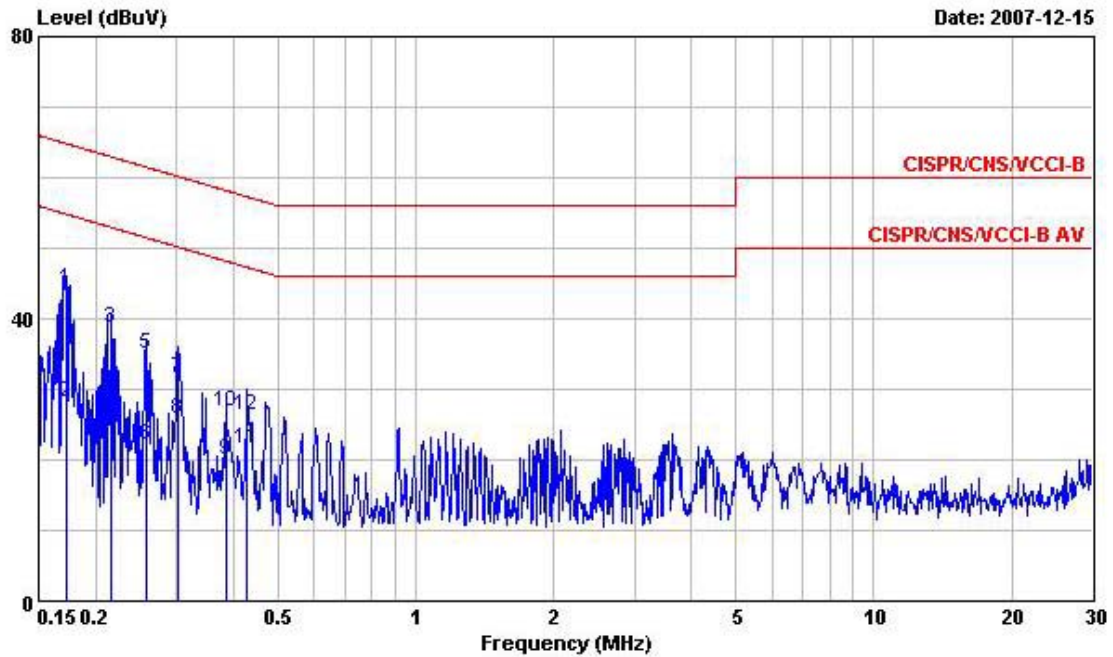

Site : CO04-HY  
 Condition : CISPR/CNS/VCCI-B LISN 200704 99041 LINE  
 EUT : Smart Phone  
 POWER: 120Vac/60Hz  
 Model : FR 701101  
 Memo : WLAN Link + BT Link + Earphone  
 Memo : + Adaptor + MP3 + GPS Rx

	Freq	Level	Over Limit	Limit Line	Read Level	LISN Factor	Cable Loss	Remark
	MHz	dBuV	dB	dBuV	dBuV	dB	dB	
1	0.1721540	44.31	-20.55	64.86	44.07	0.10	0.14	QP
2	0.1721540	28.27	-26.59	54.86	28.03	0.10	0.14	Average
3	0.2162030	38.59	-24.37	62.96	38.28	0.10	0.21	QP
4	0.2162030	24.13	-28.83	52.96	23.82	0.10	0.21	Average
5	0.2588790	34.95	-26.52	61.47	34.49	0.10	0.36	QP
6	0.2588790	22.19	-29.28	51.47	21.73	0.10	0.36	Average
7	0.3034790	31.60	-28.55	60.15	31.00	0.10	0.50	QP
8	0.3034790	25.78	-24.37	50.15	25.18	0.10	0.50	Average
9	0.3851900	19.99	-28.18	48.17	19.19	0.10	0.70	Average
10	0.3851900	26.93	-31.24	58.17	26.13	0.10	0.70	QP
11	0.4282480	21.46	-25.83	47.29	20.65	0.10	0.71	Average
12	0.4282480	26.35	-30.94	57.29	25.54	0.10	0.71	QP

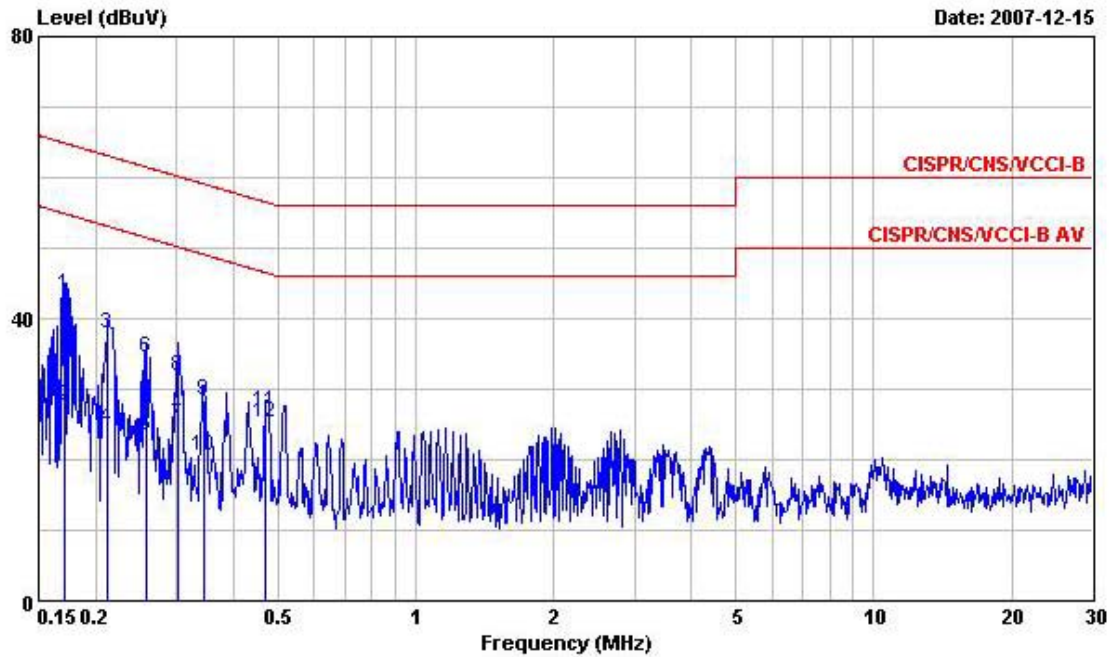

Site : CO04-HY  
 Condition : CISPR/CNS/VCCI-B LISN 200704 99041 NEUTRAL  
 EUT : Smart Phone  
 POWER: 120Vac/60Hz  
 Model : FR 701101  
 Memo : WLAN Link + BT Link + Earphone  
 Memo : + Adaptor + MP3 + GPS Rx

	Freq	Level	Over Limit	Limit Line	Read Level	LISN Factor	Cable Loss	Remark
	MHz	dBuV	dB	dBuV	dBuV	dB	dB	
1	0.1703400	43.43	-21.51	64.94	43.19	0.10	0.14	QP
2	0.1703400	27.61	-27.33	54.94	27.37	0.10	0.14	Average
3	0.2127940	37.86	-25.24	63.10	37.57	0.10	0.19	QP
4	0.2127940	24.55	-28.55	53.10	24.26	0.10	0.19	Average
5	0.2588790	23.52	-27.95	51.47	23.06	0.10	0.36	Average
6	0.2588790	34.53	-26.94	61.47	34.07	0.10	0.36	QP
7	0.3018750	25.06	-25.13	50.19	24.47	0.10	0.49	Average
8	0.3018750	31.73	-28.46	60.19	31.14	0.10	0.49	QP
9	0.3446300	28.34	-30.75	59.09	27.64	0.10	0.60	QP
10	0.3446300	20.51	-28.58	49.09	19.81	0.10	0.60	Average
11	0.4711010	26.84	-29.65	56.49	26.06	0.10	0.68	QP
12	0.4711010	25.18	-21.31	46.49	24.40	0.10	0.68	Average



- Temperature : 24~27
- Relative Humidity : 49~51%
- Test Enginner : Sun
- Test Mode : Mode 3

The test that passed at minimum margin was marked by the frame in the following table.

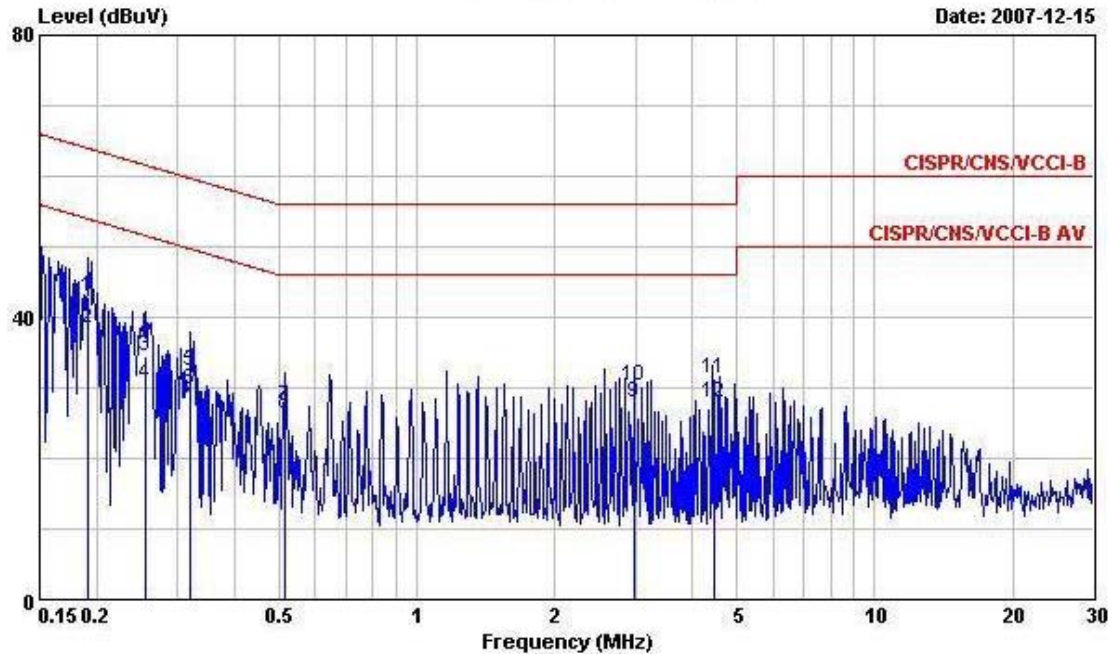

Site : CO04-HY  
 Condition : CISPR/CNS/VCCI-B LISN 200704 99041 LINE  
 EUT : Smart Phone  
 POWER: From System  
 Model : FR 701101  
 Memo : PCS1900 Idle + BT Link + Earphone  
 Memo : + USB Link + MP3 + GPS Rx

	Freq	Level	Over Limit	Limit Line	Read Level	LISN Factor	Cable Loss	Remark
	MHz	dBuV	dB	dBuV	dBuV	dB	dB	
1	0.1913990	42.97	-21.01	63.98	42.73	0.10	0.14	QP
2	0.1913990	38.48	-15.50	53.98	38.24	0.10	0.14	Average
3	0.2547970	34.50	-27.10	61.60	34.05	0.10	0.35	QP
4	0.2547970	30.57	-21.03	51.60	30.12	0.10	0.35	Average
5	0.3199920	32.38	-27.33	59.71	31.74	0.10	0.54	QP
6	0.3199920	29.79	-19.92	49.71	29.15	0.10	0.54	Average
7	0.5155030	27.40	-28.60	56.00	26.65	0.10	0.65	QP
8	0.5155030	26.25	-19.75	46.00	25.50	0.10	0.65	Average
9	2.972	27.86	-18.14	46.00	27.39	0.10	0.37	Average
10	2.972	30.24	-25.76	56.00	29.77	0.10	0.37	QP
11	4.458	31.36	-24.64	56.00	30.94	0.11	0.31	QP
12	4.458	27.85	-18.15	46.00	27.43	0.11	0.31	Average



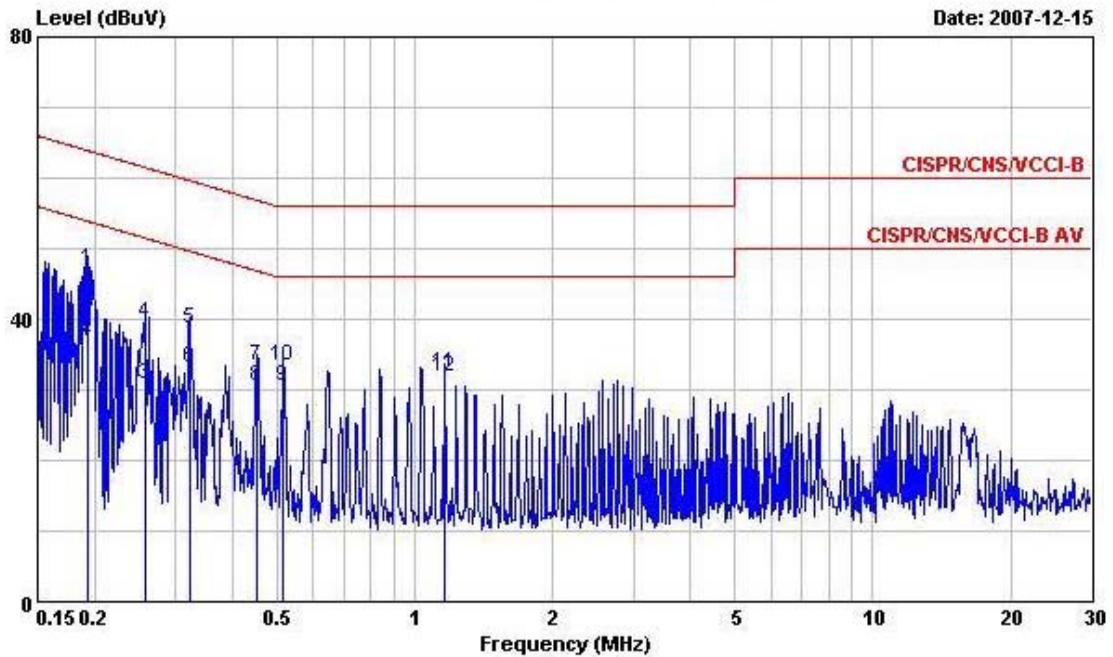

Site : CO04-HY  
 Condition : CISPR/CNS/VCCI-B LISN 200704 99041 NEUTRAL  
 EUT : Smart Phone  
 POWER: From System  
 Model : FR 701101  
 Memo : PCS1900 Idle + BT Link + Earphone  
 Memo : + USB Link + MP3 + GPS Rx

	Freq	Level	Over Limit	Limit Line	Read Level	LISN Factor	Cable Loss	Remark
	MHz	dBuV	dB	dBuV	dBuV	dB	dB	
1	0.1924150	47.21	-16.72	63.93	46.97	0.10	0.14	QP
2	0.1924150	37.49	-16.44	53.93	37.25	0.10	0.14	Average
3	0.2575110	30.71	-20.80	51.51	30.26	0.10	0.35	Average
4	0.2575110	39.54	-21.97	61.51	39.09	0.10	0.35	QP
5	0.3216920	38.59	-21.07	59.66	37.95	0.10	0.54	QP
6	0.3216920	33.04	-16.62	49.66	32.40	0.10	0.54	Average
7	0.4515500	33.33	-23.52	56.85	32.54	0.10	0.69	QP
8	0.4515500	30.63	-16.22	46.85	29.84	0.10	0.69	Average
9	@0.5155030	30.53	-15.47	46.00	29.78	0.10	0.65	Average
10	0.5155030	33.35	-22.65	56.00	32.60	0.10	0.65	QP
11	1.163	32.31	-23.69	56.00	31.77	0.10	0.44	QP
12	@ 1.163	31.91	-14.09	46.00	31.37	0.10	0.44	Average



- Temperature : 24~27
- Relative Humidity : 49~51%
- Test Enginner : Sun
- Test Mode : Mode 4

The test that passed at minimum margin was marked by the frame in the following table.

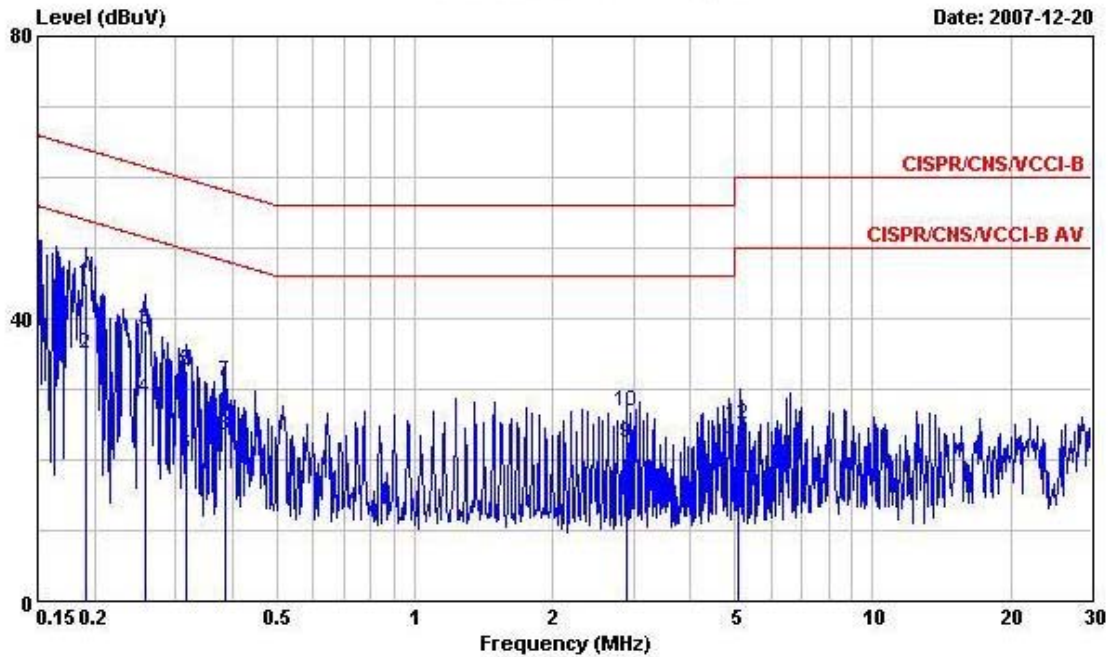

Site : CO04-HY  
 Condition : CISPR/CNS/VCCI-B LISN 200704 99041 LINE  
 EUT : Smart Phone  
 POWER: From System  
 Model : FR 701101  
 Memo : GSM850 Idle + BT Link + Earphone  
 Memo : + USB Link + MP3 + GPS Rx

	Freq	Level	Over Limit	Limit Line	Read Level	LISN Factor	Cable Loss	Remark
	MHz	dBuV	dB	dBuV	dBuV	dB	dB	
1	0.1903870	45.04	-18.98	64.02	44.80	0.10	0.14	QP
2	0.1903870	34.93	-19.09	54.02	34.69	0.10	0.14	Average
3	0.2588790	38.53	-22.94	61.47	38.07	0.10	0.36	QP
4	0.2588790	28.68	-22.79	51.47	28.22	0.10	0.36	Average
5	0.3166190	32.71	-27.09	59.80	32.08	0.10	0.53	QP
6	0.3166190	20.80	-29.00	49.80	20.17	0.10	0.53	Average
7	0.3872360	30.98	-27.14	58.12	30.18	0.10	0.70	QP
8	0.3872360	23.53	-24.59	48.12	22.73	0.10	0.70	Average
9	2.900	22.35	-23.65	46.00	21.88	0.10	0.37	Average
10	2.900	26.80	-29.20	56.00	26.33	0.10	0.37	QP
11	5.089	21.45	-28.55	50.00	21.03	0.13	0.29	Average
12	5.089	25.01	-34.99	60.00	24.59	0.13	0.29	QP

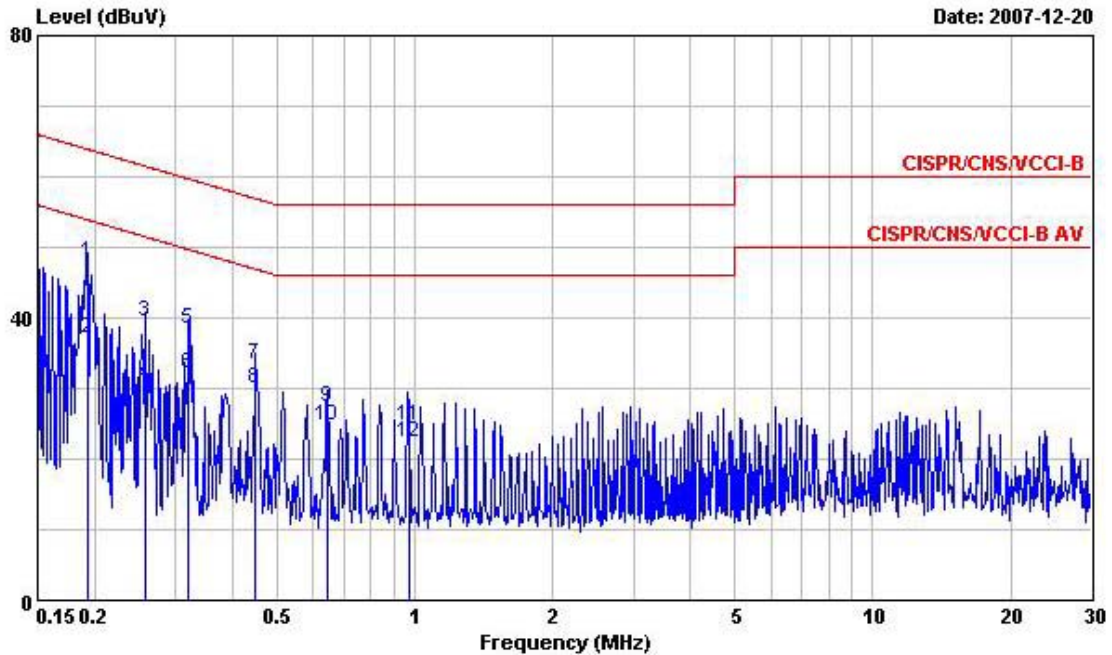

Date: 2007-12-20

Site : CO04-HY  
 Condition : CISPR/CNS/VCCI-B LISN 200704 99041 NEUTRAL  
 EUT : Smart Phone  
 POWER: From System  
 Model : FR 701101  
 Memo : GSM850 Idle + BT Link + Earphone  
 Memo : + USB Link + MP3 + GPS Rx

	Freq	Level	Over Limit	Limit Line	Read Level	LISN Factor	Cable Loss	Remark
	MHz	dBuV	dB	dBuV	dBuV	dB	dB	
1	0.1934380	47.93	-15.96	63.89	47.69	0.10	0.14	QP
2	0.1934380	37.22	-16.67	53.89	36.98	0.10	0.14	Average
3	0.2575110	39.47	-22.04	61.51	39.02	0.10	0.35	QP
4	0.2575110	30.41	-21.10	51.51	29.96	0.10	0.35	Average
5	0.3199920	38.50	-21.21	59.71	37.86	0.10	0.54	QP
6	0.3199920	32.10	-17.61	49.71	31.46	0.10	0.54	Average
7	0.4491640	33.39	-23.50	56.89	32.60	0.10	0.69	QP
8	0.4491640	29.92	-16.97	46.89	29.13	0.10	0.69	Average
9	0.6456540	27.48	-28.52	56.00	26.80	0.10	0.58	QP
10	0.6456540	24.61	-21.39	46.00	23.93	0.10	0.58	Average
11	0.9690310	24.70	-31.30	56.00	24.15	0.10	0.45	QP
12	0.9690310	22.43	-23.57	46.00	21.88	0.10	0.45	Average



## **5.9 Radiated Emission Measurement**

### **5.9.1 Measuring Instruments**

As described in chapter 6 of this Report.

### **5.9.2 Test Procedures**

- a. The EUT was placed on a rotatable table top 0.8 meter above ground.
- b. The EUT was set 3 meters from the interference receiving antenna which was mounted on the top of a variable height antenna tower.
- c. The table was rotated 360 degrees to determine the position of the highest radiation.
- d. The antenna is a broadband antenna and its height is varied between one meter and four meters above ground to find the maximum value of the field strength for both horizontal polarization and vertical polarization of the antenna.
- e. For each suspected emission, the EUT was arranged to its worst case and then tune the antenna tower (from 1 m to 4 m) and turntable (from 0 degree to 360 degrees) to find the maximum reading.
- f. Set the test-receiver system to Peak or CISPR quasi-peak Detect Function and specified bandwidth with Maximum Hold Mode.
- g. For testing below 1GHz, If the emission level of the EUT in peak mode was 3 dB lower than the limit specified, then testing will be stopped and peak values of EUT will be reported, otherwise, the emissions will be repeated one by one using the quasi-peak method and reported.
- h. For testing above 1GHz, the emission level of the EUT in peak mode was 20dB lower than average limit (that means the emission level in average mode also complies with the limit in average mode), then testing will be stopped and peak values of EUT will be reported, otherwise, the emissions will be measured in average mode again and reported.



5.9.3 Typical Test Setup Layout of Radiated Emission

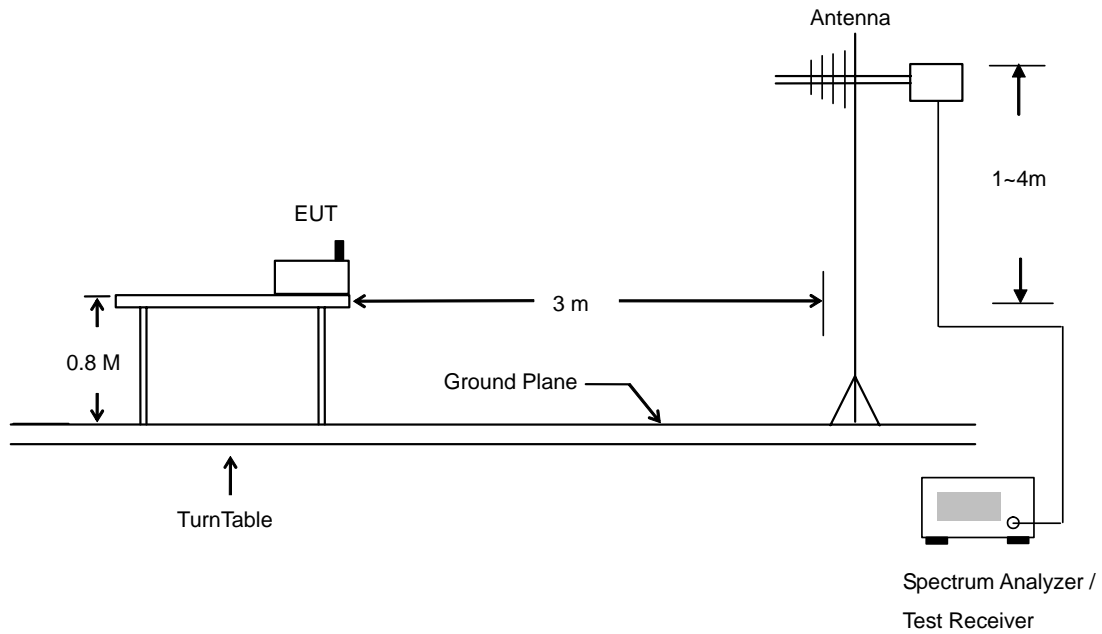



5.9.4 Test Data

- Temperature : 26~27°C
- Relating Humidity : 49~51%
- Test Enginner : Derek
- Test Mode : Mode 1
- Polarization : Horizontal (30MHz-1GHz)

The test that passed at minimum margin was marked by the boldface in the following table.

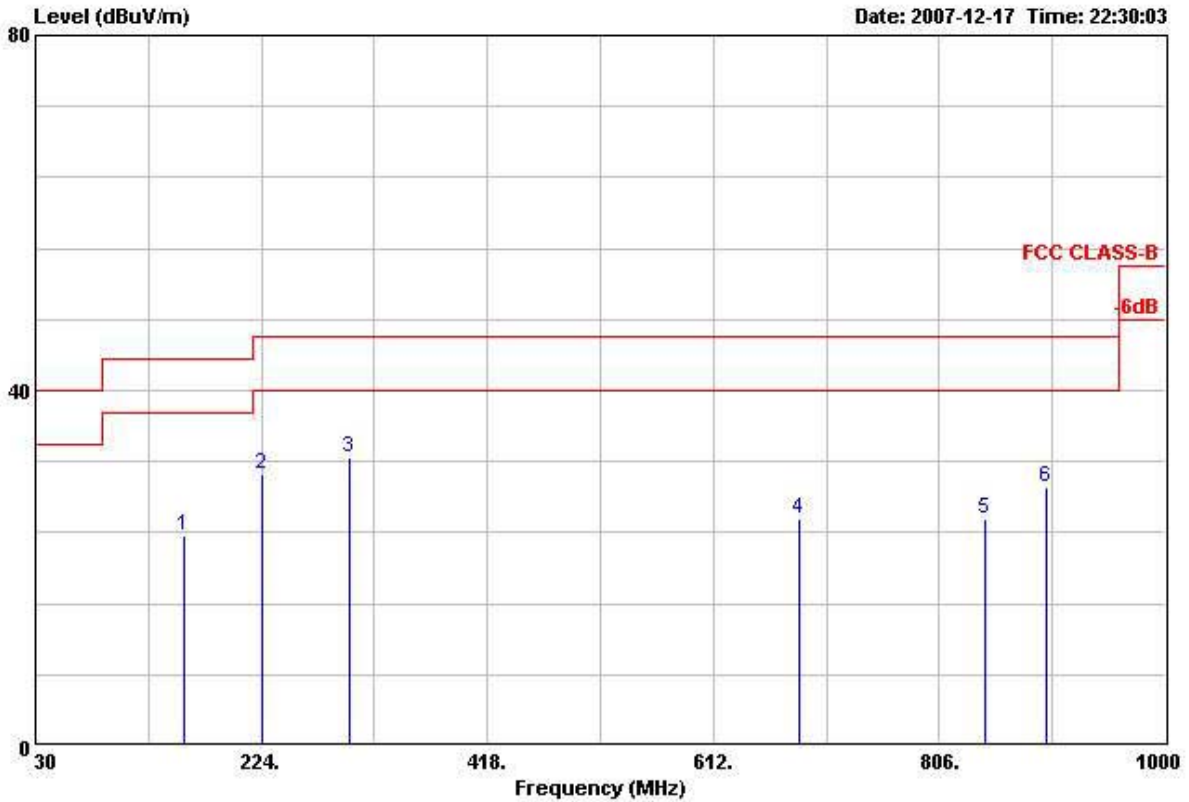

Site : 03CH04-HY  
 Condition: FCC CLASS-B 3m ANT2724 HORIZONTAL  
 EUT : Smart Phone  
 POWER : 120Vac/60Hz  
 MODEL : FR 701101  
 MEMO : Bluetooth Tx\_CH00;2402MHZ  
 PLANE : E2  
 Data Rate: 3DH5

	Freq	Level	Over Limit	Limit Line	ReadAntenna Level	Antenna Factor	Cable Loss	Preamp Factor	Ant Pos	Table Pos	Remark
	MHz	dBUV/m	dB	dBUV/m	dBuV	dB/m	dB	dB	cm	deg	
1	158.250	23.58	-19.92	43.50	40.35	9.51	1.68	27.97	---	---	Peak
2	224.940	30.55	-15.45	46.00	45.69	10.65	1.97	27.75	---	---	Peak
3	299.460	32.56	-13.44	46.00	45.61	12.31	2.24	27.60	100	157	Peak
4	685.700	25.49	-20.51	46.00	31.01	20.11	3.48	29.10	---	---	Peak
5	845.300	25.51	-20.49	46.00	29.00	21.52	3.84	28.85	---	---	Peak
6	897.800	29.15	-16.85	46.00	30.56	23.44	3.95	28.80	---	---	Peak



- Polarization : Horizontal (1GHz-25GHz)

The test that passed at minimum margin was marked by the boldface in the following table.

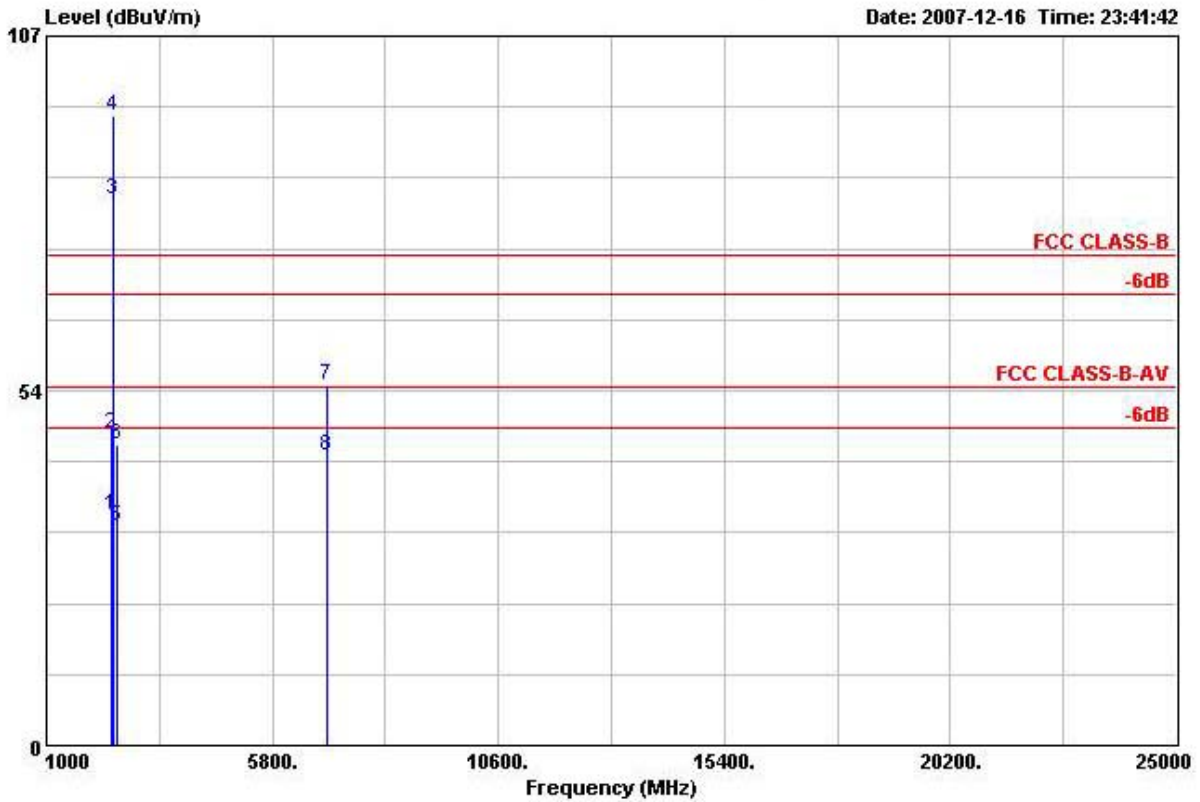

Site : 03CH04-HY  
 Condition: FCC CLASS-B 3m HF-ANT-3117 HORIZONTAL  
 EUT : Smart Phone  
 POWER : 120Vac/60Hz  
 MODEL : FR 701101  
 MEMO : Bluetooth Tx\_CH00;2402MHz  
 PLANE : E2  
 Data Rate: 3DH5

	Freq	Level	Over Limit	Limit Line	ReadAntenna Level	Antenna Factor	Cable Loss	Preamp Factor	Ant Pos	Table Pos	Remark
	MHz	dBUV/m	dB	dBUV/m	dBuV	dB/m	dB	dB	cm	deg	
1	2389.420	34.66	-19.34	54.00	32.16	32.54	3.74	33.78	160	101	Average
2	2389.420	46.99	-27.01	74.00	44.49	32.54	3.74	33.78	100	0	Peak
3 X	2402.000	82.26			79.76	32.54	3.74	33.78	160	101	Average
4 X	2402.000	95.07			92.57	32.54	3.74	33.78	100	0	Peak
5	2486.000	33.12	-20.88	54.00	30.49	32.59	3.84	33.80	160	101	Average
6	2486.000	45.26	-28.74	74.00	42.63	32.59	3.84	33.80	100	0	Peak
7	6942.000	54.41	-19.59	74.00	44.61	36.00	6.34	32.54	100	0	Peak
8	6942.000	43.60	-10.40	54.00	33.80	36.00	6.34	32.54	100	188	Average

Remark: #3 and #4 are Fundamental Signals



• Polarization : Vertical (30MHz-1GHz)

The test that passed at minimum margin was marked by the boldface in the following table.

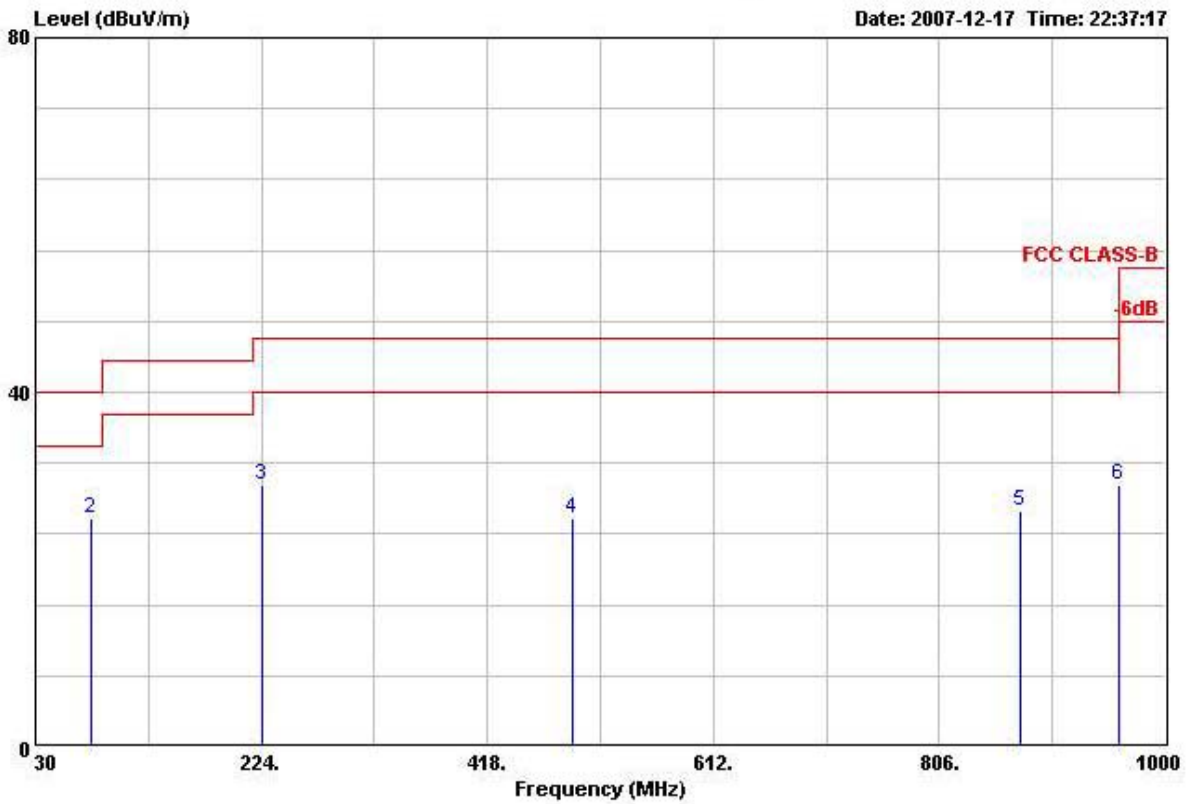

Site : 03CH04-HY  
 Condition: FCC CLASS-B 3m ANT2724 VERTICAL  
 EUT : Smart Phone  
 POWER : 120Vac/60Hz  
 MODEL : FR 701101  
 MEMO : Bluetooth Tx\_CH00;2402MHz  
 PLANE : E2  
 Data Rate: 3DH5

	Freq	Level	Over	Limit	ReadAntenna	Cable	Preamp	Ant	Table		
	MHz	dBuV/m	dB	dBuV/m	Level	Loss	Factor	Pos	Pos	Remark	
					dBuV	Factor	dB	cm	deg		
1	30.000	22.92	-17.08	40.00	33.92	16.38	0.87	28.25	---	---	Peak
2	77.250	25.78	-14.22	40.00	46.11	6.67	1.25	28.25	100	241	Peak
3	225.210	29.54	-16.46	46.00	44.68	10.65	1.97	27.75	---	---	Peak
4	491.800	25.79	-20.21	46.00	35.13	16.81	2.79	28.94	---	---	Peak
5	875.400	26.65	-19.35	46.00	28.94	22.62	3.92	28.82	---	---	Peak
6	959.400	29.61	-16.39	46.00	29.29	25.01	3.99	28.68	---	---	Peak



• Polarization : Vertical (1GHz-25GHz)

The test that passed at minimum margin was marked by the boldface in the following table.

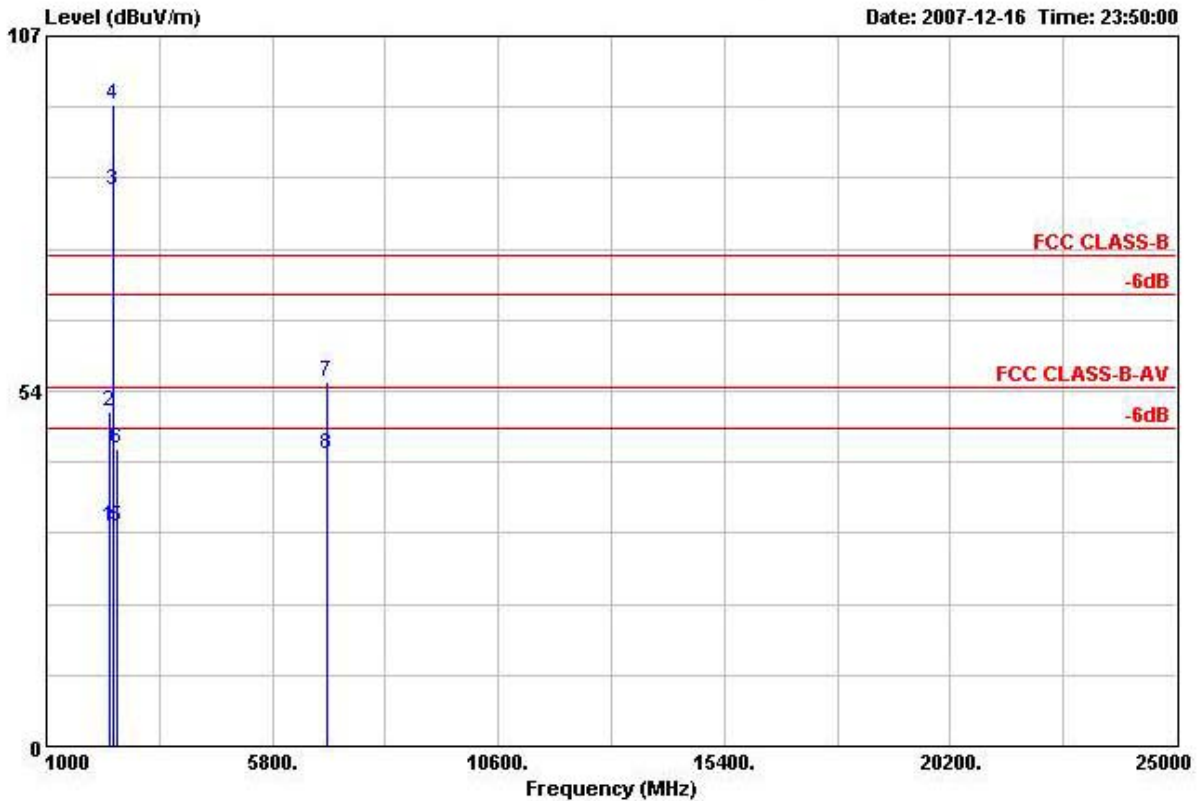

Site : 03CH04-HY  
 Condition: FCC CLASS-B 3m HF-ANT-3117 VERTICAL  
 EUT : Smart Phone  
 POWER : 120Vac/60Hz  
 MODEL : FR 701101  
 MEMO : Bluetooth Tx\_CH00;2402MHz  
 PLANE : E2  
 Data Rate: 3DH5

	Freq	Level	Over	Limit	ReadAntenna	Cable	Preamp	Ant	Table	
	MHz	dBuV/m	dB	dBuV/m	dBuV	dB/m	dB	cm	deg	Remark
1	2349.140	33.08	-20.92	54.00	30.65	32.51	3.69	33.77	101	68 Average
2	2349.140	50.33	-23.67	74.00	47.90	32.51	3.69	33.77	100	0 Peak
3 @	2402.000	83.87			81.37	32.54	3.74	33.78	101	68 Average
4 X	2402.000	96.69			94.19	32.54	3.74	33.78	100	0 Peak
5	2492.000	33.10	-20.90	54.00	30.46	32.60	3.84	33.80	101	68 Average
6	2492.000	44.76	-29.24	74.00	42.12	32.60	3.84	33.80	100	0 Peak
7	6957.000	54.81	-19.19	74.00	44.99	36.00	6.34	32.52	100	0 Peak
8	6957.000	43.86	-10.14	54.00	34.04	36.00	6.34	32.52	100	181 Average

Remark: #3 and #4 are Fundamental Signals



- Test Mode : Mode 2
- Polarization : Horizontal (30MHz-1GHz)

The test that passed at minimum margin was marked by the boldface in the following table.

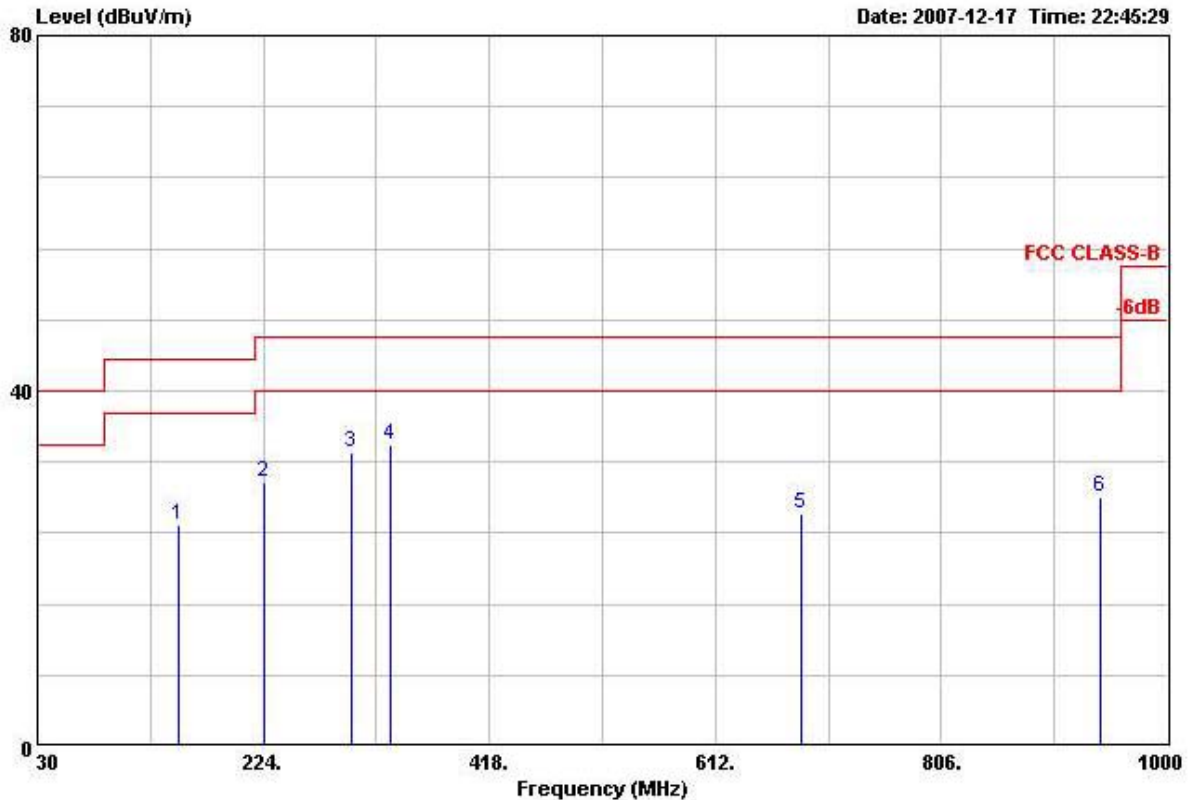

Site : 03CH04-HY  
 Condition: FCC CLASS-B 3m ANT2724 HORIZONTAL  
 EUT : Smart Phone  
 POWER : 120Vac/60Hz  
 MODEL : FR 701101  
 MEMO : Bluetooth Tx\_CH39;2441MHz  
 PLANE : E2  
 Data Rate: 3DH5

	Freq	Level	Over Limit	Limit Line	ReadAntenna Level	Antenna Factor	Cable Loss	Preamp Factor	Ant Pos	Table Pos	Remark
	MHz	dBUV/m	dB	dBUV/m	dBuV	dB/m	dB	dB	cm	deg	
1	151.500	24.88	-18.62	43.50	40.60	10.61	1.66	27.99	---	---	Peak
2	224.940	29.73	-16.27	46.00	44.87	10.65	1.97	27.75	---	---	Peak
3	299.460	33.05	-12.95	46.00	46.10	12.31	2.24	27.60	---	---	Peak
<b>4 @</b>	<b>332.900</b>	<b>33.88</b>	<b>-12.12</b>	<b>46.00</b>	<b>45.92</b>	<b>13.45</b>	<b>2.35</b>	<b>27.83</b>	<b>100</b>	<b>159</b>	<b>Peak</b>
5	685.700	26.25	-19.75	46.00	31.77	20.11	3.48	29.10	---	---	Peak
6	943.300	28.07	-17.93	46.00	28.18	24.62	3.98	28.71	---	---	Peak





- Polarization : Horizontal (1GHz-25GHz)

The test that passed at minimum margin was marked by the boldface in the following table.

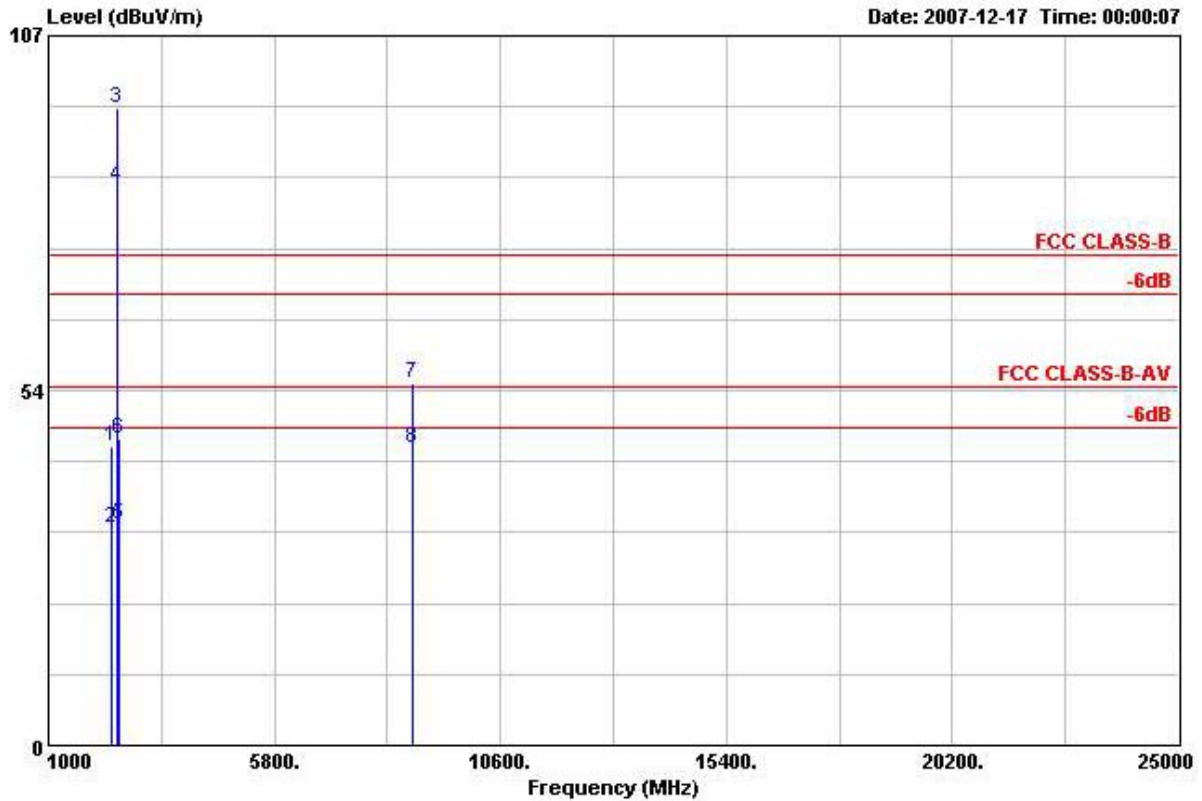

Site : 03CH04-HY  
 Condition: FCC CLASS-B 3m HF-ANT-3117 HORIZONTAL  
 EUT : Smart Phone  
 POWER : 120Vac/60Hz  
 MODEL : FR 701101  
 MEMO : Bluetooth Tx\_CH39;2441MHz  
 PLANE : E2  
 Data Rate: 3DH5

	Freq	Level	Over Limit	Limit Line	ReadAntenna Level	Antenna Factor	Cable Loss	Preamp Factor	Ant Pos	Table Pos	Remark
	MHz	dBuV/m	dB	dBuV/m	dBuV	dB/m	dB	dB	cm	deg	
1	2324.000	45.21	-28.79	74.00	42.82	32.50	3.66	33.77	100	0	Peak
2	2324.000	32.80	-21.20	54.00	30.41	32.50	3.66	33.77	156	98	Average
3 @	2441.000	96.07			93.50	32.57	3.79	33.79	100	0	Peak
4 @	2441.000	84.27			81.70	32.57	3.79	33.79	156	98	Average
5	2486.000	33.35	-20.65	54.00	30.72	32.59	3.84	33.80	156	98	Average
6	2486.000	46.12	-27.88	74.00	43.49	32.59	3.84	33.80	100	0	Peak
7	8721.000	54.76	-19.24	74.00	45.73	36.47	7.13	34.58	100	0	Peak
8 @	8721.000	44.70	-9.30	54.00	35.67	36.47	7.13	34.58	100	147	Average

Remark: #3 and #4 are Fundamental Signals



• Polarization : Vertical (30MHz-1GHz)

The test that passed at minimum margin was marked by the boldface in the following table.

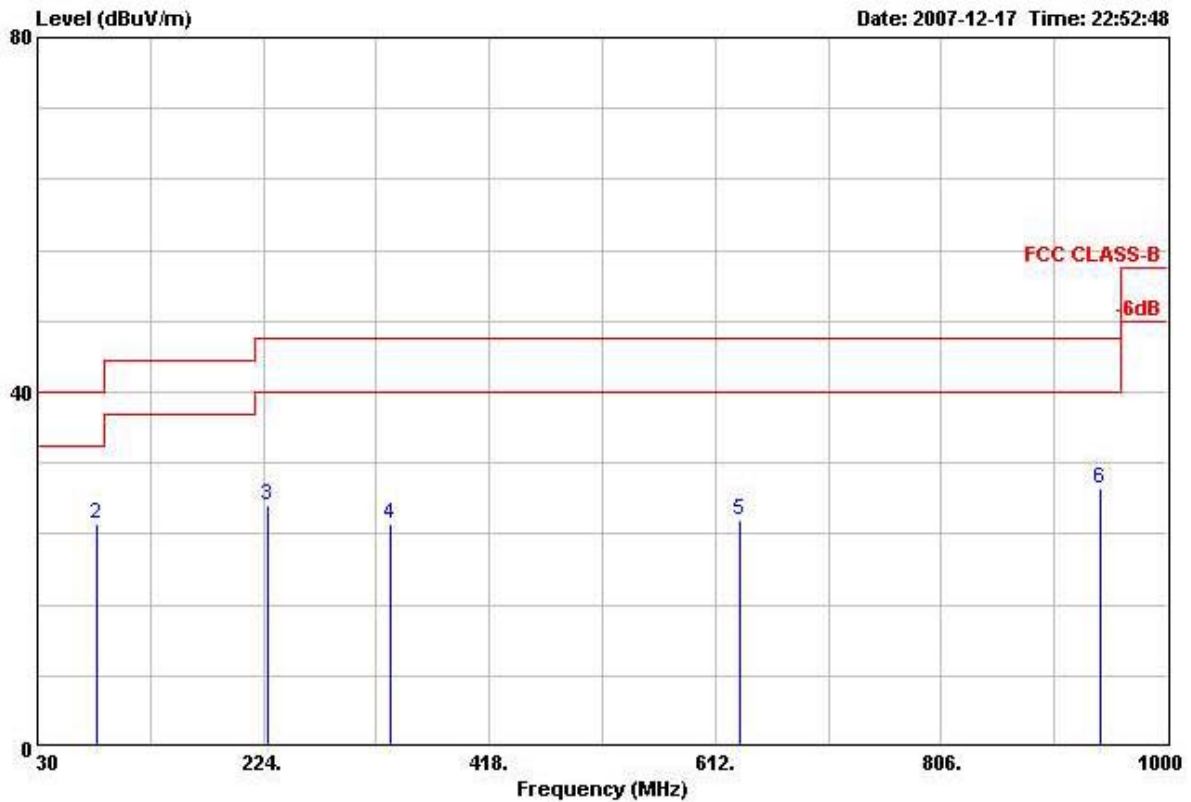

Site : 03CH04-HY  
 Condition: FCC CLASS-B 3m ANT2724 VERTICAL  
 EUT : Smart Phone  
 POWER : 120Vac/60Hz  
 MODEL : FR 701101  
 MEMO : Bluetooth Tx\_CH39;2441MHz  
 PLANE : E2  
 Data Rate: 3DH5

	Freq	Level	Over	Limit	ReadAntenna	Cable	Preamp	Ant	Table		
	MHz	dBuV/m	dB	dBuV/m	dBuV	dB/m	dB	dB	cm	deg	
1	30.000	23.35	-16.65	40.00	34.35	16.38	0.87	28.25	---	---	Peak
2	81.300	25.23	-14.77	40.00	45.09	7.10	1.28	28.24	100	315	Peak
3	228.450	27.20	-18.80	46.00	42.03	10.94	1.98	27.74	---	---	Peak
4	332.900	25.23	-20.77	46.00	37.27	13.45	2.35	27.83	---	---	Peak
5	632.500	25.65	-20.35	46.00	31.46	19.98	3.32	29.10	---	---	Peak
6	942.600	29.20	-16.80	46.00	29.34	24.60	3.98	28.71	---	---	Peak





- Polarization : Vertical (1GHz-25GHz)

The test that passed at minimum margin was marked by the boldface in the following table.

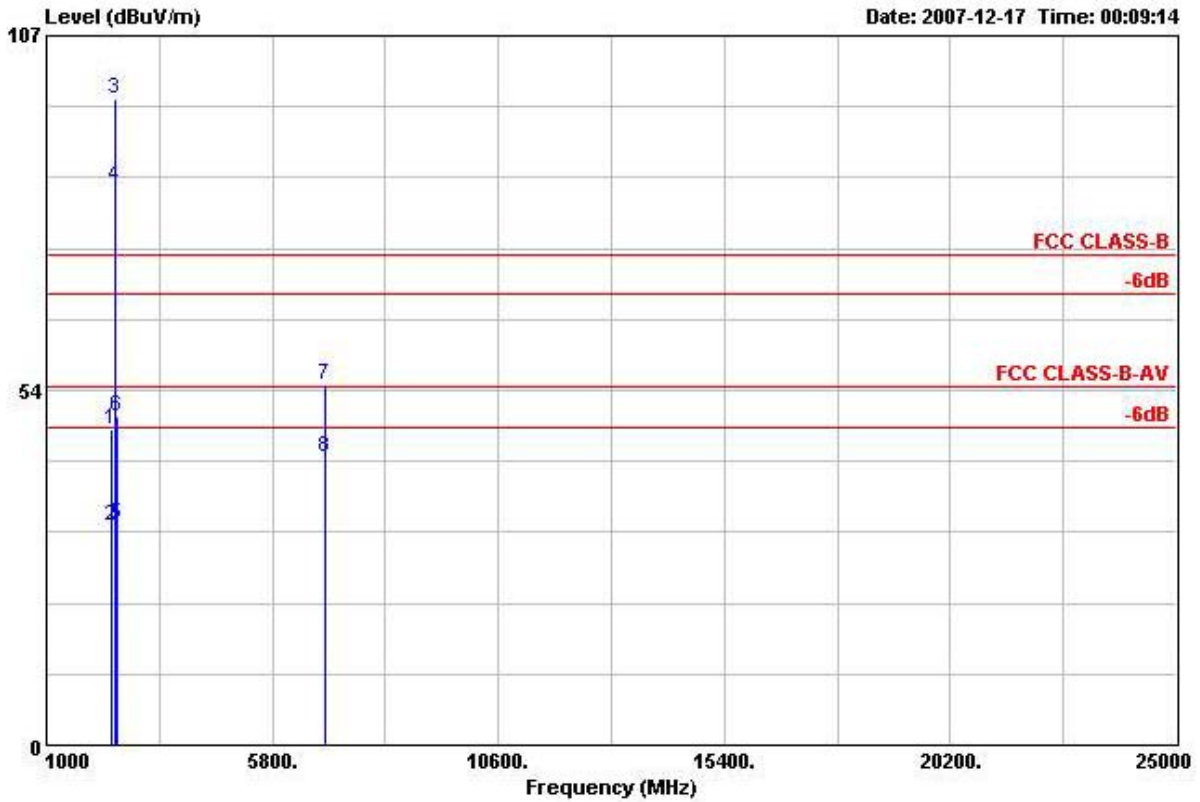

Site : 03CH04-HY  
 Condition: FCC CLASS-B 3m HF-ANT-3117 VERTICAL  
 EUT : Smart Phone  
 POWER : 120Vac/60Hz  
 MODEL : FR 701101  
 MEMO : Bluetooth Tx\_CH39;2441MHz  
 PLANE : E2  
 Data Rate: 3DH5

	Freq	Level	Over	Limit	ReadAntenna	Cable	Preamp	Ant	Table	
	MHz	dBuV/m	dB	dBuV/m	Level	Factor	Loss	Factor	Pos	Pos
					dBuV	dB/m	dB	dB	cm	deg
1	2388.000	47.54	-26.46	74.00	45.04	32.54	3.74	33.78	100	0 Peak
2	2388.000	32.96	-21.04	54.00	30.46	32.54	3.74	33.78	100	308 Average
3 @	2441.000	97.40			94.83	32.57	3.79	33.79	100	0 Peak
4 @	2441.000	84.36			81.79	32.57	3.79	33.79	100	308 Average
5	2494.000	33.30	-20.70	54.00	30.66	32.60	3.84	33.80	100	308 Average
6	2494.000	49.62	-24.38	74.00	46.98	32.60	3.84	33.80	100	0 Peak
7	6906.000	54.22	-19.78	74.00	44.45	36.00	6.33	32.56	100	0 Peak
8 @	6906.000	43.45	-10.55	54.00	33.68	36.00	6.33	32.56	100	168 Average

Remark: #3 and #4 are Fundamental Signals



- Test Mode : Mode 3
- Polarization : Horizontal (30MHz-1GHz)

The test that passed at minimum margin was marked by the boldface in the following table.

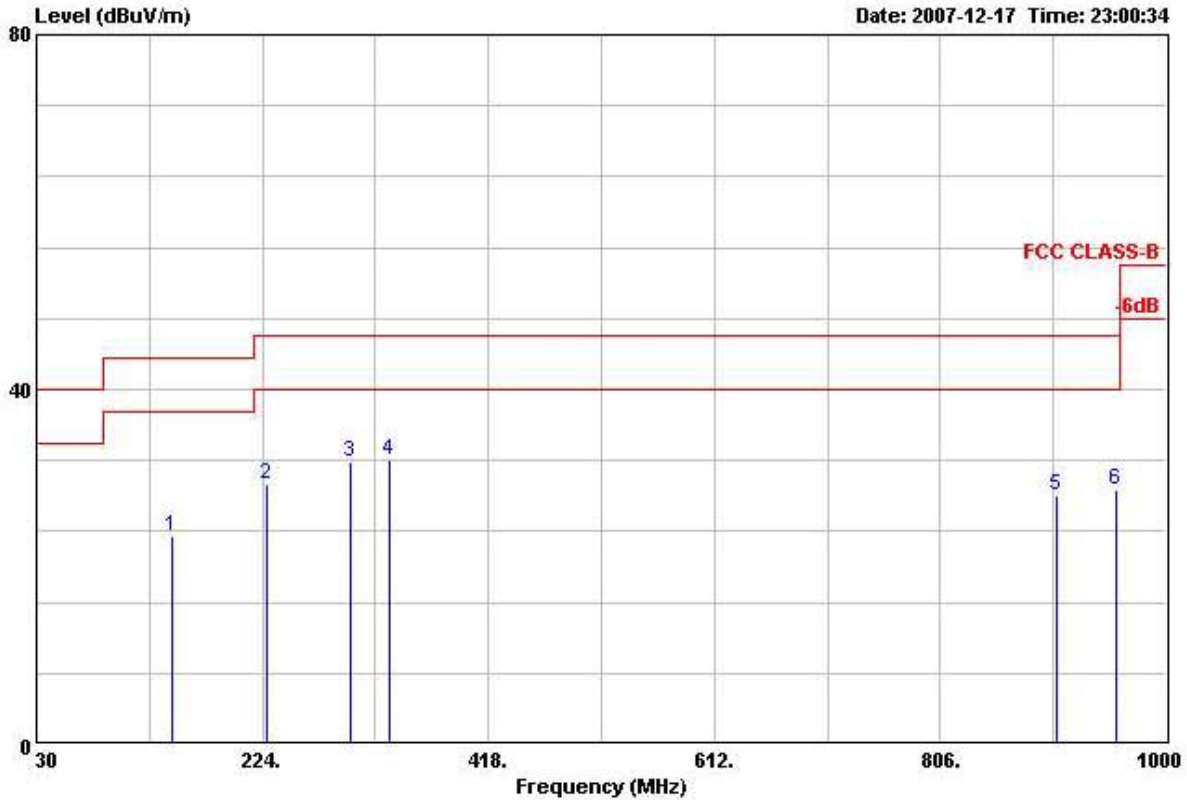

Site : 03CH04-HY  
 Condition: FCC CLASS-B 3m ANT2724 HORIZONTAL  
 EUT : Smart Phone  
 POWER : 120Vac/60Hz  
 MODEL : FR 701101  
 MEMO : Bluetooth Tx\_CH78;2480MHZ  
 PLANE : E2  
 Data Rate: 3DH5

	Freq	Level	Over Limit	Limit Line	ReadAntenna Level	Antenna Factor	Cable Loss	Preamp Factor	Ant Pos	Table Pos	Remark
	MHz	dBUV/m	dB	dBUV/m	dBuV	dB/m	dB	dB	cm	deg	
1	147.180	23.37	-20.13	43.50	39.01	10.72	1.65	28.01	---	---	Peak
2	228.450	29.30	-16.70	46.00	44.13	10.94	1.98	27.74	---	---	Peak
3	299.460	31.88	-14.12	46.00	44.93	12.31	2.24	27.60	---	---	Peak
4	332.900	31.98	-14.02	46.00	44.02	13.45	2.35	27.83	100	198	Peak
5	906.200	27.98	-18.02	46.00	29.15	23.66	3.96	28.79	---	---	Peak
6	957.300	28.70	-17.30	46.00	28.44	24.96	3.98	28.69	---	---	Peak



- Polarization : Horizontal (1GHz-25GHz)

The test that passed at minimum margin was marked by the boldface in the following table.

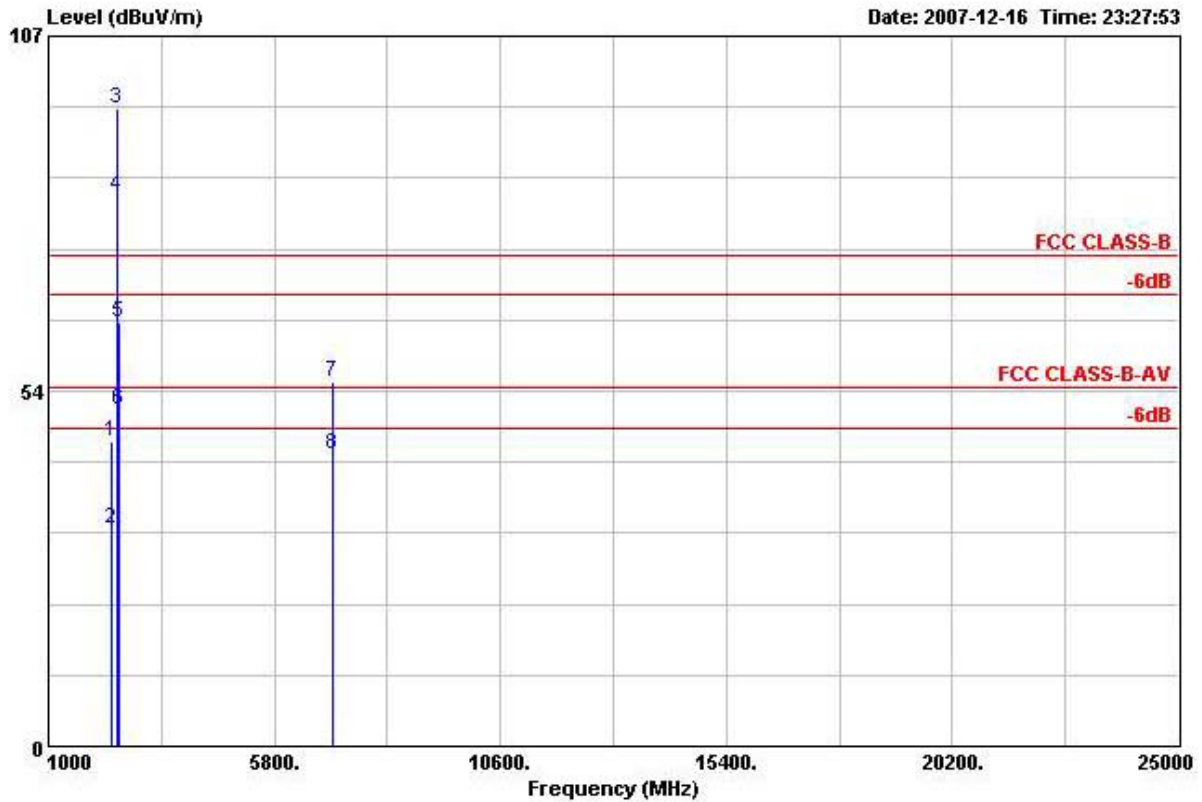

Site : 03CH04-HY  
 Condition: FCC CLASS-B 3m HF-ANT-3117 HORIZONTAL  
 EUT : Smart Phone  
 POWER : 120Vac/60Hz  
 MODEL : FR 701101  
 MEMO : Bluetooth Tx\_CH78;2480MHz  
 PLANE : E2  
 Data Rate: 3DH5

	Freq	Level	Over Limit	Limit Line	ReadAntenna Level	Antenna Factor	Cable Loss	Preamp Factor	Ant Pos	Table Pos	Remark
	MHz	dBUV/m	dB	dBUV/m	dBuV	dB/m	dB	dB	cm	deg	
1	2340.000	46.00	-28.00	74.00	43.57	32.51	3.69	33.77	100	0	Peak
2	2340.000	32.71	-21.29	54.00	30.28	32.51	3.69	33.77	102	94	Average
3 X	2480.000	96.13			93.50	32.59	3.84	33.80	100	0	Peak
4 X	2480.000	82.79			80.16	32.59	3.84	33.80	102	94	Average
5	2483.500	63.73	-10.27	74.00	61.10	32.59	3.84	33.80	100	0	Peak
6 !	2483.500	50.60	-3.40	54.00	47.97	32.59	3.84	33.80	102	94	Average
7	7050.000	54.81	-19.19	74.00	45.06	36.00	6.38	32.63	100	0	Peak
8	7050.000	44.06	-9.94	54.00	34.31	36.00	6.38	32.63	100	102	Average

Remark: #3 and #4 are Fundamental Signals



- Polarization : Vertical (30MHz-1GHz)

The test that passed at minimum margin was marked by the boldface in the following table.

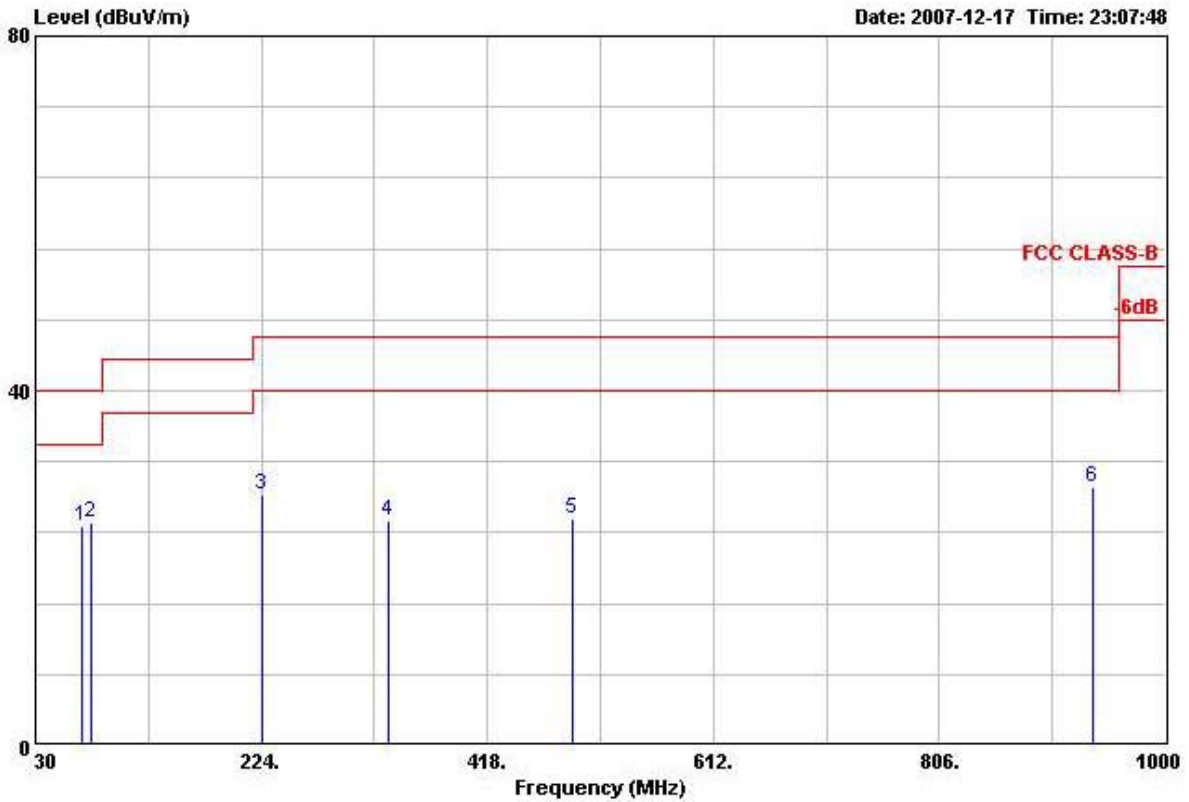

Site : 03CH04-HY  
 Condition: FCC CLASS-B 3m ANT2724 VERTICAL  
 EUT : Smart Phone  
 POWER : 120Vac/60Hz  
 MODEL : FR 701101  
 MEMO : Bluetooth Tx\_CH78;2480MHz  
 PLANE : E2  
 Data Rate: 3DH5

	Freq	Level	Over Limit	Limit	ReadAntenna	Cable	Preamp	Ant	Table		
	MHz	dBuV/m	dB	dBuV/m	dBuV	dB	dB	cm	deg	Remark	
1	69.690	24.70	-15.30	40.00	46.15	5.62	1.19	28.26	---	---	Peak
2	77.250	25.15	-14.85	40.00	45.48	6.67	1.25	28.25	100	169	Peak
3	225.210	28.22	-17.78	46.00	43.36	10.65	1.97	27.75	---	---	Peak
4	332.900	25.43	-20.57	46.00	37.47	13.45	2.35	27.83	---	---	Peak
5	491.800	25.57	-20.43	46.00	34.91	16.81	2.79	28.94	---	---	Peak
6	937.000	29.07	-16.93	46.00	29.37	24.45	3.98	28.73	---	---	Peak



- Polarization : Vertical (1GHz-25GHz)

The test that passed at minimum margin was marked by the boldface in the following table.

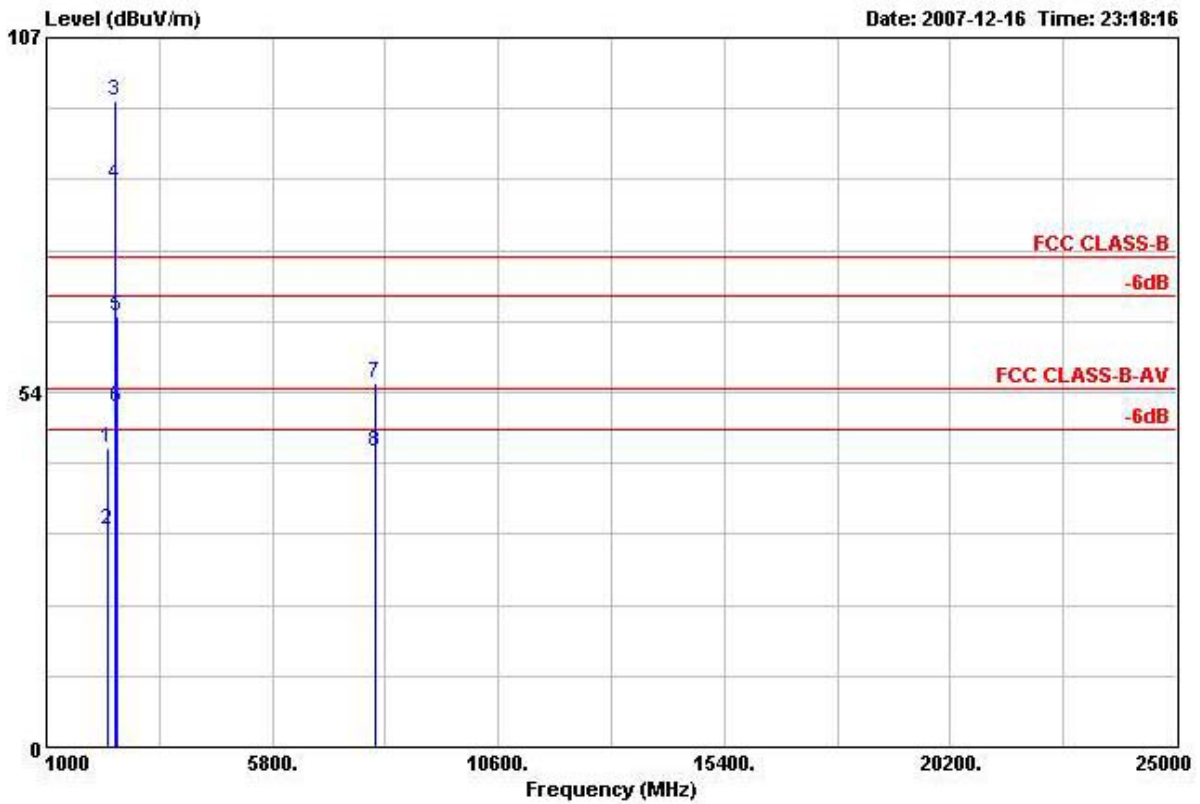

Site : 03CH04-HY  
 Condition: FCC CLASS-B 3m HF-ANT-3117 VERTICAL  
 EUT : Smart Phone  
 POWER : 120Vac/60Hz  
 MODEL : FR 701101  
 MEMO : Bluetooth Tx\_CH78;2480MHz  
 PLANE : E2  
 Data Rate: 3DH5

	Freq	Level	Over Limit	Limit Line	ReadAntenna Level	Antenna Factor	Cable Loss	Preamp Factor	Ant Pos	Table Pos	Remark
	MHz	dBuV/m	dB	dBuV/m	dBuV	dB/m	dB	dB	cm	deg	
1	2318.000	45.00	-29.00	74.00	42.61	32.50	3.66	33.77	100	0	Peak
2	2318.000	32.80	-21.20	54.00	30.41	32.50	3.66	33.77	150	99	Average
3 X	2480.000	97.55			94.92	32.59	3.84	33.80	100	0	Peak
4 @	2480.000	84.75			82.12	32.59	3.84	33.80	150	99	Average
5	2483.500	65.00	-9.00	74.00	62.37	32.59	3.84	33.80	100	0	Peak
<b>6 !</b>	<b>2483.500</b>	<b>51.31</b>	<b>-2.69</b>	<b>54.00</b>	<b>48.68</b>	<b>32.59</b>	<b>3.84</b>	<b>33.80</b>	<b>150</b>	<b>99</b>	<b>Average</b>
7	7998.000	54.80	-19.20	74.00	45.45	36.20	6.76	33.61	100	0	Peak
8	7998.000	44.45	-9.55	54.00	35.10	36.20	6.76	33.61	100	146	Average

Remark: #3 and #4 are Fundamental Signals





- Test Mode : Mode 4
- Polarization : Horizontal (30MHz-1GHz)

The test that passed at minimum margin was marked by the boldface in the following table.

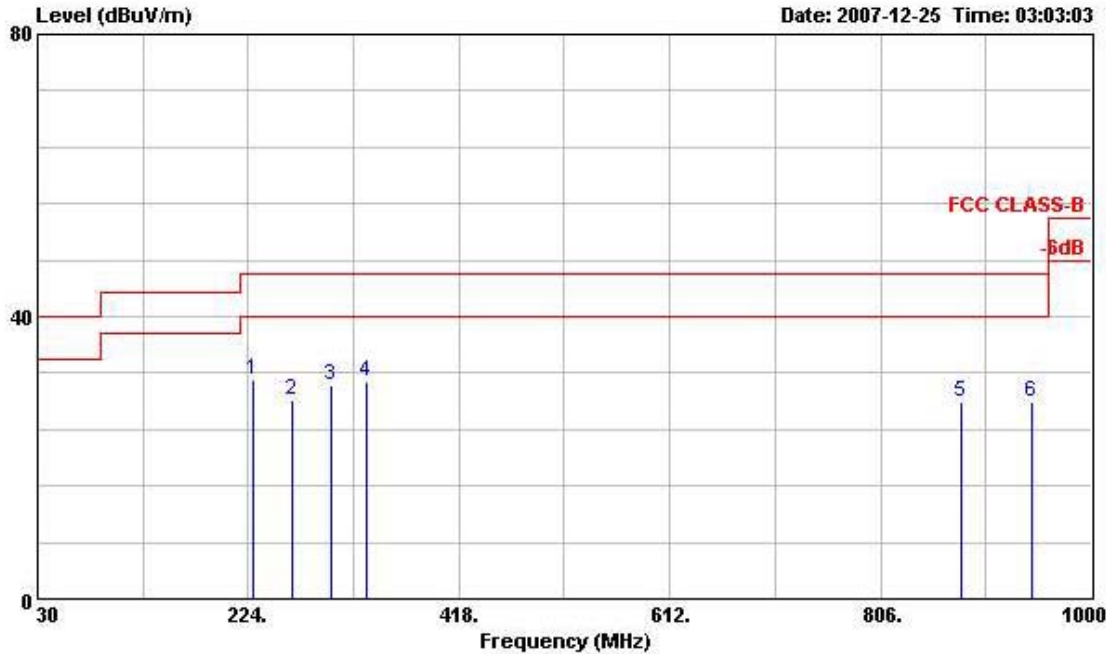

Site : 03CH04-HY  
 Condition: FCC CLASS-B 3m ANT2724 HORIZONTAL  
 EUT : Smart Phone  
 POWER : 120Vac/60Hz  
 MODEL : FR 701101  
 MEMO : Bluetooth Tx\_CH78:2480MHz +  
 : 11b Tx\_Ch01:2412MHz  
 Data Rate: BT:3DH5 WLAN:11  
 PLANE : E2

	Freq	Level	Over Limit	Limit Line	ReadAntenna Level	Antenna Factor	Cable Loss	Preamp Factor	Ant Pos	Table Pos	Remark
	MHz	dBUV/m	dB	dBUV/m	dBuV	dB/m	dB	dB	cm	deg	
1	228.450	31.09	-14.91	46.00	45.92	10.94	1.98	27.74	100	125	Peak
2	264.090	28.26	-17.74	46.00	41.33	12.50	2.10	27.67	---	---	Peak
3	299.460	30.36	-15.64	46.00	43.41	12.31	2.24	27.60	---	---	Peak
4	332.900	30.84	-15.16	46.00	42.88	13.45	2.35	27.83	---	---	Peak
5	881.000	27.78	-18.22	46.00	29.87	22.80	3.92	28.82	---	---	Peak
6	945.400	27.87	-18.13	46.00	27.93	24.67	3.98	28.71	---	---	Peak



- Polarization : Horizontal (1GHz-25GHz)

The test that passed at minimum margin was marked by the boldface in the following table.

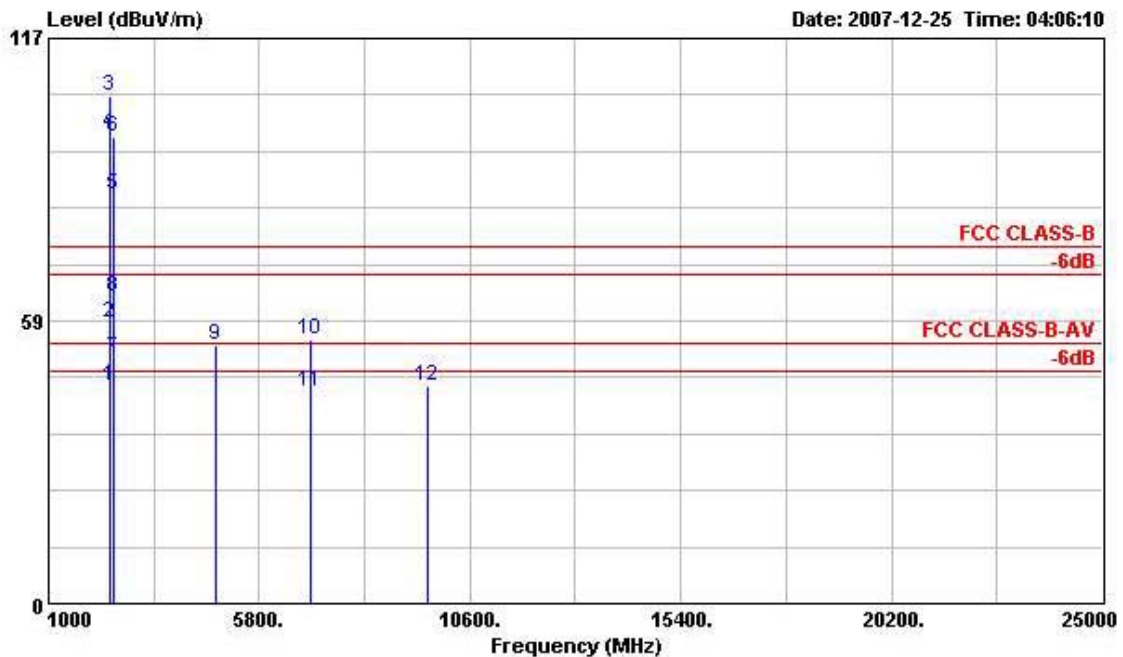

Site : 03CH04-HY  
 Condition: FCC CLASS-B 3m HF-ANT-3117 HORIZONTAL  
 EUT : Smart Phone  
 POWER : 120Vac/60Hz  
 MODEL : FR 701101  
 MEMO : Bluetooth Tx\_CH78:2480MHz +  
 : 11b Tx\_Ch01:2412MHz  
 Data Rate: BT:3DH5 WLAN:11  
 PLANE : E2

	Freq	Level	Over	Limit	Read	Antenna	Cable	Preamp	Ant	Table	
	MHz	dBuV/m	Limit	Line	Level	Factor	Loss	Factor	Pos	Pos	Remark
			dB	dBuV/m	dBuV	dB/m	dB	dB	cm	deg	
1	2390.000	44.89	-9.11	54.00	42.39	32.54	3.74	33.78	157	341	Average
2	2390.000	58.24	-15.76	74.00	55.74	32.54	3.74	33.78	100	0	Peak
3 X	2412.000	105.22			102.69	32.55	3.76	33.78	100	0	Peak
4 @	2412.000	97.55			95.02	32.55	3.76	33.78	157	341	Average
5 X	2480.000	84.59			81.96	32.59	3.84	33.80	155	159	Average
6 X	2480.000	96.42			93.79	32.59	3.84	33.80	100	0	Peak
7	2483.500	50.97	-3.03	54.00	48.34	32.59	3.84	33.80	155	159	Average
8	2483.500	63.63	-10.37	74.00	61.00	32.59	3.84	33.80	100	0	Peak
9	4821.000	53.47	-20.53	74.00	47.06	34.83	5.88	34.30	100	0	Peak
10	6978.000	54.77	-19.23	74.00	44.94	36.00	6.35	32.52	100	0	Peak
11	6978.000	43.91	-10.09	54.00	34.08	36.00	6.35	32.52	100	107	Average
12	9648.000	45.11	-28.89	74.00	82.58	-10.07	7.60	35.00	100	0	Peak

Remark: #3, #4, #5, and #6 are Fundamental Signals



- Polarization : Vertical (30MHz-1GHz)

The test that passed at minimum margin was marked by the boldface in the following table.

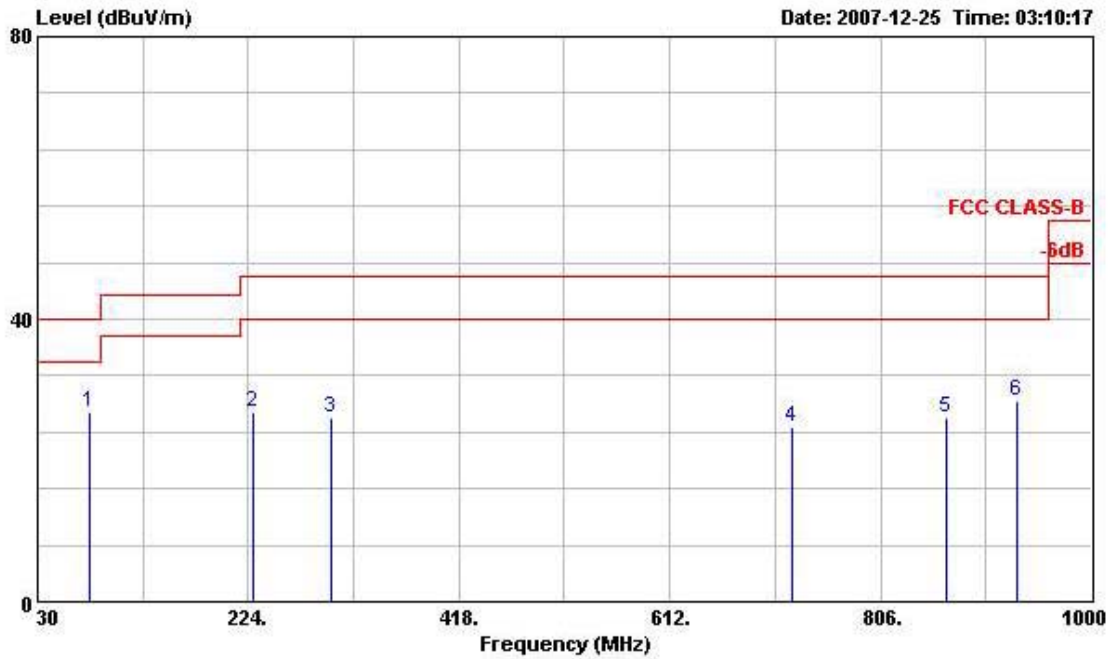

Site : 03CH04-HY  
 Condition: FCC CLASS-B 3m ANT2724 VERTICAL  
 EUT : Smart Phone  
 POWER : 120Vac/60Hz  
 MODEL : FR 701101  
 MEMO : Bluetooth Tx\_CH78:2480MHz +  
 : 11b Tx\_Ch01:2412MHz  
 Data Rate: BT:3DH5 WLAN:11  
 PLANE : E2

	Freq	Level	Over Limit	Limit Line	ReadAntenna Level	Antenna Factor	Cable Loss	Preamplifier	Ant Pos	Table Pos	Remark
	MHz	dBuV/m	dB	dBuV/m	dBuV	dB/m	dB	dB	cm	deg	
1	78.060	26.83	-13.17	40.00	47.02	6.80	1.26	28.24	100	136	Peak
2	228.450	26.82	-19.18	46.00	41.65	10.94	1.98	27.74	---	---	Peak
3	299.460	26.01	-19.99	46.00	39.06	12.31	2.24	27.60	---	---	Peak
4	724.200	24.74	-21.26	46.00	30.20	20.07	3.53	29.05	---	---	Peak
5	867.000	26.02	-19.98	46.00	28.65	22.30	3.90	28.83	---	---	Peak
6	932.100	28.53	-17.47	46.00	28.97	24.32	3.97	28.74	---	---	Peak





- Polarization : Vertical (1GHz-25GHz)

The test that passed at minimum margin was marked by the boldface in the following table.

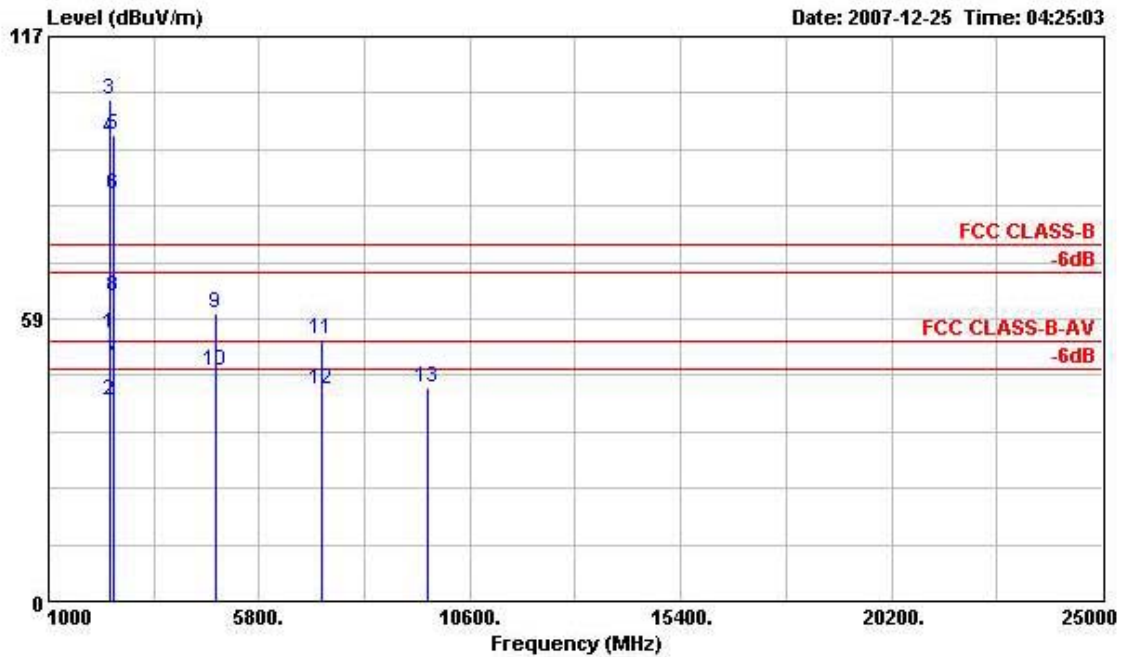

Site : 03CH04-HY  
 Condition: FCC CLASS-B 3m HF-ANT-3117 VERTICAL  
 EUT : Smart Phone  
 POWER : 120Vac/60Hz  
 MODEL : FR 701101  
 MEMO : Bluetooth Tx\_CH78:2480MHz +  
 : 11b Tx\_Ch01:2412MHz  
 Data Rate: BT:3DH5 WLAN:11  
 PLANE : E2

	Freq	Level	Over Limit	Limit Line	ReadAntenna Level	Antenna Factor	Cable Loss	Preamp Factor	Ant Pos	Table Pos	Remark
	MHz	dBuV/m	dB	dBuV/m	dBuV	dB/m	dB	dB	cm	deg	
1	2390.000	55.37	-18.63	74.00	52.87	32.54	3.74	33.78	100	0	Peak
2	2390.000	41.68	-12.32	54.00	39.18	32.54	3.74	33.78	100	6	Average
3 X	2412.000	103.84			101.31	32.55	3.76	33.78	100	0	Peak
4 @	2412.000	95.80			93.27	32.55	3.76	33.78	100	6	Average
5 X	2480.000	96.77			94.14	32.59	3.84	33.80	100	0	Peak
6 X	2480.000	84.35			81.72	32.59	3.84	33.80	100	43	Average
7 !	2483.500	49.65	-4.35	54.00	47.02	32.59	3.84	33.80	100	43	Average
8	2483.500	63.17	-10.83	74.00	60.54	32.59	3.84	33.80	100	0	Peak
9	4821.000	59.81	-14.19	74.00	53.40	34.83	5.88	34.30	100	0	Peak
10	4821.000	47.63	-6.37	54.00	41.22	34.83	5.88	34.30	149	56	Average
11	7233.000	54.25	-19.75	74.00	44.88	36.00	6.46	33.09	100	0	Peak
12	7233.000	43.78	-10.22	54.00	34.41	36.00	6.46	33.09	100	146	Average
13	9648.000	44.26	-29.74	74.00	81.73	-10.07	7.60	35.00	100	0	Peak

Remark: #3, #4, #5, and #6 are Fundamental Signals



## 5.10 Antenna Requirements

### 5.10.1 Standard Applicable

For intentional device, according to FCC 47 CFR Section 15.203, an intentional radiator shall be designed to ensure that no other antenna except assembled by the responsible party shall be used with the device.

And according to FCC 47 CFR Section 15.247 (b), if directional gain of transmitting antennas is greater than 6dBi, the power shall be reduced by the same level in dB comparing to gain minus 6dBi.

### 5.10.2 Antenna Connected Construction

The antennas used in this product are 錯誤! 找不到參照來源。 for BT without connector and it is considered to meet antenna requirement of FCC.

### 5.10.3 Antenna Gain

The antenna gain of EUT is less than 6 dBi. Therefore, it is not necessary to reduce maximum peak output power limit.



## 6. List of Measuring Equipments

Instrument	Manufacturer	Model No.	Serial No.	Characteristics	Calibration Date	Due Date	Remark
EMC Receiver	R&S	ESCS 30	100359	9kHz – 2.75GHz	Mar. 01, 2007	Feb. 29, 2008	Conduction (CO04-HY)
LISN	MessTec	NNB-2/16Z	99079	9kHz – 30MHz	Mar. 31, 2007	Mar. 30, 2008	Conduction (CO04-HY)
LISN (Support Unit)	EMCO	3810/2NM	9703-1839	9kHz – 30MHz	Mar. 22, 2007	Mar. 21, 2008	Conduction (CO04-HY)
RF Cable-CON	UTIFLEX	3102-26886-4	CB049	9kHz – 30MHz	Apr. 20, 2007	Apr. 19, 2008	Conduction (CO04-HY)
ISN	SCHAFFNER	ISN T400	21653	9kHz –30MHz	Mar. 09, 2007	Mar. 08, 2008	Conduction (CO04-HY)
EMI Filter	LINDGREN	LRE-2030	2651	< 450 Hz	N/A	N/A	Conduction (CO04-HY)
Isolation Transformer	Erika Fiedler OHG	D-65396 Walluf	58	45MHz-2.15GHz	N/A	N/A	Conduction (CO04-HY)
3m Semi Anechoic Chamber	TDK	SAC-3M	03CH04-HY	30 MHz - 1 GHz 3m	Oct. 29, 2007	Oct. 28, 2008	Radiation (03CH04-HY)
Amplifier	HP	87405A	3950M00135	10MHz - 3 GHz	Mar. 02, 2007	Mar. 01, 2008	Radiation (03CH04-HY)
Spectrum Analyzer	R&S	FSP30	100792	9 kHz – 30GHz	Dec. 13, 2007	Dec. 12, 2008	Radiation (03CH04-HY)
Bilog Antenna	SCHAFFNER	CBL6112B	2724	30 MHz - 1 GHz	Aug. 13, 2007	Aug. 12 2008	Radiation (03CH04-HY)
Turn Table	HD	Deis HD 2000	420/610	0 - 360 degree	N/A	N/A	Radiation (03CH04-HY)
Antenna Mast	Chaintek	3000	N/A	1 m - 4 m	N/A	N/A	Radiation (03CH04-HY)
RF Cable-R03m	Suhner Switzerland + RFIDEN	RG223/U +RG8/U	CB024	30 MHz - 1 GHz	Sep. 20, 2007	Sep. 19, 2008	Radiation (03CH04-HY)
Isolation Transformer	Erika FiedLer OHG	D-65396 Walluf	N/A	45 MHz – 2.15 GHz 30dB	N/A	N/A	Radiation (03CH04-HY)



## 7. Uncertainty Evaluation

### Uncertainty of Conducted Emission Measurement (150kHz ~ 30MHz)

Contribution	Uncertainty of $x_i$		$u(x_i)$
	dB	Probability Distribution	
Receiver reading	0.10	Normal(k=2)	0.05
Cable loss	0.10	Normal(k=2)	0.05
AMN insertion loss	2.50	Rectangular	0.63
Receiver Spec	1.50	Rectangular	0.43
Site imperfection	1.39	Rectangular	0.80
Mismatch	+0.34/-0.35	U-shape	0.24
<b>Combined standard uncertainty Uc(y)</b>	<b>1.13</b>		
<b>Measuring uncertainty for a level of confidence of 95% U=2Uc(y)</b>	<b>2.26</b>		

### Uncertainty of Radiated Emission Measurement (30MHz ~ 1000MHz)

Contribution	Uncertainty of $x_i$		$u(x_i)$
	dB	Probability Distribution	
Receiver reading	0.11	Normal(k=2)	0.06
Antenna factor calibration	0.91	Normal(k=2)	0.46
Cable loss calibration	0.12	Normal(k=2)	0.06
Pre Amplifier Gain calibration	0.15	Normal(k=2)	0.08
RCV/SPA specification	2.50	Rectangular	0.72
Antenna Factor Interpolation for Frequency	1.00	Rectangular	0.29
Site imperfection	1.52	Rectangular	0.88
Mismatch	+0.45/-0.48	U-shaped	0.33
<b>Combined standard uncertainty Uc(y)</b>	<b>1.30</b>		
<b>Measuring uncertainty for a level of confidence of 95% U=2Uc(y)</b>	<b>2.60</b>		



**Uncertainty of Radiated Emission Measurement (1GHz ~ 40GHz)**

Contribution	Uncertainty of $x_i$		$u(x_i)$	$C_i$	$C_i * u(x_i)$
	dB	Probability Distribution			
Receiver reading	±0.10	Normal(k=1)	0.10	1	0.10
Antenna factor calibration	±1.70	Normal(k=2)	0.85	1	0.85
Cable loss calibration	±0.50	Normal(k=2)	0.25	1	0.25
Receiver Correction	±2.00	Rectangular	1.15	1	1.15
Antenna Factor Directional	±1.50	Rectangular	0.87	1	0.87
Site imperfection	±2.80	Triangular	1.14	1	1.14
Mismatch Receiver VSWR $\Gamma_1= 0.197$ Antenna VSWR $\Gamma_2= 0.194$ Uncertainty= $20\log(1-\Gamma_1*\Gamma_2*\Gamma_3)$	+0.34/-0.35	U-shaped	0.244	1	0.244
<b>Combined standard uncertainty <math>U_c(y)</math></b>	<b>2.36</b>				
<b>Measuring uncertainty for a level of confidence of 95% <math>U=2U_c(y)</math></b>	<b>4.72</b>				

The measured result is :  $y$  dBuV  $\pm$   $U$  dB  
for a level of confidence of approximately 95% , (  $k= 2$  )