

# RADIO TEST REPORT

## FCC 47 CFR PART 15 SUBPART C

<b>Test Standard</b>	<b>FCC Part 15.247</b>
<b>FCC ID</b>	<b>EUN-GATEWAY-MF230</b>
<b>Brand Name</b>	<b>FIC</b>
<b>Product name</b>	<b>MF0230</b>
<b>Model No.</b>	<b>MF0230</b>
<b>Test Result</b>	<b>Pass</b>

The test Result was tested by Compliance Certification Services Inc. The test data, data evaluation, test procedures, and equipment configurations shown in this report were given in ANSI C63.10: 2013 and compliance standards.

The test results of this report relate only to the tested sample (EUT) identified in this report.

The test Report of full or partial shall not copy. Without written approval of Compliance Certification Services Inc.( Wugu Laboratory)



Approved by:

Tested by:

Handwritten signature of Sam Chuang in black ink.

Handwritten signature of Jerry Chuang in black ink.

---

Sam Chuang  
Manager

---

Jerry Chuang  
Engineer

### Revision History

Rev.	Issue Date	Revisions	Revised By
00	March 13, 2018	Initial Issue	Becca Chen
01	April 10, 2018	1. Modify antenna gain in page 5. 2. Modify BLE version in page 10.	Becca Chen
02	April 18, 2018	1. Added Loop Ant. in instrument calibration for 3M 966 Chamber Test site in page 7.	Becca Chen

---

## Table of contents

<b>1.</b>	<b>GENERAL INFORMATION .....</b>	<b>4</b>
1.1	EUT INFORMATION.....	4
1.2	EUT CHANNEL INFORMATION.....	5
1.3	ANTENNA INFORMATION.....	5
1.4	MEASUREMENT UNCERTAINTY .....	6
1.5	FACILITIES AND TEST LOCATION .....	7
1.6	INSTRUMENT CALIBRATION.....	7
1.7	SUPPORT AND EUT ACCESSORIES EQUIPMENT.....	8
<b>2.</b>	<b>TEST SUMMERY .....</b>	<b>9</b>
<b>3.</b>	<b>DESCRIPTION OF TEST MODES.....</b>	<b>10</b>
3.1	THE WORST MODE OF OPERATING CONDITION .....	10
3.2	THE WORST MODE OF MEASUREMENT .....	11
3.3	EUT DUTY CYCLE .....	12
<b>4.</b>	<b>TEST RESULT .....</b>	<b>13</b>
4.1	AC POWER LINE CONDUCTED EMISSION.....	13
4.2	6DB BANDWIDTH AND OCCUPIED BANDWIDTH(99%) .....	16
4.3	OUTPUT POWER MEASUREMENT .....	19
4.4	POWER SPECTRAL DENSITY .....	21
4.5	CONDUCTED BAND EDGE AND SPURIOUS EMISSION .....	23
4.6	RADIATION BANDEDGE AND SPURIOUS EMISSION .....	27
<b>APPENDIX 1 - PHOTOGRAPHS OF EUT</b>		

## 1. GENERAL INFORMATION

### 1.1 EUT INFORMATION

<b>Applicant</b>	First International Computer Inc 8F, No.300, Yang Guang St., NeiHu, Taipei, Taiwan 114
<b>Manufacturer</b>	First International Computer Inc 8F, No.300, Yang Guang St., NeiHu, Taipei, Taiwan 114
<b>Equipment</b>	MF0230
<b>Model No.</b>	MF0230
<b>Model Discrepancy</b>	N/A
<b>Trade Name</b>	FIC
<b>Received Date</b>	January 31, 2018
<b>Date of Test</b>	March 5 ~ 7, 2018
<b>Output Power (W)</b>	BLE : 0.0054
<b>Power Supply</b>	Powered from Adapter : <b>Billon / BA024-120200GXX</b> I/P: 100-240Vac, 0.7A, 50/60Hz O/P: 12Vdc, 2.0A

## 1.2 EUT CHANNEL INFORMATION

Frequency Range	2402MHz-2480MHz
Modulation Type	GFSK for BLE-1Mbps
Number of channel	40 Channels

**Remark:**

Refer as ANSI 63.10:2013 clause 5.6.1 Table 4 and RSS-GEN Table A1 for test channels

Number of frequencies to be tested		
Frequency range in which device operates	Number of frequencies	Location in frequency range of operation
<input type="checkbox"/> 1 MHz or less	1	Middle
<input type="checkbox"/> 1 MHz to 10 MHz	2	1 near top and 1 near bottom
<input checked="" type="checkbox"/> More than 10 MHz	3	1 near top, 1 near middle, and 1 near bottom

## 1.3 ANTENNA INFORMATION

<b>Antenna Type</b>	<input type="checkbox"/> PIFA <input type="checkbox"/> PCB <input checked="" type="checkbox"/> Dipole <input type="checkbox"/> Coils
<b>Antenna Gain</b>	Gain: 2.28dBi

## 1.4 MEASUREMENT UNCERTAINTY

PARAMETER	UNCERTAINTY
AC Powerline Conducted Emission	+/- 1.2575
Emission bandwidth, 20dB bandwidth	+/- 1.4003
RF output power, conducted	+/- 1.1372
Power density, conducted	+/- 1.4003
3M Semi Anechoic Chamber / 30M~200M	+/- 4.0138
3M Semi Anechoic Chamber / 200M~1000M	+/- 3.9483
3M Semi Anechoic Chamber / 1G~8G	+/- 2.5975
3M Semi Anechoic Chamber / 8G~18G	+/- 2.6112
3M Semi Anechoic Chamber / 18G~26G	+/- 2.7389
3M Semi Anechoic Chamber / 26G~40G	+/- 2.9683
3M Semi Anechoic Chamber / 40G~60G	+/- 1.8509
3M Semi Anechoic Chamber / 60G~75G	+/- 1.9869
3M Semi Anechoic Chamber / 75G~110G	+/- 2.9651
3M Semi Anechoic Chamber / 110G~170G	+/- 2.7807
3M Semi Anechoic Chamber / 170G~220G	+/- 3.6437
3M Semi Anechoic Chamber / 220G~325G	+/- 4.2982

**Remark:**

1. This uncertainty represents an expanded uncertainty expressed at approximately the 95% confidence level using a coverage factor of  $k=2$
2. ISO/IEC 17025 requires that an estimate of the measurement uncertainties associated with the emissions test results be included in the report.

## 1.5 FACILITIES AND TEST LOCATION

All measurement facilities used to collect the measurement data are located at No.11, Wugong 6th Rd., Wugu Dist., New Taipei City 24891, Taiwan. (R.O.C.)

Test site	Test Engineer	Remark
AC Conduction Room	Eric Lee	-
Radiation	Jerry Chuang	-
RF Conducted	Eric Lee	-

**Remark:** The sites are constructed in conformance with the requirements of ANSI C63.7, ANSI C63.4 and CISPR Publication 22.

## 1.6 INSTRUMENT CALIBRATION

RF Conducted Test Site					
Equipment	Manufacturer	Model	Serial Number	Calibration Date	Calibration Due
Power Meter	Anritsu	ML2495A	1033009	04/11/2017	04/10/2018
Power Sensor	Anritsu	MA2411B	917072	07/03/2017	07/02/2018
Spectrum Analyzer	R&S	FSV 40	101073	10/02/2017	10/01/2018
Directional Coupler	Agilent	87301D	MY44350252	07/25/2017	07/24/2018
SUCOFLEX Cable	HUBER SUHNER	SUCOFLEX 104PEA	25157	07/31/2017	07/30/2018
Divider	Solvang Technology	2-18GHz 4Way	STI08-0015	07/26/2017	07/25/2018

3M 966 Chamber Test Site					
Equipment	Manufacturer	Model	Serial Number	Calibration Date	Calibration Due
Bilog Antenna	Sunol Sciences	JB3	A030105	06/20/2017	06/19/2018
Horn Antenna	ETC	MCTD 1209	DRH13M02003	08/25/2017	08/24/2018
Pre-Amplifier	EMEC	EM330	60609	06/07/2017	06/06/2018
Spectrum Analyzer	Agilent	E4446A	US42510252	11/27/2017	11/26/2018
Antenna Tower	CCS	CC-A-1F	N/A	N.C.R	N.C.R
Controller	CCS	CC-C-1F	N/A	N.C.R	N.C.R
Turn Table	CCS	CC-T-1F	N/A	N.C.R	N.C.R
Pre-Amplifier	HP	8449B	3008A00965	06/27/2017	06/26/2018
Filter	N/A	2400-2500	N/A	N/A	N/A
Cable	HUBER SUHNER	SUCOFLEX 104PEA	25157	07/31/2017	07/30/2018
Cable	HUBER SUHNER	SUCOFLEX 104PEA	20995	07/31/2017	07/30/2018
Loop Ant	COM-POWER	AL-130	121051	03/21/2018	03/20/2019

AC Conducted Emissions Test Site					
Equipment	Manufacturer	Model	Serial Number	Calibration Date	Calibration Due
LISN	R&S	ENV216	101054	05/18/2017	05/17/2018
LISN	SCHWARZBECK	NSLK 8127	8127-541	02/14/2018	02/13/2019
EMI Test Receiver	R&S	ESCI	100064	05/17/2017	05/16/2018

**Note:**

1. The calibration interval of the above test instruments is 12 months and the calibrations are traceable to NML/ROC and NIST/USA.
2. N.C.R. = No Calibration Required.

## 1.7 SUPPORT AND EUT ACCESSORIES EQUIPMENT

EUT Accessories Equipment					
No.	Equipment	Brand	Model	Series No.	FCC ID
	N/A				

Support Equipment					
No.	Equipment	Brand	Model	Series No.	FCC ID
1	Monitor	DELL	U2410F	N/A	DoC
2	Keyboard	DELL	SK-8115	T3A002	DoC
3	Mouse	DELL	M-UAL-96	R41105	DoC

## 1.8 Test methodology and applied standards

The test methodology, setups and results comply with all requirements in accordance with ANSI C63.10:2013, FCC Part 2, FCC Part 15.247, KDB 558074 D01 v04.



## 2. TEST SUMMERY

<b>FCC Standard Section</b>	<b>Report Section</b>	<b>Test Item</b>	<b>Result</b>
15.203	1.2	Antenna Requirement	Pass
15.207(a)	4.1	AC Conducted Emission	-
15.247(a)(2)	4.2	6 dB Bandwidth	Pass
-	4.2	Occupied Bandwidth (99%)	Pass
15.247(b)	4.3	Output Power Measurement	Pass
15.247(e)	4.4	Power Spectral Density	Pass
15.247(d)	4.5	Conducted Band Edge	Pass
15.247(d)	4.5	Conducted Emission	Pass
15.247(d)	4.6	Radiation Band Edge	Pass
15.247(d)	4.6	Radiation Spurious Emission	Pass

### 3. DESCRIPTION OF TEST MODES

#### 3.1 THE WORST MODE OF OPERATING CONDITION

Operation mode	BT4.2 Mode (1Mbps)
Test Channel Frequencies	1.Lowest Channel : 2402MHz 2.Middle Channel : 2440MHz 3.Highest Channel : 2480MHz

**Remark:**

1. EUT pre-scanned data rate of output power for each mode, the worst data rate were recorded in this report.

### 3.2 THE WORST MODE OF MEASUREMENT

AC Power Line Conducted Emission	
Test Condition	AC Power line conducted emission for line and neutral
Voltage/Hz	120V/60Hz
Test Mode	Mode 1: EUT power by AC adapter via power cable.
Worst Mode	<input checked="" type="checkbox"/> Mode 1 <input type="checkbox"/> Mode 2 <input type="checkbox"/> Mode 3 <input type="checkbox"/> Mode 4

Radiated Emission Measurement Above 1G	
Test Condition	Band edge, Emission for Unwanted and Fundamental
Voltage/Hz	120V/60Hz
Test Mode	Mode 1: EUT power by AC adapter via power cable.
Worst Mode	<input checked="" type="checkbox"/> Mode 1 <input type="checkbox"/> Mode 2 <input type="checkbox"/> Mode 3 <input type="checkbox"/> Mode 4
Worst Position	<input type="checkbox"/> Placed in fixed position. <input type="checkbox"/> Placed in fixed position at X-Plane (E2-Plane) <input checked="" type="checkbox"/> Placed in fixed position at Y-Plane (E1-Plane) <input type="checkbox"/> Placed in fixed position at Z-Plane (H-Plane)
Worst Polarity	<input type="checkbox"/> Horizontal <input checked="" type="checkbox"/> Vertical

Radiated Emission Measurement Below 1G	
Test Condition	Radiated Emission Below 1G
Voltage/Hz	120V/60Hz
Test Mode	Mode 1: EUT power by AC adapter via power cable.
Worst Mode	<input checked="" type="checkbox"/> Mode 1 <input type="checkbox"/> Mode 2 <input type="checkbox"/> Mode 3 <input type="checkbox"/> Mode 4

**Remark:**

1. The worst mode was record in this test report.
2. EUT pre-scanned in three axis, X, Y, Z and two polarity, Horizontal and Vertical for radiated measurement. The worst case (Y-Plane and Vertical) were recorded in this report
3. For below 1G, radiation emission were performed the EUT transmit at the highest output power channel as worse case.

### 3.3 EUT DUTY CYCLE

Duty Cycle				
Configuration	TX ON (ms)	TX ALL (ms)	Duty Cycle (%)	Duty Factor(dB)
BLE	0.4100	0.6300	65.08%	1.87

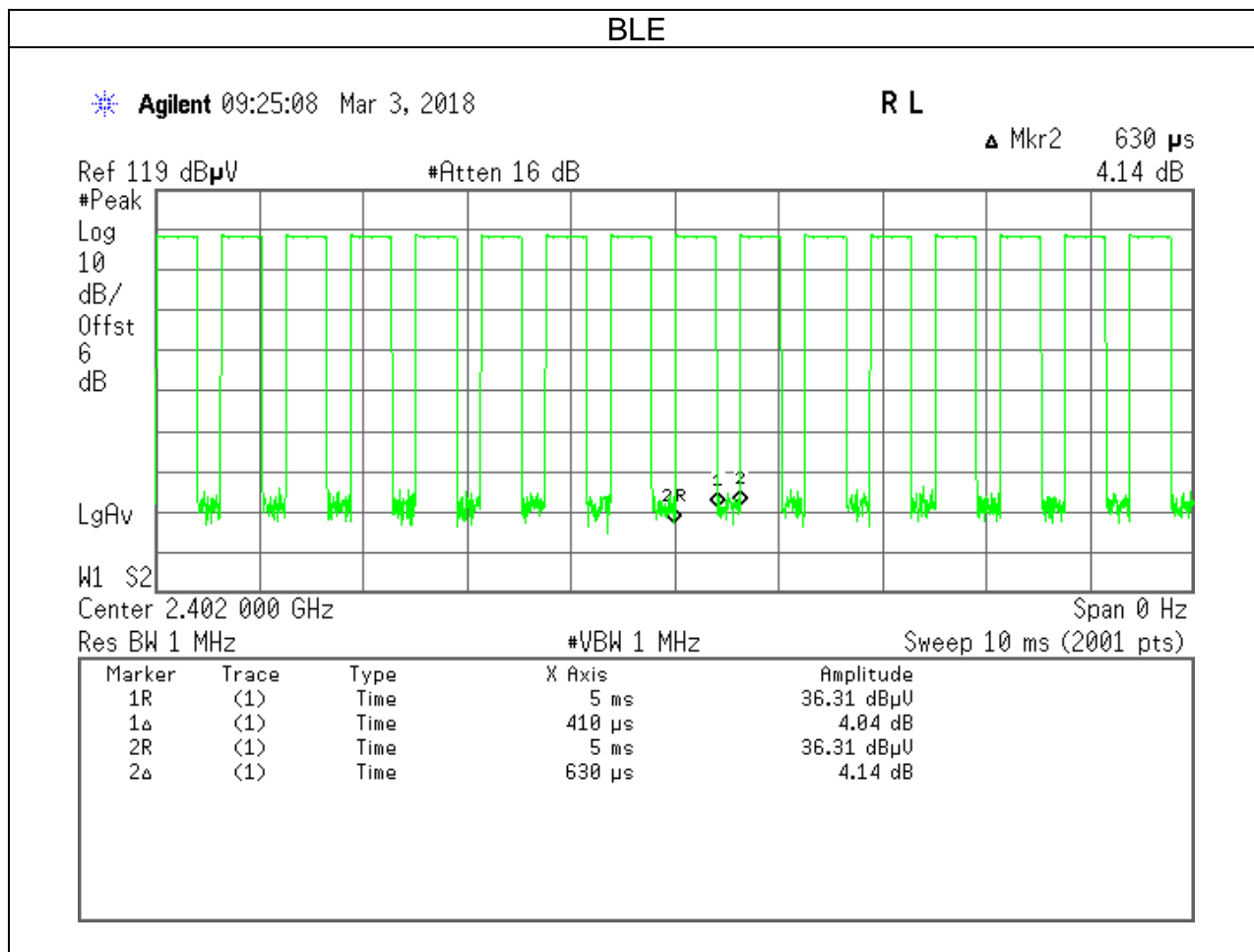

## 4. TEST RESULT

### 4.1 AC POWER LINE CONDUCTED EMISSION

#### 4.1.1 Test Limit

According to §15.207(a),

Frequency Range (MHz)	Limits(dBµV)	
	Quasi-peak	Average
0.15 to 0.50	66 to 56*	56 to 46*
0.50 to 5	56	46
5 to 30	60	50

\* Decreases with the logarithm of the frequency.

#### 4.1.2 Test Procedure

Test method Refer as ANSI 63.10:2013 clause 6.2,

1. The EUT was placed on a non-conducted table, which is 0.8m above horizontal ground plane and 0.4m above vertical ground plane.
2. EUT connected to the line impedance stabilization network (LISN)
3. Receiver set RBW of 9kHz and Detector Peak, and note as quasi-peak and average.
4. Maximum procedure was performed on the six highest emissions to ensure EUT compliance.
5. Recorded Line for Neutral and Line.

#### 4.1.3 Test Setup

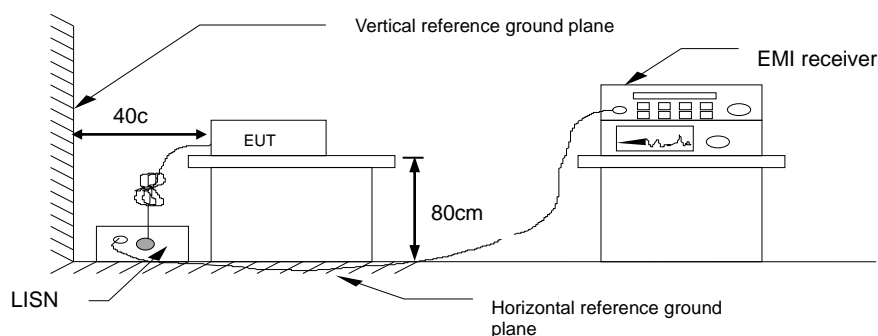

#### 4.1.4 Test Result

**Pass.**

Test Mode:	Mode 1	Temp/Hum	24(°C) / 50%RH
Test Voltage:	AC 120V	Test Date	2018/3/6
Phase:	Line	Test Engineer	Eric Lee

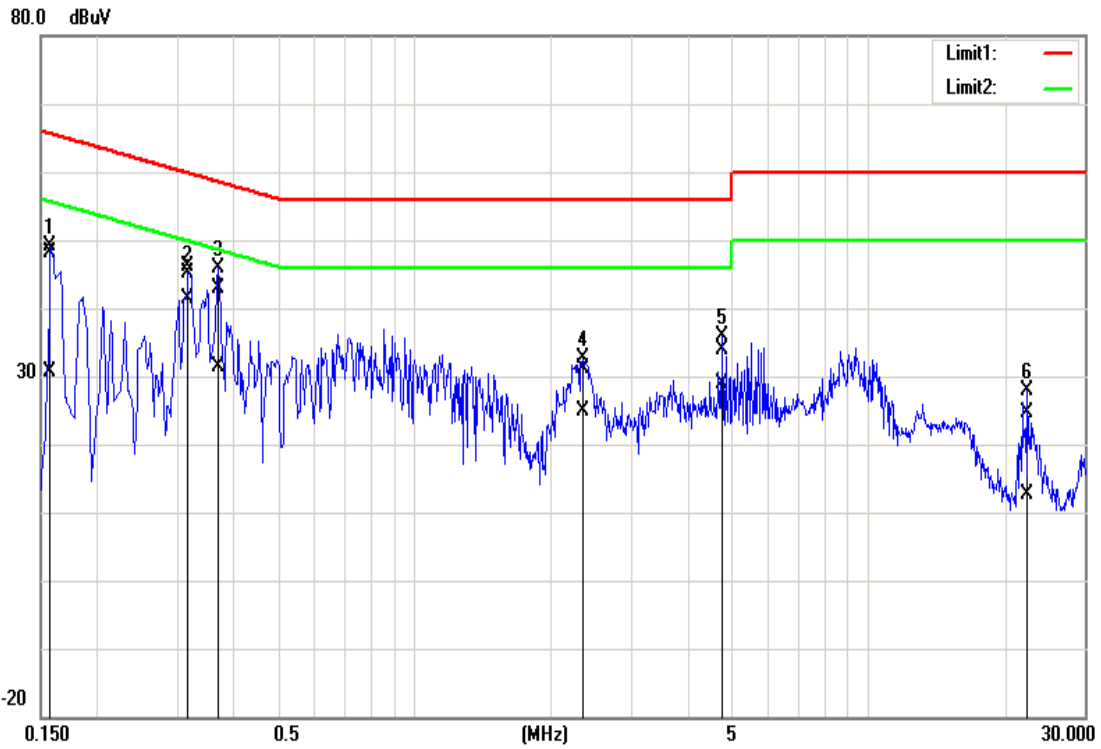

No.	Frequency (MHz)	QuasiPeak reading (dBuV)	Average reading (dBuV)	Correction factor (dB)	QuasiPeak result (dBuV)	Average result (dBuV)	QuasiPeak limit (dBuV)	Average limit (dBuV)	QuasiPeak margin (dB)	Average margin (dB)	Remark
1	0.1580	48.12	30.46	0.11	48.23	30.57	65.56	55.57	-17.33	-25.00	Pass
2*	0.3180	46.07	41.30	0.12	46.19	41.42	59.76	49.76	-13.57	-8.34	Pass
3	0.3700	42.69	31.30	0.12	42.81	31.42	58.50	48.50	-15.69	-17.08	Pass
4	2.3540	30.95	24.63	0.16	31.11	24.79	56.00	46.00	-24.89	-21.21	Pass
5	4.7740	33.74	28.68	0.20	33.94	28.88	56.00	46.00	-22.06	-17.12	Pass
6	22.5100	24.06	12.03	0.50	24.56	12.53	60.00	50.00	-35.44	-37.47	Pass

Test Mode:	Mode 1	Temp/Hum	24(°C) / 50%RH
Test Voltage:	AC 120V	Test Date	2018/3/6
Phase:	Neutral	Test Engineer	Eric Lee

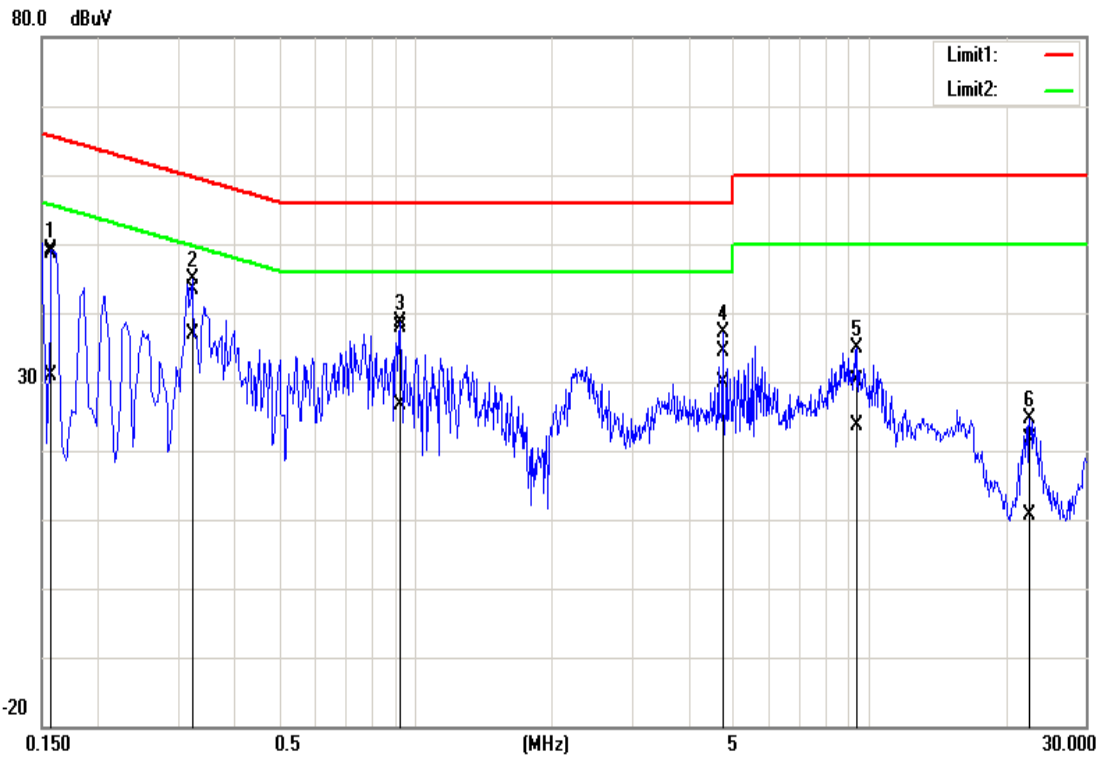

No.	Frequency (MHz)	QuasiPeak reading (dBuV)	Average reading (dBuV)	Correction factor (dB)	QuasiPeak result (dBuV)	Average result (dBuV)	QuasiPeak limit (dBuV)	Average limit (dBuV)	QuasiPeak margin (dB)	Average margin (dB)	Remark
1	0.1580	48.52	30.79	0.14	48.66	30.93	65.57	55.57	-16.91	-24.64	Pass
2*	0.3220	43.32	36.69	0.13	43.45	36.82	59.66	49.66	-16.21	-12.84	Pass
3	0.9260	37.65	26.60	0.14	37.79	26.74	56.00	46.00	-18.21	-19.26	Pass
4	4.7660	34.16	29.75	0.21	34.37	29.96	56.00	46.00	-21.63	-16.04	Pass
5	9.4300	29.81	23.29	0.29	30.10	23.58	60.00	50.00	-29.90	-26.42	Pass
6	22.6020	21.09	10.13	0.51	21.60	10.64	60.00	50.00	-38.40	-39.36	Pass

## 4.2 6DB BANDWIDTH AND OCCUPIED BANDWIDTH(99%)

### 4.2.1 Test Limit

According to §15.247(a)(2),

#### 6 dB Bandwidth :

Limit	Shall be at least 500kHz
-------	--------------------------

Occupied Bandwidth(99%) : For reporting purposes only.

### 4.2.2 Test Procedure

Test method Refer as KDB 558074 D01 v04, Section 8.1 and ANSI 63.10:2013 clause 6.9.2,

1. The EUT RF output connected to the spectrum analyzer by RF cable.
2. Setting maximum power transmit of EUT.
3. SA set RBW =100KHz, VBW = 300KHz and Detector = Peak, to measurement 6dB Bandwidth.
4. SA set RBW = 1% ~ 5% OBW, VBW = three times the RBW and Detector = Peak, to measurement 99% Bandwidth.
5. Measure and record the result of 6 dB Bandwidth and 99% Bandwidth. in the test report.

### 4.2.3 Test Setup

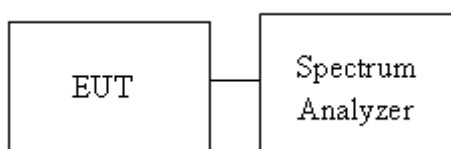

### 4.2.4 Test Result

Test mode: BLE mode / 2402-2480 MHz				
Channel	Frequency (MHz)	OBW(99%) (MHz)	6dB BW (MHz)	6dB limit (kHz)
Low	2402	1.0463	0.7207	>500
Mid	2440	1.0419	0.7250	
High	2480	1.0463	0.6903	



## 6dB BW Test Data

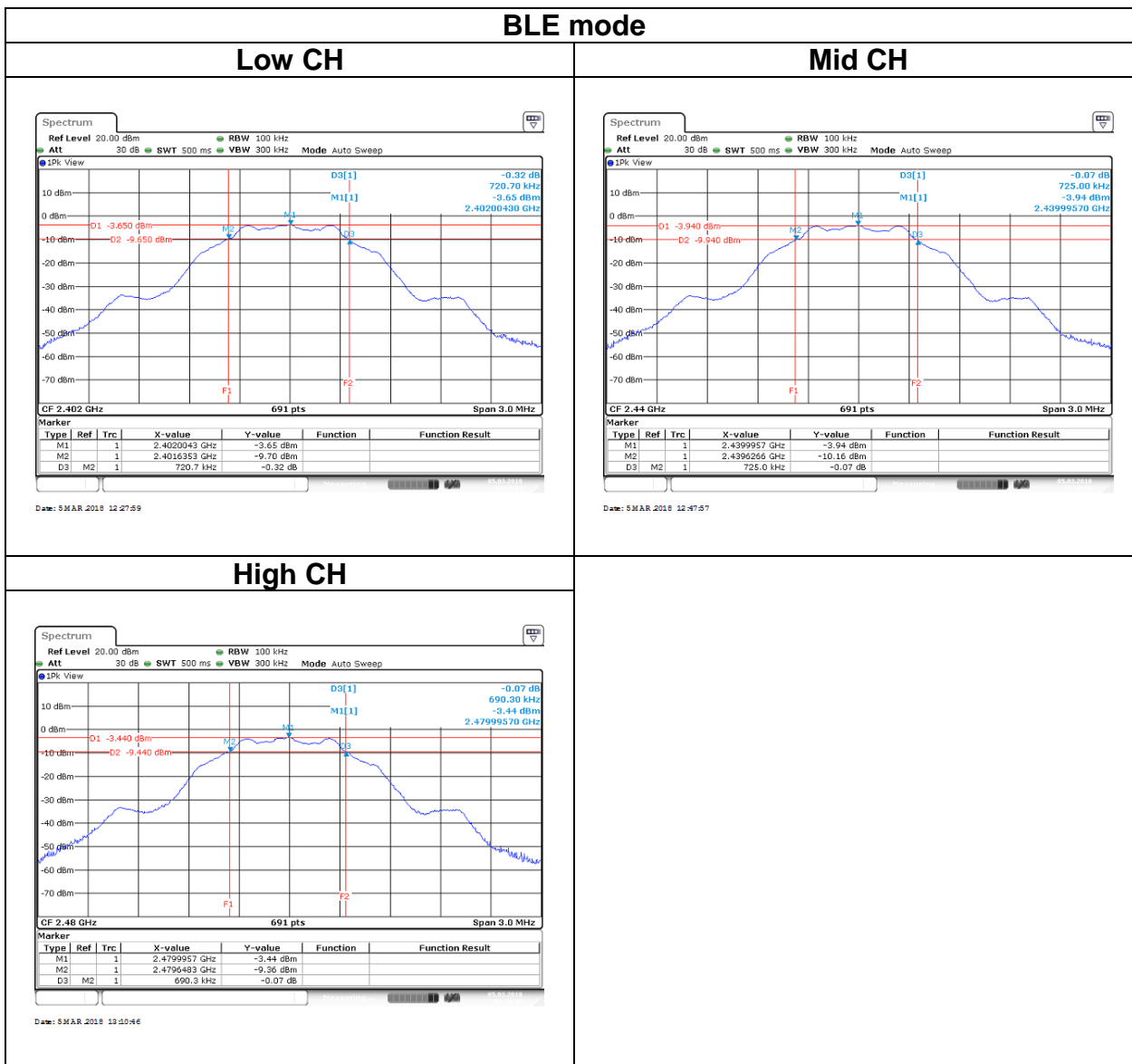

## OBW(99%) Test Data

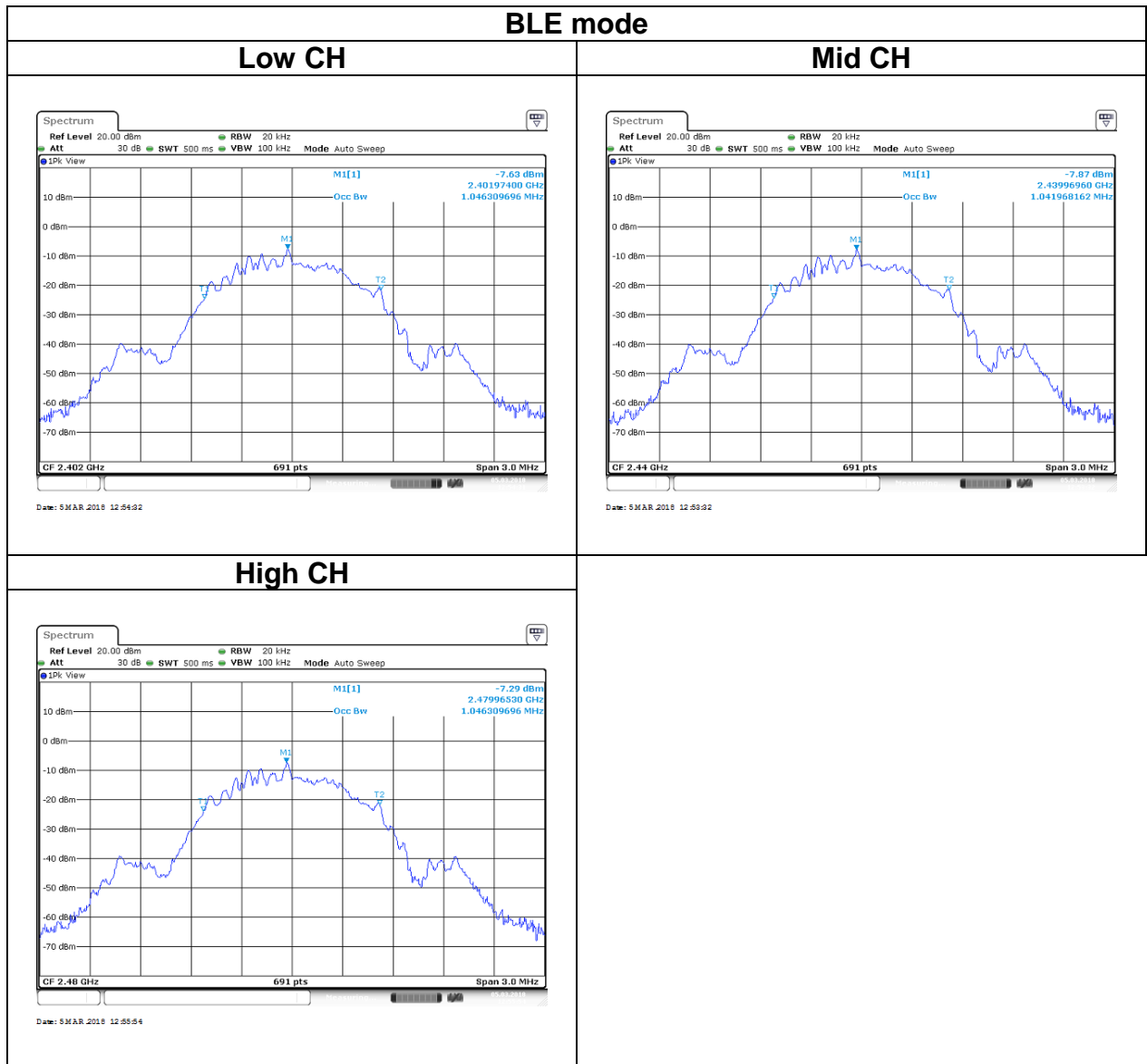

### 4.3 OUTPUT POWER MEASUREMENT

#### 4.3.1 Test Limit

According to §15.247(b).

**Peak output power :**

For systems using digital modulation in the 2400-2483.5 MHz, and 5725-5850 MHz bands: 1 Watt(30 dBm), base on the use of antennas with directional gain not exceed 6 dBi If transmitting antennas of directional gain greater than 6dBi are used the peak output power the conducted output power from the intentional radiator shall be reduced by the amount in dB that the directional gain of the antenna exceeds 6 dBi. In case of point-to-point operation, the limit has to be reduced by 1dB for every 3 dB that the directional gain of the antenna exceeds 6 dBi.

Limit	<input checked="" type="checkbox"/> Antenna not exceed 6 dBi : 30dBm <input type="checkbox"/> Antenna with DG greater than 6 dBi [ Limit = 30 – (DG – 6) ] <input type="checkbox"/> Point-to-point operation
-------	---

**Average output power** : For reporting purposes only.

#### 4.3.2 Test Procedure

Test method Refer as KDB 558074 D01 v04, section 9.1.2.

1. The EUT RF output connected to the power meter by RF cable.
2. Setting maximum power transmit of EUT.
3. The path loss was compensated to the results for each measurement.
4. Measure and record the result of Peak output power and Average output power. in the test report.

#### 4.3.3 Test Setup

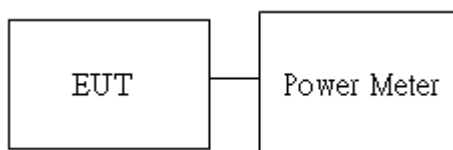

### 4.3.4 Test Result

**Peak output power :**

Channel	Frequency (MHz)	Output Power (dBm)	Output Power (W)	Limit (dBm)	Result
0	2402	6.91	0.0049	30	PASS
19	2440	6.87	0.0049		PASS
39	2480	7.32	0.0054		PASS

**Average output power :**

Channel	Frequency (MHz)	Output Power (dBm)	Output Power (W)
0	2402	6.53	0.0045
19	2440	6.44	0.0044
39	2480	6.78	0.0048

## 4.4 POWER SPECTRAL DENSITY

### 4.4.1 Test Limit

According to §15.247(e),

For digitally modulated systems, the power spectral density conducted from the intentional radiator to the antenna shall not be greater than 8 dBm in any 3 kHz band during any time interval of continuous transmission.

Limit	<input checked="" type="checkbox"/> Antenna not exceed 6 dBi : 8dBm <input type="checkbox"/> Antenna with DG greater than 6 dBi [ Limit = 8 – (DG – 6) ] <input type="checkbox"/> Point-to-point operation :
-------	---

### 4.4.2 Test Procedure

Test method Refer as KDB 558074 D01 v04, Section 10.2

1. The EUT RF output connected to the spectrum analyzer by RF cable.
2. Setting maximum power transmit of EUT
3. SA set RBW = 3kHz, VBW = 30kHz, Span = 1.5 times DTS Bandwidth (6 dB BW), Detector = Peak, Sweep Time = Auto and Trace = Max hold.
4. The path loss and Duty Factor were compensated to the results for each measurement by SA.
5. Mark the maximum level.
6. Measure and record the result of power spectral density. in the test report.

### 4.4.3 Test Setup

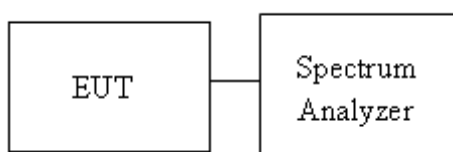

### 4.4.4 Test Result

Test mode: BLE mode / 2402-2480 MHz			
Channel	Frequency (MHz)	PSD (dBm)	FCC limit (dBm)
Low	2402	-6.41	8
Mid	2440	-6.39	
High	2480	-6.01	

## Test Data

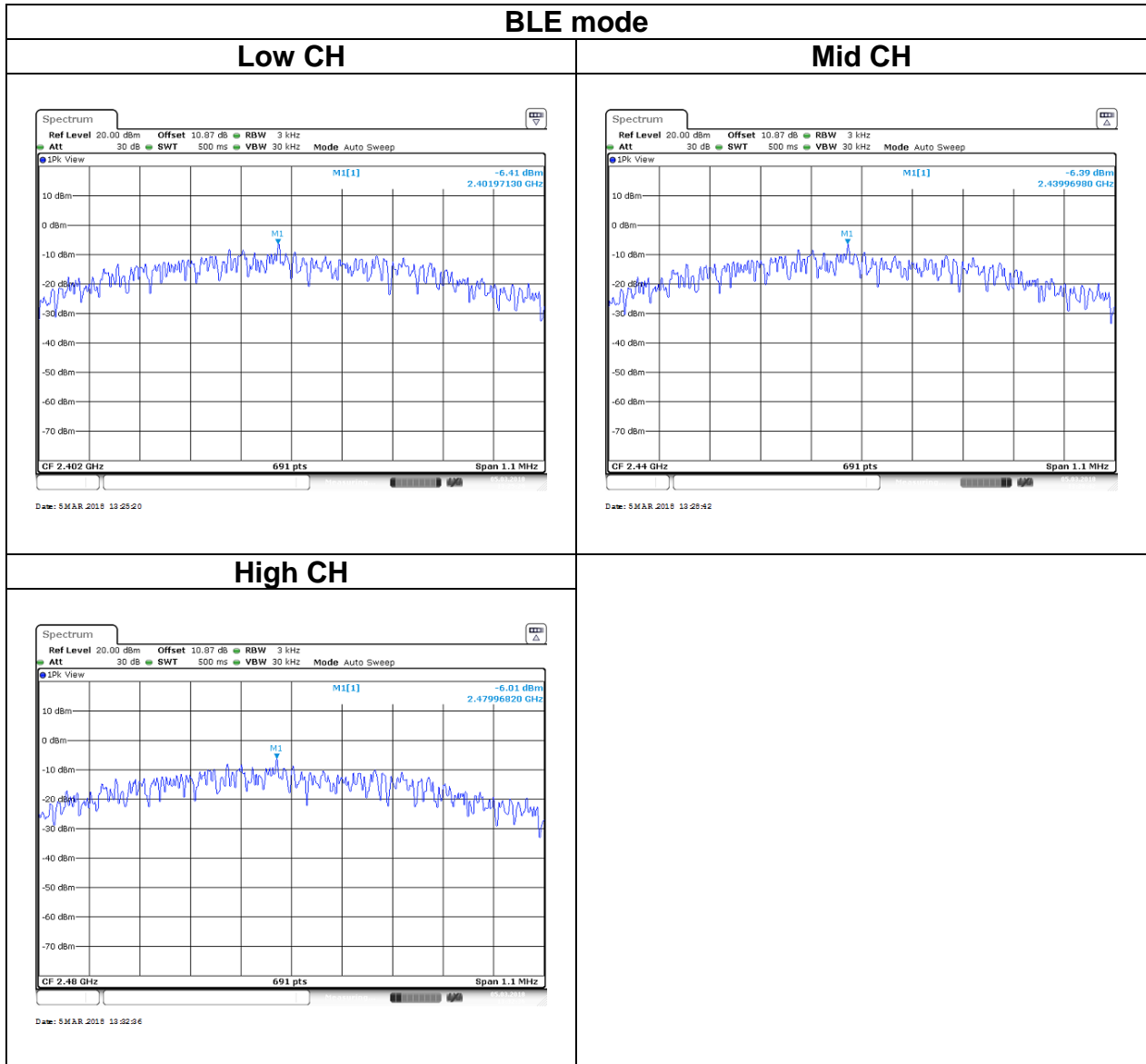

## 4.5 CONDUCTED BAND EDGE AND SPURIOUS EMISSION

### 4.5.1 Test Limit

According to §15.247(d),

In any 100 kHz bandwidth outside the authorized frequency band,

Non-restricted bands shall be attenuated at least 20 dB/30 dB relative to the maximum PSD level in 100 kHz by RF conducted or a radiated measurement which fall in the restricted bands, as defined in §15.205(a), must also comply with the radiated emission limits specified in §15.209(a).

### 4.5.2 Test Procedure

Test method Refer as KDB 558074 D01 v04, Section 11.

1. EUT RF output port connected to the SA by RF cable, and the path loss was compensated to result.
2. SA setting, RBW=100kHz, VBW=300kHz, Detector=Peak, Trace mode = max hold, SWT = Auto.
3. In any 100 kHz bandwidth outside the authorized frequency band, shall be attenuated at least 20 dB relative to the maximum in-band peak PSD level in 100 kHz when conducted power procedure is used. If the transmitter complies with the conducted power limits based on the use of RMS averaging over a time interval, the attenuation required under this paragraph shall be 30 dB instead of 20 dB.

### 4.5.3 Test Setup

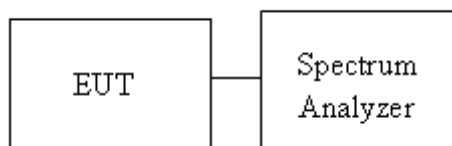

### 4.5.4 Test Result

#### Test Data

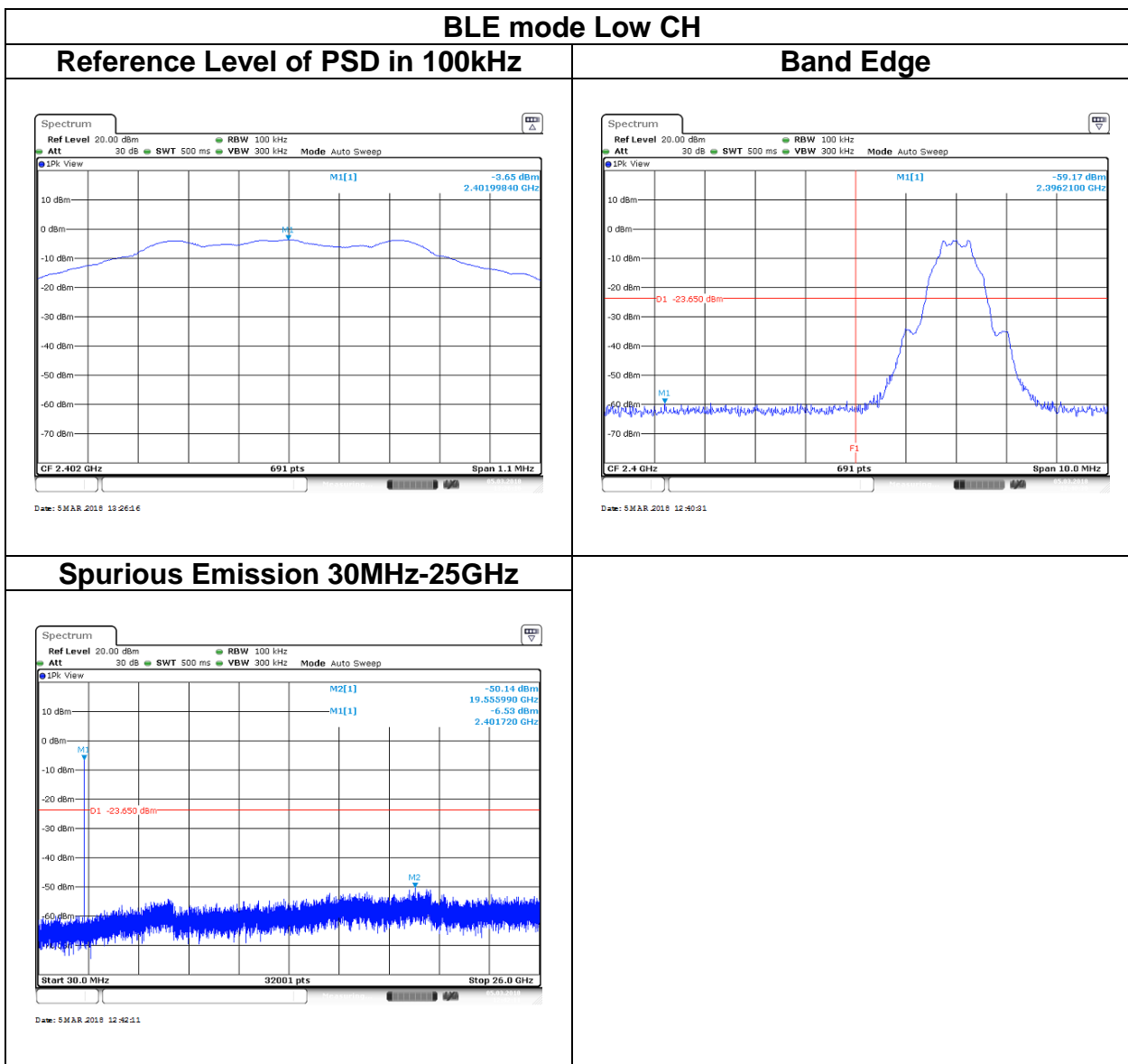



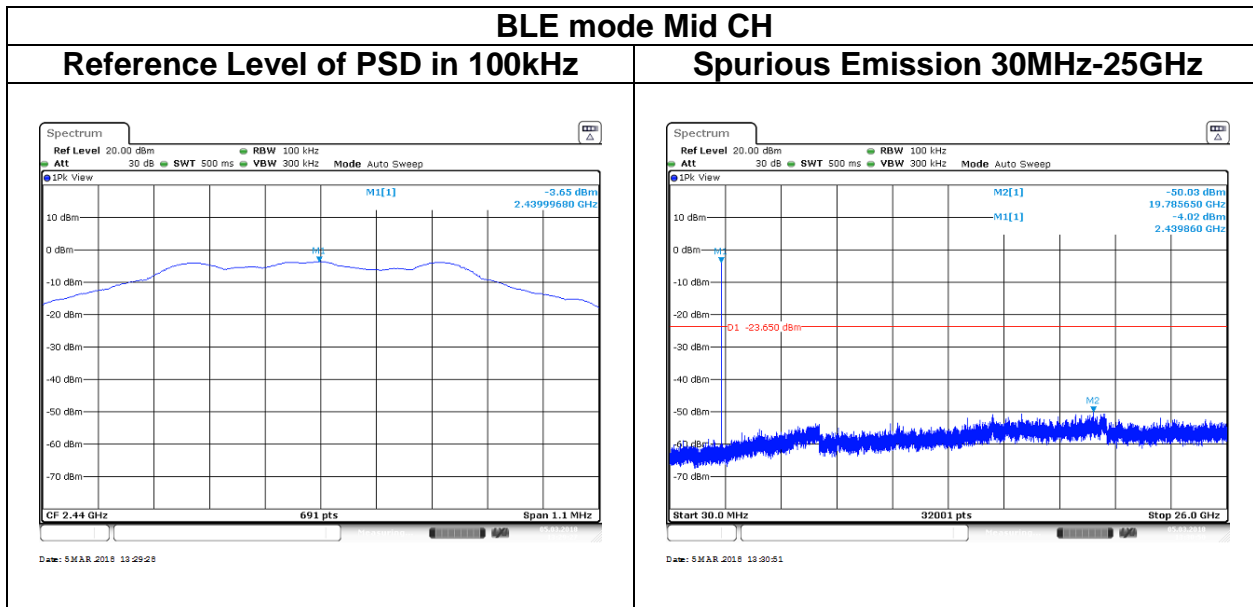

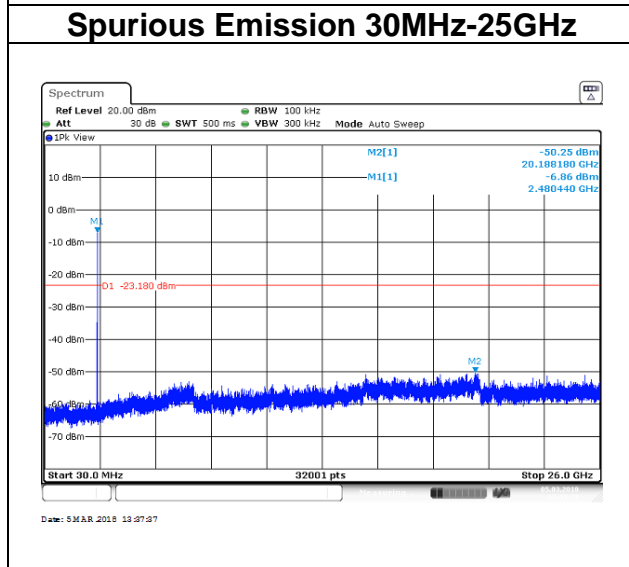
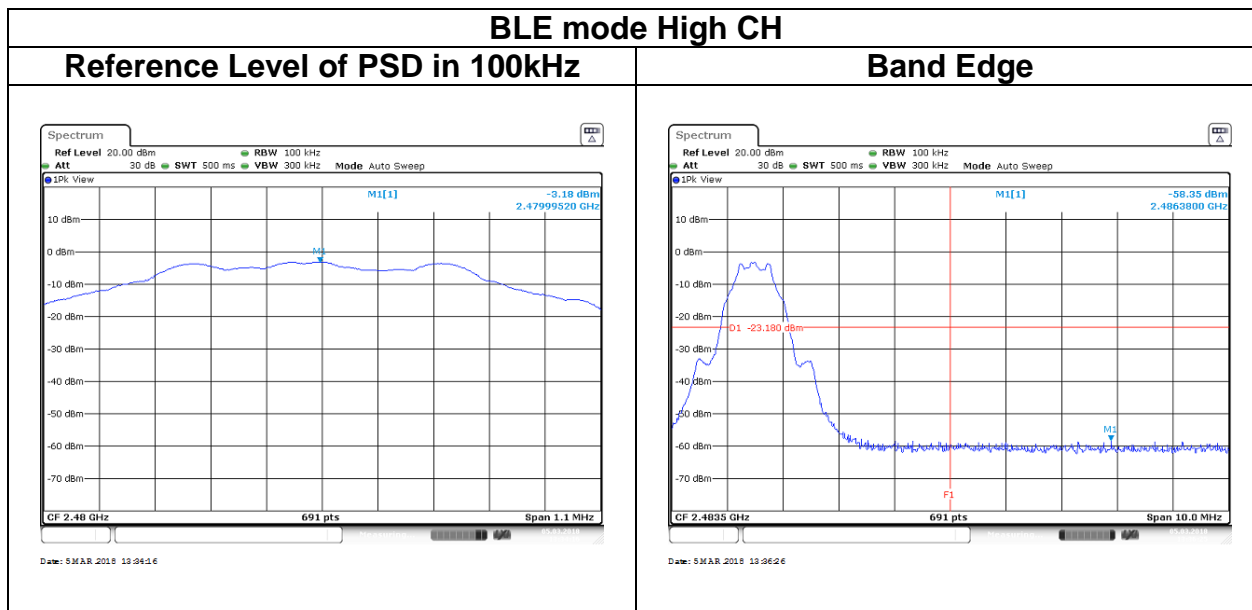

## 4.6 RADIATION BANDEGE AND SPURIOUS EMISSION

### 4.6.1 Test Limit

FCC according to §15.247(d), §15.209 and §15.205,

In any 100 kHz bandwidth outside the authorized frequency band, all harmonic and spurious must be least 20 dB below the highest emission level with the authorized frequency band. Radiation emission which fall in the restricted bands must also follow the FCC section 15.209 as below limit in table.

#### Below 30 MHz

Frequency	Field Strength (microvolts/m)	Magnetic H-Field (microamperes/m)	Measurement Distance (metres)
9-490 kHz	2,400/F (F in kHz)	2,400/F (F in kHz)	300
490-1,705 kHz	24,000/F (F in kHz)	24,000/F (F in kHz)	30
1.705-30 MHz	30	N/A	30

#### Above 30 MHz

Frequency (MHz)	Field Strength microvolts/m at 3 metres (watts, e.i.r.p.)	
	Transmitters	Receivers
30-88	100 (3 nW)	100 (3 nW)
88-216	150 (6.8 nW)	150 (6.8 nW)
216-960	200 (12 nW)	200 (12 nW)
Above 960	500 (75 nW)	500 (75 nW)

Remark:

Although these tests were performed other than open area test site, adequate comparison measurements were confirmed against 30 m open are test site. Therefore sufficient tests were made to demonstrate that the alternative site produces results that correlate with the ones of tests made in an open field based on KDB 937606.

### 4.6.2 Test Procedure

Test method Refer as KDB 558074 D01 v04, Section 12.1.

1. The EUT is placed on a turntable, Above 1 GHz is 1.5m and below 1 GHz is 0.8m above ground plane. The EUT Configured un accordance with ANSI C63.10, and the EUT set in a continuous mode.
2. The turntable shall be rotated for 360 degrees to determine the position of maximum emission level. And EUT is set 3m away from the receiving antenna, which is scanned from 1m to 4m above the ground plane to find out the highest emissions. Measurement are made polarized in both the vertical and the horizontal positions with antenna.
3. Span shall wide enough to full capture the emission measured. The SA from 9KHz to 26.5GHz set to the low, Mid and High channels with the EUT transmit.
4. No emission found between lowest internal used/generated frequency to 30MHz (9KHz~30MHz)

Remark:

Although these tests were performed other than open area test site, adequate comparison measurements were confirmed against 30 m open are test site. Therefore sufficient tests were made to demonstrate that the alternative site produces results that correlate with the ones of tests made in an open field based on KDB 937606.

5. The SA setting following :

- (1) Below 1G : RBW = 100kHz, VBW ≥ 3 RBW, Sweep = Auto, Detector = Peak, Trace = Max hold.
- (2) Above 1G :
  - (2.1) For Peak measurement : RBW = 1MHz, VBW ≥ 3 RBW, Sweep = Auto, Detector = Peak, Trace = Max hold.
  - (2.2) For Average measurement : RBW = 1MHz, VBW
    - If Duty Cycle ≥ 98%, VBW=10Hz.
    - If Duty Cycle < 98%, VBW=1/T.

Configuration	Duty Cycle (%)	T(ms)	1/T (kHz)	VBW Setting
BLE	65%	0.4100	2.439	2.7Khz

### 4.6.3 Test Setup

#### 9kHz ~ 30MHz

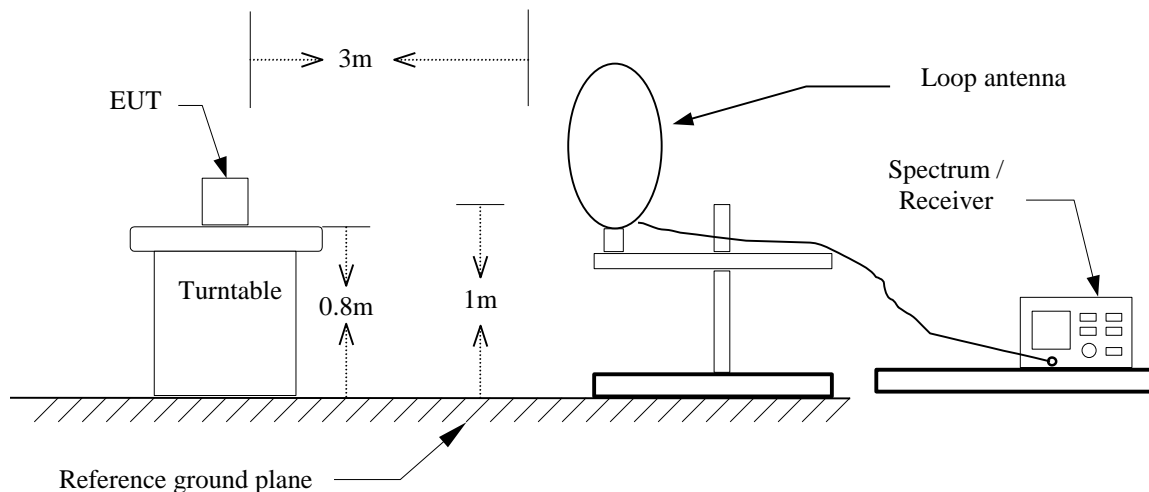

#### 30MHz ~ 1GHz

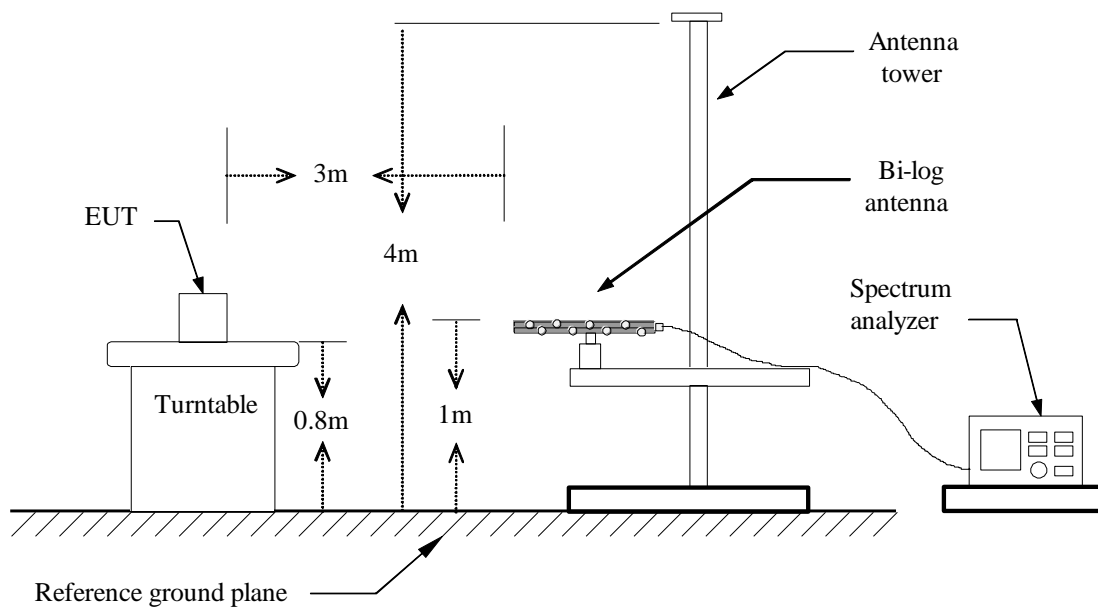

**Above 1 GHz**

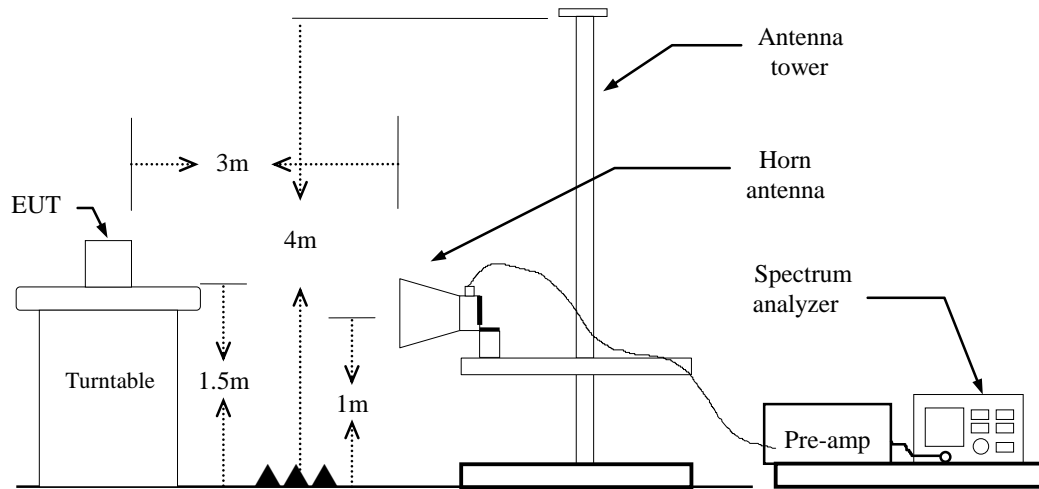

### 4.6.4 Test Result

#### Band Edge Test Data

Test Mode:	BLE Low CH	Temp/Hum	22(°C)/ 34%RH
Test Item	Band Edge	Test Date	March 7, 2018
Polarize	Vertical	Test Engineer	Jerry Chuang
Detector	Peak	Test Voltage	AC 120V

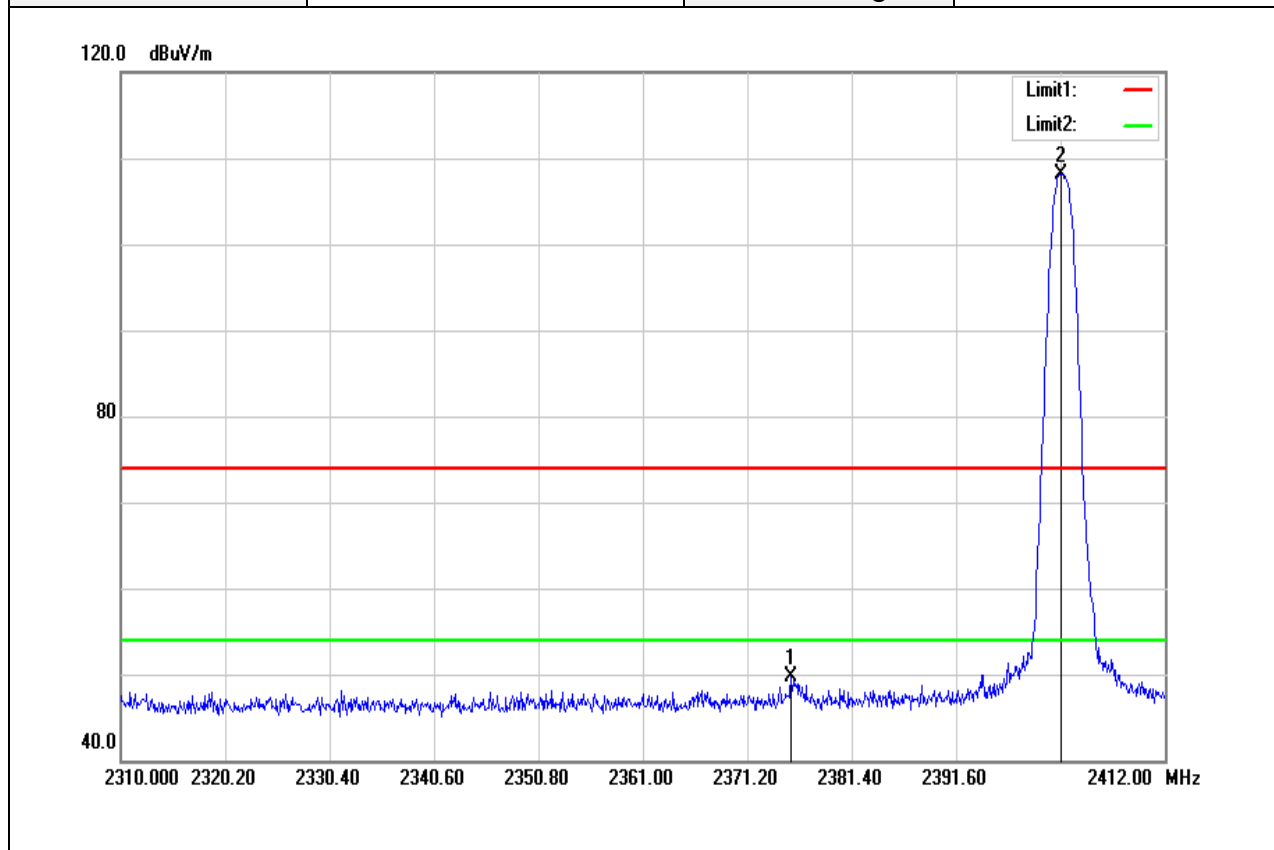

No.	Frequency (MHz)	Reading (dBuV)	Correct Factor(dB/m)	Result (dBuV/m)	Limit (dBuV/m)	Margin (dB)	Remark
1	2375.484	52.64	-3.02	49.62	74.00	-24.38	peak
2	2401.902	111.02	-2.95	108.07	--	--	peak

Test Mode:	BLE Low CH	Temp/Hum	22(°C)/ 34%RH
Test Item	Band Edge	Test Date	March 7, 2018
Polarize	Vertical	Test Engineer	Jerry Chuang
Detector	Average	Test Voltage	AC 120V

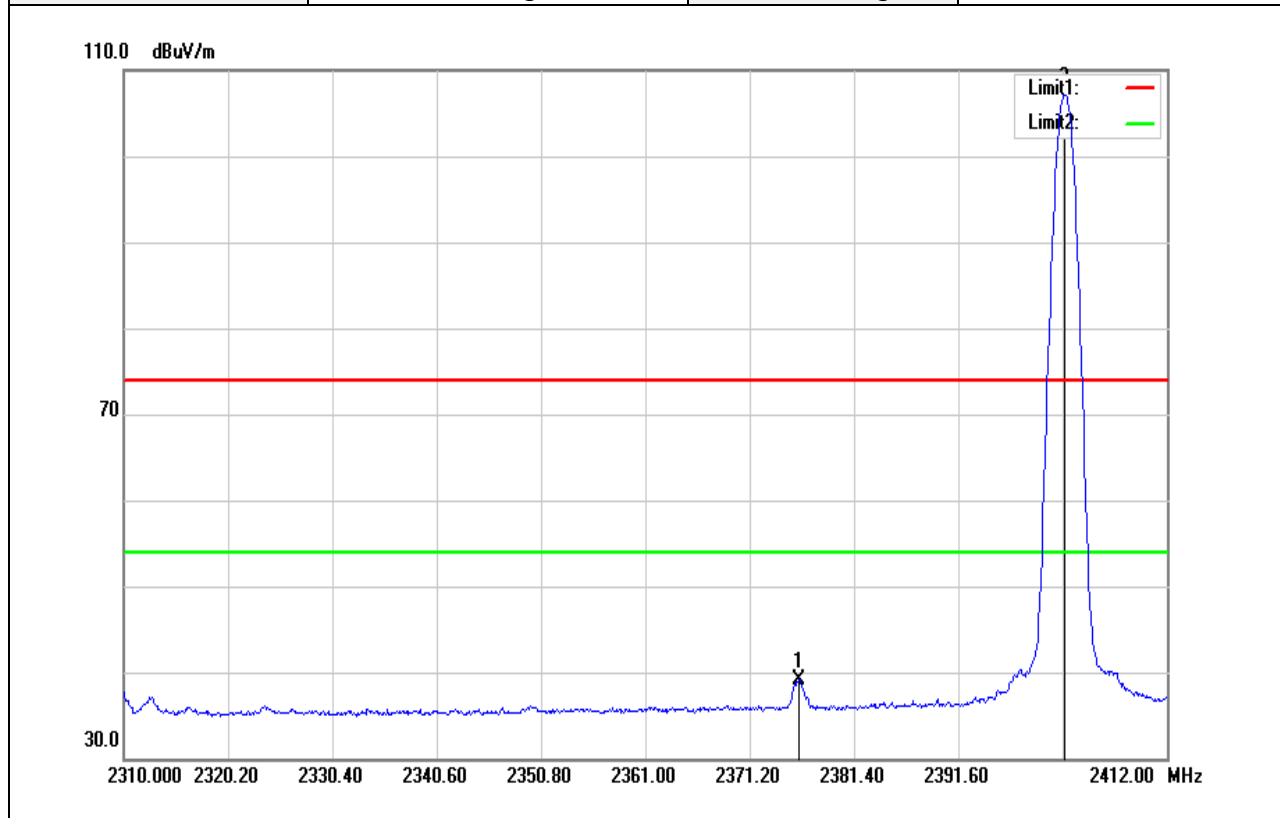

No.	Frequency (MHz)	Reading (dBuV)	Correct Factor(dB/m)	Result (dBuV/m)	Limit (dBuV/m)	Margin (dB)	Remark
1	2375.994	42.14	-3.02	39.12	54.00	-14.88	AVG
2	2402.055	110.11	-2.95	107.16	--	--	AVG



Test Mode:	BLE High CH	Temp/Hum	22(°C)/ 34%RH
Test Item	Band Edge	Test Date	March 7, 2018
Polarize	Vertical	Test Engineer	Jerry Chuang
Detector	Peak	Test Voltage	AC 120V

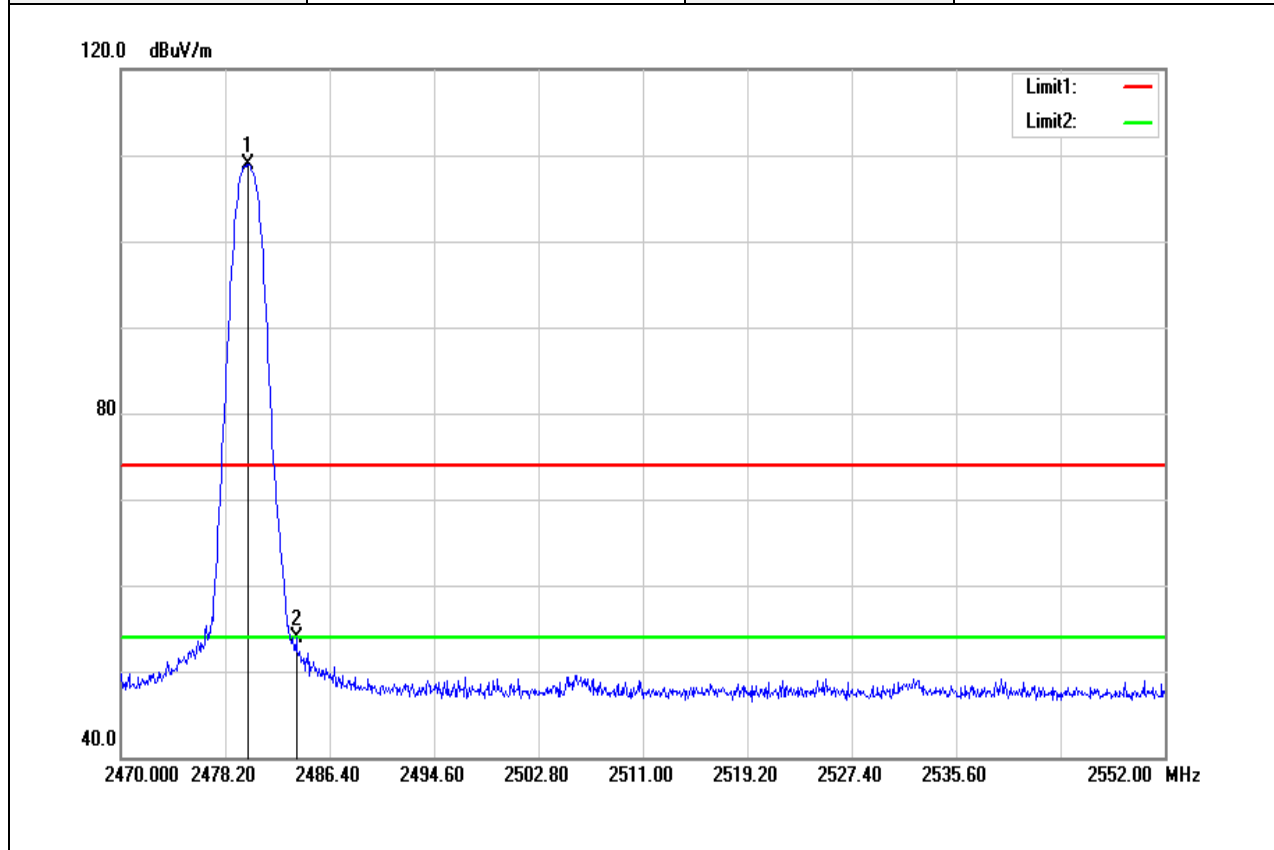

No.	Frequency (MHz)	Reading (dBuV)	Correct Factor(dB/m)	Result (dBuV/m)	Limit (dBuV/m)	Margin (dB)	Remark
1	2480.004	111.65	-2.70	108.95	--	--	peak
2	2483.776	56.52	-2.69	53.83	74.00	-20.17	peak

Test Mode:	BLE High CH	Temp/Hum	22(°C)/ 34%RH
Test Item	Band Edge	Test Date	March 7, 2018
Polarize	Vertical	Test Engineer	Jerry Chuang
Detector	Average	Test Voltage	AC 120V

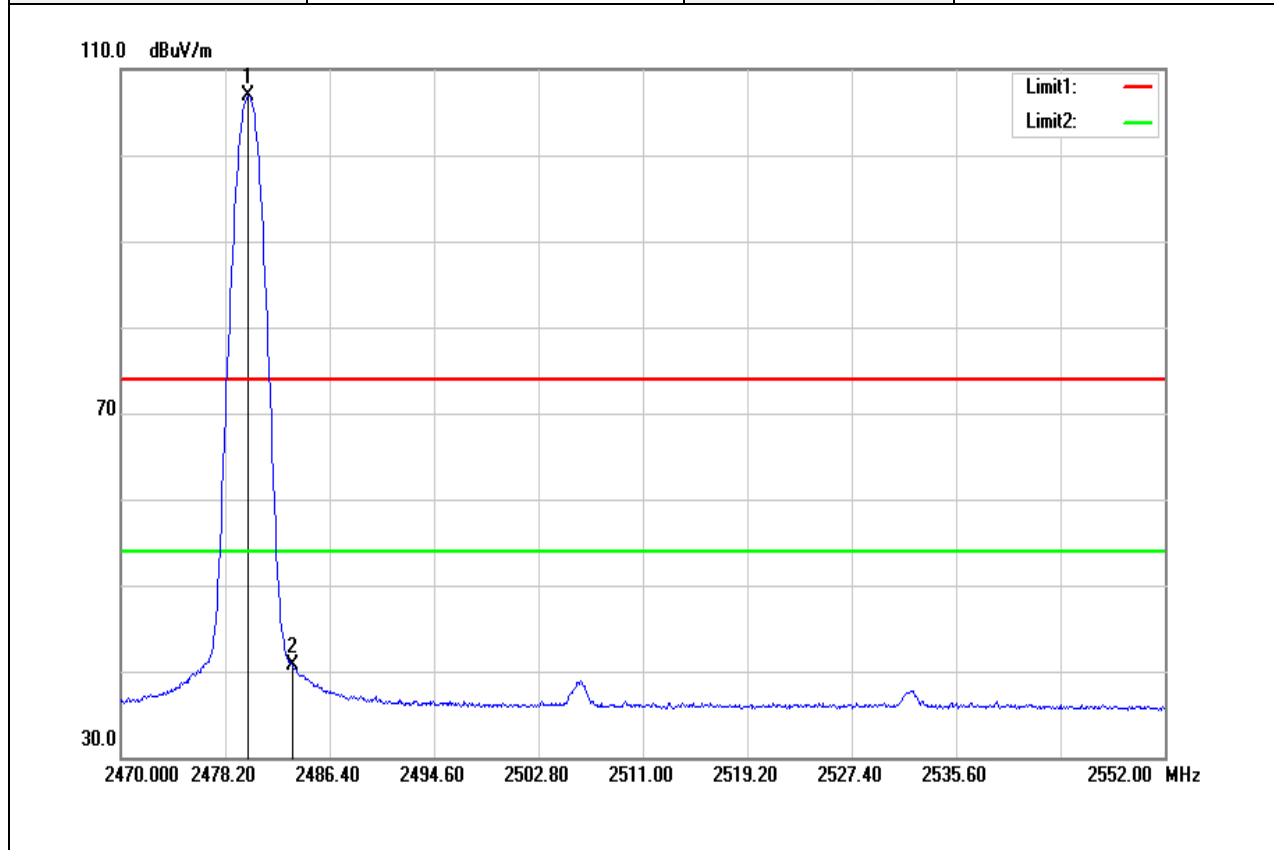

No.	Frequency (MHz)	Reading (dBuV)	Correct Factor(dB/m)	Result (dBuV/m)	Limit (dBuV/m)	Margin (dB)	Remark
1	2480.004	109.54	-2.70	106.84	--	--	AVG
2	2483.500	43.30	-2.69	40.61	54.00	-13.39	AVG

**Below 1G Test Data**

Test Mode:	BT Mode	Temp/Hum	22(°C)/ 34%RH
Test Item	30MHz-1GHz	Test Date	March 5, 2018
Polarize	Vertical	Test Engineer	Jerry Chuang
Detector	Peak	Test Voltage:	AC 120V

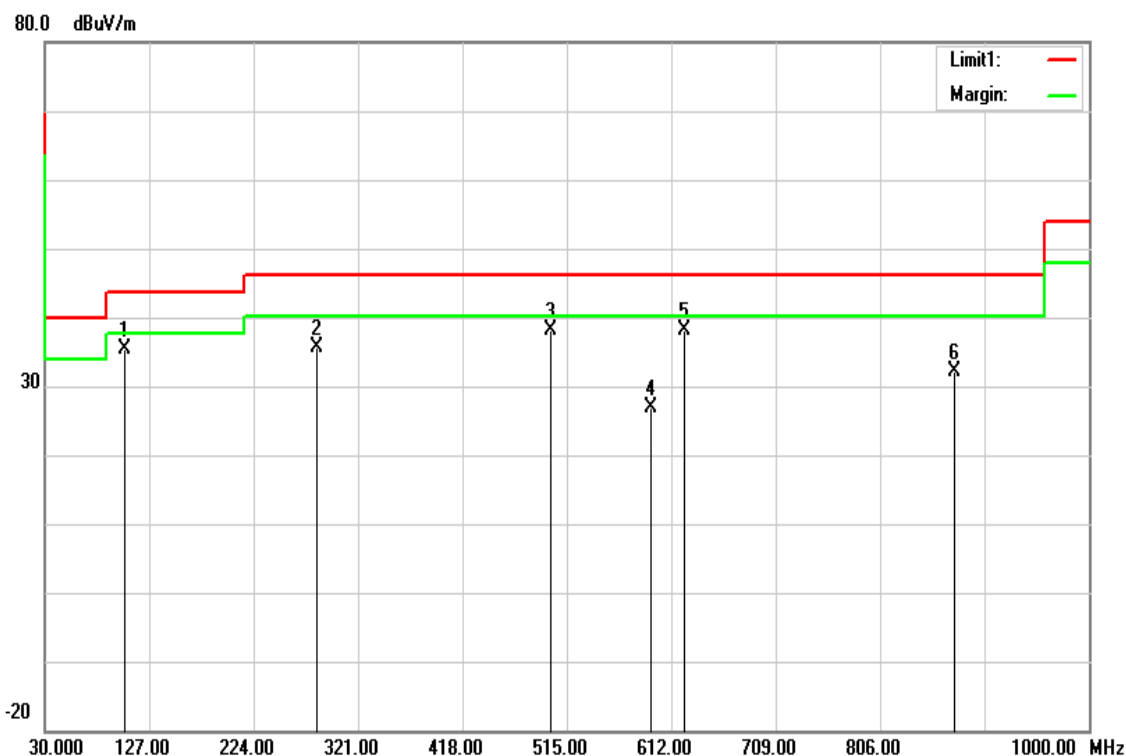

No.	Frequency (MHz)	Reading (dBuV)	Correct Factor(dB/m)	Result (dBuV/m)	Limit (dBuV/m)	Margin (dB)	Remark
1	104.6900	53.00	-17.73	35.27	43.52	-8.25	peak
2	283.1700	49.83	-14.24	35.59	46.02	-10.43	peak
3	500.4500	46.64	-8.48	38.16	46.02	-7.86	peak
4	593.5700	33.89	-7.01	26.88	46.02	-19.14	peak
5	624.6100	44.35	-6.25	38.10	46.02	-7.92	peak
6	874.8700	34.64	-2.44	32.20	46.02	-13.82	peak

**Note:** No emission found between lowest internal used/generated frequency to 30MHz(9KHz~30MHz)

Test Mode:	BT Mode	Temp/Hum	22(°C)/ 34%RH
Test Item	30MHz-1GHz	Test Date	March 5, 2018
Polarize	Horizontal	Test Engineer	Jerry Chuang
Detector	Peak	Test Voltage:	AC 120V

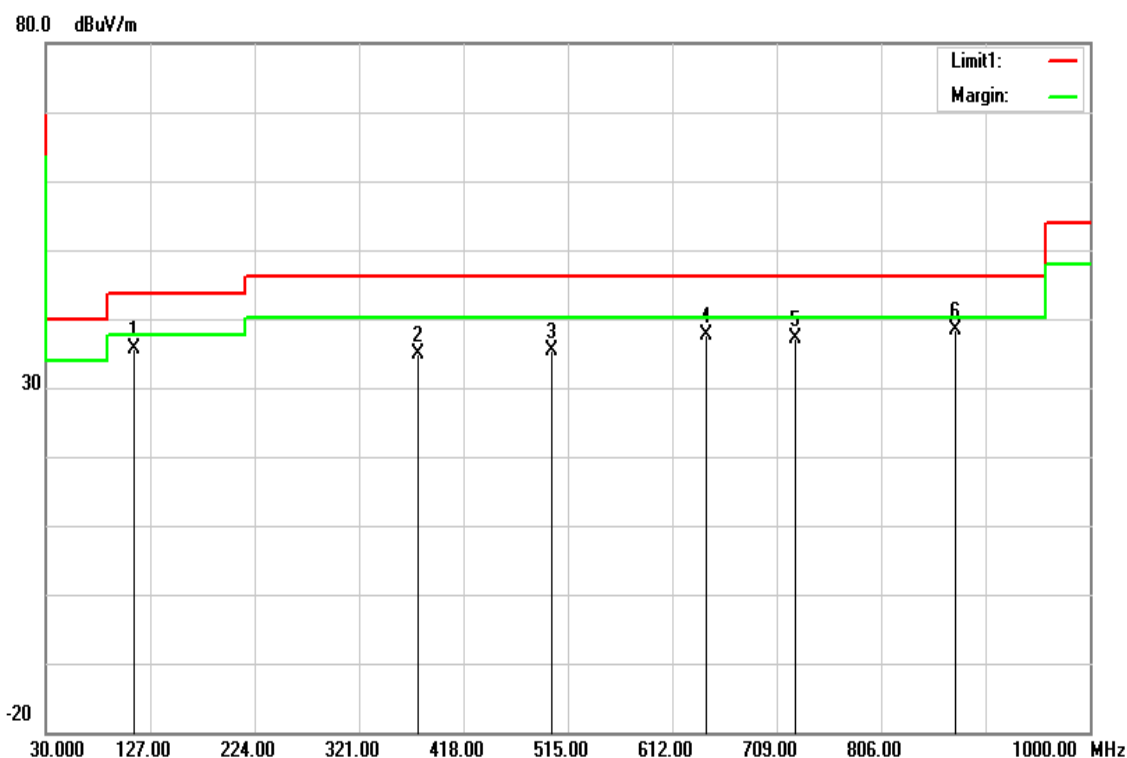

No.	Frequency (MHz)	Reading (dBuV)	Correct Factor(dB/m)	Result (dBuV/m)	Limit (dBuV/m)	Margin (dB)	Remark
1	111.4800	52.20	-16.52	35.68	43.52	-7.84	peak
2	375.3200	46.94	-12.17	34.77	46.02	-11.25	peak
3	500.4500	43.78	-8.48	35.30	46.02	-10.72	peak
4	643.0400	43.26	-5.74	37.52	46.02	-8.50	peak
5	726.4600	41.70	-4.57	37.13	46.02	-8.89	peak
6	874.8700	40.86	-2.44	38.42	46.02	-7.60	peak

**Note:** No emission found between lowest internal used/generated frequency to 30MHz(9KHz~30MHz)

**Above 1G Test Data**

Test Mode:	BLE Low CH	Temp/Hum	22(°C)/ 34%RH
Test Item	Harmonic	Test Date	March 7, 2018
Polarize	Vertical	Test Engineer	Jerry Chuang
Detector	Peak	Test Voltage	AC 120V

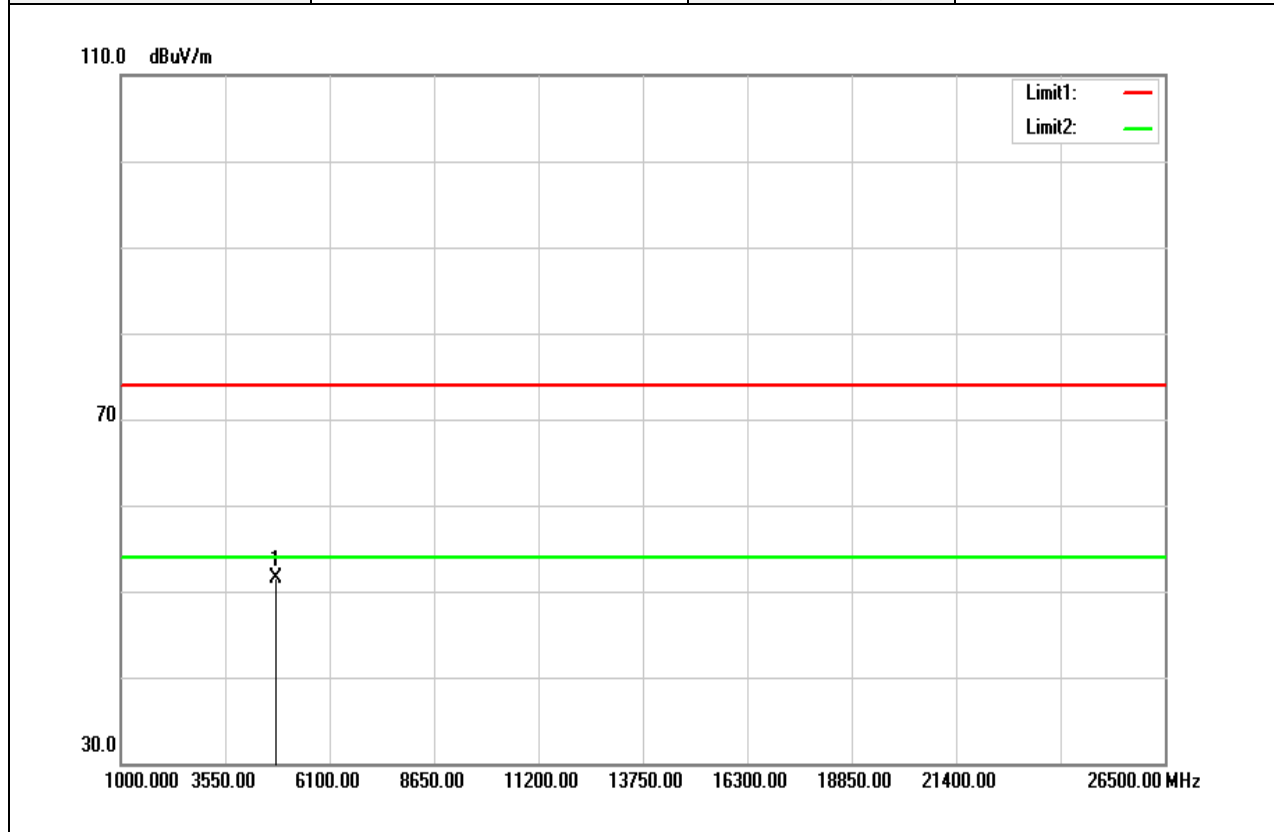

No.	Frequency (MHz)	Reading (dBuV)	Correct Factor(dB/m)	Result (dBuV/m)	Limit (dBuV/m)	Margin (dB)	Remark
1	4802.000	47.27	4.33	51.60	74.00	-22.40	peak

**Remark:**

1. Measuring frequencies from 1 GHz to the 10th harmonic of highest fundamental frequency.
2. For above 1GHz, the EUT peak value was under average limit, therefore the Average value compliance with the average limit

Test Mode:	BLE Low CH	Temp/Hum	22(°C)/ 34%RH
Test Item	Harmonic	Test Date	March 7, 2018
Polarize	Horizontal	Test Engineer	Jerry Chuang
Detector	Peak	Test Voltage	AC 120V

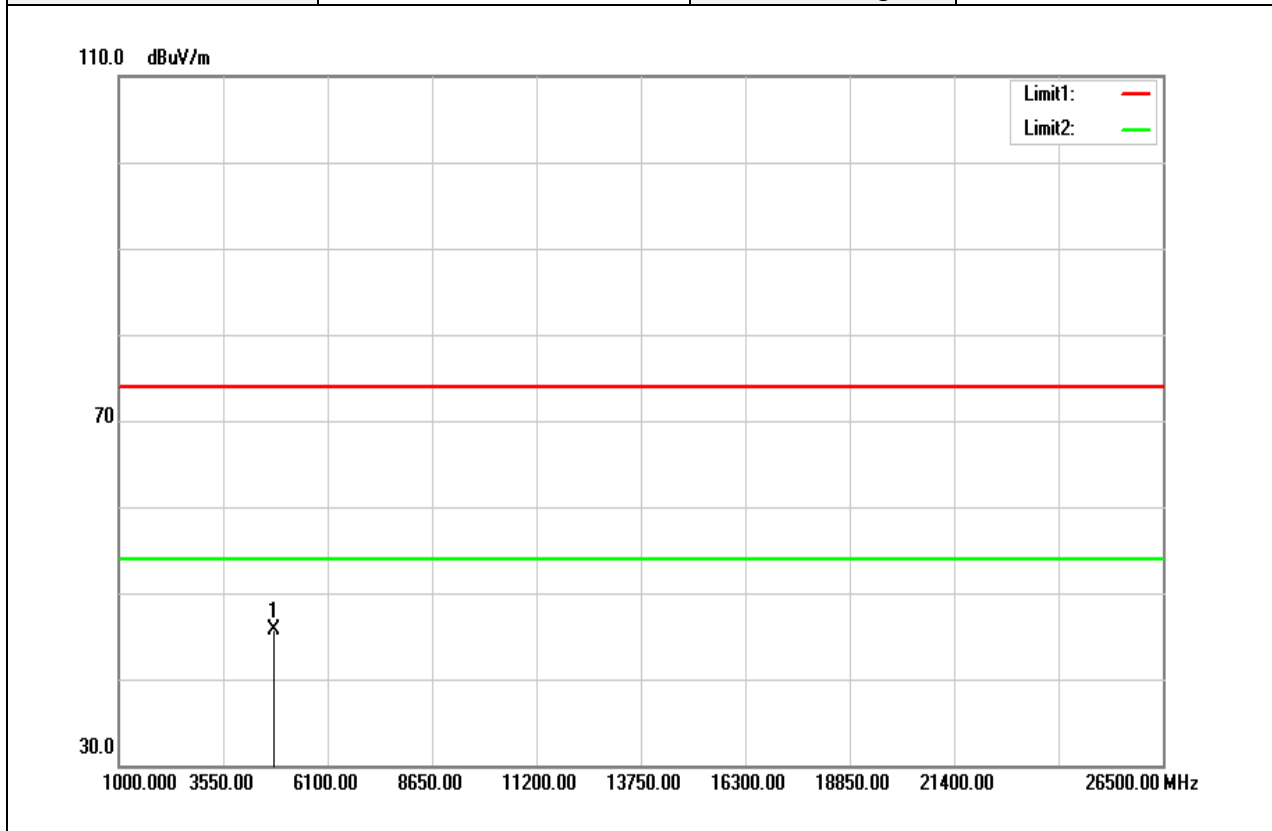

No.	Frequency (MHz)	Reading (dBuV)	Correct Factor(dB/m)	Result (dBuV/m)	Limit (dBuV/m)	Margin (dB)	Remark
1	4806.000	41.29	4.35	45.64	74.00	-28.36	peak

**Remark:**

1. Measuring frequencies from 1 GHz to the 10th harmonic of highest fundamental frequency.
2. For above 1GHz, the EUT peak value was under average limit, therefore the Average value compliance with the average limit

Test Mode:	BLE Mid CH	Temp/Hum	22(°C)/ 34%RH
Test Item	Harmonic	Test Date	March 7, 2018
Polarize	Vertical	Test Engineer	Jerry Chuang
Detector	Peak	Test Voltage	AC 120V

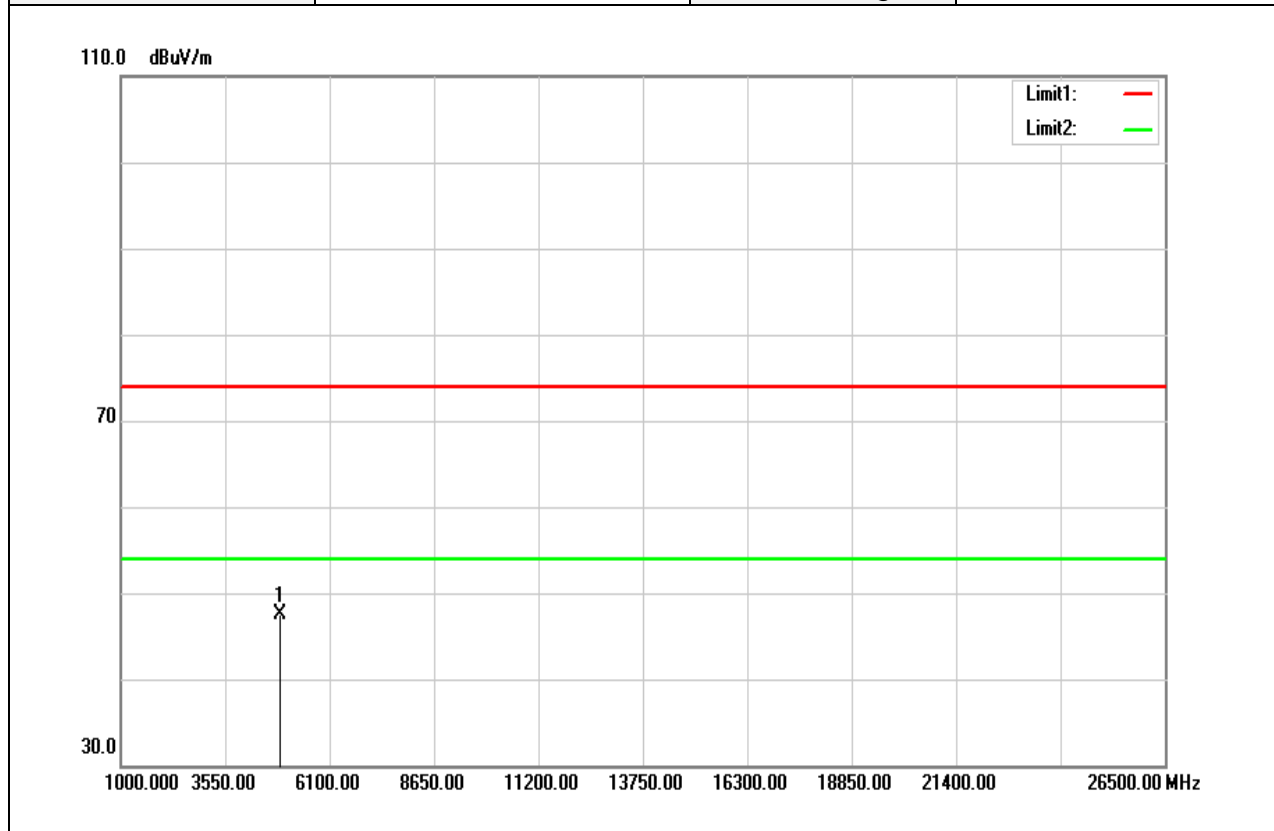

No.	Frequency (MHz)	Reading (dBuV)	Correct Factor(dB/m)	Result (dBuV/m)	Limit (dBuV/m)	Margin (dB)	Remark
1	4879.000	43.01	4.47	47.48	74.00	-26.52	peak

**Remark:**

1. Measuring frequencies from 1 GHz to the 10th harmonic of highest fundamental frequency.
2. For above 1GHz, the EUT peak value was under average limit, therefore the Average value compliance with the average limit

Test Mode:	BLE Mid CH	Temp/Hum	22(°C)/ 34%RH
Test Item	Harmonic	Test Date	March 7, 2018
Polarize	Horizontal	Test Engineer	Jerry Chuang
Detector	Peak	Test Voltage	AC 120V

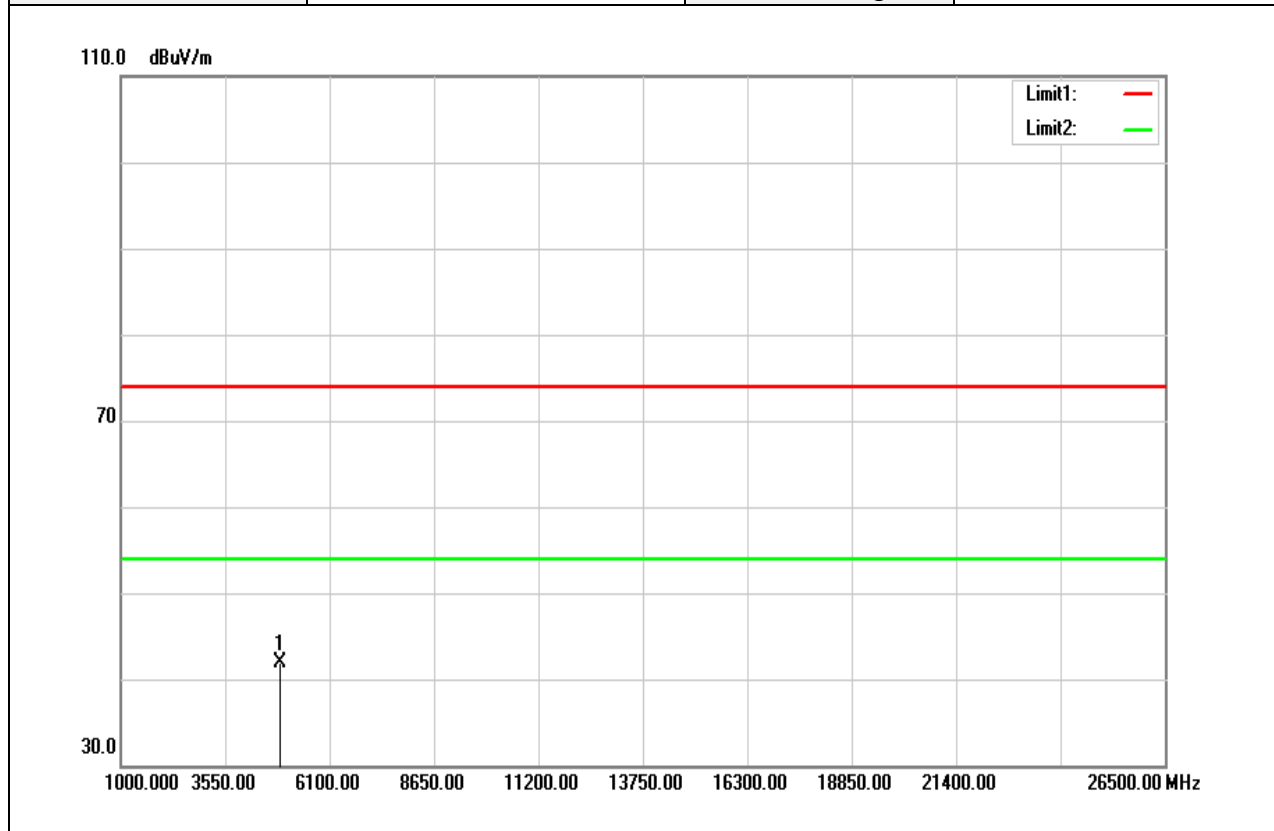

No.	Frequency (MHz)	Reading (dBuV)	Correct Factor(dB/m)	Result (dBuV/m)	Limit (dBuV/m)	Margin (dB)	Remark
1	4880.000	37.42	4.48	41.90	74.00	-32.10	peak

**Remark:**

1. Measuring frequencies from 1 GHz to the 10th harmonic of highest fundamental frequency.
2. For above 1GHz, the EUT peak value was under average limit, therefore the Average value compliance with the average limit



Test Mode:	BLE High CH	Temp/Hum	22(°C)/ 34%RH
Test Item	Harmonic	Test Date	March 7, 2018
Polarize	Vertical	Test Engineer	Jerry Chuang
Detector	Peak	Test Voltage	AC 120V

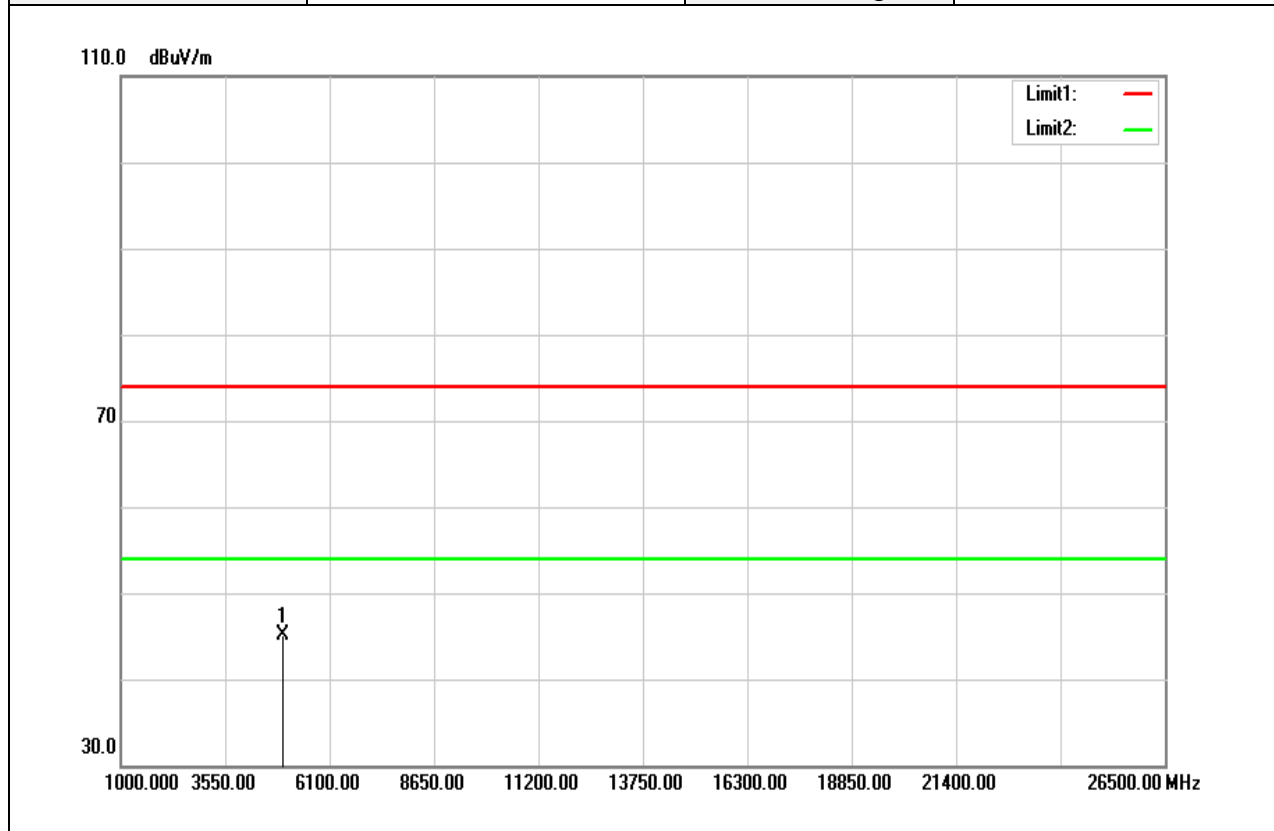

No.	Frequency (MHz)	Reading (dBuV)	Correct Factor(dB/m)	Result (dBuV/m)	Limit (dBuV/m)	Margin (dB)	Remark
1	4960.000	40.55	4.61	45.16	74.00	-28.84	peak

**Remark:**

1. Measuring frequencies from 1 GHz to the 10th harmonic of highest fundamental frequency.
2. For above 1GHz, the EUT peak value was under average limit, therefore the Average value compliance with the average limit

Test Mode:	BLE High CH	Temp/Hum	22(°C)/ 34%RH
Test Item	Harmonic	Test Date	March 7, 2018
Polarize	Horizontal	Test Engineer	Jerry Chuang
Detector	Peak	Test Voltage	AC 120V

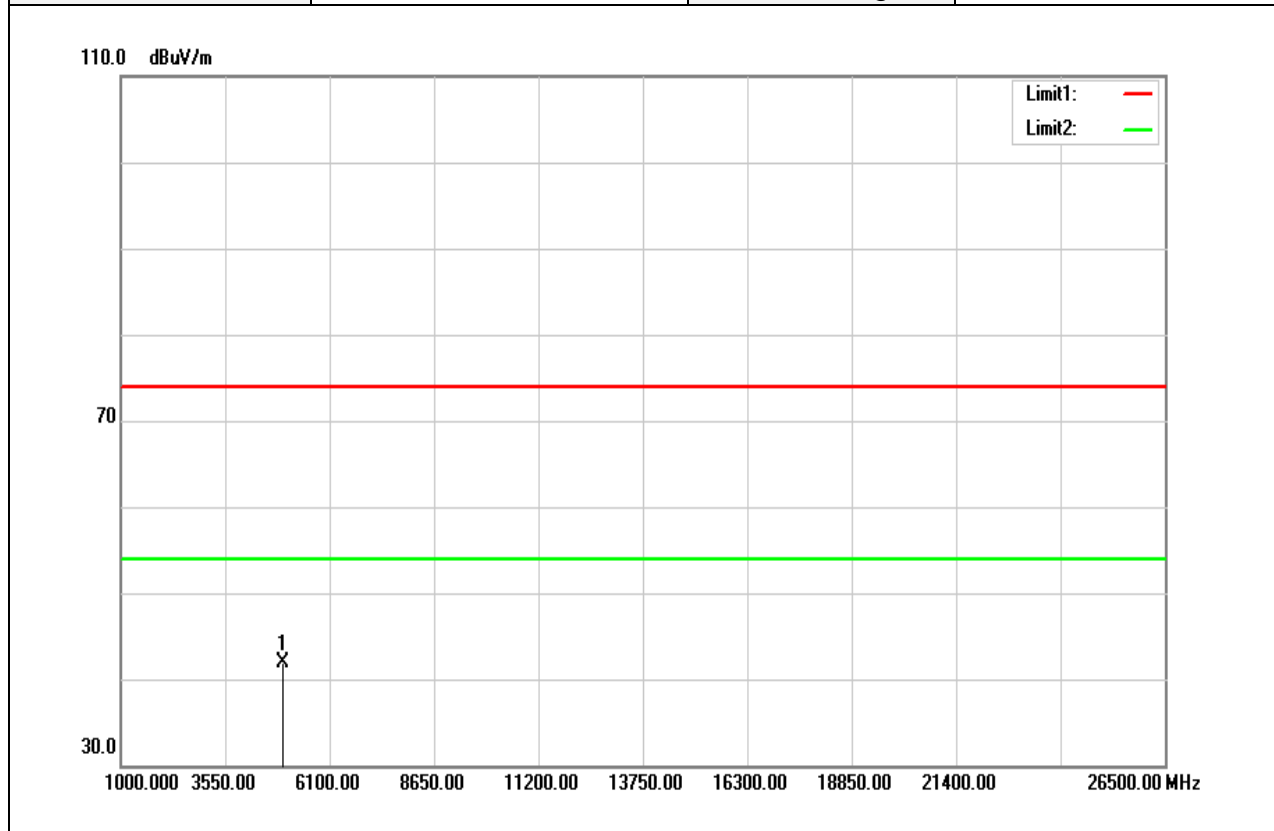

No.	Frequency (MHz)	Reading (dBuV)	Correct Factor(dB/m)	Result (dBuV/m)	Limit (dBuV/m)	Margin (dB)	Remark
1	4960.000	37.35	4.61	41.96	74.00	-32.04	peak

**Remark:**

1. Measuring frequencies from 1 GHz to the 10th harmonic of highest fundamental frequency.
2. For above 1GHz, the EUT peak value was under average limit, therefore the Average value compliance with the average limit