

Hisense

PARTY SPEAKER

Model: Party Rocker One
Party Rocker One Plus

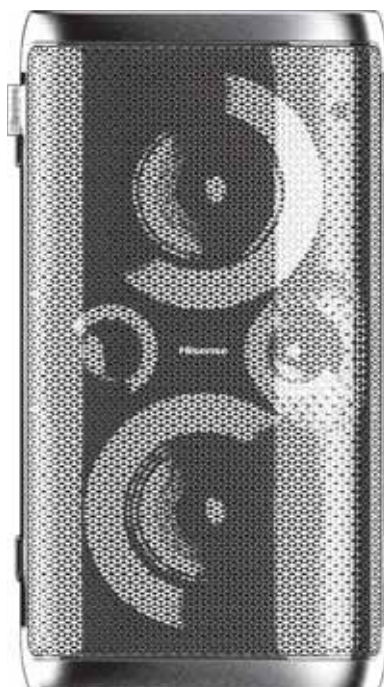

USER MANUAL



Read all the safety instructions carefully before use and keep this instruction manual for future reference

EN

Contents

Important Safety Instructions	2
Features	5
Package Contents	5
Product Diagram	6
Top View	6
Rear View	7
Connections	8
Connect Power	8
AUX IN/AUX OUT Socket	8
MIC Socket	9
GUITAR Socket	9
WIRELESS MICROPHONE CONNECTION (Only for Party Rocker One Plus)	10
Basic Operation	11
Standby/ON	11
DJ Effect	11
Select Modes	11
Adjust the Volume	11
Preset Equalizer	11
Bass settings	11
Adjust the LED light	11
AUX IN Operation	11
WIRELESS CHARGING	11
Bluetooth Operation	12
Pair Bluetooth-enabled Devices	12
Listen to Music from Bluetooth Device	12
TWS Connection	12
USB Operation	13
USB Operation	13
Charging from the USB Port	13
FM Radio Operation	14
Battery Charging For Party Speaker	14
Built-in Battery Charging	14
Troubleshooting	15
Specifications	16

EN

Important Safety Instructions

EN

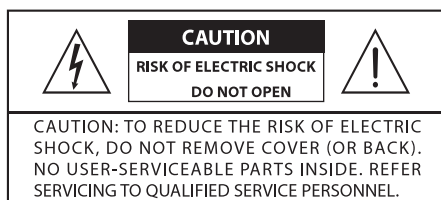

The lightning flash with arrowhead symbol, within an equilateral triangle, is intended to alert the user to the presence of uninsulated "dangerous voltage" within the product's enclosure that may be of sufficient magnitude to constitute a risk of electric shock to persons.



The exclamation point within an equilateral triangle is intended to alert the user to the presence of important operating and maintenance (servicing) instructions in the literature accompanying the appliance.

Safety

- 1 Read these instructions – All the safety and operating instructions should be read before this product is operated.
- 2 Keep these instructions – The safety and operating instructions should be retained for future reference.
- 3 Heed all warnings – All warnings on the appliance and in the operating instructions should be adhered to.
- 4 Follow all instructions – All operating and use instructions should be followed.
- 5 Do not use this apparatus near water – The appliance should not be used near water or moisture – for example, in a wet basement or near a swimming pool, and the like.
- 6 Clean only with dry cloth.
- 7 Do not block any ventilation openings. Install in accordance with the manufacturer's instructions.
- 8 Do not install near any heat sources such as radiators, heat registers, stoves, or other apparatus (including amplifiers) that produce heat.
- 9 Danger of explosion if battery is incorrectly replaced. Replace only with the same or equivalent type.
- 10 Do not defeat the safety purpose of the polarized or grounding plug. A polarized

plug has two blades with one wider than the other. A grounding plug has two blades and a third grounding prong. The wide blade or the third prong is provided for your safety. If the provided plug does not fit into your outlet, consult an electrician for replacement of the obsolete outlet.

- 11 Protect the power cord from being walked on or pinched particularly at the plugs, convenience receptacles, and at the point where they exit from the apparatus.
- 12 Only use attachments/accessories specified by the manufacturer.
- 13 Use only with the cart, stand, tripod, bracket, or table specified by the manufacturer, or sold with the apparatus. When a cart or rack is used, use caution when moving the cart/apparatus combination to avoid injury from tip-over.
- 14 Unplug the apparatus during lightning storms or when unused for long periods of time.
- 15 Refer all servicing to qualified personnel. Servicing is required when the apparatus has been damaged in any way, such as power supply cord or plug is damaged, liquid has been spilled or objects have fallen into the apparatus has been exposed to rain or moisture, does not operate normally, or has been dropped.
- 16  This equipment is a Class II or double insulated electrical appliance. It has been designed in such a way that it does not require a safety connection to electrical earth.
- 17 To reduce the risk of fire or electric shock, do not expose this apparatus to rain or moisture. The apparatus must not be exposed to dripping or splashing and objects filled with liquids, such as vases, must not be placed on apparatus.
- 18 The mains plug is used as the disconnect device, the disconnect device shall remain readily operable.

Warning

- The battery (batteries or battery pack) shall not be exposed to excessive heat such as sunshine, fire or the like.
- These servicing instructions are for use by qualified service personnel only. To reduce the risk of electric shock, do not perform

Important Safety Instructions



The Bluetooth® word mark and logos are registered trademarks owned by Bluetooth SIG, Inc. We are the licensee to use such marks. Other trademarks and trade names are those of their respective owners.

EN

any servicing other than that contained in the operating instructions unless you are qualified to do so.

- Avoid foreign bodies and liquids entering the device.
- Do not place open e.g. lit candles, on or directly adjacent to the device.
- Do not use any corrosive or abrasive cleaning agents. These could damage the surface of the device.
- Please refer the information on exterior bottom or rear enclosure for electrical and safety information before installing or operating the apparatus.
- Minimum distance around the apparatus for sufficient ventilation is 5cm;
- The ventilation should not be impeded by covering the ventilation openings with items such as newspaper, table-cloths, curtains etc.
- No naked flame sources such as lighted candles should be placed on the apparatus;
- Batteries should be recycled or disposed of as per state and local guidelines;
- The use of apparatus in moderate or tropical climates.
- The marking label is pasted on the bottom or back of the equipment.

WARNING

DO NOT INGEST BATTERY, CHEMICAL BURN HAZARD

If you think batteries might have been swallowed or placed inside any part of the body, seek immediate medical attention. Keep new and used batteries away from children. If the battery compartment does not close securely, stop using the product and keep it away from children. The remote control supplied with this product contains a coin/button cell battery. If the coin/button cell battery is swallowed, it can cause severe internal burns in just 2 hours and lead to death.



Correct Disposal of this product. This marking indicates that this product should not be disposed with other household wastes throughout the EU.

To prevent possible harm to the environment or human health from uncontrolled waste disposal, recycle it responsibly to promote the sustainable reuse of material resources. To return your used device, please use the return and collection systems or contact the retailer where the product was purchased. They can take this product for environmental safe recycling.

FCC INFORMATION (for US customers)

Warning:

Any Changes or modifications not expressly approved by the party responsible for compliance could void the user's authority to operate the equipment.

NOTE:

- This equipment has been tested and found to comply with the limits for a Class B digital device, pursuant to Part 15 of the FCC Rules. These limits are designed to provide reasonable protection against harmful interference in a residential installation. This equipment generates, uses and can radiate radio frequency energy and, if not installed and used in accordance with the instructions, may cause harmful interference to radio communications.
- However, there is no guarantee that interference will not occur in a particular installation. If this equipment does cause harmful interference to radio or television reception, which can be determined by turning the equipment off and on, the user is encouraged to try to correct the interference by one or more of the following measures:
 - Reorient or relocate the receiving antenna.
 - Increase the separation between the equipment and receiver.
 - Connect the equipment into an outlet on a circuit different from that to which the receiver is connected.
 - Consult the dealer or an experienced radio / TV technician for help.
- This device complies with Part 15 of the FCC Rules. Operation is subject to the following two conditions:
 - (1) this device may not cause harmful interference, and
 - (2) this device must accept any interference received, including interference that may cause undesired operation.
- Shielded cables must be used with this unit to ensure compliance with the Class B FCC limits.

Important Safety Instructions

EN

IC Caution

This device contains licence-exempt transmitter(s)/receiver(s) that comply with Innovation, Science and Economic Development Canada's licence-exempt RSS(s). Operation is subject to the following two conditions:

- (1) This device may not cause interference.
- (2) This device must accept any interference, including interference that may cause undesired operation of the device.

French:

Cet appareil contient un (s) émetteur (s) / récepteur (s) exempté (s) de licence (s) conforme à l'innovation, à la science et au développement économique Canada exempte (s) RSS (s). L'opération est soumise aux deux conditions suivantes:

- (1) Cet appareil peut ne pas causer d'interférence.
- (2) Cet appareil doit accepter toute interférence, y compris les interférences pouvant entraîner un fonctionnement indésirable de l'appareil.

RF warning for Portable device:

- The device has been evaluated to meet general RF exposure requirement. The device can be used in portable exposure condition without restriction.

RF warning for Mobile device:

- This equipment complies with FCC radiation exposure limits set forth for an uncontrolled environment. This equipment should be installed and operated with minimum distance 20cm between the radiator & your body.

RED

- Hereby, Hisense International Co., Ltd. declares that the radio equipment type Party Rocker One is in compliance with Directive 2014/53/EU. The full text of the EU declaration of conformity is available at the following internet address:
<https://hisense.fr>
<https://hisense.de>

UKCA

- Hereby, Hisense International Co., Ltd. declares that the radio equipment type Party Rocker One is in compliance with Radio Equipment Regulations 2017. The full text of the EU declaration of conformity is available at the following internet address:
<https://hisense.co.uk>

Features

Thanks for your purchase of our product. Please read through this manual before making connections and operating this product. Retain this manual for future reference.

- Bluetooth playback
- AUX IN
- FM tuner
- USB slot
- Microphone function
- Guitar function
- Multiple EQ sound effect mode

EN

Package Contents



Main Unit

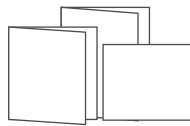

User Manual
Quick Start Guide
Warranty Card



* AC power cord



Wireless Microphone x2
(Only for Party Rocker One Plus)

*Power cord quantity and plug type vary by regions.





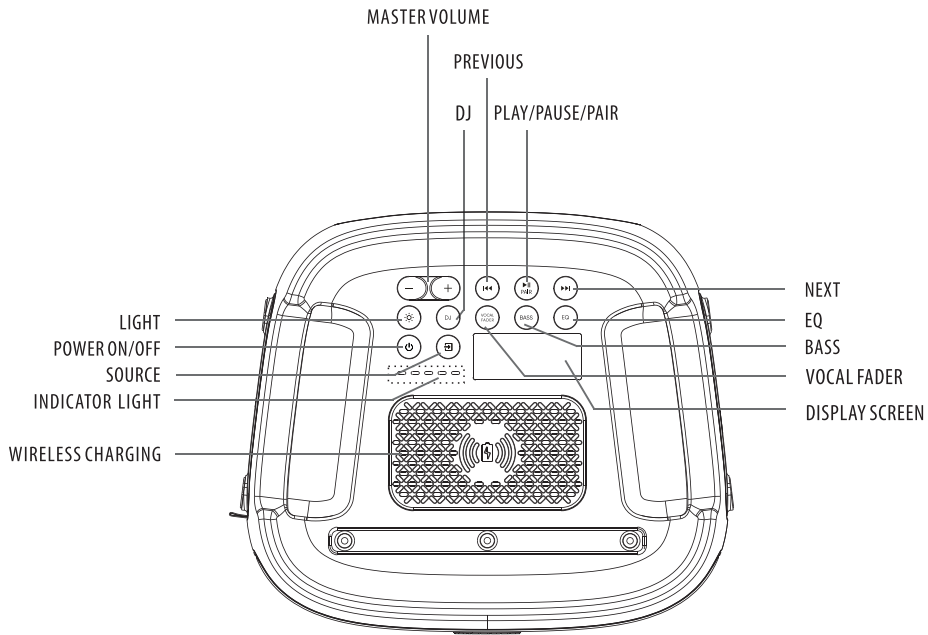

Product Diagram

Top View

EN



Party Rocker One Port

LIGHT 	Select the different lighting mode of LED indicator
POWER ON/OFF 	Power on/off
SOURCE 	Select a play function
INDICATOR LIGHT	Built-in battery charging indicator
WIRELESS CHARGING	Wireless charging
MASTER VOLUME 	Increase/Decrease the volume level
DJ	DJ effect
PREVIOUS 	Press to the previous track
PLAY/PAUSE/PAIR 	Play/Pause/Pair playback
NEXT 	Press to the next track
EQ	Equalizer manual mode
BASS	ON/OFF the BASS mode
VOCAL FADER	Switch between vocal fader on and vocal fader off
DISPLAY SCREEN	Display screen

Product Diagram

Rear View

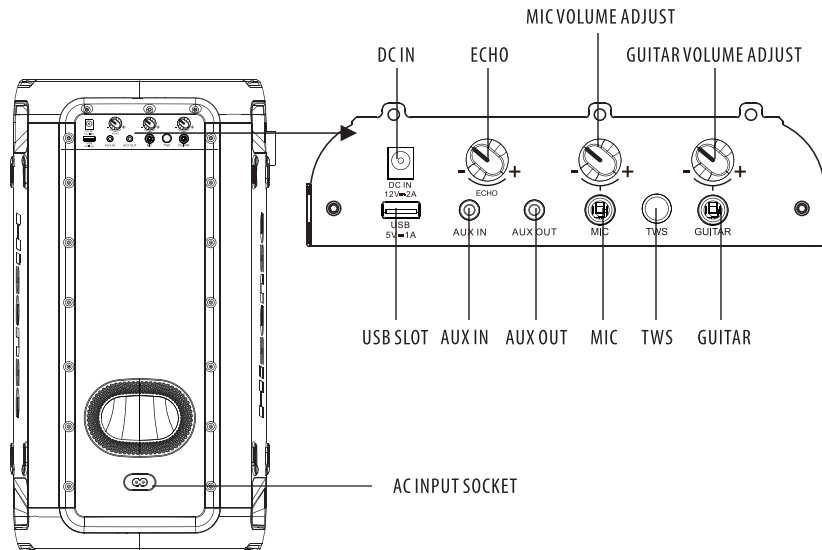

EN

Party Rocker One Port

DC IN	DC input socket(Only available for vehicle DC power adapter)
ECHO	Increase/decrease the mic echo volume level
MIC VOLUME ADJUST	Increase/decrease the mic volume level
GUITAR VOLUME ADJUST	Increase/decrease the guitar volume level
USB SLOT	USB slot
AUX IN	AUX input socket
AUX OUT	AUX output socket
MIC	MIC socket
TWS	Press to enter TWS pairing mode
GUITAR	Guitar socket
AC INPUT SOCKET	AC power socket

Connections

Connect Power

EN

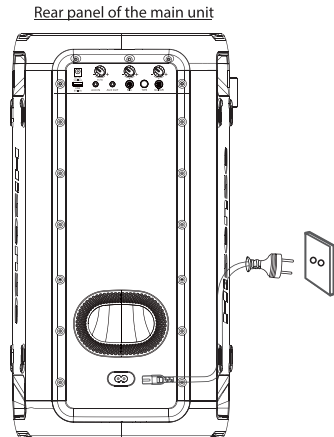

Risk of product damage!

Ensure that the power supply voltage corresponds to the voltage printed on the back or the underside of the unit.
-Insert the AC power cord into a mains socket .

AUX IN Socket

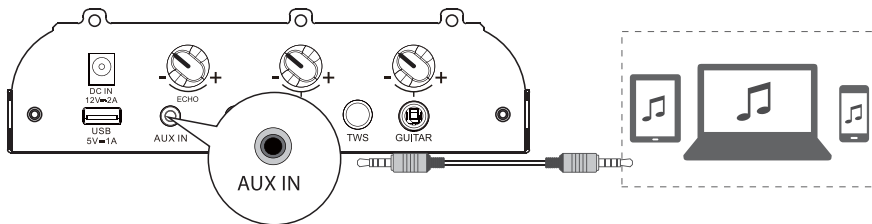

This unit has a audio input terminal. You can input the analogue stereo audio signals from extra devices such as VCD, CD, VCR, MP3 player, etc.
Use the audio cable with a 3.5mm(not supplied) connector to connect the input terminal **AUX IN** on the rear panel of the unit, press  button to select **AUX IN** mode.

AUX OUT Socket

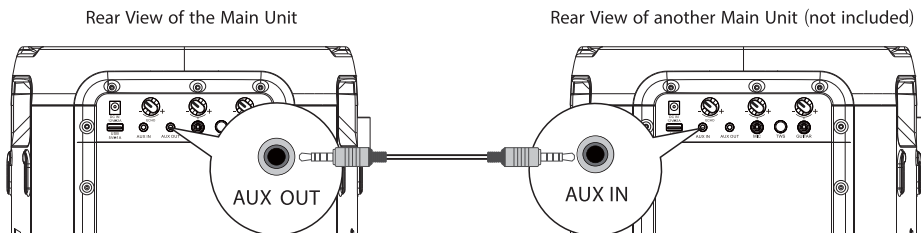

This unit has a **AUX OUT** jack. You can output the analog stereo audio signals to external devices such as an active speaker.
Connect an audio cable (not supplied) to the **AUX OUT** jack on the rear panel of the unit and the **AUX IN** jack of the external device, and the unit will output audio automatically to the external device.

Connections

MIC Socket

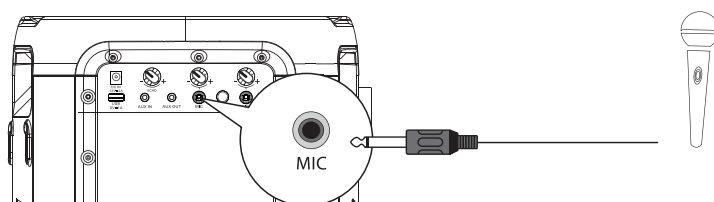

EN

Insert the microphone into the microphone socket on the rear panel and adjust to a low level using the microphone volume knob on the rear panel.

Adjust the microphone volume level to your desired level using the microphone volume knob on the rear panel.

Now, enjoy the karaoke singing!

GUITAR Socket

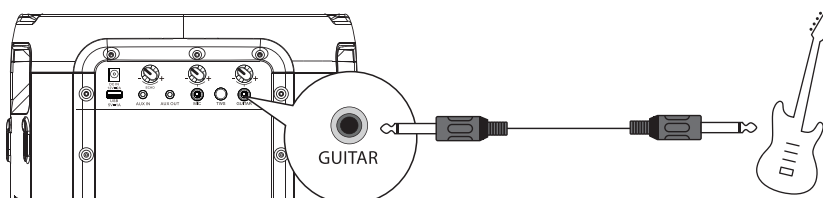

Insert the guitar cable into the guitar socket on the rear panel.

Now, enjoy yourself!

WIRELESS MICROPHONE CONNECTION (Only for Party Rocker One Plus)

Connecting Microphone

To connect the supplied wireless microphone
By default, the wireless microphone comes pre-paired with the speaker at factory.

EN

1. Load the two Alkaline AA batteries with correct polarity.

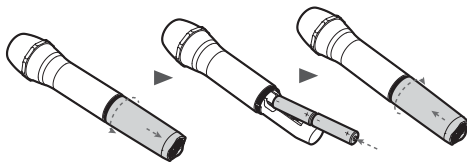

2. Turn on the speaker and supplied wireless microphone successively.
- Wireless connection will be set up automatically.

Notes:

- The microphone powers off automatically after 20 minutes of inactivity.
- A maximum of two wireless microphones are supported.

To replace wireless microphone batteries

Cautions:

- Do not mix batteries (old and new or carbon and alkaline, etc.).
- Remove batteries if they are exhausted or if the microphone is not to be used for a long time.
- Batteries contain chemical substances, they should be disposed of properly.

1. Low battery prompt.

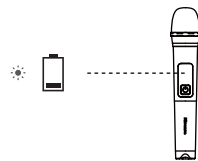

⚡ Indicator blinking red

2.If the battery level is low, replace the old batteries with new ones.

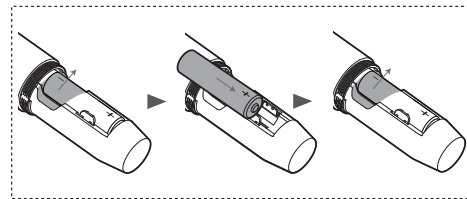
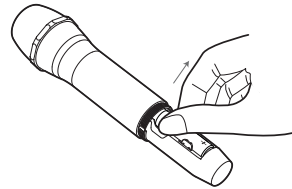

Connecting

- ⚡ pairing(The indicator blinking blue)
- connected(The indicator keep solid blue)

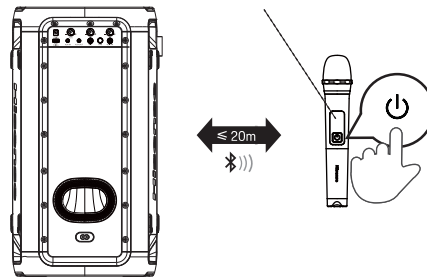

Press the  button on the top panel of the unit to switch on the unit.

Press the  button on the wireless microphone to switch on the wireless microphone, the indicator on the wireless microphone will blink blue and the wireless microphone pair with the unit automatically, once paired successfully, the indicator on the wireless microphone will keep solid blue.

Adjust the microphone volume level to your desired level using the microphone volume knob on the rear panel.

Note: when the battery of the wireless microphone is in low battery state, the indicator on the wireless microphone blinks red and need to replace the old batteries in wireless microphone battery compartment with new ones.

Basic Operation

Standby/ON

- Press the  button on the unit to switch the main unit ON, Press and hold for 2 seconds to OFF.
- Disconnect the main plug from the main socket if you want to switch the unit off completely.
- When there is no input signal from the unit more than 15 minutes, it will switch to Standby mode automatically.

EN

DJ Effect

- Press the DJ button to the select different DJ effect.
- Press the DJ key once to play the current DJ. When you press the DJ continuously within 1 second, cycle to select different DJ sound effects. Press the DJ key for 1 second to start playing the current DJ sound effects after no operation;
- DJ sound effect types: DJ1 cheering sound, DJ2 drum sound, DJ3 alarm sound, DJ4 horn sound, DJ5 disc playing sound.

Select Modes

- Press the  button on the unit to select the play function BT→USB→AUX IN→FM mode.

Adjust the Volume

- Press the **VOL+/VOL-** button on the unit to adjust the volume.



Preset Equalizer

- During play, press the EQ button repeatedly to select: ROCK-JAZZ-SAMBA-POP-BALANCE.

Bass settings

- Press BASS button to select BASS ON / BASS OFF.

Adjust the LED light

- Press the  button repeatedly to select the LED effect: LED OFF, LED1, LED2, LED3, LED4, LED5.
- Press and hold  to switch ON/OFF the strobe light

AUX IN Operation

- 1 Ensure that the unit is connected to the TV or the other audio devices.
- 2 Press the  button on the unit to select the **AUX IN** mode.
- 3 Operate your audio device directly for playback features.
- 4 Press the **VOL+/VOL-** button to adjust the volume to your desired level.

WIRELESS CHARGING

The party speaker can charge wireless charging compatible phones by placing your phone on top of the wireless charging logo of the party speaker. The charging icon on display is on while charging.

Bluetooth Operation

Pair Bluetooth-enabled Devices

The first time you connect your Bluetooth device to this player, you need to pair your device to this player.

Note:

EN

- The operational range between this player and a Bluetooth device is approximately 8 meters (without any object between the Bluetooth device and the unit).
 - Before you connect a Bluetooth device to this unit, ensure you know the device's capabilities.
 - Compatibility with all Bluetooth devices is not guaranteed.
 - Any obstacle between this unit and a Bluetooth device can reduce the operational range.
 - If the signal strength is weak, your Bluetooth receiver may disconnect, but it will re-enter pairing mode automatically.
- 1 Press the  on the unit to select **Bluetooth** mode.
 - 2 The word "**PAIRING**" will be shown on the display screen, the system has entered pairing mode.
 - 3 Activate your Bluetooth device and select the search mode. "**Hisense Party Rocker One**" or "**Hisense Party Rocker One Plus**" will appear on your Bluetooth device.
 - 4 Select "**Hisense Party Rocker One**" or "**Hisense Party Rocker One Plus**" in the pairing list, the system is successfully connected and the word "**CONNECTED**" will scroll show on the display screen.
 - 5 Begin playing music from the connected Bluetooth device.

To disconnect the Bluetooth function, you can :

- Switch to another function on the unit.
- Disable the Bluetooth function on your device.
- Press and hold the "**▶||**" button on the unit.

Tips:

- Enter "0000" for the password if necessary.
- The player will also be disconnected when your device is moved beyond the operational range.
- If you want to reconnect your device to this player, place it within the operational range.
- If the device is moved beyond the operational range, when it is brought back, please check if the device is still connected to the player.
- If the connection is lost, follow the instructions above to pair your device to the player again.

Listen to Music from Bluetooth Device

If your Bluetooth device supports A2DP, play music via your device.

- To pause/resume playback, press **▶||** .
- To skip to a track, press **◀◀** or **▶▶** .
- Press the **VOL+/-** button to increase or decrease the volume.

TWS Connection



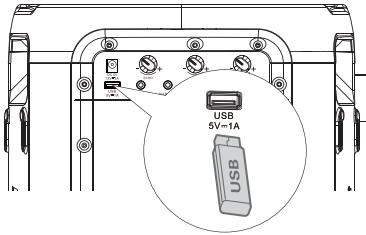

- This **TWS**(TRUE WIRELESS STEREO) bluetooth connection only use between the same two speakers.
- Power on both speakers, press  button on the both speakers to switch to bluetooth mode,press **TWS** button on the one of both speakers,the display screen of the speaker scroll display **TWS ON**, and then scroll display **TWS PAIRING** ,the both speakers enter the pairing state automatically, once paired successfully, one scrolls display **MASTER** on the display of the speaker is configured as the master ,the other displays **SLAVE** on the display of the speaker is configured as the slave .
- Enable your bluetooth device and make sure it is in searching mode.
- Select "**Hisense Party Rocker One**" or "**Hisense Party Rocker One Plus**" from the list of discovered devices and connect to it.
- The master speaker will act as the left channel during **TWS** and will receive the bluetooth signal,the other speaker will act as the right channel to play music.
- Press and hold **TWS** button to disconnect the **MASTER** and the **SLAVE** speaker connection in **TWS** connection mode,the display screen of the both speakers scroll display **TWS OFF**.

USB Operation

USB Operation





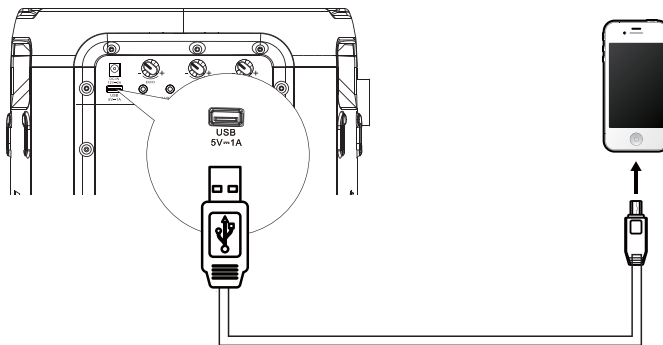

EN

- 1 Insert the USB device and press  button to select USB mode.
- 2 Play starts automatically. If play does not start automatically, press  button.
 - To skip to the previous/next track, press the  buttons on the unit.
 - To skip to the previous/next folder, press and hold  buttons on the unit.
- 3 In PLAY/PAUSE state, press and hold  button for 3 seconds to switch among in REPEAT 1/REPEAT ALL/RANDOM/NORMAL.

Charging from the USB Port





The Charging  **5V**  1A socket is designed for charging mobile devices(e.g. Mp3 player, mobile phone, etc). It supplies 5V DC at a charging current up to 1000mA(1A).
In power on mode,Use a USB cable (not included) to connect mobile device to Charging  **5V**  1A Socket of the unit and the mobile device will start charging.

FM Radio Operation

Press  button repeatedly to select the TUNER source. The display will show "TUNER".



TUNING in a Station

Auto Tuning





- 1 Press and hold  button to start auto tuning. Press  button again to stop the auto tuning.
 - 2 The searched radio stations will be stored as preset stations.
- Note: The search may not stop at a station with a very weak signal.

EN



Manual Tuning

Press and hold  or  button to start the forward or reverse scanning. The display will show the frequency being searched. Once a station has been found, the scanning will stop automatically to change the frequency until you find the station you want.

Searching for a radio station manually

- 1 Briefly press the buttons  or  until the optimal reception frequency is reached.
- 2 Each time the buttons  or  are pressed, the frequency decreases/increases by 0.05MHz.

Recalling a preset station

- 1 Press  button to switch between preset station and frequency.
- 2 Press  /  button to select your desired preset station.

Battery Charging For Party Speaker

Built-in Battery Charging

Use the AC power cord (included) to connect AC power input socket on the unit to AC power outlet. the current charging-indicator light on the unit will flash during charging, when five charging-indicator light on the unit keep solid light that the battery has been fully charged. Alternatively, connect one terminal of the vehicle DC power adapter (not included) to the DC input socket on the unit and connect the other terminal of the vehicle DC power adapter to the power socket on the vehicle.

5 LED white light up=approx. 100% full

4 LED white light up=approx. 80% full

3 LED white light up=approx. 60% full

2 LED white light up=approx. 40% full

1 LED white light up=approx. 20% full

(indicating charging is needed)

Note: when the battery is low, the unit will emit a prompt beep.

When DC in is connected for charging, the unit can only be charged and cannot be played.

Troubleshooting

To keep the warranty valid, never try to repair the system yourself. If you encounter problems when using this unit, review the following before requesting service.

No power

- Ensure that the AC cord is properly connected.
- Ensure that there is power at the AC outlet.
- Press  button on the speaker.

EN

I hear buzzing or humming

- Ensure all cables and wires are securely connected.
- Connect a different source device (Blu-ray player, etc) to see if the buzzing persists. If it does not, the problem may be with the original device.
- Connect your device to a different input on the speaker.

I can't find the Bluetooth name of this unit on my Bluetooth device

- Ensure the Bluetooth function is activated on your Bluetooth device.
- Re-pair the unit with your Bluetooth device.

SPECIFICATONS

Model name	Party Rocker One
Model name	Party Rocker One Plus

EN

Power supply

Voltage	AC 100-240 V ~ 50/60Hz; DC IN 12V 2A
Power consumption(AC)	80 W
Dimensions(W x H x D)	295x550x258mm

Amplifier(Max Audio Power)

Amplifier Maximun Audio Power Total	300W
-------------------------------------	------

Ambient conditions

In operation	min. 0°C – max. +45°C / 60% relative humidity
Not in operation	min. -10°C – max. +60°C / 65% relative humidity
Built-in battery	Li-ion 5000mAh,7.4V
Battery charge time	3.5 hours
Battery playtime	15 hours*

Radio

FM band	FM 87.5 – 108 MHz.
FM antenna	Permanently installed wire aerial

System

Frequency range	20Hz to 20KHz
Signal-to-noise	>80dB
USB port	USB 2.0 to 32GB WAV \WMA \ MP3
USB output	Output: 5V 1A max.

Bluetooth®

Bluetooth Version	5.0
Bluetooth Transmitter Power	<10dBm
Frequency Range	2.4GHz-2.4835GHz

Proof-water

Top-Panel	IPX4
-----------	------

Wireless microphone (Only for Party Rocker One Plus)

Battery type	AA battery(1.5V x 2)
Transmission power	9dBm
Distance between transmitter and receives	≤20m

*15 hrs battery playtime is only for reference and may vary depending on music content and battery aging after numerous charging and discharging cycles. It's achievable with a predefined music source, light show switch off, volume level at 7 and BT streaming source.

*If only powered by the battery, the Power would lowered automatically to protect the battery.

Hisense

Party Rocker One
Party Rocker One Plus

PARTY SPEAKER