

Final Trim Size: 5.512 x 8.268 in. (140 x 210 mm)



NS-SBAR21F20\_19-0079\_MAN\_V1\_ENG.fm Page 1 Monday, June 17, 2019 12:48 PM

INSIGNIA™

**USER GUIDE**

# 2.1 Channel Soundbar System

**NS-SBAR21F20**



Before using your new product, please read these instructions to prevent any damage.

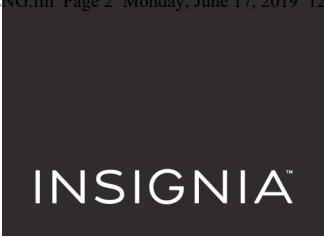

## Contents

Introduction .....	2
Getting started .....	3
Important safety instructions .....	5
Package contents .....	7
Features .....	7
Front view .....	7
Side view .....	8
Back view .....	8
Subwoofer .....	9
Remote control .....	10
Using the remote control .....	11
Installing the remote control batteries .....	11
Setting up your soundbar .....	12
Choosing your sound source .....	12
Connecting your soundbar .....	13
Connecting the AC power .....	16
Connecting the subwoofer .....	17
Pairing the subwoofer with the soundbar if they are disconnected .....	18
Positioning the soundbar .....	18
Positioning the subwoofer .....	19
Mounting your soundbar on a wall (optional) .....	19
Using your soundbar .....	20
Maintaining your soundbar .....	21
Cleaning your soundbar and subwoofer .....	21
Troubleshooting .....	21
Specifications .....	24
Legal notices .....	24
ONE-YEAR LIMITED WARRANTY .....	26

## Introduction

Congratulations on your purchase of an Insignia 2.1 Channel Soundbar System. The soundbar is designed to be used with today's flat panel TVs. It features a variety of connections, including Bluetooth, and it can either be mounted on the wall or placed on a TV stand.

This user guide explains how to correctly install, operate, and get the best performance from your soundbar. Read this user guide carefully before installing your system, and then keep it handy for quick reference.

## Getting started

To help you get started quickly, here are the basic steps to setting up your soundbar. For more detailed information, follow the page numbers listed below:

### Connecting your sound source

Choose a sound source, such as a TV, DVD/Blu-ray player, or smartphone to connect to your soundbar. The device you select will provide the sound for the soundbar to play. For more detail, See [Choosing your sound source](#) on page [12](#).

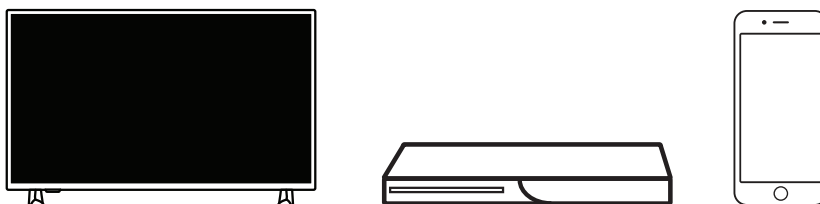

### Connecting your soundbar

Connect your sound source to your soundbar. You may need to find or purchase the correct cable, depending on the connection. For more detail, see [Connecting your soundbar](#) on page [13](#).

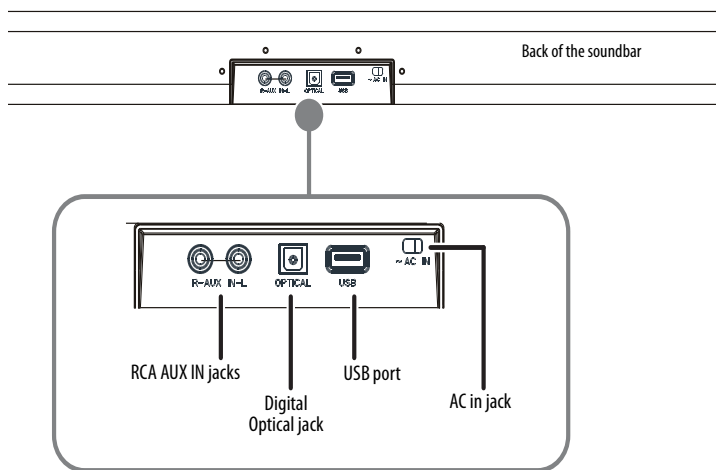

## Connecting the AC power

Plug your soundbar into an AC power outlet. For more detail, see [Connecting the AC power](#) on page 16.

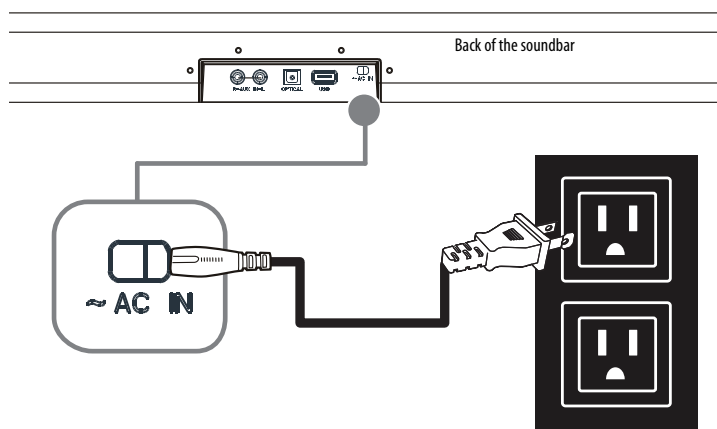

## Connecting and positioning your subwoofer and positioning your soundbar

(Optional) To enhance the low frequency sounds from your sound source, connect the included subwoofer using Bluetooth. For more detail, see [Connecting the subwoofer](#) on page 17. Then position your subwoofer for best enjoyment. For more detail, see [Positioning the subwoofer](#) on page 19.

You can either place the soundbar on a cabinet or mount it on the wall (optional) under the TV. For more detail, see [Mounting your soundbar on a wall \(optional\)](#) on page 19.

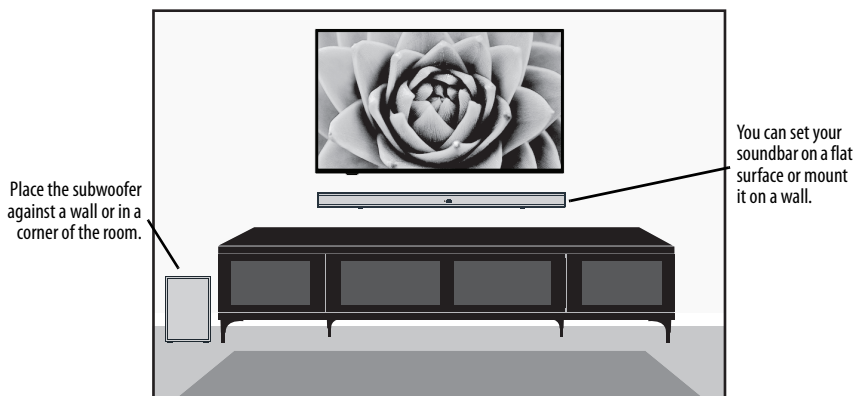

## Important safety instructions

- 1 Read these instructions.
- 2 Keep these instructions.
- 3 Heed all warnings.
- 4 Follow all instructions.
- 5 Do not use this apparatus near water.
- 6 Clean only with a dry cloth.
- 7 Do not block any ventilation openings. Install in accordance with the manufacturer's instructions.
- 8 Do not install near any heat sources such as radiators, heat registers, stoves, or other apparatus (including amplifiers) that produce heat.
- 9 Do not defeat the safety purpose of the polarized or grounding-type plug. A polarized plug has two blades with one wider than the other. A grounding type plug has two blades and a third grounding prong. The wide blade or the third prong are provided for your safety. If the provided plug does not fit into your outlet, consult an electrician for replacement of the obsolete outlet.
- 10 Protect the power cord from being walked on or pinched particularly at plugs, outlets, and the point where they exit from the apparatus.
- 11 Only use attachments/accessories specified by the manufacturer.
- 12 Use only with the cart, stand, tripod, bracket, or table specified by the manufacturer, or sold with the apparatus. When a cart is used, use caution when moving the cart/apparatus combination to avoid injury from tip-over. 
- 13 Unplug this apparatus during lightning storms or when unused for long periods of time.
- 14 Refer all servicing to qualified service personnel. Servicing is required when the apparatus has been damaged in any way, such as when the power-supply cord or plug is damaged, liquid has been spilled or objects have fallen into the apparatus, the apparatus has been exposed to rain or moisture, does not operate normally, or has been dropped.
- 15 To reduce the risk of fire or electric shock, do not expose this device to rain, moisture, dripping, or splashing, and no objects filled with liquids, such as vases, shall be placed on it.
- 16 An apparatus with a three-prong, grounding-type plug is a Class I apparatus, which needs to be grounded to prevent possible electric shock. Make sure that you connect any Class I device to a grounding-type, three-prong outlet.
- 17 DO NOT overload wall outlets or extension cords beyond their rated capacity as this can cause electric shock or fire.
- 18 The wall plug is the disconnecting device. The plug must remain readily operable.

INSIGNIA™

NS-SBAR21F20

- 19 No naked flame sources, such as lighted candles, should be placed on the apparatus.
- 20 The ventilation should not be impeded by covering the ventilation openings with items, such as newspapers, tablecloths, curtains, etc.
- 21 Batteries should not be exposed to excessive heat such as sunshine, fire, or the like.

**WARNING:** Danger of explosion if the remote control batteries are incorrectly replaced. Replace only with the same or equivalent type.

- 22 Keep new and used batteries away from children.
- 23 If the battery compartment does not close securely, stop using the product and keep it away from children.
- 24 If you think batteries might have been swallowed or placed inside any part of the body, seek immediate medical attention.



The lightning flash with arrowhead symbol within an equilateral triangle is intended to alert the user to the presence of uninsulated "dangerous voltage" within the product's enclosure that may be of sufficient magnitude to constitute a risk of electrical shock to persons.



The exclamation point, within an equilateral triangle, is intended to alert the user to the presence of important operating and maintenance (servicing) instructions in the literature accompanying the product.

## Placement

- The soundbar cabinet is made out of plastic and is therefore sensitive to extreme temperatures and humidity. Do not put it in locations subject to direct sunlight or in humid places, such as near an air conditioner, humidifier, bathroom, or kitchen.
- Do not put water or other liquids close to the soundbar. If liquid is spilled on top of the soundbar, it may be damaged.
- The soundbar should be placed on a sturdy, flat surface that is free from vibration, or mounted on a wall. Do not put the soundbar on an uneven or unstable surface, where it may fall and cause damage.

## Package contents

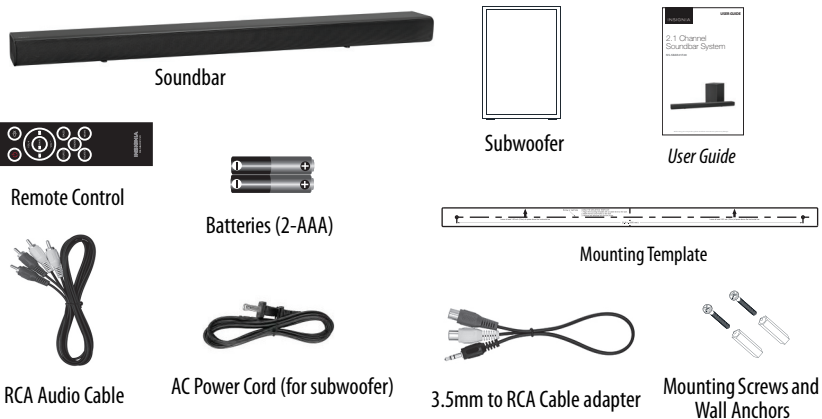

## Features

### Front view

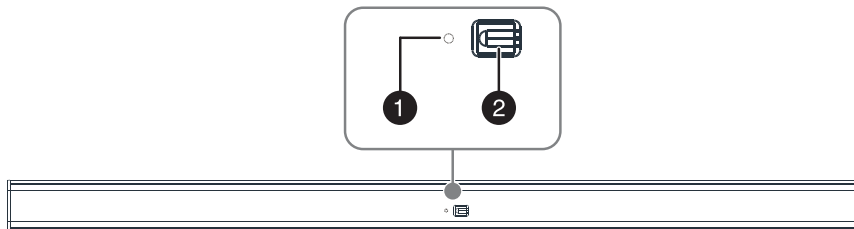

#	ITEM	DESCRIPTION
1	Status indicator	Different color LEDs indicate the following: <ul style="list-style-type: none"> <li>• Red - Standby mode</li> <li>• Green - On in digital optical mode</li> <li>• Yellow - On in AUX IN mode</li> <li>• Blue - On in Bluetooth mode (blinks while pairing)</li> <li>• Purple - On in USB mode</li> </ul>
2	Remote control sensor	Detects signals from the remote control.

### Side view

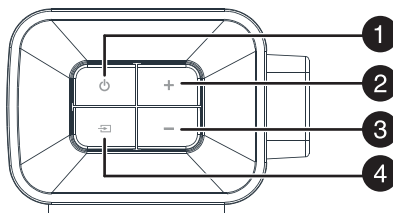

#	ITEM	DESCRIPTION
1	⏻ (Power) button	Press to turn on the soundbar. The status indicator turns green, yellow, blue, or purple to indicate that the soundbar is on and what input is selected. Press again to return the soundbar to standby mode. The status indicator turns red.
2	+ (volume up) button	Press to increase the volume of the soundbar.
3	- (volume down) button	Press to decrease the volume of the soundbar.
4	🔊 (sound source selector)	Press to cycle through the available sound sources: <ul style="list-style-type: none"> <li>• Green - Digital optical</li> <li>• Yellow - AUX IN</li> <li>• Blue - Bluetooth</li> <li>• Purple - USB</li> </ul> Press and hold for three seconds to pair the soundbar with the subwoofer if they are disconnected.

### Back view

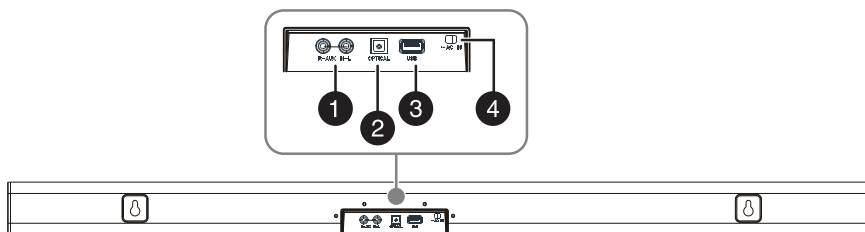

#	ITEM	DESCRIPTION
1	<b>AUX IN</b> jacks	Connect an RCA audio cable to these jacks, red to red and white to white.
2	<b>DIGITAL OPTICAL</b> jack	If your TV (or other audio source device) has an <b>Optical OUT</b> jack, connect a digital optical cable (not included) to your source device and this jack. Make sure that the sound output from the source is set to PCM format.



2.1 Channel Soundbar System

#	ITEM	DESCRIPTION
3	<b>USB port</b>	You can play WAV files from a USB source and charge the USB device with the 0.5 A connection output.
4	<b>AC IN jack</b>	Connect the AC power cord to this jack to power the soundbar.

**Subwoofer**

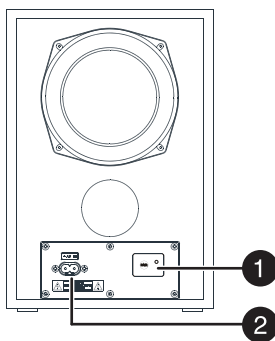

#	ITEM	DESCRIPTION
1	<b>PAIR button and indicator LED</b>	Press and hold for three seconds to disconnect or re-connect with the soundbar. The indicator LED blinks turquoise in pairing mode and is solid turquoise when paired.
2	<b>AC IN jack</b>	Connect the AC power cord to this jack to power the subwoofer.

INSIGNIA™

NS-SBAR21F20

## Remote control

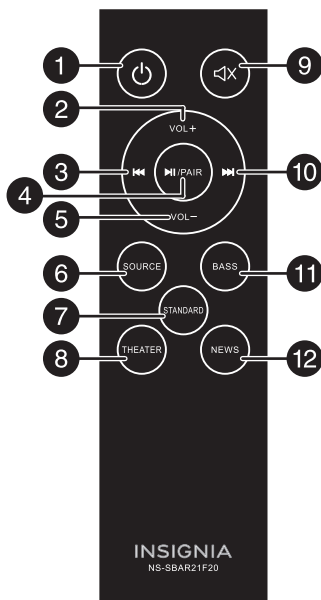

#	BUTTON	DESCRIPTION
1	⏻ (Power)	Press to turn on the soundbar. Press again to put the soundbar into standby mode.
2	<b>VOL +</b>	Press to increase the volume of the soundbar.
3	⏮ (previous)	In Bluetooth mode, press to skip to the previous track.
4	▶⏸ (play/pause)/ <b>PAIR</b>	<ul style="list-style-type: none"> <li>In Bluetooth mode, press to start or pause playback.</li> <li>Press and hold this button for three seconds to disconnect Bluetooth.</li> </ul>
5	<b>VOL -</b>	Press to decrease the volume of the soundbar.
6	<b>SOURCE</b>	Press repeatedly to cycle through the available sound sources.
7	<b>STANDARD</b>	Press to enter the STANDARD sound mode to optimize general music. The status indicator on the soundbar blinks white three times.
8	<b>THEATER</b>	Press to enter the THEATER sound mode to optimize music played in a theater setting. The status indicator on the soundbar blinks white three times.
9	🔇 (Mute)	Press to mute the sound from the soundbar. Press again to restore the sound.
10	⏭ (next)	In Bluetooth mode, press to go to the next track.

#	BUTTON	DESCRIPTION
11	<b>BASS</b>	Press to activate the bass frequency enhancement. The status indicator on the soundbar blinks turquoise for 10 seconds. When activated, use the <b>VOL +/-</b> buttons to adjust the bass volume level.
12	<b>NEWS</b>	Press to enter the NEWS sound mode to optimize the spoken voice. The status indicator on the soundbar blinks white three times.

## Using the remote control

Point the remote control directly at the IR sensor on the front of the soundbar. You must be within approximately 26 ft. (8 m) of the soundbar and within 30° on either side.

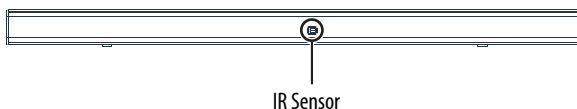

## Installing the remote control batteries

- 1 Remove the battery compartment cover from the back of the remote control.

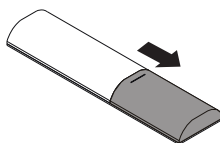

- 2 Insert two AAA batteries into the battery compartment, making sure that the polarity on the batteries matches the + and - symbols inside the battery compartment.

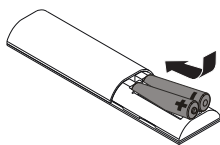

**3** Replace the battery compartment cover.

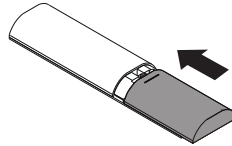

**CAUTIONS:**

- Do not spill water or any liquid on the remote control.
- Do not place the remote control on a wet surface.
- Do not place the remote control in direct sunlight or near sources of excessive heat.
- If the remote control is not going to be used for a long time, remove the batteries to avoid any damage that may be caused by leakage and corrosion.







## Setting up your soundbar

### Choosing your sound source

- Look at your sound source device, such as a TV, DVD/Blu-ray player, or cable box, to identify your audio OUT ports. Choose one connection option below that fits your sound source. You can connect several devices and switch the sound source as required.

**CAUTIONS:**

- Turn off or unplug all devices while you are making connections.
- If you mounted your soundbar on a wall, you must use right-angle cable connectors for the RCA cable (AUX IN) connection.

AUDIO QUALITY	JACK TYPE	CABLE
<b>Best</b>		 Digital Optical cable (not included). See <a href="#">Digital Optical connection (best)</a> on page 13.
<b>Good</b>		 RCA audio cable (included). See <a href="#">RCA connection (good)</a> on page 13.
<b>Good</b>		 3.5mm to RCA audio cable adapter (included). See <a href="#">RCA connection (good)</a> on page 13.

You can also choose a USB thumbdrive or Bluetooth device as your sound source. See [USB sound source](#) on page 14, or [Bluetooth sound source](#) on page 15.

## Connecting your soundbar

### Digital Optical connection (best)

- 1 Connect one end of the digital optical cable (not included) to your soundbar.
- 2 Connect the other end into the **Digital Optical Output** port on your source device.

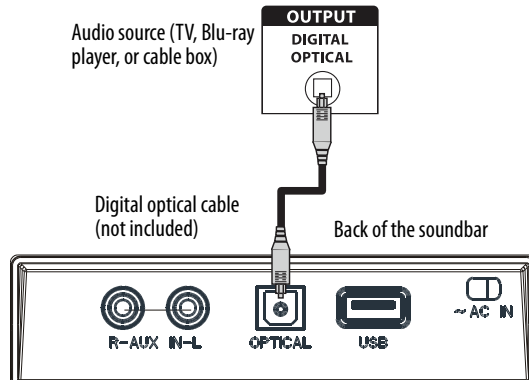

- 3 Change the device's audio output to 'PCM' format (typically found in audio settings). Refer to the documentation that came with your sound source device for more information.
- 4 Go to [Connecting the AC power on page 16](#).
- 5 After your soundbar is plugged in and turned on, press the **SOURCE** button repeatedly on your soundbar or remote control until the source indicator turns green.

**Important:** Make sure that the device you connect and select as your sound source is outputting sound to the soundbar. See your device's user manual for more information.

### RCA connection (good)

- 1 Plug the red and white RCA connectors on an RCA audio cable (included) to the AUX IN jacks on your soundbar, red to red and white to white.
- 2 Connect the other end of the RCA audio cable into the **Audio Output** ports on your sound source device.

**Note:** If your sound source device does not have RCA audio output jacks (for example a smartphone, tablet, or iPad), use the optional 3.5mm to RCA cable adapter.

INSIGNIA™

NS-SBAR21F20

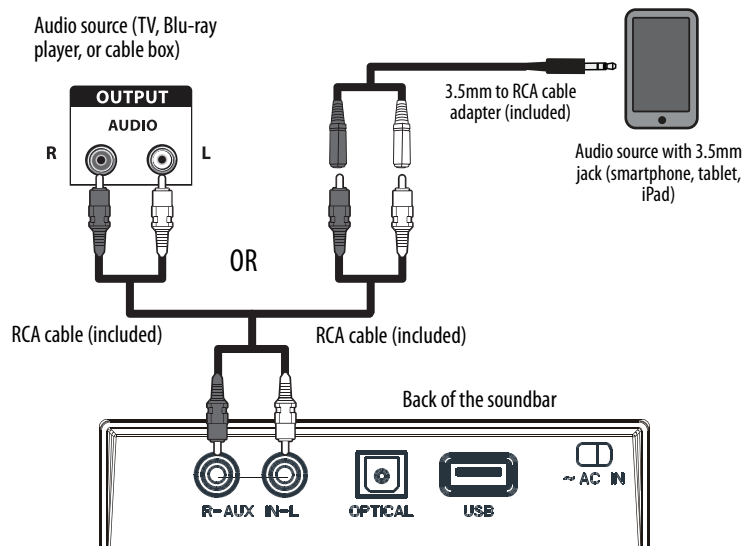

- 3 Go to [Connecting the AC power](#) on page 16.
- 4 After your soundbar is plugged in and turned on, press the **SOURCE** button repeatedly on your soundbar or remote control until the source indicator turns yellow.

**Important:** Make sure that the device you connect and select as your sound source is outputting sound to the soundbar. See your device's user manual for more information.

### USB sound source

**Note:** If you mount your soundbar on a wall, you will not be able to use a USB thumbdrive as a sound source.

- 1 Plug a USB thumbdrive (with WAV files) into the USB port on the back of your soundbar. FAT16/FAT32/ ExFAT/Fat64 files are acceptable.
- 2 Go to [Connecting the AC power](#) on page 16.
- 3 After your soundbar is plugged in and turned on, press the **SOURCE** button repeatedly on your soundbar or remote control until the source indicator turns purple.
- 4 Control USB playback by pressing the ►|| (play/pause), ◀◀ (previous), and ▶▶ (next) buttons on the remote control.

**Note:** If playback does not begin immediately, press the ►|| (play/pause)/ **PAIR** button on the remote control.

### Bluetooth sound source

Before you can use your soundbar with a Bluetooth device, you need to pair your device to the soundbar. Go to [Connecting the AC power](#) on page 16. After your soundbar is plugged in and turned on, do the following:

**Notes:**

- Your soundbar must be on to make a Bluetooth connection.
- Place the Bluetooth device within 30 ft. (10 m) of your soundbar.

### Pairing your devices

- 1 Select **Bluetooth** as the input source by pressing the **SOURCE** button on the soundbar or on the remote control. The status indicator blinks blue.
- 2 Navigate to your device's Bluetooth settings, turn on Bluetooth, then search for available devices. For additional information on pairing your device, see your device's documentation.
- 3 On your Bluetooth device, select "NS-SBAR21F20" from the device list. Repeat steps 1-2 if "NS-SBAR21F20" is not displayed.
- 4 If a PIN code is requested, enter "0000."
- 5 When the Bluetooth connection has been established, the status indicator turns solid blue.

**Notes:**

- Some devices, such as an iPhone, connect immediately after pairing so the status indicator on your soundbar remains on. Other devices, such as notebook computers, may ask you if you wish to connect. In this instance, the status indicator continues to blink until a connection is established.
- Your soundbar saves pairing information for up to eight devices. However, it can only be connected and play content from one device at a time.
- When you turn on your soundbar, it automatically connects to the last connected device if that device is in range. To connect to a different paired device, turn off Bluetooth or unpair from the currently paired device and manually connect to the other paired device.

**Important:** Make sure that the device you connect and select as your sound source is outputting sound to the soundbar. See your device's user manual for more information.

### Disconnecting your devices

- Turn off the Bluetooth function on your device.

### Reconnecting to a paired device

When your soundbar is not paired to a device, the LED indicator blinks.

Your soundbar loses the Bluetooth connection if you...	To reconnect...
Turn it off.	Turn on your soundbar. Your soundbar searches for the last connected Bluetooth device and reconnects.
Move the Bluetooth device out of range.	Move your Bluetooth device within 30 ft. (10 m) of your soundbar.
Turn off your Bluetooth device.	Turn on your Bluetooth device, then make sure that Bluetooth is on.
Turn off Bluetooth on your Bluetooth device.	Turn on Bluetooth on your Bluetooth device.
Connect your Bluetooth device to another Bluetooth device.	Disconnect your Bluetooth device from the other Bluetooth device, then set your device to pairing mode. Select "NS-SBAR21F20" on your Bluetooth device.

**Note:** If a device does not automatically reconnect, you may need to reselect "NS-SBAR21F20" on your Bluetooth device.

### Connecting to a different device

- 1 On your Bluetooth device you are currently connected to, turn off the Bluetooth function or unpair the soundbar in your Bluetooth device list. The soundbar can now be connected to another Bluetooth device.
- 2 Follow the section [Positioning the soundbar](#) on page 18 to connect a new device.

### Receiving a phone call while playing music

- When you receive a call while playing music through your phone, the music stops automatically.
- When you hang up, depending on the setting of your phone, the current track may resume playback.

### Connecting the AC power

After you have connected your soundbar to an audio source, you need to connect it to an AC power outlet.

**CAUTION:** Make sure that the electrical outlet matches the input requirements of 100-240 V, 50/60 Hz before connecting.

- 1 Connect the AC power cord to the AC IN jack on the back of the soundbar.



## 2.1 Channel Soundbar System

- 2 Plug the other end of the AC power cord into a power outlet or surge protector.

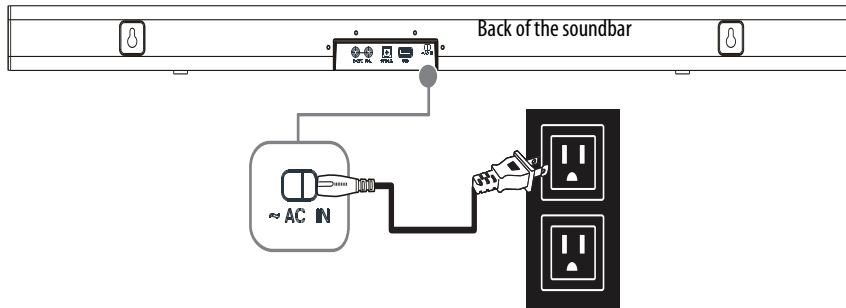

### Connecting the subwoofer

- 1 When you turn on your soundbar for the first time, the status indicator blinks turquoise.
- 2 Plug in your subwoofer. The pairing indicator blinks turquoise. The soundbar and subwoofer automatically connect, then the pairing indicator turns solid turquoise on the subwoofer and the appropriate indicator (yellow=AUX IN, green=Digital Optical, blue=Bluetooth, and purple=USB) on the soundbar.

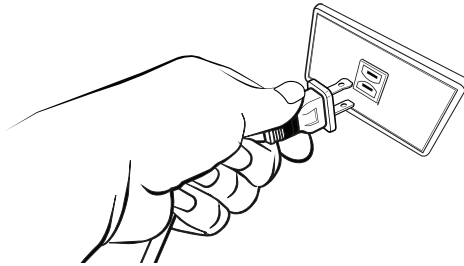

- 3 To disconnect/reconnect the subwoofer from the soundbar, press and hold the PAIR button on the subwoofer for three seconds. The status indicator blinks turquoise on the subwoofer when they are disconnected, or solid turquoise when they are connected.

**Note:** When disconnected, your Bluetooth device list might show the subwoofer name "NS-SBAR21F20SW", but it only allows the soundbar NS-SBAR21F20 to pair. It cannot be connected by your Bluetooth device.

**Notes:**

- After the initial connection, the soundbar and subwoofer automatically reconnect when they are turned on.
- If your subwoofer does not connect automatically, the pairing LED blinks turquoise slowly. You need to manually pair them by doing the following:
  - 1 Make sure the soundbar is already powered on and positioned next to subwoofer.
  - 2 Press and hold the **PAIR** button on the subwoofer for three seconds. It should reconnect to the soundbar within two minutes. The subwoofer LED will be solid turquoise when connected.- Or
  - 3 Press and hold the **SOURCE** button on the soundbar for three seconds. The soundbar's LED blinks turquoise and it will connect to the subwoofer. The subwoofer's indicator LED will be solid turquoise when connected.

**Pairing the subwoofer with the soundbar if they are disconnected**

- Press and hold for three seconds to reconnect the subwoofer with the previous soundbar if they are disconnected.
- Press and hold three seconds to disconnect the soundbar from the subwoofer if they are connected. This allows the subwoofer to be paired with the previous or a new soundbar (NS-SBAR21F20).

**Positioning the soundbar**

**WARNING:** Improper installation can result in serious injury or damage to your soundbar. If necessary, seek the assistance of a professional.

**Note:** If you are installing screws into drywall or concrete, use wall anchors (provided) designed for that type of surface.

- You can set the soundbar on a flat surface or mount it on a wall.

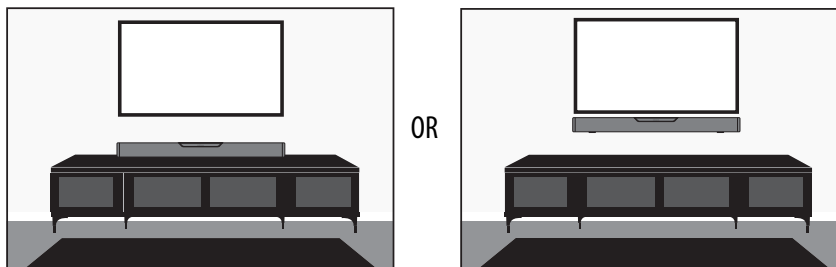

**Note:** If you connected a subwoofer, you can place it anywhere in the room because the low frequency sound is non-directional.

## Positioning the subwoofer

For the best sound results from your subwoofer, it should be placed against a wall or in a corner of the room. The location within the room is less important, because bass tones are omni directional.

## Mounting your soundbar on a wall (optional)

### Notes:

- Make all connections to your soundbar before mounting the soundbar on a wall.
- If you mount your soundbar on a wall, you will not be able to use a USB thumbdrive as a sound source.

You will need (not included with your soundbar):

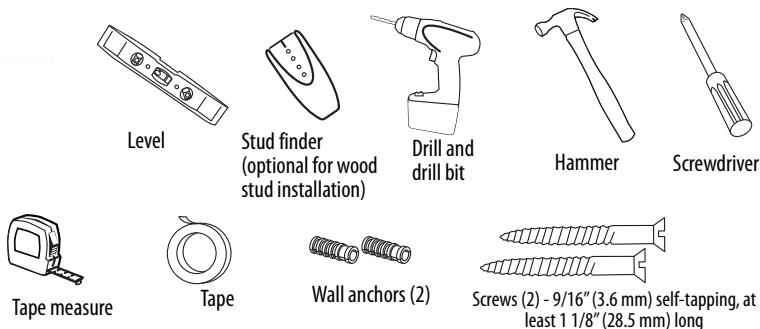

- 1 Select a location close to your TV and directly in front of the viewing/listening position. For best sound quality, choose a location where sound waves are not blocked by furniture or other obstacles.
- 2 If you are mounting your soundbar to drywall, use the stud finder to find the studs and mark the locations.
- 3 Drill two 15/64" holes into the wall 25.6 inches (650 mm) apart and level.
- 4 If you are mounting on drywall without studs or on concrete, install wall anchors (included) into the holes you drilled, using the instructions that came with your anchors.
- 5 Secure two screws (included) to the wall or wall anchors (if required). The screws must protrude from the wall by about 5/32" (4 mm). Use a 9/16" (3.6 mm) self-tapping wood screw (or similar), 1-1/8" (28.5 mm) in length. The screw head must be approximately 9/32" (7 mm).

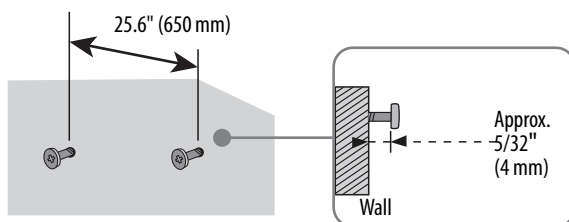

- 6 Align the speaker hanging brackets with the screws, then hang the soundbar on the screws.

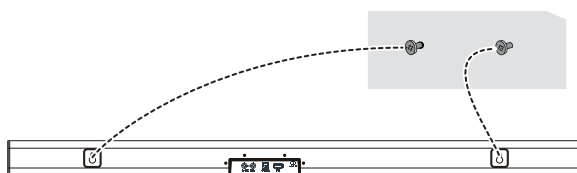



**WARNING:** Improper installation can result in serious injury or damage to your soundbar. If necessary, seek the assistance of a professional.

## Using your soundbar

This system lets you access four different sound sources, including Optical, AUX IN (RCA), Bluetooth, and USB.

### Listening to your soundbar

- 1 Press the  (Power) button to turn on your soundbar. The power indicator turns off.
- 2 Turn on the audio source device connected to your soundbar and begin playback.
- 3 Press the  button on the soundbar repeatedly to select the audio source or press the selected source button on the remote control until you hear sound from your soundbar.

#### Notes:

- If you use the OPTICAL connection, you must change your device's audio output setting to "PCM" format. Refer to the manual you received with the output device for additional information.
- Make sure that your sound source is set to output sound to the soundbar (whichever connection method you choose). Refer to your device's manual for additional information.

- 4 Adjust the volume on your soundbar or the source audio device to a comfortable level.

**WARNING:** Continuous use of high volume sound may permanently damage your hearing.

- 5 Press the  (Power) button again to turn off your soundbar. The status indicator lights red.

## Maintaining your soundbar

### Cleaning your soundbar and subwoofer

**CAUTION:** Only use a soft and clean rag to clean the outside of the soundbar or subwoofer. Never clean them with chemicals, detergents, or abrasives.

## Troubleshooting

Check this list for a possible troubleshooting solution before calling for service.

PROBLEM	POSSIBLE SOLUTIONS
The power does not come on.	<ul style="list-style-type: none"> <li>• Make sure that the AC power cord is securely plugged into the power outlet and the soundbar and subwoofer.</li> <li>• Make sure that the soundbar is turned on. It does not turn on automatically when you turn on your TV or other sound source.</li> </ul>
The remote control does not work.	<ul style="list-style-type: none"> <li>• Remove any obstacles between the remote control and the IR sensor on the soundbar.</li> <li>• The remote control batteries may be exhausted, replace them.</li> <li>• Move closer to the soundbar. The remote control is only effective to approximately 26 ft. (8 m) of the soundbar and within 30° on either side.</li> </ul>

PROBLEM	POSSIBLE SOLUTIONS
The sound is breaking up or buzzing.	<ul style="list-style-type: none"> <li>• Make sure that you are connected to an audio OUT jack on your sound source. The port will not send audio out if it is an INPUT jack.</li> <li>• Make sure that all connections are secure and cables are not broken or damaged.</li> <li>• If you are using the OPTICAL connection, make sure that the source device's audio source is set to "PCM" format. Refer to the documentation you received with the audio source device (such as a TV or DVD/Blu-ray player, etc.) for additional information.</li> <li>• Connect to a different source device (such as a TV or DVD/Blu-ray player) to see if the buzzing still occurs. If it does not, this may indicate an issue with the original source device.</li> <li>• Use a different connection method (for example, try Optical instead of AUX IN) between the soundbar and the source device to make sure the jacks on both devices are still working.</li> <li>• Make sure that the audio cable you are using is not damaged or broken. Try using another one.</li> </ul>
There is no sound or very low-level sound is heard from the soundbar.	<ul style="list-style-type: none"> <li>• Make sure that you are connected to an audio OUT jack on your sound source. The port will not send audio out if it is an INPUT jack.</li> <li>• Make sure that the volume level of the soundbar is set to an adequate level.</li> <li>• If you are using Bluetooth, turn up the volume on your Bluetooth device.</li> <li>• If you are using Bluetooth, make sure that your Bluetooth device is not paired with a device other than the soundbar.</li> <li>• Make sure that the volume level is not muted. Press the  (mute) button on the remote control again to restore the sound output.</li> <li>• Make sure that the correct audio source is selected. Press the <b>SOURCE</b> button repeatedly to switch to the correct audio source.</li> <li>• Make sure that the power is on and all connections are secure.</li> <li>• Make sure that the volume is turned up on your sound source.</li> <li>• If you are using the OPTICAL connection, make sure that the source device's audio source is set to "PCM" format. Refer to the documentation you received with the audio source device (such as a TV or DVD/Blu-ray player, etc.) for additional information.</li> <li>• Make sure that the audio cable you are using is not damaged or broken. Try using another one.</li> <li>• Make sure that the sound source device is outputting sound to the soundbar.</li> </ul>
I can hear sound from both my TV and my soundbar.	<ul style="list-style-type: none"> <li>• Turn off or mute the internal speakers of your TV. Refer to the TV's manual for instructions.</li> </ul>

PROBLEM	POSSIBLE SOLUTIONS
My TV remote does not control my soundbar.	<ul style="list-style-type: none"> <li>• If you are using a universal remote control, make sure that it is programmed to your soundbar. See <a href="#">Setting up your soundbar</a> on page 12.</li> <li>• Universal remotes will only control your soundbar's volume. Use the controls on your soundbar or the remote that came with it to change the soundbar's audio source or sound mode.</li> <li>• Make sure that you aim your universal remote at the remote sensor on the front of your soundbar.</li> <li>• Make sure that you select the correct source on your universal remote.</li> </ul>
There is no sound or low volume in Bluetooth mode.	<ul style="list-style-type: none"> <li>• Make sure that your Bluetooth device is turned on, Bluetooth is turned on, and "NS-SBAR21F20" is selected.</li> <li>• Turn up the volume on your soundbar.</li> <li>• Turn up the volume on your Bluetooth device.</li> <li>• Make sure that your Bluetooth device is not muted.</li> <li>• Make sure that you are playing music from your Bluetooth device.</li> <li>• Make sure that you have selected the Bluetooth source on your soundbar.</li> <li>• Make sure that your soundbar is not paired to another Bluetooth device.</li> <li>• Make sure that your Bluetooth device is not paired to a different Bluetooth speaker or other device.</li> </ul>
My soundbar won't connect to my Bluetooth device.	<ul style="list-style-type: none"> <li>• Shorten the distance between your soundbar and your Bluetooth device.</li> <li>• Turn your devices off, then on. Re-pair your soundbar and your Bluetooth device.</li> <li>• Make sure that your soundbar is not paired to another Bluetooth device.</li> <li>• Make sure that your soundbar and Bluetooth device are both in pairing mode.</li> <li>• Make sure that your Bluetooth device is not paired to any other device.</li> <li>• Make sure that you have selected "NS-SBAR21F20" on your Bluetooth device.</li> </ul>
The wireless subwoofer is not connected.	<ul style="list-style-type: none"> <li>• The wireless subwoofer is set at the factory so that the soundbar and subwoofer should link automatically when the soundbar is turned on. However, if the link indicator does not light when the soundbar and subwoofer are both powered on, or if your soundbar has been serviced recently, then you need to re-pair the two devices. See <a href="#">Connecting the subwoofer</a> on page 17.</li> <li>• Make sure that the subwoofer is next to soundbar.</li> </ul>
My Bluetooth device keeps unpairing.	<ul style="list-style-type: none"> <li>• Shorten the distance between your soundbar and your Bluetooth device.</li> <li>• If the battery on your Bluetooth device is low, recharge the battery.</li> </ul>

INSIGNIA™

NS-SBAR21F20

PROBLEM	POSSIBLE SOLUTIONS
"NS-SBAR21F20" does not appear on my Bluetooth device.	<ul style="list-style-type: none"> <li>• Shorten the distance between your soundbar and your Bluetooth device.</li> <li>• Put your soundbar into pairing mode, then refresh your list of Bluetooth devices. For more information, see the documentation that came with your Bluetooth device.</li> <li>• Make sure that your Bluetooth device is visible to other devices. For more information, see the documentation that came with your Bluetooth device.</li> </ul>
The sound is lagging or I hear an echo.	<ul style="list-style-type: none"> <li>• Turn off or mute the internal speakers of your TV. Refer to the TV's manual for instructions.</li> </ul>

## Specifications

Designs and specifications are subject to change without notice.

Power output	Left and right channel: 20W x 2 (1% THD) Subwoofer: 40W (10% THD)
Speaker information	Soundbar - 2 x 1-21/32 x 6-3/16" (42 x 157 mm) Subwoofer - 1 x 5.25" (133.4 mm)
Power requirement - Soundbar	AC-100~240 V at 50/60 Hz
Power requirement - Subwoofer	AC-100~240 V at 50/60 Hz
Dimensions (approx.) (W x H x D)	Soundbar - 36.2 x 2.2 x 2.9 in. (920 x 56 x 74 mm) Subwoofer - 7.8 x 11.5 x 9 in. (200 x 293 x 230 mm)
Weight	Net: 10.6 lb. (4.8 kg) Gross: 14.7 lb. (6.7 kg)
Batteries (remote)	AAA (2)
Working environment	Temperature - 14~95°F (-10~35°C) Humidity - 5%~90%
Inputs	USB connector AUX IN (RCA stereo) audio jack Digital optical audio jack Bluetooth

## Legal notices

### FCC Part 15

This device complies with Part 15 of the FCC Rules. Operation of this product is subject to the following two conditions: (1) this device may not cause harmful interference, and (2) this device must accept any interference received, including interference that may cause undesired operation.



## 2.1 Channel Soundbar System

This equipment has been tested and found to comply within the limits for a class B digital device, pursuant to Part 15 of the FCC Rules. These limits are designed to provide reasonable protection against harmful interference in a residential installation. This equipment generates, uses, and can radiate radio frequency energy and, if not installed and used in accordance with the instructions, may cause harmful interference to radio communications. However, there is no guarantee that interference will not occur in a particular installation. If this equipment does cause harmful interference to radio or television reception, which can be determined by turning the equipment off and on, the user is encouraged to try to correct the interference by one or more of the following measures:

- Reorient or relocate the receiving antenna.
- Increase the separation between the equipment and receiver.
- Connect the equipment into an outlet on a circuit different from that to which the receiver is connected.
- Consult the dealer or an experienced technician for help.

### FCC warning

Changes or modifications not expressly approved by the party responsible for compliance with the FCC Rules could void the user's authority to operate this equipment.

### Canada IC statement

This device complies with Industry license-exempt RSS standard(s). Operation is subject to the following two conditions: (1) this device may not cause interference, and (2) this device must accept any interference, including interference that may cause undesired operation of the device.

Ce dispositif est conforme à la norme de l'industrie RSS exempts de licence (s). Son fonctionnement est soumis aux deux conditions suivantes: (1) cet appareil ne peut pas provoquer d'interférences et (2) cet appareil doit accepter toute interférence, y compris les interférences qui peuvent causer un mauvais fonctionnement du dispositif."

This equipment complies with IC radiation exposure limits set forth for an uncontrolled environment.

Cet équipement est conforme à l'exposition aux rayonnements IC limites établies pour un environnement non contrôlé.

INSIGNIA™

NS-SBAR21F20

## ONE-YEAR LIMITED WARRANTY

### Definitions:

The Distributor\* of Insignia branded products warrants to you, the original purchaser of this new Insignia-branded product ("Product"), that the Product shall be free of defects in the original manufacturer of the material or workmanship for a period of one (1) year from the date of your purchase of the Product ("Warranty Period").

For this warranty to apply, your Product must be purchased in the United States or Canada from a Best Buy branded retail store or online at [www.bestbuy.com](http://www.bestbuy.com) or [www.bestbuy.ca](http://www.bestbuy.ca) and is packaged with this warranty statement.

### How long does the coverage last?

The Warranty Period lasts for 1 year (365 days) from the date you purchased the Product. Your purchase date is printed on the receipt you received with the Product.

### What does this warranty cover?

During the Warranty Period, if the original manufacture of the material or workmanship of the Product is determined to be defective by an authorized Insignia repair center or store personnel, Insignia will (at its sole option): (1) repair the Product with new or rebuilt parts; or (2) replace the Product at no charge with new or rebuilt comparable products or parts. Products and parts replaced under this warranty become the property of Insignia and are not returned to you. If service of Products or parts are required after the Warranty Period expires, you must pay all labor and parts charges. This warranty lasts as long as you own your Insignia Product during the Warranty Period. Warranty coverage terminates if you sell or otherwise transfer the Product.

### How to obtain warranty service?

If you purchased the Product at a Best Buy retail store location or from a Best Buy online website ([www.bestbuy.com](http://www.bestbuy.com) or [www.bestbuy.ca](http://www.bestbuy.ca)), please take your original receipt and the Product to any Best Buy store. Make sure that you place the Product in its original packaging or packaging that provides the same amount of protection as the original packaging.

To obtain warranty service, in the United States and Canada call 1-877-467-4289. Call agents may diagnose and correct the issue over the phone.

### Where is the warranty valid?

This warranty is valid only in the United States and Canada at Best Buy branded retail stores or websites to the original purchaser of the product in the county where the original purchase was made.

### What does the warranty not cover?

This warranty does not cover:

- Customer instruction/education
- Installation
- Set up adjustments
- Cosmetic damage
- Damage due to weather, lightning, and other acts of God, such as power surges
- Accidental damage
- Misuse
- Abuse
- Negligence
- Commercial purposes/use, including but not limited to use in a place of business or in communal areas of a multiple dwelling condominium or apartment complex, or otherwise used in a place of other than a private home.
- Modification of any part of the Product, including the antenna

## 2.1 Channel Soundbar System

- Display panel damaged by static (non-moving) images applied for lengthy periods (burn-in).
- Damage due to incorrect operation or maintenance
- Connection to an incorrect voltage or power supply
- Attempted repair by any person not authorized by Insignia to service the Product
- Products sold "as is" or "with all faults"
- Consumables, including but not limited to batteries (i.e. AA, AAA, C etc.)
- Products where the factory applied serial number has been altered or removed
- Loss or Theft of this product or any part of the product
- Display panels containing up to three (3) pixel failures (dots that are dark or incorrectly illuminated) grouped in an area smaller than one tenth (1/10) of the display size or up to five (5) pixel failures throughout the display. (Pixel based displays may contain a limited number of pixels that may not function normally.)
- Failures or Damage caused by any contact including but not limited to liquids, gels or pastes.

REPAIR REPLACEMENT AS PROVIDED UNDER THIS WARRANTY IS YOUR EXCLUSIVE REMEDY FOR BREACH OF WARRANTY. INSIGNIA SHALL NOT BE LIABLE FOR ANY INCIDENTAL OR CONSEQUENTIAL DAMAGES FOR THE BREACH OF ANY EXPRESS OR IMPLIED WARRANTY ON THIS PRODUCT, INCLUDING, BUT NOT LIMITED TO, LOST DATA, LOSS OF USE OF YOUR PRODUCT, LOST BUSINESS OR LOST PROFITS. INSIGNIA PRODUCTS MAKES NO OTHER EXPRESS WARRANTIES WITH RESPECT TO THE PRODUCT, ALL EXPRESS AND IMPLIED WARRANTIES FOR THE PRODUCT, INCLUDING BUT NOT LIMITED TO ANY IMPLIED WARRANTIES OF AND CONDITIONS OF MERCHANTABILITY AND FITNESS FOR A PARTICULAR PURPOSE, ARE LIMITED IN DURATION TO THE WARRANTY PERIOD SET FORTH ABOVE AND NO WARRANTIES, WHETHER EXPRESS OR IMPLIED, WILL APPLY AFTER THE WARRANTY PERIOD. SOME STATES, PROVINCES AND JURISDICTIONS DO NOT ALLOW LIMITATIONS ON HOW LONG AN IMPLIED WARRANTY LASTS, SO THE ABOVE LIMITATION MAY NOT APPLY TO YOU. THIS WARRANTY GIVES YOU SPECIFIC LEGAL RIGHTS, AND YOU MAY ALSO HAVE OTHER RIGHTS, WHICH VARY FROM STATE TO STATE OR PROVINCE TO PROVINCE.

Contact Insignia:

**1-877-467-4289**

[www.insigniaproducts.com](http://www.insigniaproducts.com)

INSIGNIA is a trademark of Best Buy and its affiliated companies.

\*Distributed by Best Buy Purchasing, LLC

7601 Penn Ave South, Richfield, MN 55423 U.S.A.

©2019 Best Buy. All rights reserved.

**Made in China**



INSIGNIA™

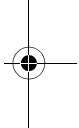
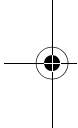

[www.insigniaproducts.com](http://www.insigniaproducts.com)  
1-877-467-4289 (U.S. and Canada) or 01-800-926-3000 (Mexico)

INSIGNIA is a trademark of Best Buy and its affiliated companies.  
Distributed by Best Buy Purchasing, LLC  
7601 Penn Ave South, Richfield, MN 55423 U.S.A.  
©2019 Best Buy. All rights reserved.  
**Made in China.**

V1 ENGLISH  
19-0079

