

# Technical Documentation

## Print Instructions



### Standard Requirements:

- ▶ Paper quality must be 80% ISO white and 100% recycled (exception for Straubing plant)
- ▶ Paper must be printed in both sides
- ▶ Printing technology must be offset or digital and made by a professional supplier
- ▶ Paper sizes are A3, A4 and a mix between ISO and American standards with 2mm tolerance
- ▶ Exceptions must be mentioned in the "Special requirements" field

### Special Requirements:

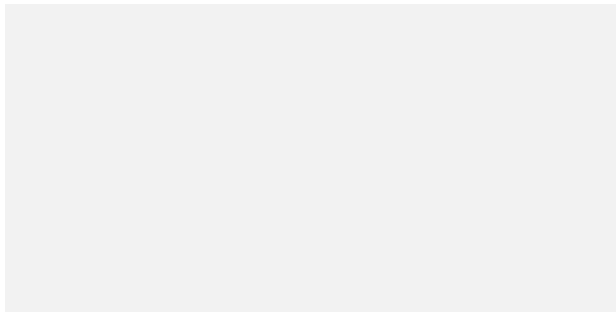

ECR F03X XXXXXX  
Release date

**NOTE:** For questions regarding the information in this document or about the document referred please contact the author.

**Author and department**  
Pedro Mesquita MKW4

**Pages number**  
44

**Template**  
Midatlantic



**Product family**  
EVOLVE 50M

**SAP number**  
F01U393750

**Paper**  
80g/m2 IOR

**Document version**  
1

**Color**  
Grayscale

**Cover**  
same as paper weight

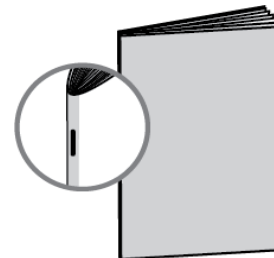

### Saddle-Stitch

Saddle-stitched bindings are stapled through the center-fold and wrap a set of nested sheets into one book. Maximum 100 pages.

# **EVOLVE Portable Column Loudspeaker**

EVOLVE50M-SB-EU | EVOLVE50M-SB-US | EVOLVE50M-SW |  
EVOLVE50-TW | EVOLVE50-TB

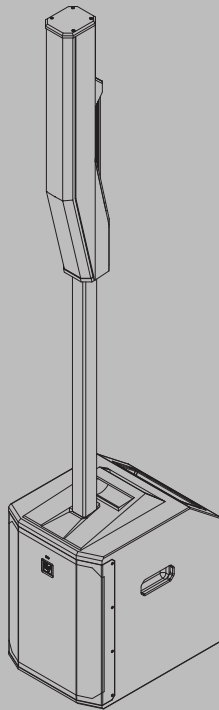





## Table of contents

<b>1</b>	<b>Safety</b>	<b>4</b>
1.1	Important safety instructions	4
1.2	FCC information	6
1.3	Precautions	7
1.4	Certifications	7
1.5	Notices	8
<b>2</b>	<b>Short information</b>	<b>10</b>
2.1	Shipping contents	10
<b>3</b>	<b>Description</b>	<b>11</b>
<b>4</b>	<b>Installation</b>	<b>13</b>
<b>5</b>	<b>Amplifier DSP</b>	<b>14</b>
5.1	Amplifier DSP controls	14
5.2	System status	16
5.3	DSP control menu	17
<b>6</b>	<b>Mixer operation</b>	<b>29</b>
6.1	Inputs 1-4, 5/6 & 7/8	29
6.2	QuickSmart Link configuration	30
<b>7</b>	<b>Pairing the QuickSmart Mobile application</b>	<b>32</b>
<b>8</b>	<b>Recommended configurations</b>	<b>34</b>
8.1	Stereo pair of Evolve 50M systems	34
8.2	Solo musician performance	36
<b>9</b>	<b>Troubleshooting</b>	<b>37</b>
<b>10</b>	<b>Technical data</b>	<b>39</b>
10.1	Dimensions	40

# 1 Safety

## 1.1 Important safety instructions

 <p><b>WARNING:</b> TO REDUCE THE RISK OF FIRE OR ELECTRIC SHOCK, DO NOT OVEREXPOSE THIS APPLIANCE TO RAIN OR MOISTURE</p> <p><b>AVIS:</b> RISQUE DE CHOC ELECTRIQUE, NE PAS OUVRIR.</p> <p><b>WARNING:</b> THE MAINS PLUG OR AC INLET IS USED AS A DISCONNECT DEVICE. THE DISCONNECT DEVICE SHALL REMAIN READILY OPERABLE.</p> <p><b>WARNING:</b> CONNECT ONLY TO MAINS SOCKET WITH PROTECTIVE EARTHING CONNECTION.</p> <p><b>WARNING:</b> TO REDUCE THE RISK OF ELECTRIC SHOCK, DO NOT REMOVE COVER (OR BACK) AS THERE ARE NO USER-SERVICABLE PARTS INSIDE. REFER SERVICING TO QUALIFIED PERSONNEL.</p>		<p>The lightning flash with arrowhead symbol, within an equilateral triangle is intended to alert the user to the presence of uninsulated “dangerous voltage” within the product’s enclosure that may be sufficient magnitude to constitute a risk of electric shock to persons.</p>
		<p>The exclamation point within an equilateral triangle is intended to alert the user to the presence of important operating and maintenance (servicing) instructions in the literature accompanying the appliance.</p>
		<p>The asterisk within an equilateral triangle is intended to inform the user to necessary installation or removal instructions regarding equipment or hardware use relating to the system.</p>

1. Read these instructions.
2. Keep these instructions.
3. Heed all warnings.
4. Follow all instructions.
5. Do not use this apparatus near water.
6. Clean only with a dry cloth.
7. Do not block any ventilation openings. Install in accordance with the manufacturer's instructions.
8. Do not install near any heat sources such as radiators, heat registers, stoves, or other apparatus (including amplifiers) that produce heat.
9. Do not defeat the safety purpose of the polarized or grounding-type plug. A polarized plug has two blades with one wider than the other. A grounding type plug has two blades and a third grounding prong. The wide blade or the third prong is provided for your safety. If the provided plug does not fit into your outlet, consult an electrician for replacement of the obsolete outlet.
10. Protect the power cord from being walked on or pinched particularly at plugs, convenience receptacles, and the point where they exit from the apparatus.
11. Only use attachments/accessories specified by the manufacturer.
12. Use only with the cart, stand, tripod, bracket, or table specified by the manufacturer, or with the apparatus. When a cart is used, use caution when moving the cart/apparatus combination to avoid injury from tip-over.
13. Unplug the apparatus during lightning storms or when unused for long periods of time.

14. Refer all servicing to qualified service personnel. Servicing is required when the apparatus has been damaged in any way, such as power-supply cord or plug is damaged, liquid has been spilled or objects have fallen into the apparatus, the apparatus has been exposed to rain or moisture, does not operate normally, or has been dropped.
15. No naked flame sources, such as lighted candles, should be placed on the apparatus.
16. To reduce the risk of fire or electric shock, do not expose this apparatus to rain or moisture. The apparatus should not be exposed to dripping or splashing. Objects filled with liquids, such as vases should not be placed on apparatus.
17. Do not block any ventilation openings. Install in accordance with the manufacturer's instructions.
18. Minimum 60 cm (2 ft) distances around the apparatus for sufficient ventilation.
19. The ventilation should not be impeded by covering the ventilation openings with items, such as newspapers, table-cloths, curtains, etc.
20. To completely disconnect AC power from this apparatus, the power supply cord must be unplugged.

**Warning!**

Apparatets stikprop skal tilsluttes en stikkontakt med jord som giver forbindelse til stikproppens jord.

Laite on liitettävä suojakoskettimilla varustettuun pistorasiaan

Apparatet må tilkoples jordet stikkontakt

Apparaten skall anslutas till jordat uttag

**Warning!**

This product is not designed to be suspended. Do NOT use handles or any other method to suspend the loudspeaker. Handles on Electro-Voice loudspeakers are intended to only be used for temporary transport by people.

Items, such as fiber rope, wire rope, cables, or other types of materials cannot be used to suspend loudspeaker from the handles.

**Warning!**

Use of non-authorized accessories or attachments with this or any Electro-Voice product is at your own discretion. Use of non-authorized accessories or attachments can result in product malfunction, injury, or death.

The user assumes all liability and may result in the warranty being voided.

**Caution!**

Do not attempt to move this loudspeaker system when it is fully assembled.

You may damage the system or cause personal injury.

**Caution!**

To maintain tip-over stability, do not use EVOLVE 30M 2-piece sub-pole with EVOLVE 50 column speaker array or subwoofer.

Doing so may result in damage, and/or personal injury

**Caution!**

For optimal acoustics and performance, ONLY use EVOLVE 50/50M column speaker array with the EVOLVE 50/50M subwoofer. Do not use EVOLVE 50/50M column speaker array or subwoofer with EVOLVE 50/50M column speaker array or subwoofer.

Doing so may result in poor acoustic performance, permanent damage, and void of warranty.

**1.2****FCC information**

This device complies with Part 15 of the FCC Rules. Operation is subject to the following two conditions:

- (1) This device may not cause harmful interference, and
- (2) This device must accept any interference received, including interference that may cause undesired operation.

**Notice!**

This product has been tested and found to comply with the limits for a Class B digital device, pursuant to Part 15 of the FCC Rules. These limits are designed to provide reasonable protection against harmful interference in a residential installation. This product generates, uses, and can radiate radio frequency energy and, if not installed and used in accordance with the instructions, may cause harmful interference to radio communications.

However, there is no guarantee that interference will not occur in a particular installation. If this product does cause harmful interference to radio or television reception, which can be determined by turning the equipment off and on, the user is encouraged to try to correct the interference by one or more of the following measures:

- Reorient or relocate the receiving antenna.
- Increase the separation between the equipment and receiver.
- Connect the equipment into an outlet on a circuit different from that to which the receiver is connected.
- Consult the dealer or an experienced radio/TV technician for help.



The device has been granted by FCC and IC, the FCC ID:ESVEVOLVE and IC:1249A-EVOLVE30M

Please take attention that changes or modification not expressly approved by the party responsible for compliance could void the user's authority to operate the equipment.

This equipment should be installed and operated with a minimum distance of 20cm between the radiator and your body.

This device complies with Industry Canada license-exempt RSS standard(s). Operation is subject to the following two conditions:

- (1) this device may not cause interference, and
- (2) this device must accept any interference, including interference that may cause undesired operation of the device.

Le présent appareil est conforme aux CNR d'Industrie Canada applicables aux appareils radioexempts de licence. L'exploitation est autorisée aux deux conditions suivantes :





- (1) l'appareil ne doit pas produire de brouillage, et
- (2) l'utilisateur de l'appareil doit accepter tout brouillage radioélectrique subi, même si le brouillage est susceptible d'en compromettre le fonctionnement.

Under Industry Canada regulations, this radio transmitter may only operate using an antenna of a type and maximum (or lesser) gain approved for the transmitter by Industry Canada. To reduce potential radio interference to other users, the antenna type and its gain should be so chosen that the equivalent isotropically radiated power (e.i.r.p.) is not more than that necessary for successful communication.

Conformément à la réglementation d'Industrie Canada, le présent émetteur radio peut fonctionner avec une antenne d'un type et d'un gain maximal (ou inférieur) approuvé pour l'émetteur par Industrie Canada. Dans le but de réduire les risques de brouillage radioélectrique à l'intention des autres utilisateurs, il faut choisir le type d'antenne et son gain de sorte que la puissance isotrope rayonnée équivalente (p.i.r.e.) ne dépasse pas l'intensité nécessaire à l'établissement d'une communication satisfaisante.

ce matériel est conforme aux limites de dose d'exposition aux rayonnements, FCC / CNR-102 énoncée dans un autre environnement.cette equipment devrait être installé et exploité avec distance minimale de 20 entre le radiateur et votre corps.

### 1.3 Precautions

	<p>If an Electro-Voice loudspeaker is used outdoors on a sunny day, place the loudspeaker in a shaded or covered area. The loudspeaker amplifiers have protection circuits that temporarily shut the loudspeaker off when extremely high temperatures are reached. This can happen on hot days when the loudspeaker is in direct sunlight.</p>
	<p>Do not use Electro-Voice loudspeakers in an environment where temperatures are below 0°C (32°F) or exceed +35°C (95°F).</p>
	<p>Never expose an Electro-Voice loudspeaker to rain, water, or high moisture.</p>
	<p>Electro-Voice loudspeakers are easily capable of generating sound pressure levels sufficient to cause permanent hearing damage to anyone within normal coverage distance. Caution should be taken to avoid prolonged exposure to sound pressure levels exceeding 90 dB.</p>

### 1.4 Certifications

**Brazil:**

Após uma perturbação da rede elétrica, o EVOLVE pode entrar em estado de segurança. Neste caso, você deve desligar e ligar o dispositivo novamente.

**Mexico:**

“La operación de este equipo está sujeta a las siguientes dos condiciones: (1) es posible que este equipo o dispositivo no cause interferencia perjudicial y (2) este equipo o dispositivo debe aceptar cualquier interferencia, incluyendo la que pueda causar su operación no deseada”

- EVOLVE 50M (RCPBOEV20-1717)
- EVOLVE50M-SB-US (RCPBOEV20-1717-A5)
- EVOLVE50M-SB-EU (RCPBOEV20-1717-A6)
- EVOLVE50M-SW (RCPBOEV20-1717-A7)

**Republic of Korea:**

R-C-B6S-ESVEVOLVE

제품명:	앰프내장형 스피커
모델명:	EVOLVE50M
정격:	100-240 Vac, 50-60 Hz, 1000 W
수입업체(상호)명:	로버트보쉬코리아(유)
제조사:	Bosch Security Systems, LLC.
제조연월:	별도표기
제조국:	중국
A/S:	02-702-2846

해당 무선설비는 운용 중 전파혼신 가능성이 있음  
 해당 무선설비는 전파혼신 가능성이 있으므로 인명안전과 관련된 서비스는 할 수 없습니다.

**United Arab Emirates:**

TRA Registered no.: ER77128/19

Dealer no.: DA45733/15

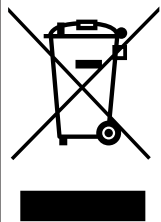
**1.5****Notices****Old electrical and electronic equipment**

This product and/or battery must be disposed of separately from household waste. Dispose such equipment according to local laws and regulations, to allow their reuse and/or recycling. This will help in conserving resources, and in protecting human health and the environment.

**Copyright and disclaimer**

All rights reserved. No part of this document may be reproduced or transmitted in any form by any means, electronic, mechanical, photocopying, recording, or otherwise, without the prior written permission of the publisher. For information on getting permission for reprints and excerpts, contact Electro-Voice.

All content including specifications, data, and illustrations in this manual are subject to change without prior notice.

**Notice!**

Bluetooth® is available in select countries.

Contact your nearest Electro-Voice dealer or Electro-Voice distributor for more information.

The Bluetooth® word mark and logos are registered trademarks owned by Bluetooth SIG, Inc. and any use of such marks by Bosch Security Systems, Inc. is under license. Other trademarks and trade names are those of their respective owners.



## For use in China: CHINA ROHS DISCLOSURE TABLE

针对在中国境内的使用：CHINA ROHS披露表

扬声器

根据SJ/T 11364-2014编制的有害物质表						
	Pb (Pb)	Hg (Hg)	Cd (Cd)	Cr 6+ (Cr 6+)	PBB (PBB)	PBDE (PBDE)
电路板	○	○	○	○	○	○
电子组件	x	○	○	○	○	○
换能器	x	○	○	○	○	○
显示屏	x	○	○	○	○	○
电缆和导线	○	○	○	○	○	○
塑料材料	○	○	○	○	○	○
金属材料	x	○	○	○	○	○
木质和纸质材料	○	○	○	○	○	○
涂料与涂层	○	○	○	○	○	○
本表系根据SJ/T 11364的规定编制而成						
○：上述有害物质在所有包含该物质的均质材料中的含量均低于GB/T 26572规定的限值						
x：上述有害物质在特定均质材料中的含量均高于GB/T 26572规定的限值						

关于该类产品生产日期代码的详细说明，请见：

<http://www.boschsecurity.com/datecodes/>

## 2 Short information

The following table lists products in a family, with CTN (Commercial Type Number) and identifying product name DESCRIPTION.

CTN	Description
EVOLVE50-TB	Column speaker array, pole, black
EVOLVE50M-SB-US	Column speaker sub US, black
EVOLVE50M-SB-EU	Column speaker sub EU, black
EVOLVE50-TW	Column speaker array, pole, white
EVOLVE50M-SW	Column speaker sub, US & EU, white
EVOLVE50-PL-SB	Column speaker pole, short, black
EVOLVE50-PL-SW	Column speaker pole, short, white
EVOLVE50-CASE	Column speaker carrying case, wheels
EVOLVE50-SUBCVR	Subwoofer Cover

### 2.1 Shipping contents

Quantity	Component
1	Subwoofer
1 (2 for EVOLVE50M-SW)	Power cord
1	User manual
1	Safety manual

Tab. 2.1: EVOLVE50M-SB-US, EVOLVE50M-SB-EU, EVOLVE50M-SW

Quantity	Component
1	Column array
1	Sub pole
1	Carry bag

Tab. 2.2: EVOLVE50-TB, EVOLVE50-TW

### 3 Description

Thank you for choosing an Electro-Voice portable column system. Please take time to consult the manual to understand all the features built into your EV system and fully utilize its performance capabilities.

Designed to deliver a step up in sound quality and set a new performance standard for compact column speaker systems - EVOLVE 50M is perfect for solo musicians, small groups, mobile entertainers and smaller venues that need an easy-to-use, highly portable and lightweight system with extraordinary coverage and output for its size. EVOLVE 50M comes ready to go with speaker array, symmetrical aluminum pole connectors with internal wire assembly and magnetically assisted latching, subwoofer, and included pole/array carry case - all designed to pack up compactly, set up and tear down quickly, look great on stage, and withstand real-world wear and tear.

Professional-grade EV-engineered components and build quality - The full-range column array and its eight 3.5" neodymium drivers provide room-filling ultra-wide 120° coverage via custom-designed waveguides; array-formed 40° asymmetrical vertical coverage ensures acoustic output is directed towards both sitting and standing audience members. The array enclosure is constructed from a durable composite material and incorporates an ergonomic aluminum handle. Four tuning ports are located on the rear of the enclosure for acoustic optimization. A 12" subwoofer is housed in a 15 mm wood enclosure with a high-efficiency laminar-flow vent design, for enhanced rigidity and acoustical performance. The Class-D amplifier provides up to 1000 W of output power. The speakers are protected by a black powder-coated 18 ga. steel grille. Combined, these components generate a genuinely stunning performance to size ratio - an elegant form factor that looks as good as it sounds.

The most extensive feature set in its class - The EVOLVE 50M has an integrated full-function and fully programmable eight-channel digital mixer with multiple inputs (4x XLR/TRS combo line/mic inputs, 1x XLR/TRS stereo line input, 1x RCA, 1x 3.5 mm stereo, 1x Hi-Z instrument input, wireless Bluetooth® Audio Input), and professional-grade preamps and mixer functions - all designed in collaboration with the world-class mixer engineering team at Electro-Voice's sibling brand Dynacord. For the performing musician, Hi-Z and foot switch inputs are included for flexible system configuration, and a range of onboard studio-quality effects (30 presets, including chorus, delay, flange and reverb, via two FX channels) add myriad options for finessing your sound. This reduces set-up time - and on-stage clutter - by minimizing the need for external equipment such as a mixer and effects pedals, which also makes loading in and out of the venue quicker. High-resolution, low-latency Bluetooth®\* streaming ensures exceptional results for music playback or accompaniment.

EVOLVE 50M features class exclusive QuickSmart Link technology. QuickSmart Link allows users to easily create a digital audio and control link between two EVOLVE 50M systems using a common network cable. When connected, both EVOLVE 50M systems auto configure to allow use of both mixer inputs, and sync stereo output mix and system controls.

The next-generation Electro-Voice Quick**Smart** Mobile application utilizes Bluetooth® Low Energy (BTLE) technology for the wireless configuration, control, mixing and monitoring of all parameters of up to six EVOLVE 50M systems simultaneously, and is fully programmable. The full-function GUI allows intuitive control of all system functions from your mobile device. EVOLVE 50M offers simple or sophisticated operation according to your application, making great sound easy for users of all levels.

EV's industry-leading Quick**Smart** DSP interface - Allowing intuitive navigation of system parameters via an LCD with single-knob control - as well as multiple options for signal routing and inputs. Setup is simple via four presets (Music, Live, Speech, Club), three-band system

EQ (low, mid, high), seven-band graphic EQ (in Mixer mode), five user-programmable presets (Store and Recall settings), phantom power\*, visual monitoring of limiter status, input level control and meters, and master volume control to optimize gain structure.

\*+15V phantom power is always on and available on INPUTS 1-4 XLR connectors only. TRS connector does not have phantom power. A safety circuit is employed to prevent damage to devices not requiring phantom power (e.g. dynamic microphones, mixer outputs, etc...)

## 4 Installation



### Caution!

Do not attempt to move this loudspeaker system when it is fully assembled. You may damage the system or cause personal injury.

### Assembling the loudspeaker system

To **assemble the loudspeaker system**, do the following:

1. Place the **subwoofer** on a level and stable surface.
2. Insert the pole into the subwoofer base.  
The pole has magnets (A) at each end.
3. Place the **column array loudspeaker system** on top of the subwoofer pole.
4. The **column array loudspeaker system** set up is complete.

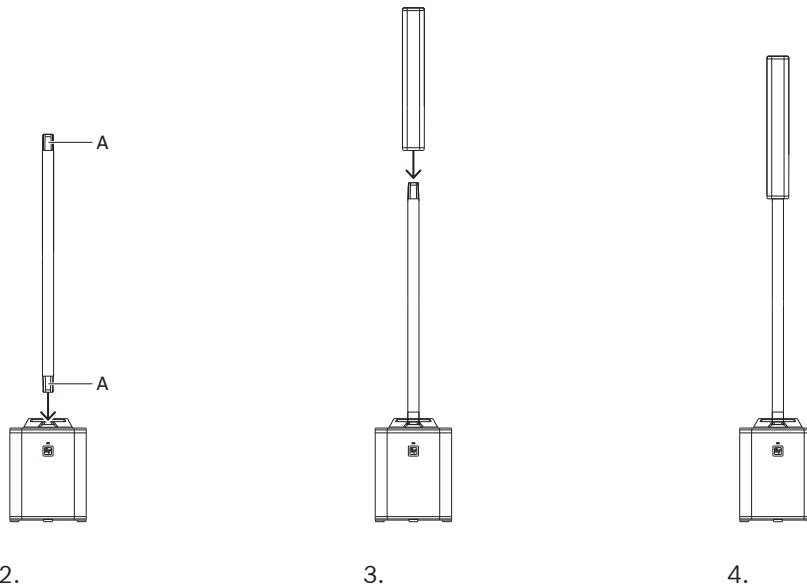

## 5 Amplifier DSP

### 5.1 Amplifier DSP controls

The amplifier has a combination of controls and connectors to ensure the most versatile loudspeaker system.

#### Portable column system control and monitoring interface

The portable column system DSP control menu selections are available for the EVOLVE.

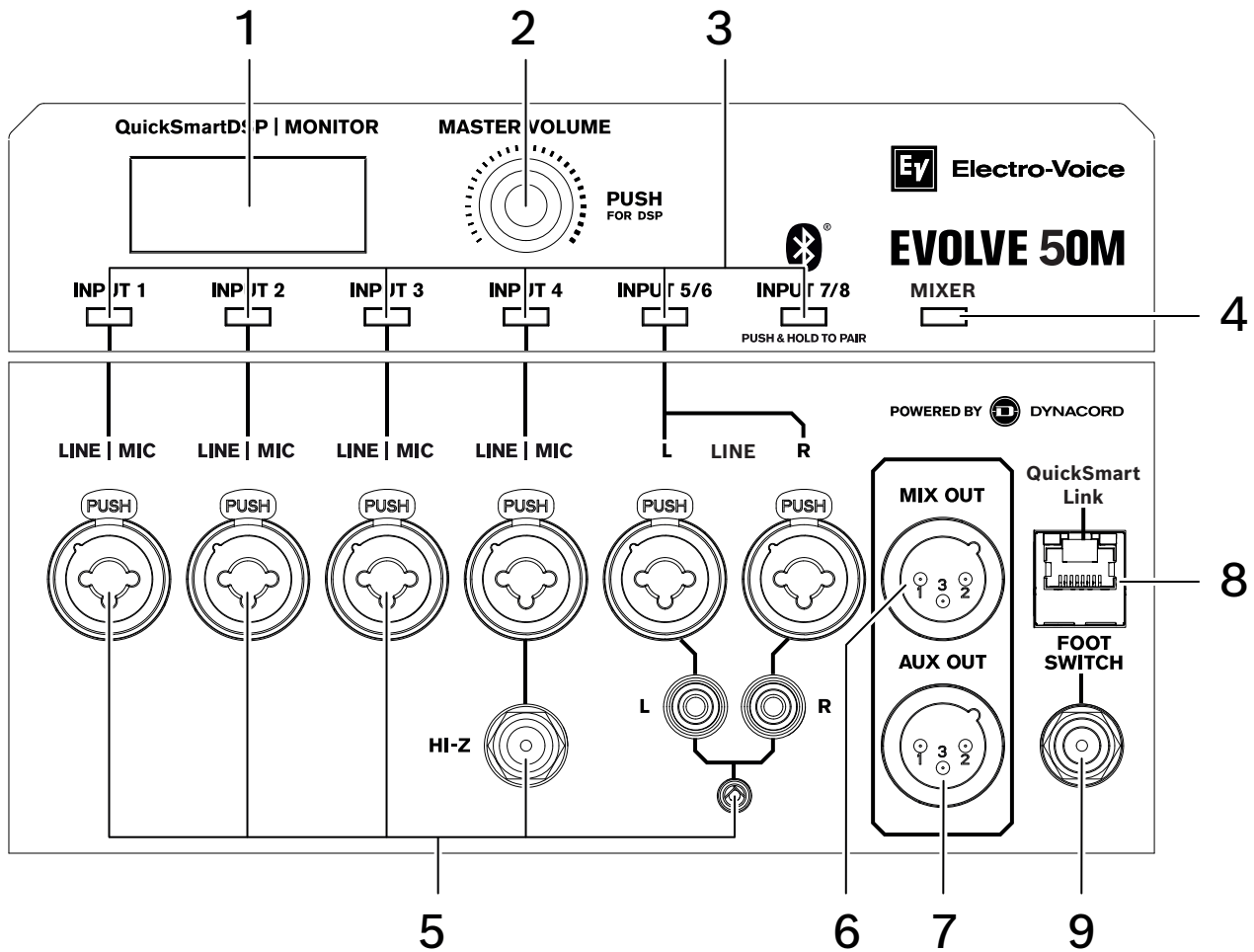

1. **LCD** – DSP control and monitoring interface.
2. **MASTER VOL** – Adjusts the sound level.  
**DSP** – Scroll through the menu and select the available choices. Push the MASTER VOL knob to enter the DSP menu.
3. **INPUT selection soft keys** - Selects channels INPUT 1 through INPUT 7/8 for channel DSP settings and individual level settings.
4. **MIXER selection soft key** - accesses mixer controls in DSP (e.g. Level, GEQ, effects and signal routings).
5. **INPUT 1-4, 5/6 & 7/8** - Electronically balanced INPUT 1 thru INPUT 4 for the connection of a microphone or line level signal source. Establishing a connection is possible via TRS or XLR-type plugs. Phantom Power (+15 V) is always enabled on INPUTS 1-4 on the XLR connectors only. INPUT 4 includes a HI-Z input below the TRS/XLR combo plug for connection to a high impedance instrument output via a TS plug. Stereo INPUT 5/6 for

connection of stereo line level signals. Connection is made using either two XLR-type, TRS, RCA, or a single 1/8th inch stereo connector. Input 7/8 is reserved for stereo Bluetooth audio connection.

6. **MIX OUT** - The post-fader audio signals of INPUT 1 through INPUT 7/8 are mixed and passed to MIX OUT. The ratio of the input signals changes when the level controls INPUT 1 - 7/8 are adjusted. This feature allows the loudspeaker to act as a basic eight-channel mixer that can send the mix to another loudspeaker via the MIX OUT socket. The output is configurable in the menu to provide either the Mixer Mono, Stereo left or Stereo right signal. If QuickSmart Link is used, MIX OUT provides the same signal as the column system.
7. **AUX OUT** - The AUX OUT is configurable to provide either a separate post fader audio mix of INPUT1 - 7/8 (controlled by individual channel AUX levels adjustable in DSP) or the main mix output signal. In the case of main mix, the full mix including effects is provided whereas the separate aux mix comes without effects.
8. **QuickSmart Link** - RJ45 connector for Cat5 cable to link two EVOLVE 50M systems together for digital audio and system control. QuickSmart Link should only be used to connect two EVOLVE 50M systems. QuickSmart Link is not an Ethernet/LAN port and is not compatible with network devices.
9. **FOOT SWITCH** - ON/OFF control of DSP user selectable audio FX.

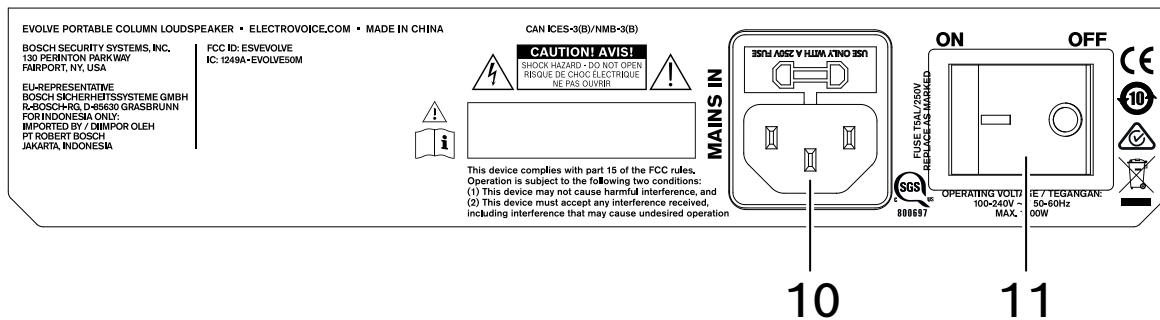

10. **MAINS IN** – The device receives its power supply via the MAINS IN socket. Only the provided power cord may be used. Connect the device only to a mains network, which corresponds to the requirements indicated on the type plate.
11. **POWER** - AC switch for switching the power ON or OFF. The LCD screen lights up when the power is turned ON, after approximately 1 second.



**Notice!**

Markings and statements on amplifier panel may vary.

## 5.2

### System status

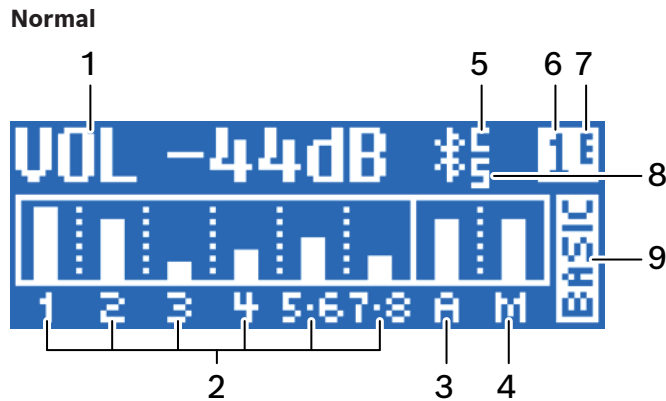

**Figure 5.1:** Normal system status home screen with Bluetooth® status

1. **VOLUME (VOL)** - Indicates the master gain of the system in dB. The range is from mute to +10 dB, in 1 dB increments.
2. **1, 2, 3, 4, 5-6, 7-8** - VU meter displays the signal level of INPUT1 through 7/8 into the amplifier. Input levels are independent of each other.
3. **AUX** - VU meter displays the signal level of the AUX output. AUX level is independent of MAIN levels.
4. **MAIN** - VU meter displays the signal level of the MAIN output. MAIN level is independent of AUX levels.
5. **C** - Control app; the available options are:  
OFF - DISABLED  
FLASHING - PAIRING MODE  
SOLID - CONNECTED
6. **1** - Indicates the selected store function number. There are five user defined store function numbers available.
7. **E** - Indicates the preset is not saved. When the preset is saved the E is not displayed.
8. **S** - Audio streaming; the available options are:  
OFF - DISABLED  
FLASHING - PAIRING MODE (120s)  
SOLID - CONNECTED
9. **FUNCTION indicator** - Indicates whether the system is in MIXER or BASIC mode.



#### Notice!

Bluetooth® is available in select countries.

Contact your nearest Electro-Voice dealer or Electro-Voice distributor for more information.

#### System protection

System protection limiters indicate when a system is exceeding recommended usage by indicating CLIP or LIMIT on the LCD display.

#### CLIP

**CLIP** indicates the signal to the loudspeaker is too high, resulting in a clipped signal into the loudspeaker. If CLIP is shown, reduce the input gain and/or the signal on the mixer or source equipment.



**LIMIT**

**LIMIT** protects the loudspeaker from short-term peaks which can cause distortion. When **LIMIT** is shown on the screen the limiter is active. Reducing the output volume (MASTER VOL) is strongly recommended when the limit indication is shown often or continuously.

**5.3**

**DSP control menu**

**DSP control main menu (Basic mode)**

VOLUME		0 dB (Default) Mute, -80 dB +10 dB (1 dB)
	EXIT	
	FUNCTION	<b>Basic</b> Mixer
	MODE	MUSIC (Default) LIVE SPEECH CLUB
	SYS DELAY	OFF (Default) to 100 m (.1 m) (0 ft to 328.1ft)
	SUB DELAY	OFF (Default), -10 m to +10 m (.1 m) (-32.8 ft to 32.8 ft)
	SUB LEVEL	0 dB (Default) Mute, -80 dB to +10 dB (1 dB)
	TREBLE	0 dB (Default) -12 dB to +6 dB (1 dB)
	MID	0 dB (Default) -12 dB to +6 dB (1 dB)
	BASS	0 dB (Default) -12 dB to +6 dB (1 dB)
	BLUETOOTH	BLUETOOTH ON (Default) OFF
		CONTROL PAIR CONTROL PAIRING
		AUDIO PAIR AUDIO PAIRING
	LED	OFF ON (Default) LIMIT
	DISPLAY	LCD DIM ON (Default) OFF
		BRIGHT 5 (Default) 1 to 10
		CONTRAST 5 (Default) 1 to 10

STORE	EXIT, 1, 2, 3, 4, 5, EXIT
RECALL	EXIT, 1, 2, 3, 4, 5, 6, EXIT
RESET	RESET ARE YOU SURE? NO (Default) YES
INFO	PRODUCT NAME FIRMWARE VERSION © 2020 Electro-Voice
EXIT	

**DSP control main menu (Mixer mode)**

VOLUME		0 dB (Default) Mute, -80 dB +10 dB (1 dB)
	EXIT	
	FUNCTION	<b>Basic</b> Mixer
	MODE	MUSIC (Default) LIVE SPEECH CLUB
	SUB DELAY	OFF (Default), -10 m to +10 m (.1 m) (-32.8 ft to 32.8 ft)
	SUB LEVEL	0 dB (Default) Mute, -80 dB to +10 dB (1 dB)
	TREBLE	0 dB (Default) -12 dB to +6 dB (1 dB)
	MID	0 dB (Default) -12 dB to +6 dB (1 dB)
	BASS	0 dB (Default) -12 dB to +6 dB (1 dB)
	BLUETOOTH	BLUETOOTH ON (Default) OFF
		CONTROL PAIR CONTROL PAIRING
		AUDIO PAIR AUDIO PAIRING
	LED	OFF ON (Default) LIMIT
DISPLAY	LCD DIM	ON (Default)

		OFF
	BRIGHT	5 (Default) 1 to 10
	CONTRAST	5 (Default) 1 to 10
STORE		EXIT, 1, 2, 3, 4, 5, EXIT
RECALL		EXIT, 1, 2, 3, 4, 5, 6, EXIT
RESET		RESET ARE YOU SURE?
		NO (Default)
		YES
INFO		PRODUCT NAME
		FIRMWARE VERSION
		© 2020 Electro-Voice
EXIT		

**DSP control menu for Input 1-4 (Mixer mode)**

LEVEL		0 dB (Default) Mute, -80 to +10 dB (1 dB)
	EXIT	
	INPUT PRESET	FLAT LOW CUT 80 LOW CUT 120 VOCAL MIC VOICE FILTER SPEECH ACOUST GUIT ELECTR GUIT BASS GUITAR PERCUSSION LINE INPUT More input presets available with firmware updates.
	COMP	OFF, 1 to 100
	TREBLE	0 dB (Default) -12 dB to +12 dB (1 dB)
	MID	0 dB (Default) -12 dB to +12 dB (1 dB)
	BASS	0 dB (Default) -12 dB to +12 dB (1 dB)
	FX1	OFF (Default) -80dB TO +10dB (1dB)
	FX2	OFF (Default) -80dB TO +10dB (1dB)
	AUX*	OFF (Default) -80dB TO +10dB (1dB)
	PAN*	C (Default) 10L to 10R
	EXIT	

**DSP control menu for Input 5/6 (Mixer mode)**

LEVEL		0 dB (Default) -80 dB to +10 dB (1 dB)
	EXIT	
	MONO	OFF/ON
	TREBLE	0 dB (Default) -12 dB to +12 dB (1 dB)

MID	0 dB (Default) -12 dB to +12 dB (1 dB)
BASS	0 dB (Default) -12 dB to +12 dB (1 dB)
FX1	OFF (Default) -80dB TO +10dB (1dB)
FX2	OFF (Default) -80dB TO +10dB (1dB)
AUX*	OFF (Default) -80dB TO +10dB (1dB)
BAL*	C (Default) 10L to 10R
EXIT	

**DSP control menu for Input 7/8 (Mixer mode)**

LEVEL		0 dB (Default) -80 dB to +10 dB (1 dB)
EXIT		
TREBLE		0 dB (Default) -12 dB to +12 dB (1 dB)
MID		0 dB (Default) -12 dB to +12 dB (1 dB)
BASS		0 dB (Default) -12 dB to +12 dB (1 dB)
AUX*		OFF (Default) -80dB TO +10dB (1dB)
BAL*		C (Default) 10L to 10R
BLUETOOTH	BLUETOOTH	ON (Default) OFF
	CONTROL PAIR	CONTROL PAIRING
	AUDIO PAIR	AUDIO PAIRING
EXIT		

\* NOTE: PAN and BAL controls only visible when MIXOUT is set to “Stereo L” or “Stereo R”.  
AUX controls only visible when AUX OUT is set to AUX MIX.

**DSP control menu for Mixer controls (Mixer mode)**

LEVEL			0 dB (Default) -80 dB to +10 dB (1 dB)	
	EXIT			
	AUX LEVEL		0 dB (Default) -80 dB to +10 dB (1 dB)	
	MAIN GEQ	ENABLE	On/Off	
		63Hz	0 dB (Default) -12 dB to +12 dB (1 dB)	
		160Hz	0 dB (Default) -12 dB to +12 dB (1 dB)	
		400Hz	0 dB (Default) -12 dB to +12 dB (1 dB)	
		1KHz	0 dB (Default) -12 dB to +12 dB (1 dB)	
		2.5KHz	0 dB (Default) -12 dB to +12 dB (1 dB)	
		6KHz	0 dB (Default) -12 dB to +12 dB (1 dB)	
		12KHz	0 dB (Default) -12 dB to +12 dB (1 dB)	
		RESET	Reset all bands? Yes/No	
		BACK		
	AUX GEQ	ENABLE	On/Off	
		63Hz	0 dB (Default) -12 dB to +12 dB (1 dB)	
		160Hz	0 dB (Default) -12 dB to +12 dB (1 dB)	
		400Hz	0 dB (Default) -12 dB to +12 dB (1 dB)	
		1KHz	0 dB (Default) -12 dB to +12 dB (1 dB)	
		2.5KHz	0 dB (Default) -12 dB to +12 dB (1 dB)	
		6KHz	0 dB (Default) -12 dB to +12 dB (1 dB)	
12KHz		0 dB (Default) -12 dB to +12 dB (1 dB)		

		RESET	Reset all bands? Yes/No
		BACK	
	FX1	00: OFF	
		01: ECHO+REV LONG (default)	
		02: ECHO+REV SHORT	
		03: REV ROOM	
		04: REV CONCERT	
		05: REV HALL	
		06: REV CHURCH	
		07: REV CATHEDRAL	
		08: REV ROOM S	
		09: REV CONCERT S	
		10: REV HALL S	
		11: REV CHURCH S	
		12: REV CATHEDRAL S	
		13: PLATE MEDIUM	
		14: PLATE LONG	
		15: PLATE MEDIUM S	
		16: PLATE LONG S	
		17: DEL SHORT	
		18: DEL LONG	
		19: DEL SHORT S	
		20: DEL LONG S	
		21: ECHO+CHORUS	
		22: REVERSE	
	FX2	00: OFF	
		01: CHORUS SLOW (default)	
		02: CHORUS MEDIUM	
		03: CHORUS FAST	
		04: CHORUS+ECHO	
		05: JET FLANGER	
		06: DOUBLING NARROW	
		07: DOUBLING MEDIUM	

		08: DOUBLING WIDE
	FX ENABLE	ON OFF
	AUX OUT	Aux Mix Main Mix
	SPK OUT	L+R L R
	MIX OUT	L+R L R
EXIT		

**EXIT Menu**

The **Exit menu** is used to return to the home screen.

**FUNCTION Menu**

The **FUNCTION menu** is used to configure between Basic and Mixer functions.

- **BASIC** - provides input and output gain controls, 3-band EQ, and system delay for simplified audio setups or used as satellite or R-channel stereo setup.
- **MIXER** - provides full access and control of 8-channel digital mixer with AUX outs, FX, and 7-band GEQ.

**MODE Menu**

The **Mode menu** is used to configure the type of sound the EVOLVE column speaker system delivers.

- **MUSIC** – is used for recorded music playback and electronic dance music applications. (Default)
- **LIVE** – is used for live sound applications.
- **SPEECH** – is used for spoken word applications.
- **CLUB** – is used for recorded electronic music playback.

**MAIN LEVEL Menu (Mixer mode)**

The **MAIN LEVEL menu** is used to control the overall mixer output level that is fed to the EVOLVE column speaker system and the MIX OUT connector.

**AUX LEVEL Menu (Mixer mode)**

The **AUX LEVEL menu** is used to control the overall level of the signal present at the AUX OUT connector.

**SYS DELAY Menu (Basic mode)**

The **SYS Delay menu** is used to delay the output signal, e.g. to compensate for differences in distance among individual loudspeakers. The delay can be set in meters or feet. Available options for this selection are OFF or a delay up to 100.0 m (328 ft). The delay can be changed in 0.1-meter increments or 0.1-foot increments.

The default is OFF.



### SUB DELAY Menu

The **SUB DELAY** menu is used to acoustically align subwoofer and column speaker if used with an Electro-Voice authorized mounting bracket. The delay can be set in meters. The range is from -10 m to +10 m, default setting is OFF. Positive values are used if the subwoofer is located closer to the audience (in front of the column), negative values are used if the subwoofer is further away from the audience (behind the column).



#### Notice!

Do not change this value if subwoofer and column are connected with the connector pole. This may cause unwanted acoustic changes to the system sound.

### SUB LEVEL Menu

The **Sub Level menu** allows independent gain control of the subwoofer output. Changes to this parameter effectively change the crossover of the EVOLVE system. The default setting of 0 dB is recommended for best audio performance.

The range is MUTE, -80 dB to +10 dB.

The default is 0 dB.

### TREBLE Menu

The **Treble menu** is used to adjust the high frequency performance of the loudspeaker for different applications or personal preference.

The range is -12 dB to +6 dB for Main system EQ. The range is -12 dB to +12 dB for INPUTS 1-7/8 in mixer mode.

The default is 0 dB.

### MID Menu

The **MID menu** is used to set the gain of the MID peak filter.

The range is -12 dB to +6 dB for Main system EQ. The range is -12 dB to +12 dB for INPUTS 1-7/8 in mixer mode.

The default is 0 dB.

### BASS Menu

The **Bass menu** item is used to configure the low frequencies of sound.

The range is -12 dB to +6 dB for Main system EQ. The range is -12 dB to +12 dB for INPUTS 1-7/8 in mixer mode.

The default is 0 dB.

### MAIN GEQ Menu (Mixer mode)

The **MAIN EQ menu** is used to adjust the frequency response of the loudspeaker for different applications or personal preference. There are 7 different EQ filters available centered at the following frequencies: 63, 160, 400, 1.0K, 2.5K, 6.0K & 12K Hz. The filter is also independent of the MAIN GEQ setting if AUX OUT is set to MAIN MIX.

The range of each filter is -12 dB to +12 dB.

The default value for each filter is 0 dB.

### AUX GEQ Menu (Mixer mode)

The **AUX GEQ menu** is used to adjust the frequency response of the AUX OUT for different applications or personal preference. There are 7 different EQ filters available centered at the following frequencies: 63, 160, 400, 1.0K, 2.5K, 6.0K & 12K Hz.

The range of each filter is -12 dB to +12 dB.

The default value for each filter is 0 dB.

**FX1 & FX2 Menu (Mixer mode)**

The **FX1 & FX2 menu** is used to select the reverb, delay, chorus, or flanger preset for each FX unit.

**AUX OUT Menu (Mixer mode)**

The **AUX OUT menu** is used to select the signal present at the AUX OUT connector:

- **AUX MIX** (default) - provides the signal mix controlled by the individual channel AUX sends
- **MAIN MIX** - provides the same signal that is present at the loudspeaker

**MIX OUT Menu (Mixer mode)**

The **MIX OUT menu** is used to select which signals should be output at MIX OUT and which signal should be delivered by the loudspeaker.

- **L+R: INPUTS 1-4** and the left and right signals of INPUT 5/6 & 7/8 are summed. The sum is output at MIX OUT and is delivered by the loudspeaker. (Default)
- **R:** Only the right signal of INPUT 5/6 & 7/8 and the percentage of INPUTS 1-4 panned right is output at MIX OUT. The loudspeaker will deliver only the left signal.
- **L:** Only the left signal of INPUT 5/6 & 7/8 and the percentage of INPUTS 1-4 panned left is output at MIX OUT. The loudspeaker will deliver only the right signal.

**BLUETOOTH Menu****Turning Bluetooth® ON or OFF**

To **turn Bluetooth® ON or OFF**, do the following:

1. Select **ON**.
- OR
1. Select **OFF**.

The **Bluetooth menu** options are ON/OFF, CONTROL PAIR, and AUDIO PAIR.

**CONTROL PAIR Menu**

The **CONTROL PAIR menu** is used to enable the QuickSmart Mobile wireless control and monitoring application. Available options for this selection are: ON or OFF.

The default is OFF.

**Notice!**

Bluetooth® is available in select countries.

Contact your nearest Electro-Voice dealer or Electro-Voice distributor for more information.

The Bluetooth® word mark and logos are registered trademarks owned by Bluetooth SIG, Inc. and any use of such marks by Bosch Security Systems, Inc. is under license. Other trademarks and trade names are those of their respective owners.

**AUDIO PAIR Menu**

The **AUDIO PAIR menu** is used to stream audio from your Bluetooth® enabled device to the loudspeaker system. Available options for this selection are: PAIRING, ON or OFF.

The default is OFF.

**Pairing the portable column system with your Bluetooth® enabled device**

To **pair the portable column system with your Bluetooth® enabled device**, do the following:

1. From the DSP menu, scroll to **AUDIO PAIR**.
2. Select **AUDIO PAIR**.  
**AUDIO PAIR** mode enables 120 seconds of visibility to Bluetooth® enabled devices.
3. On your mobile device, select **EV EVOLVE** to initiate the pairing process.  
Once the device is paired, all device audio will be output through the EVOLVE system.

**Notice!**

If connected with a mobile device, notification alerts and ring tones will also be played through the system.

Disable these notifications or enable Airplane mode on your mobile device to prevent unwanted interruptions during audio playback.

**LED Menu**

The **LED menu** shows power on and indicates limit. Available options for this selection are: ON, OFF, or LIMIT.

- **ON** - turns the LED on when the power to the loudspeaker is ON. (Default)
- **OFF** - turns the LED off.
- **LIMIT** - turns the LED off under normal operation. The LED brief blinking indicates the limiter is activating. Short-term blinking is not critical because the integrated limiter keeps distortion under control. Constant lighting of the LED indicates the sound is negatively affected. If the LED is constantly lit, check the rear LCD for more information. Reducing the output volume is strongly recommended.

**DISPLAY Menu**

The **Display menu** options are BACK, LCD DIM, BRIGHT, and CONTRAST.

**LCD DIM Menu**

The **LCD Dim menu** is used to dim the display when the display is idle for 30 seconds.

Available options for this selection are: ON or OFF.

The default is ON.

**BRIGHT Menu**

The **Bright menu** is used to determine the brightness of the LCD.

The range is 1 to 10.

The default is five (5).

**CONTRAST Menu**

The **Contrast menu** is used to increase or decrease the visibility of the LCD screen.

The range is 1 to 10.

The default is five.

**STORE Menu**

The **Store menu** allows you create up to five customized user settings. Available options for this selection are: EXIT, 1, 2, 3, 4, and 5.

**Notice!**

The customized user setting name can contain a combination of alphanumeric characters including spaces. The alphanumeric character range is A to Z and 0-9.

The name field length is 11 characters.

**Storing customized user settings**

To store customized user settings, do the following:

1. From the DSP menu, scroll to **STORE**.
2. Push the **MASTER VOL** knob to select **STORE**.  
The store screen appears.
3. Push the **MASTER VOL** knob to select 1.  
The Enter name for 1 screen appears.
4. Use the **MASTER VOL** knob to scroll through the characters.  
The characters appear.
5. Push the **MASTER VOL** knob to select the desired character.

6. Turn the **MASTER VOL** knob to move to the next character entry.  
Continue selecting characters until the desired name is entered.
7. Use the **MASTER VOL** knob to scroll to **SAVE**.
8. Push the **MASTER VOL** knob to select **SAVE**.
9. Repeat **steps 3 through 8** to store additional customized user settings.
10. Select **EXIT** to return to the home screen.

#### **RECALL Menu**

The **Recall menu** allows you retrieve up to five customized user settings.

Available options for this selection are: **EXIT, 1, 2, 3, 4,** and **5**.

In addition, setting **6** is available to recall a default setting. This setting cannot be used to store user settings.

#### **Recalling customized user settings**

To recall customized user settings, do the following:

1. From the DSP menu, scroll to **RECALL**.
2. Push the **MASTER VOL** knob to select **RECALL**.  
The recall screen appears.
3. Push the **MASTER VOL** knob to select **1**.  
The selected item is loaded.
4. Select **EXIT** to return to the home screen.

#### **RESET Menu**

The **Reset menu** is used to reset the loudspeaker to original factory settings.

Available options for this selection are: **NO** or **YES**.

The default is **NO**.

#### **Resetting the system**

To **reset the system to original factory settings**, do the following:

1. From the DSP menu, select **RESET**.  
The "DEFAULT SETTINGS?" validation message appears.
2. Select **YES**.  
The system is reset to the original factory settings.  
The "Erase User Presets" validation message appears.
3. Select **YES** or **NO**.
4. If **YES**, the user presets are deleted and return to <EMPTY>.



#### **Notice!**

The reset menu item is used to revert the loudspeaker to the original factory default settings. All user settings will be deleted. The user customized settings in the **STORE** and **RECALL** menus return to <EMPTY> if **YES** was selected in during the reset process.

---

#### **INFO Menu**

The **Information menu** is used to display the product name and firmware version.

## 6 Mixer operation

### 6.1 Inputs 1-4, 5/6 & 7/8

#### **INPUT LEVEL control**

Control for adjusting a LINE/MIC or line input's sensitivity. These controls let you adjust the incoming signals to the mixer's internal operation level. The following gain setting instruction is to be used as a guide to help achieve a good signal input level:

Set the MASTER volume controls to -80 dB.

Set the INPUT LEVEL control to -80 dB.

Connect the sound source (microphone, instrument, etc.) to the desired LINE/MIC input.

Start the sound source at the highest volume level to be expected - respectively sing or speak as loudly as possible directly (close up) into the microphone.

While playing the sound source or singing into the microphone, adjust the input level using the INPUT GAIN control, so that during the loudest part, the CLIP does not show. Then increase the MASTER VOL until the desired output from the column is achieved. This is the basic channel setting.

If further adjustments to the channel's EQ setting are necessary, perform these steps again, as changes in the sound shaping section also have an influence on the channel's overall level.

#### **TREBLE/MID/BASS controls**

The input channel's EQ section allows for a broad difference in the shaping of the incoming audio signal within three frequency bands. Before you begin to alter the sound, all EQ controls should be set to 0. Try not to set the EQ controls to extreme positions. Usually, minor changes are sufficient to produce the best results in the overall sound. Use the natural reproduction as a starting point and rely on your musically trained ear. The moderate use of the MID control is the best remedy to avoid acoustical feedback. Try to avoid using this frequency range to an extreme level. Lowering the level in this band will provide you with higher output and help reduce feedback. Adjust the BASS control to add more "punch" to the sound of a kick drum or "body" to the vocals. Use the TREBLE control in the same way to provide cymbals and vocals with more treble for a more transparent sound.

#### **FX1 & FX2 control**

The **FX1 & FX2 control** is used to set the amount of effect you require on that channel. Using the FX controls lets you easily assign an effect for groups of musical instruments or vocals. To determine the desired level of the effect, start with the controls set at their minimum and individually increase the level gradually until the desired sound is achieved.

The FX Enable switch turns the internal FX units on or off. Please keep in mind that you can also use an external footswitch for turning the FX1 & FX2 on or off. If you want to use a footswitch, the EVOLVE 50M is preconfigured to control FX on/off with a footswitch, requiring no additional configuration.

#### **Phantom Power**

+15V DC Phantom power is available on the XLR connectors of INPUTS 1-4 only. There is no phantom power on the TRS connectors. Phantom power is always on, and not switchblade.



#### **Notice!**

A protection circuit is provided to prevent damage to devices which do not require phantom power such as dynamic microphones and mixer outputs. Best practice dictates to connect line level sources to INPUTS 5/6 when possible.

### AUX control

The **AUX control** is primarily meant for establishing an independent mix, e.g. for monitor or a second room/zone. The individual channel AUX controls will determine the amount of each channel's post fader signal present at the AUX output if AUX OUT is set to AUX MIX.

### COMP control

During operation, the input signal processing can be adjusted by using the **COMP control** to control the on board compressor. Compressors are available on INPUTS 1-4. Adjust the COMPRESSOR threshold and compression ration simultaneously using the COMP adjustment. As the **COMP control** is adjusted from 0 to 100, the gain below the threshold will increase from 0 to 10 dB and the compression ratio will increase from 1:1 to 8:1. The compressor will reduce the dynamic range of the audio signal proportional to the compressor setting. Once the signal exceeds a certain threshold, the signal gets compressed, i.e. major input level changes result in minor output level changes. Narrowing the dynamic range often allows for easier recording or mixing the audio signal. It is recommended to start with low to moderate levels of compression (25-40) and increase slowly if necessary.

## 6.2 QuickSmart Link configuration

With QuickSmart Link you can combine all input signals from 2 EVOLVE50M loudspeakers into one mixer. The mixer output signal can be Mono or Stereo, the signal routing is set during the configuration process.

1. Make sure both EVOLVE 50M systems are turned on.
2. Connect the network cable to the QuickSmart link port on each EVOLVE 50M system.
3. Configuration is completed through the QuickSmart DSP control menu displayed on the LCD of either EVOLVE 50M system. Choose one EVOLVE 50M system to complete the configuration.
4. The LCD will display that the QuickSmart link is detected.
5. You will need to determine how to synchronize parameters between both EVOLVE 50M systems. The LCD will display "parameter Sync Send or Receive".
6. If you wish to copy and send parameters from the EVOLVE 50M system you are controlling, select "send".
7. If you wish to read and copy the parameters from the second EVOLVE 50M system, select "receive".
8. The LCD will display a message asking if the EVOLVE 50M system you are controlling should be configured for Stereo L, Stereo R or Mono signals.
9. Select the appropriate signal. The second EVOLVE 50M system will automatically be configured based on your selection.
10. The LCD will then display that the QuickSmart Link is ready.

With QuickSmart Link, several parameters of the connected EVOLVE 50M systems are linked. (i.e. changing a parameter on one EVOLVE 50M system will trigger an equivalent change on the 2nd EVOLVE 50M system) This ensures the system parameters are consistent and results the best acoustic performance.

Linked parameters are:

- System volume
- Function
- Mode
- System and Subwoofer Delay
- Speaker EQ (Bass, Mid, Treble)
- SPK OUT, MIX OUT and AUX OUT routings
- Main GEQ

- FX enable (also via Foot Switch)
- Preset load and store

## 7 Pairing the QuickSmart Mobile application

The EV Quick**Smart** Mobile app is available for download for the iOS 12 and higher tablets and smart phones from the iTunes App Store or Android 5.0 and higher tablets and smart phones from the Google Play Store.



### Notice!

The EV Quick**Smart** Mobile app is designed to only find speakers from Electro-Voice with Bluetooth® enabled.

The EV Quick**Smart** Mobile app will not display other types of Bluetooth® devices, e.g. phones, laptops, tablets, or headsets.



### Notice!

Bluetooth® is available in select countries.

Contact your nearest Electro-Voice dealer or Electro-Voice distributor for more information.

Prior to pairing the EV Quick**Smart** Mobile app with loudspeakers by Electro-Voice ensure Bluetooth® is enabled on the smart phone or tablet, and the loudspeaker.

### First time pairing:

To pair the loudspeaker with the EV Quick**Smart** Mobile app, do the following:

1. Open the EV Quick**Smart** Mobile app. 
2. Allow the app to access your location if requested.
3. Finding nearby speakers is displayed on the screen  
The EV Quick**Smart** Mobile app is looking for available Bluetooth® enabled Electro-Voice loudspeakers.
4. The available loudspeakers are displayed on the screen.  
The app will display up to eight available loudspeakers.
5. Tap the loudspeaker you want to pair with the app.  
The selected loudspeaker will have a line under it acknowledging it is selected.  
ControlPair needs to be activated.
6. Repeat the previous step until all of the desired loudspeakers are selected.
7. Tap the CONNECT button.
8. The app pairs with the desired loudspeaker.  
Allow the app to pair if prompted. Sometimes this window is hidden and you have to actively open it.  
The app can connect to up to six loudspeakers.

### Subsequent pairing:

To pair the loudspeaker with the EV Quick**Smart** Mobile app, do the following:

1. Tap the EV Quick**Smart** Mobile app icon. 
2. Finding nearby speakers is displayed on the screen  
The EV Quick**Smart** Mobile app is looking for available Bluetooth® enabled Electro-Voice loudspeakers.
3. The available loudspeakers are displayed on the screen.  
The app will display up to eight available loudspeakers.
4. Tap the loudspeaker you want to pair with the app.  
The selected loudspeaker will have a line under it acknowledging it is selected.
5. Repeat the previous step until all of the desired loudspeakers are selected.



6. Tap the CONNECT button.
7. The app pairs with the desired loudspeaker.  
The app can connect to up to six loudspeakers.

# 8 Recommended configurations

## 8.1 Stereo pair of Evolve 50M systems

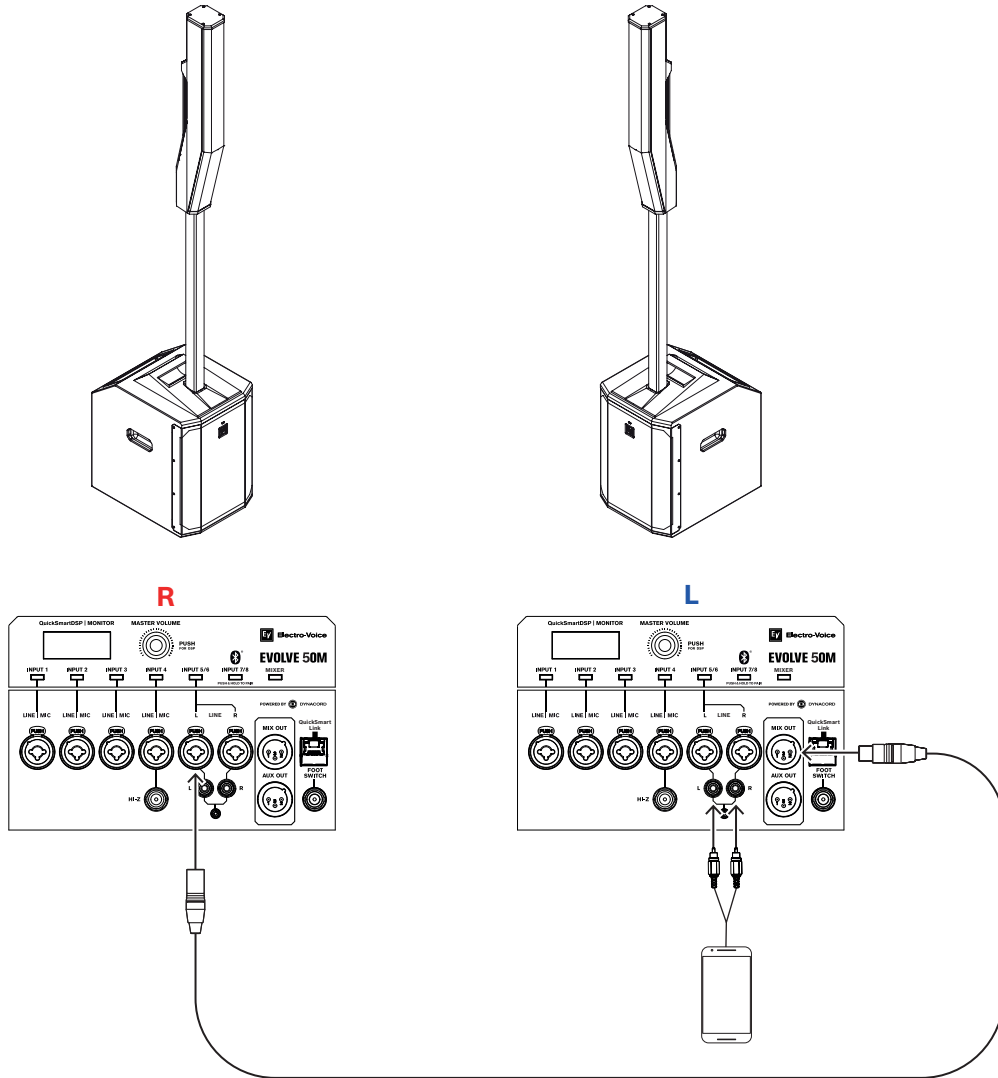

<b>Mode:</b>	Music
<b>MASTER SPEAKER (L) MIX OUT:</b>	R
<b>SATELLITE SPEAKER (R):</b>	INPUT 5 (MONO)

Tab. 8.3: DSP settings for the portable column system

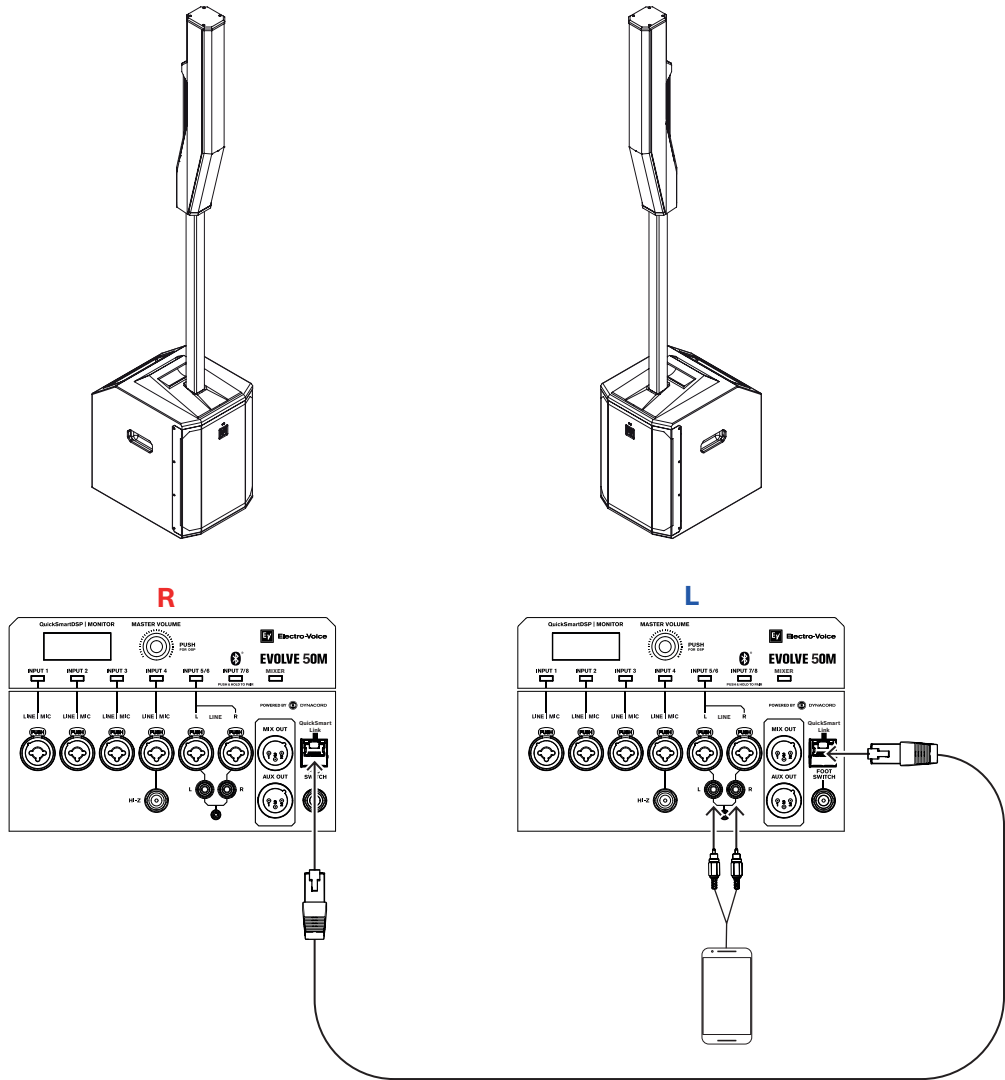

<b>Mode:</b>	Music
<b>MASTER SPEAKER (L) SPK OUT:</b>	L
<b>SATELLITE SPEAKER (R):</b>	QuickSmart Link input

Tab. 8.4: DSP settings for the portable column system



**Notice!**

Stereo connection from device to the MASTER SPEAKER can be made with hard wires into the stereo INPUT 5/6 or via Bluetooth® into stereo Bluetooth® INPUT 7/8.

## 8.2 Solo musician performance

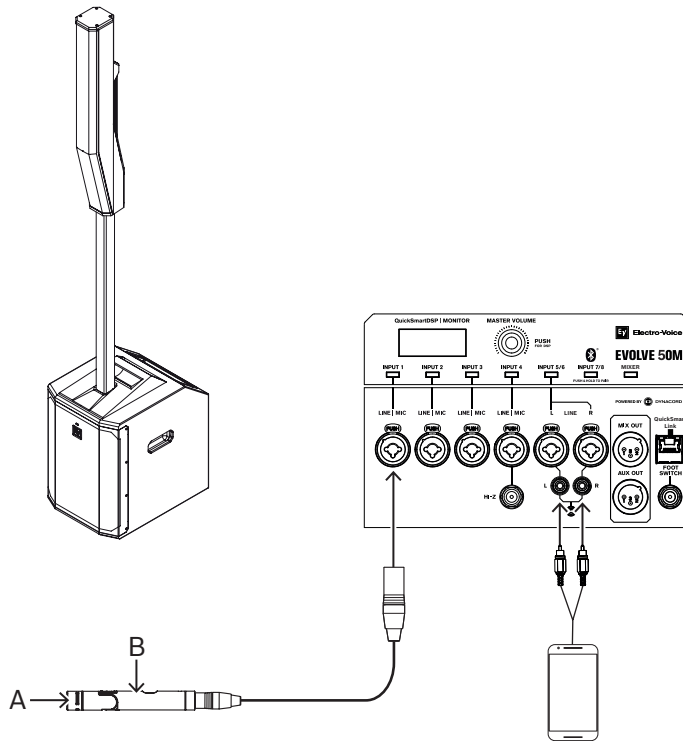

**Notice!**

The direction of the arrow indicates the signal path.

<b>Mode:</b>	Live
--------------	------

Tab. 8.5: DSP settings for the portable column system

# 9 Troubleshooting

Problem	Possible cause	Action
1. No sound	Amplifier	Verify all the electronics are on, the signal routing is correct, the source is active; the volume is turned up, no channels are muted, etc. Correct/repair/replace as necessary. If there is still no sound, the problem may be wiring.
	Wiring	Verify you have connected the correct cables to the amplifier. Play something at a low level through the amplifier. Connect a test loudspeaker in parallel with the malfunctioning line. If the sound level is gone or is very weak, the line has a short in it (possibly a severe scrape, pinch, or a missed connection). Using the test loudspeaker, move down the line and test each connection/junction until you find the problem and correct it. Observe proper polarity.
2. Intermittent output such as crackling or distortion	Faulty connection	Check all connections at amplifier and loudspeakers to ensure they are all clean and tight. If the problem persists, check the wiring. See problem 1.
3. Constant noise such as buzzing hissing or humming	Defective source or other electronic device	If noise is present, but no program material is playing, evaluate each component as necessary to isolate the problem. Most likely there is a break in the signal path.
	Poor system grounding or ground loop	Check and correct the system grounding, as required.
4. No sound produced with microphone connected to INPUTS 1-4	Microphone requires phantom power.	Ensure the microphone is connected to INPUTS 1-4. Phantom power is not available on INPUT 5/6.
	Input channel is muted or LEVEL is too low.	Select the channel and verify the channel is not muted. If it is not muted, slowly increase the channel LEVEL until sound is produced.
5. Sound is distorted front LED is OFF, LCD screen LIMIT is ON	Excessive input level	Reduce the input level or loudspeaker level to prevent limit.
	Incorrect gain structure or source input (mixing console/preamp) is overdriven	Verify level controls of the source are properly structured by using the VU meter indicator on the LCD screen. If the VU meter bar is solid or the system indicates CLIP or LIMIT, the input or source level is too high.

Problem	Possible cause	Action
6. Microphone produces acoustic feedback when input level is amplified	Incorrect gain structure	Reduce the microphone signal by reducing the INPUT level. Positioning the microphone close to the sound source increases gain before feedback.
	MODE is set to MUSIC	Change the MODE to LIVE or SPEECH.
	Microphone position is too close to the front of the loudspeaker	Whenever possible, setup the loudspeakers so the microphone is behind them. If using a separate loudspeaker in a monitor position, aim the loudspeaker to the back of the microphone.
7. <b>QuickSmart</b> Mobile app does not detect the loudspeaker	Enable Bluetooth®	Ensure Bluetooth® is enabled on the loudspeaker.
8. Sound is distorted or interrupted if using QuickSmart Link	Improper cable or cable that is too long	Use shielded CAT5 (or better) cables that are not longer than as specified in the datasheet.
	Network hardware (Switches / Routers) connected	Only a direct connection between no more than two EVOLVE50M systems is allowed to work correctly.

If these suggestions do not solve your problem, contact your nearest Electro-Voice dealer or Electro-Voice distributor.

## 10 Technical data

Frequency response (-3 dB) <sup>1</sup> :	43 Hz to 20 KHz
Frequency range (-10 dB) <sup>1</sup> :	37 Hz to 20 KHz
Maximum SPL <sup>2</sup> :	127 dB
Coverage (H x V):	120° x 40°
Amplifier rating:	1000 W
LF channel rating:	500 W
HF channel rating:	500 W
Crossover frequency:	200 Hz
Connectors:	4x XLR/TRS Combo Jack Line / Mic Input 1x 1/4" TRS HI-Z input 2x XLR/TRS Combo Jack for Stereo Line Input 1x Stereo RCA Input 1x 3.5 mm Stereo Input 1x Wireless Stereo Bluetooth® Audio Input 1x 1/4" Foot Switch Input 1x XLR MIX OUT Output 1x XLR AUX OUT Output 1x RJ45 QuickSmart-Link connector
Enclosure:	Sub: 15 mm plywood Column: Composite Pole: Aluminum
Grille:	Steel with black or white powder coat
Color:	Black or white
Dimensions (HxWxD): mm (in)	Subwoofer: 530 x 345 x 471 (20.9 x 13.6 x 18.5) Column: 825 x 102 x 172 (32.5 x 4.0 x 6.9) Sub pole: 929 x 48.5 x 55 (36.6 x 1.9 x 2.2)
Assembled dimensions (HxWxD): mm (in)	2045 x 345 x 471 (80.5 x 13.6 x 18.5)
Net weight:	Subwoofer: 20.3 kg (44.66 lb) Column: 4.7 kg (10.34 lb) Pole: 1.25 kg (2.75 lb) Subwoofer cover: 0.4 kg (0.9 lb) Bag for column and pole: 0.85 kg (1.87 lb)
Shipping weight (sub box):	23 kg (50.71 lb)
Shipping weight (column box):	8.3 kg (18.30 lb)
Frequency Band:	2402 MHz to 2480 MHz
Transmitter Power:	EIRP:4.8 dBm
Power consumption <sup>3</sup> :	100-240 V AC, 50-60 Hz, 1.5-0.6 A

<sup>1</sup>Half-space measurement using live DSP preset.

<sup>2</sup>Maximum SPL is measured at 1 m using broadband pink noise at maximum output.

<sup>3</sup>Current rating is 1/8 power.

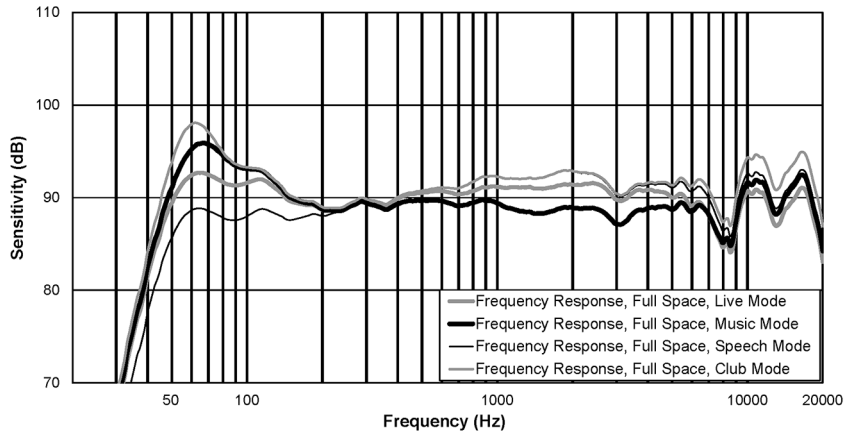

Figure 10.1: Frequency response EVOLVE 50M (Live Mode, Music Mode, Speech Mode, and Club Mode)

## 10.1 Dimensions

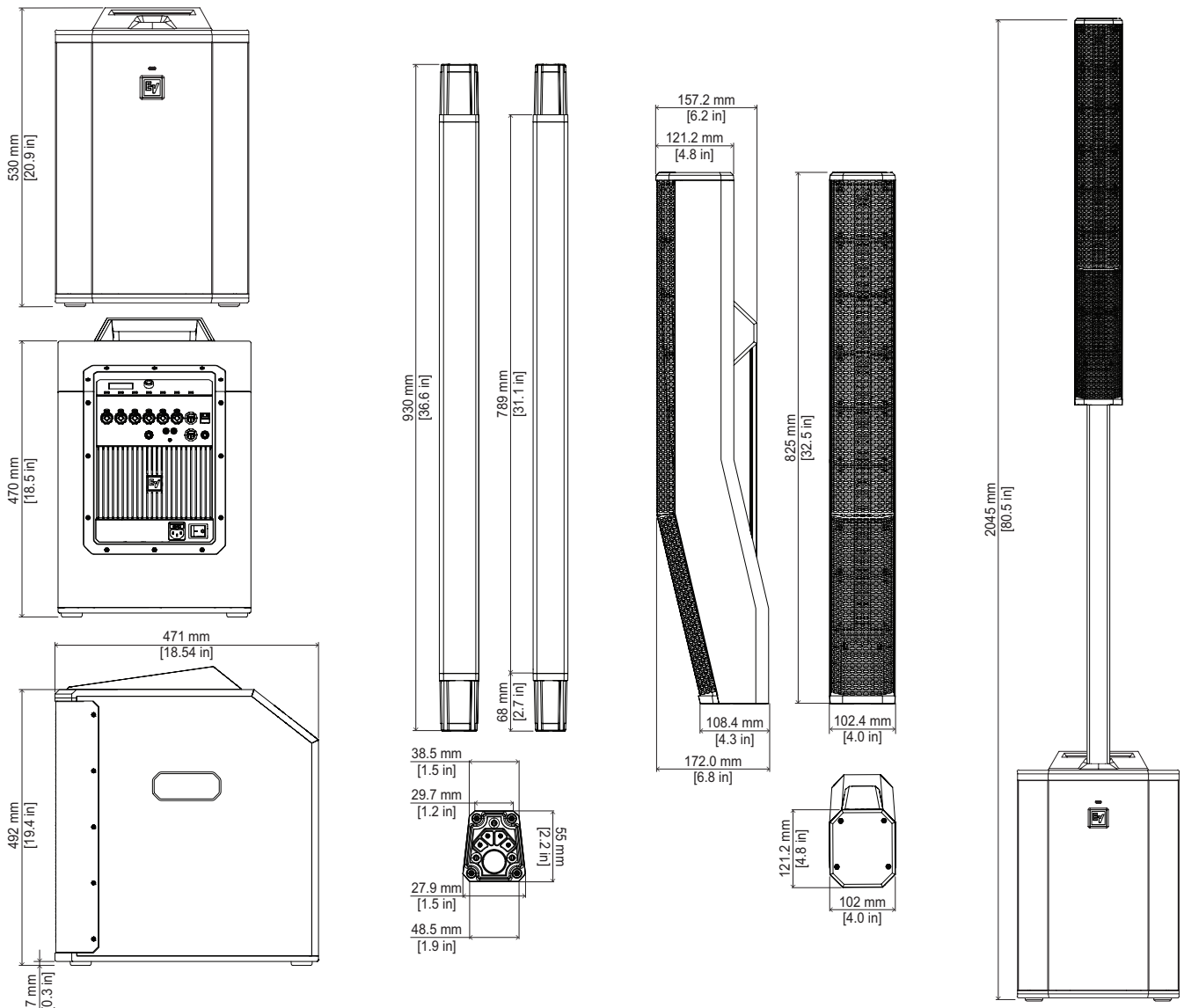
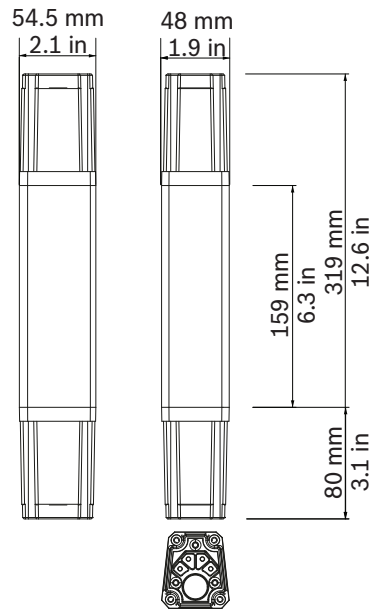

Figure 10.2: Dimensions EVOLVE50M System





**Figure 10.3:** Dimensions EVOLVE short pole



**Notice!**

The EVOLVE short pole can be used with EVOLVE 30M, EVOLVE 50 and EVOLVE 50M.





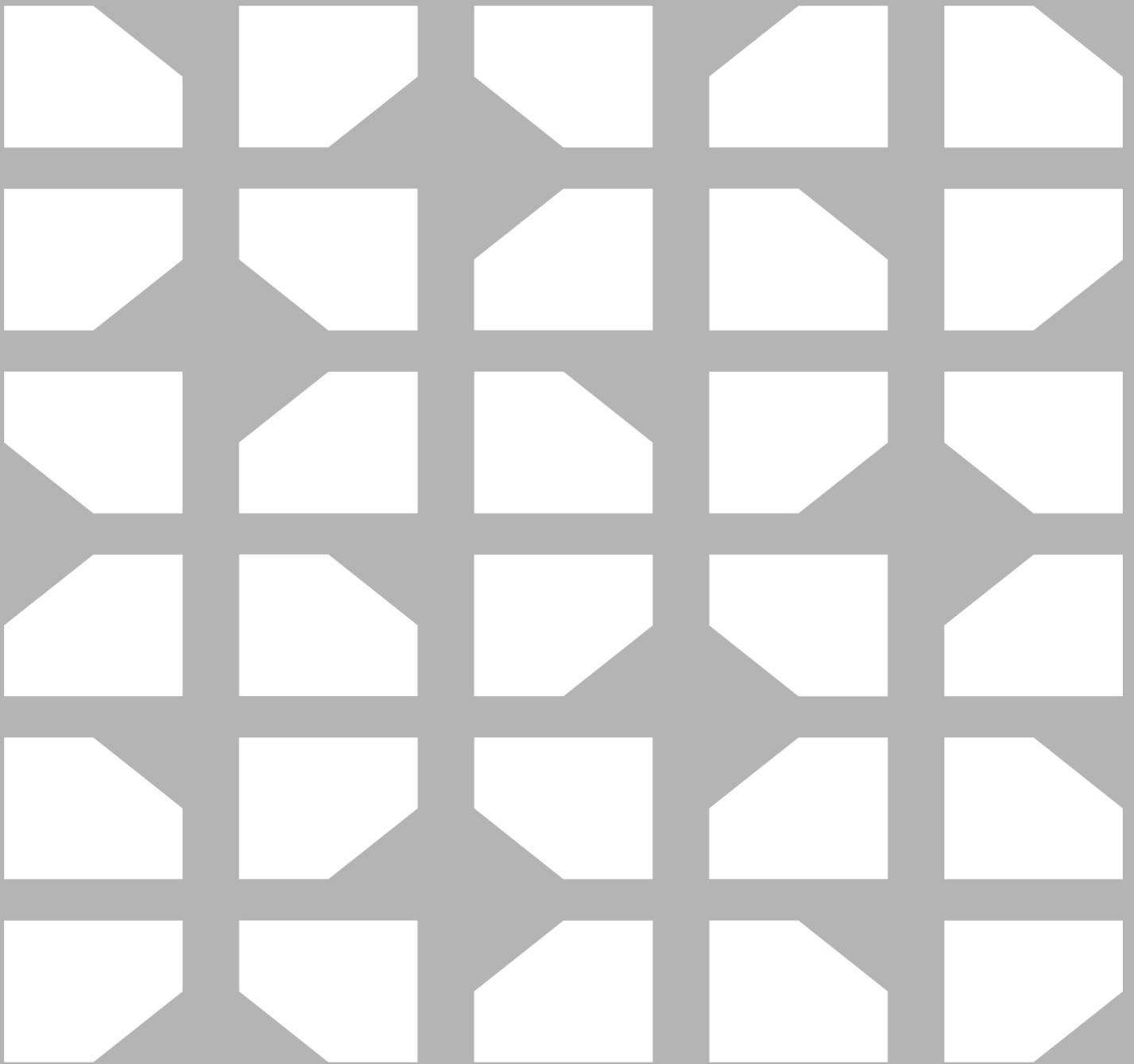

**Bosch Sicherheitssysteme GmbH**

Robert-Bosch-Ring 5

85630 Grasbrunn

Germany

**[www.boschsecurity.com](http://www.boschsecurity.com)**

© Bosch Sicherheitssysteme GmbH, 2020

**Bosch Security Systems, LLC**

12000 Portland Avenue South

Burnsville MN 55337

USA

**[www.electrovoice.com](http://www.electrovoice.com)**

© Bosch Security Systems, LLC, 2020