

# **EVERSE 8**

EVERSE8-US, EVERSE8-EU, EVERSE8-W

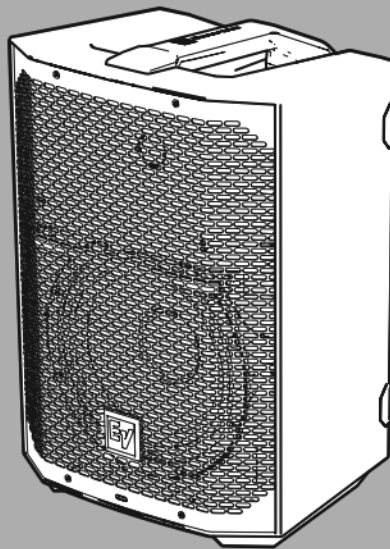







## Table of contents

<b>1</b>	<b>Safety</b>	<b>4</b>
1.1	Important safety instructions	4
1.2	Battery and internal charger safety rules	5
1.3	Suspension	7
1.4	FCC information	7
1.5	Precautions	8
1.6	Certifications	9
1.7	Notices	9
<b>2</b>	<b>Description</b>	<b>11</b>
2.1	Short information	11
2.2	System features	12
2.3	Quick setup	13
<b>3</b>	<b>Pairing the QuickSmart Mobile app</b>	<b>15</b>
<b>4</b>	<b>Tripod and floor monitor operation</b>	<b>17</b>
4.1	Tripod or pole mount	17
4.2	Floor monitor & kickback	19
<b>5</b>	<b>Amplifier DSP</b>	<b>21</b>
5.1	Amplifier DSP controls	21
5.2	System status	22
5.3	DSP controls	23
5.3.1	Full-Range loudspeaker DSP control menu	24
<b>6</b>	<b>Mixer Operation</b>	<b>31</b>
6.1	Inputs 1, 2, & 3/4	31
<b>7</b>	<b>Recommended configurations</b>	<b>34</b>
7.1	Connecting with mobile device	34
7.2	Street Musician performance	35
7.3	Bluetooth True Wireless Stereo (TWS)	36
7.4	Using as monitor	36
7.5	Using as monitor while recording	38
<b>8</b>	<b>Troubleshooting</b>	<b>39</b>
<b>9</b>	<b>Technical data</b>	<b>41</b>
9.1	Dimensions	42
9.2	Frequency response	42

# 1 Safety

## 1.1 Important safety instructions

 <p><b>WARNING:</b> TO REDUCE THE RISK OF FIRE OR ELECTRIC SHOCK, DO NOT OVEREXPOSE THIS APPLIANCE TO RAIN OR MOISTURE</p> <p><b>AVIS:</b> RISQUE DE CHOC ELECTRIQUE, NE PAS OUVRIR.</p> <p><b>WARNING:</b> THE MAINS PLUG OR AC INLET IS USED AS A DISCONNECT DEVICE. THE DISCONNECT DEVICE SHALL REMAIN READILY OPERABLE.</p> <p><b>WARNING:</b> CONNECT ONLY TO MAINS SOCKET WITH PROTECTIVE EARTHING CONNECTION.</p> <p><b>WARNING:</b> TO REDUCE THE RISK OF ELECTRIC SHOCK, DO NOT REMOVE COVER (OR BACK) AS THERE ARE NO USER-SERVICABLE PARTS INSIDE. REFER SERVICING TO QUALIFIED PERSONNEL.</p>	 <p>The lightning flash with arrowhead symbol, within an equilateral triangle is intended to alert the user to the presence of uninsulated “dangerous voltage” within the product’s enclosure that may be sufficient magnitude to constitute a risk of electric shock to persons.</p>
	 <p>The exclamation point within an equilateral triangle is intended to alert the user to the presence of important operating and maintenance (servicing) instructions in the literature accompanying the appliance.</p>
	 <p>The asterisk within an equilateral triangle is intended to inform the user to necessary installation or removal instructions regarding equipment or hardware use relating to the system.</p>

1. Read these instructions.
2. Keep these instructions.
3. Heed all warnings.
4. Follow all instructions.
5. Do not use this apparatus near water.
6. Clean only with a dry cloth.
7. Do not block any ventilation openings. Install in accordance with the manufacturer's instructions.
8. Do not install near any heat sources such as radiators, heat registers, stoves, or other apparatus (including amplifiers) that produce heat.
9. Do not defeat the safety purpose of the polarized or grounding-type plug. A polarized plug has two blades with one wider than the other. A grounding type plug has two blades and a third grounding prong. The wide blade or the third prong is provided for your safety. If the provided plug does not fit into your outlet, consult an electrician for replacement of the obsolete outlet.
10. Protect the power cord from being walked on or pinched particularly at plugs, convenience receptacles, and the point where they exit from the apparatus.
11. Only use attachments/accessories specified by the manufacturer.
12. Use only with the cart, stand, tripod, bracket, or table specified by the manufacturer, or with the apparatus. When a cart is used, use caution when moving the cart/apparatus combination to avoid injury from tip-over.
13. Unplug the apparatus during lightning storms or when unused for long periods of time.

14. Refer all servicing to qualified service personnel. Servicing is required when the apparatus has been damaged in any way, such as power-supply cord or plug is damaged, liquid has been spilled or objects have fallen into the apparatus, the apparatus has been exposed to rain or moisture, does not operate normally, or has been dropped.
15. No naked flame sources, such as lighted candles, should be placed on the apparatus.
16. To reduce the risk of fire or electric shock, do not expose this apparatus to rain or moisture. The apparatus should not be exposed to dripping or splashing. Objects filled with liquids, such as vases should not be placed on apparatus.
17. Do not block any ventilation openings. Install in accordance with the manufacturer's instructions.
18. Minimum 60 cm (2 ft) distances around the apparatus for sufficient ventilation.
19. The ventilation should not be impeded by covering the ventilation openings with items, such as newspapers, table-cloths, curtains, etc.
20. To completely disconnect AC power from this apparatus, the power supply cord must be unplugged.

## 1.2

### **Battery and internal charger safety rules**

1. **SAVE THESE INSTRUCTIONS.** This manual contains important safety and operating instructions for Electro-Voice EVERSE 8 loudspeaker.
2. Before using Electro-Voice EVERSE 8 internal battery charger to re-charge the battery, read all instructions and warning markings on (1) battery, (2) EVERSE 8 loudspeaker.
3. To reduce the risk of injury, charge only Electro-Voice battery packs specified for use with the EVERSE 8 loudspeaker. Other types of batteries may burst causing personal injury and damage.
4. Charge the battery pack in temperatures above 0 °C (+32 °F) and below 35 °C (+95 °F). Avoid charging battery in direct sunlight. Store the loudspeaker and the battery pack in locations where temperatures will not exceed 45 °C (113 °F). This is important to prevent serious damage to the battery cells.
5. Do not recharge the battery in a damp or wet environment. Do not expose the loudspeaker to rain or snow while plugged in to mains. Always use the supplied weather cover and/or rain cover accessory in wet environments. Water entering battery charger may result in electric shock or fire.
6. Never submerge the battery pack, or the EVERSE 8 loudspeaker in fluid of any kind or allow fluid to enter them. Corrosive or conductive fluid (such as seawater or industrial chemical or bleach containing products, etc.) can cause short circuit, which may result in fire, personal injury and property damage.
7. Battery leakage may occur under extreme usage or temperature conditions. Avoid contact with skin and eyes. The battery liquid is caustic and could cause chemical burns to tissues. If liquid comes in contact with skin, wash quickly with soap and water. If the liquid contacts your eyes, flush them with water for a minimum of 10 minutes and seek medical attention.
8. Place the EVERSE 8 loudspeaker on flat nonflammable surfaces and away from flammable materials when using or charging the battery pack. Carpeting and other heat insulating surfaces block proper air circulation which may cause overheating of the charger and battery pack. If smoke or melting of the charger or battery pack is observed, unplug the speaker immediately and do not use the battery pack or speaker. Contact customer service immediately.

9. Make sure cord is located so that it will not be stepped on, tripped over, or otherwise subjected to damage or stress. Damaged plug and cord may result in electric shock or fire.
10. Disconnect the EVERSE 8 loudspeaker by pulling the plug rather than the cord. Do not operate the EVERSE 8 loudspeaker with damaged cord or plug. Have them replaced immediately. Damaged plug or cord may result in electric shock or fire.
11. Do not insert the battery pack in the EVERSE 8 loudspeaker if the battery pack case is cracked or visibly damaged. Using a damaged battery pack may result in electric shock or fire.
12. Do not disassemble or operate the EVERSE 8 loudspeaker if it has received a sharp blow, been dropped or otherwise damaged in anyway. Incorrect reassembly or damage may result in electric shock or fire.
13. Before each use, check the EVERSE 8 loudspeaker, cable, plug and battery pack. Do not use if damage is detected. Never open the battery pack yourself, take it to an Electro-Voice Service Center, only using original replacement parts. Incorrect reassembly or using damaged product may result in electric shock or fire.
14. Only use accessories or batteries recommended or sold by Electro-Voice. Using attachments not recommended may result in electric shock or fire.
15. Unplug the EVERSE 8 loudspeaker from outlet before storage, attempting any maintenance or cleaning. Such preventive safety measures reduce the risk of electric shock or fire.
16. Replace battery pack if a substantial drop in operating time per charge is observed. Battery pack may be nearing the end of its life.

### Battery care



#### Warning!

**When batteries are not installed in a speaker, keep them away from metal objects.** For example, to protect terminals from shorting **DO NOT** place batteries in a tool box or pocket with nails, screws, keys, etc. Fire or injury may result.

**DO NOT PUT BATTERIES INTO FIRE** or expose to high heat. They may explode.

### Battery disposal



#### Warning!

**Do not attempt to disassemble the battery or remove any component projecting from the battery terminals.** Fire or injury may result. Prior to disposal, protect exposed terminals with heavy insulating tape to prevent shorting.

### Lithium-ion batteries

The lithium-ion battery must be collected, recycled or disposed of in an environmentally sound manner.



#### Notice!

Use of battery packs not sold by Electro-Voice will void the warranty.

**Battery protection mode**

The lithium-ion battery is protected against deep discharging by the “Battery protection mode”. When the battery is empty, the EVERSE 8 loudspeaker enters a battery protection mode. The battery is supplied partially charged. Completely charge the battery before using your loudspeaker for the first time. The lithium-ion battery can be charged at any time, without reducing its service life. Interrupting the charging procedure does not damage the battery.

**Notice!**

Do not dispose batteries in household waste. Dispose of batteries only at suitable collection points and, in the case of lithium batteries, cover the terminal with electrical tap or other electrically insulating material.

**Warning!**

Air transport warning

Follow the airline transportation baggage regulation in use for the lithium-ion battery pack device.

**Warning!**

Risk of explosion or burns

This device includes a lithium-ion battery pack. To reduce the risk of fire or burns, do not attempt to open, disassemble, or service the battery pack. Do not crush, puncture, short external contacts, or dispose of in fire or water. Only use the device in temperatures between 0 °C (32 °F) and 35 °C (95 °F). Recycle or dispose of properly.

**1.3****Suspension****Warning!**

Do not suspend this product in any other manner than explicitly described in this manual, or Electro-Voice installation guides. Do NOT use handles to suspend the loudspeaker. Handles on Electro-Voice loudspeakers are intended to only be used for temporary transport by people. Items, such as fiber rope, wire rope, cables, or other types of materials cannot be used to suspend loudspeaker from the handles.

**1.4****FCC information**

**IMPORTANT:** Do not modify this unit! Changes or modifications not expressly approved by the manufacturer could void the user’s authority, granted by the FCC, to operate the equipment.

**Notice!**

This equipment has been tested and found to comply with the limits for a Class B digital device, pursuant to Part 15 of the FCC Rules. These limits are designed to provide reasonable protection against harmful interference in a residential installation. This equipment generates, uses and can radiate radio frequency energy and, if not installed and used in accordance with the instructions, may cause harmful interference to radio communications. However, there is no guarantee interference will not occur in a particular installation.

If this equipment does cause harmful interference to radio or television reception or receive audible interference from radio, television or communications equipment, which can be determined by turning the equipment off and on. The user is encouraged to try to correct the interference by one or more of the following measures:

- Reorient or relocate the receiving antenna.
- Increase the separation between the equipment and receiver.

- Connect the equipment into an outlet on a circuit different from that to which the receiver is connected.
  - Consult the dealer or an experienced radio/TV/communications equipment technician.
- The device has been granted by FCC and IC, the FCC ID:ESVEVERSE and IC: 1249A-EVERSE Please take attention that changes or modification not expressly approved by the party responsible for compliance could void the user’s authority to operate the equipment. This equipment should be installed and operated with a minimum distance of 20cm between the radiator and your body.

This device complies with Industry Canada license-exempt RSS standard(s). Operation is subject to the following two conditions:

- (1) this device may not cause interference, and
- (2) this device must accept any interference, including interference that may cause undesired operation of the device.





Le présent appareil est conforme aux CNR d'Industrie Canada applicables aux appareils radioexempts de licence. L'exploitation est autorisée aux deux conditions suivantes :

- (1) l'appareil ne doit pas produire de brouillage, et
- (2) l'utilisateur de l'appareil doit accepter tout brouillage radioélectrique subi, même si le brouillage est susceptible d'en compromettre le fonctionnement.

Under Industry Canada regulations, this radio transmitter may only operate using an antenna of a type and maximum (or lesser) gain approved for the transmitter by Industry Canada. To reduce potential radio interference to other users, the antenna type and its gain should be so chosen that the equivalent isotropically radiated power (e.i.r.p.) is not more than that necessary for successful communication.

Conformément à la réglementation d'Industrie Canada, le présent émetteur radio peut fonctionner avec une antenne d'un type et d'un gain maximal (ou inférieur) approuvé pour l'émetteur par Industrie Canada. Dans le but de réduire les risques de brouillage radioélectrique à l'intention des autres utilisateurs, il faut choisir le type d'antenne et son gain de sorte que la puissance isotrope rayonnée équivalente (p.i.r.e.) ne dépasse pas l'intensité nécessaire à l'établissement d'une communication satisfaisante.

## 1.5 Precautions

	If an Electro-Voice loudspeaker is used outdoors on a sunny day, place the loudspeaker in a shaded or covered area. The loudspeaker amplifiers have protection circuits that temporarily shut the loudspeaker off when extremely high temperatures are reached. This can happen on hot days when the loudspeaker is in direct sunlight.
	Do not use Electro-Voice loudspeakers in an environment where temperatures are below 0 °C (32 °F) or exceed +35 °C (95 °F).
	Electro-Voice loudspeakers are easily capable of generating sound pressure levels sufficient to cause permanent hearing damage to anyone within normal coverage distance. Caution should be taken to avoid prolonged exposure to sound pressure levels exceeding 90 dB.
	Do not store EVERSE 8 batteries in an environment where temperatures are below -20 °C (-4 °F) or exceed 45 °C (113 °F).



## 1.6

### Certifications

#### Brazil:

Após uma perturbação da rede elétrica, o EVERSE 8 pode entrar em estado de segurança. Neste caso, você deve desligar e ligar o dispositivo novamente.

Este equipamento não tem direito à proteção contra interferência prejudicial e não pode causar interferência em sistemas devidamente autorizados.

#### Mexico:

“La operación de este equipo está sujeta a las siguientes dos condiciones: (1) es posible que este equipo o dispositivo no cause interferencia perjudicial y (2) este equipo o dispositivo debe aceptar cualquier interferencia, incluyendo la que pueda causar su operación no deseada”

EVERSE8-US (XXXXXXXXXXXX)

EVERSE8-EU (XXXXXXXXXXXX)

EVERSE8-W (XXXXXXXXXXXX)

EVERSE8-BAT-B (XXXXXXXXXXXX)

EVERSE8-BAT-W (XXXXXXXXXXXX)

#### Republic of Korea:

XXXXXXXXXXXX

제품명: 앰프내장형 스피커

모델명: EVERSE 8

정격: 100-240 Vac, 50-60 Hz, 1000 W

수입업체(상호)명: 로버트보쉬코리아(유)

제조사: Bosch Security Systems, LLC.

제조연월: 별도표기

제조국: 중국

A/S: 02-702-2846

해당 무선설비는 운용 중 전파혼신 가능성이 있음

해당 무선설비는 전파혼신 가능성이 있으므로 인명안전과 관련된 서비스는 할 수 없습니다.

#### United Arab Emirates:

TRA Registered no.: ER77128/19

Dealer no.: DA45733/15

## 1.7



### Notices

#### Old electrical and electronic appliances

Electrical or electronic devices that are no longer serviceable must be collected separately and sent for environmentally compatible recycling (in accordance with the European Waste Electrical and Electronic Equipment Directive).

To dispose of old electrical or electronic devices, you should use the return and collection systems put in place in the country concerned.

#### Copyright and disclaimer

All rights reserved. No part of this document may be reproduced or transmitted in any form by any means, electronic, mechanical, photocopying, recording, or otherwise, without the prior written permission of the publisher. For information on getting permission for reprints and excerpts, contact Electro-Voice.

All content including specifications, data, and illustrations in this manual are subject to change without prior notice.

---



**Notice!**

Bluetooth® is available in select countries.

Contact your nearest Electro-Voice dealer or Electro-Voice distributor for more information.

---

The Bluetooth® word mark and logos are registered trademarks owned by Bluetooth SIG, Inc. and any use of such marks by Bosch Security Systems, LLC is under license. Other trademarks and trade names are those of their respective owners.

## 2 Description

Thank you for choosing an Electro-Voice powered loudspeaker system. Please take time to consult the manual to understand all the features built into your Electro-Voice system and fully utilize its performance capabilities.

The EVERSE 8 is a versatile, easy to use, compact, battery-powered speaker system. It provides professional level performance and is housed in a robust weatherized enclosure. The EVERSE 8 provides real professional performance for musical performances, voice reinforcement and audio playback. The EVERSE 8 takes advantage of decades of Electro-Voice and Dynacord pro-audio and electronics expertise, along with new advancements in technology, to provide truly portable and truly wireless audio.

The EVERSE 8 utilizes a 2-way configuration with an 8-inch woofer using patented SST port design by Electro-Voice. It includes a hi-output, titanium, ferrofluid cooled tweeter, featuring a high-energy neodymium magnet for maximum output and reduced weight. The tweeter is mounted on a custom constant-directivity waveguide, producing exceptionally high SPL with even 100° x 100° coverage. The EVERSE 8 provides two monitor positions, traditional and kickback, in addition to the upright position, providing flexibility of placement and coverage. The rugged polypropylene enclosure features a weatherized input cover for the input section, allowing the speaker to meet IP43 rating (splash and light rain resistant) for use on battery power and Bluetooth® streaming. The available accessory slipcover allows for additional weather resistance and protection when needed.

The EVERSE 8 features Electro-Voice's QuickSmart DSP and is powered by Dynacord, featuring a built-in 4-channel digital mixer with FX, feedback suppression, and ducking features. The speaker is powered by a custom designed, and fully optimized for audio use, high capacity battery pack. The battery pack provides more than enough power to complete the show, including a 12 VDC accessory port to power RE3 or R300 wireless microphone systems. The EVERSE 8 is available in both white and black.

### 2.1 Short information

The following table lists products in the EVERSE family, with CTN (Commercial Type Number) and identifying product name DESCRIPTION.

CTN	Description
EVERSE8-US	8" 2-way speaker battery black US
EVERSE8-EU	8" 2-way speaker battery black EU
EVERSE8-W	8" 2-way speaker battery white US&EU
EVERSE8-TRAY-B	Tray for EVERSE 8, 12V DC cable black
EVERSE8-TRAY-W	Tray for EVERSE 8, 12V DC cable white
EVERSE8-RAINCVR	Rain resistant cover for EVERSE 8
EVERSE8-TOTE	Padded tote bag for EVERSE 8
EVERSE8-BAT-B	Battery pack assembly, EVERSE8, black
EVERSE8-BAT-W	Battery pack assembly, EVERSE8, white

**Importer and after-sales service****China**

Bosch (Shanghai) Security Systems Ltd.  
333 Fuquan Road North IBP  
Changning District Shanghai  
200335 P.R. China

博世（上海）安保系统有限公司  
上海市长宁区虹桥临空经济园区，福泉北路333号

**EU**

Bosch Sicherheitssysteme GmbH  
Robert-Bosch-Ring 5  
85630 Grasbrunn  
Germany

**UK**

Robert Bosch Ltd.  
Broadwater Park  
North Orbital Road  
Uxbridge UB9 5HJ  
UK

**Mexico**

Robert Bosch de R.L de C.V.  
Calle Robert Bosch No. Ext. 405  
C.P.50071  
Zona industrial Toluca  
Mexico  
Phone: +52 722 279 2300

**2.2****System features****EVERSE8-US/EVERSE8-EU/EVERSE8-W**

- **Long run-time battery removable and replaceable battery pack.**  
The EVERSE 8 battery pack will provide 6+ hours of constant music playback at maximum output levels, or over 12+ hours at 95 dB SPL average. EVERSE 8 has integrated power saving features to extend battery life when no signal is present. The 12 VDC jack on the EVERSE 8 speaker can be used to power a wireless microphone receiver like the Electro-Voice RE3 or R300.
- **Real professional level output Electro-Voice sound quality.**  
The EVERSE 8 features a 8-inches woofer with SST port and a 1-inch titanium dome tweeter which produces over 121 dB SPL max, from 50 Hz to 20 kHz. The 100° x 100° wave guide ensures even coverage across all frequencies. Two additional monitor angles (30° and 55°) ensure the right coverage and position for any situation.
- **Easy to use with QuickSmart Mobile app and Electro-Voice's Intuitive User Interface (UI).**  
The EVERSE 8 features Electro-Voice's intuitive QuickSmart DSP with single encoder interface for simple and quick setup. EVERSE 8 can be paired via Bluetooth® to a mobile device with the QuickSmart Mobile app installed to provide easy remote control of all





audio functions. The QuickSmart Mobile app allows pairing and grouping of up to 6 speakers, in any combination, including EVERSE 8, ELX200 powered family, and the EVOLVE family.

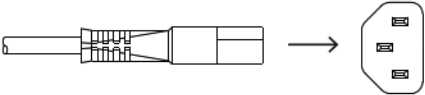
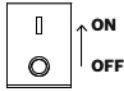

- **High Quality Stereo Bluetooth® streaming.**  
The EVERSE 8 features Bluetooth® streaming using the AptX-HD codec for high quality stereo audio streaming with compatible devices. Two EVERSE 8 speakers can be paired for True Wireless Stereo (TWS) streaming from a mobile device.
- **Powered by Dynacord with built-in digital 4-channel mixer.**  
The EVERSE 8 features a built-in 4-channel mixer with FX, EQ, automatic feedback suppression and ducking functions. The mixer includes 2 XLR/TRS combo jacks, including 48 V phantom power on INPUT 1 (XLR) and Hi-Z compatibility on INPUT 2 (TRS). The mixer also includes Stereo Bluetooth(r), 3.5 mm, and USB PC I/O connections.

## 2.3 Quick setup

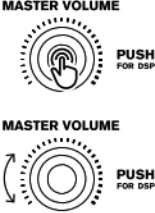
### Full-range loudspeaker

To set up the loudspeaker, do the following:

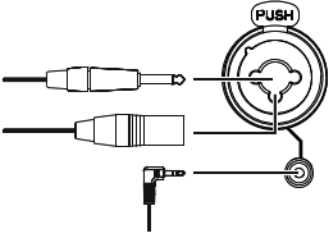
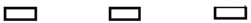
Step	Illustration
1. Connect the <b>AC power cord</b> from a ground receptacle to the MAINS IN.	
2. Switch <b>POWER</b> to ON.	
3. Adjust the <b>MASTER VOL</b> knob to -80 dB.	
4. Push the <b>MASTER VOL</b> knob to enter the <b>DSP</b> menu. Using the <b>MASTER VOL</b> knob, scroll through the menu items to <b>FUNCTION</b> . Press the <b>MASTER VOL</b> knob to access parameters. Using the <b>MASTER VOL</b> knob, scroll through parameters and select <b>BASIC</b> . Press <b>MASTER VOL</b> knob to confirm the parameter. Use <b>MASTER VOL</b> to exit menu.	
5. Push the input selection soft key for <b>INPUT 1</b> or <b>INPUT 2</b> if using an XLR or TRS cable, or push the input selection soft key for <b>INPUT 3/4</b> if using a 3.5mm mini jack. Use the <b>MASTER VOL</b> knob to adjust gain	

<p>to -80 dB. Push the input selection soft key to exit the channel menu.</p>	
<p>6. Connect an audio source using an XLR or TRS cable to <b>INPUT 1</b>, <b>INPUT 2</b>, or a 3.5mm mini jack to <b>INPUT 3/4</b>.</p>	
<p>7. Push the input selection soft key for <b>INPUT 1</b> or <b>INPUT 2</b> if using XLR or TRS cable, or push the input selection soft key for <b>INPUT 3/4</b> if using 3.5mm mini jack. Use the <b>MASTER VOL</b> knob to adjust gain to the required audio level slowly. Press the input soft key again to exit the channel menu.</p>	<p><b>INPUT1</b>    <b>INPUT2</b>    <b>INPUT3/4</b></p> 
<p>8. Adjust the <b>MASTER VOL</b> knob to 0 dB.</p>	<p><b>MASTER VOLUME</b></p> 

### 3 Pairing the QuickSmart Mobile app

The EV QuickSmart Mobile app is available for download for the iOS 12 and higher tablets and smart phones from the iTunes App Store or Android 6.0 and higher tablets and smart phones from the Google Play Store.



**Notice!**

The EV Quick**Smart** Mobile app is designed to only find speakers from Electro-Voice with Bluetooth® enabled.

The EV Quick**Smart** Mobile app will not display other types of Bluetooth® devices, e.g. phones, laptops, tablets, or headsets.



**Notice!**

Bluetooth® is available in select countries.

Contact your nearest Electro-Voice dealer or Electro-Voice distributor for more information.

Prior to pairing the EV Quick**Smart** Mobile app with Electro-Voice loudspeakers:

1. Ensure that Bluetooth® is enabled on the smartphone or tablet.
2. Ensure that pairing mode is enabled on the loudspeaker.

To place the speaker in pairing mode for both control and streaming:

1. Press and hold **INPUT 3/4** until Pairing Mode On the 4-digit ID is shown on the LCD. Pairing mode can be enabled through the LCD menu for control and streaming separately.
2. Navigate to your mobile device's Bluetooth® settings menu and ensure you are paired to the speaker.



**Notice!**

For Android devices ensure location services are allowed. Electro-Voice does not collect, store, or track user location data or personal information.

**First time pairing:**

1. Open the EV Quick**Smart** Mobile app. 
2. Finding nearby speakers is displayed on the screen  
The EV Quick**Smart** Mobile app is looking for available Bluetooth® enabled Electro-Voice loudspeakers.
3. The available loudspeakers are displayed on the screen.  
The app will display up to eight available loudspeakers.
4. Tap the loudspeaker you want to pair with the app.  
The selected loudspeaker will have a red line under it acknowledging it is selected.
5. Repeat the previous step until all of the required loudspeakers are selected.
6. Tap the red CONNECT button.
7. The app pairs with the required loudspeaker.  
The app can connect to up to six loudspeakers.

**Subsequent pairing:**

To pair the loudspeaker with the EV Quick**Smart** Mobile app:

1. Ensure that the pairing mode is enabled on the speaker.
2. Tap the EV Quick**Smart** Mobile app icon. 

3. Finding nearby speakers is displayed on the screen  
The EV Quick**Smart** Mobile app is looking for available Bluetooth® enabled Electro-Voice loudspeakers.
4. The available loudspeakers are displayed on the screen.  
The app will display up to eight available loudspeakers.
5. Tap the loudspeaker you want to pair with the app.  
The selected loudspeaker will have a red line under it acknowledging it is selected.
6. Repeat the previous step until all of the required loudspeakers are selected.
7. Tap the red CONNECT button.
8. The app pairs with the required loudspeaker.  
The app can connect to up to six loudspeakers.



## 4 Tripod and floor monitor operation

### 4.1 Tripod or pole mount

EVERSE 8 loudspeakers mount on a tripod stand or on a pole above a subwoofer.

#### Mounting a loudspeaker on a tripod stand

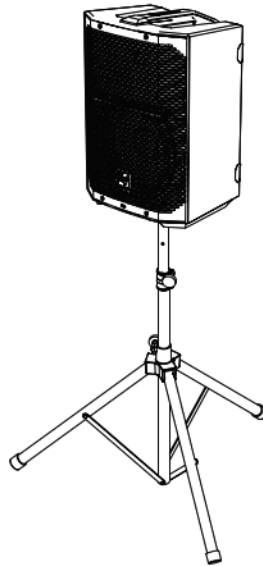

#### Caution!

Tripod is not evaluated for safety with this loudspeaker. Check the specifications of the tripod stand to be certain it is capable of supporting the weight of the loudspeaker.

To mount a loudspeaker on a tripod stand, do the following:

1. Place the tripod stand on a level and stable surface.
  - Fully extend the legs on the tripod stand.
  - Do not compromise the tripod stand's structural integrity by trying to make the stand taller.
  - Do not attempt to mount more than one loudspeaker on a stand designed for a single loudspeaker.
2. Lift the loudspeaker using two hands.
3. Set the pole cup located on the bottom of the loudspeaker onto the pole.

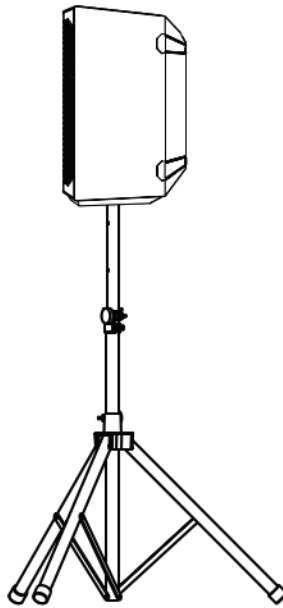
**Mounting a loudspeaker on a pole**

To mount a loudspeaker on a pole, do the following:

1. Place the subwoofer on a level and stable surface.
2. Insert the M20 threaded pole into the combo pole cup on the top of the subwoofer.
3. Turn the M20 threaded pole clockwise to secure the pole to the subwoofer.

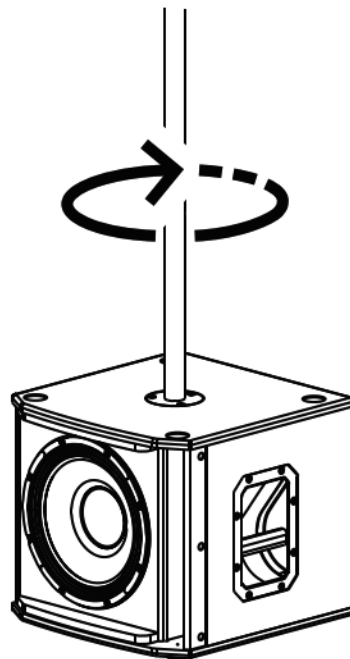

4. Lift the loudspeaker using two hands.
5. Set the pole cup located on the bottom of the loudspeaker onto the pole.

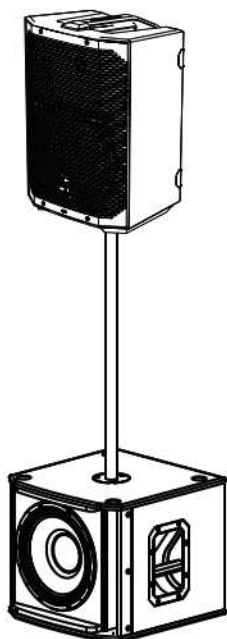

## 4.2 Floor monitor & kickback

EVERSE 8 loudspeakers may be used as a floor monitor or in kickback position by placing the loudspeaker on one of the two integral monitor angles.

To set up a loudspeaker as a floor monitor, do the following:

1. Place the loudspeaker on a level and stable surface.
2. Safely route cables to prevent injury to performers, production crew, and audience members.

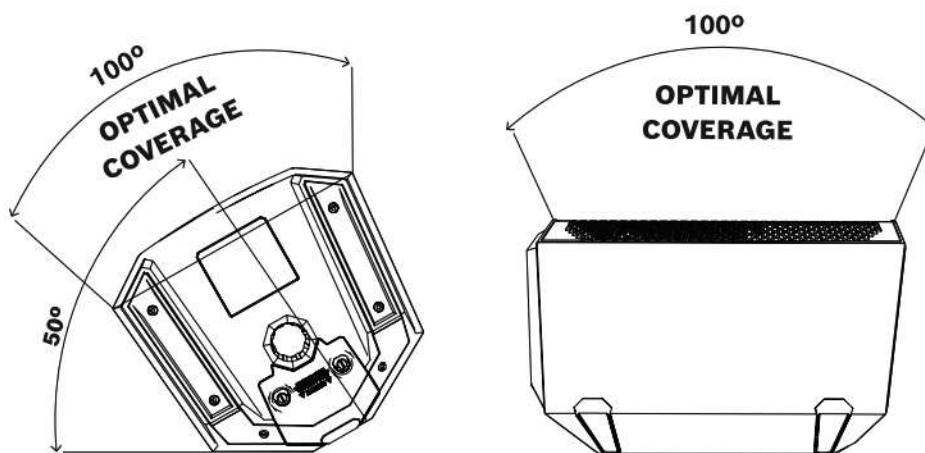

**Figure 4.1:** Optimum coverage in monitor position (side view left and front view right)

To set up a loudspeaker in kickback position, do the following:

1. Place the loudspeaker on a level and stable surface.
2. Safely route cables to prevent injury to performers, production crew, and audience members.

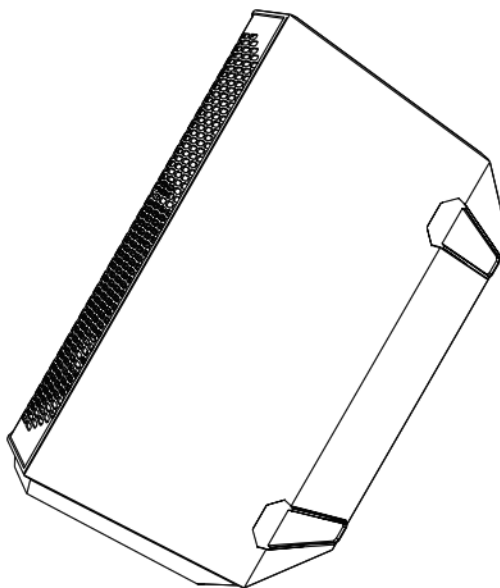

**Notice!**

Secure cables with wire ties or tape whenever possible.

## 5 Amplifier DSP

### 5.1 Amplifier DSP controls

The amplifier has a combination of controls and connectors to ensure the most versatile loudspeaker system.

#### Full-Range loudspeaker control and monitoring interface

The full-range loudspeaker DSP control menu selections are available for the EVERSE 8.



**Figure 5.1:** Full-range loudspeaker amplifier panel

1. **LCD** – DSP control and monitoring interface.
2. **MASTER VOL** - Adjusts the sound level and navigates DSP menu.  
**DSP** - Scroll through the menu and select the available choices. Push the MASTER VOL knob to enter the DSP menu.
3. **INPUT 1** - Balanced input for the connection of signal sources like mixing consoles, instruments, or microphones. Connections can be established using 1/4 inch TRS or XLR connectors.
4. **INPUT 2** - Balanced input for the connection of input sources like mixing consoles, or microphones via XLR connector or Hi-Z instrument connection via TRS.
5. **INPUT 3/4** - Bluetooth® stereo input for audio streaming or analog stereo input via 3.5mm mini-jack.
6. **POWER** – AC switch for switching the power ON or OFF. The LCD screen lights up when the power is turned ON, after approximately 3 seconds.
7. **MAINS IN** – AC connection is established via an IEC-connector.
8. **MIX OUT** - XLR output sends the mix of all input signals to another loudspeaker or subwoofer.
9. **FOOTSWITCH** - 1/4" TRS connector for connecting footswitch control to toggle FX on/off.
10. **DC POWER JACK** - 5.6 mm DC power out, 12 V DC 500 mA for powering wireless microphone receiver.

## 5.2

## System status

## Normal



1. **VOL** - Indicates the master gain of the system in dB. The range is from mute to +10 dB, in 1 dB increments.
2. **INPUT1** - VU meter displays the signal level of INPUT 1 into the amplifier from INPUT 1 connector. The display of **P** indicates 48 V phantom power is switched on.
3. **INPUT2** - VU meter displays the signal level of INPUT 2 into the amplifier from INPUT 2 connector. The display of **H** indicates Hi-Z instrument connection is present on the INPUT 2 TRS connection.
4. **INPUT3/4** - VU meter displays the signal level of INPUT 3/4 into the amplifier from Bluetooth® streaming or 3.5mm mini-jack
5. **C** - Control app. The available options are:
  - OFF** - DISABLED
  - FLASHING** - PAIRING MODE
  - SOLID** - CONNECTED
6. **S** - Audio streaming. The available options are:
  - OFF - DISABLED**
  - FLASHING** - PAIRING MODE (120s)
  - SOLID - CONNECTED**
7. **1** - Indicates the selected preset number. There are five user defined presents available.
8. **E** - Indicates the preset is not saved. When the preset is saved, the E is not displayed.
9. Battery level -
10. Lock status -
11. BASIC/MIXER mode -
12. **DUCK** - Ducking is activated on either or both INPUT 1 and 2.
13. **AFS** - Automatic feedback suppression is enabled.

**Notice!**

Bluetooth® is available in select countries.

Contact your nearest Electro-Voice dealer or Electro-Voice distributor for more information.

**System protection**

System protection limiters indicate when a system is exceeding recommended usage by indicating input **CLIP** or output **LIMIT** on the LCD display.

**CLIP**

**CLIP** indicates the signal to the loudspeaker is too high, resulting in a clipped signal into the loudspeaker. If **CLIP** is shown, reduce the input gain knob and/or the signal on the mixer or source equipment.



OR

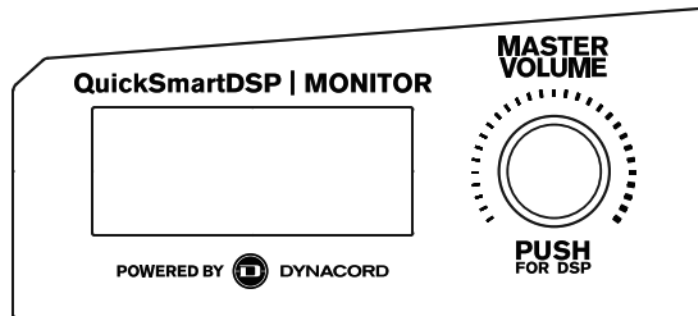

Figure 5.2: Limit system status

**LIMIT** protects the loudspeaker from short-term peaks which can cause distortion. When **LIMIT** is shown small on the screen, the limiter is active but keeps distortion under control. The large **LIMIT** indicates the sound is negatively affected. Reducing the output volume (**MASTER VOL**) is strongly recommended when the large limit indication is shown.

### 5.3 DSP controls

An integrated DSP control menu allows the user to select multiple DSP system settings on the loudspeaker.



#### Accessing the DSP control menu

To access the DSP control menu, do the following:

1. Push the **MASTER VOL** knob.  
The DSP control menu appears.
2. Using the **MASTER VOL** knob, scroll through the menu items.
3. Push the **MASTER VOL** knob to select the menu item you want to modify.  
The focus moves to the parameters on the right side of the **DSP** menu.
4. Using the **MASTER VOL** knob, scroll through the parameters.
5. Push the **MASTER VOL** knob to confirm the selected parameter.  
The setting is saved. The focus returns to the menu items on the left side of the **DSP** menu.
6. Repeat steps 2 through 5 to modify additional DSP and system settings.
7. Select **EXIT** to return to the home screen.

### 5.3.1

#### Full-Range loudspeaker DSP control menu

The full-range loudspeaker DSP control menu selections are available for the EVERSE 8 loudspeakers.

<b>EXIT</b>		
<b>FUNCTION</b>	MIXER	
	BASIC	
<b>MODE</b>	MODE MUSIC (Default)	
	LIVE	
	SPEECH	
	CLUB	
<b>LOCATION</b>	TRIPOD (Default)	
	MONITOR	
	KICKBACK	
<b>MAIN LEVEL</b>	0 dB (DEFAULT)	
	MUTE, -80 dB -10dB	
<b>AUX LEVEL</b>	0 dB (DEFAULT)	
	MUTE, -80 dB -10dB	
<b>LOCATION</b>	TRIPOD	
	KICKBACK	
	MONITOR	
<b>SUB</b>	100Hz	
	120Hz	
	150Hz	
	ELX200-12SP	
	ELX200-18SP	
	EKX-15SP	
	EKX-18SP	
<b>TREBLE</b>	0 dB (Default)	
	-12 dB to +6 dB	
<b>MID</b>	0 dB (Default)	
	-12 dB to +6 dB	
<b>BASS</b>	0 dB (Default)	
	-12 dB to +6 dB	
<b>MAIN PEQ</b>	ENABLE ALL	ON
		OFF



	RESET ALL	NO
		YES
	BYPASS	OFF
		ON
	PEQ #	1
		1 to 8
	TYPE	PEQ
		HI SHELF
		LOW SHELF
		HI PASS
		LOW PASS
	Q	0.7
		0.5 - 10.0
	FREQ	120 Hz
20 - 20.0kHz		
GAIN	0 dB	
	-12dB - 6 dB	
	RESET	
	BACK	
<b>FX</b>	01	
	00 to 30	
<b>FX ENABLE</b>	ON	
	OFF	
<b>AFS</b>	OFF	
	ON	
<b>MIX OUT</b>	L + R	
	L	
	R	
<b>BLUETOOTH</b>	BACK	
	BLUETOOTH	ON
		OFF
	ID	
	CONTROL PAIR	
	AUDIO PAR	

	LINK SPEAKERS	
	BACK	
<b>LED</b>		ON (Default)
		OFF
		LIMIT
<b>DISPLAY</b>	BACK	
	LCD DIM	ON (Default)
		OFF
	BRIGHT	5
		1 - 10
	CONTRAST	5
1 - 10		
BACK		
<b>STORE</b>	EXIT, 1, 2, 3, 4, 5, EXIT	
<b>RECALL</b>	EXIT, 1, 2, 3, 4, 5, 6, EXIT	
<b>RESET</b>	RESET ARE YOU SURE?	
	NO (Default)	
	YES	
<b>INFO</b>	[PRODUCT NAME]	
	[FIRMWARE VERSION]	
	©2021 Electro-Voice	
<b>EXIT</b>		

Tab. 5.1: Full-Range Loudspeaker DSP control menu

**EXIT menu**

The **Exit** menu is used to return to the home screen.



**Notice!**

The display returns to the home screen after two minutes of inactivity.

**MODE menu**

The **Mode** menu is used to configure the type of sound the loudspeaker delivers.

Available options for this selection are: MUSIC, LIVE, SPEECH and CLUB.

- **MUSIC** – is used for recorded music playback and electronic dance music applications. (Default)
- **LIVE** – is used for live sound applications.
- **SPEECH** – is used for spoken word applications.
- **CLUB** – is used for recorded electronic music playback.

The default is MUSIC.

#### **LOCATION menu**

The **Location** menu is used to optimize the loudspeaker for different boundaries.

Available options for this selection are: TRIPOD, MONITOR, and KICKBACK.

- **TRIPOD** - is used when the loudspeaker is placed on a tripod stand or placed on a pole.
- **MONITOR** – is used when the loudspeaker is placed on the angled monitor panel in monitor position. This setting compensates for the amount of low frequency boost created by placing the speaker close to the floor.
- **KICKBACK** - is used when the loudspeaker is placed on the angled rear kick-back position. This setting compensates for the amount of low frequency boost created by placing the speaker close to the floor.

The default is TRIPOD.

#### **SUB menu**

The **Sub** menu is used to select a high pass frequency for use with a subwoofer or a matched subwoofer.

Available options for this selection are: OFF, 100Hz, 120Hz, 150Hz, ELX200-12SP, ELX200-18SP, EKX-15SP and EKX-18SP. The 100 Hz, 120 Hz, and 150 Hz choices are generic high pass settings for use with other subwoofers. The ELX200-12SP, ELX200-18SP, EKX-15SP, and EKX-18SP settings are specifically optimized for subwoofers by including delay for best summation.

The default is OFF.

#### **TREBLE menu**

The **Treble** menu is used to adjust the high frequency performance of the loudspeaker for different applications or personal preference. The parameter controls a high shelving filter that is centered on 6 kHz.

The default is zero.

#### **MID menu**

The **MID** menu is used to adjust the midrange frequency performance of the loudspeaker for different applications or personal preference. The parameter controls a parametric EQ that is centered on 1.8 kHz.

The default is zero.

#### **BASS menu**

The **Bass** menu is used to adjust the low frequency performance of the loudspeaker for different applications or personal preference. The parameter controls a parametric EQ filter that is centered on 60 Hz.

The default is zero.

#### **LED menu**

The **LED** menu shows power on and indicates limit. Available options for this selection are: ON, OFF or LIMIT.

- **ON** - turns the LED on when the power to the loudspeaker is ON. (Default)
- **OFF** - turns the LED off.
- **LIMIT** - turns the LED off under normal operation. The LED brief blinking indicates the limiter is activating. Short-term blinking is not critical because the integrated limiter keeps distortion under control. Constant lighting of the LED indicates the sound is negatively affected. If the LED is constantly lit, check the rear LCD for more information. Reducing the output volume is strongly recommended.

**LCD DIM menu**

The **LCD Dim** menu is used to dim the display when the display is idle for two minutes. Available options for this selection are: ON or OFF.

The default is ON.

**BRIGHT menu**

The **Bright** menu is used to determine the brightness of the LCD.

The range is 1 to 10.

The default is five.

**CONTRAST menu**

The **Contrast** menu is used to increase or decrease the visibility of the LCD screen.

The default is five.

**STORE menu**

The **Store** menu allows you create up to five customized user settings. Available options for this selection are: EXIT, 1, 2, 3, 4, and 5.

**Notice!**

The customized user setting name can contain a combination of alphanumeric characters including spaces. The alphanumeric character range is A to Z and 0-9.

The name field length is 12 characters.

**Storing customized user settings**

To store customized user settings, do the following:

1. From the **DSP** menu, scroll to **STORE**.
2. Push the **MASTER VOL** knob to select **STORE**.  
The store screen appears.
3. Push the **MASTER VOL** knob to select 1.  
The Enter name for 1 screen appears.
4. Use the **MASTER VOL** knob to scroll through the characters.  
The characters appear.
5. Push the **MASTER VOL** knob to select the desired character.
6. Turn the **MASTER VOL** knob to move to the next character entry.  
Continue selecting characters until the desired name is entered.
7. Use the **MASTER VOL** knob to scroll to **SAVE**.
8. Push the **MASTER VOL** knob to select **SAVE**.
9. Repeat steps 3 through 8 to store additional customized user settings.
10. Select **EXIT** to return to the home screen.

**RECALL menu**

The **Recall** menu allows you retrieve up to five customized user settings. Available options for this selection are: EXIT, 1, 2, 3, 4, and 5. In addition, setting 6 is available to recall a default setting. This setting cannot be used to store user settings.

**Recalling customized user settings**

To recall customized user settings, do the following:

1. From the **DSP** menu, scroll to **RECALL**.
2. Push the **MASTER VOL** knob to select **RECALL**.  
The recall screen appears.
3. Push the **MASTER VOL** knob to select 1.  
The selected item is loaded.
4. Select **EXIT** to return to the home screen.

**LOCK menu**

The **Lock** menu is designed to prevent users from inadvertently changing settings. Available options for this selection are: NO or YES.

The default is NO.

**Locking the DSP menu**

To lock the **DSP** menu, do the following:

1. From the **DSP** menu, scroll to **LOCK**.
2. Select **ON**.

**Notice!**

If menu lock is ON, the user is allowed to adjust the MASTER VOL.

**Unlocking the DSP menu**

To unlock the **DSP** menu, do the following:

- ▶ Press and hold the **MASTER VOL** knob for three seconds.  
The **DSP** menu unlocks.

**CONTROL APP menu**

The **Control App** menu is used to enable the Quick**Smart** Mobile wireless control and monitoring application. Available options for this selection are: ON or OFF.

The default is OFF.

**Notice!**

Bluetooth® is available in select countries.

Contact your nearest Electro-Voice dealer or Electro-Voice distributor for more information.

The Bluetooth® word mark and logos are registered trademarks owned by Bluetooth SIG, Inc. and any use of such marks by Bosch Security Systems, LLC is under license. Other trademarks and trade names are those of their respective owners.

**Turning Bluetooth® ON or OFF**

To **turn Bluetooth® ON or OFF**, do the following:

1. Select **ON**.  
OR  
Select **OFF**.

The **Bluetooth menu** options are **ON/OFF**, **CONTROL PAIR**, and **AUDIO PAIR**.

**RESET menu**

The **Reset** menu is used to reset the loudspeaker to original factory settings. Available options for this selection are: NO or YES.

**Resetting the system**

To reset the system to original factory settings, do the following:

1. From the **DSP** menu, select **RESET**.  
The reset "Are you sure?" message appears.
2. Select **YES**.

The loudspeaker restarts and resets the system to the original factory settings.

**Notice!**

The reset menu item is used to revert the loudspeaker to the original factory default settings. All user settings will be deleted. The user customized settings in the STORE and RECALL menus return to <EMPTY>.

---

**INFO menu**

The **Information** menu is used to display the product name and firmware version.

## 6 Mixer Operation

### 6.1 Inputs 1, 2, & 3/4

#### INPUT LEVEL control

The **INPUT LEVEL** control adjusts the sensitivity of the incoming signals to the internal operation level of the mixer.

To achieve a good signal input level:

1. Set the **MASTER** volume controls to -80 dB.
2. Set the **INPUT LEVEL** control to -80 dB.
3. Connect the sound source (microphone, instrument and so on) to the required **LINE/MIC** input.
4. Start the sound source at the highest volume level to be expected. Sing or speak as loudly as possible directly (close up) into the microphone.
5. While playing the sound source or singing into the microphone:
  - Adjust the input level by using the **INPUT GAIN** control, so that during the loudest part, the **CLIP** does not show.
  - Increase the **MASTER VOL** until you get the required output from the column. This is the basic channel setting.

If further adjustments to the EQ setting of the channel are necessary, perform these steps again. Changes in the sound shaping section also have an influence on the overall level of the channel.

#### TREBLE/MID/BASS controls

The EQ section of the input channel allows for a broad difference in the shaping of the incoming audio signal within three frequency bands:

- **TREBLE** control - provides cymbals and vocals with more treble for a more transparent sound.
- **MID** control - provides higher output and reduces acoustical feedback by lowering the level.
- **BASS control** - adds more “punch” to the sound of a kick drum or “body” to the vocals.

#### Adjusting the incoming sound

Caution is advised when adjusting the incoming sound. Usually minor changes are sufficient to produce the best results in the overall sound.

To adjust the incoming sound:

- Set all EQ controls to 0.
- Avoid setting the EQ controls to extreme positions.
- Use natural reproduction as a starting point.
- Rely on your musically trained ear.

#### FX

The **FX** is used to set the amount of effect you require on that channel. Using the FX controls lets you easily assign an effect for groups of musical instruments or vocals.

To determine the required level of effect:

1. Set the controls to minimum.
2. Increase the level individually and gradually until the required sound is achieved.

The **FX Enable** switch turns the internal FX unit on or off. You can also use an external footswitch for turning the FX1 on or off. If you want to use a footswitch, the EVERSE 8 is preconfigured to control FX on/off with a footswitch, requiring no additional configuration.

**Phantom power**

+48 V DC Phantom power is available on the XLR connector of **INPUT 1** only. There is no phantom power on the TRS connectors. Phantom power is switchable.

**Notice!**

Switch off Phantom power (default) for devices which do not require phantom power such as dynamic microphones and mixer outputs.

**COMP control**

The **COMP** control controls the onboard compressor to adjust the input signal processing during operation. Compressors are available on **INPUTS 1 & 2**.

- ▶ Use the **COMP** control to adjust the compressor threshold and the compression ratio simultaneously.

Adjusting the **COMP control** from 0 to 100 will result in the following:

- The gain below the threshold will increase from 0 to 10 dB.
- The compression ratio will increase from 1:1 to 8:1.
- The compressor will reduce the dynamic range of the audio signal proportional to the compressor setting.

Once the signal exceeds a certain threshold, the signal gets compressed. Major input level changes result in minor output level changes. Narrowing the dynamic range often allows for easier recording or mixing of the audio signal. It is recommended to start with low to moderate levels of compression (25 - 40) and increase slowly if necessary.

**DUCKER**

The ducker reduces the level of the signal(s) on the other inputs whenever a signal is present at the selected MIC/LINE input (**INPUT 1** or **INPUT 2**). If no signal is present at the selected MIC/LINE input, the level of the signal(s) on the other inputs will return to the previous set levels.

The ducker is useful to speak over background music:

- When signal is present on the selected MIC input, the music on the other input channel will be reduced.
- When signal is no longer present, the music will return to the previous level.

**Engaging the ducker**

To engage the ducker:

1. Select **INPUT 1** and/or **INPUT 2**.
2. Adjust the **DUCKER** level to reduce the signal level on the other inputs. Typical values are -10 to -20 dB.

If the ducker is engaged on:

- **INPUT 1 - INPUT 2** and **INPUT 3/4** will be reduced by the selected value when signal is present at **INPUT 1**.
- **INPUT 2 - INPUT 1** and **INPUT 3/4** will be reduced by the selected value when signal is present at **INPUT 2**.
- **INPUT 1** and **INPUT 2** - only **INPUT 3/4** will be reduced by the selected value when signal is present at either **INPUT 1** or **INPUT 2**.

**AFS control**

The 12-band automatic feedback suppression (AFS) can be engaged to reduce unwanted feedback frequencies when microphones or instruments with pickups are used. Feedback occurs when sound from the speaker enters the microphone or pickup and is amplified by the speaker and played back again. High levels or extended periods of feedback can damage hearing and equipment.



### Reducing feedback

To reduce feedback:

1. Set the speaker and microphone or instrument according to your performance. Follow appropriate microphone placement and use practices:
  - Do not place the microphone directly in front of the speaker. Refer to the user manual of your microphone to know the pickup and rejection patterns of your microphone.
  - Avoid placing music stands, tablets, or other large flat objects near the microphone such that they can cause audio reflections into the microphone.
  - Use proper microphone technique when speaking, singing or playing by an instrument to avoid using excessive INPUT gain. For example, hold the microphone close to your mouth when performing.
  - Engage appropriate INPUT channel preset for your application: Low Cut 80 Hz, Low Cut 120 Hz, Vocal Mic, Voice Filter, Speech, Acoustic Guitar, etc.
  - Do not cup the microphone element with your hands while speaking or singing. Only hold the microphone by handle or body as per the microphone manufacturer's recommendation.
2. Enable AFS in the **DSP** menu or **FX** section of the QuickSmart Mobile app. This will enable AFS on INPUT 1 and 2.
3. Slowly turn up the output of the loudspeaker, and begin sound checking your microphone or instrument.
4. As you hear feedback, allow a few seconds for the AFS to detect and to reduce the feedback.
5. Continue sound check until no additional feedback tones are generated.

# 7 Recommended configurations

## 7.1 Connecting with mobile device

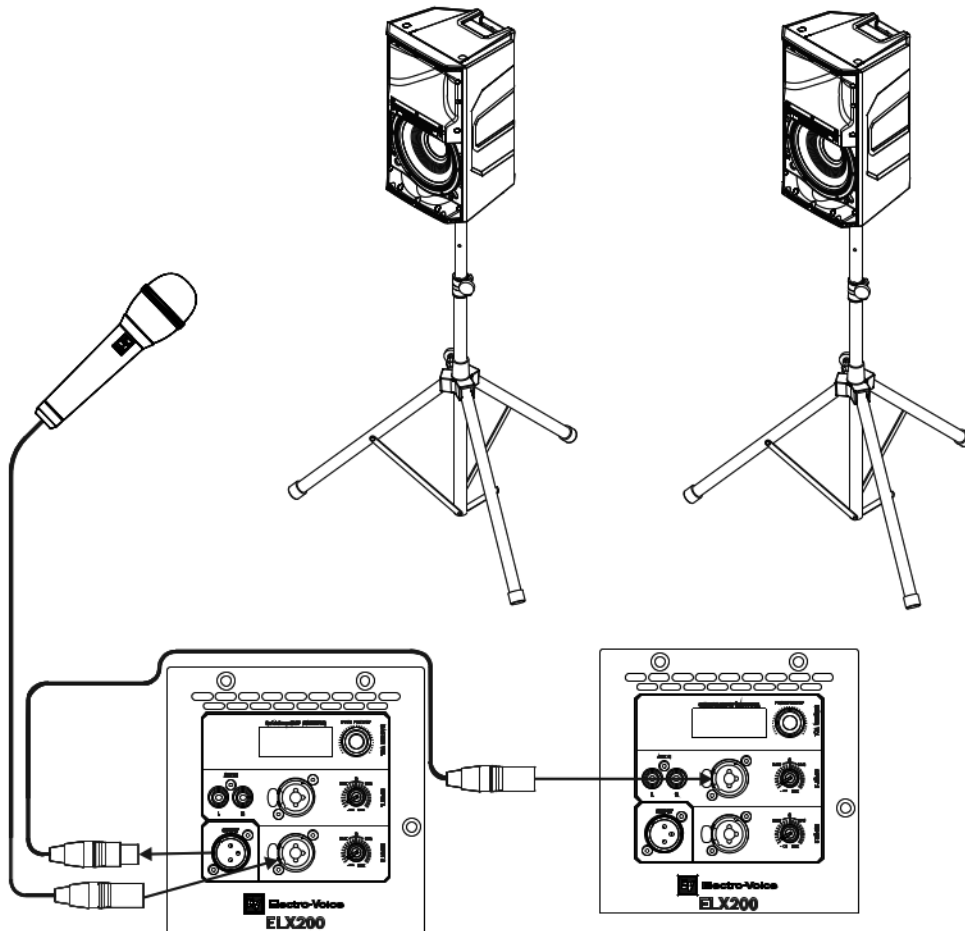

**Notice!**  
The direction of the arrow indicates the signal path.

<b>Mode:</b>	Music
<b>Location:</b>	Tripod
<b>Sub:</b>	Off
<b>INPUT preset:</b>	None

Tab. 7.2: DSP settings loudspeaker on a tripod

## 7.2 Street Musician performance

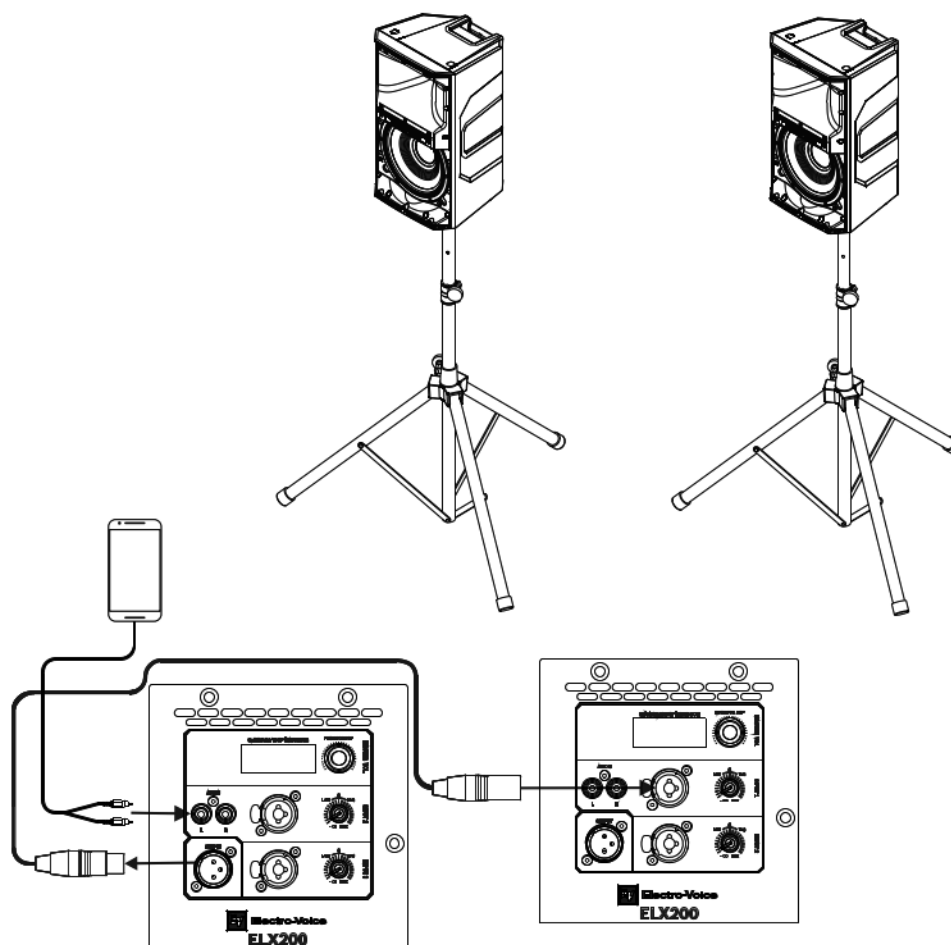

**Notice!**  
The direction of the arrow indicates the signal path.

<b>Mode:</b>	Live
<b>Location:</b>	Kickback
<b>Sub:</b>	Off
<b>INPUT 1 preset:</b>	Vocal Mic
<b>INPUT 2 preset:</b>	Acoustic GTR

Tab. 7.3: DSP settings loudspeaker in kickback position

### 7.3 Bluetooth True Wireless Stereo (TWS)

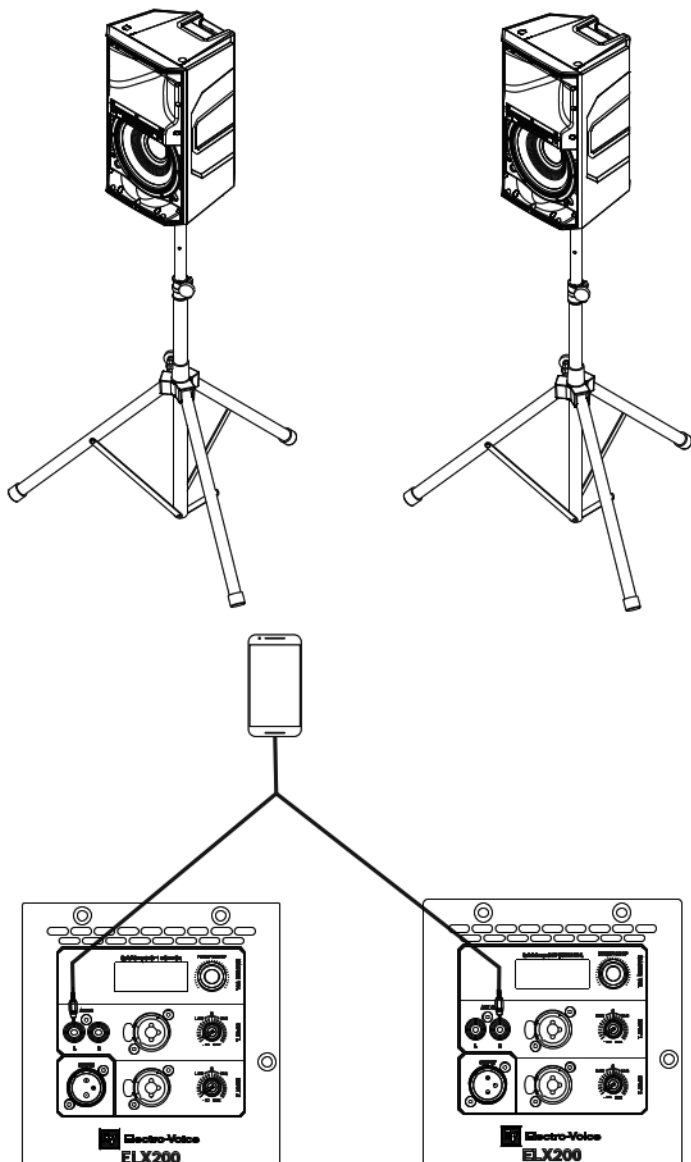

<b>Mode:</b>	Music
<b>Location:</b>	Tripod
<b>Sub:</b>	Off
<b>INPUT preset:</b>	None

Tab. 7.4: DSP settings loudspeaker on a tripod

### 7.4 Using as monitor

LINE and MIC input level control is available for both INPUT 1 and INPUT 2. The 12 o'clock position is unity gain (no gain or attenuation) and the range to the right of zero is for adjusting microphone levels.

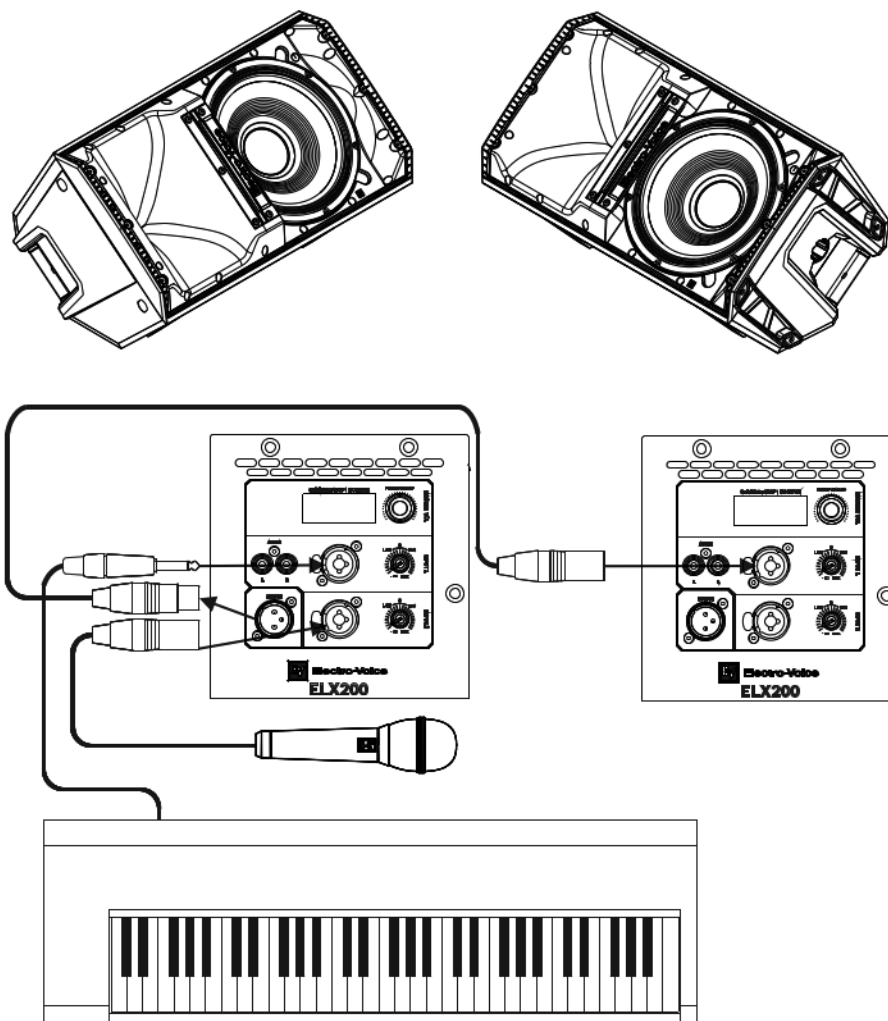

**Notice!**  
The direction of the arrow indicates the signal path.

<b>Mode:</b>	Live
<b>Location:</b>	Monitor
<b>Sub:</b>	Off
<b>INPUT 1 preset:</b>	Vocal Mic
<b>INPUT 2 preset:</b>	Bass GTR

Tab. 7.5: DSP settings loudspeakers as monitors

## 7.5 Using as monitor while recording

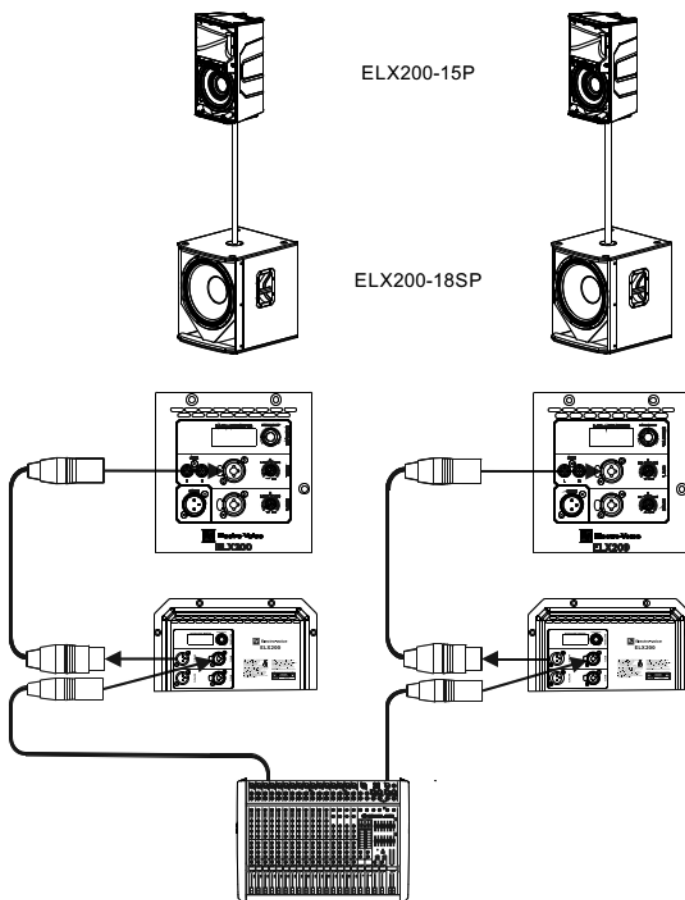

**Notice!**  
The direction of the arrow indicates the signal path.

<b>Mode:</b>	Live
<b>Location:</b>	Kickback
<b>INPUT 1 preset:</b>	Low CUT 120 Hz
<b>INPUT 2 preset:</b>	Electric GTR

Tab. 7.6: DSP settings loudspeakers as monitors while recording

## 8 Troubleshooting

Problem	Possible Cause(s)	Action
1. No sound	Amplifier	Verify all the electronics are on, the signal routing is correct, the source is active; the volume is turned up, etc. Correct/repair/replace as necessary. If there is still no sound, then the problem may be wiring.
	Wiring	Verify you have connected the correct cables to the amplifier. Play something at a low level through the amplifier. Connect a test loudspeaker in parallel with the malfunctioning line. If the sound level is gone or is very weak, the line has a short in it (possibly a severe scrape, pinch, or a missed connection). Using the test loudspeaker, move down the line and test each connection/junction until you find the problem and correct it. Observe proper polarity.
2. Poor Low-Frequency Response	With SUB menu cross-over frequency activated	If no subwoofers are used with the system, select the OFF position.
3. Intermittent output such as cracking or distortion	Faulty connection	Check all connections at amplifier and loudspeakers to ensure they are all clean and tight. If the problem persists, check the wiring. See problem 1.
4. Constant noise such as buzzing, hissing or humming	Defective source or other electronic device	If noise is present, but no program material is playing, evaluate each component as necessary to isolate the problem. Most likely there is a break in the signal path.
	Poor system grounding or ground loop	Check and correct the system grounding, as required.
	Input gain knob is not in the MIC position	Slowly increase the input gain knob level to engage the microphone pre-amp.
5. No sound produced with microphone connected to INPUT 1 or INPUT 2	Microphone requires phantom power.	Use a dynamic microphone that does not require phantom power. If using a microphone requiring phantom power, an external phantom power source is needed.
	Input gain knob is not in the MIC position	Slowly increase the input gain knob level to engage the microphone pre-amp.
6. Sound is distorted front LED is OFF, LCD screen LIMIT is ON	Excessive input level	Reduce the input level or loudspeaker level knobs to prevent limit.

Problem	Possible Cause(s)	Action
	Incorrect gain structure or source input (mixing console/preamp) is overdriven	Verify level controls of the source are properly structured by using the VU meter indicator on the LCD screen. If the VU meter bar is solid or the system indicates LIMIT, the input or source level is too high.
7. Microphone produces acoustic feedback when input level is amplified	Incorrect gain structure	Reduce the microphone levels at the mixing console or input source. If the microphone is connected directly to the speaker, reduce the input level on the speaker. Positioning the microphone close to the sound source increases gain-before-feedback. See problem 6.
	MODE is set to MUSIC	Change the MODE to LIVE or SPEECH.
	Microphone position is too close to the front of the loudspeaker	Whenever possible setup the loudspeakers so the microphone is behind them. If using the loudspeaker in a monitor position, aim the loudspeaker to the back of the microphone.
8. DSP menu is locked	The Menu Lock function has been turned on. A lock symbol displays on the LCD screen.	Press and hold the MASTER VOL knob for 5 seconds.
9. QuickSmart Mobile app does not detect the loudspeaker	Enable Bluetooth®	Ensure Bluetooth® is enabled on the loudspeaker.

If these suggestions do not solve your problem, contact your nearest Electro-Voice dealer or Electro-Voice distributor.



## 9 Technical data

EVERSE8-EU 8" 2-way speaker and EVERSE8-US 8" 2-way speaker

Frequency response (-3 dB) <sup>1</sup> :	65 Hz - 18 kHz
Frequency range (-10 dB) <sup>2</sup> :	50 Hz - 20 kHz
Max. SPL <sup>3</sup> :	121 dB
Coverage angle (H x V):	100° x 100°
Power rating:	200 W
LF transducer:	8 in. woofer - ferrite magnet
HF transducer:	1 in. titanium dome, neodymium magnet, ferro-fluid cooled
Crossover frequency:	2250 Hz
Connectors:	2 - XLR/TRS Combo, 1 - 3.5mm Stereo, 1 - USB-C, 1 - TRS footswitch, 1 - DC power
Enclosure:	Polypropylene
Grille:	Powder coated steel
USB charging:	1.5 A max, device-dependent
Color:	Black & White
Dimensions (H x W x D):	400 mm x 275 mm x 272 mm
Net weight:	7.6 kg
Shipping weight:	11.0 kg
Power consumption <sup>4</sup> :	100 - 240 V, ~50 - 60 Hz, 0.8 - 0.6 A
Battery capacity:	91 Wh
Battery run time (at max. output) <sup>5</sup> :	6+ hours
Battery run time (at moderate output) <sup>6</sup> :	12+ hours

<sup>1</sup>Full space measurement using music DSP preset.

<sup>2</sup>Half-space measurement.

<sup>3</sup> Maximum SPL is measured at 1 m using broadband pink noise at maximum output.

<sup>4</sup> Current rating is 1/8 power.

<sup>5</sup> Maximum output before speaker limit indication, with typical program material.

<sup>6</sup> Moderate output is approximately 95 dB SPL, with typical program material.

### 9.1 Dimensions

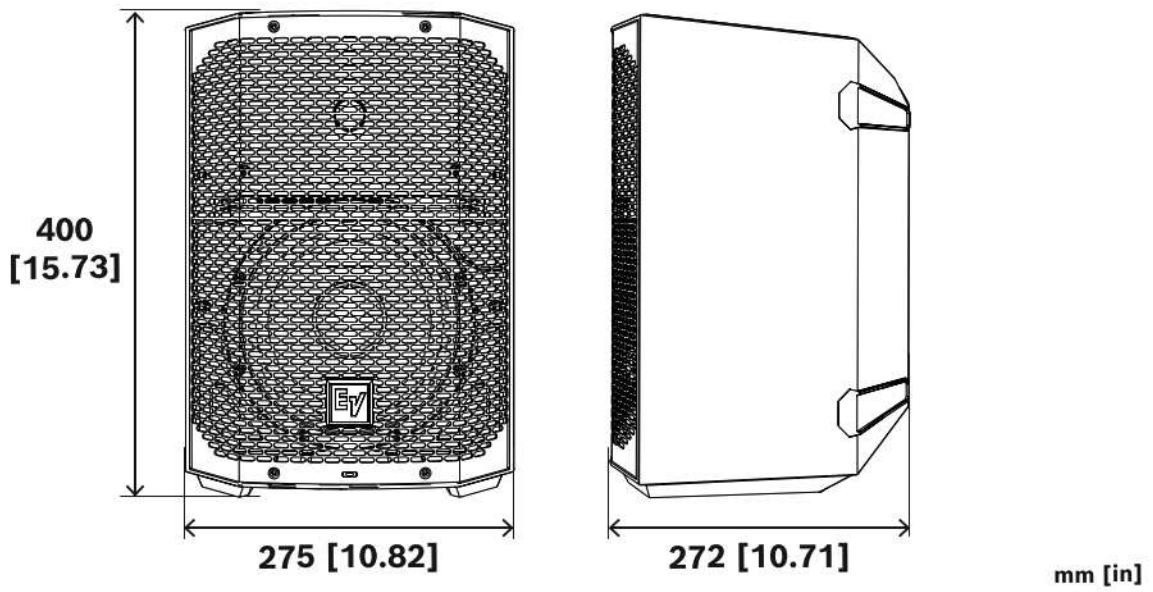

### 9.2 Frequency response

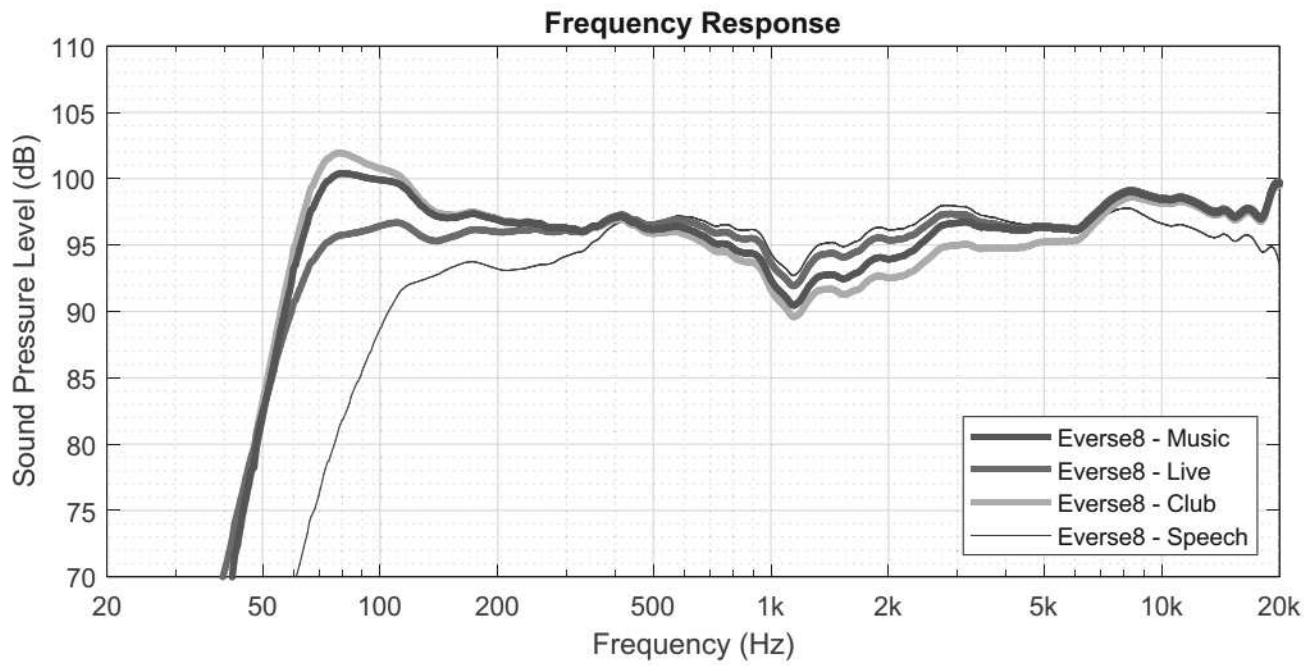







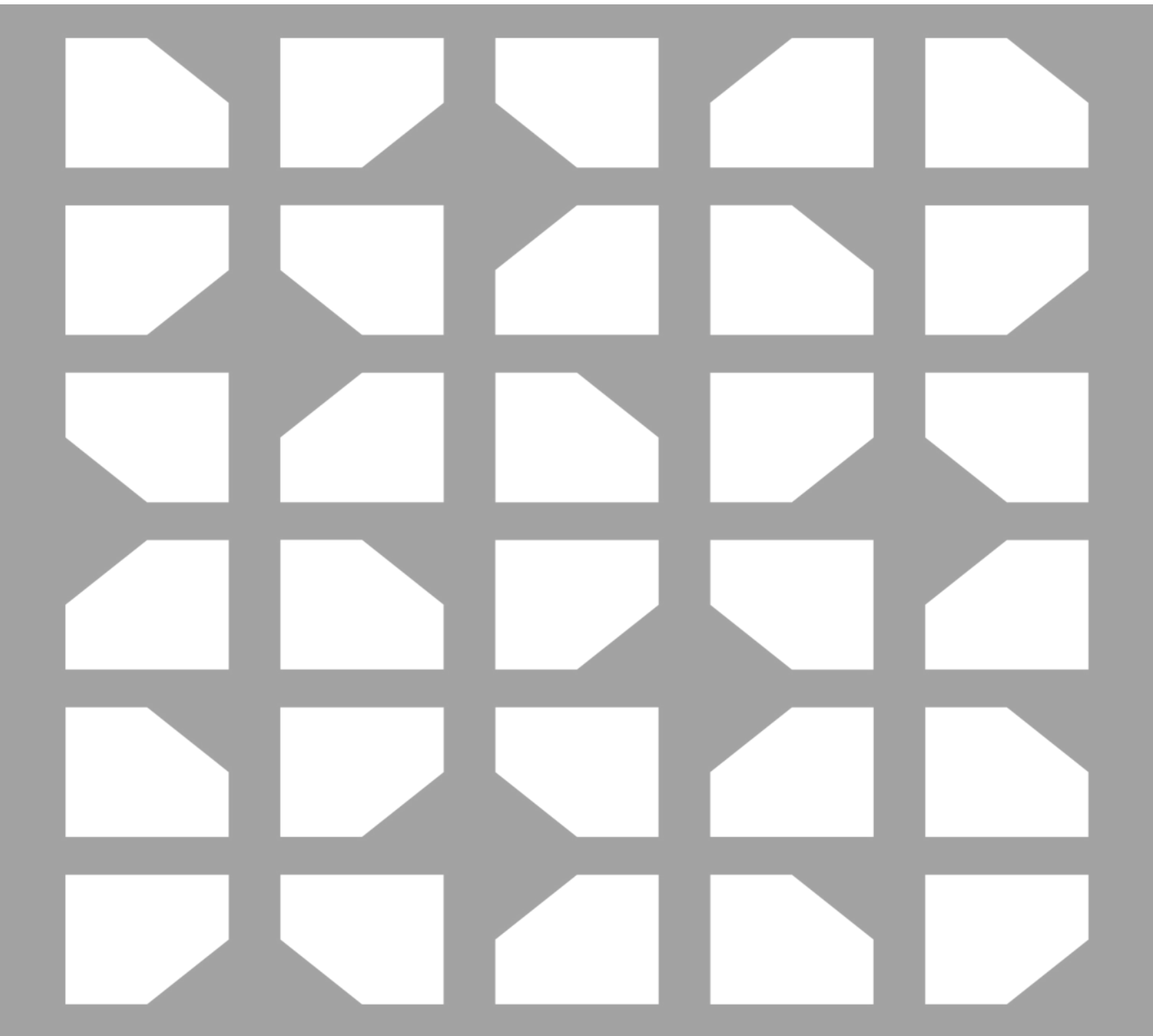

**Bosch Sicherheitssysteme GmbH**

Robert-Bosch-Ring 5

85630 Grasbrunn

Germany

[www.boschsecurity.com](http://www.boschsecurity.com)

© Bosch Sicherheitssysteme GmbH, 2021

**Bosch Security Systems, LLC**

12000 Portland Avenue South

Burnsville MN 55337

USA

[www.electrovoice.com](http://www.electrovoice.com)

© Bosch Security Systems, LLC, 2021

202109291928



F\_01U\_401\_530