

REV	DATE	DESCRIPTION	DRAWN BY
B	1/19/98	RELEASED	RWJ
C	2/25/98	PER ECR-7546	RWJ

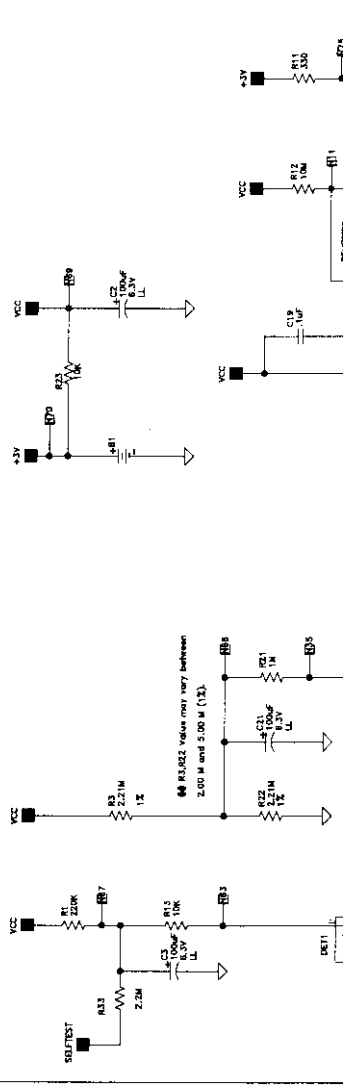
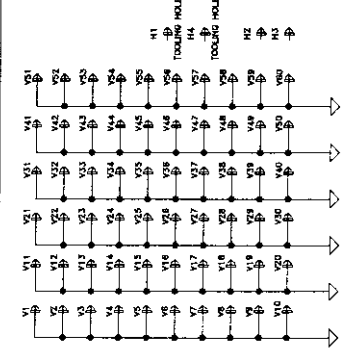

A

NOTE: PARTS WITH NO VALUE MAY HAVE OPTIONAL VALUES AND USAGE. SEE BILL OF MATERIALS FOR PROPER USE OF UNMARKED PARTS.

A

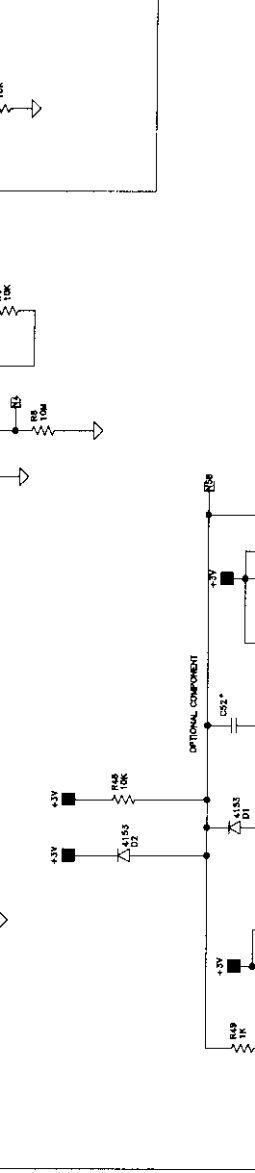
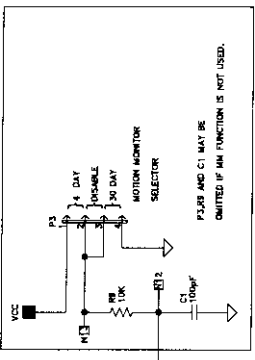
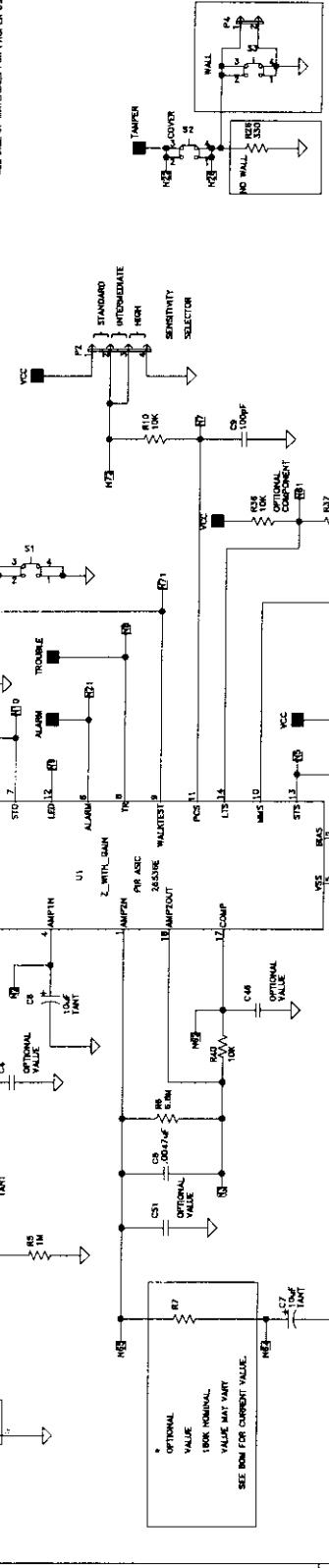

B

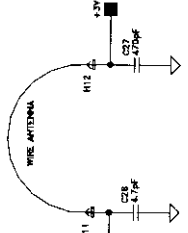

B

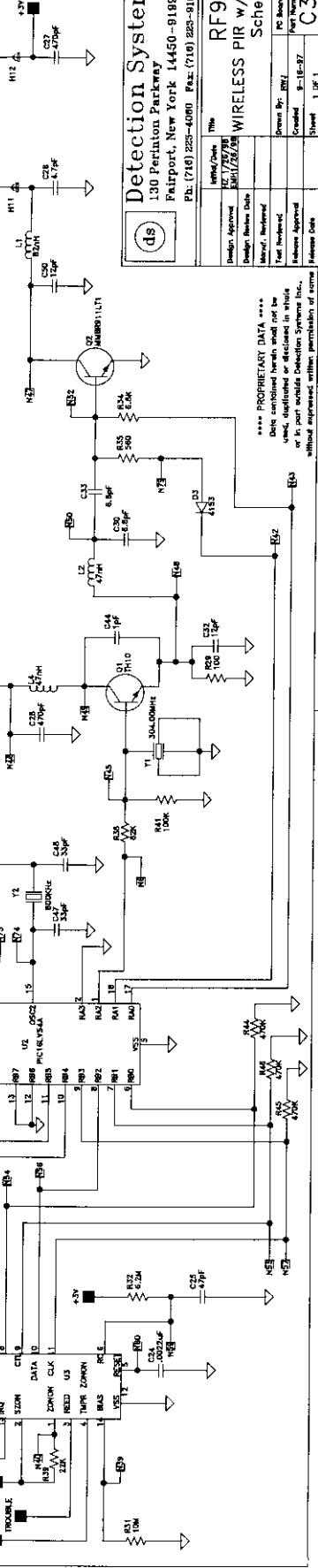

ds Detection Systems Inc.
130 Perinton Parkway
Fairport, New York 14450-9189
Ph: (716) 225-6000 Fax: (716) 225-9180

Design Approved	12/17/97	10/17/98	10/17/98
Design Review Date			
Manufact. Reviewed			
Field Reviewed			
Indicates Approved			
Release Date			

Model Code: 7546
Date: 12/17/97
Rev: 10/17/98
PC Board Number/Revision: RF920
Schematic
Drawn By: RWJ
Part Number: C34481
Sheet: 1 OF 1

*** PROPRIETARY DATA ***
Data contained herein shall not be
reproduced, stored in a retrieval system,
or transmitted in any form or by any means,
without expressed, written permission of source.

2

2