

FCC Radio Test Report

FCC ID: EROTSW1070

Report No. : BTL-FCCP-4-1911T046
Equipment : 10.1 inch Touch Screen wall mount
Model Name : M201923003, TSW-1070-B-S, TSW-1070-W-S, TSW-1070P-B-S,
 TSW-1070P-W-S, TSS-1070-B-S, TSS-1070-W-S
Brand Name : CRESTRON
Applicant : Crestron Electronics, Inc.
Address : 15 Volvo Drive, Rockleigh, NJ 07647

Radio Function : RLAN 5 GHz (U-NII 1, U-NII 3)

FCC Rule Part(s) : FCC Part15, Subpart E (15.407)
Measurement Procedure(s) : ANSI C63.10-2013

Date of Receipt : 2018/11/28
Date of Test : 2018/11/28 ~ 2020/1/5
Issued Date : 2020/3/24

The above equipment has been tested and found in compliance with the requirement of the above standards by BTL Inc.

Prepared by

 Peter Chen, Engineer

**Approved by**

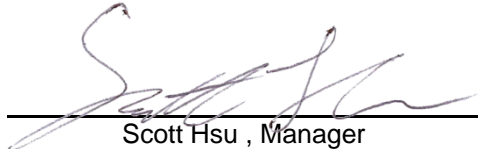
 Scott Hsu, Manager

BTL Inc.

No.18, Ln. 171, Sec. 2, Jiuzong Rd., Neihu Dist., Taipei City 114, Taiwan

Tel: +886-2-2657-3299

Fax: +886-2-2657-3331

Web: www.newbtl.com

Declaration

BTL represents to the client that testing is done in accordance with standard procedures as applicable and that test instruments used has been calibrated with standards traceable to international standard(s) and/or national standard(s).

BTL's reports apply only to the specific samples tested under conditions. It is manufacture's responsibility to ensure that additional production units of this model are manufactured with the identical electrical and mechanical components. **BTL** shall have no liability for any declarations, inferences or generalizations drawn by the client or others from **BTL** issued reports.

The report must not be used by the client to claim product certification, approval, or endorsement by NIST, A2LA, or any agency of the U.S. Government.

This report is the confidential property of the client. As a mutual protection to the clients, the public and ourselves, the test report shall not be reproduced, except in full, without our written approval.

BTL's laboratory quality assurance procedures are in compliance with the **ISO/IEC 17025** requirements, and accredited by the conformity assessment authorities listed in this test report.

BTL is not responsible for the sampling stage, so the results only apply to the sample as received.

The information, data and test plan are provided by manufacturer which may affect the validity of results, so it is manufacturer's responsibility to ensure that the apparatus meets the essential requirements of applied standards and in all the possible configurations as representative of its intended use.

Limitation

For the use of the authority's logo is limited unless the Test Standard(s)/Scope(s)/Item(s) mentioned in this test report is (are) included in the conformity assessment authorities acceptance respective.

Please note that the measurement uncertainty is provided for informational purpose only and are not use in determining the Pass/Fail results.

CONTENTS

REPORT ISSUED HISTORY	5
1 SUMMARY OF TEST RESULTS	6
1.1 TEST FACILITY	7
1.2 MEASUREMENT UNCERTAINTY	7
1.3 TEST ENVIRONMENT CONDITIONS	8
1.4 TABLE OF PARAMETERS OF TEXT SOFTWARE SETTING	8
1.5 DUTY CYCLE	9
2 GENERAL INFORMATION	10
2.1 DESCRIPTION OF EUT	10
2.2 TEST MODES	12
2.3 BLOCK DIAGRAM SHOWING THE CONFIGURATION OF SYSTEM TESTED	13
2.4 SUPPORT UNITS	13
3 RADIATED EMISSIONS TEST	14
3.1 LIMIT	14
3.2 TEST PROCEDURE	15
3.3 DEVIATION FROM TEST STANDARD	15
3.4 TEST SETUP	16
3.5 EUT OPERATING CONDITIONS	17
3.6 TEST RESULT – 9 KHZ TO 30 MHZ	17
3.7 TEST RESULT – 30 MHZ TO 1 GHZ	17
3.8 TEST RESULT – ABOVE 1 GHZ	17
4 BANDWIDTH TEST	18
4.1 LIMIT	18
4.2 TEST PROCEDURE	18
4.3 DEVIATION FROM TEST STANDARD	18
4.4 TEST SETUP	18
4.5 EUT OPERATING CONDITIONS	18
4.6 TEST RESULT	18
5 OUTPUT POWER TEST	19
5.1 LIMIT	19
5.2 TEST PROCEDURE	19
5.3 DEVIATION FROM TEST STANDARD	19
5.4 TEST SETUP	19
5.5 EUT OPERATING CONDITIONS	19
5.6 TEST RESULT	19
6 POWER SPECTRAL DENSITY	20
6.1 LIMIT	20
6.2 TEST PROCEDURE	20
6.3 DEVIATION FROM TEST STANDARD	20
6.4 TEST SETUP	20
6.5 EUT OPERATING CONDITIONS	20
6.6 TEST RESULT	20
7 LIST OF MEASURING EQUIPMENTS	21
8 EUT TEST PHOTO	22
9 EUT PHOTOS	22
APPENDIX A RADIATED EMISSIONS - 9 KHZ TO 30 MHZ	23

APPENDIX B	RADIATED EMISSIONS - 30 MHZ TO 1 GHZ	28
APPENDIX C	RADIATED EMISSIONS - ABOVE 1 GHZ	31
APPENDIX D	BANDWIDTH	82
APPENDIX E	CONDUCTED OUTPUT POWER	90
APPENDIX F	POWER SPECTRAL DENSITY	94

REPORT ISSUED HISTORY

Report Version	Description	Issued Date
R00	Original Issue.	2020/1/21
R01	Revised report to address TCB's comments.	2020/3/24

1 SUMMARY OF TEST RESULTS

Test procedures according to the technical standards.

FCC Part 15, Subpart E (15.407)				
Standard(s) Section	Description	Test Result	Judgement	Remark
15.207	AC Power Line Conducted Emissions	-----	N/A	NOTE(4)
15.205 15.209 15.407(b)	Radiated Emissions	APPENDIX A APPENDIX B APPENDIX C	Pass	-----
15.407(a)	Bandwidth	APPENDIX D	Pass	-----
15.407(a)	Output Power	APPENDIX E	Pass	-----
15.407(a)	Power Spectral Density	APPENDIX F	Pass	-----
15.203	Antenna Requirement	-----	Pass	-----
15.407(c)	Automatically Discontinue Transmission	-----	Pass	NOTE (2)

NOTE:

- (1) "N/A" denotes test is not applicable in this Test Report.
- (2) The EUT can detect the controlling signal of ACK message transmitting from remote device and verify whether it shall resend or discontinue transmission.
- (3) The report format version is TP.1.1.1.
- (4) Input power is supplied by POE.

1.1 TEST FACILITY

The test facilities used to collect the test data in this report:

No. 68-1, Ln. 169, Sec. 2, Datong Rd., Xizhi Dist., New Taipei City 221, Taiwan

The test sites and facilities are covered under FCC RN: 355421 and DN: TW1099.

- C05 CB08 CB11 CB15 CB16
 SR06

No.18, Ln. 171, Sec. 2, Jiuzong Rd., Neihu Dist., Taipei City 114, Taiwan

The test sites and facilities are covered under FCC RN: 325517 and DN: TW1115.

- C03 CB18 CB19

1.2 MEASUREMENT UNCERTAINTY

The reported uncertainty of measurement $y \pm U$, where expanded uncertainty U is based on a standard uncertainty multiplied by a coverage factor of $k = 2$, providing a level of confidence of approximately **95 %**.

The measurement instrumentation uncertainty considerations contained in CISPR 16-4-2. The BTL measurement uncertainty is less than the CISPR 16-4-2 U_{cispr} requirement.

A. Radiated emissions below 1 GHz test :

Test Site	Method	Measurement Frequency Range	Ant. H / V	U,(dB)
CB18 (3m)	CISPR	30MHz ~ 200MHz	V	4.20
		30MHz ~ 200MHz	H	3.64
		200MHz ~ 1,000MHz	V	4.56
		200MHz ~ 1,000MHz	H	3.90

B. Radiated emissions above 1 GHz test :

Test Site	Method	Measurement Frequency Range	Ant. H / V	U,(dB)
CB18 (3m)	CISPR	1GHz ~ 6GHz	V	4.46
		1GHz ~ 6GHz	H	4.40
		6GHz ~ 18GHz	V	3.88
		6GHz ~ 18GHz	H	4.00

Test Site	Method	Measurement Frequency Range	U,(dB)
CB18 (1m)	CISPR	18 ~ 26.5 GHz	4.62
		26.5 ~ 40 GHz	5.12

C. Conducted test :

Test Item	U,(dB)
Bandwidth	1.13
Output power	1.07
Power Spectral Density	1.20
Conducted Band edges	1.13
Frequency Stability	1.13

NOTE:

Unless specifically mentioned, the uncertainty of measurement has not been taken into account to declare the compliance or non-compliance to the specification.

1.3 TEST ENVIRONMENT CONDITIONS

Test Item	Environment Condition	Tested by
Radiated emissions below 1 GHz	23°C, 65%	Hunter Chiang
Radiated emissions above 1 GHz	23°C, 65%	Hunter Chiang
Bandwidth	25.3 °C, 45 %	Jay Kao
Output Power	25.3 °C, 45 %	Jay Kao
Power Spectral Density	25.3 °C, 45 %	Jay Kao

1.4 TABLE OF PARAMETERS OF TEXT SOFTWARE SETTING

UNII-1				
Test Software	QRCT 4			
Mode	5180 MHz	5200 MHz	5240 MHz	Data Rate
IEEE 802.11a	13	14	14	6 Mbps
IEEE 802.11n (HT20)	13	14	14	MCS 0
IEEE 802.11ac (VHT20)	13	14	14	MCS 0
Mode	5190 MHz	5230 MHz		Data Rate
IEEE 802.11n (HT40)	9	14		MCS 0
IEEE 802.11ac (VHT40)	9	14		MCS 0
Mode	5210 MHz			Data Rate
IEEE 802.11ac (VHT80)	9			MCS 0

UNII-3				
Test Software	QRCT 4			
Mode	5745 MHz	5785 MHz	5825 MHz	Data Rate
IEEE 802.11a	13	13	13	6 Mbps
IEEE 802.11n (HT20)	13	13	13	MCS 0
IEEE 802.11ac (VHT20)	13	13	13	MCS 0
Mode	5755 MHz	5795 MHz		Data Rate
IEEE 802.11n (HT40)	13	13		MCS 0
IEEE 802.11ac (VHT40)	13	13		MCS 0
Mode	5775 MHz			Data Rate
IEEE 802.11ac (VHT80)	14			MCS 0

1.5 DUTY CYCLE

If duty cycle is $\geq 98\%$, duty factor is not required.

If duty cycle is $< 98\%$, duty factor shall be considered.

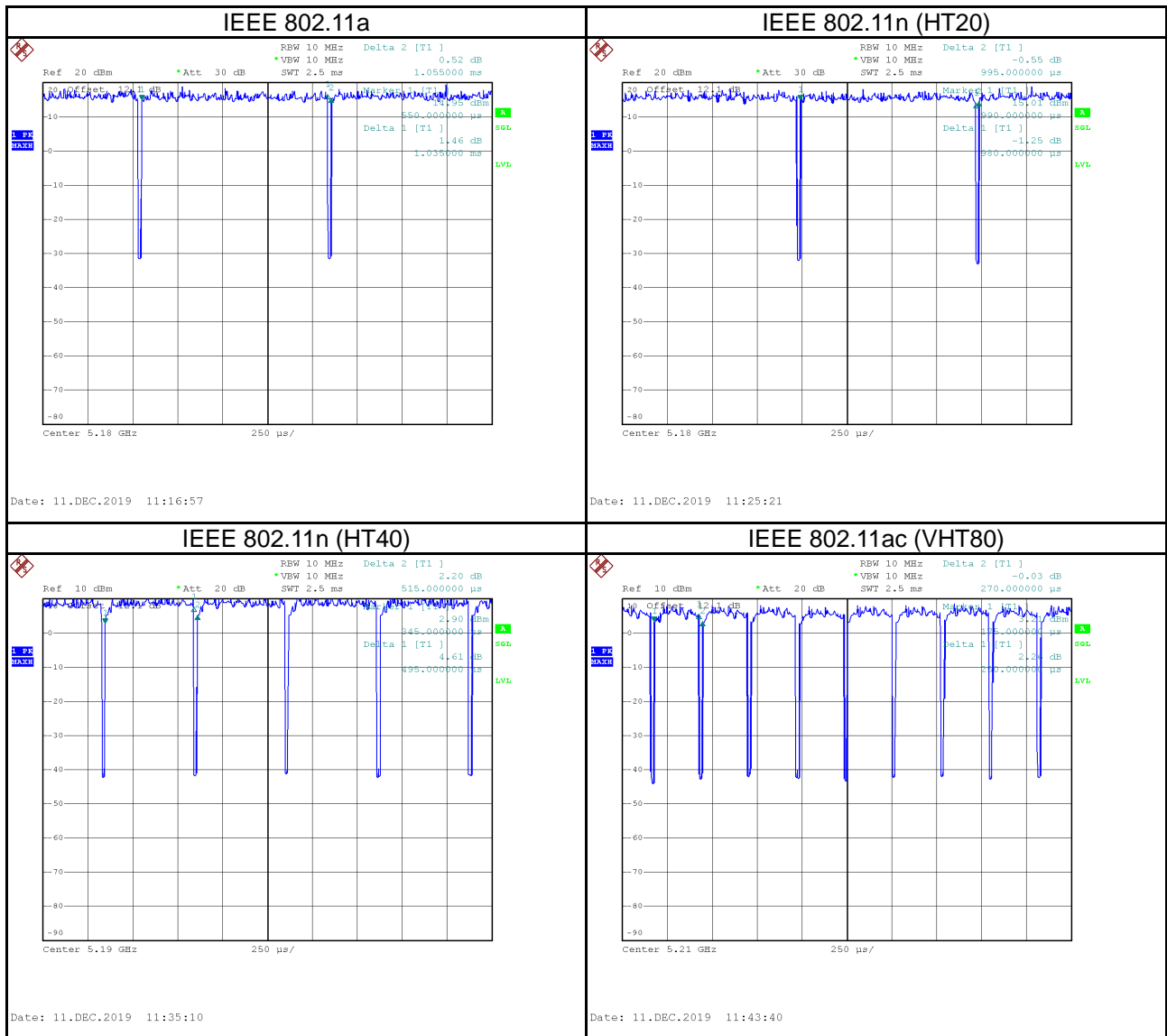

Remark	Delta 1			Delta 2	On Time/Period	10 log(1/Duty Cycle)
Mode	ON (ms)	Numbers (ON)	On Time (B) (ms)	Period (ON+OFF) (ms)	Duty Cycle (%)	Duty Factor (dB)
IEEE 802.11a	1.035	1	1.035	1.055	98.10%	0.08
IEEE 802.11n (HT20)	0.980	1	0.980	0.995	98.49%	0.07
IEEE 802.11n (HT40)	0.495	1	0.495	0.515	96.12%	0.17
IEEE 802.11n (HT40)	0.250	1	0.250	0.270	92.59%	0.33

2 GENERAL INFORMATION

2.1 DESCRIPTION OF EUT

Equipment	10.1 inch Touch Screen wall mount
Model Name	M201923003, TSW-1070-B-S, TSW-1070-W-S, TSW-1070P-B-S, TSW-1070P-W-S, TSS-1070-B-S, TSS-1070-W-S
Brand Name	CRESTRON
Model Difference	M201923003 includes six series: TSW-1070-B-S, TSW-1070-W-S, TSW-1070P-B-S, TSW-1070P-W-S, TSS-1070-B-S, TSS-1070-W-S All modes are identical to each other except below: B: Black, W: White, P: Portrait, S: Smooth, TSS: Touch Screen Scheduling
Power Source	DC voltage supplied from POE.
Power Rating	I/P: 48 VDC 350mA (802.3at type 1), 48 VDC 600mA (802.3at type 2)
Products Covered	N/A
Frequency Range	UNII-1: 5150 MHz to 5250 MHz UNII-3: 5725 MHz to 5850 MHz
Operation Frequency	UNII-1: 5180 MHz to 5240 MHz UNII-3: 5745 MHz to 5825 MHz
Modulation Technology	OFDM
Transfer Rate	up to 433.3 Mbps
Output Power Max. for UNII-1	IEEE 802.11a: 13.76 dBm (0.0238 W) IEEE 802.11n (HT20): 13.73 dBm (0.0236 W) IEEE 802.11n (HT40): 13.54 dBm (0.0226 W) IEEE 802.11ac (VHT20): 13.63 dBm (0.0231 W) IEEE 802.11ac (VHT40): 13.26 dBm (0.0212 W) IEEE 802.11ac (VHT80): 8.06 dBm (0.0064 W)
Output Power Max. for UNII-3	IEEE 802.11a: 19.16 dBm (0.0824 W) IEEE 802.11n (HT20): 19.03 dBm (0.0800 W) IEEE 802.11n (HT40): 19.09 dBm (0.0811 W) IEEE 802.11ac (VHT20): 18.95 dBm (0.0785 W) IEEE 802.11ac (VHT40): 18.86 dBm (0.0769 W) IEEE 802.11ac (VHT80): 18.51 dBm (0.0710 W)
Test Model	M201923003
Sample Status	Engineering Sample
EUT Modification(s)	N/A

NOTE:

- (1) For a more detailed features description, please refer to the manufacturer's specifications or the user's manual.

(2) Channel List:

UNII-1					
IEEE 802.11a IEEE 802.11n (HT20) IEEE 802.11ac (VHT20)		IEEE 802.11n (HT40) IEEE 802.11ac (VHT40)		IEEE 802.11ac (VHT80)	
Channel	Frequency (MHz)	Channel	Frequency (MHz)	Channel	Frequency (MHz)
36	5180	38	5190	42	5210
40	5200	46	5230		
44	5220				
48	5240				

UNII-3					
IEEE 802.11a IEEE 802.11n (HT20) IEEE 802.11ac (VHT20)		IEEE 802.11n (HT40) IEEE 802.11ac (VHT40)		IEEE 802.11ac (VHT80)	
Channel	Frequency (MHz)	Channel	Frequency (MHz)	Channel	Frequency (MHz)
149	5745	151	5755	155	5775
153	5765	159	5795		
157	5785				
161	5805				
165	5825				

(3) Table for Filed Antenna:

Ant.	Brand	Model Name	Antenna Type	Connector	Gain (dBi)	Note
1	YAGEO	TSW WLAN MAIN	PIFA	IPEX	2.23	UNII-1
					3.95	UNII-3

2.2 TEST MODES

Test Items	Test mode	Channel	Note
AC power line conducted emissions	TX Mode_IEEE 802.11a	149	-
Transmitter Radiated Emissions (below 1GHz)	TX Mode_IEEE 802.11a	149	-
Transmitter Radiated Emissions (above 1GHz)	TX Mode_IEEE 802.11a	36/48	Bandedge
	TX Mode_IEEE 802.11n (HT20)	149/165	
	TX Mode_IEEE 802.11ac (VHT40)	38/46 151/159	
	TX Mode_IEEE 802.11ac (VHT80)	42 155	
	Harmonic	TX Mode_IEEE 802.11a	36/40/48
		TX Mode_IEEE 802.11n (HT20)	149/157/165
		TX Mode_IEEE 802.11ac (VHT40)	38/46 151/159
		TX Mode_IEEE 802.11ac (VHT80)	42 155
Bandwidth	TX Mode_IEEE 802.11a	36/40/48	-
	TX Mode_IEEE 802.11n (HT20)	149/157/165	
	TX Mode_IEEE 802.11n (HT40)	38/46 151/159	
	TX Mode_IEEE 802.11ac (VHT80)	42 155	
Output Power	TX Mode_IEEE 802.11a	36/40/48 149/157/165	-
	TX Mode_IEEE 802.11n (HT20)		
	TX Mode_IEEE 802.11ac (VHT20)		
	TX Mode_IEEE 802.11n (HT40)	38/46	
	TX Mode_IEEE 802.11ac (VHT40)	151/159	
Power Spectral Density	TX Mode_IEEE 802.11a	42 155	-
	TX Mode_IEEE 802.11n (HT20)	36/40/48 149/157/165	
	TX Mode_IEEE 802.11n (HT40)	38/46 151/159	
	TX Mode_IEEE 802.11ac (VHT80)	42 155	

NOTE:

- (1) The Radiated emissions test was verified based on the worst conducted power and Bandwidth test results reported in the original report.
- (2) For radiated emission band edge test, both Vertical and Horizontal are evaluated, but only the worst case (Vertical) is recorded.
- (3) All X, Y and Z axes are evaluated, but only the worst case (Z axis) is recorded.

2.3 BLOCK DIAGRAM SHOWING THE CONFIGURATION OF SYSTEM TESTED

Equipment letters and Cable numbers refer to item numbers described in the tables of clause 2.4.

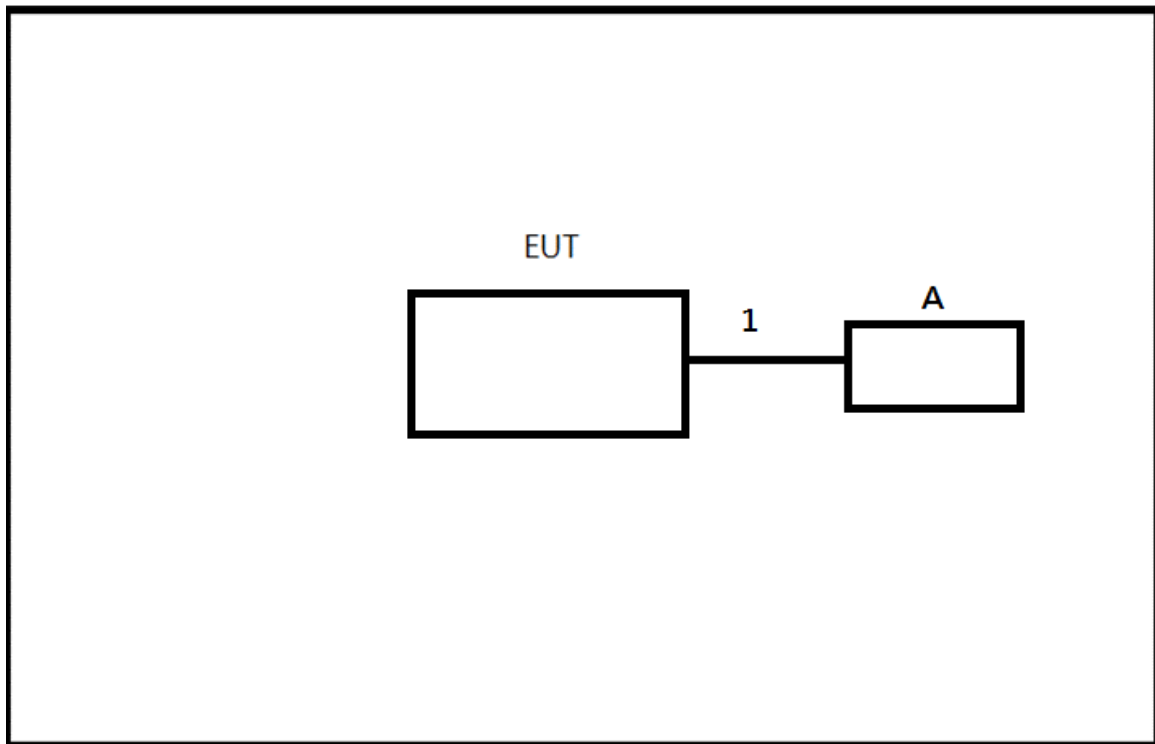

2.4 SUPPORT UNITS

Item	Equipment	Brand	Model No.	Series No.	Remarks
A	MANAGED POE SWITCH	CRESTRON	CEN-SWPOE-16	N/A	-

Item	Shielded	Ferrite Core	Length	Cable Type	Remarks
1	NO	NO	3m	LAN Cable	-

3 RADIATED EMISSIONS TEST

3.1 LIMIT

In case the emission fall within the restricted band specified on 15.205, then the 15.209 limit in the table below has to be followed.

LIMITS OF RADIATED EMISSIONS MEASUREMENT (9 kHz to 1000 MHz)

Frequency (MHz)	Field Strength (microvolts/meter)	Measurement Distance (meters)
0.009~0.490	2400/F(KHz)	300
0.490~1.705	24000/F(KHz)	30
1.705~30.0	30	30
30~88	100	3
88~216	150	3
216~960	200	3
960~1000	500	3

LIMITS OF UNWANTED EMISSION OUT OF THE RESTRICTED BANDS

Frequency (MHz)	EIRP Limit (dBm)	Equivalent Field Strength at 3m (dBµV/m)
5150-5250	-27	68.3
5250-5350	-27	68.3
5470-5725	-27	68.3
5725-5850	-27 (NOTE 2)	68.3
	10 (NOTE 2)	105.3
	15.6 (NOTE 2)	110.9
	27 (NOTE 2)	122.3

NOTE:

(1) The following formula is used to convert the equipment isotropic radiated power (eirp) to field strength:

$$E = \frac{1000000\sqrt{30P}}{3} \mu\text{V/m, where P is the eirp (Watts)}$$

(2) According to FCC 16-24, All emissions shall be limited to a level of -27 dBm/MHz at 75 MHz or more above or below the band edge increasing linearly to 10 dBm/MHz at 25 MHz above or below the band edge, and from 25 MHz above or below the band edge increasing linearly to a level of 15.6 dBm/MHz at 5 MHz above or below the band edge, and from 5 MHz above or below the band edge increasing linearly to a level of 27 dBm/MHz at the band edge.

(3) The test result calculated as following:

Measurement Value = Reading Level + Correct Factor

Correct Factor = Antenna Factor + Cable Loss - Amplifier Gain(if use)

Margin Level = Measurement Value - Limit Value

Calculation example:

Reading Level		Correct Factor		Measurement Value
19.11	+	2.11	=	21.22

Measurement Value		Limit Value		Margin Level
21.22	-	68.3	=	-47.08

Spectrum Parameter	Setting
Attenuation	Auto
Start Frequency	1000 MHz
Stop Frequency	10th carrier harmonic
RBW / VBW (Emission in restricted band)	1MHz / 3MHz for Peak, 1MHz / 1/T for Average

Spectrum Parameter	Setting
Attenuation	Auto
Start ~ Stop Frequency	9KHz~90KHz for PK/AVG detector
Start ~ Stop Frequency	90KHz~110KHz for QP detector
Start ~ Stop Frequency	110KHz~490KHz for PK/AVG detector
Start ~ Stop Frequency	490KHz~30MHz for QP detector
Start ~ Stop Frequency	30MHz~1000MHz for QP detector

3.2 TEST PROCEDURE

- a. The measuring distance of 3 m shall be used for measurements. The EUT was placed on the top of a rotating table 0.8 meter above the ground at a 3 meter semi-anechoic chamber. The table was rotated 360 degrees to determine the position of the highest radiation.(below 1GHz)
- b. The measuring distance of 3 m shall be used for measurements. The EUT was placed on the top of a rotating table 1.5 meter above the ground at a 3 meter semi-anechoic chamber. The table was rotated 360 degrees to determine the position of the highest radiation.(above 1GHz)
- c. The height of the equipment or of the substitution antenna shall be 0.8 m or 1.5 m, the height of the test antenna shall vary between 1 m to 4 m. Both horizontal and vertical polarizations of the antenna are set to make the measurement.
- d. For each suspected emission, the EUT was arranged to its worst case and then the antenna was tuned to heights find the maximum reading (used Bore sight function).
- e. The receiver system was set to peak and average detect function and specified bandwidth with maximum hold mode when the test frequency is above 1GHz.
- f. The initial step in collecting radiated emission data is a receiver peak detector mode pre-scanning the measurement frequency range. Significant peaks are then marked and then Quasi Peak detector mode re-measured.
- g. All readings are Peak unless otherwise stated QP in column of Note. Peak denotes that the Peak reading compliance with the QP Limits and then QP Mode measurement didn't perform. (below 1GHz)
- h. All readings are Peak Mode value unless otherwise stated AVG in column of Note. If the Peak Mode Measured value compliance with the Peak Limits and lower than AVG Limits, the EUT shall be deemed to meet both Peak & AVG Limits and then only Peak Mode was measured, but AVG Mode didn't perform. (above 1GHz)
- i. For the actual test configuration, please refer to the related Item – EUT TEST PHOTO.

3.3 DEVIATION FROM TEST STANDARD

No deviation.

3.4 TEST SETUP

9 kHz to 30 MHz

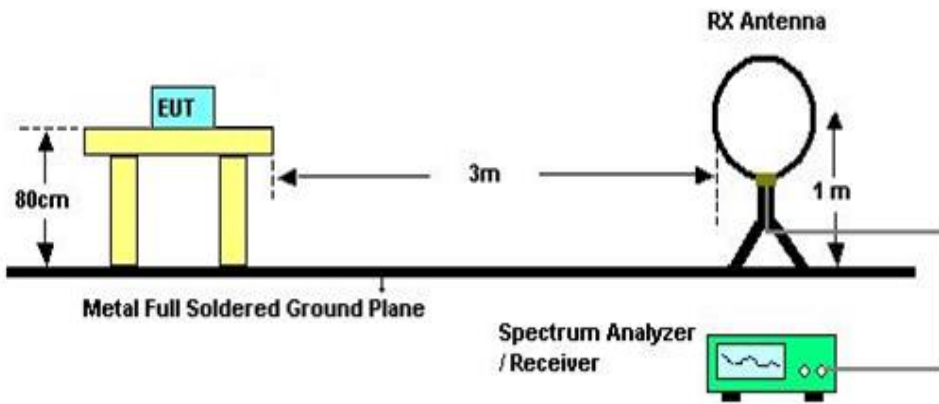

30 MHz to 1 GHz

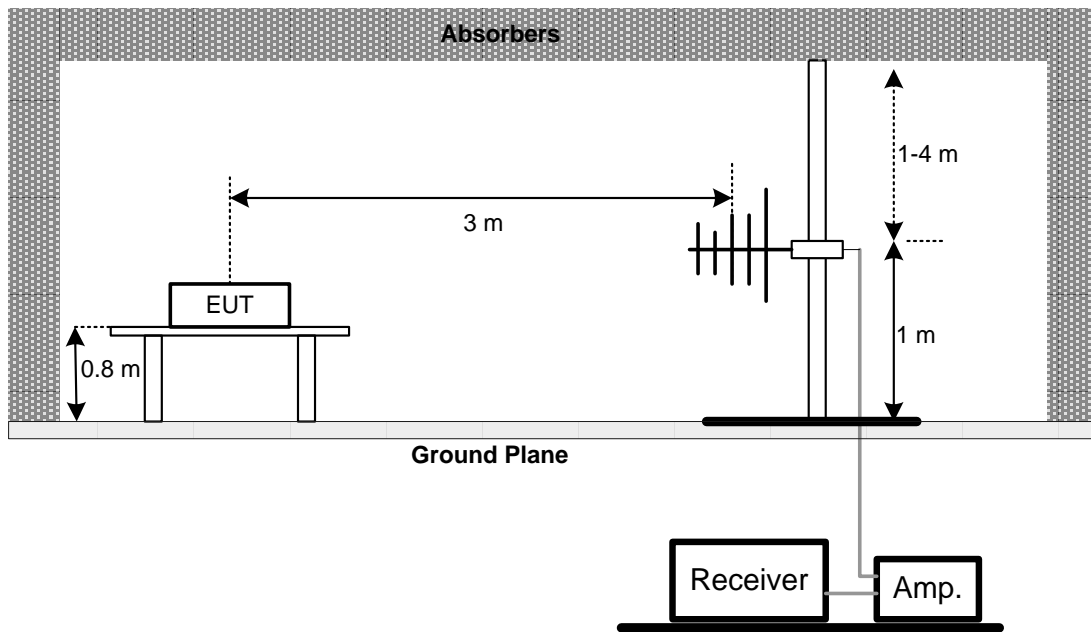

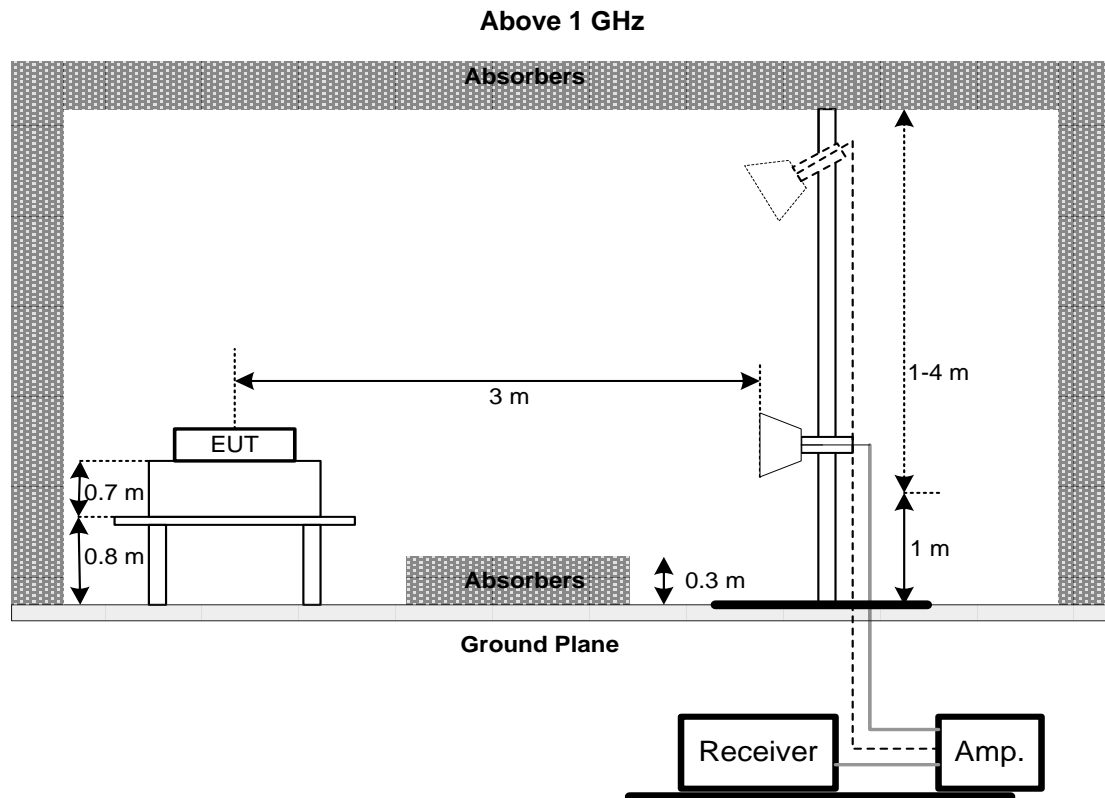

3.5 EUT OPERATING CONDITIONS

The EUT was programmed to be in continuously transmitting mode.

3.6 TEST RESULT – 9 KHZ TO 30 MHZ

Please refer to the APPENDIX A.

3.7 TEST RESULT – 30 MHZ TO 1 GHZ

Please refer to the APPENDIX B.

3.8 TEST RESULT – ABOVE 1 GHZ

Please refer to the APPENDIX C.

NOTE:

- (1) No limit: This is fundamental signal, the judgment is not applicable. For fundamental signal judgment was referred to Peak output test.

4 BANDWIDTH TEST

4.1 LIMIT

FCC Part15, Subpart E (15.407)		
Section	Test Item	Frequency Range (MHz)
15.407(a)	26 dB Bandwidth	5150-5250
		5250-5350
		5470-5725
	Minimum 500 kHz 6 dB Bandwidth	5725-5850

4.2 TEST PROCEDURE

- a. The EUT was directly connected to the spectrum analyzer and antenna output port as show in the block diagram below.
- b. Spectrum Setting:

Spectrum Parameter	Setting
Attenuation	Auto
Span Frequency	> 26 dB Bandwidth
RBW	300 kHz(Bandwidth 20 MHz) 1 MHz(Bandwidth 40 MHz and 80 MHz)
VBW	1 MHz(Bandwidth 20 MHz) 3 MHz(Bandwidth 40 MHz and 80 MHz)
Detector	Peak
Trace	Max Hold
Sweep Time	Auto

4.3 DEVIATION FROM TEST STANDARD

No deviation.

4.4 TEST SETUP

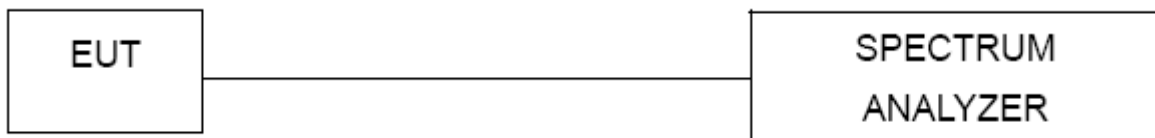

4.5 EUT OPERATING CONDITIONS

The EUT was programmed to be in continuously transmitting mode.

4.6 TEST RESULT

Please refer to the APPENDIX D.

5 OUTPUT POWER TEST

5.1 LIMIT

FCC Part15, Subpart E (15.407)			
Section	Test Item	Limit	Frequency Range (MHz)
15.407(a)	Maximum Output Power	Fixed:1 Watt (30 dBm) Mobile and portable: 250 mW (24 dBm)	5150-5250
		250 mW (24 dBm)	5250-5350
		1 Watt (30dBm)	5470-5725 5725-5850

Note: The maximum e.i.r.p at any elevation angle above 30 degrees as measured from the horizon must not exceed 125 mW(21 dBm).

5.2 TEST PROCEDURE

- a. The EUT was directly connected to the power meter and antenna output port as show in the block diagram below.
- b. Spectrum Setting:

Spectrum Parameter	Setting
Attenuation	Auto
Span Frequency	Encompass the entire emissions bandwidth (EBW) of the signal
RBW	= 1 MHz
VBW	≥ 3 MHz
Detector	RMS
Trace	Max Hold
Sweep Time	auto

- c. The maximum peak conducted output power was performed in accordance with method of FCC KDB 789033 D02 General UNII Test Procedures New Rules v02r01.

5.3 DEVIATION FROM TEST STANDARD

No deviation.

5.4 TEST SETUP



5.5 EUT OPERATING CONDITIONS

The EUT was programmed to be in continuously transmitting mode.

5.6 TEST RESULT

Please refer to the APPENDIX E.

6 POWER SPECTRAL DENSITY

6.1 LIMIT

FCC Part15, Subpart E (15.407)			
Section	Test Item	Limit	Frequency Range (MHz)
15.407(a)	Power Spectral Density	Other than Mobile and portable: 17 dBm/MHz Mobile and portable: 11 dBm/MHz	5150-5250
		11 dBm/MHz	5250-5350
			5470-5725
		30 dBm/500 kHz	5725-5850

6.2 TEST PROCEDURE

- a. The EUT was directly connected to the spectrum analyzer and antenna output port as show in the block diagram below.
- b. Spectrum Setting:

Spectrum Parameter	Setting
Attenuation	Auto
Span Frequency	Encompass the entire emissions bandwidth (EBW) of the signal
RBW	= 1 MHz
VBW	≥ 3 MHz
Detector	RMS
Trace	Max Hold
Sweep Time	Auto

6.3 DEVIATION FROM TEST STANDARD

No deviation.

6.4 TEST SETUP



6.5 EUT OPERATING CONDITIONS

The EUT was programmed to be in continuously transmitting mode.

6.6 TEST RESULT

Please refer to the APPENDIX F.

7 LIST OF MEASURING EQUIPMENTS

Radiated Emissions						
Item	Kind of Equipment	Manufacturer	Type No.	Serial No.	Calibrated Date	Calibrated Until
1	Preamplifier	EMCI	EMC001340	980555	2019/4/12	2020/4/11
2	Preamplifier	EMCI	EMC02325B	980217	2019/4/12	2020/4/11
3	Preamplifier	EMCI	EMC012645B	980267	2019/4/12	2020/4/11
4	Test Cable	EMCI	EMC104-SM-SM-800	150207	2019/4/12	2020/4/11
5	Test Cable	EMCI	EMC104-SM-SM-3000	151205	2019/4/12	2020/4/11
6	Test Cable	EMCI	EMC-SM-SM-7000	180408	2019/4/12	2020/4/11
7	MXE EMI Receiver	Agilent	N9038A	MY55420127	2019/3/26	2020/3/25
8	Signal Analyzer	Agilent	N9010A	MY56480554	2019/6/6	2020/6/5
9	Loop Ant	EMCO	EMCI-LPA600	274	2019/5/31	2020/5/30
10	Horn Ant	SCHWARZBECK	BBHA 9120D	9120D-1342	2019/6/10	2020/6/9
11	Trilog-Broadband Antenna	Schwarzbeck	VULB 9168	000992	2019/5/29	2020/5/28
12	5dB Attenuator	EMCI	EMCI-N-6-05	AT-N0508	2019/5/29	2020/5/28

Bandwidth						
Item	Kind of Equipment	Manufacturer	Type No.	Serial No.	Calibrated Date	Calibrated Until
1	Spectrum Analyzer	R&S	FSP40	100129	2019/5/23	2020/5/22

Output Power						
Item	Kind of Equipment	Manufacturer	Type No.	Serial No.	Calibrated Date	Calibrated Until
1	Power Meter	Anritsu	ML2487A	6K00004714	2019/6/20	2020/6/18
2	Power Sensor	Anritsu	MA2491A	1725282	2019/6/20	2020/6/18

Power Spectral Density						
Item	Kind of Equipment	Manufacturer	Type No.	Serial No.	Calibrated Date	Calibrated Until
1	Spectrum Analyzer	R&S	FSP40	100129	2019/5/23	2020/5/22

Remark: "N/A" denotes no model name, no serial no. or no calibration specified.
All calibration period of equipment list is one year.

8 EUT TEST PHOTO

Please refer to document Appendix No.: TP-1911T046-FCCP-2 (APPENDIX-TEST PHOTOS).

9 EUT PHOTOS

Please refer to document Appendix No.: EP-1911T046-1 (APPENDIX-EUT PHOTOS).

APPENDIX A RADIATED EMISSIONS - 9 KHZ TO 30 MHZ

Test Mode	UNII-3_TX a Mode 5745MHz	Tested Date	2019/12/6
Test Voltage	DC 48V	Azimuth Angle	90°

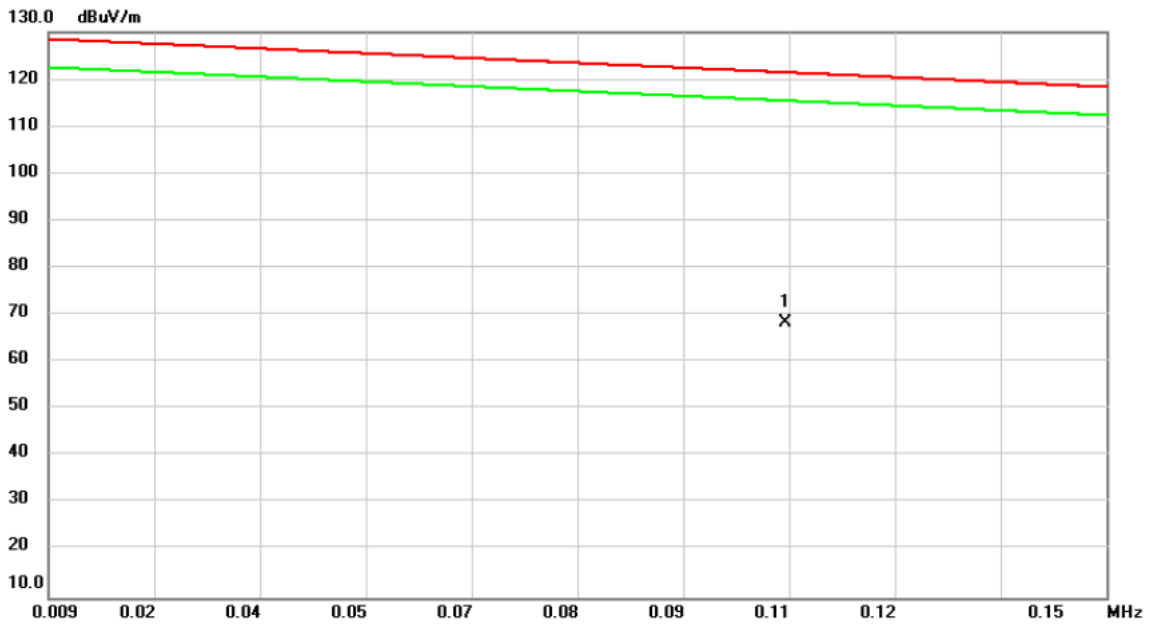

No.	Mk.	Freq.	Reading Level	Correct Factor	Measurement	Limit	Margin	Detector	Comment
		MHz	dBuV	dB	dBuV/m	dBuV/m	dB		
1	*	0.1073	52.83	15.62	68.45	121.42	-52.97	AVG	

REMARKS:

- (1) Measurement Value = Reading Level + Correct Factor.
- (2) Margin Level = Measurement Value - Limit Value.

Test Mode	UNII-3_TX a Mode 5745MHz	Tested Date	2019/12/6
Test Voltage	DC 48V	Azimuth Angle	90°

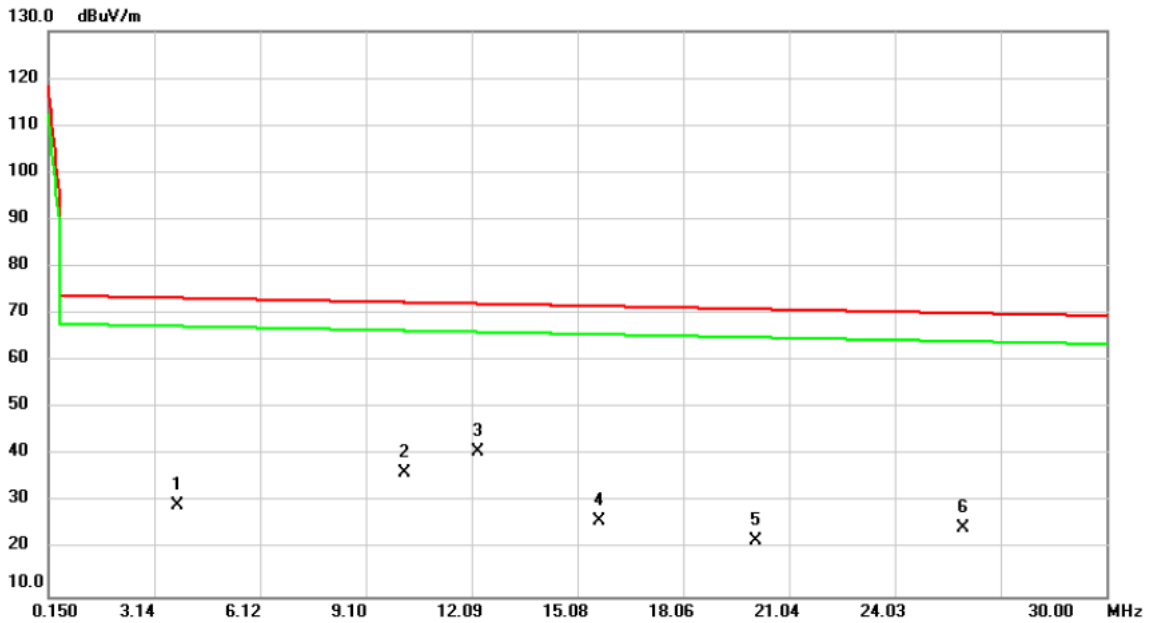

No. Mk.	Freq. MHz	Reading Level dBuV	Correct Factor dB	Measurement dBuV/m	Limit dBuV/m	Margin dB	Detector	Comment
1	3.7917	33.27	-3.77	29.50	73.32	-43.82	QP	
2	10.2094	41.10	-4.73	36.37	72.40	-36.03	QP	
3 *	12.2691	45.67	-4.82	40.85	72.10	-31.25	QP	
4	15.7020	31.37	-5.24	26.13	71.60	-45.47	QP	
5	20.1197	28.35	-6.54	21.81	70.97	-49.16	QP	
6	25.9703	33.33	-8.85	24.48	70.12	-45.64	QP	

REMARKS:

(1) Measurement Value = Reading Level + Correct Factor.

(2) Margin Level = Measurement Value - Limit Value.

Test Mode	UNII-3_TX a Mode 5745MHz	Tested Date	2019/12/6
Test Voltage	DC 48V	Azimuth Angle	0°

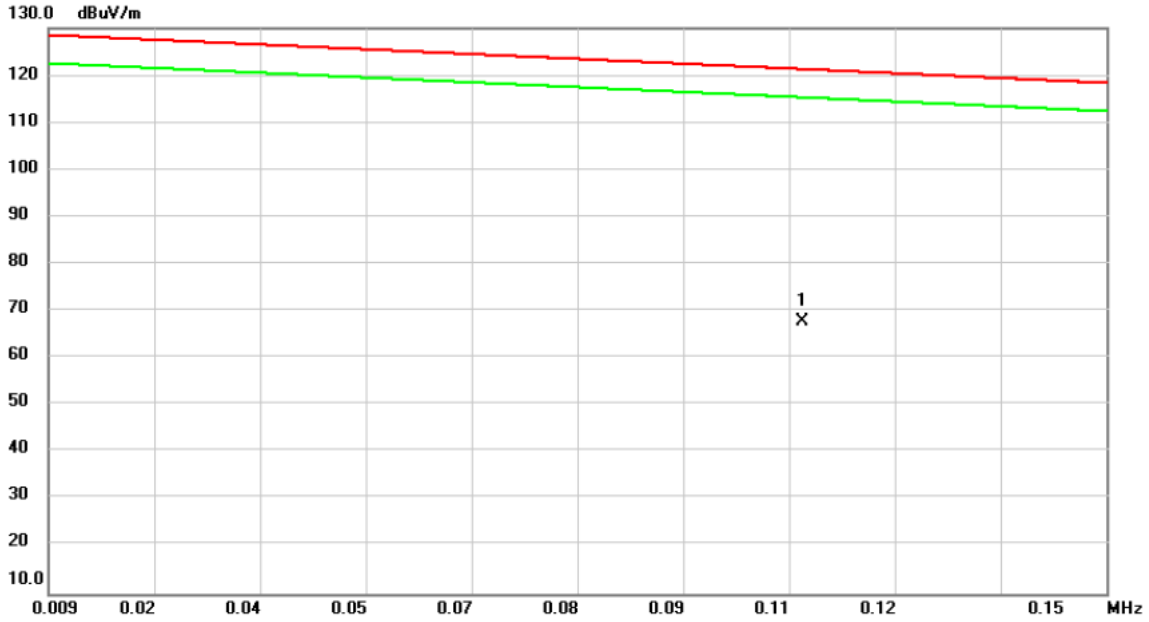

No.	Mk.	Freq.	Reading Level	Correct Factor	Measurement	Limit	Margin	Detector	Comment
		MHz	dBuV	dB	dBuV/m	dBuV/m	dB		
1	*	0.1095	52.32	15.49	67.81	121.26	-53.45	AVG	

REMARKS:

- (1) Measurement Value = Reading Level + Correct Factor.
- (2) Margin Level = Measurement Value - Limit Value.

Test Mode	UNII-3_TX a Mode 5745MHz	Tested Date	2019/12/6
Test Voltage	DC 48V	Azimuth Angle	0°

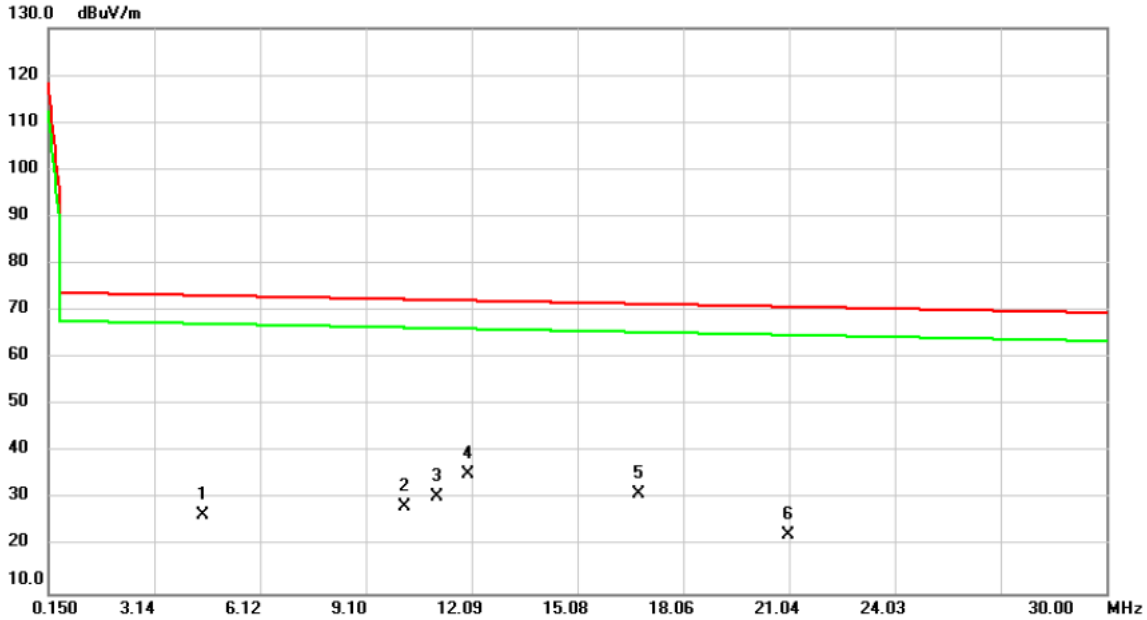

No. Mk.	Freq. MHz	Reading Level dBuV	Correct Factor dB	Measurement dBuV/m	Limit dBuV/m	Margin dB	Detector	Comment
1	4.5080	30.65	-3.86	26.79	73.22	-46.43	QP	
2	10.2094	33.21	-4.73	28.48	72.40	-43.92	QP	
3	11.1050	35.38	-4.81	30.57	72.27	-41.70	QP	
4 *	11.9706	40.16	-4.82	35.34	72.14	-36.80	QP	
5	16.8063	36.81	-5.73	31.08	71.44	-40.36	QP	
6	21.0151	29.10	-6.54	22.56	70.84	-48.28	QP	

REMARKS:

- (1) Measurement Value = Reading Level + Correct Factor.
- (2) Margin Level = Measurement Value - Limit Value.

APPENDIX B RADIATED EMISSIONS - 30 MHZ TO 1 GHZ

Test Mode	UNII-3_TX a Mode 5745MHz	Tested Date	2019/12/6
Test Voltage	DC 48V	Polarization	Vertical

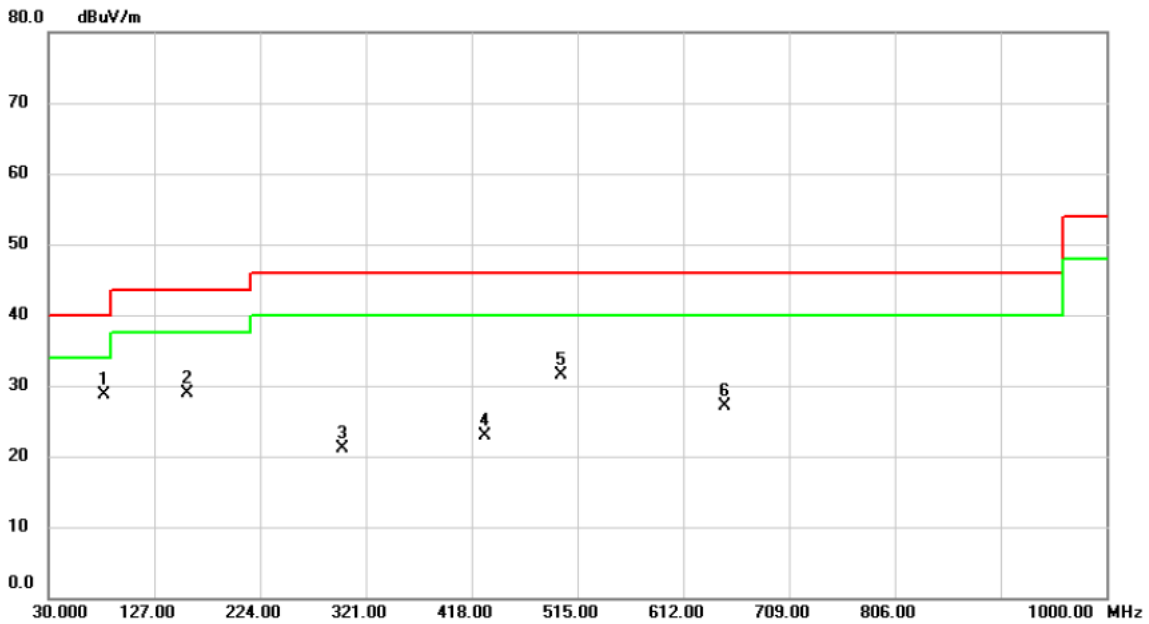

No.	Mk.	Freq. MHz	Reading Level dBuV	Correct Factor dB	Measure- ment dBuV/m	Limit dBuV/m	Margin dB	Detector	Comment
1	*	81.4100	44.73	-16.02	28.71	40.00	-11.29	peak	
2		157.0700	40.18	-11.35	28.83	43.50	-14.67	peak	
3		299.6600	31.49	-10.33	21.16	46.00	-24.84	peak	
4		429.6400	30.30	-7.46	22.84	46.00	-23.16	peak	
5		500.4500	37.56	-6.12	31.44	46.00	-14.56	peak	
6		649.8300	30.00	-2.91	27.09	46.00	-18.91	peak	

REMARKS:

- (1) Measurement Value = Reading Level + Correct Factor.
- (2) Margin Level = Measurement Value - Limit Value.

Test Mode	UNII-3_TX a Mode 5745MHz	Tested Date	2019/12/6
Test Voltage	DC 48V	Polarization	Horizontal

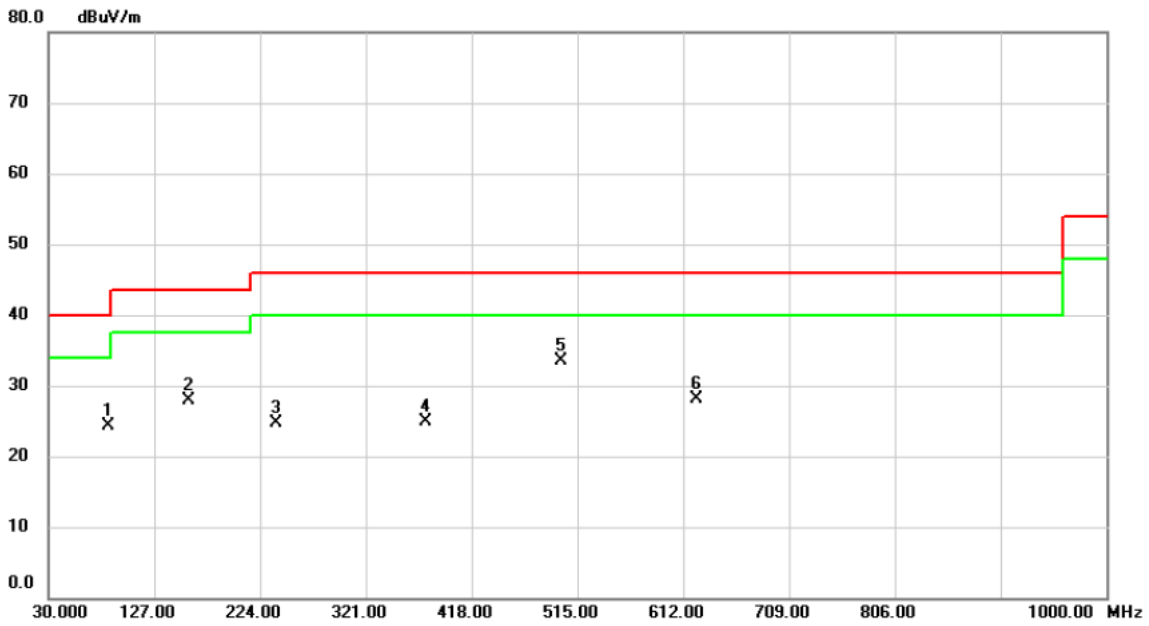

No.	Mk.	Freq. MHz	Reading Level dBuV	Correct Factor dB	Measure- ment dBuV/m	Limit dBuV/m	Margin dB	Detector	Comment
1		85.2900	40.87	-16.66	24.21	40.00	-15.79	peak	
2		158.0400	39.13	-11.31	27.82	43.50	-15.68	peak	
3		238.5500	38.10	-13.36	24.74	46.00	-21.26	peak	
4		375.3200	33.92	-9.05	24.87	46.00	-21.13	peak	
5	*	500.4500	39.58	-6.12	33.46	46.00	-12.54	peak	
6		624.6100	31.74	-3.54	28.20	46.00	-17.80	peak	

REMARKS:

- (1) Measurement Value = Reading Level + Correct Factor.
- (2) Margin Level = Measurement Value - Limit Value.

APPENDIX C RADIATED EMISSIONS - ABOVE 1 GHZ

Test Mode	UnII-1/ TX a Mode 5180MHz	Tested Date	2019/12/4
Test Voltage	DC 48V	Polarization	Vertical

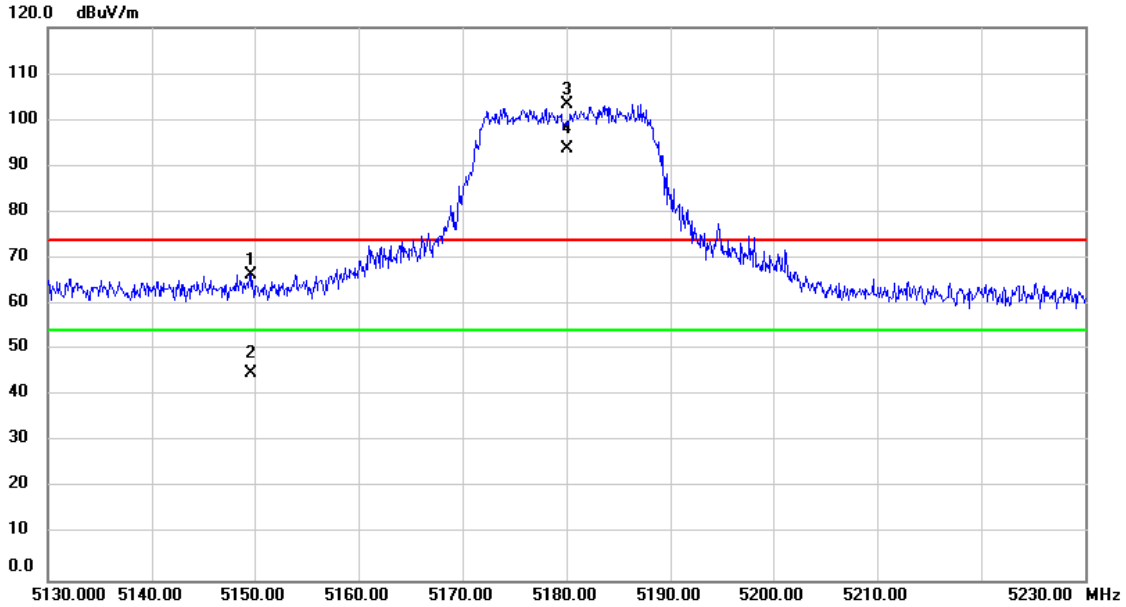

No.	Mk.	Freq. MHz	Reading Level dBuV	Correct Factor dB	Measure- ment dBuV/m	Limit dBuV/m	Margin dB	Detector	Comment
1		5149.600	28.58	37.80	66.38	74.00	-7.62	peak	
2		5149.600	6.95	37.80	44.75	54.00	-9.25	AVG	
3	X	5180.000	65.39	37.83	103.22	74.00	29.22	peak	No Limit
4	*	5180.000	55.78	37.83	93.61	54.00	39.61	AVG	No Limit

REMARKS:

- (1) Measurement Value = Reading Level + Correct Factor.
- (2) Margin Level = Measurement Value - Limit Value.

Test Mode	UnII-1/ TX a Mode 5240MHz	Tested Date	2019/12/4
Test Voltage	DC 48V	Polarization	Vertical

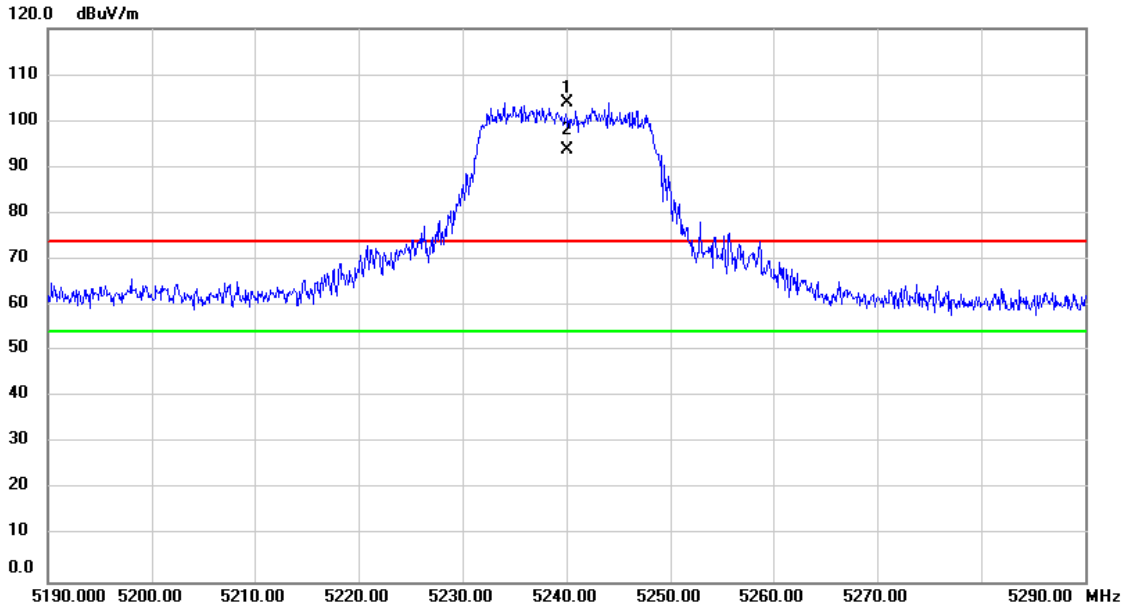

No.	Mk.	Freq. MHz	Reading Level dBuV	Correct Factor dB	Measure- ment dBuV/m	Limit dBuV/m	Margin dB	Detector	Comment
1	X	5240.000	65.95	37.90	103.85	74.00	29.85	peak	No Limit
2	*	5240.000	55.86	37.90	93.76	54.00	39.76	AVG	No Limit

REMARKS:

- (1) Measurement Value = Reading Level + Correct Factor.
- (2) Margin Level = Measurement Value - Limit Value.

Test Mode	UnII-3/ TX a Mode 5745MHz	Tested Date	2019/12/4
Test Voltage	DC 48V	Polarization	Vertical

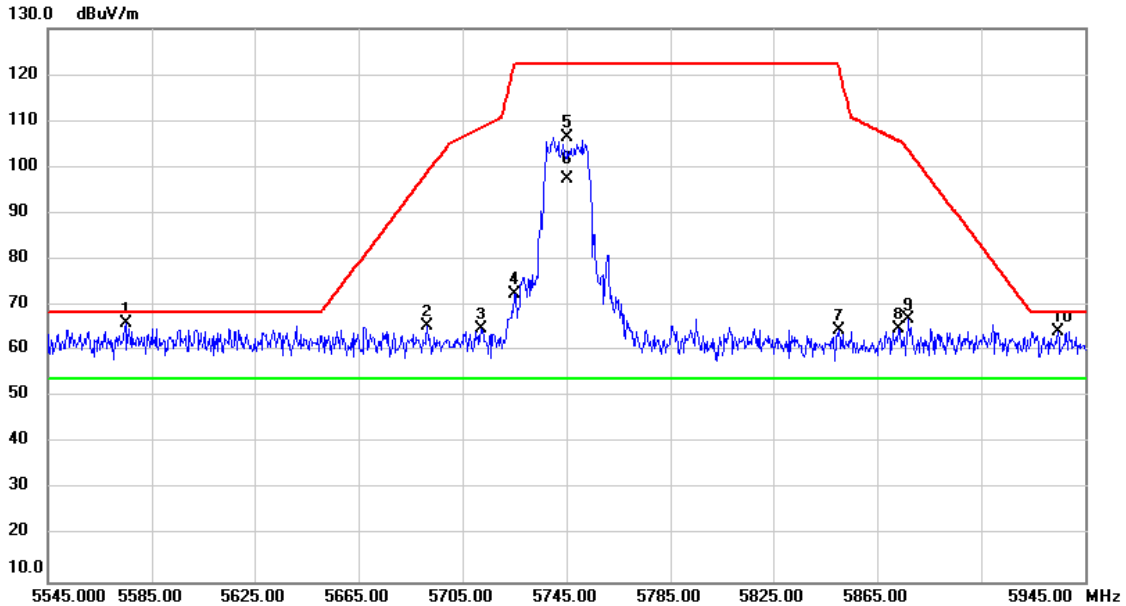

No.	Mk.	Freq. MHz	Reading Level dBuV	Correct Factor dB	Measure- ment dBuV/m	Limit dBuV/m	Margin dB	Detector	Comment
1		5575.000	27.61	38.26	65.87	68.20	-2.33	peak	
2		5691.400	26.90	38.35	65.25	98.84	-33.59	peak	
3		5712.200	26.43	38.37	64.80	108.62	-43.82	peak	
4		5725.000	34.30	38.38	72.68	122.20	-49.52	peak	
5		5745.000	68.06	38.39	106.45	122.20	-15.75	peak	No Limit
6	*	5745.000	59.09	38.39	97.48	54.00	43.48	AVG	No Limit
7		5850.200	26.03	38.47	64.50	121.74	-57.24	peak	
8		5873.000	26.29	38.48	64.77	105.76	-40.99	peak	
9		5877.000	28.25	38.49	66.74	103.72	-36.98	peak	
10		5934.600	25.62	38.53	64.15	68.20	-4.05	peak	

REMARKS:

- (1) Measurement Value = Reading Level + Correct Factor.
- (2) Margin Level = Measurement Value - Limit Value.

Test Mode	UnII-3/ TX a Mode 5825MHz	Tested Date	2019/12/4
Test Voltage	DC 48V	Polarization	Vertical

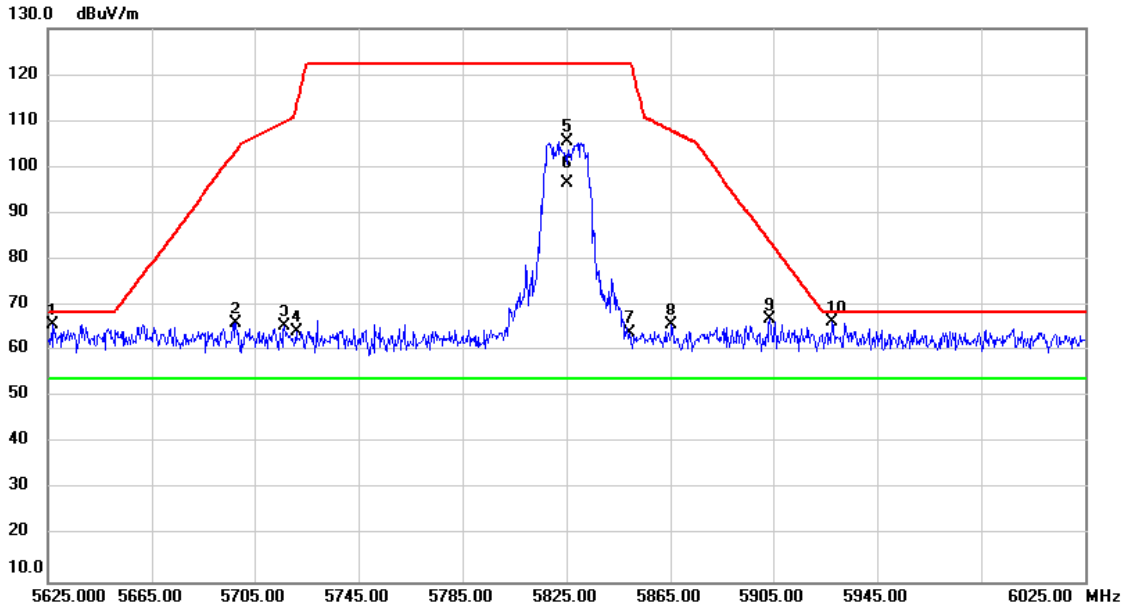

No.	Mk.	Freq. MHz	Reading Level dBuV	Correct Factor dB	Measure- ment dBuV/m	Limit dBuV/m	Margin dB	Detector	Comment
1		5627.000	27.39	38.31	65.70	68.20	-2.50	peak	
2		5697.800	27.68	38.36	66.04	103.57	-37.53	peak	
3		5716.600	26.85	38.37	65.22	109.85	-44.63	peak	
4		5721.000	25.77	38.37	64.14	113.08	-48.94	peak	
5		5825.000	66.97	38.46	105.43	122.20	-16.77	peak	No Limit
6	*	5825.000	58.08	38.46	96.54	54.00	42.54	AVG	No Limit
7		5849.400	25.43	38.47	63.90	122.20	-58.30	peak	
8		5865.400	27.04	38.48	65.52	107.89	-42.37	peak	
9		5903.800	28.35	38.51	66.86	83.89	-17.03	peak	
10		5927.800	27.70	38.53	66.23	68.20	-1.97	peak	

REMARKS:

- (1) Measurement Value = Reading Level + Correct Factor.
- (2) Margin Level = Measurement Value - Limit Value.

Test Mode	UnII-1/TX n (HT20) Mode 5180MHz	Tested Date	2019/12/4
Test Voltage	DC 48V	Polarization	Vertical

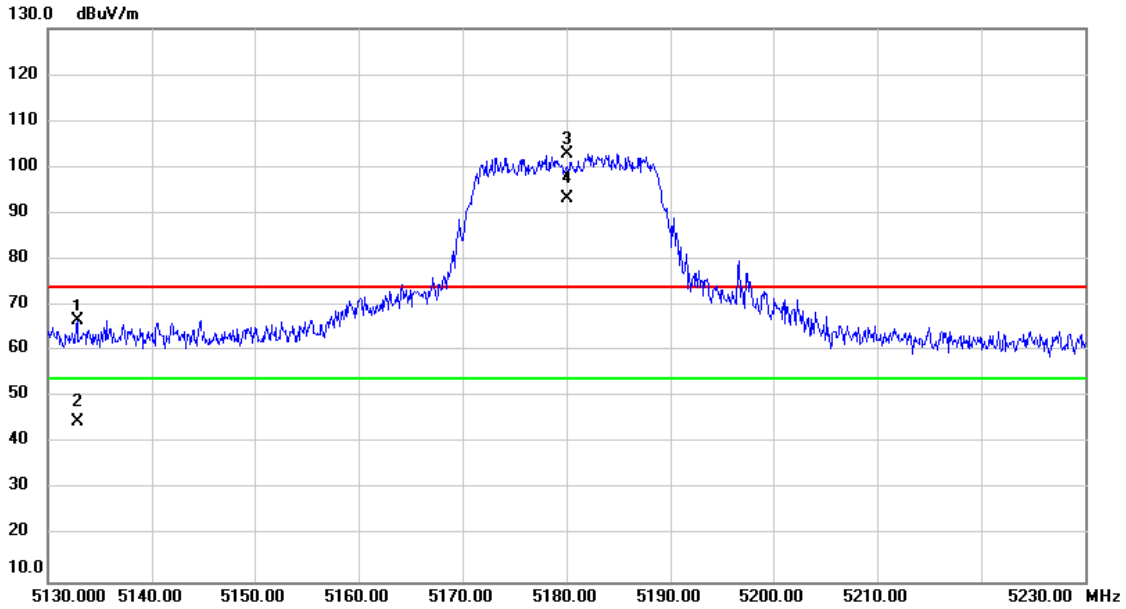

No.	Mk.	Freq. MHz	Reading Level dBuV	Correct Factor dB	Measure- ment dBuV/m	Limit dBuV/m	Margin dB	Detector	Comment
1		5132.800	28.85	37.78	66.63	74.00	-7.37	peak	
2		5132.800	7.02	37.78	44.80	54.00	-9.20	AVG	
3	X	5180.000	65.03	37.83	102.86	74.00	28.86	peak	No Limit
4	*	5180.000	55.42	37.83	93.25	54.00	39.25	AVG	No Limit

REMARKS:

- (1) Measurement Value = Reading Level + Correct Factor.
- (2) Margin Level = Measurement Value - Limit Value.

Test Mode	UnII-1/TX n (HT20) Mode 5240MHz	Tested Date	2019/12/4
Test Voltage	DC 48V	Polarization	Vertical

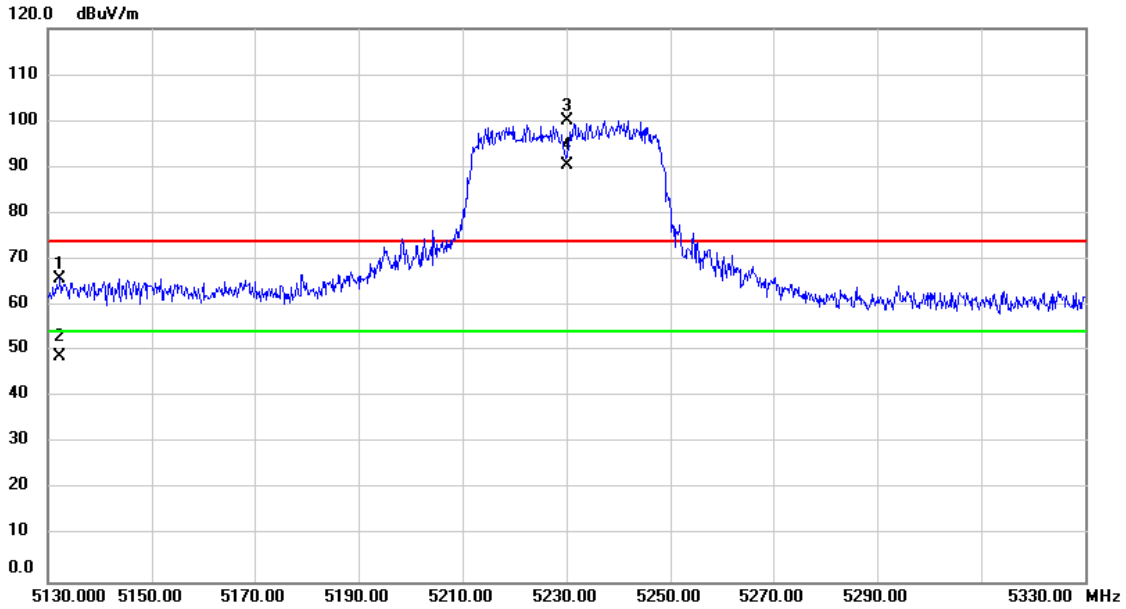

No.	Mk.	Freq. MHz	Reading Level dBuV	Correct Factor dB	Measure- ment dBuV/m	Limit dBuV/m	Margin dB	Detector	Comment
1		5132.400	28.22	37.78	66.00	74.00	-8.00	peak	
2		5132.400	11.05	37.78	48.83	54.00	-5.17	AVG	
3	X	5230.000	62.15	37.89	100.04	74.00	26.04	peak	No Limit
4	*	5230.000	52.44	37.89	90.33	54.00	36.33	AVG	No Limit

REMARKS:

- (1) Measurement Value = Reading Level + Correct Factor.
- (2) Margin Level = Measurement Value - Limit Value.

Test Mode	UnII-3/TX n (HT20) Mode 5745MHz	Tested Date	2019/12/4
Test Voltage	DC 48V	Polarization	Vertical

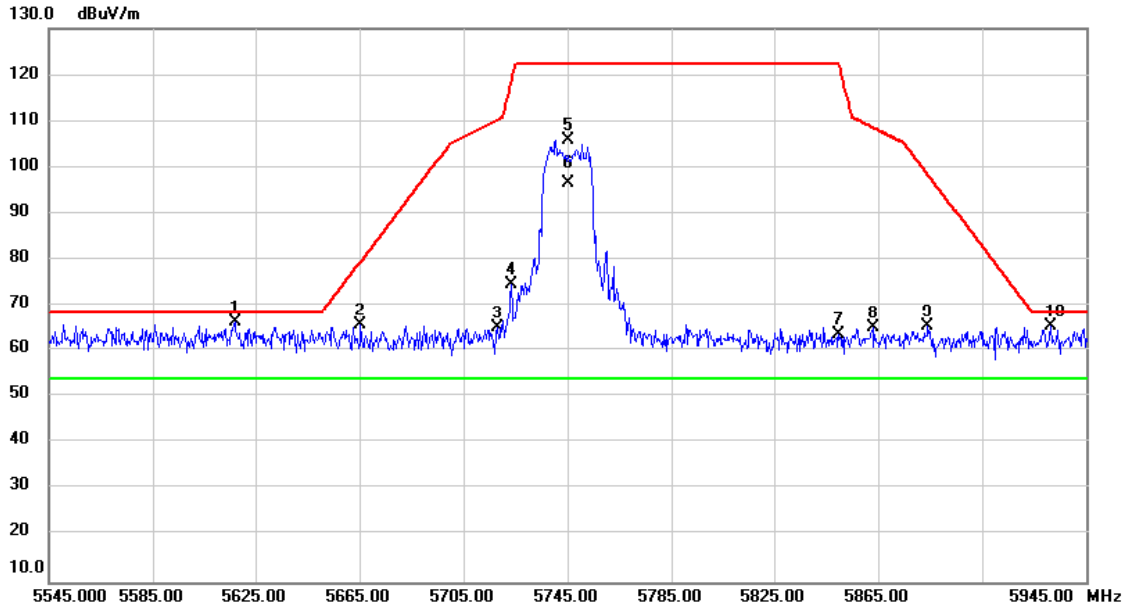

No.	Mk.	Freq. MHz	Reading Level dBuV	Correct Factor dB	Measure- ment dBuV/m	Limit dBuV/m	Margin dB	Detector	Comment
1		5617.000	27.87	38.29	66.16	68.20	-2.04	peak	
2		5665.400	27.24	38.33	65.57	79.60	-14.03	peak	
3		5718.200	26.71	38.38	65.09	110.30	-45.21	peak	
4		5723.400	36.32	38.37	74.69	118.55	-43.86	peak	
5		5745.000	67.36	38.39	105.75	122.20	-16.45	peak	No Limit
6	*	5745.000	58.09	38.39	96.48	54.00	42.48	AVG	No Limit
7		5849.800	25.12	38.47	63.59	122.20	-58.61	peak	
8		5863.000	26.63	38.48	65.11	108.56	-43.45	peak	
9		5884.200	26.95	38.50	65.45	98.39	-32.94	peak	
10		5931.400	26.79	38.53	65.32	68.20	-2.88	peak	

REMARKS:

- (1) Measurement Value = Reading Level + Correct Factor.
- (2) Margin Level = Measurement Value - Limit Value.

Test Mode	UnII-3/TX n (HT20)Mode 5825MHz	Tested Date	2019/12/4
Test Voltage	DC 48V	Polarization	Vertical

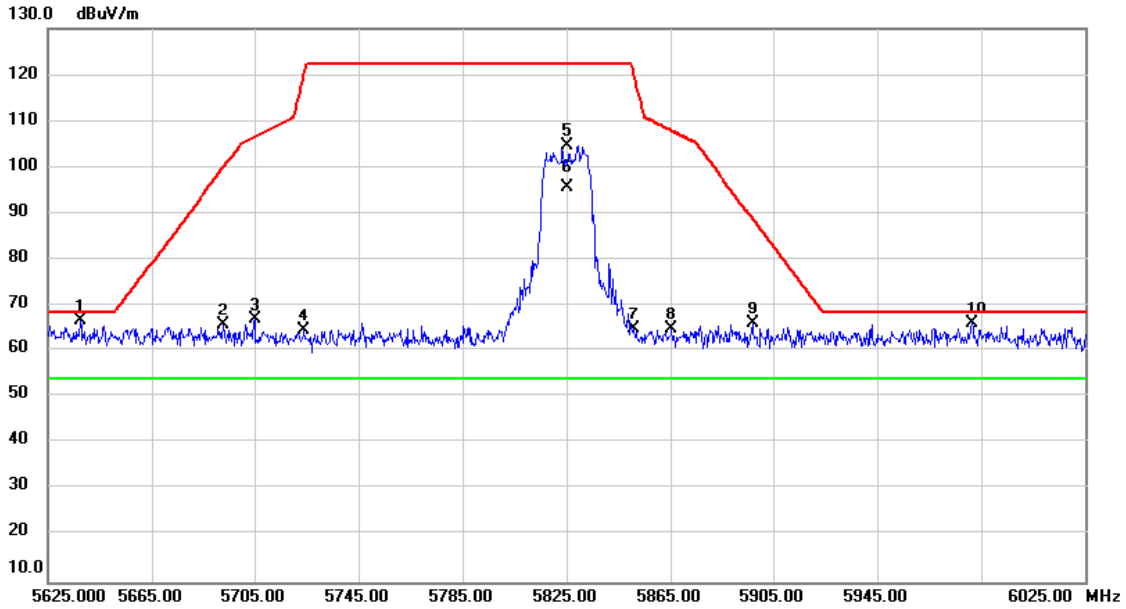

No.	Mk.	Freq. MHz	Reading Level dBuV	Correct Factor dB	Measure- ment dBuV/m	Limit dBuV/m	Margin dB	Detector	Comment
1		5637.400	28.13	38.31	66.44	68.20	-1.76	peak	
2		5693.000	27.28	38.35	65.63	100.02	-34.39	peak	
3		5705.000	28.47	38.36	66.83	106.60	-39.77	peak	
4		5724.200	25.98	38.37	64.35	120.38	-56.03	peak	
5		5825.000	66.23	38.46	104.69	122.20	-17.51	peak	No Limit
6	*	5825.000	57.22	38.46	95.68	54.00	41.68	AVG	No Limit
7		5851.000	26.34	38.47	64.81	119.92	-55.11	peak	
8		5865.400	26.27	38.48	64.75	107.89	-43.14	peak	
9		5897.000	27.44	38.51	65.95	88.92	-22.97	peak	
10		5981.400	27.54	38.56	66.10	68.20	-2.10	peak	

REMARKS:

- (1) Measurement Value = Reading Level + Correct Factor.
- (2) Margin Level = Measurement Value - Limit Value.

Test Mode	UnII-1/TX n (HT40) Mode 5190MHz	Tested Date	2019/12/4
Test Voltage	DC 48V	Polarization	Vertical

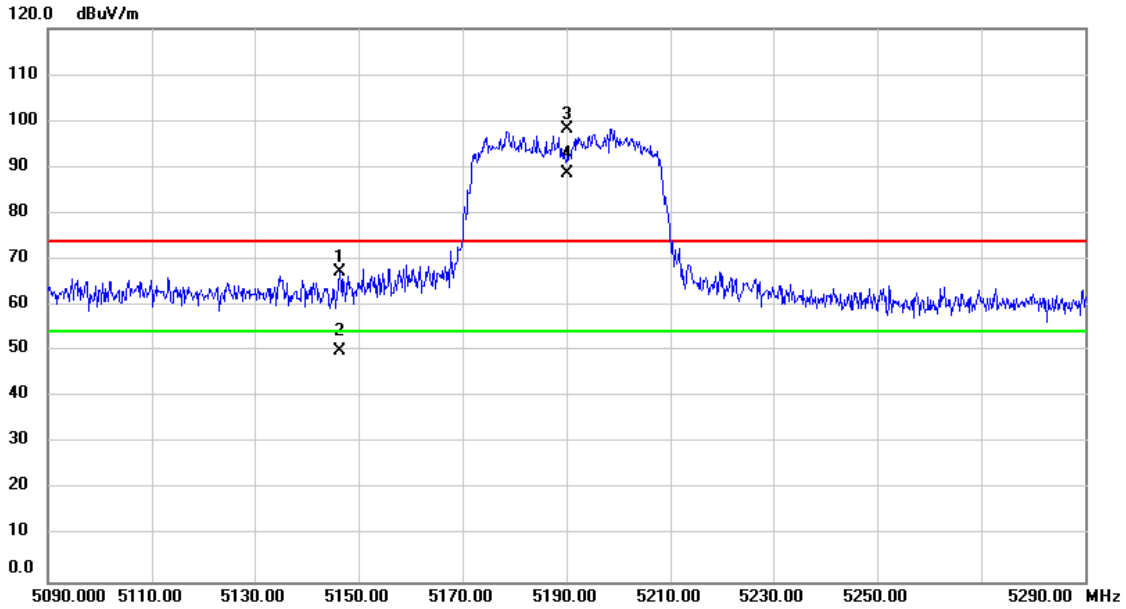

No.	Mk.	Freq. MHz	Reading Level dBuV	Correct Factor dB	Measure- ment dBuV/m	Limit dBuV/m	Margin dB	Detector	Comment
1		5146.400	29.46	37.79	67.25	74.00	-6.75	peak	
2		5146.400	12.09	37.79	49.88	54.00	-4.12	AVG	
3	X	5190.000	60.35	37.84	98.19	74.00	24.19	peak	No Limit
4	*	5190.000	50.73	37.84	88.57	54.00	34.57	AVG	No Limit

REMARKS:

- (1) Measurement Value = Reading Level + Correct Factor.
- (2) Margin Level = Measurement Value - Limit Value.

Test Mode	UnII-1/TX n (HT40) Mode 5230MHz	Tested Date	2019/12/4
Test Voltage	DC 48V	Polarization	Vertical

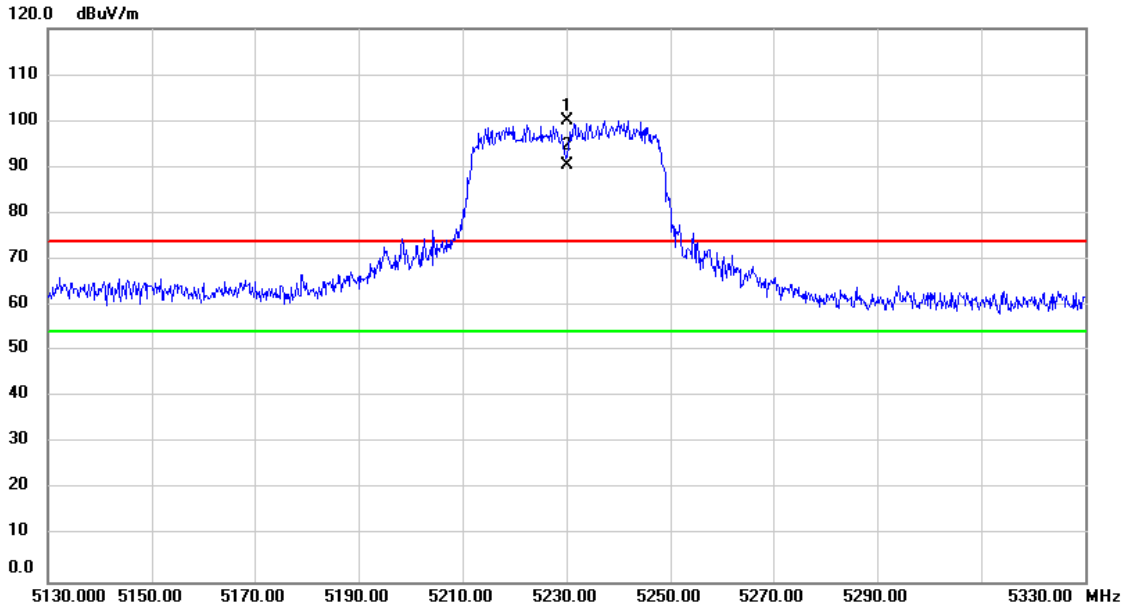

No.	Mk.	Freq. MHz	Reading Level dBuV	Correct Factor dB	Measure- ment dBuV/m	Limit dBuV/m	Margin dB	Detector	Comment
1	X	5230.000	62.15	37.89	100.04	74.00	26.04	peak	No Limit
2	*	5230.000	52.44	37.89	90.33	54.00	36.33	AVG	No Limit

REMARKS:

- (1) Measurement Value = Reading Level + Correct Factor.
- (2) Margin Level = Measurement Value - Limit Value.

Test Mode	UnII-3/TX n (HT40) Mode 5755MHz	Tested Date	2019/12/4
Test Voltage	DC 48V	Polarization	Vertical

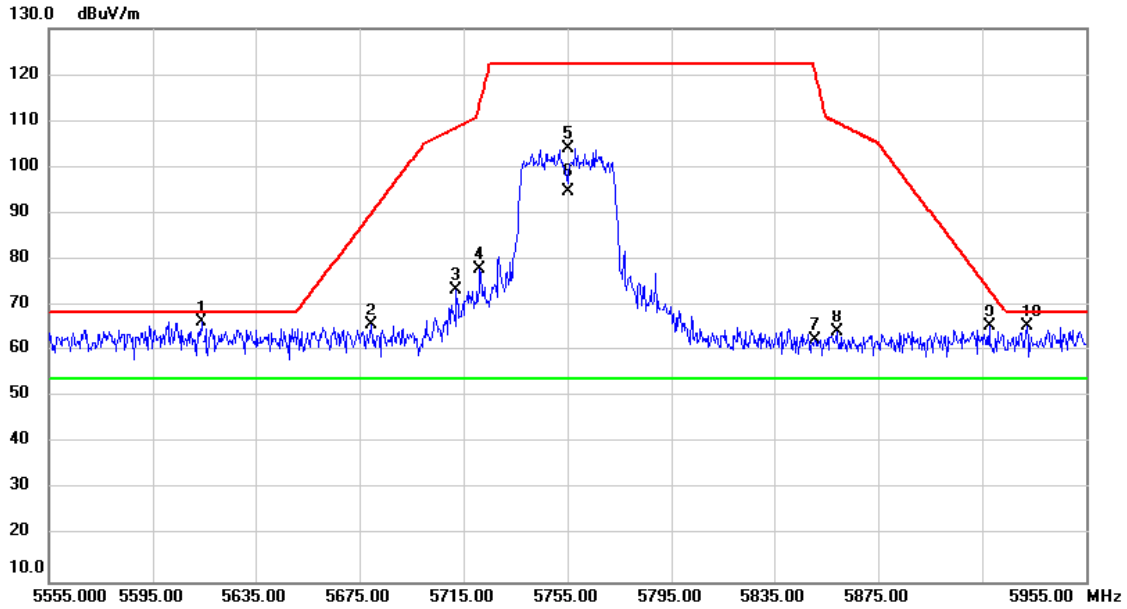

No.	Mk.	Freq. MHz	Reading Level dBuV	Correct Factor dB	Measure- ment dBuV/m	Limit dBuV/m	Margin dB	Detector	Comment
1		5614.200	27.92	38.29	66.21	68.20	-1.99	peak	
2		5679.400	27.34	38.34	65.68	89.96	-24.28	peak	
3		5712.200	35.02	38.37	73.39	108.62	-35.23	peak	
4		5721.400	39.44	38.37	77.81	113.99	-36.18	peak	
5		5755.000	65.51	38.40	103.91	122.20	-18.29	peak	No Limit
6	*	5755.000	56.47	38.40	94.87	54.00	40.87	AVG	No Limit
7		5850.600	23.91	38.47	62.38	120.83	-58.45	peak	
8		5859.000	25.58	38.47	64.05	109.68	-45.63	peak	
9		5917.800	26.81	38.51	65.32	73.53	-8.21	peak	
10		5932.200	26.81	38.53	65.34	68.20	-2.86	peak	

REMARKS:

- (1) Measurement Value = Reading Level + Correct Factor.
- (2) Margin Level = Measurement Value - Limit Value.

Test Mode	UnII-3/TX n (HT40) Mode 5795MHz	Tested Date	2019/12/4
Test Voltage	DC 48V	Polarization	Vertical

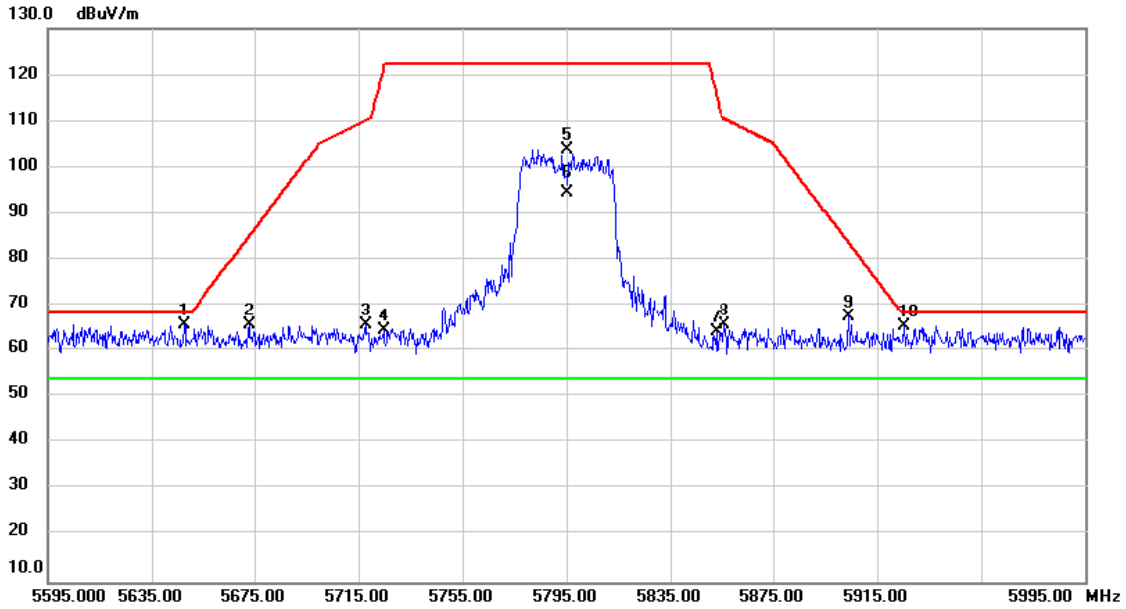

No.	Mk.	Freq. MHz	Reading Level dBuV	Correct Factor dB	Measure- ment dBuV/m	Limit dBuV/m	Margin dB	Detector	Comment
1		5647.400	27.42	38.32	65.74	68.20	-2.46	peak	
2		5673.000	27.27	38.34	65.61	85.22	-19.61	peak	
3		5717.800	27.16	38.37	65.53	110.18	-44.65	peak	
4		5724.600	26.13	38.37	64.50	121.29	-56.79	peak	
5		5795.000	65.42	38.43	103.85	122.20	-18.35	peak	No Limit
6	*	5795.000	55.93	38.43	94.36	54.00	40.36	AVG	No Limit
7		5852.600	25.81	38.47	64.28	116.27	-51.99	peak	
8		5855.800	27.32	38.48	65.80	110.58	-44.78	peak	
9		5904.200	29.09	38.51	67.60	83.59	-15.99	peak	
10		5925.400	26.78	38.53	65.31	68.20	-2.89	peak	

REMARKS:

- (1) Measurement Value = Reading Level + Correct Factor.
- (2) Margin Level = Measurement Value - Limit Value.

Test Mode	UnII-1/TX ac (VHT80) Mode 5210MHz	Tested Date	2019/12/4
Test Voltage	DC 48V	Polarization	Vertical

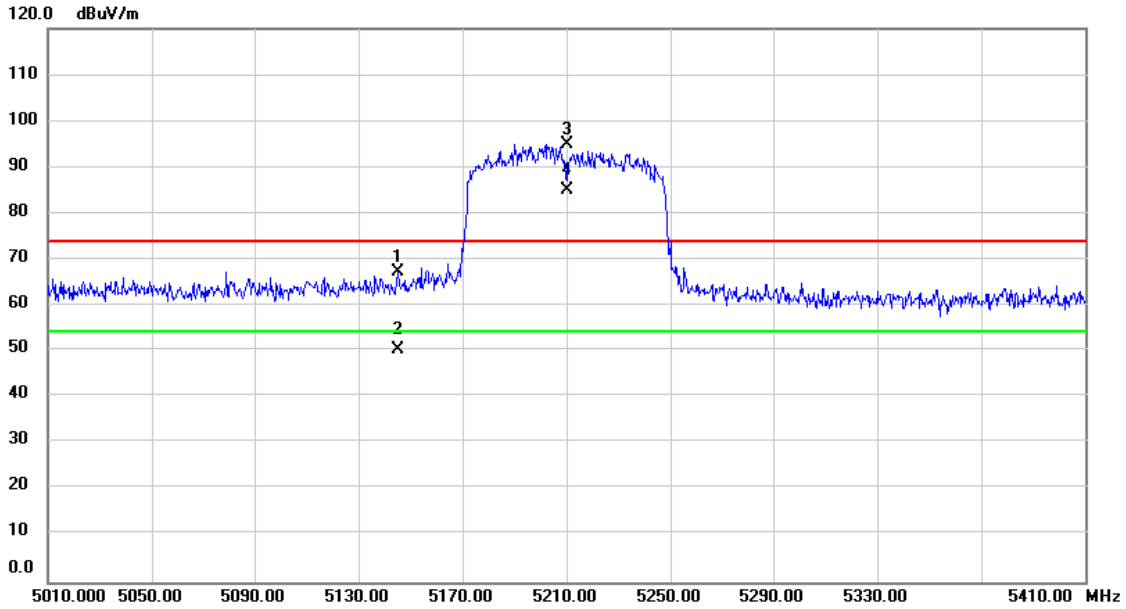

No.	Mk.	Freq. MHz	Reading Level dBuV	Correct Factor dB	Measure- ment dBuV/m	Limit dBuV/m	Margin dB	Detector	Comment
1		5145.200	29.42	37.79	67.21	74.00	-6.79	peak	
2		5145.200	12.47	37.79	50.26	54.00	-3.74	AVG	
3	X	5210.000	57.15	37.87	95.02	74.00	21.02	peak	No Limit
4	*	5210.000	47.31	37.87	85.18	54.00	31.18	AVG	No Limit

REMARKS:

- (1) Measurement Value = Reading Level + Correct Factor.
- (2) Margin Level = Measurement Value - Limit Value.

Test Mode	UnII-3/TX ac (VHT80) Mode 5775MHz	Tested Date	2019/12/4
Test Voltage	DC 48V	Polarization	Vertical

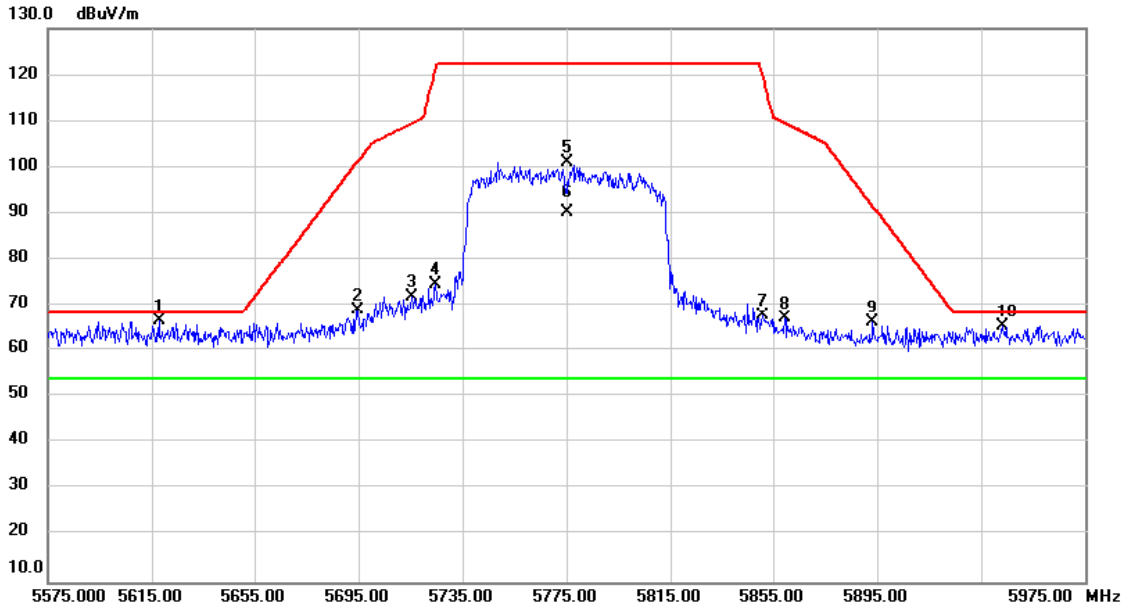

No.	Mk.	Freq. MHz	Reading Level dBuV	Correct Factor dB	Measure- ment dBuV/m	Limit dBuV/m	Margin dB	Detector	Comment
1		5617.800	28.18	38.29	66.47	68.20	-1.73	peak	
2		5694.600	30.56	38.35	68.91	101.20	-32.29	peak	
3		5715.400	33.69	38.37	72.06	109.51	-37.45	peak	
4		5724.600	36.42	38.37	74.79	121.29	-46.50	peak	
5		5775.000	62.66	38.41	101.07	122.20	-21.13	peak	No Limit
6	*	5775.000	51.87	38.41	90.28	54.00	36.28	AVG	No Limit
7		5851.000	29.33	38.47	67.80	119.92	-52.12	peak	
8		5859.400	28.74	38.47	67.21	109.57	-42.36	peak	
9		5893.400	27.83	38.50	66.33	91.58	-25.25	peak	
10		5943.000	26.78	38.54	65.32	68.20	-2.88	peak	

REMARKS:

- (1) Measurement Value = Reading Level + Correct Factor.
- (2) Margin Level = Measurement Value - Limit Value.

Test Mode	UNII-1_TX a Mode 5180MHz	Tested Date	2019/12/6
Test Voltage	DC 48V	Polarization	Vertical

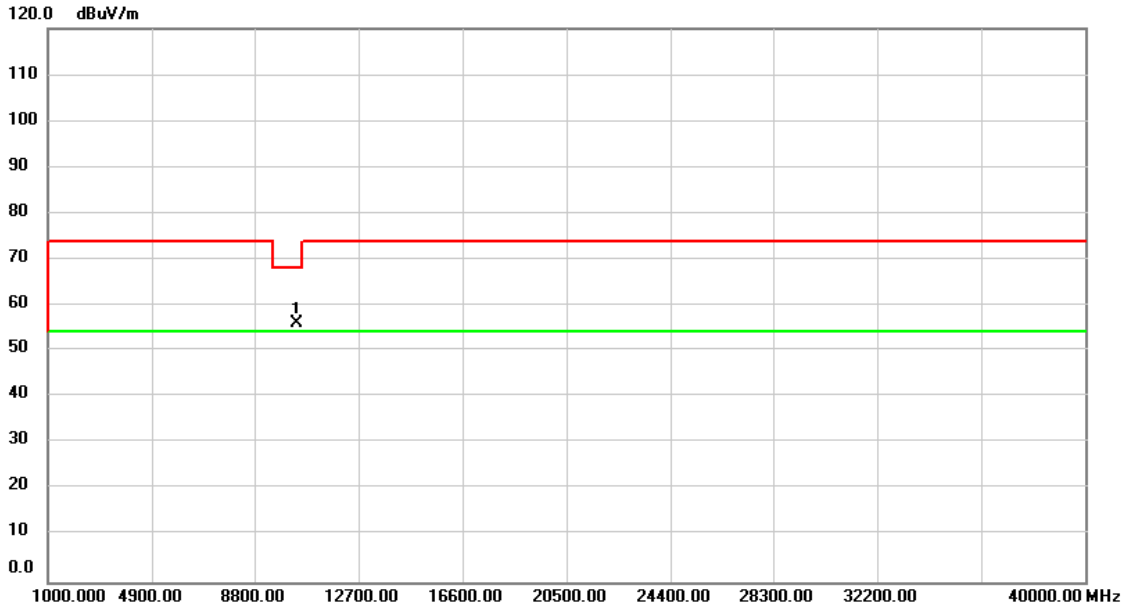

No.	Mk.	Freq. MHz	Reading Level dBuV	Correct Factor dB	Measure- ment dBuV/m	Limit dBuV/m	Margin dB	Detector	Comment
1	*	10360.00	53.01	2.83	55.84	68.20	-12.36	peak	

REMARKS:

- (1) Measurement Value = Reading Level + Correct Factor.
- (2) Margin Level = Measurement Value - Limit Value.

Test Mode	UNII-1_TX a Mode 5180MHz	Tested Date	2019/12/6
Test Voltage	DC 48V	Polarization	Horizontal

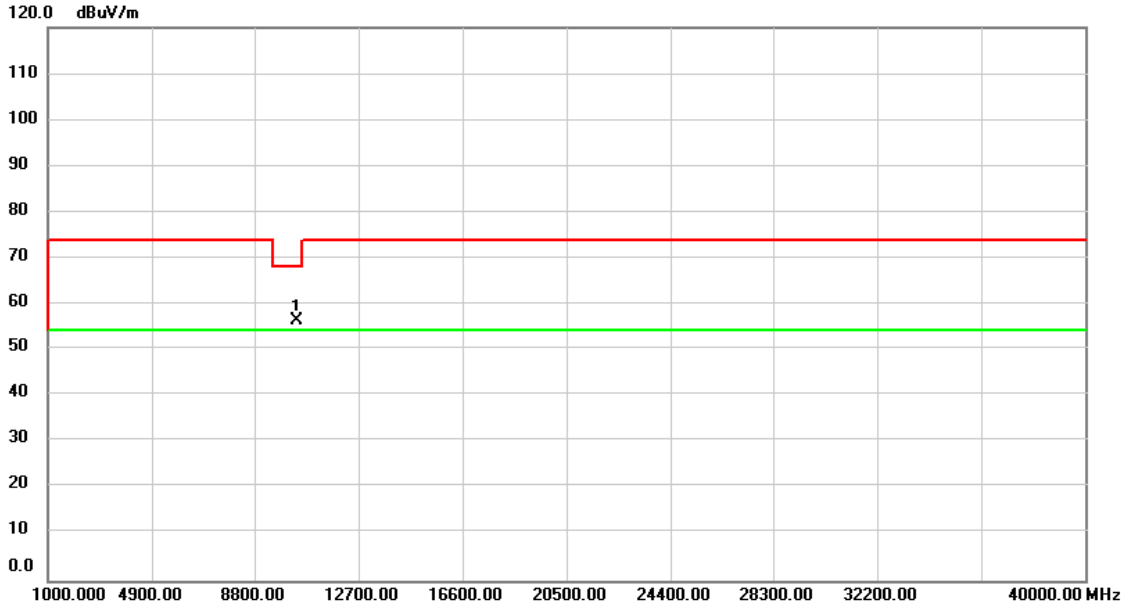

No.	Mk.	Freq.	Reading Level	Correct Factor	Measurement	Limit	Margin	Detector	Comment
		MHz	dBuV	dB	dBuV/m	dBuV/m	dB		
1	*	10360.00	53.50	2.83	56.33	68.20	-11.87	peak	

REMARKS:

- (1) Measurement Value = Reading Level + Correct Factor.
- (2) Margin Level = Measurement Value - Limit Value.

Test Mode	UNII-1_TX a Mode 5200MHz	Tested Date	2019/12/6
Test Voltage	DC 48V	Polarization	Vertical

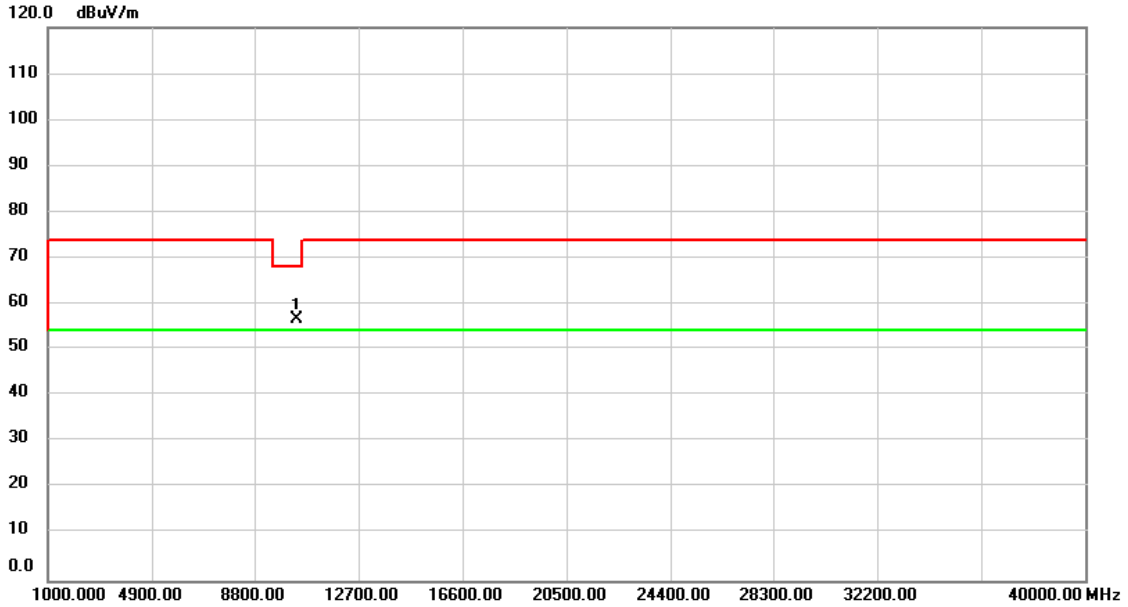

No.	Mk.	Freq.	Reading Level	Correct Factor	Measurement	Limit	Margin	Detector	Comment
		MHz	dBuV	dB	dBuV/m	dBuV/m	dB		
1	*	10400.00	53.76	2.89	56.65	68.20	-11.55	peak	

REMARKS:

- (1) Measurement Value = Reading Level + Correct Factor.
- (2) Margin Level = Measurement Value - Limit Value.

Test Mode	UNII-1_TX a Mode 5200MHz	Tested Date	2019/12/6
Test Voltage	DC 48V	Polarization	Horizontal

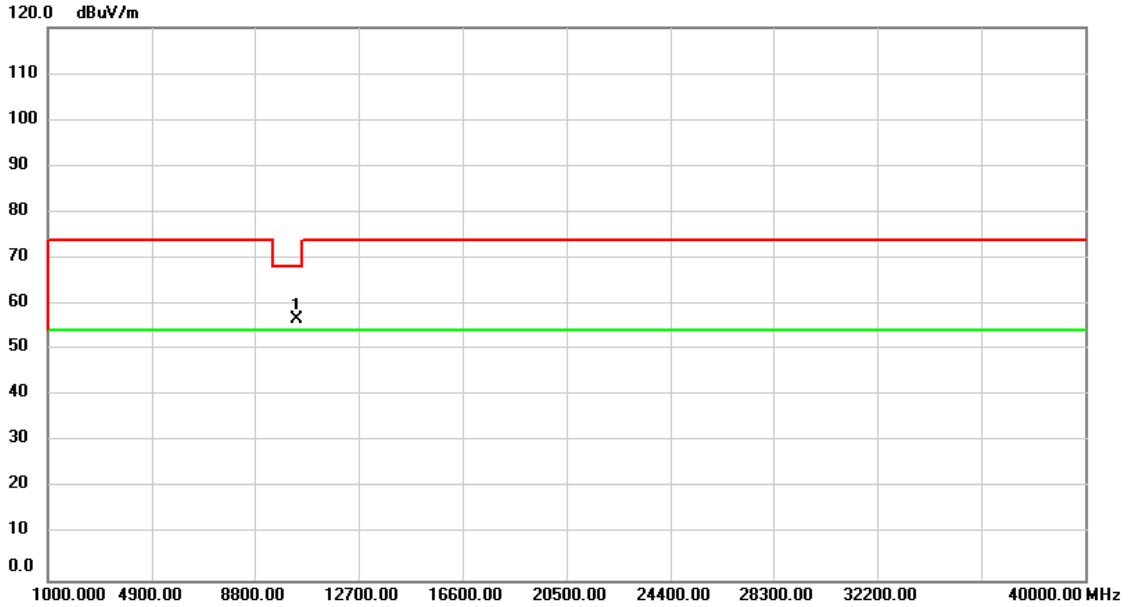

No.	Mk.	Freq.	Reading Level	Correct Factor	Measurement	Limit	Margin	Detector	Comment
		MHz	dBuV	dB	dBuV/m	dBuV/m	dB		
1	*	10400.00	53.72	2.89	56.61	68.20	-11.59	peak	

REMARKS:

- (1) Measurement Value = Reading Level + Correct Factor.
- (2) Margin Level = Measurement Value - Limit Value.

Test Mode	UNII-1_TX a Mode 5240MHz	Tested Date	2019/12/6
Test Voltage	DC 48V	Polarization	Vertical

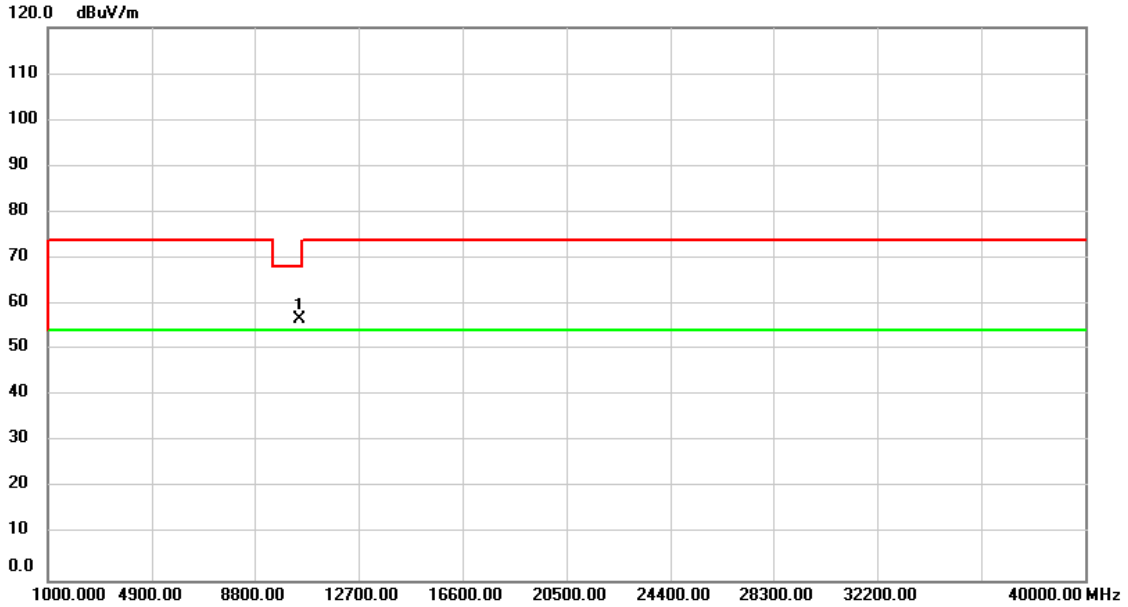

No.	Mk.	Freq.	Reading Level	Correct Factor	Measurement	Limit	Margin	Detector	Comment
		MHz	dBuV	dB	dBuV/m	dBuV/m	dB		
1	*	10480.00	53.53	3.00	56.53	68.20	-11.67	peak	

REMARKS:

- (1) Measurement Value = Reading Level + Correct Factor.
- (2) Margin Level = Measurement Value - Limit Value.

Test Mode	UNII-1_TX a Mode 5240MHz	Tested Date	2019/12/6
Test Voltage	DC 48V	Polarization	Horizontal

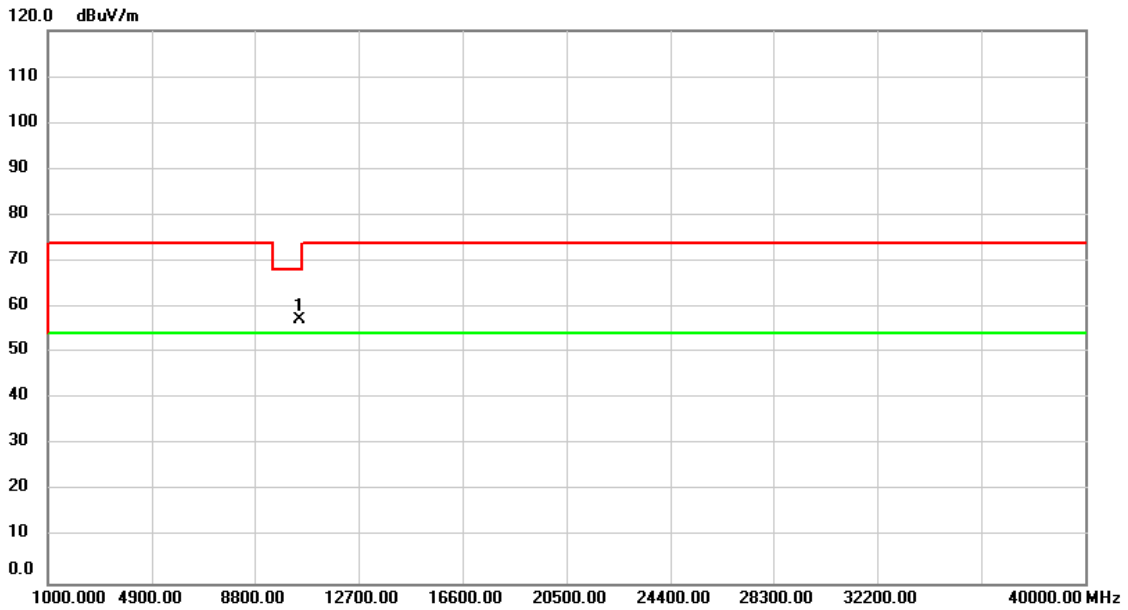

No.	Mk.	Freq.	Reading Level	Correct Factor	Measurement	Limit	Margin	Detector	Comment
		MHz	dBuV	dB	dBuV/m	dBuV/m	dB		
1	*	10480.00	54.17	3.00	57.17	68.20	-11.03	peak	

REMARKS:

- (1) Measurement Value = Reading Level + Correct Factor.
- (2) Margin Level = Measurement Value - Limit Value.

Test Mode	UNII-1_TX n (HT20) Mode 5180MHz	Tested Date	2019/12/6
Test Voltage	DC 48V	Polarization	Vertical

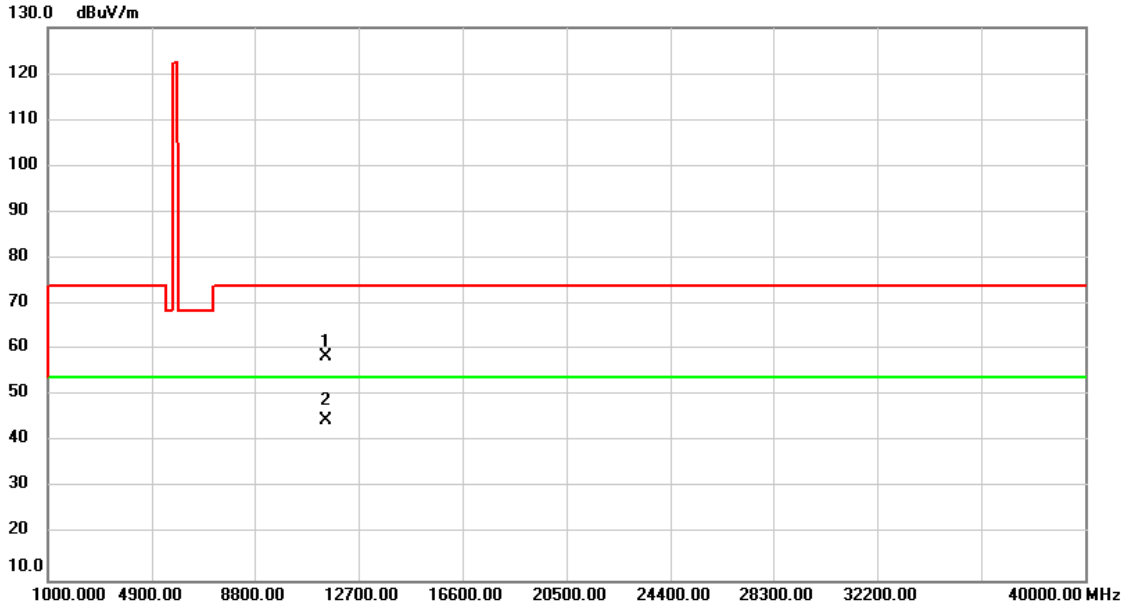

No.	Mk.	Freq. MHz	Reading Level dBuV	Correct Factor dB	Measure- ment dBuV/m	Limit dBuV/m	Margin dB	Detector	Comment
1		11490.00	54.42	3.89	58.31	74.00	-15.69	peak	
2	*	11490.00	40.74	3.89	44.63	54.00	-9.37	AVG	

REMARKS:

- (1) Measurement Value = Reading Level + Correct Factor.
- (2) Margin Level = Measurement Value - Limit Value.

Test Mode	UNII-1_TX n (HT20) Mode 5180MHz	Tested Date	2019/12/6
Test Voltage	DC 48V	Polarization	Horizontal

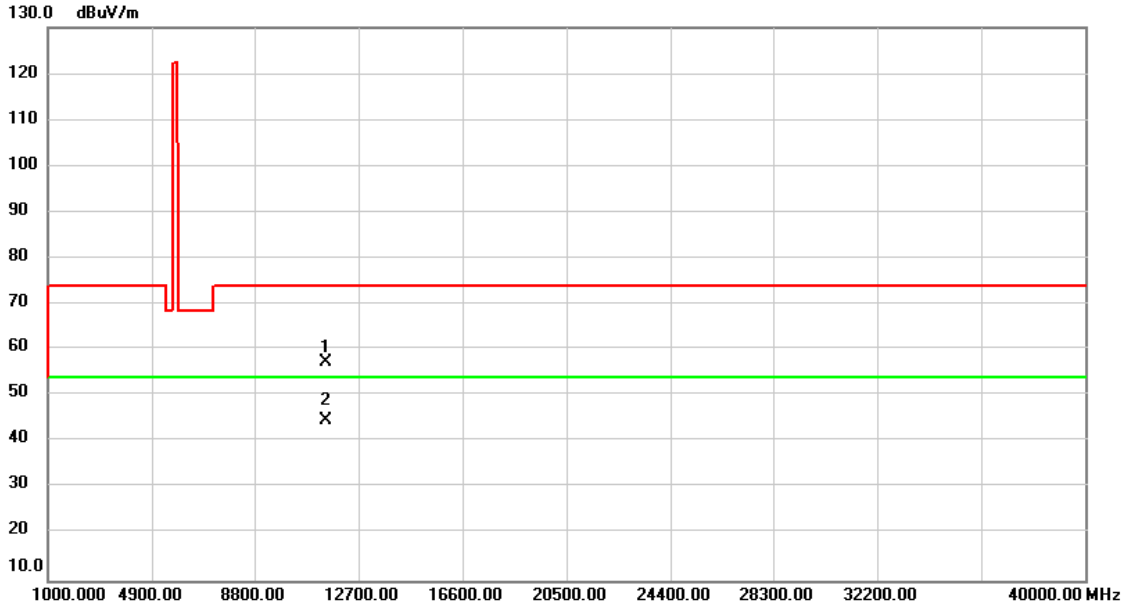

No.	Mk.	Freq. MHz	Reading Level dBuV	Correct Factor dB	Measure- ment dBuV/m	Limit dBuV/m	Margin dB	Detector	Comment
1		11490.00	53.49	3.89	57.38	74.00	-16.62	peak	
2	*	11490.00	40.87	3.89	44.76	54.00	-9.24	AVG	

REMARKS:

- (1) Measurement Value = Reading Level + Correct Factor.
- (2) Margin Level = Measurement Value - Limit Value.

Test Mode	UNII-1_TX n (HT20) Mode 5200MHz	Tested Date	2019/12/6
Test Voltage	DC 48V	Polarization	Vertical

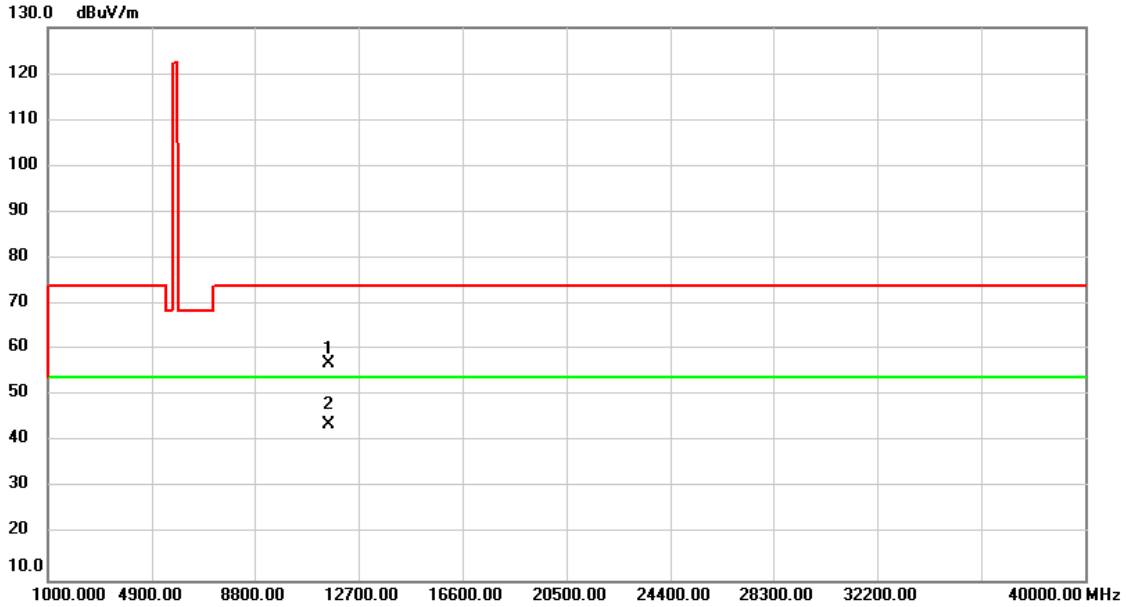

No.	Mk.	Freq. MHz	Reading Level dBuV	Correct Factor dB	Measure- ment dBuV/m	Limit dBuV/m	Margin dB	Detector	Comment
1		11570.00	53.39	3.57	56.96	74.00	-17.04	peak	
2	*	11570.00	40.33	3.57	43.90	54.00	-10.10	AVG	

REMARKS:

- (1) Measurement Value = Reading Level + Correct Factor.
- (2) Margin Level = Measurement Value - Limit Value.

Test Mode	UNII-1_TX n (HT20) Mode 5200MHz	Tested Date	2019/12/6
Test Voltage	DC 48V	Polarization	Horizontal

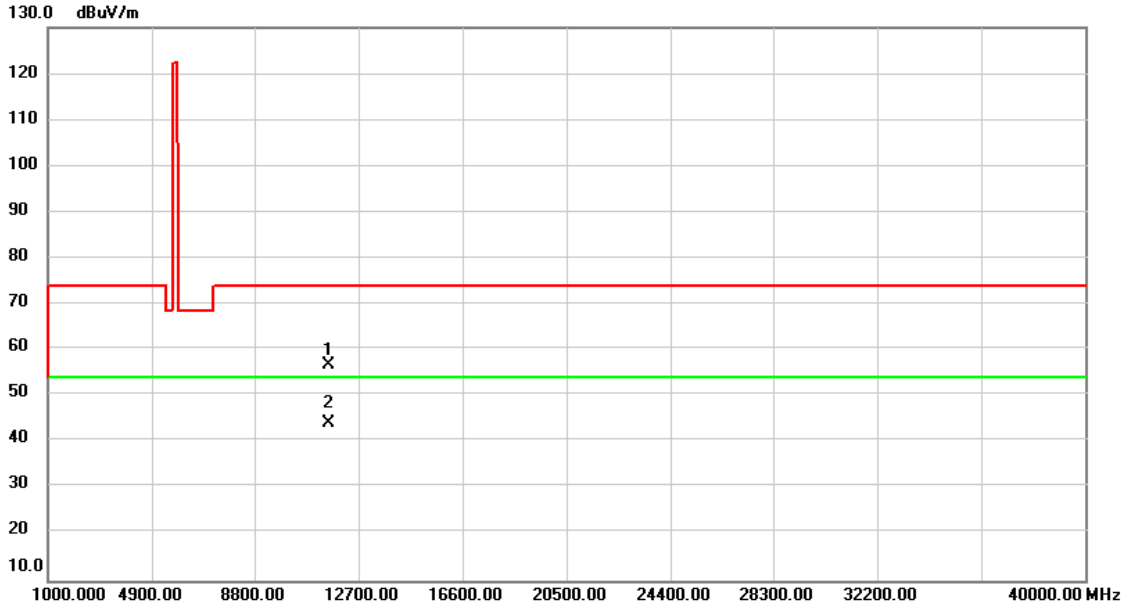

No.	Mk.	Freq. MHz	Reading Level dBuV	Correct Factor dB	Measure- ment dBuV/m	Limit dBuV/m	Margin dB	Detector	Comment
1		11570.00	53.18	3.57	56.75	74.00	-17.25	peak	
2	*	11570.00	40.40	3.57	43.97	54.00	-10.03	AVG	

REMARKS:

- (1) Measurement Value = Reading Level + Correct Factor.
- (2) Margin Level = Measurement Value - Limit Value.

Test Mode	UNII-1_TX n (HT20) Mode 5240MHz	Tested Date	2019/12/6
Test Voltage	DC 48V	Polarization	Vertical

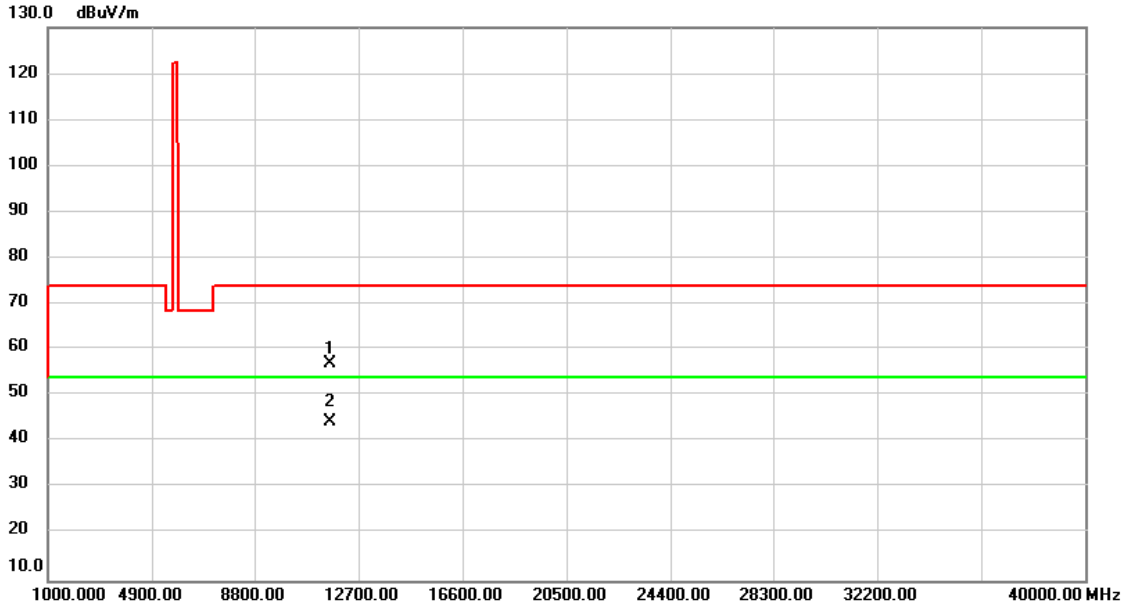

No.	Mk.	Freq. MHz	Reading Level dBuV	Correct Factor dB	Measure- ment dBuV/m	Limit dBuV/m	Margin dB	Detector	Comment
1		11650.00	53.85	3.18	57.03	74.00	-16.97	peak	
2	*	11650.00	41.16	3.18	44.34	54.00	-9.66	AVG	

REMARKS:

- (1) Measurement Value = Reading Level + Correct Factor.
- (2) Margin Level = Measurement Value - Limit Value.

Test Mode	UNII-1_TX n (HT20) Mode 5240MHz	Tested Date	2019/12/6
Test Voltage	DC 48V	Polarization	Horizontal

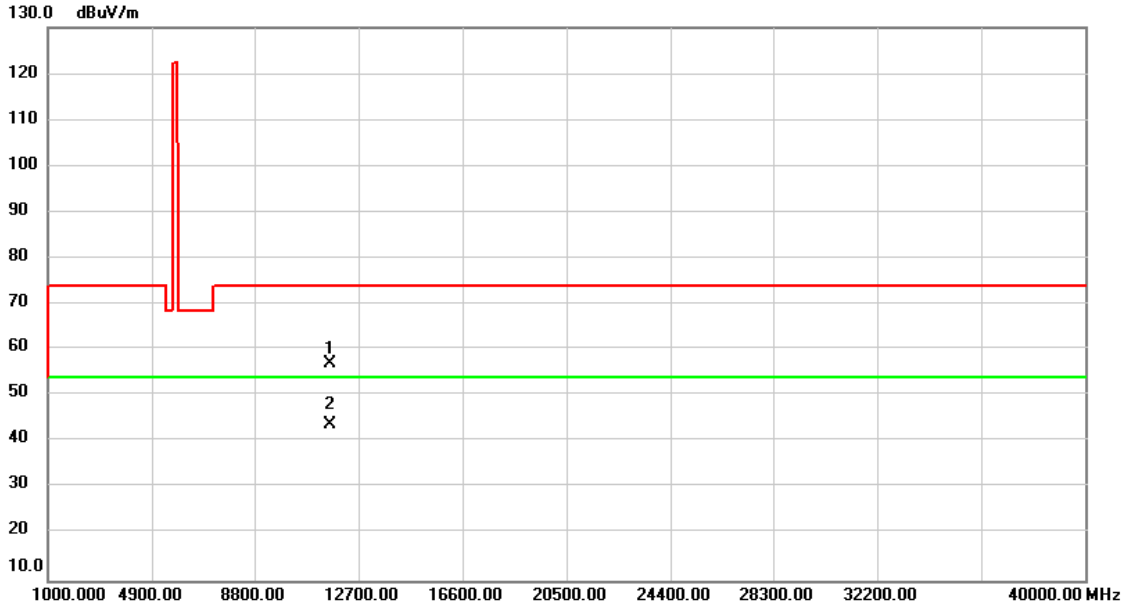

No.	Mk.	Freq. MHz	Reading Level dBuV	Correct Factor dB	Measure- ment dBuV/m	Limit dBuV/m	Margin dB	Detector	Comment
1		11650.00	53.64	3.18	56.82	74.00	-17.18	peak	
2	*	11650.00	40.64	3.18	43.82	54.00	-10.18	AVG	

REMARKS:

- (1) Measurement Value = Reading Level + Correct Factor.
- (2) Margin Level = Measurement Value - Limit Value.

Test Mode	UNII-1_TX ac (VHT40) Mode 5190MHz	Tested Date	2019/12/6
Test Voltage	DC 48V	Polarization	Vertical

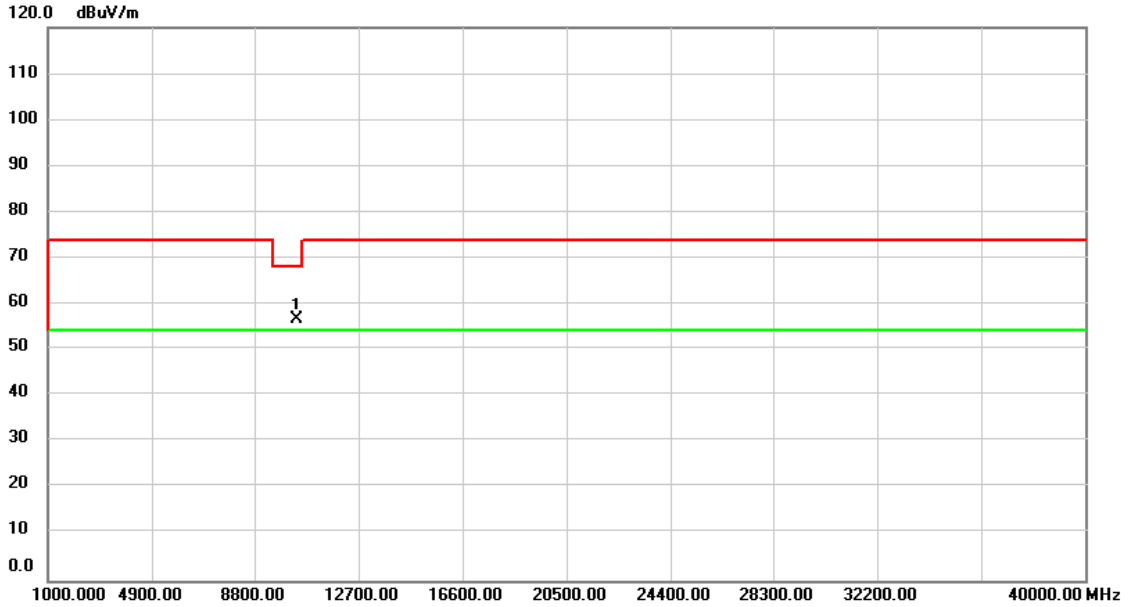

No.	Mk.	Freq.	Reading Level	Correct Factor	Measurement	Limit	Margin	Detector	Comment
		MHz	dBuV	dB	dBuV/m	dBuV/m	dB		
1	*	10360.00	53.58	2.83	56.41	68.20	-11.79	peak	

REMARKS:

- (1) Measurement Value = Reading Level + Correct Factor.
- (2) Margin Level = Measurement Value - Limit Value.

Test Mode	UNII-1_TX ac (VHT40) Mode 5190MHz	Tested Date	2019/12/6
Test Voltage	DC 48V	Polarization	Horizontal

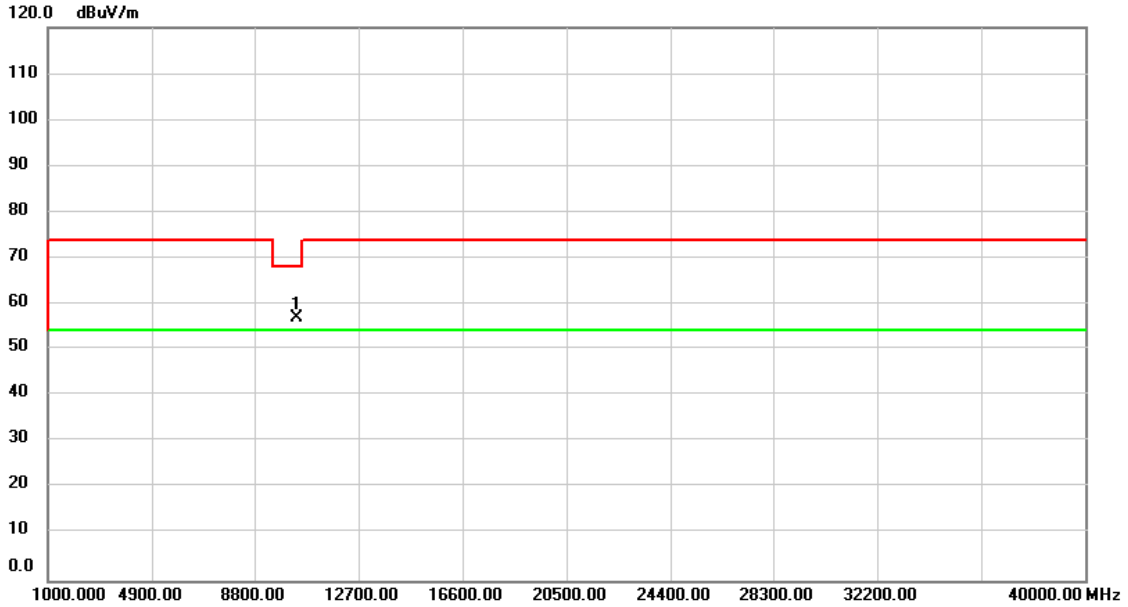

No.	Mk.	Freq. MHz	Reading Level dBuV	Correct Factor dB	Measure- ment dBuV/m	Limit dBuV/m	Margin dB	Detector	Comment
1	*	10360.00	54.09	2.83	56.92	68.20	-11.28	peak	

REMARKS:

- (1) Measurement Value = Reading Level + Correct Factor.
- (2) Margin Level = Measurement Value - Limit Value.

Test Mode	UNII-1_TX ac (VHT40) Mode 5230MHz	Tested Date	2019/12/6
Test Voltage	DC 48V	Polarization	Vertical

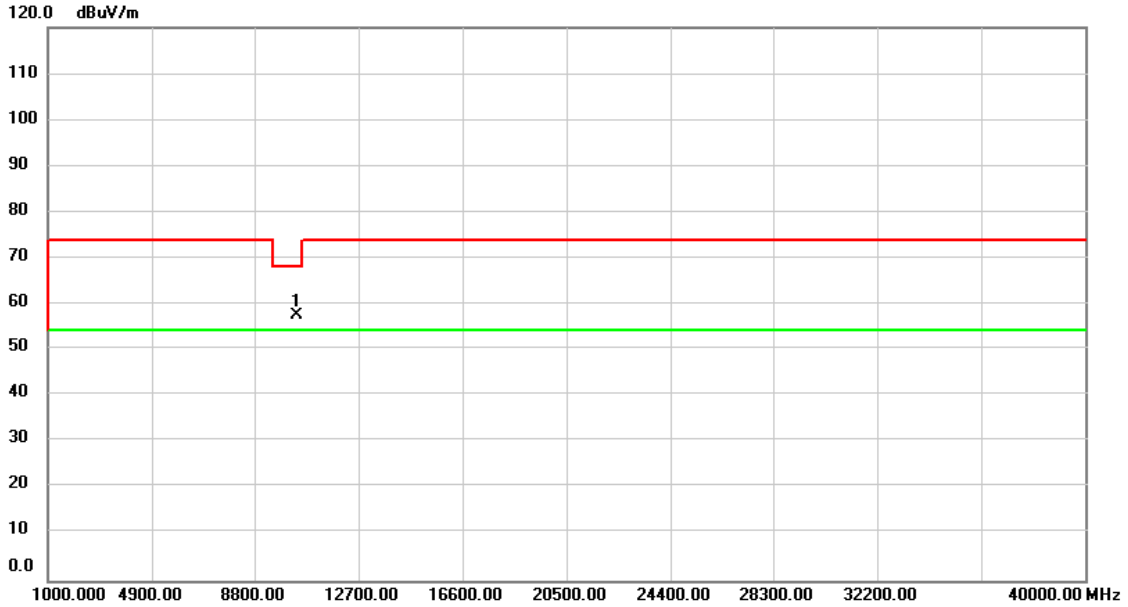

No.	Mk.	Freq.	Reading Level	Correct Factor	Measurement	Limit	Margin	Detector	Comment
		MHz	dBuV	dB	dBuV/m	dBuV/m	dB		
1	*	10400.00	54.45	2.89	57.34	68.20	-10.86	peak	

REMARKS:

- (1) Measurement Value = Reading Level + Correct Factor.
- (2) Margin Level = Measurement Value - Limit Value.

Test Mode	UNII-1_TX ac (VHT40) Mode 5230MHz	Tested Date	2019/12/6
Test Voltage	DC 48V	Polarization	Horizontal

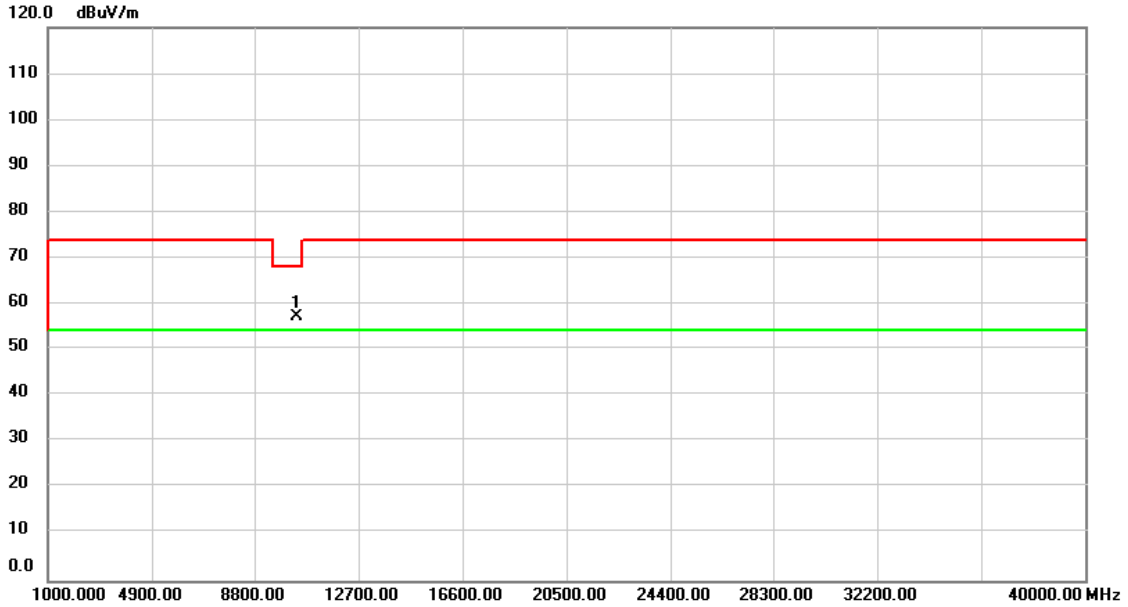

No.	Mk.	Freq.	Reading Level	Correct Factor	Measurement	Limit	Margin	Detector	Comment
		MHz	dBuV	dB	dBuV/m	dBuV/m	dB		
1	*	10400.00	54.35	2.89	57.24	68.20	-10.96	peak	

REMARKS:

- (1) Measurement Value = Reading Level + Correct Factor.
- (2) Margin Level = Measurement Value - Limit Value.

Test Mode	UNII-1_TX ac (VHT80) Mode 5210MHz	Tested Date	2019/12/6
Test Voltage	DC 48V	Polarization	Vertical

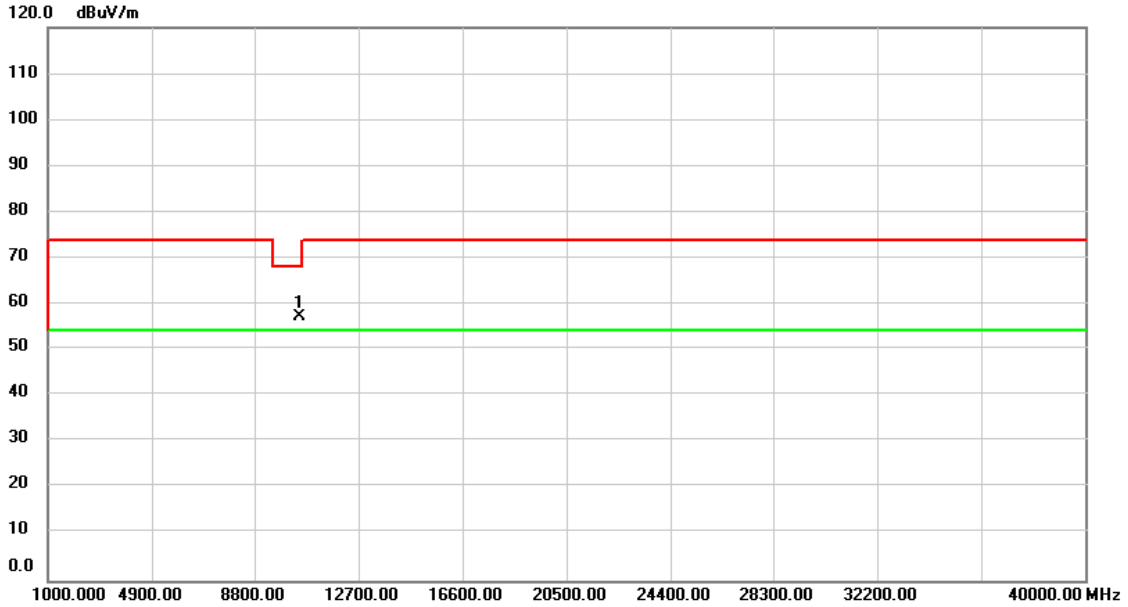

No.	Mk.	Freq.	Reading Level	Correct Factor	Measurement	Limit	Margin	Detector	Comment
		MHz	dBuV	dB	dBuV/m	dBuV/m	dB		
1	*	10480.00	54.13	3.00	57.13	68.20	-11.07	peak	

REMARKS:

- (1) Measurement Value = Reading Level + Correct Factor.
- (2) Margin Level = Measurement Value - Limit Value.

Test Mode	UNII-1_TX ac (VHT80) Mode 5210MHz	Tested Date	2019/12/6
Test Voltage	DC 48V	Polarization	Horizontal

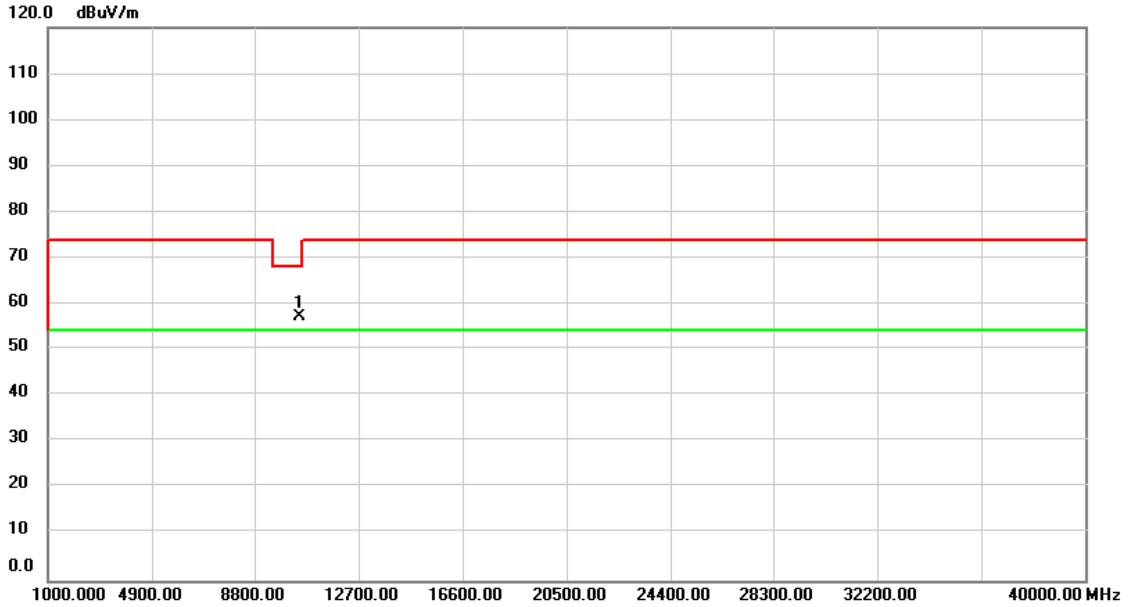

No.	Mk.	Freq.	Reading Level	Correct Factor	Measurement	Limit	Margin	Detector	Comment
		MHz	dBuV	dB	dBuV/m	dBuV/m	dB		
1	*	10480.00	54.14	3.00	57.14	68.20	-11.06	peak	

REMARKS:

- (1) Measurement Value = Reading Level + Correct Factor.
- (2) Margin Level = Measurement Value - Limit Value.

Test Mode	UNII-3_TX a Mode 5745MHz	Tested Date	2019/12/6
Test Voltage	DC 48V	Polarization	Vertical

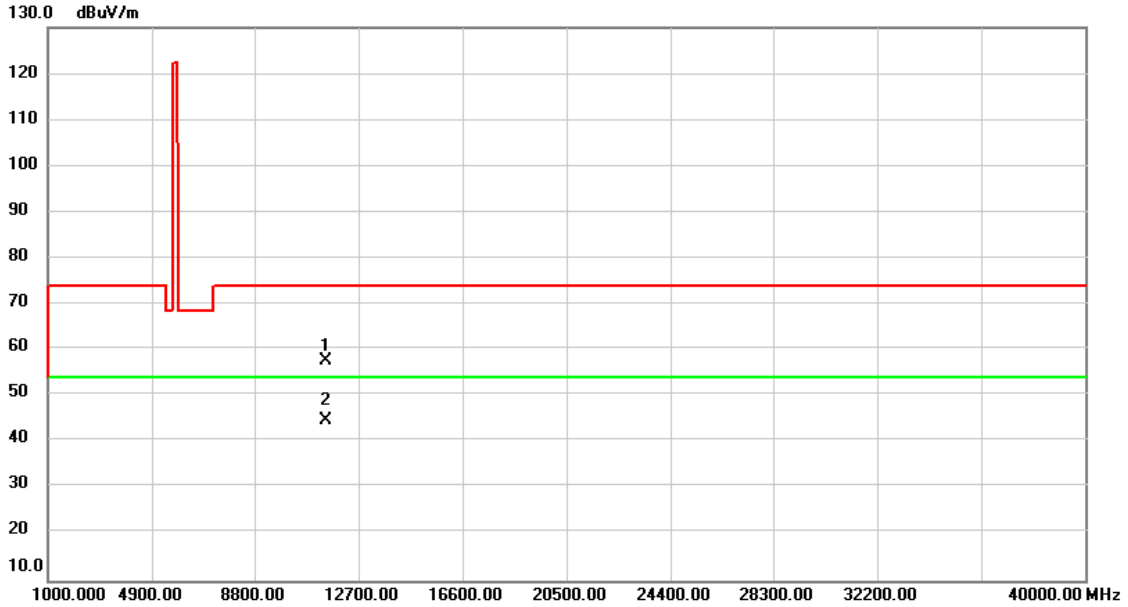

No.	Mk.	Freq. MHz	Reading Level dBuV	Correct Factor dB	Measure- ment dBuV/m	Limit dBuV/m	Margin dB	Detector	Comment
1		11490.00	53.56	3.89	57.45	74.00	-16.55	peak	
2	*	11490.00	40.85	3.89	44.74	54.00	-9.26	AVG	

REMARKS:

- (1) Measurement Value = Reading Level + Correct Factor.
- (2) Margin Level = Measurement Value - Limit Value.

Test Mode	UNII-3_TX a Mode 5745MHz	Tested Date	2019/12/6
Test Voltage	DC 48V	Polarization	Horizontal

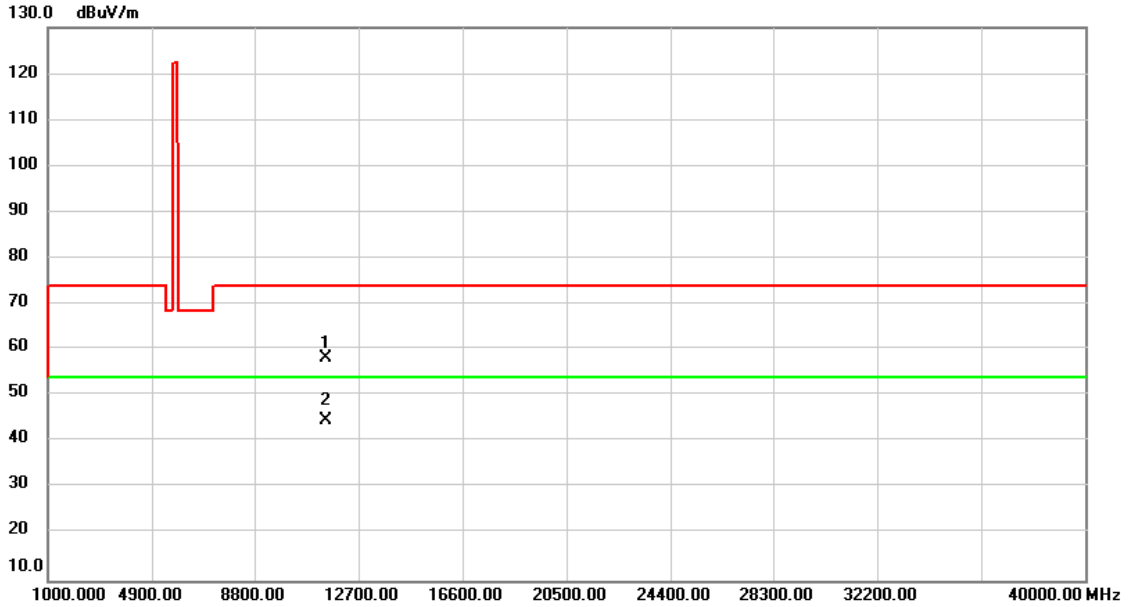

No.	Mk.	Freq. MHz	Reading Level dBuV	Correct Factor dB	Measure- ment dBuV/m	Limit dBuV/m	Margin dB	Detector	Comment
1		11490.00	54.20	3.89	58.09	74.00	-15.91	peak	
2	*	11490.00	40.81	3.89	44.70	54.00	-9.30	AVG	

REMARKS:

- (1) Measurement Value = Reading Level + Correct Factor.
- (2) Margin Level = Measurement Value - Limit Value.

Test Mode	UNII-3_TX a Mode 5785MHz	Tested Date	2019/12/6
Test Voltage	DC 48V	Polarization	Vertical

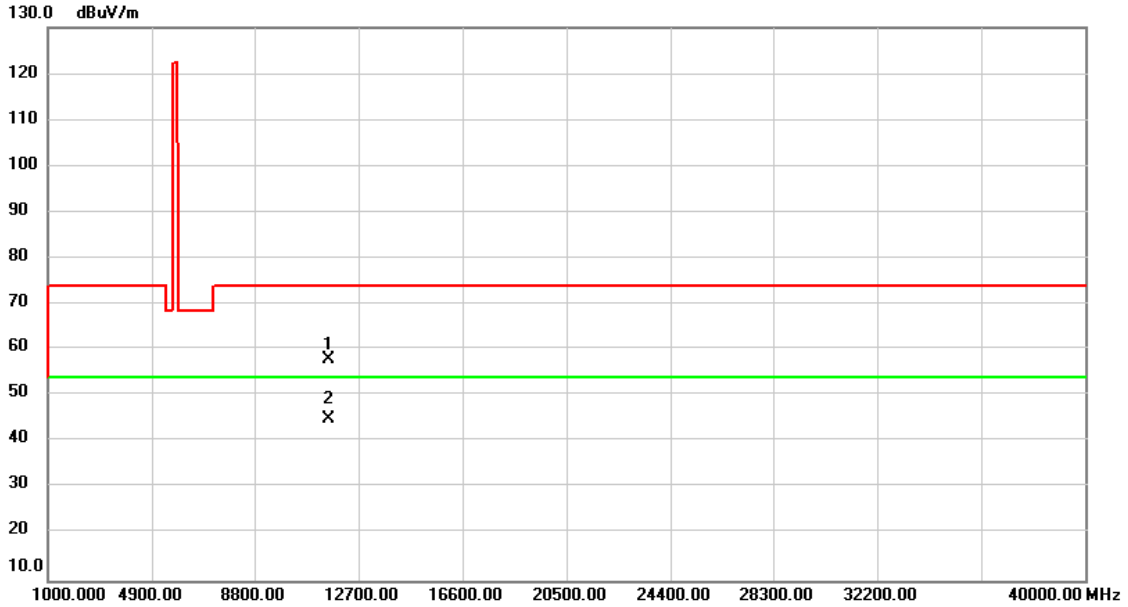

No.	Mk.	Freq. MHz	Reading Level dBuV	Correct Factor dB	Measure- ment dBuV/m	Limit dBuV/m	Margin dB	Detector	Comment
1		11570.00	54.33	3.57	57.90	74.00	-16.10	peak	
2	*	11570.00	41.28	3.57	44.85	54.00	-9.15	AVG	

REMARKS:

- (1) Measurement Value = Reading Level + Correct Factor.
- (2) Margin Level = Measurement Value - Limit Value.

Test Mode	UNII-3_TX a Mode 5785MHz	Tested Date	2019/12/6
Test Voltage	DC 48V	Polarization	Horizontal

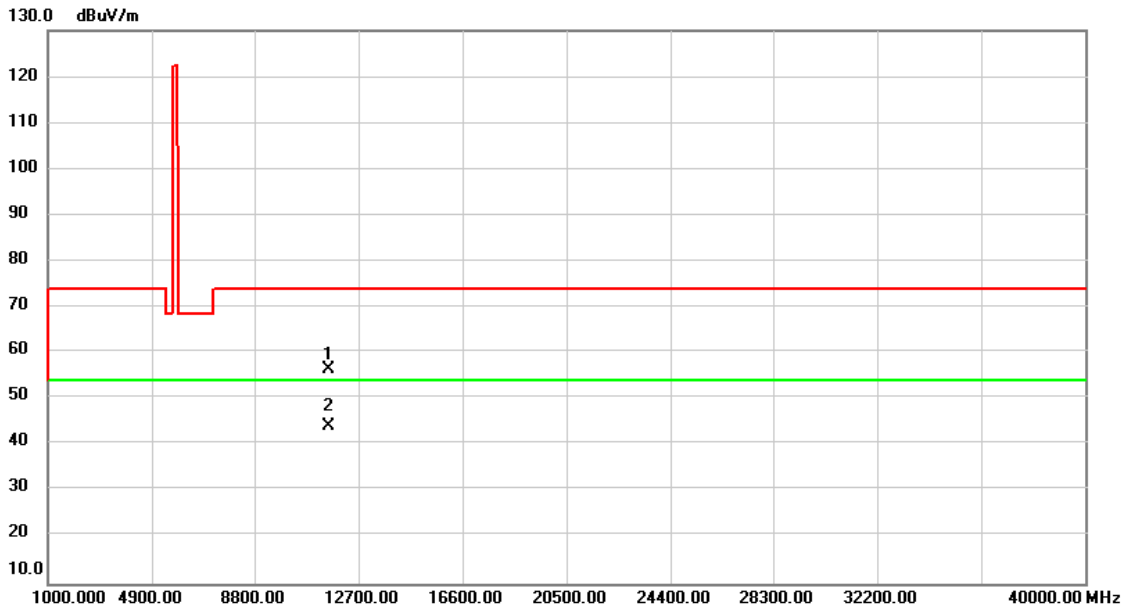

No.	Mk.	Freq. MHz	Reading Level dBuV	Correct Factor dB	Measure- ment dBuV/m	Limit dBuV/m	Margin dB	Detector	Comment
1		11570.00	52.84	3.57	56.41	74.00	-17.59	peak	
2	*	11570.00	40.38	3.57	43.95	54.00	-10.05	AVG	

REMARKS:

- (1) Measurement Value = Reading Level + Correct Factor.
- (2) Margin Level = Measurement Value - Limit Value.

Test Mode	UNII-3_TX a Mode 5825MHz	Tested Date	2019/12/6
Test Voltage	DC 48V	Polarization	Vertical

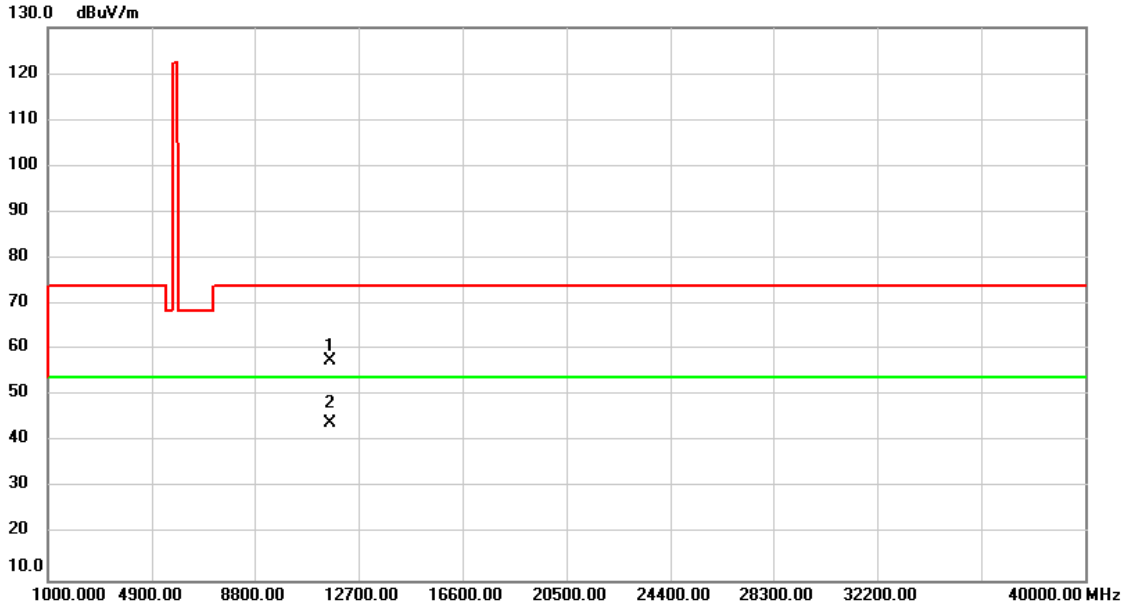

No.	Mk.	Freq. MHz	Reading Level dBuV	Correct Factor dB	Measure- ment dBuV/m	Limit dBuV/m	Margin dB	Detector	Comment
1		11650.00	54.48	3.18	57.66	74.00	-16.34	peak	
2	*	11650.00	40.86	3.18	44.04	54.00	-9.96	AVG	

REMARKS:

- (1) Measurement Value = Reading Level + Correct Factor.
- (2) Margin Level = Measurement Value - Limit Value.

Test Mode	UNII-3_TX a Mode 5825MHz	Tested Date	2019/12/6
Test Voltage	DC 48V	Polarization	Horizontal

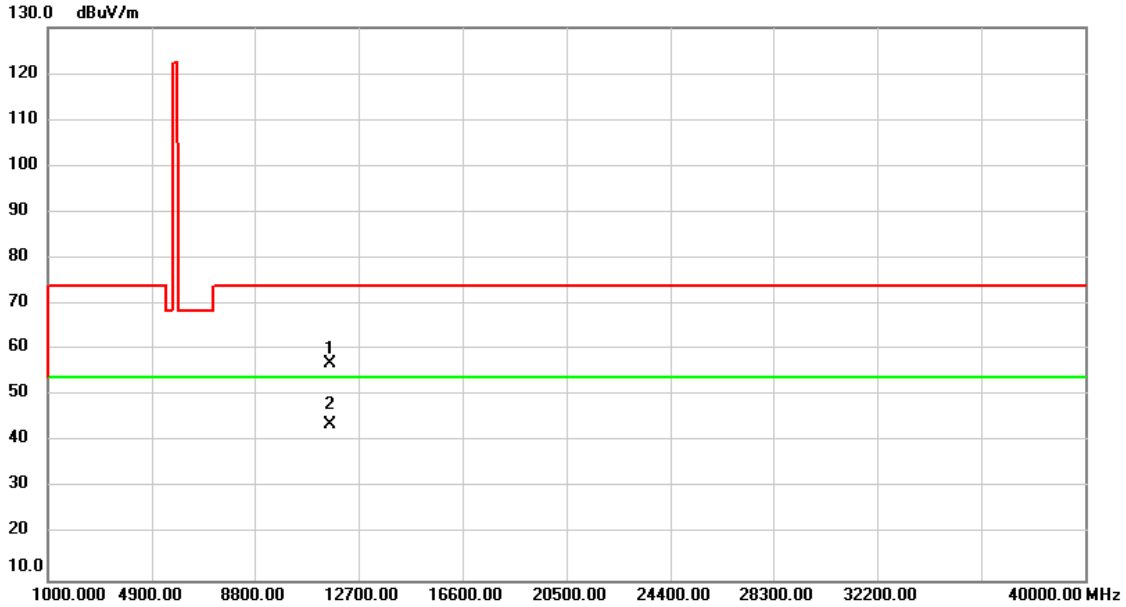

No.	Mk.	Freq. MHz	Reading Level dBuV	Correct Factor dB	Measure- ment dBuV/m	Limit dBuV/m	Margin dB	Detector	Comment
1		11650.00	53.82	3.18	57.00	74.00	-17.00	peak	
2	*	11650.00	40.60	3.18	43.78	54.00	-10.22	AVG	

REMARKS:

- (1) Measurement Value = Reading Level + Correct Factor.
- (2) Margin Level = Measurement Value - Limit Value.

Test Mode	UNII-3_TX n (HT20) Mode 5745MHz	Tested Date	2019/12/6
Test Voltage	DC 48V	Polarization	Vertical

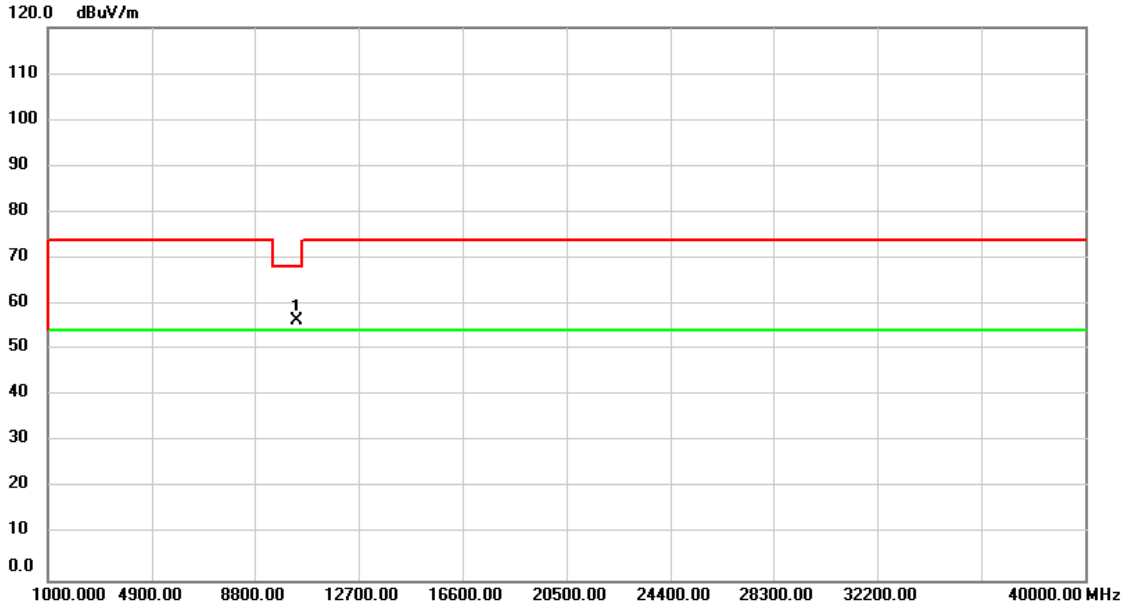

No.	Mk.	Freq.	Reading Level	Correct Factor	Measurement	Limit	Margin	Detector	Comment
		MHz	dBuV	dB	dBuV/m	dBuV/m	dB		
1	*	10380.00	53.44	2.85	56.29	68.20	-11.91	peak	

REMARKS:

- (1) Measurement Value = Reading Level + Correct Factor.
- (2) Margin Level = Measurement Value - Limit Value.

Test Mode	UNII-3_TX n (HT20) Mode 5745MHz	Tested Date	2019/12/6
Test Voltage	DC 48V	Polarization	Horizontal

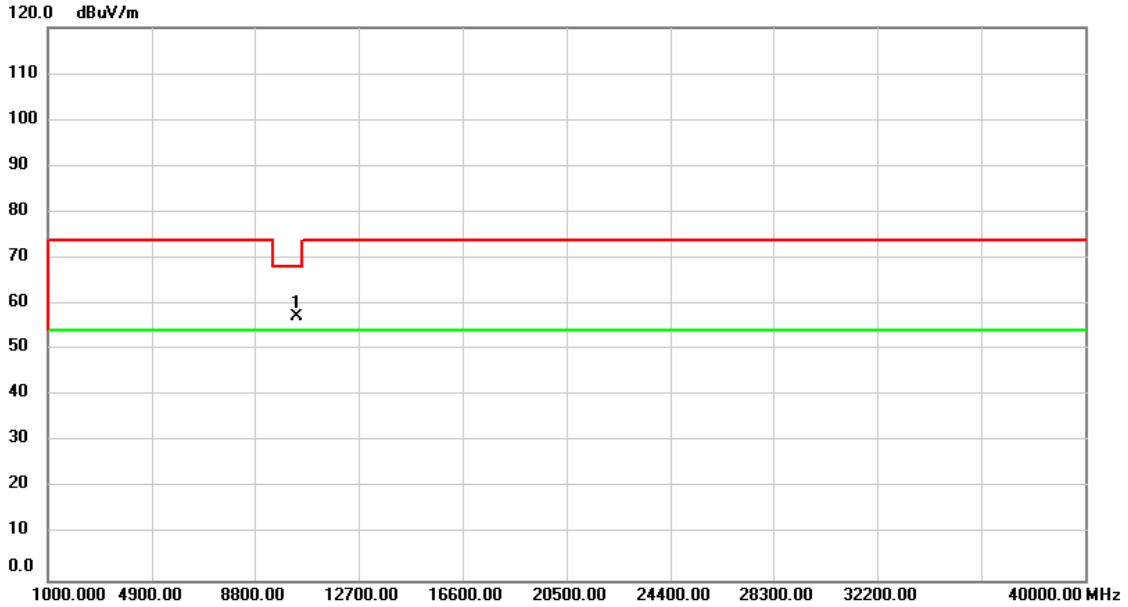

No.	Mk.	Freq.	Reading Level	Correct Factor	Measurement	Limit	Margin	Detector	Comment
		MHz	dBuV	dB	dBuV/m	dBuV/m	dB		
1	*	10380.00	54.35	2.85	57.20	68.20	-11.00	peak	

REMARKS:

- (1) Measurement Value = Reading Level + Correct Factor.
- (2) Margin Level = Measurement Value - Limit Value.

Test Mode	UNII-3_TX n (HT20) Mode 5785MHz	Tested Date	2019/12/6
Test Voltage	DC 48V	Polarization	Vertical

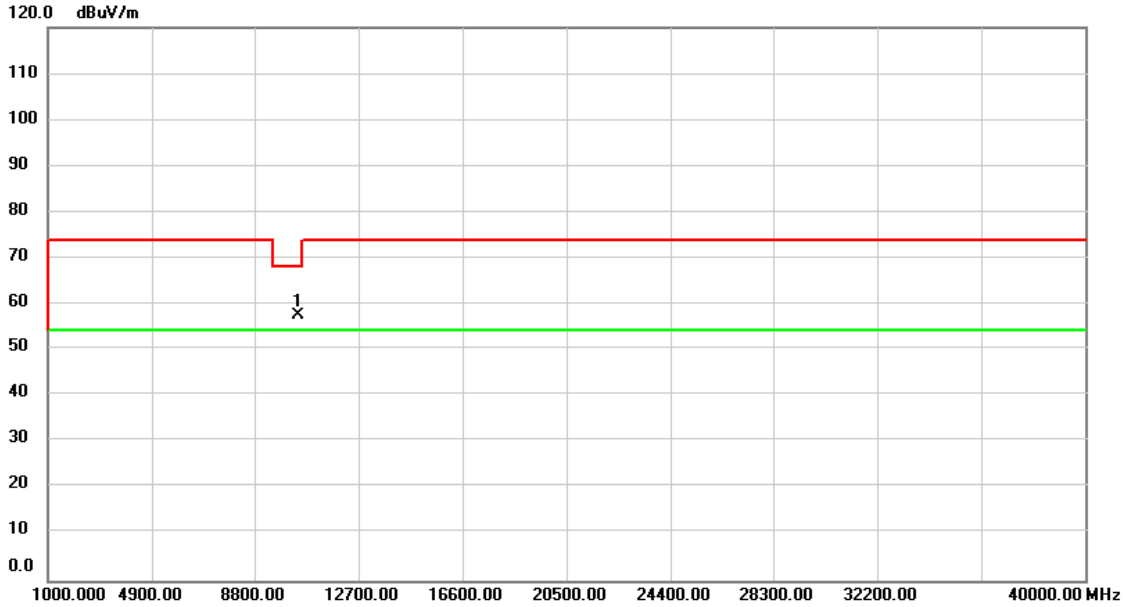

No.	Mk.	Freq.	Reading Level	Correct Factor	Measurement	Limit	Margin	Detector	Comment
		MHz	dBuV	dB	dBuV/m	dBuV/m	dB		
1	*	10460.00	54.47	2.98	57.45	68.20	-10.75	peak	

REMARKS:

- (1) Measurement Value = Reading Level + Correct Factor.
- (2) Margin Level = Measurement Value - Limit Value.

Test Mode	UNII-3_TX n (HT20) Mode 5785MHz	Tested Date	2019/12/6
Test Voltage	DC 48V	Polarization	Horizontal

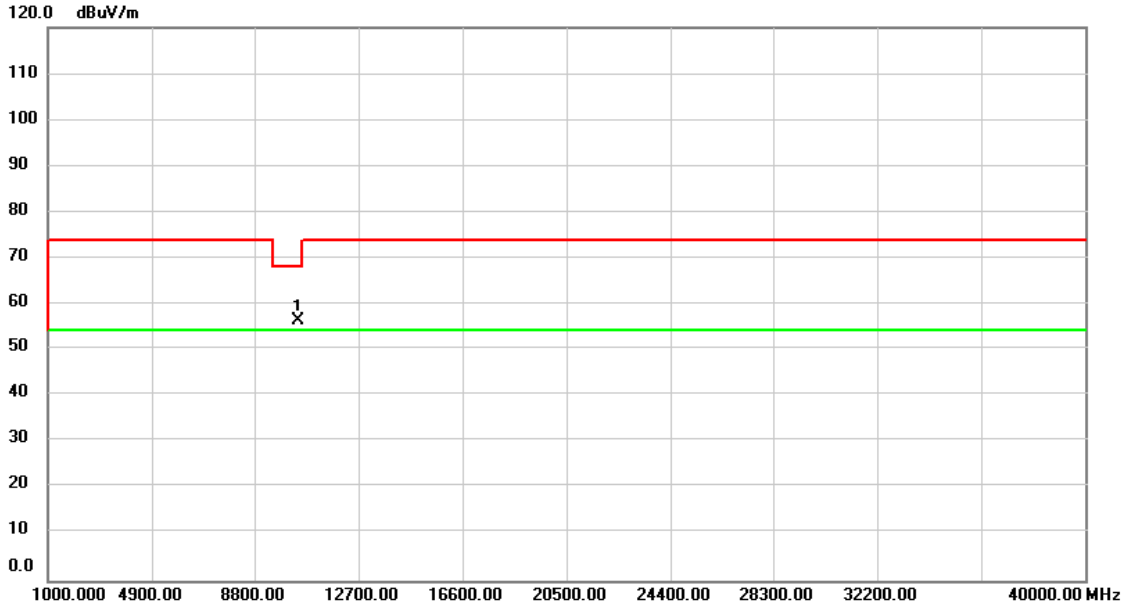

No.	Mk.	Freq.	Reading Level	Correct Factor	Measurement	Limit	Margin	Detector	Comment
		MHz	dBuV	dB	dBuV/m	dBuV/m	dB		
1	*	10460.00	53.31	2.98	56.29	68.20	-11.91	peak	

REMARKS:

- (1) Measurement Value = Reading Level + Correct Factor.
- (2) Margin Level = Measurement Value - Limit Value.

Test Mode	UNII-3_TX n (HT20)Mode 5825MHz	Tested Date	2019/12/6
Test Voltage	DC 48V	Polarization	Vertical

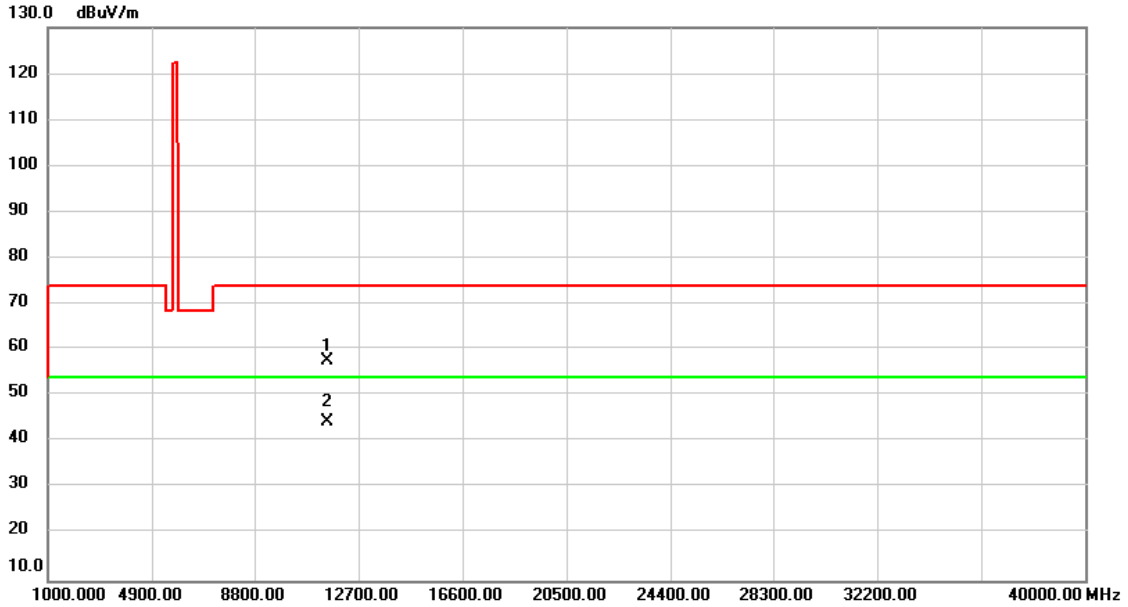

No.	Mk.	Freq. MHz	Reading Level dBuV	Correct Factor dB	Measure- ment dBuV/m	Limit dBuV/m	Margin dB	Detector	Comment
1		11510.00	53.78	3.86	57.64	74.00	-16.36	peak	
2	*	11510.00	40.54	3.86	44.40	54.00	-9.60	AVG	

REMARKS:

- (1) Measurement Value = Reading Level + Correct Factor.
- (2) Margin Level = Measurement Value - Limit Value.

Test Mode	UNII-3_TX n (HT20)Mode 5825MHz	Tested Date	2019/12/6
Test Voltage	DC 48V	Polarization	Horizontal

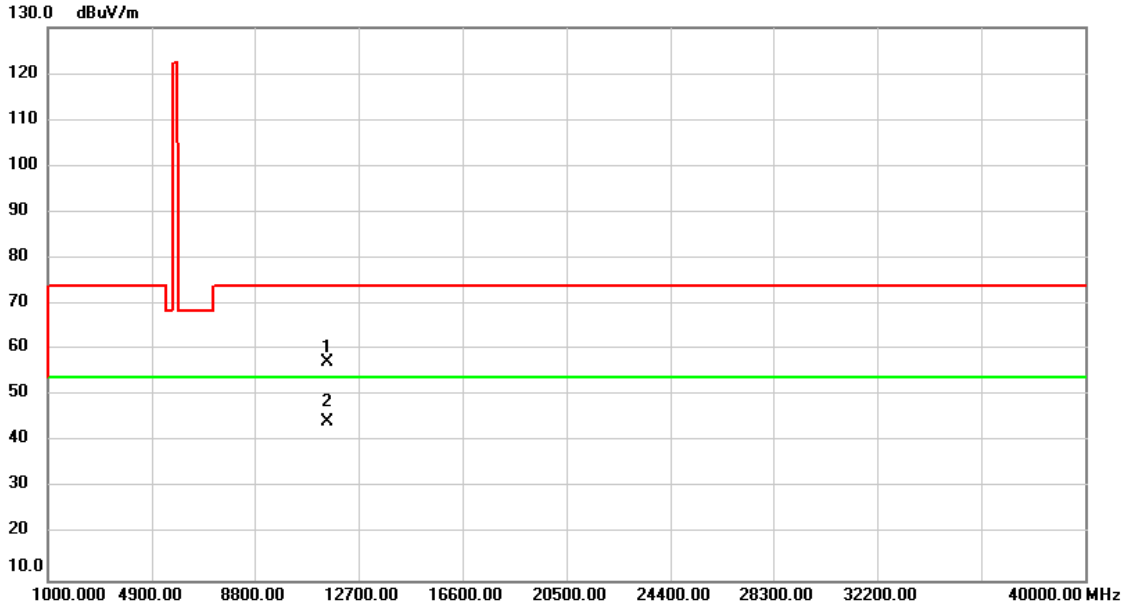

No.	Mk.	Freq. MHz	Reading Level dBuV	Correct Factor dB	Measure- ment dBuV/m	Limit dBuV/m	Margin dB	Detector	Comment
1		11510.00	53.43	3.86	57.29	74.00	-16.71	peak	
2	*	11510.00	40.54	3.86	44.40	54.00	-9.60	AVG	

REMARKS:

- (1) Measurement Value = Reading Level + Correct Factor.
- (2) Margin Level = Measurement Value - Limit Value.

Test Mode	UNII-3_TX ac (VHT40) Mode 5755MHz	Tested Date	2019/12/6
Test Voltage	DC 48V	Polarization	Vertical

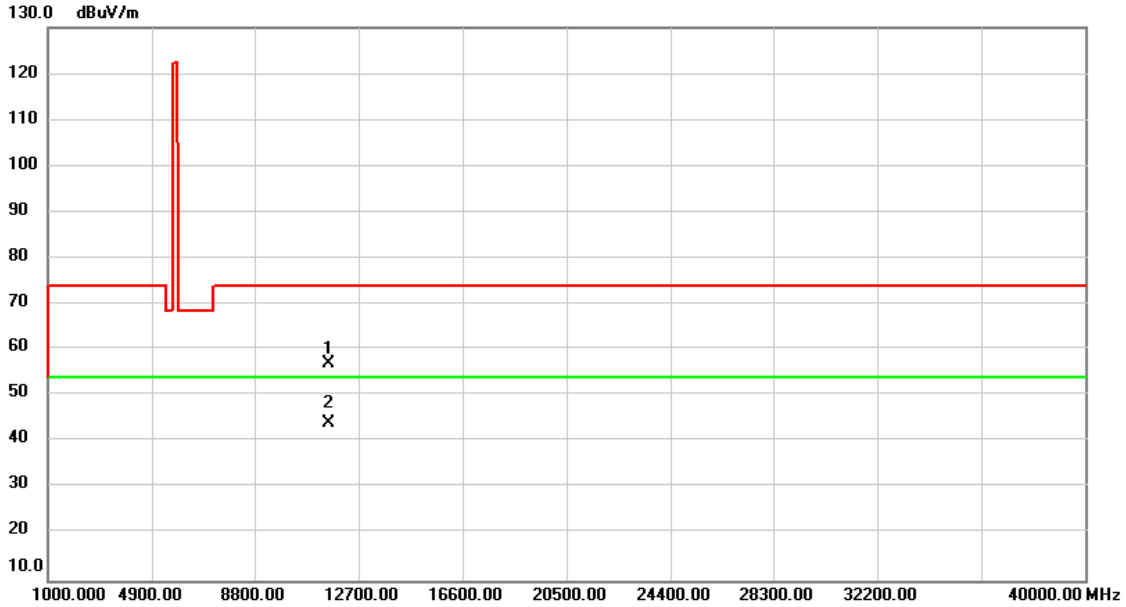

No.	Mk.	Freq. MHz	Reading Level dBuV	Correct Factor dB	Measure- ment dBuV/m	Limit dBuV/m	Margin dB	Detector	Comment
1		11590.00	53.60	3.47	57.07	74.00	-16.93	peak	
2	*	11590.00	40.72	3.47	44.19	54.00	-9.81	AVG	

REMARKS:

- (1) Measurement Value = Reading Level + Correct Factor.
- (2) Margin Level = Measurement Value - Limit Value.

Test Mode	UNII-3_TX ac (VHT40) Mode 5755MHz	Tested Date	2019/12/6
Test Voltage	DC 48V	Polarization	Horizontal

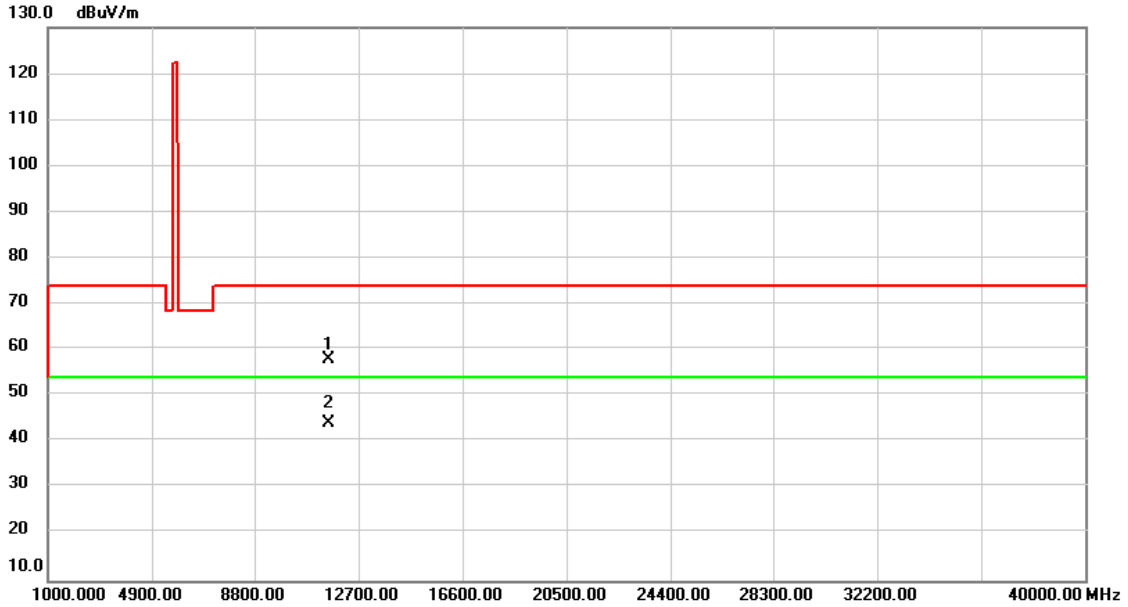

No.	Mk.	Freq. MHz	Reading Level dBuV	Correct Factor dB	Measure- ment dBuV/m	Limit dBuV/m	Margin dB	Detector	Comment
1		11590.00	54.38	3.47	57.85	74.00	-16.15	peak	
2	*	11590.00	40.70	3.47	44.17	54.00	-9.83	AVG	

REMARKS:

- (1) Measurement Value = Reading Level + Correct Factor.
- (2) Margin Level = Measurement Value - Limit Value.

Test Mode	UNII-3_TX ac (VHT40) Mode 5795MHz	Tested Date	2019/12/6
Test Voltage	DC 48V	Polarization	Vertical

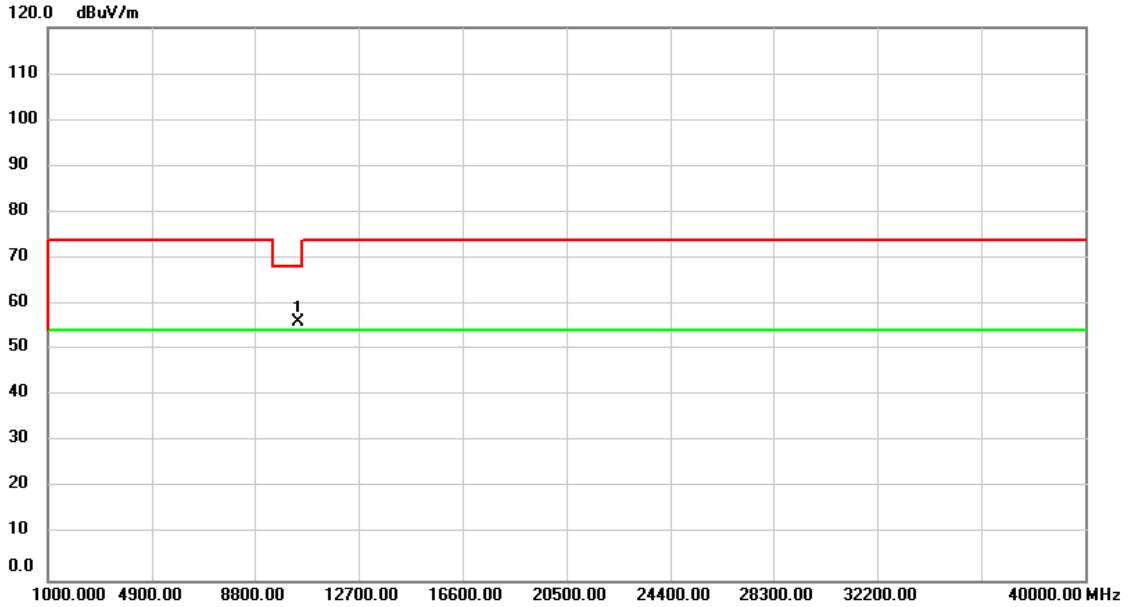

No.	Mk.	Freq.	Reading Level	Correct Factor	Measurement	Limit	Margin	Detector	Comment
		MHz	dBuV	dB	dBuV/m	dBuV/m	dB		
1	*	10420.00	52.93	2.91	55.84	68.20	-12.36	peak	

REMARKS:

- (1) Measurement Value = Reading Level + Correct Factor.
- (2) Margin Level = Measurement Value - Limit Value.

Test Mode	UNII-3_TX ac (VHT40) Mode 5795MHz	Tested Date	2019/12/6
Test Voltage	DC 48V	Polarization	Horizontal

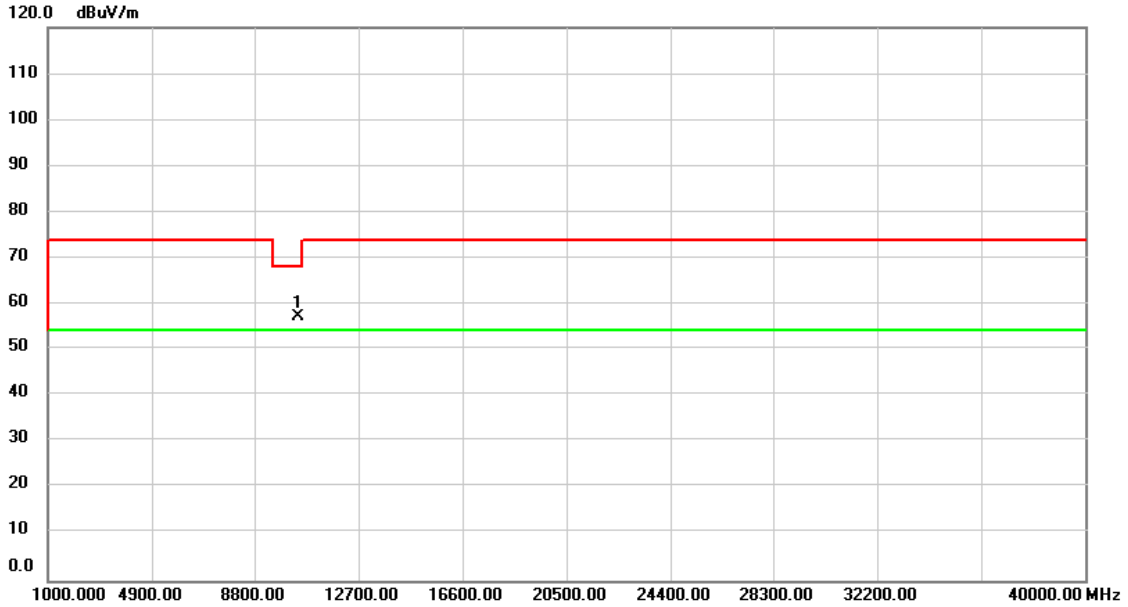

No.	Mk.	Freq.	Reading Level	Correct Factor	Measurement	Limit	Margin	Detector	Comment
		MHz	dBuV	dB	dBuV/m	dBuV/m	dB		
1	*	10420.00	54.29	2.91	57.20	68.20	-11.00	peak	

REMARKS:

- (1) Measurement Value = Reading Level + Correct Factor.
- (2) Margin Level = Measurement Value - Limit Value.

Test Mode	UNII-3_TX ac (VHT80) Mode 5775MHz	Tested Date	2019/12/6
Test Voltage	DC 48V	Polarization	Vertical

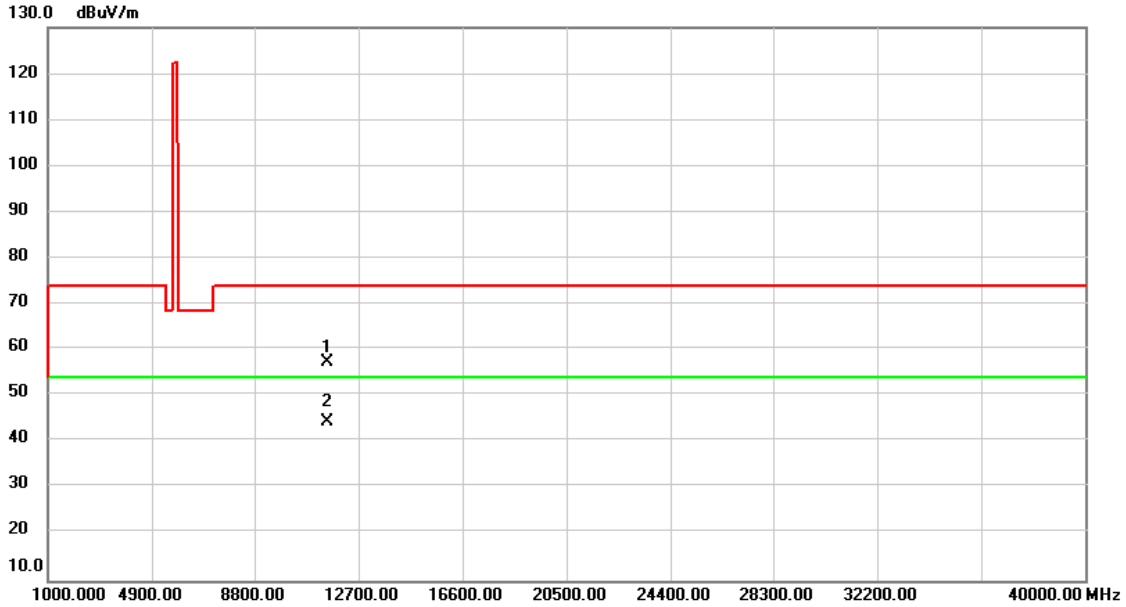

No.	Mk.	Freq. MHz	Reading Level dBuV	Correct Factor dB	Measure- ment dBuV/m	Limit dBuV/m	Margin dB	Detector	Comment
1		11550.00	53.63	3.67	57.30	74.00	-16.70	peak	
2	*	11550.00	40.64	3.67	44.31	54.00	-9.69	AVG	

REMARKS:

- (1) Measurement Value = Reading Level + Correct Factor.
- (2) Margin Level = Measurement Value - Limit Value.

Test Mode	UNII-3_TX ac (VHT80) Mode 5775MHz	Tested Date	2019/12/6
Test Voltage	DC 48V	Polarization	Horizontal

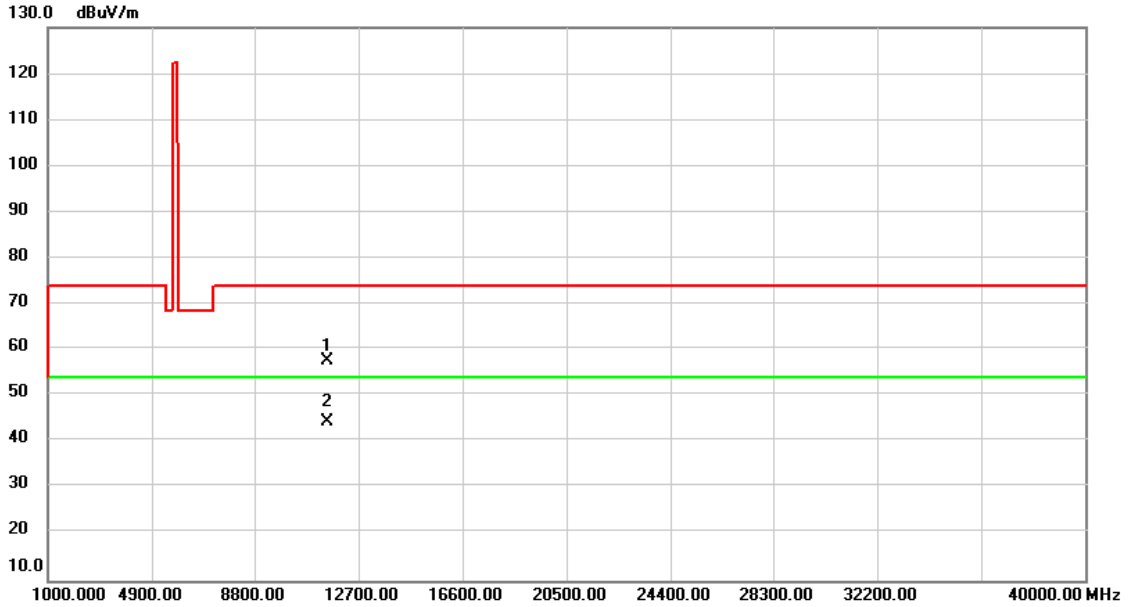

No.	Mk.	Freq. MHz	Reading Level dBuV	Correct Factor dB	Measure- ment dBuV/m	Limit dBuV/m	Margin dB	Detector	Comment
1		11550.00	53.97	3.67	57.64	74.00	-16.36	peak	
2	*	11550.00	40.72	3.67	44.39	54.00	-9.61	AVG	

REMARKS:

- (1) Measurement Value = Reading Level + Correct Factor.
- (2) Margin Level = Measurement Value - Limit Value.

APPENDIX D BANDWIDTH

Test Mode	IEEE 802.11a
Test Voltage	DC 48V

Frequency (MHz)	26dB Bandwidth (MHz)	99% Occupied Bandwidth (MHz)
5180	36.90	18.90
5200	42.00	20.50
5240	39.50	20.40

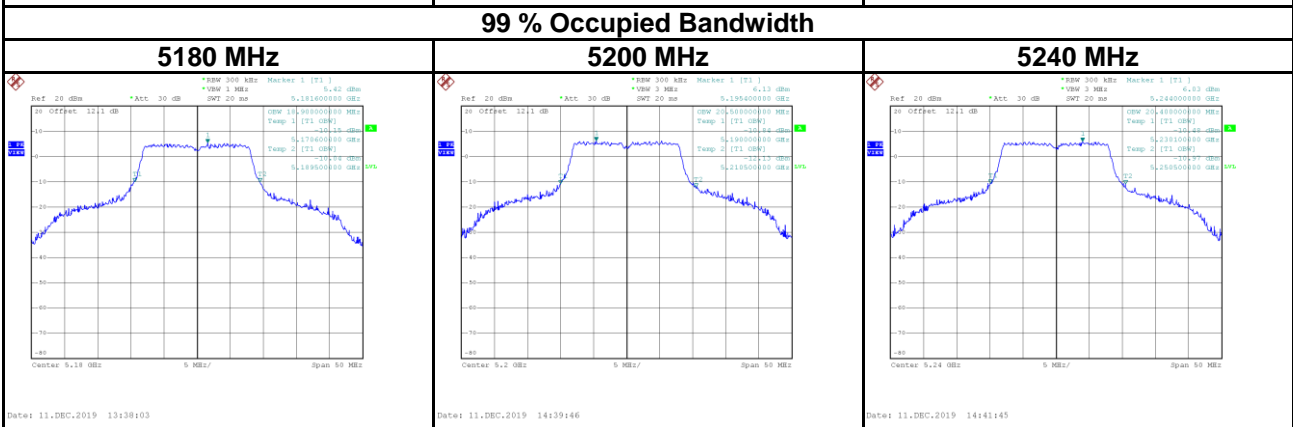
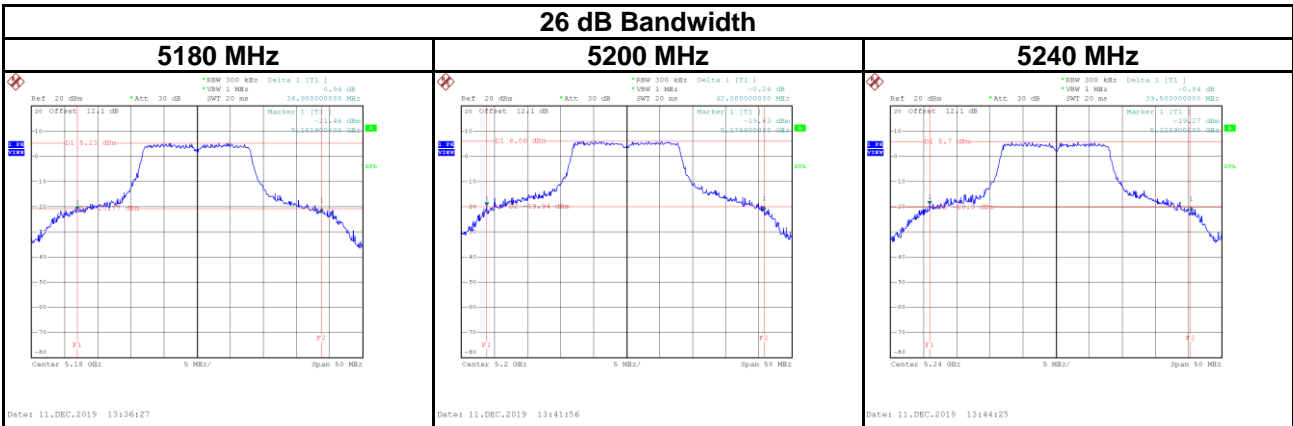

Frequency (MHz)	6dB Bandwidth (MHz)	99 % Occupied Bandwidth (MHz)	6 dB Bandwidth Limit (kHz)	Result
5745	16.60	18.20	500	Complies
5785	16.60	18.00	500	Complies
5825	16.50	18.00	500	Complies

6 dB Bandwidth

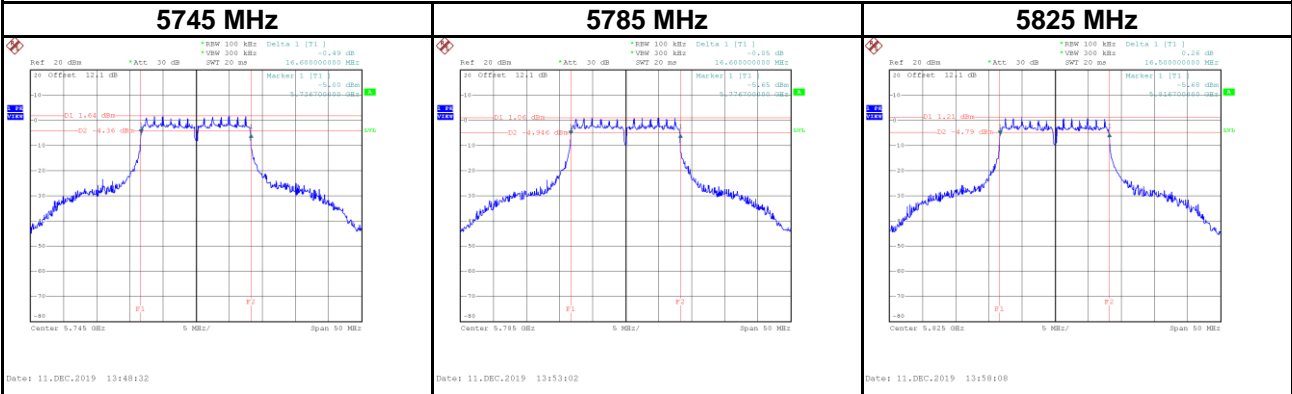

99 % Occupied Bandwidth

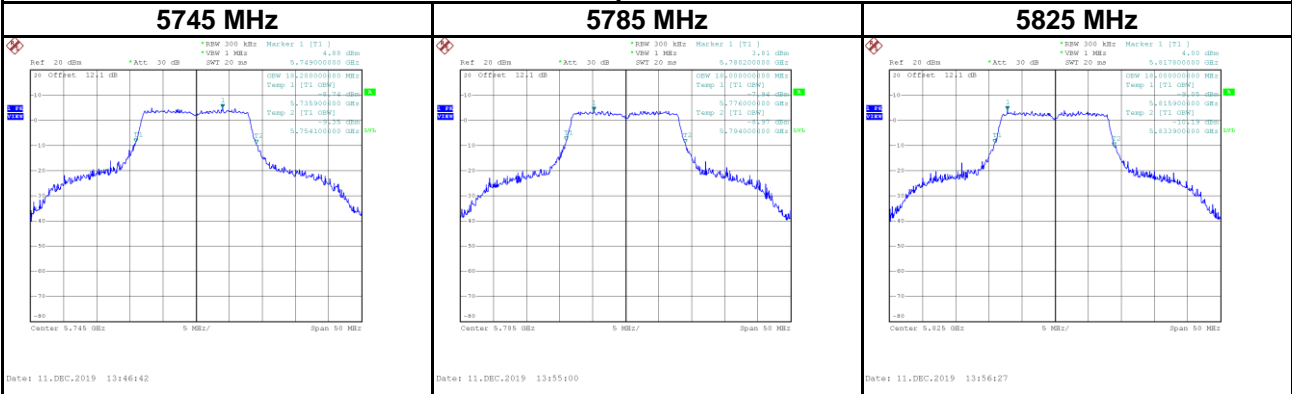

Test Mode	IEEE 802.11n (HT20)
Test Voltage	DC 48V

Frequency (MHz)	26dB Bandwidth (MHz)	99% Occupied Bandwidth (MHz)
5180	40.20	19.80
5200	43.10	20.80
5240	42.50	20.80

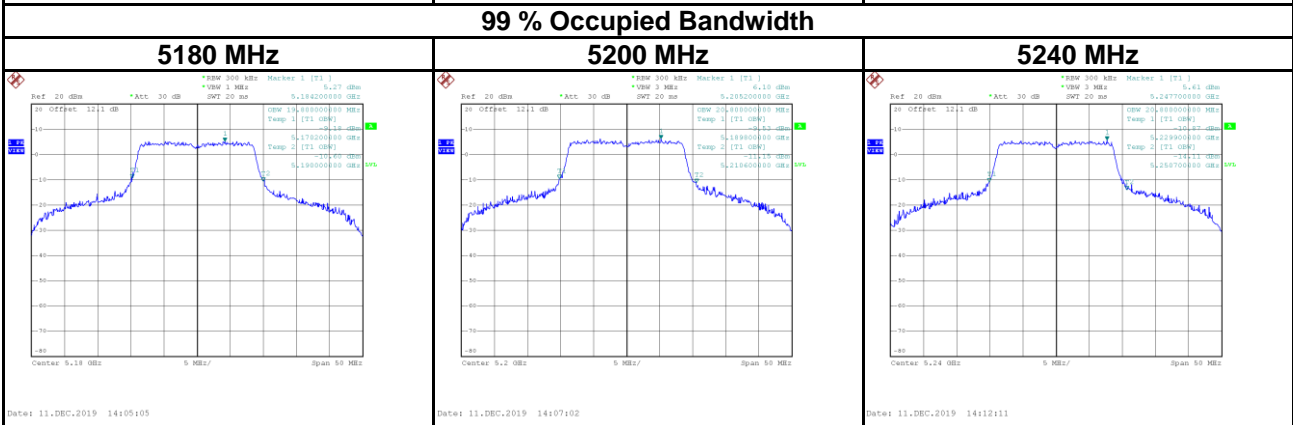
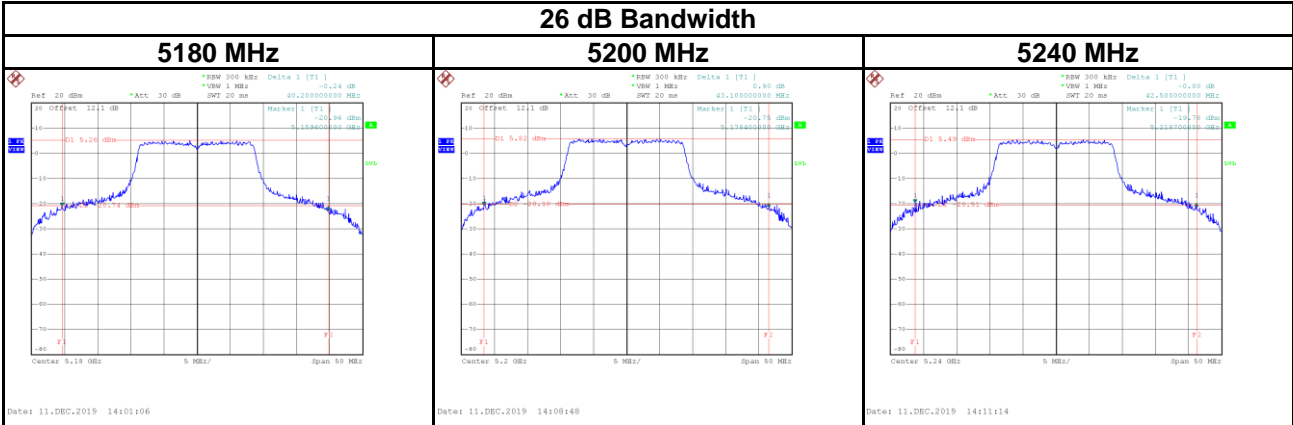

Frequency (MHz)	6dB Bandwidth (MHz)	99 % Occupied Bandwidth (MHz)	6 dB Bandwidth Limit (kHz)	Result
5745	17.60	18.80	500	Complies
5785	17.60	18.90	500	Complies
5825	17.60	19.00	500	Complies

6 dB Bandwidth

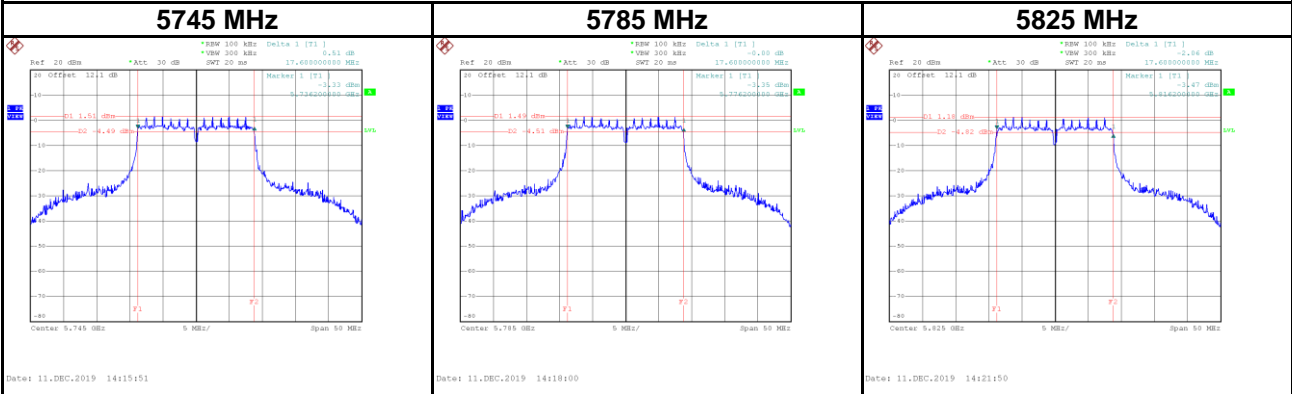

99 % Occupied Bandwidth

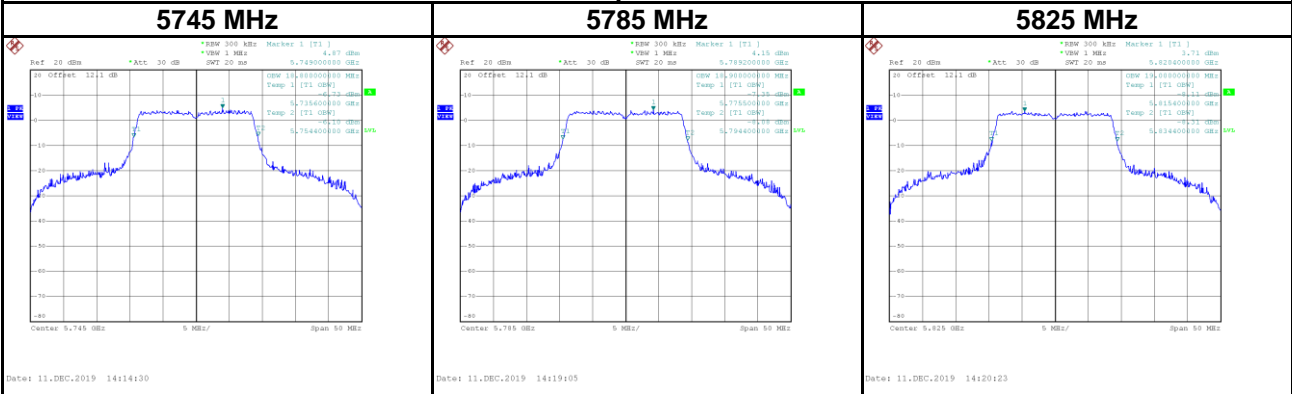

Test Mode	IEEE 802.11n (HT40)
Test Voltage	DC 48V

Frequency (MHz)	26dB Bandwidth (MHz)	99% Occupied Bandwidth (MHz)
5190	50.80	37.60
5230	88.00	41.80

26 dB Bandwidth

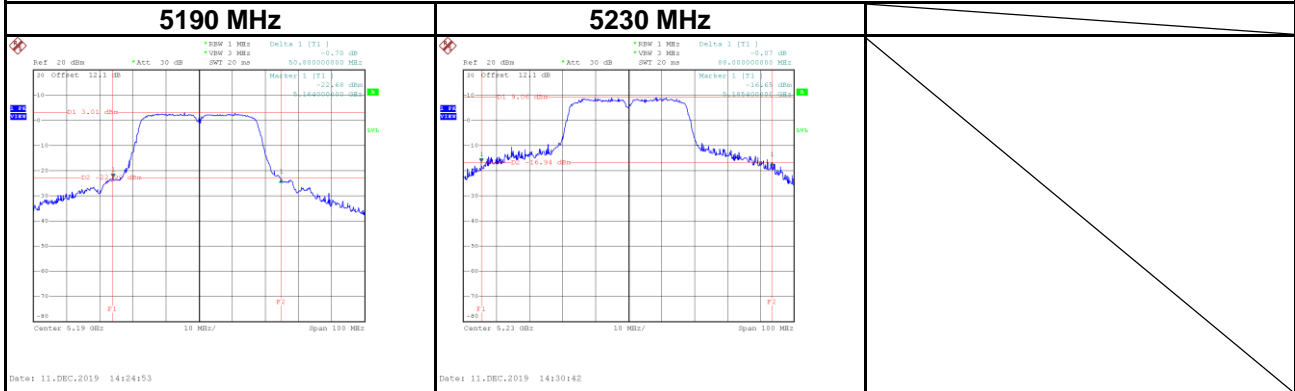

99 % Occupied Bandwidth

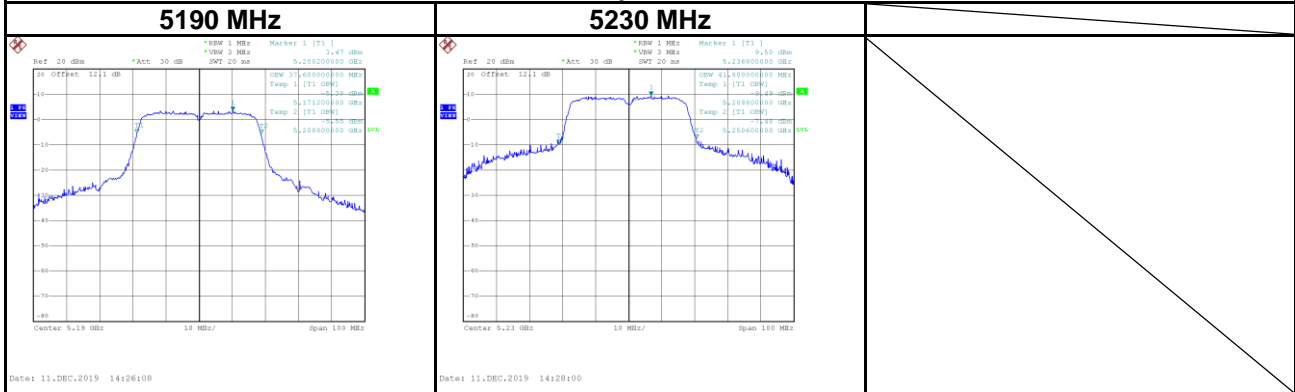

Frequency (MHz)	6dB Bandwidth (MHz)	99 % Occupied Bandwidth (MHz)	6 dB Bandwidth Limit (kHz)	Result
5755	35.80	39.20	500	Complies
5795	35.60	38.80	500	Complies

6 dB Bandwidth

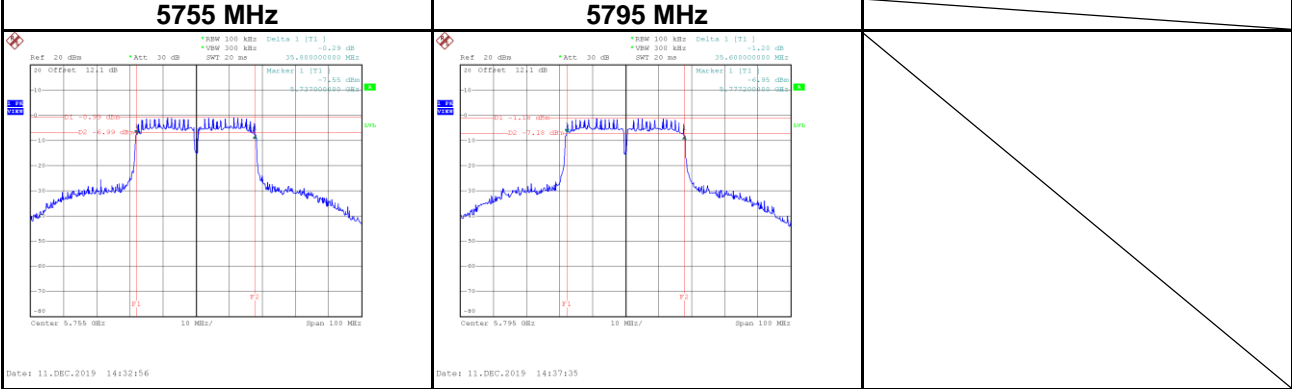

99 % Occupied Bandwidth

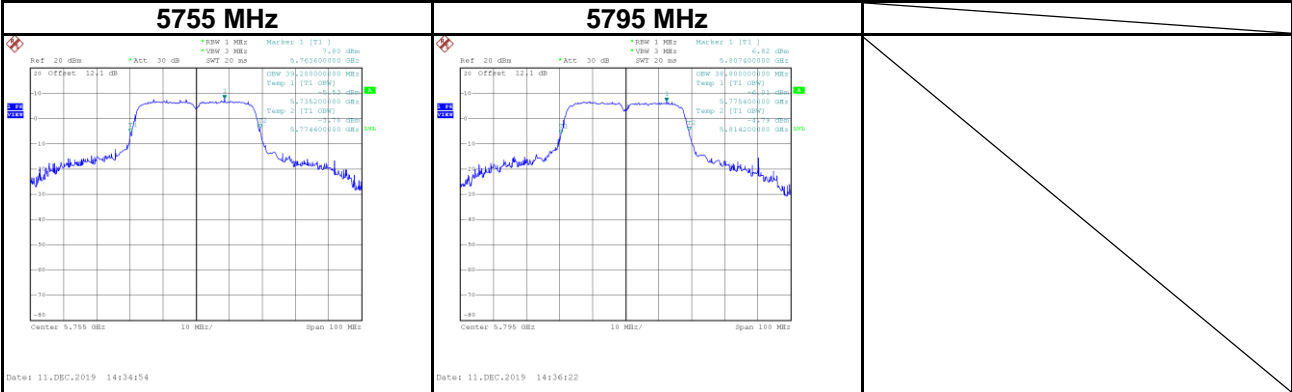

Test Mode	IEEE 802.11ac (VHT80)
Test Voltage	DC 48V

Frequency (MHz)	26dB Bandwidth (MHz)	99% Occupied Bandwidth (MHz)
5210	86.40	75.20

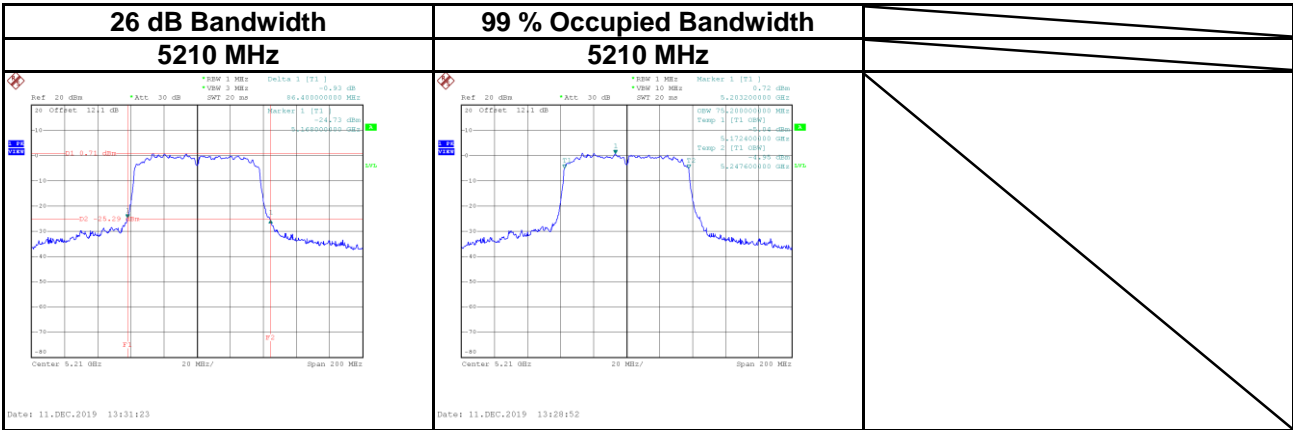

Frequency (MHz)	6dB Bandwidth (MHz)	99 % Occupied Bandwidth (MHz)	6 dB Bandwidth Limit (kHz)	Result
5775	76.00	76.80	500	Complies

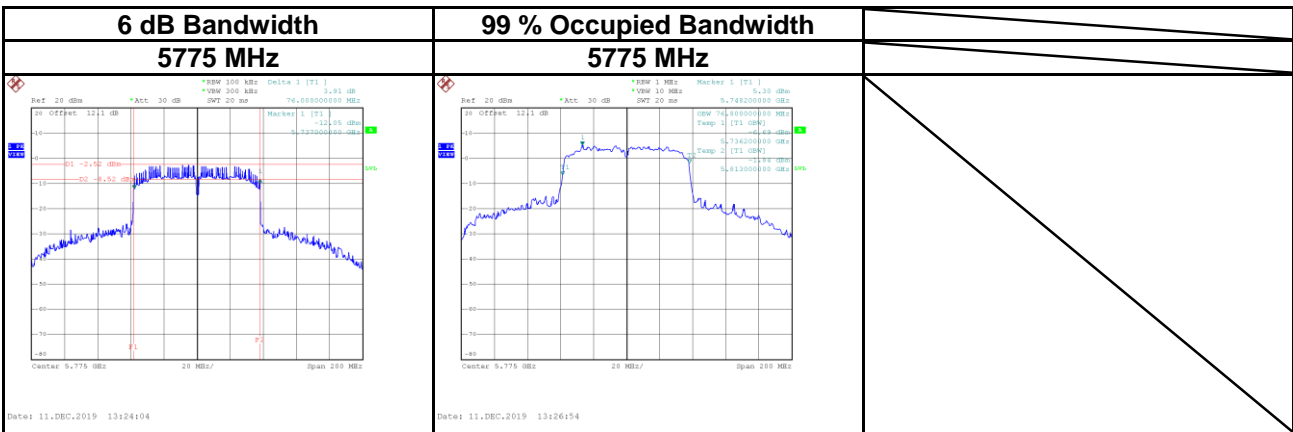

APPENDIX E CONDUCTED OUTPUT POWER

Test Mode	IEEE 802.11a	Tested Date	2020/1/2
Test Voltage	DC 48V		

Frequency (MHz)	Average Power (dBm)	Average Power (W)	Max. Limit (dBm)	Max. Limit (W)	Result
5180	12.32	0.0171	24.00	0.2512	Complies
5200	13.76	0.0238	24.00	0.2512	Complies
5240	13.65	0.0232	24.00	0.2512	Complies

Frequency (MHz)	Conducted Power (dBm)	Conducted Power (W)	Max. Limit (dBm)	Max. Limit (W)	Result
5745	19.05	0.0804	30.00	1.0000	Complies
5785	19.16	0.0824	30.00	1.0000	Complies
5825	18.95	0.0785	30.00	1.0000	Complies

Test Mode	IEEE 802.11n (HT20)	Tested Date	2020/1/2
Test Voltage	DC 48V		

Frequency (MHz)	Average Power (dBm)	Average Power (W)	Max. Limit (dBm)	Max. Limit (W)	Result
5180	12.75	0.0188	24.00	0.2512	Complies
5200	13.72	0.0236	24.00	0.2512	Complies
5240	13.73	0.0236	24.00	0.2512	Complies

Frequency (MHz)	Conducted Power (dBm)	Conducted Power (W)	Max. Limit (dBm)	Max. Limit (W)	Result
5745	19.03	0.0800	30.00	1.0000	Complies
5785	18.98	0.0791	30.00	1.0000	Complies
5825	18.88	0.0773	30.00	1.0000	Complies

Test Mode	IEEE 802.11n (HT40)	Tested Date	2020/1/2
Test Voltage	DC 48V		

Frequency (MHz)	Average Power (dBm)	Average Power (W)	Max. Limit (dBm)	Max. Limit (W)	Result
5190	8.13	0.0065	24.00	0.2512	Complies
5230	13.54	0.0226	24.00	0.2512	Complies

Frequency (MHz)	Conducted Power (dBm)	Conducted Power (W)	Max. Limit (dBm)	Max. Limit (W)	Result
5755	18.96	0.0787	30.00	1.0000	Complies
5795	19.09	0.0811	30.00	1.0000	Complies

Test Mode	IEEE 802.11ac (VHT20)	Tested Date	2020/1/2
Test Voltage	DC 48V		

Frequency (MHz)	Average Power (dBm)	Average Power (W)	Max. Limit (dBm)	Max. Limit (W)	Result
5180	12.29	0.0169	24.00	0.2512	Complies
5200	13.58	0.0228	24.00	0.2512	Complies
5240	13.63	0.0231	24.00	0.2512	Complies

Frequency (MHz)	Conducted Power (dBm)	Conducted Power (W)	Max. Limit (dBm)	Max. Limit (W)	Result
5745	18.95	0.0785	30.00	1.0000	Complies
5785	18.94	0.0783	30.00	1.0000	Complies
5825	18.91	0.0778	30.00	1.0000	Complies

Test Mode	IEEE 802.11ac (VHT40)	Tested Date	2020/1/2
Test Voltage	DC 48V		

Frequency (MHz)	Average Power (dBm)	Average Power (W)	Max. Limit (dBm)	Max. Limit (W)	Result
5190	8.11	0.0065	24.00	0.2512	Complies
5230	13.26	0.0212	24.00	0.2512	Complies

Frequency (MHz)	Conducted Power (dBm)	Conducted Power (W)	Max. Limit (dBm)	Max. Limit (W)	Result
5755	18.86	0.0769	30.00	1.0000	Complies
5795	18.72	0.0745	30.00	1.0000	Complies

Test Mode	IEEE 802.11ac (VHT80)	Tested Date	2020/1/2
Test Voltage	DC 48V		

Frequency (MHz)	Average Power (dBm)	Average Power (W)	Max. Limit (dBm)	Max. Limit (W)	Result
5210	8.06	0.0064	24.00	0.2512	Complies

Frequency (MHz)	Conducted Power (dBm)	Conducted Power (W)	Max. Limit (dBm)	Max. Limit (W)	Result
5775	18.51	0.0710	30.00	1.0000	Complies

APPENDIX F POWER SPECTRAL DENSITY

Test Mode	IEEE 802.11a
Test Voltage	DC 48V

Frequency (MHz)	Power Density (dBm/MHz)	Duty Factor (dB)	Power Density+ Duty Factor (dBm/MHz)	Limit (dBm/MHz)	Result
5180	1.21	0.08	1.29	11.00	Complies
5200	2.68	0.08	2.76	11.00	Complies
5240	2.42	0.08	2.50	11.00	Complies

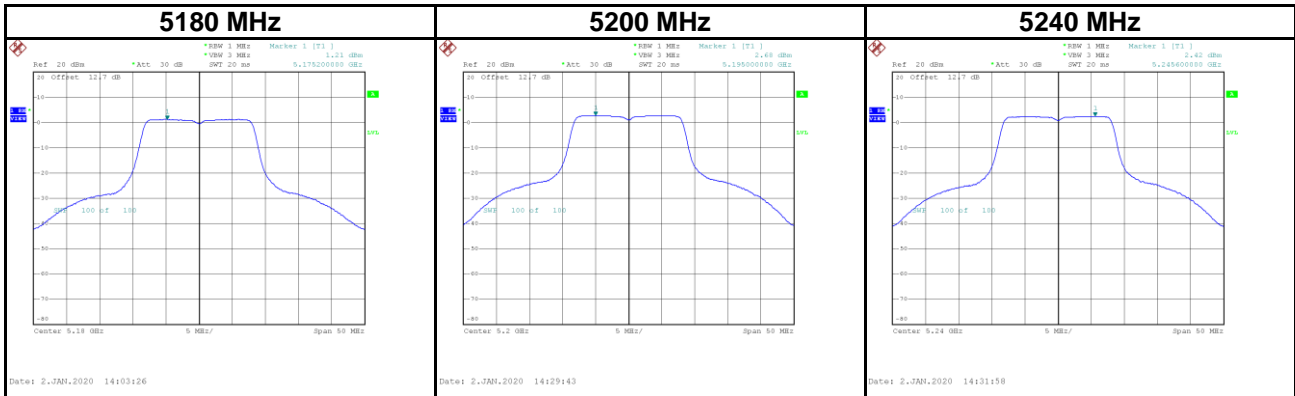

Frequency (MHz)	Power Density (dBm/1MHz)	Power Density (dBm/500KHz)	Duty Factor (dB)	Power Density+ Duty Factor (dBm/500 kHz)	Limit (dBm/500 kHz)	Result
5745	-2.36	-5.37	0.08	-5.29	30.00	Complies
5785	-2.14	-5.15	0.08	-5.07	30.00	Complies
5825	-2.36	-5.37	0.08	-5.29	30.00	Complies

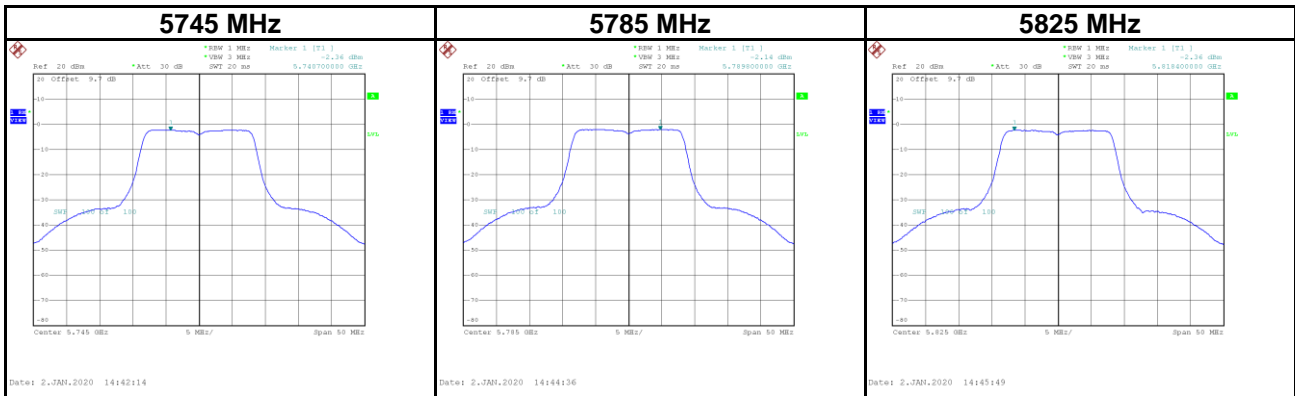

Test Mode	IEEE 802.11n (HT20)
Test Voltage	DC 48V

Frequency (MHz)	Power Density (dBm/500 kHz)	Duty Factor (dB)	Power Density+ Duty Factor (dBm/500 kHz)	Limit (dBm/500 kHz)	Result
5180	1.33	0.07	1.40	11.00	Complies
5200	2.38	0.07	2.45	11.00	Complies
5240	2.31	0.07	2.38	11.00	Complies

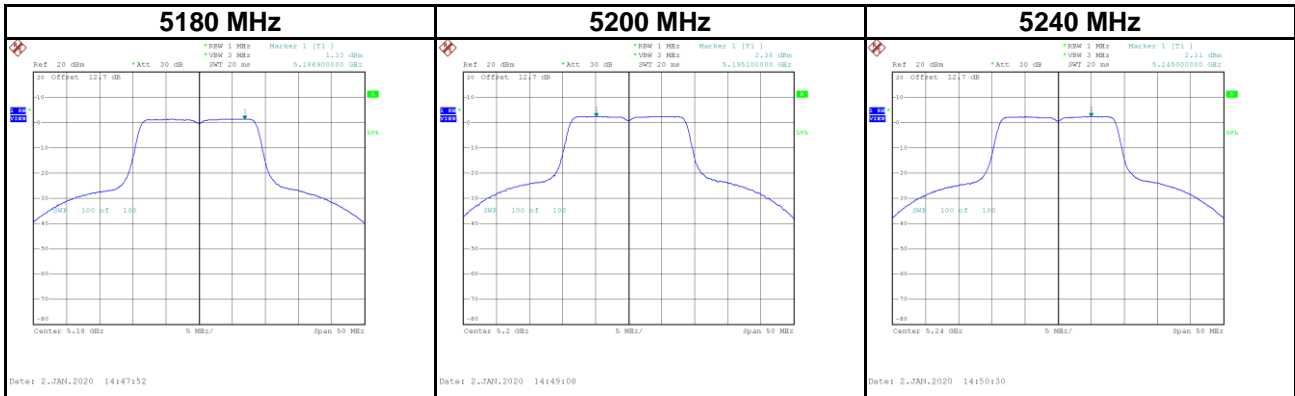

Frequency (MHz)	Power Density (dBm/1MHz)	Power Density (dBm/500KHz)	Duty Factor (dB)	Power Density+ Duty Factor (dBm/500 kHz)	Limit (dBm/500 kHz)	Result
5745	-2.51	-5.52	0.07	-5.45	30.00	Complies
5785	-2.40	-5.41	0.07	-5.34	30.00	Complies
5825	-2.55	-5.56	0.07	-5.49	30.00	Complies

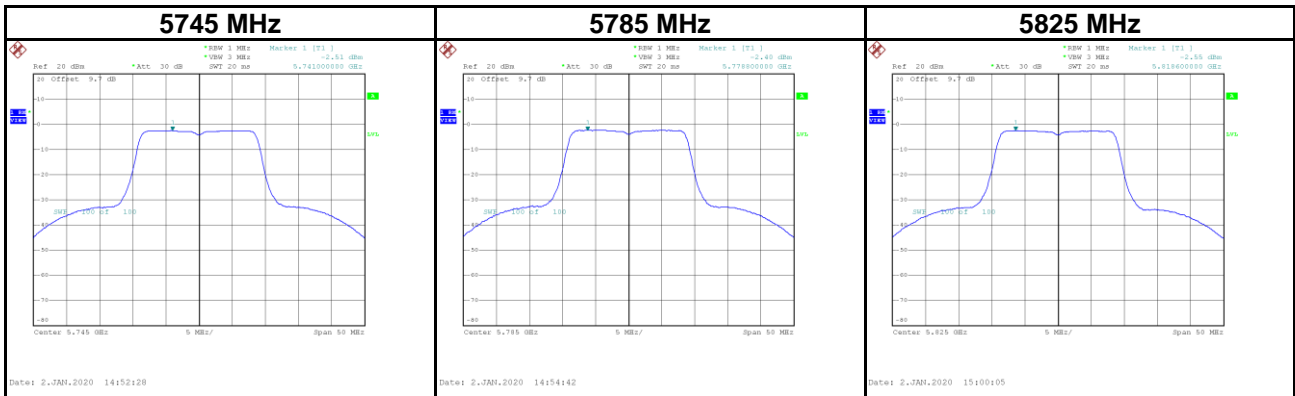

Test Mode	IEEE 802.11n (HT40)
Test Voltage	DC 48V

Frequency (MHz)	Power Density (dBm/MHz)	Duty Factor (dB)	Power Density+ Duty Factor (dBm/MHz)	Limit (dBm/MHz)	Result
5190	-5.91	0.17	0.27	11.00	Complies
5230	-0.57	0.17	0.91	11.00	Complies

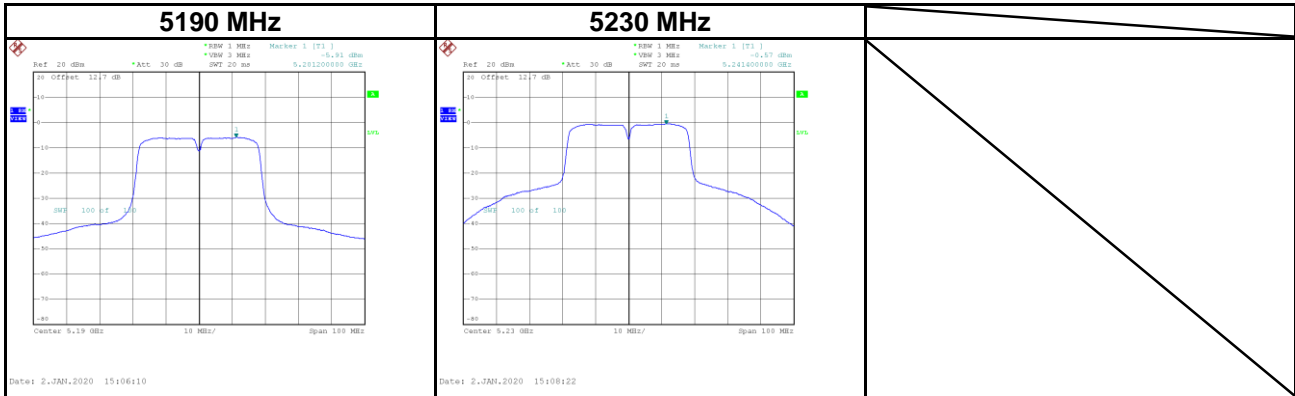

Frequency (MHz)	Power Density (dBm/1MHz)	Power Density (dBm/500KHz)	Duty Factor (dB)	Power Density+ Duty Factor (dBm/500 kHz)	Limit (dBm/500 kHz)	Result
5755	-4.99	-8.00	0.17	-7.83	30.00	Complies
5795	-5.16	-8.17	0.17	-8.00	30.00	Complies

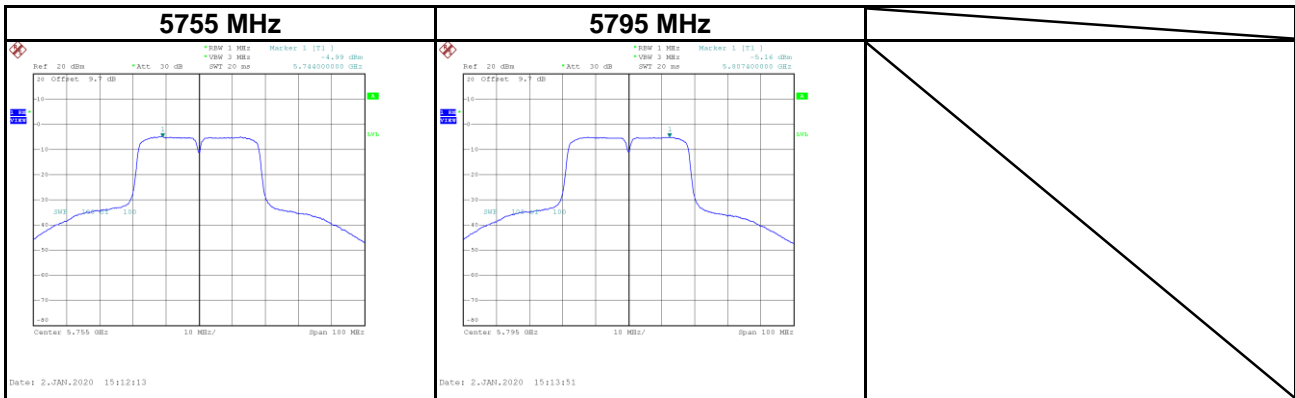

Test Mode	IEEE 802.11ac (VHT80)
Test Voltage	DC 48V

Frequency (MHz)	Power Density (dBm/MHz)	Duty Factor (dB)	Power Density+ Duty Factor (dBm/MHz)	Limit (dBm/MHz)	Result
5210	-8.92	0.33	-8.59	11.00	Complies

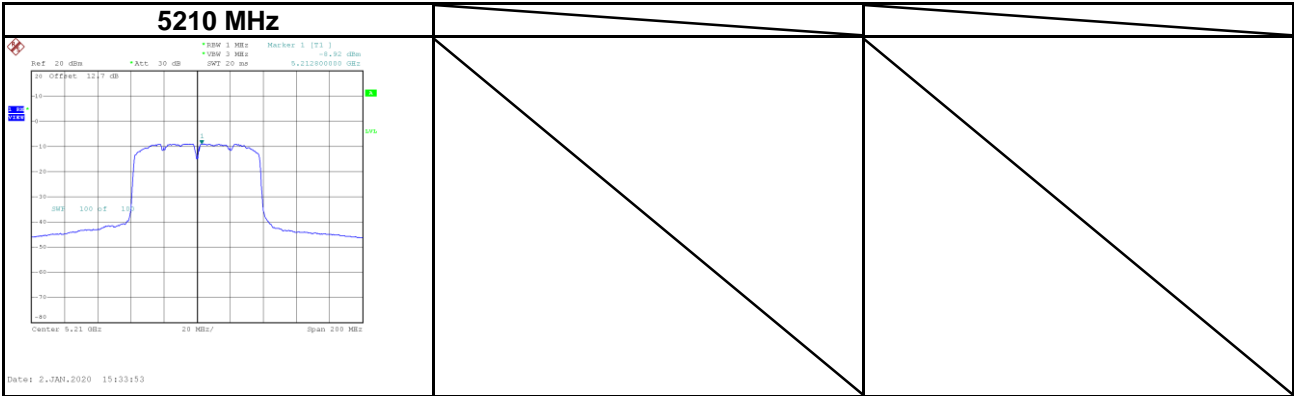

Frequency (MHz)	Power Density (dBm/1MHz)	Power Density (dBm/500KHz)	Duty Factor (dB)	Power Density+ Duty Factor (dBm/500 kHz)	Limit (dBm/500 kHz)	Result
5775	-7.41	-10.42	0.33	-10.09	30.00	Complies

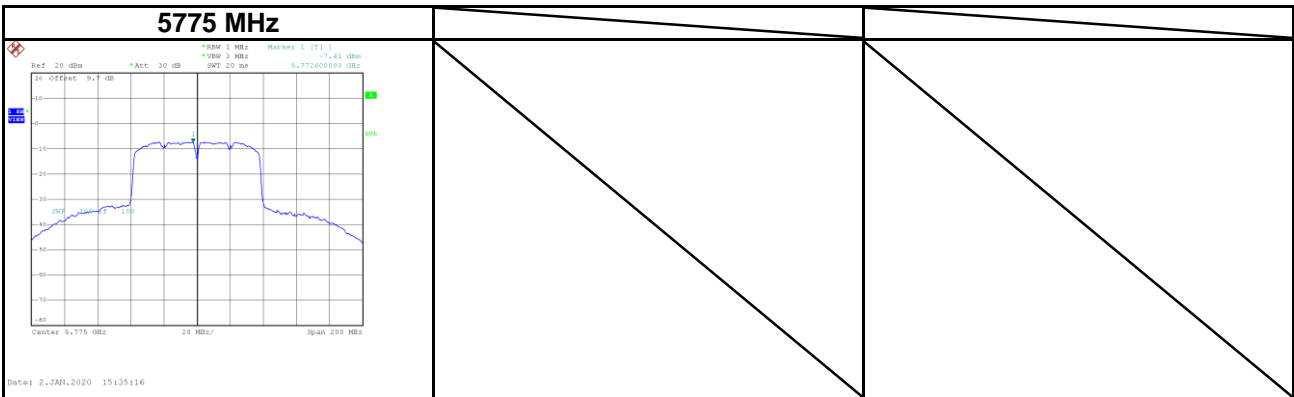

End of Test Report