

FCC Radio Test Report

FCC ID: EROTSW1070

Report No. : BTL-FCCP-1-1911T046
Equipment : 10.1 inch Touch Screen wall mount
Model Name : M201923003, TSW-1070-B-S, TSW-1070-W-S, TSW-1070P-B-S,
TSW-1070P-W-S, TSS-1070-B-S, TSS-1070-W-S
Brand Name : CRESTRON
Applicant : Crestron Electronics, Inc.
Address : 15 Volvo Drive, Rockleigh, NJ 07647

Radio Function : Bluetooth EDR

FCC Rule Part(s) : FCC Part15, Subpart C (15.247)
Measurement Procedure(s) : ANSI C63.10-2013

Date of Receipt : 2018/11/28
Date of Test : 2018/11/28 ~ 2019/12/18
Issued Date : 2020/3/24

The above equipment has been tested and found in compliance with the requirement of the above standards by BTL Inc.

Prepared by :

Peter Chen, Engineer

**Approved by** :

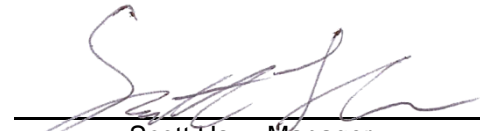
Scott Hsu, Manager

BTL Inc.

No.18, Ln. 171, Sec. 2, Jiuzong Rd., Neihu Dist., Taipei City 114, Taiwan

Tel: +886-2-2657-3299

Fax: +886-2-2657-3331

Web: www.newbtl.com

Declaration

BTL represents to the client that testing is done in accordance with standard procedures as applicable and that test instruments used has been calibrated with standards traceable to international standard(s) and/or national standard(s).

BTL's reports apply only to the specific samples tested under conditions. It is manufacture's responsibility to ensure that additional production units of this model are manufactured with the identical electrical and mechanical components. **BTL** shall have no liability for any declarations, inferences or generalizations drawn by the client or others from **BTL** issued reports.

The report must not be used by the client to claim product certification, approval, or endorsement by NIST, A2LA, or any agency of the U.S. Government.

This report is the confidential property of the client. As a mutual protection to the clients, the public and ourselves, the test report shall not be reproduced, except in full, without our written approval.

BTL's laboratory quality assurance procedures are in compliance with the **ISO/IEC 17025** requirements, and accredited by the conformity assessment authorities listed in this test report.

BTL is not responsible for the sampling stage, so the results only apply to the sample as received.

The information, data and test plan are provided by manufacturer which may affect the validity of results, so it is manufacturer's responsibility to ensure that the apparatus meets the essential requirements of applied standards and in all the possible configurations as representative of its intended use.

Limitation

For the use of the authority's logo is limited unless the Test Standard(s)/Scope(s)/Item(s) mentioned in this test report is (are) included in the conformity assessment authorities acceptance respective.

Please note that the measurement uncertainty is provided for informational purpose only and are not use in determining the Pass/Fail results.

CONTENTS

REPORT ISSUED HISTORY	5
1 SUMMARY OF TEST RESULTS	6
1.1 TEST FACILITY	7
1.2 MEASUREMENT UNCERTAINTY	7
1.3 TEST ENVIRONMENT CONDITIONS	8
1.4 TABLE OF PARAMETERS OF TEXT SOFTWARE SETTING	8
1.5 DUTY CYCLE	9
2 GENERAL INFORMATION	10
2.1 DESCRIPTION OF EUT	10
2.2 TEST MODES	12
2.3 BLOCK DIAGRAM SHOWING THE CONFIGURATION OF SYSTEM TESTED	13
2.4 SUPPORT UNITS	13
3 RADIATED EMISSIONS TEST	14
3.1 LIMIT	14
3.2 TEST PROCEDURE	15
3.3 DEVIATION FROM TEST STANDARD	15
3.4 TEST SETUP	15
3.5 EUT OPERATING CONDITIONS	16
3.6 TEST RESULT – 9 KHZ TO 30 MHZ	17
3.7 TEST RESULT – 30 MHZ TO 1 GHZ	17
3.8 TEST RESULT – ABOVE 1 GHZ	17
4 NUMBER OF HOPPING CHANNEL	18
4.1 APPLIED PROCEDURES	18
4.2 TEST PROCEDURE	18
4.3 DEVIATION FROM STANDARD	18
4.4 TEST SETUP	18
4.5 EUT OPERATION CONDITIONS	18
4.6 TEST RESULTS	18
5 AVERAGE TIME OF OCCUPANCY	19
5.1 APPLIED PROCEDURES / LIMIT	19
5.2 TEST PROCEDURE	19
5.3 DEVIATION FROM STANDARD	19
5.4 TEST SETUP	19
5.5 EUT OPERATION CONDITIONS	19
5.6 TEST RESULTS	19
6 HOPPING CHANNEL SEPARATION MEASUREMENT	20
6.1 APPLIED PROCEDURES / LIMIT	20
6.2 TEST PROCEDURE	20
6.3 DEVIATION FROM STANDARD	20
6.4 TEST SETUP	20
6.5 TEST RESULTS	20
7 BANDWIDTH TEST	21
7.1 APPLIED PROCEDURES	21
7.2 TEST PROCEDURE	21
7.3 DEVIATION FROM STANDARD	21
7.4 TEST SETUP	21
7.5 EUT OPERATION CONDITIONS	21

7.6	TEST RESULTS	21
8	OUTPUT POWER TEST	22
8.1	APPLIED PROCEDURES / LIMIT	22
8.2	TEST PROCEDURE	22
8.3	DEVIATION FROM STANDARD	22
8.4	TEST SETUP	22
8.5	EUT OPERATION CONDITIONS	22
8.6	TEST RESULTS	22
9	ANTENNA CONDUCTED SPURIOUS EMISSION	23
9.1	APPLIED PROCEDURES / LIMIT	23
9.2	TEST PROCEDURE	23
9.3	DEVIATION FROM STANDARD	23
9.4	TEST SETUP	23
9.5	EUT OPERATION CONDITIONS	23
9.6	TEST RESULTS	23
10	LIST OF MEASURING EQUIPMENTS	24
11	EUT TEST PHOTO	26
12	EUT PHOTOS	26
APPENDIX A	RADIATED EMISSIONS - 9 KHZ TO 30 MHZ	27
APPENDIX B	RADIATED EMISSIONS - 30 MHZ TO 1 GHZ	32
APPENDIX C	RADIATED EMISSIONS - ABOVE 1 GHZ	35
APPENDIX D	NUMBER OF HOPPING CHANNEL	52
APPENDIX E	AVERAGE TIME OF OCCUPANCY	54
APPENDIX F	HOPPING CHANNEL SEPARATION MEASUREMENT	57
APPENDIX G	BANDWIDTH	60
APPENDIX H	OUTPUT POWER	63
APPENDIX I	ANTENNA CONDUCTED SPURIOUS EMISSION	65

REPORT ISSUED HISTORY

Report Version	Description	Issued Date
R00	Original Issue.	2020/1/21
R01	Revised report to address TCB's comments.	2020/3/24

1 SUMMARY OF TEST RESULTS

Test procedures according to the technical standards.

FCC Part 15, Subpart C (15.247)				
Standard(s) Section	Description	Test Result	Judgement	Remark
15.207	AC Power Line Conducted Emissions	-----	N/A	NOTE(3)
15.205 15.209 15.247(d)	Radiated Emissions	APPENDIX A APPENDIX B APPENDIX C	Pass	-----
15.247 (a)(1)(iii)	Number of Hopping Frequency	APPENDIX D	Pass	-----
15.247 (a)(1)(iii)	Average Time of Occupancy	APPENDIX E	Pass	-----
15.247 (a)(1)	Hopping Channel Separation	APPENDIX F	Pass	-----
15.247 (a)(1)	Bandwidth	APPENDIX G	Pass	-----
15.247 (b)(1)	Output Power	APPENDIX H	Pass	-----
15.247(d)	Antenna conducted Spurious Emission	APPENDIX I	Pass	-----
15.203	Antenna Requirement	-----	Pass	-----

NOTE:

- (1) "N/A" denotes test is not applicable in this Test Report.
- (2) The report format version is TP.1.1.1.
- (3) Input power is supplied by POE.

1.1 TEST FACILITY

The test facilities used to collect the test data in this report:

No. 68-1, Ln. 169, Sec. 2, Datong Rd., Xizhi Dist., New Taipei City 221, Taiwan

The test sites and facilities are covered under FCC RN: 355421 and DN: TW1099.

- C05 CB08 CB11 CB15 CB16
 SR06

No.18, Ln. 171, Sec. 2, Jiuzong Rd., Neihu Dist., Taipei City 114, Taiwan

The test sites and facilities are covered under FCC RN: 325517 and DN: TW1115.

- C03 CB18 CB19

1.2 MEASUREMENT UNCERTAINTY

The reported uncertainty of measurement $y \pm U$, where expanded uncertainty U is based on a standard uncertainty multiplied by a coverage factor of $k = 2$, providing a level of confidence of approximately **95 %**.

The measurement instrumentation uncertainty considerations contained in CISPR 16-4-2. The BTL measurement uncertainty is less than the CISPR 16-4-2 U_{cispr} requirement.

A. Radiated emissions below 1 GHz test :

Test Site	Method	Measurement Frequency Range	Ant. H / V	U,(dB)
CB18 (3m)	CISPR	30MHz ~ 200MHz	V	4.20
		30MHz ~ 200MHz	H	3.64
		200MHz ~ 1,000MHz	V	4.56
		200MHz ~ 1,000MHz	H	3.90

B. Radiated emissions above 1 GHz test :

Test Site	Method	Measurement Frequency Range	Ant. H / V	U,(dB)
CB18 (3m)	CISPR	1GHz ~ 6GHz	V	4.46
		1GHz ~ 6GHz	H	4.40
		6GHz ~ 18GHz	V	3.88
		6GHz ~ 18GHz	H	4.00

Test Site	Method	Measurement Frequency Range	U,(dB)
CB18 (1m)	CISPR	18 ~ 26.5 GHz	4.62
		26.5 ~ 40 GHz	5.12

C. Conducted test :

Test Item	U,(dB)
Number of Hopping Frequency	0.00
Average Time of Occupancy	1.20
Hopping Channel Separation	1.20
Bandwidth	1.13
Peak Output Power	1.06
Antenna conducted Spurious Emission	1.14
Conducted Band edges	1.13

NOTE:

Unless specifically mentioned, the uncertainty of measurement has not been taken into account to declare the compliance or non-compliance to the specification.

1.3 TEST ENVIRONMENT CONDITIONS

Test Item	Environment Condition	Tested by
Radiated emissions below 1 GHz	23 °C, 65 %	Hunter Chiang
Radiated emissions above 1 GHz	23 °C, 65 %	Hunter Chiang
Number of Hopping Frequency	24.5 °C, 54.3 %	Jay Kao
Average Time of Occupancy	24.5 °C, 54.3 %	Jay Kao
Hopping Channel Separation	24.5 °C, 54.3 %	Jay Kao
Bandwidth	24.5 °C, 54.3 %	Jay Kao
Output Power	24.5 °C, 54.3 %	Jay Kao
Antenna conducted Spurious Emission	24.5 °C, 54.3 %	Jay Kao

1.4 TABLE OF PARAMETERS OF TEXT SOFTWARE SETTING

Test Software	QRCT 4			
Modulation Mode	2402 MHz	2441 MHz	2480 MHz	Data Rate
GFSK	7	7	7	1 Mbps
$\pi/4$ -DQPSK	8	8	8	2 Mbps
8DPSK	8	8	8	3 Mbps

1.5 DUTY CYCLE

If duty cycle is $\geq 98\%$, duty factor is not required.
 If duty cycle is $< 98\%$, duty factor shall be considered.

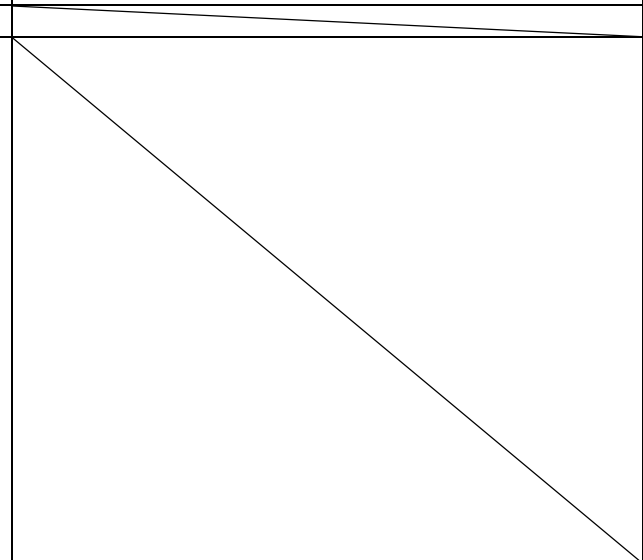
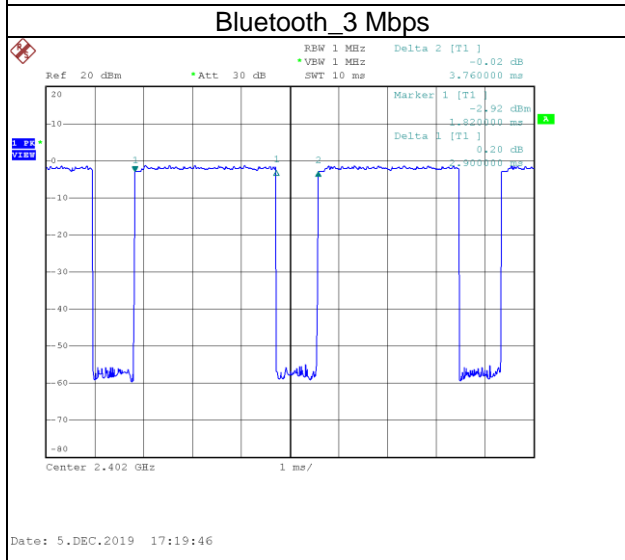
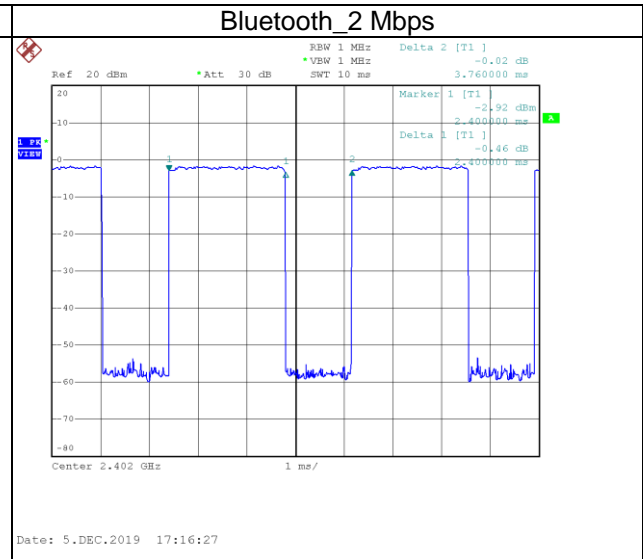
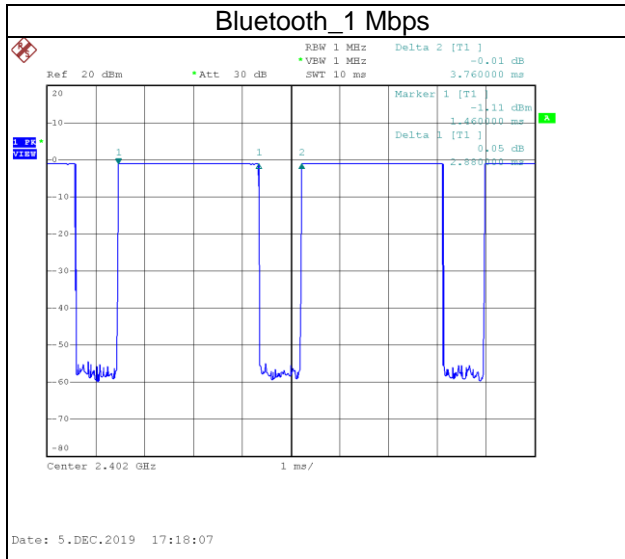

Remark	Delta 1			Delta 2	On Time/Period	10 log(1/Duty Cycle)
Mode	ON (ms)	Numbers (ON)	On Time (B) (ms)	Period (ON+OFF) (ms)	Duty Cycle (%)	Duty Factor (dB)
BT (1 Mbps)	2.880	1	2.880	3.760	76.60%	1.16
BT (2 Mbps)	2.400	1	2.400	3.760	63.83%	1.95
BT (3 Mbps)	2.900	1	2.900	3.760	77.13%	1.13

2 GENERAL INFORMATION

2.1 DESCRIPTION OF EUT

Equipment	10.1 inch Touch Screen wall mount
Model Name	M201923003, TSW-1070-B-S, TSW-1070-W-S, TSW-1070P-B-S, TSW-1070P-W-S, TSS-1070-B-S, TSS-1070-W-S
Brand Name	CRESTRON
Model Difference	M201923003 includes six series: TSW-1070-B-S, TSW-1070-W-S, TSW-1070P-B-S, TSW-1070P-W-S, TSS-1070-B-S, TSS-1070-W-S All modes are identical to each other except below: B: Black, W: White, P: Portrait, S: Smooth, TSS: Touch Screen Scheduling
Power Source	DC voltage supplied from POE.
Power Rating	I/P: 48 VDC 350mA (802.3at type 1), 48 VDC 600mA (802.3at type 2)
Products Covered	N/A
Frequency Range	2400 MHz ~ 2483.5 MHz
Operation Frequency	2402 MHz ~ 2480 MHz
Modulation Type	GFSK, $\pi/4$ -DQPSK, 8DPSK
Modulation Technology	FHSS
Transfer Rate	1/2/3Mbps
Output Power Max.	1 Mbps: 1.08 dBm (0.0013 W) 2 Mbps: 5.31 dBm (0.0034 W) 3 Mbps: 5.55 dBm (0.0036 W)
Test Model	M201923003
Sample Status	Engineering Sample
EUT Modification(s)	N/A

NOTE:

- (1) For a more detailed features description, please refer to the manufacturer's specifications or the user's manual.

(2) Channel List:

Channel	Frequency (MHz)	Channel	Frequency (MHz)	Channel	Frequency (MHz)
00	2402	27	2429	54	2456
01	2403	28	2430	55	2457
02	2404	29	2431	56	2458
03	2405	30	2432	57	2459
04	2406	31	2433	58	2460
05	2407	32	2434	59	2461
06	2408	33	2435	60	2462
07	2409	34	2436	61	2463
08	2410	35	2437	62	2464
09	2411	36	2438	63	2465
10	2412	37	2439	64	2466
11	2413	38	2440	65	2467
12	2414	39	2441	66	2468
13	2415	40	2442	67	2469
14	2416	41	2443	68	2470
15	2417	42	2444	69	2471
16	2418	43	2445	70	2472
17	2419	44	2446	71	2473
18	2420	45	2447	72	2474
19	2421	46	2448	73	2475
20	2422	47	2449	74	2476
21	2423	48	2450	75	2477
22	2424	49	2451	76	2478
23	2425	50	2452	77	2479
24	2426	51	2453	78	2480
25	2427	52	2454		
26	2428	53	2455		

(3) Table for Filed Antenna:

Ant.	Brand	Test Model	Antenna Type	Connector	Gain (dBi)
1	YAGEO	TSW WLAN MAIN	PIFA	IPEX	-3.92

2.2 TEST MODES

Test Items	Test mode	Channel	Note
Transmitter Radiated Emissions (below 1GHz)	1 Mbps	00	-
Transmitter Radiated Emissions (above 1GHz)	1/3 Mbps	00/78	Bandedge
	1/3 Mbps	00/39/78	Harmonic
Number of Hopping Frequency	1/3 Mbps	00~78	-
Average Time of Occupancy	1/3 Mbps	00/39/78	-
Hopping Channel Separation	1/3 Mbps	00/39/78	-
Bandwidth	1/3 Mbps	00/39/78	-
Peak Output Power	1/2/3 Mbps	00/39/78	-
Antenna conducted Spurious Emission	1/3 Mbps	00/39/78	-

NOTE:

- (1) The Radiated emissions test was verified based on the worst conducted power and Bandwidth test results reported in the original report.
- (2) For radiated emission band edge test, both Vertical and Horizontal are evaluated, but only the worst case (Horizontal) is recorded.
- (3) All X, Y and Z axes are evaluated, but only the worst case (Y axis) is recorded.

2.3 BLOCK DIAGRAM SHOWING THE CONFIGURATION OF SYSTEM TESTED

Equipment letters and Cable numbers refer to item numbers described in the tables of clause 2.4.

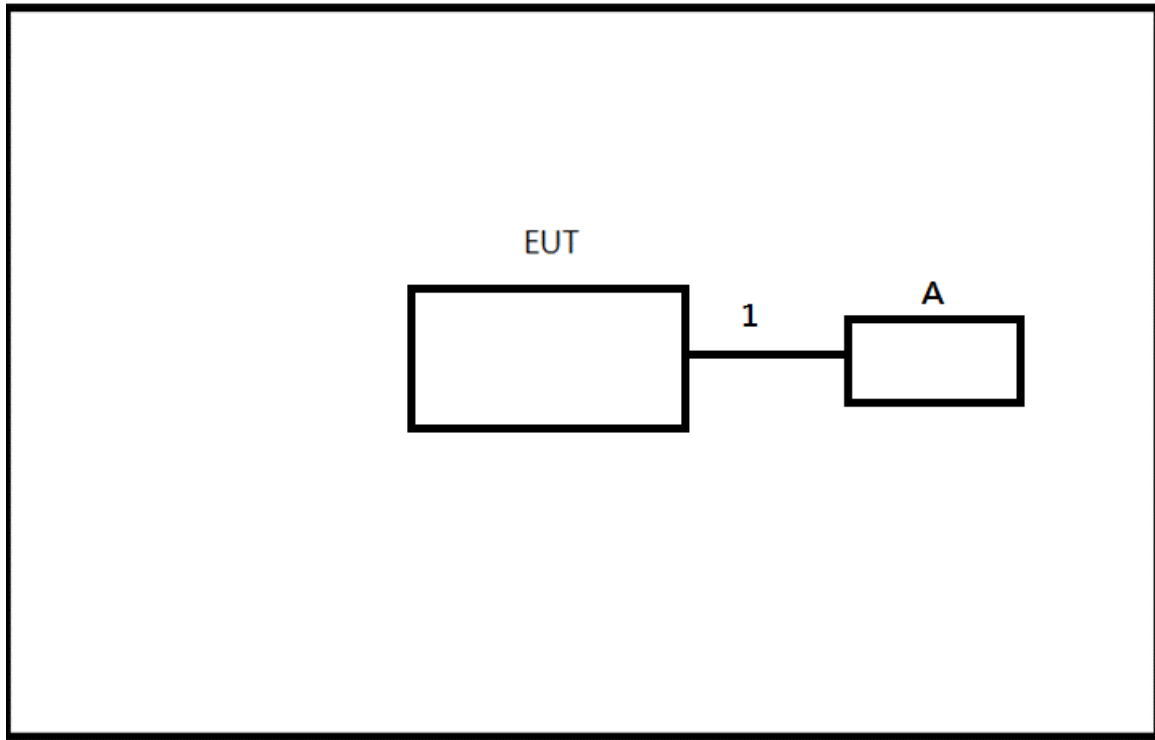

2.4 SUPPORT UNITS

Item	Equipment	Brand	Model No.	Series No.	Remarks
A	MANAGED POE SWITCH	CRESTRON	CEN-SWPOE-16	N/A	-

Item	Shielded	Ferrite Core	Length	Cable Type	Remarks
1	NO	NO	3m	LAN Cable	-

3 RADIATED EMISSIONS TEST

3.1 LIMIT

In case the emission fall within the restricted band specified on 15.205, then the 15.209 limit in the table below has to be followed.

LIMITS OF RADIATED EMISSIONS MEASUREMENT (9 kHz to 1000 MHz)

Frequency (MHz)	Field Strength (microvolts/meter)	Measurement Distance (meters)
0.009~0.490	2400/F(KHz)	300
0.490~1.705	24000/F(KHz)	30
1.705~30.0	30	30
30~88	100	3
88~216	150	3
216~960	200	3
960~1000	500	3

LIMITS OF RADIATED EMISSIONS MEASUREMENT (Above 1000 MHz)

Frequency (MHz)	Radiated Emissions (dBuV/m)		Measurement Distance (meters)
	Peak	Average	
Above 1000	74	54	3

NOTE:

- (1) The limit for radiated test was performed according to FCC Part 15, Subpart C.
- (2) The tighter limit applies at the band edges.
- (3) Emission level (dBuV/m)=20log Emission level (uV/m).
- (4) The test result calculated as following:

Measurement Value = Reading Level + Correct Factor

Correct Factor = Antenna Factor + Cable Loss - Amplifier Gain(if use)

Margin Level = Measurement Value - Limit Value

Calculation example:

Reading Level		Correct Factor		Measurement Value
19.11	+	2.11	=	21.22

Measurement Value		Limit Value		Margin Level
21.22	-	54	=	-32.78

Spectrum Parameter	Setting
Attenuation	Auto
Start Frequency	1000 MHz
Stop Frequency	10th carrier harmonic
RBW / VBW (Emission in restricted band)	1MHz / 3MHz for Peak, 1MHz / 1/T for Average

Spectrum Parameter	Setting
Attenuation	Auto
Start ~ Stop Frequency	9KHz~90KHz for PK/AVG detector
Start ~ Stop Frequency	90KHz~110KHz for QP detector
Start ~ Stop Frequency	110KHz~490KHz for PK/AVG detector
Start ~ Stop Frequency	490KHz~30MHz for QP detector
Start ~ Stop Frequency	30MHz~1000MHz for QP detector

3.2 TEST PROCEDURE

- a. The measuring distance of 3 m shall be used for measurements. The EUT was placed on the top of a rotating table 0.8 meter above the ground at a 3 meter semi-anechoic chamber. The table was rotated 360 degrees to determine the position of the highest radiation.(below 1GHz)
- b. The measuring distance of 3 m shall be used for measurements. The EUT was placed on the top of a rotating table 1.5 meter above the ground at a 3 meter semi-anechoic chamber. The table was rotated 360 degrees to determine the position of the highest radiation.(above 1GHz)
- c. The height of the equipment or of the substitution antenna shall be 0.8 m or 1.5 m, the height of the test antenna shall vary between 1 m to 4 m. Both horizontal and vertical polarizations of the antenna are set to make the measurement.
- d. For each suspected emission, the EUT was arranged to its worst case and then the antenna was tuned to heights find the maximum reading (used Bore sight function).
- e. The receiver system was set to peak and average detect function and specified bandwidth with maximum hold mode when the test frequency is above 1GHz.
- f. The initial step in collecting radiated emission data is a receiver peak detector mode pre-scanning the measurement frequency range. Significant peaks are then marked and then Quasi Peak detector mode re-measured.
- g. All readings are Peak unless otherwise stated QP in column of Note. Peak denotes that the Peak reading compliance with the QP Limits and then QP Mode measurement didn't perform. (below 1GHz)
- h. All readings are Peak Mode value unless otherwise stated AVG in column of Note. If the Peak Mode Measured value compliance with the Peak Limits and lower than AVG Limits, the EUT shall be deemed to meet both Peak & AVG Limits and then only Peak Mode was measured, but AVG Mode didn't perform. (above 1GHz)
- i. For the actual test configuration, please refer to the related Item – EUT TEST PHOTO.

3.3 DEVIATION FROM TEST STANDARD

No deviation.

3.4 TEST SETUP

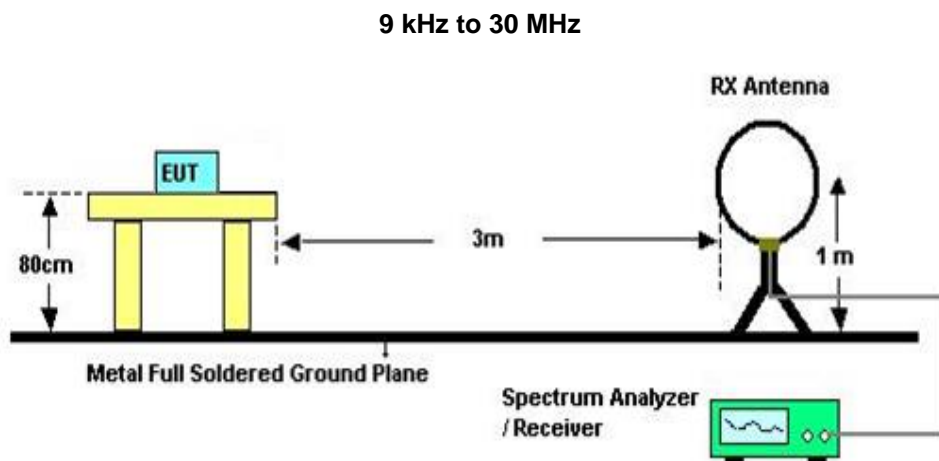

30 MHz to 1 GHz

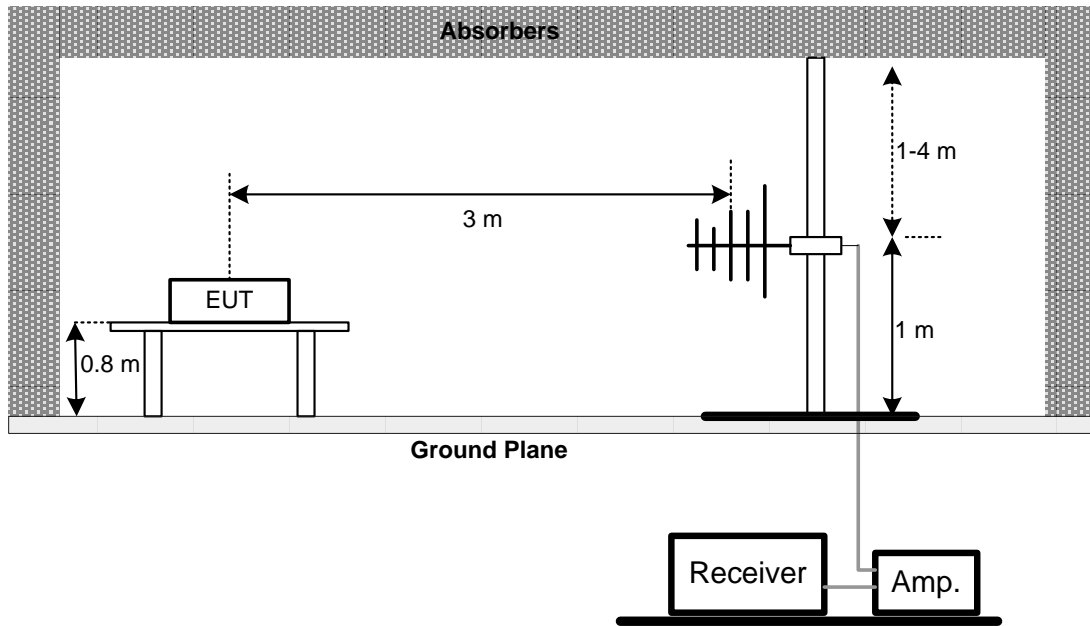

Above 1 GHz

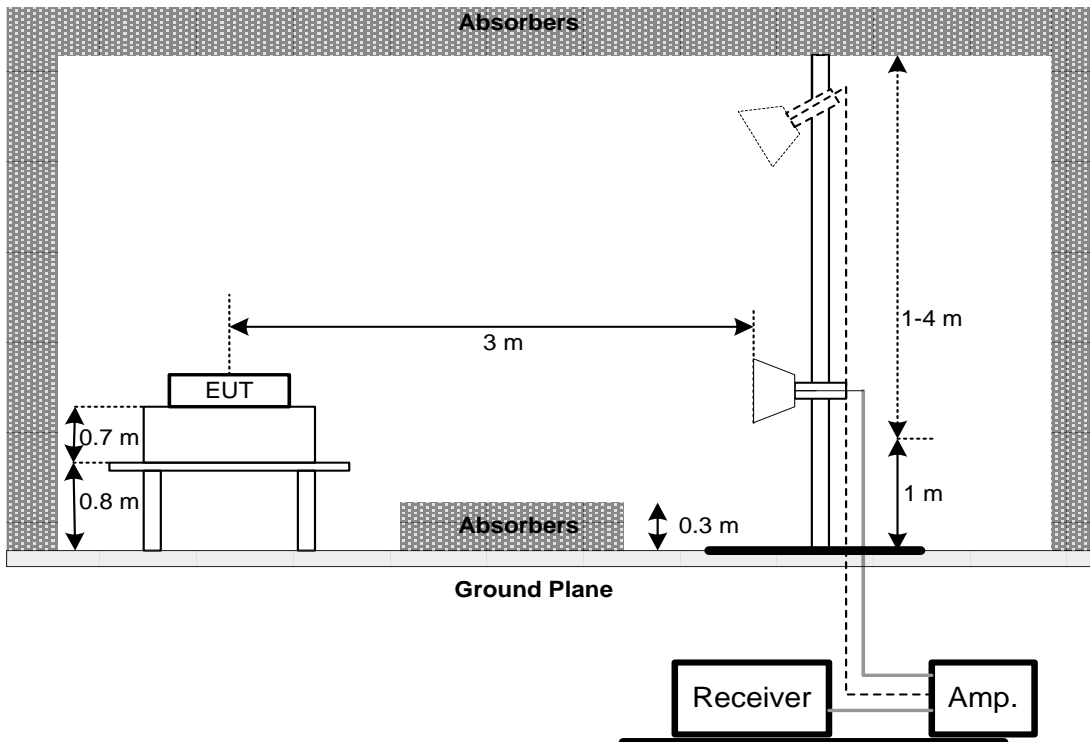

3.5 EUT OPERATING CONDITIONS

The EUT was programmed to be in continuously transmitting mode.

3.6 TEST RESULT – 9 KHZ TO 30 MHZ

Please refer to the APPENDIX A.

3.7 TEST RESULT – 30 MHZ TO 1 GHZ

Please refer to the APPENDIX B.

3.8 TEST RESULT – ABOVE 1 GHZ

Please refer to the APPENDIX C.

NOTE:

- (1) No limit: This is fundamental signal, the judgment is not applicable.
For fundamental signal judgment was referred to Peak output test.

4 NUMBER OF HOPPING CHANNEL

4.1 APPLIED PROCEDURES

FCC Part15 (15.247) , Subpart C			
Section	Test Item	Frequency Range (MHz)	Result
15.247(a)(1)(iii)	Number of Hopping Channel	2400-2483.5	PASS

Spectrum Parameters	Setting
Attenuation	Auto
Span Frequency	> Operating Frequency Range
RBW	100 KHz
VBW	100 KHz
Detector	Peak
Trace	Max Hold
Sweep Time	Auto

4.2 TEST PROCEDURE

- a. The EUT was directly connected to the spectrum analyzer and antenna output port as show in the block diagram below,
- b. Spectrum Setting: RBW=100KHz, VBW=100KHz, Sweep time = Auto.

4.3 DEVIATION FROM STANDARD

No deviation.

4.4 TEST SETUP



4.5 EUT OPERATION CONDITIONS

The EUT tested system was configured as the statements of 4.1.5 unless otherwise a special operating condition is specified in the follows during the testing.

4.6 TEST RESULTS

Please refer to the APPENDIX D.

5 AVERAGE TIME OF OCCUPANCY

5.1 APPLIED PROCEDURES / LIMIT

FCC Part15 (15.247) , Subpart C				
Section	Test Item	Limit	Frequency Range (MHz)	Result
15.247(a)(1)(iii)	Average Time of Occupancy	0.4sec	2400-2483.5	PASS

5.2 TEST PROCEDURE

- a. The transmitter output (antenna port) was connected to the spectrum analyzer
- b. Set RBW of spectrum analyzer to 1MHz and VBW to 1MHz.
- c. Use a video trigger with the trigger level set to enable triggering only on full pulses.
- d. Sweep Time is more than once pulse time.
- e. Set the center frequency on any frequency would be measure and set the frequency span to zero span.
- f. Measure the maximum time duration of one single pulse.
- g. Set the EUT for DH5, DH3 and DH1 packet transmitting.
- h. Measure the maximum time duration of one single pulse.
- i. Measure the maximum time duration of one single pulse.
A Period Time = (channel number)*0.4

For Normal Mode (79 Channel):

DH1 Time Solt: Reading * (1600/2)*31.6/(channel number)

DH3 Time Solt: Reading * (1600/2)*31.6/(channel number)

DH5 Time Solt: Reading * (1600/2)*31.6/(channel number)

For AFH Mode (20 Channel):

DH1 Time Solt: Reading * (1600/2)*8/(channel number)

DH3 Time Solt: Reading * (1600/4)*8/(channel number)

DH5 Time Solt: Reading * (1600/6)*8/(channel number)

5.3 DEVIATION FROM STANDARD

No deviation.

5.4 TEST SETUP



5.5 EUT OPERATION CONDITIONS

The EUT tested system was configured as the statements of 4.1.5 unless otherwise a special operating condition is specified in the follows during the testing.

5.6 TEST RESULTS

Please refer to the APPENDIX E.

6 Hopping Channel Separation Measurement

6.1 APPLIED PROCEDURES / LIMIT

Frequency hopping systems operating in the 2400-2483.5 MHz band may have hopping channel carrier frequencies that are separated by 25 KHz or two-thirds of the 20 dB bandwidth of the hopping channel, whichever is greater.

Spectrum Parameter	Setting
Attenuation	Auto
Span Frequency	> Measurement Bandwidth or Channel Separation
RBW	30 KHz
VBW	100 KHz
Detector	Peak
Trace	Max Hold
Sweep Time	Auto

6.2 TEST PROCEDURE

- a. The EUT must have its hopping function enabled
- b. Span = wide enough to capture the peaks of two adjacent channels
 Resolution (or IF) Bandwidth (RBW) \geq 1% of the span
 Video (or Average) Bandwidth (VBW) \geq RBW
 Sweep = Auto
 Detector function = Peak
 Trace = Max Hold

6.3 DEVIATION FROM STANDARD

No deviation.

6.4 TEST SETUP

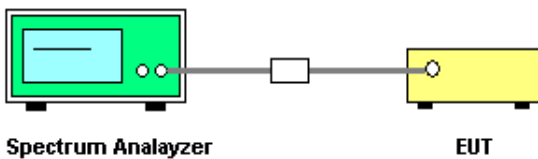

6.5 TEST RESULTS

Please refer to the APPENDIX F.

7 BANDWIDTH TEST

7.1 APPLIED PROCEDURES

FCC Part15 (15.247) , Subpart C		
Section	Test Item	Frequency Range (MHz)
15.247(a)(2)	Bandwidth	2400-2483.5

Spectrum Parameter	Setting
Attenuation	Auto
Span Frequency	> Measurement Bandwidth or Channel Separation
RBW	30 KHz (20dB Bandwidth) / 30 KHz (Channel Separation)
VBW	100 KHz (20dB Bandwidth) / 100 KHz (Channel Separation)
Detector	Peak
Trace	Max Hold
Sweep Time	Auto

7.2 TEST PROCEDURE

- a. The EUT was directly connected to the spectrum analyzer and antenna output port as show in the block diagram below,
- b. Spectrum Setting: RBW= 30KHz, VBW=100KHz, Sweep Time = Auto.

7.3 DEVIATION FROM STANDARD

No deviation.

7.4 TEST SETUP

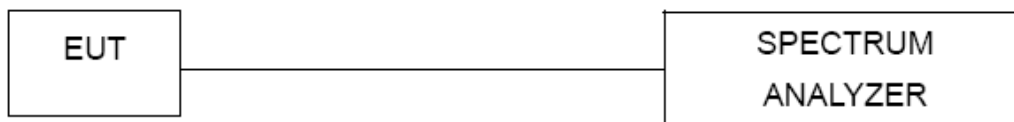

7.5 EUT OPERATION CONDITIONS

The EUT tested system was configured as the statements of 4.1.5 unless otherwise a special operating condition is specified in the follows during the testing.

7.6 TEST RESULTS

Please refer to the APPENDIX G.

8 OUTPUT POWER TEST**8.1 APPLIED PROCEDURES / LIMIT**

FCC Part15 (15.247) , Subpart C				
Section	Test Item	Limit	Frequency Range (MHz)	Result
15.247(b)(1)	Peak Output Power	1 Watt or 30dBm (hopping channel >75) 0.125Watt or 21dBm (hopping channel <75	2400-2483.5	PASS

8.2 TEST PROCEDURE

- a. The EUT was directly connected to the spectrum analyzer and antenna output port as show in the block diagram below,
- b. Spectrum Setting: RBW= 3MHz, VBW= 3MHz, Sweep time = Auto.

8.3 DEVIATION FROM STANDARD

No deviation.

8.4 TEST SETUP**8.5 EUT OPERATION CONDITIONS**

The EUT tested system was configured as the statements of 4.1.5 unless otherwise a special operating condition is specified in the follows during the testing.

8.6 TEST RESULTS

Please refer to the APPENDIX H.

9 ANTENNA CONDUCTED SPURIOUS EMISSION

9.1 APPLIED PROCEDURES / LIMIT

In any 100 kHz bandwidth outside the frequency band in which the spread spectrum or digitally modulated device is operating, the RF power that is produced shall be at least 20 dB below that in the 100 kHz bandwidth within the band that contains the highest level of the desired power, based on either an RF conducted or a radiated measurement, provided that the transmitter demonstrates compliance with the peak conducted power limits.

9.2 TEST PROCEDURE

- a. The EUT was directly connected to the spectrum analyzer and antenna output port as show in the block diagram below,
- b. Spectrum Setting: RBW= 100KHz, VBW=100KHz, Sweep time = Auto.
- c. Offset=antenna gain+cable loss

9.3 DEVIATION FROM STANDARD

No deviation.

9.4 TEST SETUP



9.5 EUT OPERATION CONDITIONS

The EUT tested system was configured as the statements of 4.1.5 unless otherwise a special operating condition is specified in the follows during the testing.

9.6 TEST RESULTS

Please refer to the APPENDIX I.

10 LIST OF MEASURING EQUIPMENTS

Radiated Emissions						
Item	Kind of Equipment	Manufacturer	Type No.	Serial No.	Calibrated Date	Calibrated Until
1	Preamplifier	EMCI	EMC001340	980555	2019/4/12	2020/4/11
2	Preamplifier	EMCI	EMC02325B	980217	2019/4/12	2020/4/11
3	Preamplifier	EMCI	EMC012645B	980267	2019/4/12	2020/4/11
4	Test Cable	EMCI	EMC104-SM-SM-800	150207	2019/4/12	2020/4/11
5	Test Cable	EMCI	EMC104-SM-SM-3000	151205	2019/4/12	2020/4/11
6	Test Cable	EMCI	EMC-SM-SM-7000	180408	2019/4/12	2020/4/11
7	MXE EMI Receiver	Agilent	N9038A	MY55420127	2019/3/26	2020/3/25
8	Signal Analyzer	Agilent	N9010A	MY56480554	2019/6/6	2020/6/5
9	Loop Ant	EMCO	EMCI-LPA600	274	2019/5/31	2020/5/30
10	Horn Ant	SCHWARZBECK	BBHA 9120D	9120D-1342	2019/6/10	2020/6/9
11	Trilog-Broadband Antenna	Schwarzbeck	VULB 9168	000992	2019/5/29	2020/5/28
12	5dB Attenuator	EMCI	EMCI-N-6-05	AT-N0508	2019/5/29	2020/5/28

Number of Hopping Frequency						
Item	Kind of Equipment	Manufacturer	Type No.	Serial No.	Calibrated Date	Calibrated Until
1	Spectrum Analyzer	R&S	FSP40	100129	2019/5/23	2020/5/22

Average Time of Occupancy						
Item	Kind of Equipment	Manufacturer	Type No.	Serial No.	Calibrated Date	Calibrated Until
1	Spectrum Analyzer	R&S	FSP40	100129	2019/5/23	2020/5/22

Hopping Channel Separation						
Item	Kind of Equipment	Manufacturer	Type No.	Serial No.	Calibrated Date	Calibrated Until
1	Spectrum Analyzer	R&S	FSP40	100129	2019/5/23	2020/5/22

Bandwidth						
Item	Kind of Equipment	Manufacturer	Type No.	Serial No.	Calibrated Date	Calibrated Until
1	Spectrum Analyzer	R&S	FSP40	100129	2019/5/23	2020/5/22

Output Power						
Item	Kind of Equipment	Manufacturer	Type No.	Serial No.	Calibrated Date	Calibrated Until
1	Power Meter	Anritsu	ML2487A	6K00004714	2019/6/20	2020/6/18
2	Power Sensor	Anritsu	MA2491A	1725282	2019/6/20	2020/6/18

Antenna conducted Spurious Emission						
Item	Kind of Equipment	Manufacturer	Type No.	Serial No.	Calibrated Date	Calibrated Until
1	Spectrum Analyzer	R&S	FSP40	100129	2019/5/23	2020/5/22

Remark: "N/A" denotes no model name, no serial no. or no calibration specified.
All calibration period of equipment list is one year.

11 EUT TEST PHOTO

Please refer to document Appendix No.: TP-1911T046-FCCP-1 (APPENDIX-TEST PHOTOS).

12 EUT PHOTOS

Please refer to document Appendix No.: EP-1911T046-1 (APPENDIX-EUT PHOTOS).

APPENDIX A RADIATED EMISSIONS - 9 KHZ TO 30 MHZ

Test Mode	TX Mode 2402MHz _CH00_1Mbps	Tested Date	2019/12/9
Test Voltage	DC 48V	Azimuth Angle	90°

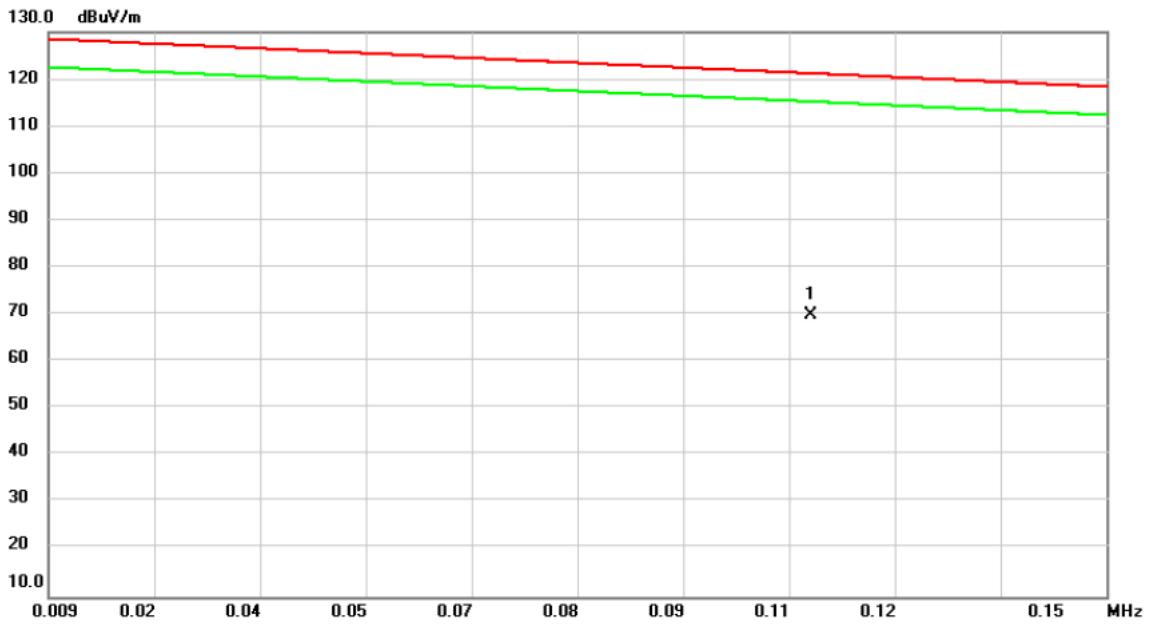

No.	Mk.	Freq.	Reading Level	Correct Factor	Measurement	Limit	Margin	Detector	Comment
		MHz	dBuV	dB	dBuV/m	dBuV/m	dB		
1	*	0.1107	54.37	15.42	69.79	121.17	-51.38	AVG	

REMARKS:

- (1) Measurement Value = Reading Level + Correct Factor.
- (2) Margin Level = Measurement Value - Limit Value.

Test Mode	TX Mode 2402MHz _CH00_1Mbps	Tested Date	2019/12/9
Test Voltage	DC 48V	Azimuth Angle	90°

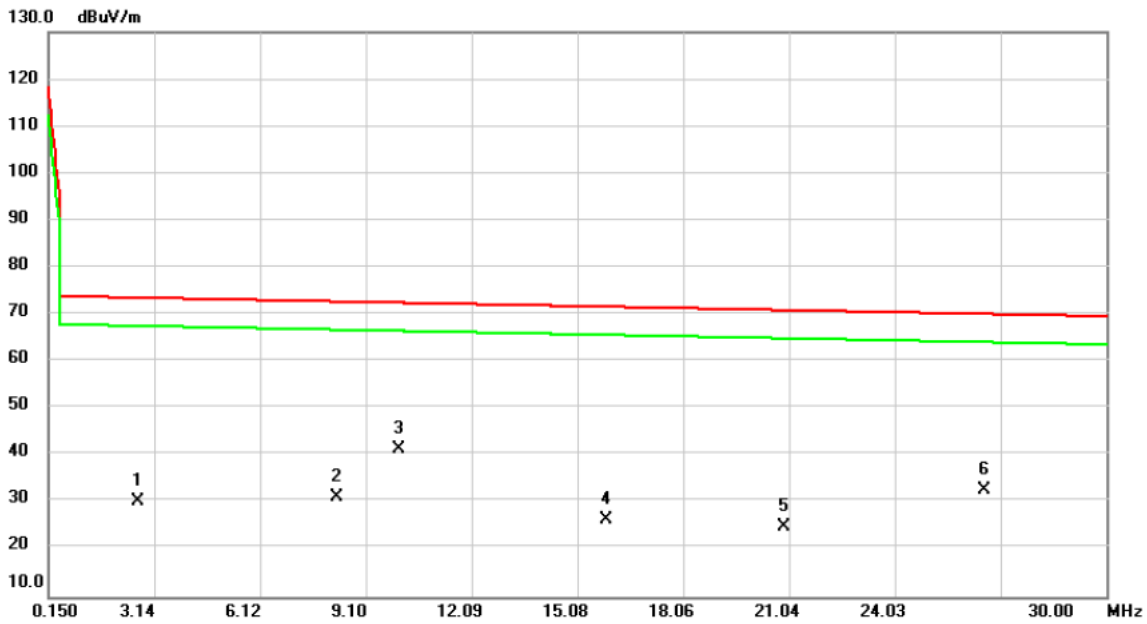

No. Mk.	Freq. MHz	Reading Level dBuV	Correct Factor dB	Measurement dBuV/m	Limit dBuV/m	Margin dB	Detector	Comment
1	2.6574	33.67	-3.41	30.26	73.49	-43.23	QP	
2	8.2692	35.54	-4.42	31.12	72.68	-41.56	QP	
3 *	10.0304	45.93	-4.71	41.22	72.42	-31.20	QP	
4	15.8810	31.62	-5.29	26.33	71.58	-45.25	QP	
5	20.9255	31.40	-6.54	24.86	70.85	-45.99	QP	
6	26.5374	41.23	-8.53	32.70	70.04	-37.34	QP	

REMARKS:

- (1) Measurement Value = Reading Level + Correct Factor.
- (2) Margin Level = Measurement Value - Limit Value.

Test Mode	TX Mode 2402MHz _CH00_1Mbps	Tested Date	2019/12/9
Test Voltage	DC 48V	Azimuth Angle	0°

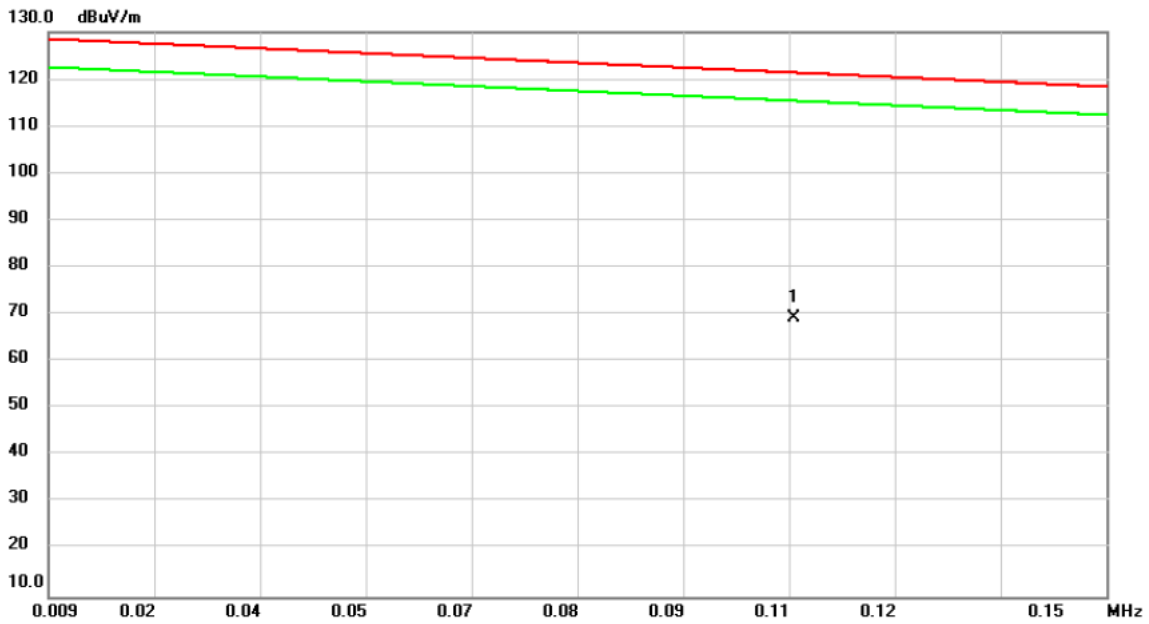

No. Mk.	Freq.	Reading Level	Correct Factor	Measurement	Limit	Margin	Detector	Comment
	MHz	dBuV	dB	dBuV/m	dBuV/m	dB		
1 *	0.1083	53.60	15.56	69.16	121.34	-52.18	AVG	

REMARKS:

- (1) Measurement Value = Reading Level + Correct Factor.
- (2) Margin Level = Measurement Value - Limit Value.

Test Mode	TX Mode 2402MHz _CH00_1Mbps	Tested Date	2019/12/9
Test Voltage	DC 48V	Azimuth Angle	0°

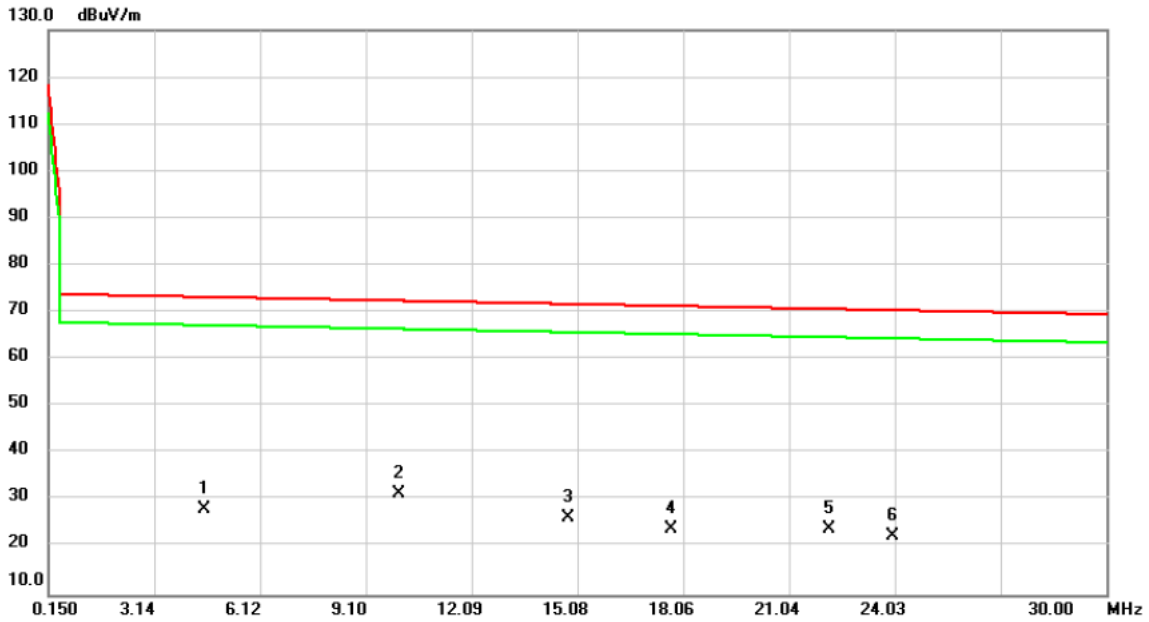

No.	Mk.	Freq. MHz	Reading Level dBuV	Correct Factor dB	Measure- ment dBuV/m	Limit dBuV/m	Margin dB	Detector	Comment
1		4.5380	32.06	-3.86	28.20	73.22	-45.02	QP	
2	*	10.0304	36.16	-4.71	31.45	72.42	-40.97	QP	
3		14.8064	31.40	-4.98	26.42	71.73	-45.31	QP	
4		17.7316	29.94	-6.12	23.82	71.31	-47.49	QP	
5		22.1793	30.80	-6.75	24.05	70.67	-46.62	QP	
6		23.9703	30.54	-8.02	22.52	70.41	-47.89	QP	

REMARKS:

- (1) Measurement Value = Reading Level + Correct Factor.
- (2) Margin Level = Measurement Value - Limit Value.

APPENDIX B RADIATED EMISSIONS - 30 MHZ TO 1 GHZ

Test Mode	TX Mode 2402MHz _CH00_1Mbps	Tested Date	2019/12/9
Test Voltage	DC 48V	Polarization	Vertical

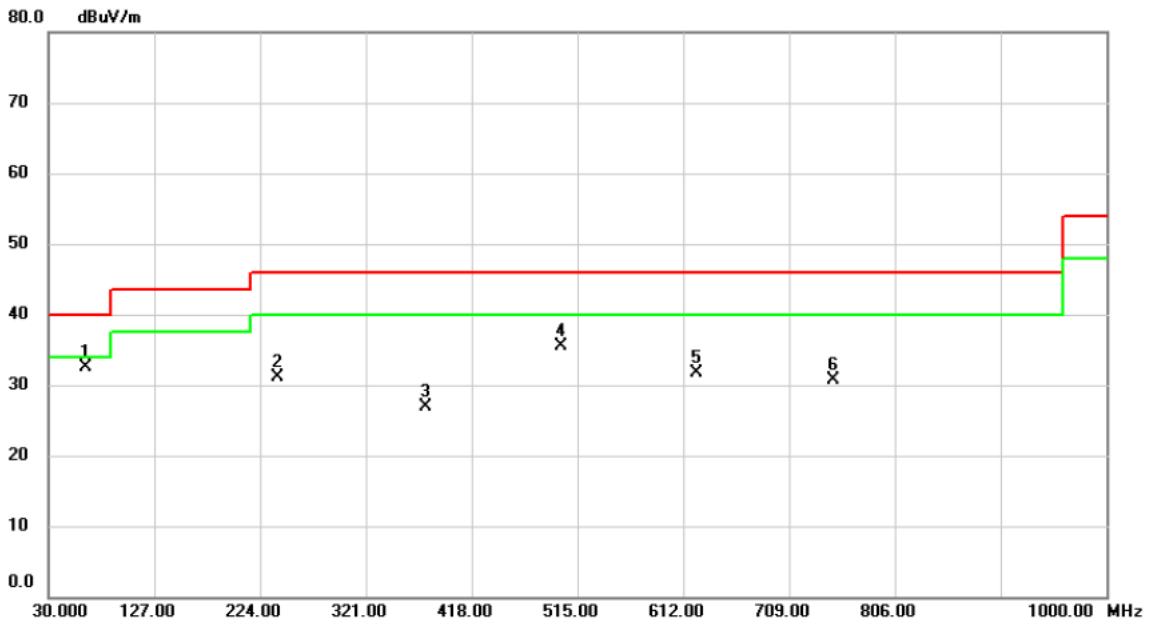

No.	Mk.	Freq. MHz	Reading Level dBuV	Correct Factor dB	Measure- ment dBuV/m	Limit dBuV/m	Margin dB	Detector	Comment
1	*	63.9500	45.38	-12.83	32.55	40.00	-7.45	peak	
2		239.5200	44.29	-13.25	31.04	46.00	-14.96	peak	
3		375.3200	36.05	-9.05	27.00	46.00	-19.00	peak	
4		500.4500	41.66	-6.12	35.54	46.00	-10.46	peak	
5		624.6100	35.30	-3.54	31.76	46.00	-14.24	peak	
6		749.7400	32.16	-1.36	30.80	46.00	-15.20	peak	

REMARKS:

- (1) Measurement Value = Reading Level + Correct Factor.
- (2) Margin Level = Measurement Value - Limit Value.

Test Mode	TX Mode 2402MHz _CH00_1Mbps	Tested Date	2019/12/9
Test Voltage	DC 48V	Polarization	Horizontal

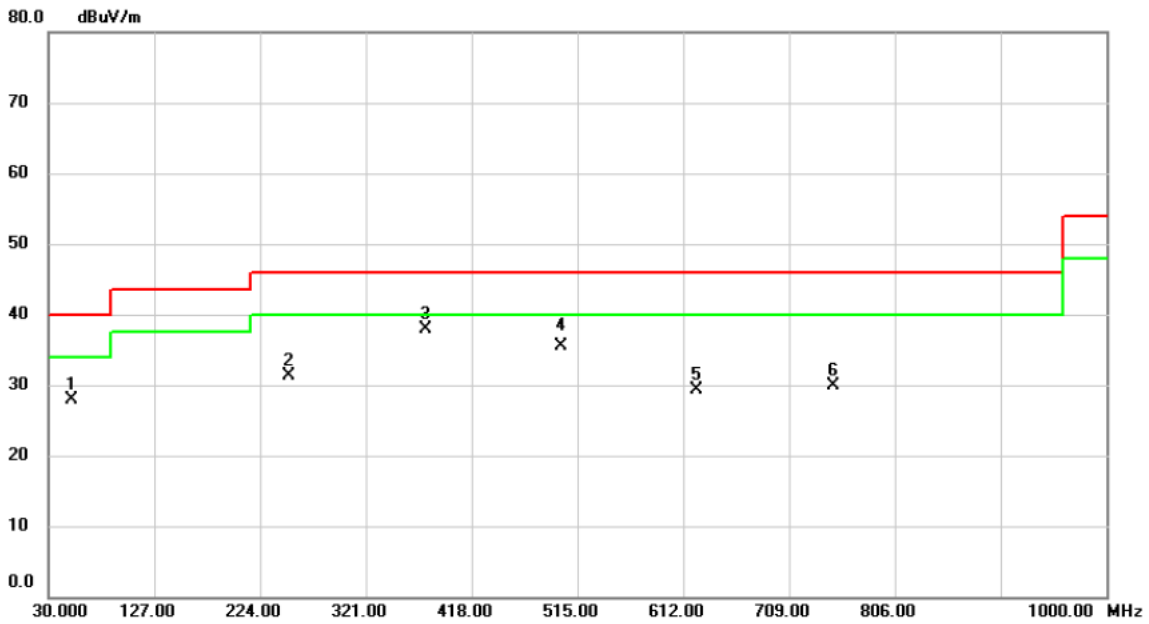

No.	Mk.	Freq. MHz	Reading Level dBuV	Correct Factor dB	Measure- ment dBuV/m	Limit dBuV/m	Margin dB	Detector	Comment
1		51.3400	39.78	-11.80	27.98	40.00	-12.02	peak	
2		250.1900	44.30	-12.92	31.38	46.00	-14.62	peak	
3	*	375.3200	46.86	-9.05	37.81	46.00	-8.19	peak	
4		500.4500	41.71	-6.12	35.59	46.00	-10.41	QP	
5		624.6100	32.81	-3.54	29.27	46.00	-16.73	peak	
6		749.7400	31.21	-1.36	29.85	46.00	-16.15	peak	

REMARKS:

- (1) Measurement Value = Reading Level + Correct Factor.
- (2) Margin Level = Measurement Value - Limit Value.

APPENDIX C RADIATED EMISSIONS - ABOVE 1 GHZ

Test Mode	TX Mode 2402MHz _CH00_1Mbps	Tested Date	2019/12/10
Test Voltage	DC 48V	Polarization	Horizontal

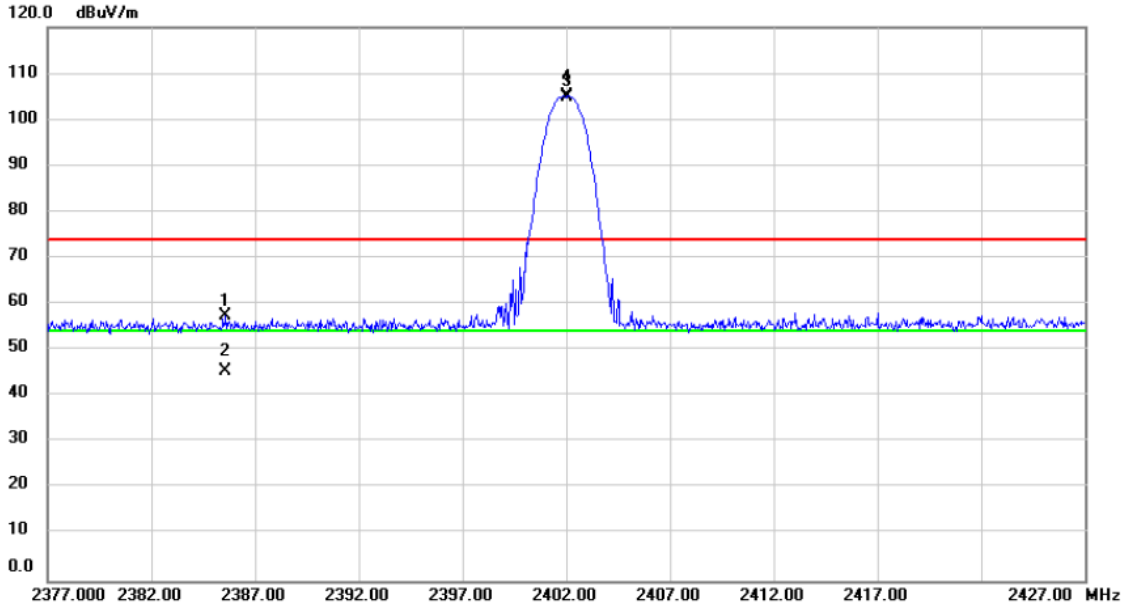

No.	Mk.	Freq. MHz	Reading Level dBuV	Correct Factor dB	Measure- ment dBuV/m	Limit dBuV/m	Margin dB	Detector	Comment
1		2385.600	26.12	31.22	57.34	74.00	-16.66	peak	
2		2385.600	14.14	31.22	45.36	54.00	-8.64	AVG	
3	X	2402.000	73.73	31.30	105.03	74.00	31.03	peak	No Limit
4	*	2402.000	73.67	31.30	104.97	54.00	50.97	AVG	No Limit

REMARKS:

- (1) Measurement Value = Reading Level + Correct Factor.
- (2) Margin Level = Measurement Value - Limit Value.

Test Mode	TX Mode 2480MHz_CH78_1Mbps	Tested Date	2019/12/10
Test Voltage	DC 48V	Polarization	Horizontal

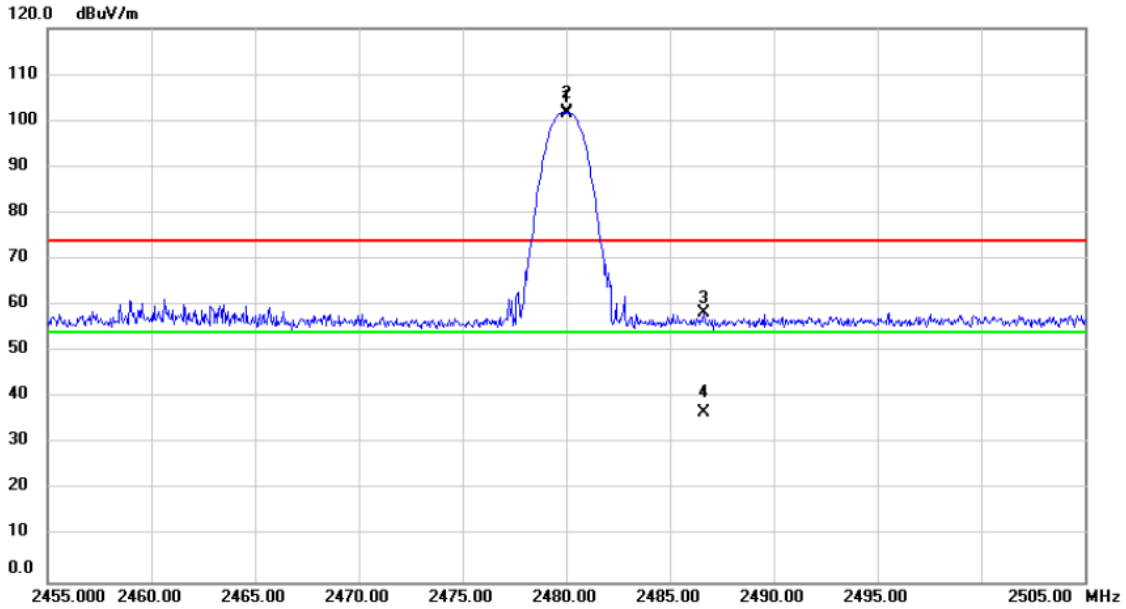

No.	Mk.	Freq. MHz	Reading Level dBuV	Correct Factor dB	Measure- ment dBuV/m	Limit dBuV/m	Margin dB	Detector	Comment
1	X	2480.000	70.09	31.65	101.74	74.00	27.74	peak	No Limit
2	*	2480.000	70.04	31.65	101.69	54.00	47.69	AVG	No Limit
3		2486.650	26.55	31.67	58.22	74.00	-15.78	peak	
4		2486.650	5.18	31.67	36.85	54.00	-17.15	AVG	

REMARKS:

- (1) Measurement Value = Reading Level + Correct Factor.
- (2) Margin Level = Measurement Value - Limit Value.

Test Mode	TX Mode 2402MHz_CH00_3Mbps	Tested Date	2019/12/10
Test Voltage	DC 48V	Polarization	Horizontal

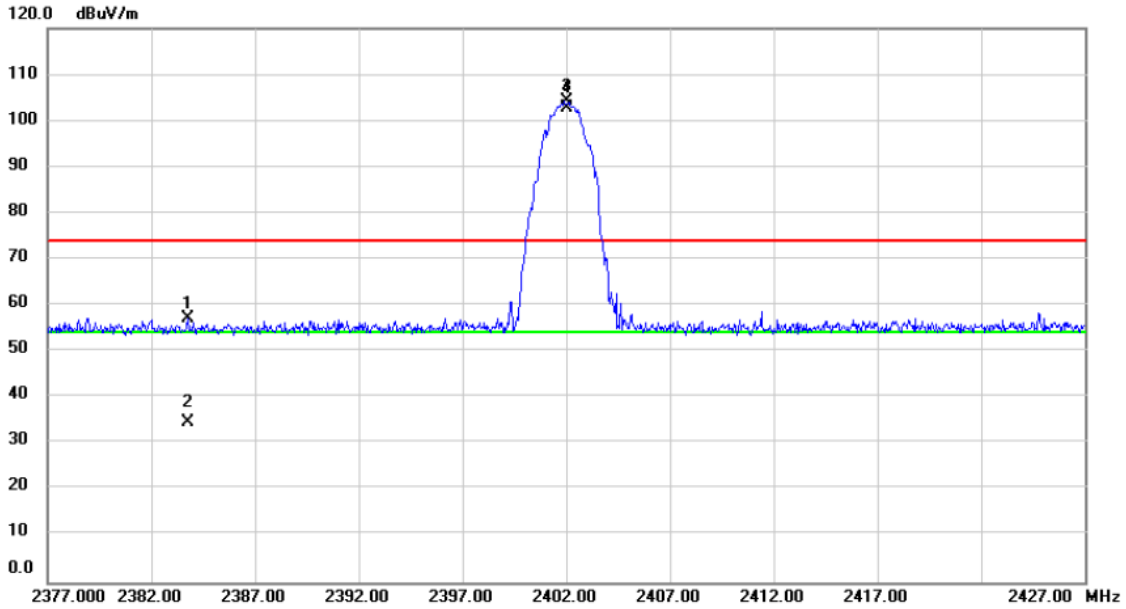

No.	Mk.	Freq. MHz	Reading Level dBuV	Correct Factor dB	Measure- ment dBuV/m	Limit dBuV/m	Margin dB	Detector	Comment
1		2383.750	26.03	31.22	57.25	74.00	-16.75	peak	
2		2383.750	3.35	31.22	34.57	54.00	-19.43	AVG	
3	X	2402.000	72.90	31.30	104.20	74.00	30.20	peak	No Limit
4	*	2402.000	71.49	31.30	102.79	54.00	48.79	AVG	No Limit

REMARKS:

- (1) Measurement Value = Reading Level + Correct Factor.
- (2) Margin Level = Measurement Value - Limit Value.

Test Mode	TX Mode 2480MHz_CH78_3Mbps	Tested Date	2019/12/10
Test Voltage	DC 48V	Polarization	Horizontal

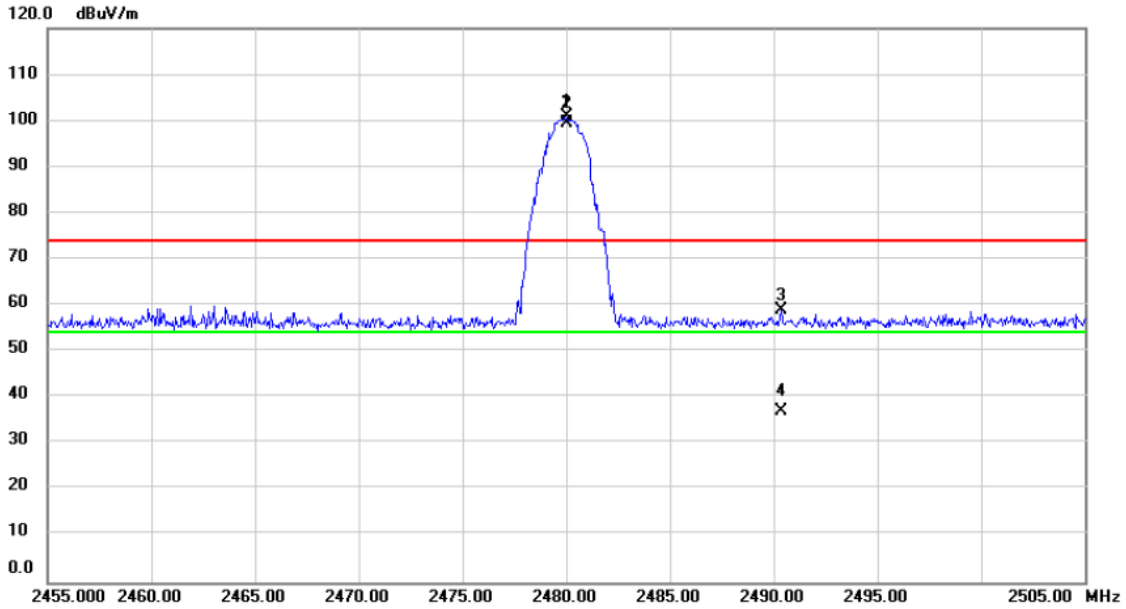

No.	Mk.	Freq. MHz	Reading Level dBuV	Correct Factor dB	Measure- ment dBuV/m	Limit dBuV/m	Margin dB	Detector	Comment
1	X	2480.000	69.18	31.65	100.83	74.00	26.83	peak	No Limit
2	*	2480.000	67.78	31.65	99.43	54.00	45.43	AVG	No Limit
3		2490.350	27.25	31.69	58.94	74.00	-15.06	peak	
4		2490.350	5.28	31.69	36.97	54.00	-17.03	AVG	

REMARKS:

- (1) Measurement Value = Reading Level + Correct Factor.
- (2) Margin Level = Measurement Value - Limit Value.

Test Mode	TX Mode 2402MHz _CH00_1Mbps	Tested Date	2019/12/10
Test Voltage	DC 48V	Polarization	Vertical

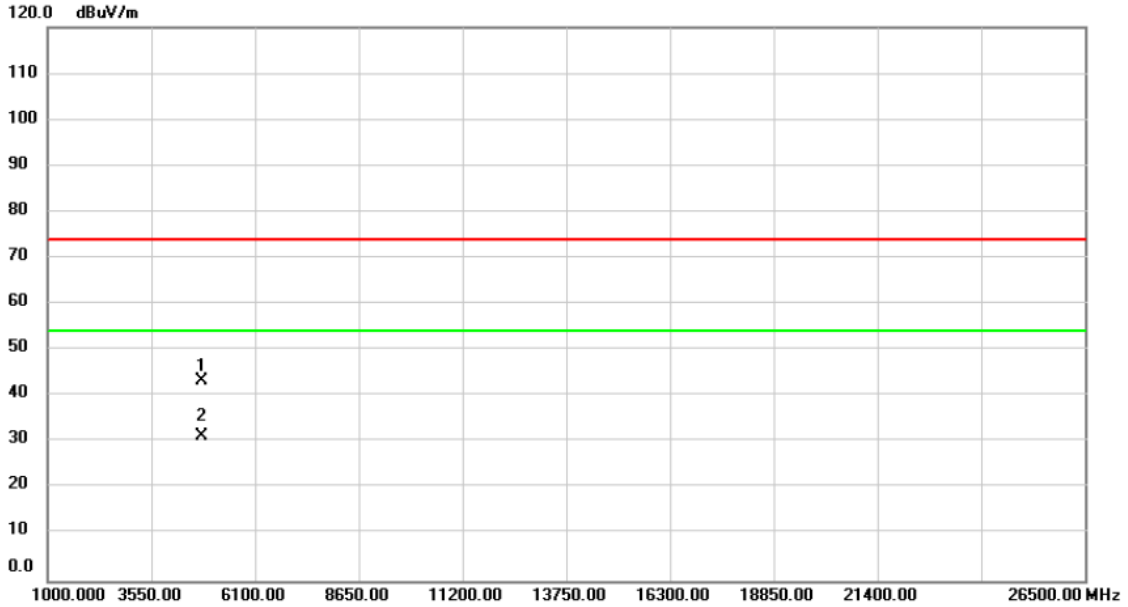

No. Mk.	Freq. MHz	Reading Level dBuV	Correct Factor dB	Measurement dBuV/m	Limit dBuV/m	Margin dB	Detector	Comment
1	4804.000	54.08	-10.58	43.50	74.00	-30.50	peak	
2 *	4804.000	41.80	-10.58	31.22	54.00	-22.78	AVG	

REMARKS:

- (1) Measurement Value = Reading Level + Correct Factor.
- (2) Margin Level = Measurement Value - Limit Value.

Test Mode	TX Mode 2402MHz _CH00_1Mbps	Tested Date	2019/12/10
Test Voltage	DC 48V	Polarization	Horizontal

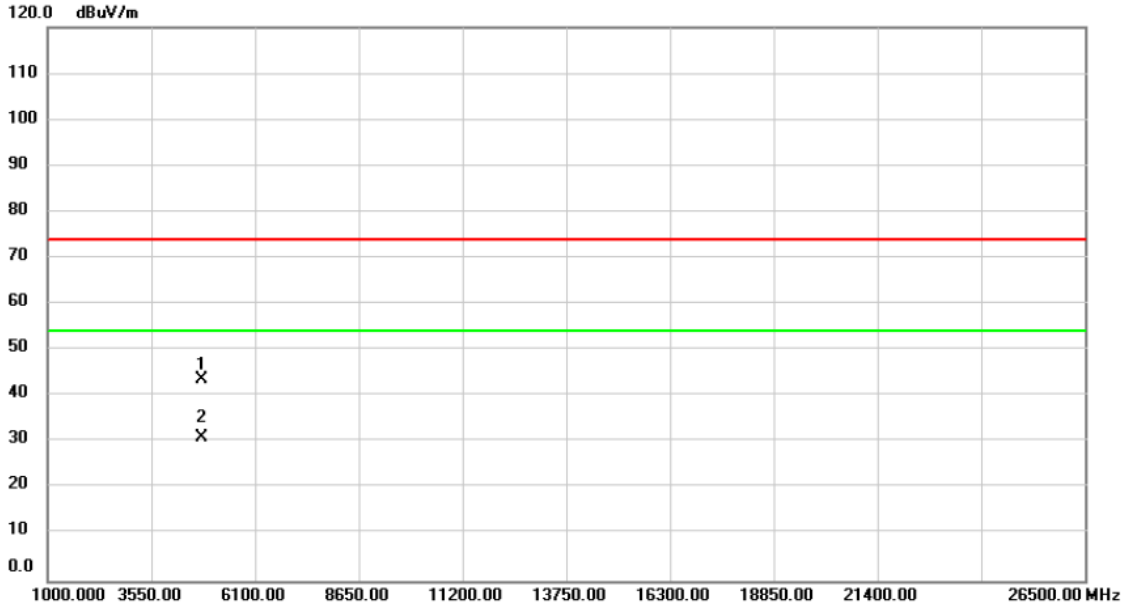

No. Mk.	Freq. MHz	Reading Level dBuV	Correct Factor dB	Measurement dBuV/m	Limit dBuV/m	Margin dB	Detector	Comment
1	4804.000	54.11	-10.58	43.53	74.00	-30.47	peak	
2 *	4804.000	41.55	-10.58	30.97	54.00	-23.03	AVG	

REMARKS:

- (1) Measurement Value = Reading Level + Correct Factor.
- (2) Margin Level = Measurement Value - Limit Value.

Test Mode	TX Mode 2441MHz _CH39_1Mbps	Tested Date	2019/12/10
Test Voltage	DC 48V	Polarization	Vertical

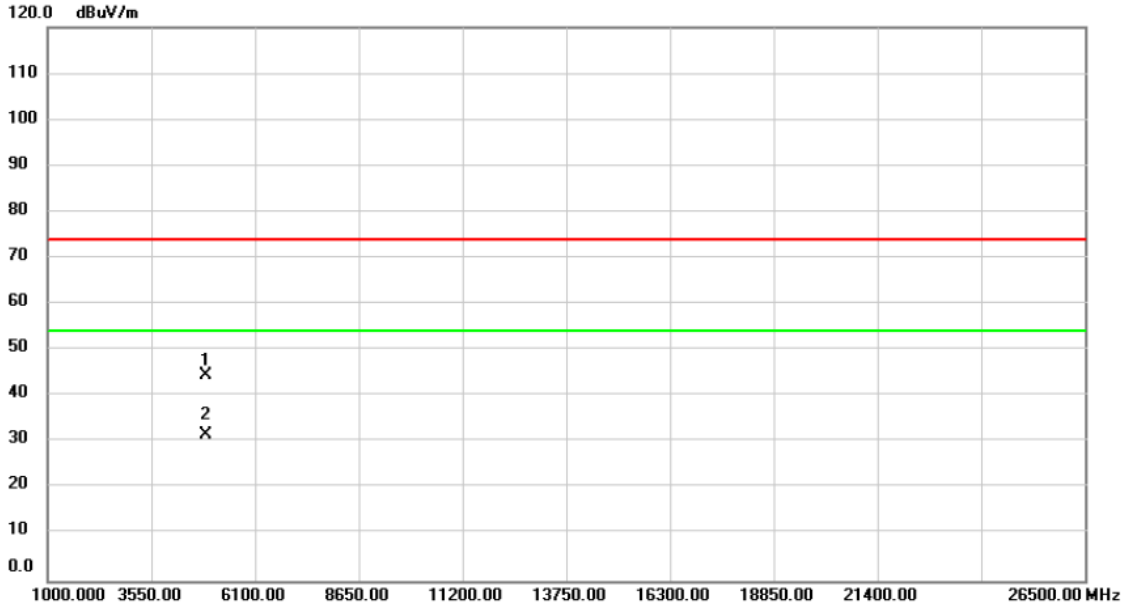

No. Mk.	Freq. MHz	Reading Level dBuV	Correct Factor dB	Measurement dBuV/m	Limit dBuV/m	Margin dB	Detector	Comment
1	4882.000	54.97	-10.39	44.58	74.00	-29.42	peak	
2 *	4882.000	42.08	-10.39	31.69	54.00	-22.31	AVG	

REMARKS:

- (1) Measurement Value = Reading Level + Correct Factor.
- (2) Margin Level = Measurement Value - Limit Value.

Test Mode	TX Mode 2441MHz _CH39_1Mbps	Tested Date	2019/12/10
Test Voltage	DC 48V	Polarization	Horizontal

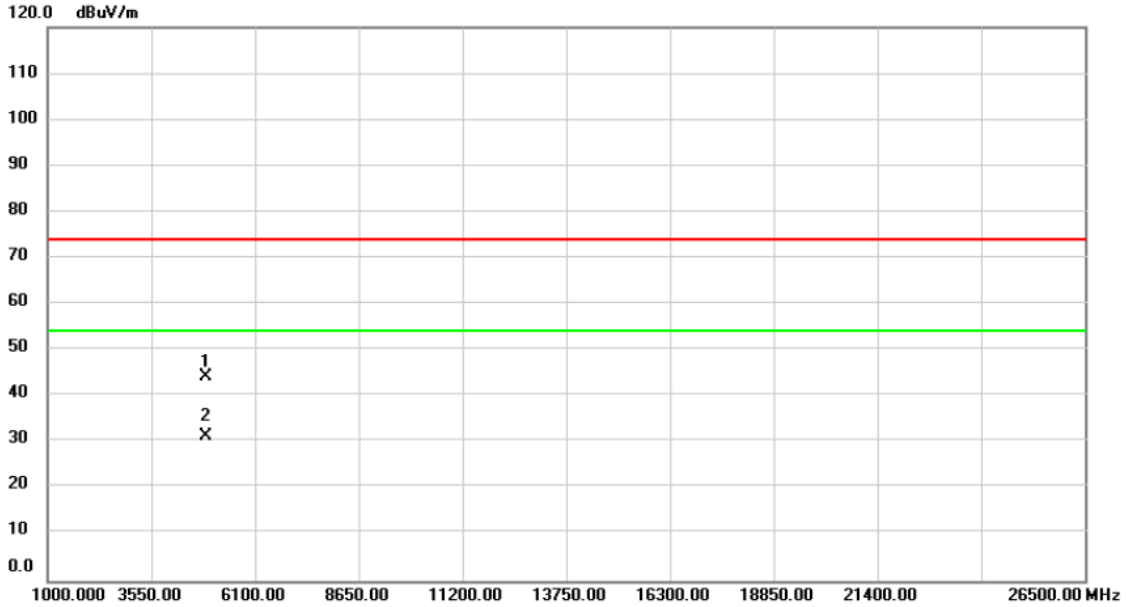

No. Mk.	Freq. MHz	Reading Level dBuV	Correct Factor dB	Measurement dBuV/m	Limit dBuV/m	Margin dB	Detector	Comment
1	4882.000	54.67	-10.39	44.28	74.00	-29.72	peak	
2 *	4882.000	41.74	-10.39	31.35	54.00	-22.65	AVG	

REMARKS:

- (1) Measurement Value = Reading Level + Correct Factor.
- (2) Margin Level = Measurement Value - Limit Value.

Test Mode	TX Mode 2480MHz _CH78_1Mbps	Tested Date	2019/12/10
Test Voltage	DC 48V	Polarization	Vertical

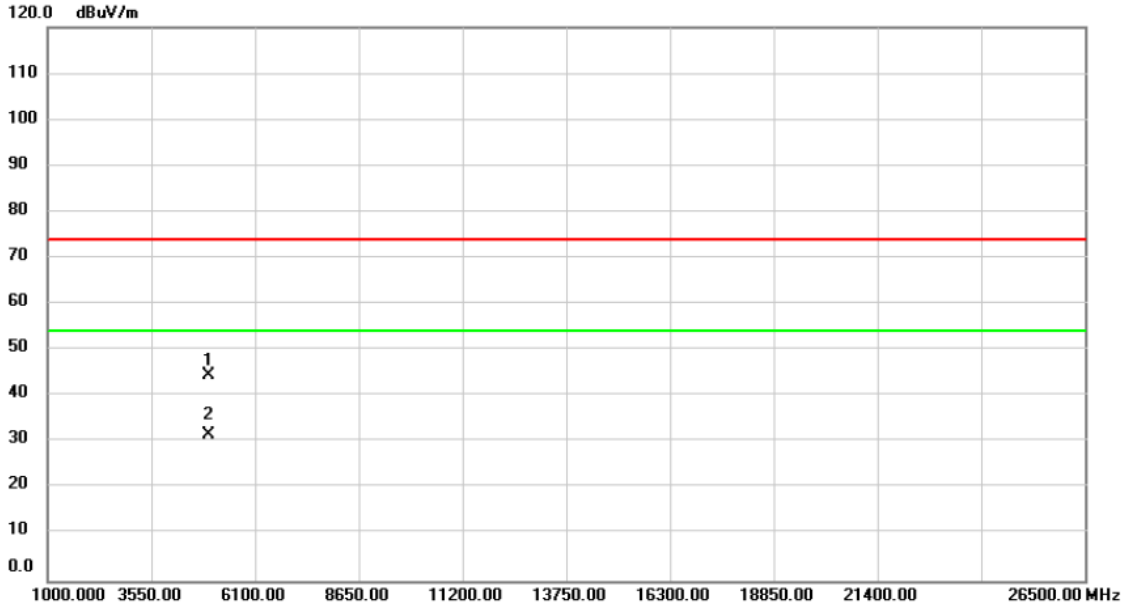

No. Mk.	Freq. MHz	Reading Level dBuV	Correct Factor dB	Measurement dBuV/m	Limit dBuV/m	Margin dB	Detector	Comment
1	4960.000	54.76	-10.19	44.57	74.00	-29.43	peak	
2 *	4960.000	41.89	-10.19	31.70	54.00	-22.30	AVG	

REMARKS:

- (1) Measurement Value = Reading Level + Correct Factor.
- (2) Margin Level = Measurement Value - Limit Value.

Test Mode	TX Mode 2480MHz _CH78_1Mbps	Tested Date	2019/12/10
Test Voltage	DC 48V	Polarization	Horizontal

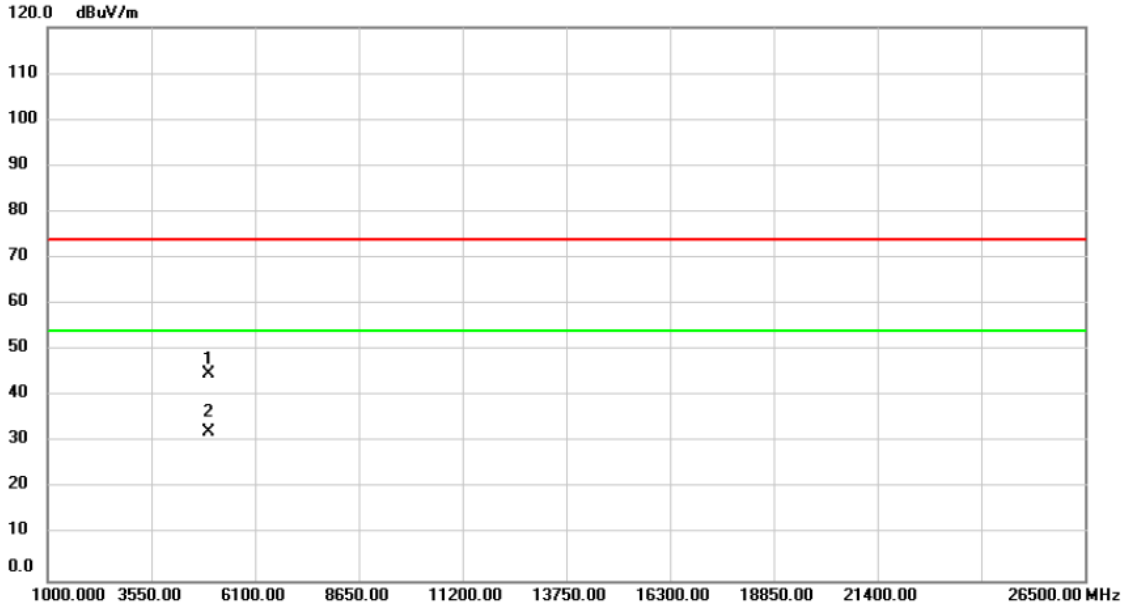

No. Mk.	Freq. MHz	Reading Level dBuV	Correct Factor dB	Measurement dBuV/m	Limit dBuV/m	Margin dB	Detector	Comment
1	4960.000	55.05	-10.19	44.86	74.00	-29.14	peak	
2 *	4960.000	42.48	-10.19	32.29	54.00	-21.71	AVG	

REMARKS:

- (1) Measurement Value = Reading Level + Correct Factor.
- (2) Margin Level = Measurement Value - Limit Value.

Test Mode	TX Mode 2402MHz _CH00_3Mbps	Tested Date	2019/12/10
Test Voltage	DC 48V	Polarization	Vertical

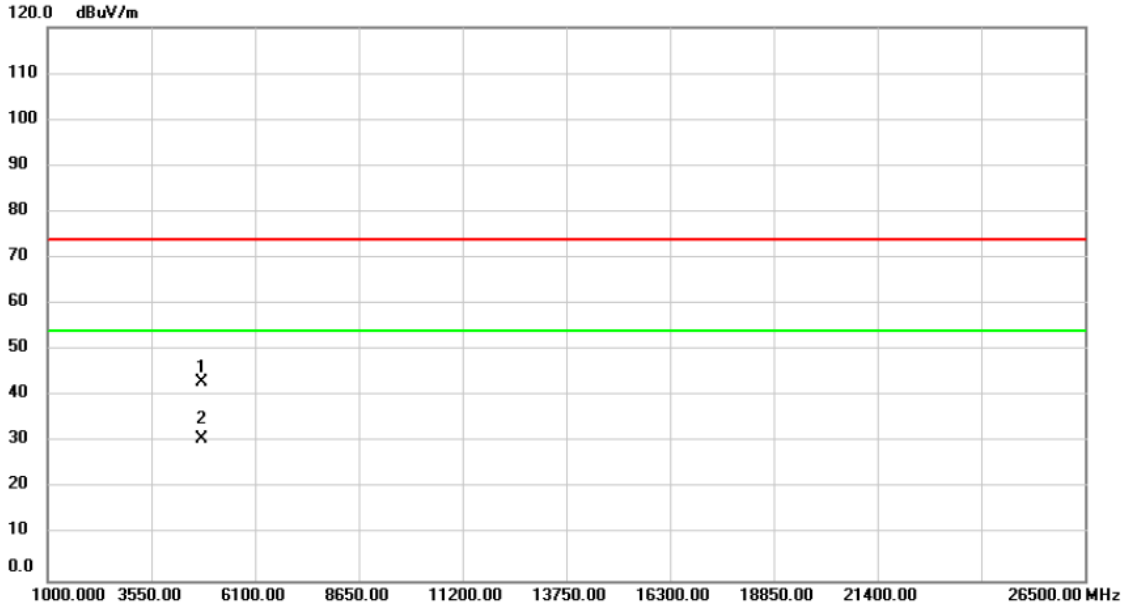

No. Mk.	Freq. MHz	Reading Level dBuV	Correct Factor dB	Measurement dBuV/m	Limit dBuV/m	Margin dB	Detector	Comment
1	4804.000	53.76	-10.58	43.18	74.00	-30.82	peak	
2 *	4804.000	41.29	-10.58	30.71	54.00	-23.29	AVG	

REMARKS:

- (1) Measurement Value = Reading Level + Correct Factor.
- (2) Margin Level = Measurement Value - Limit Value.

Test Mode	TX Mode 2402MHz _CH00_3Mbps	Tested Date	2019/12/10
Test Voltage	DC 48V	Polarization	Horizontal

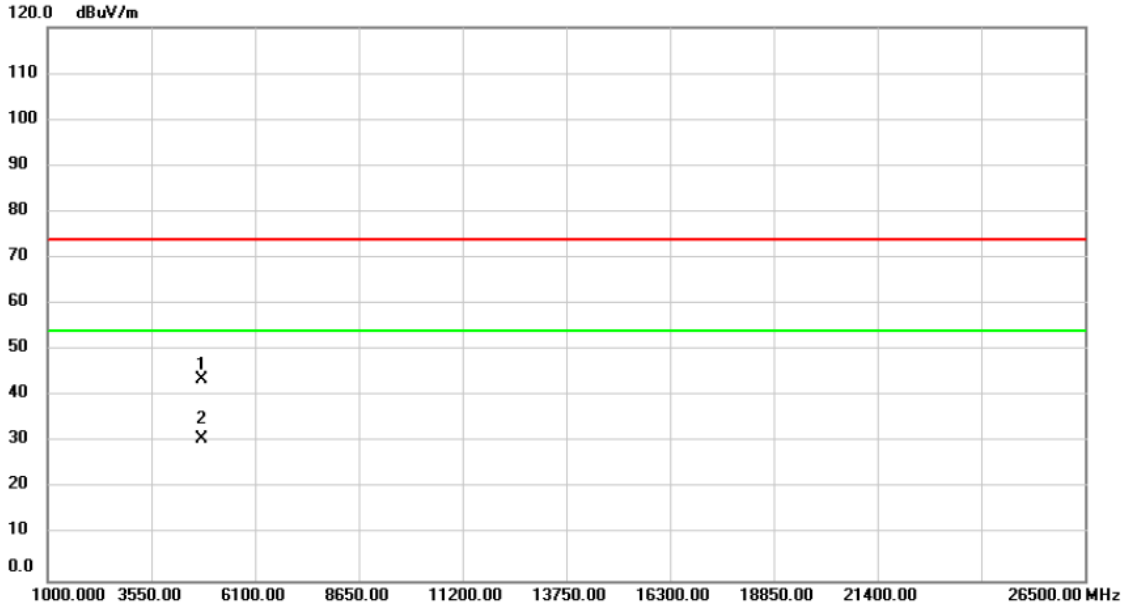

No. Mk.	Freq. MHz	Reading Level dBuV	Correct Factor dB	Measurement dBuV/m	Limit dBuV/m	Margin dB	Detector	Comment
1	4804.000	54.10	-10.58	43.52	74.00	-30.48	peak	
2 *	4804.000	41.47	-10.58	30.89	54.00	-23.11	AVG	

REMARKS:

- (1) Measurement Value = Reading Level + Correct Factor.
- (2) Margin Level = Measurement Value - Limit Value.

Test Mode	TX Mode 2441MHz _CH39_3Mbps	Tested Date	2019/12/10
Test Voltage	DC 48V	Polarization	Vertical

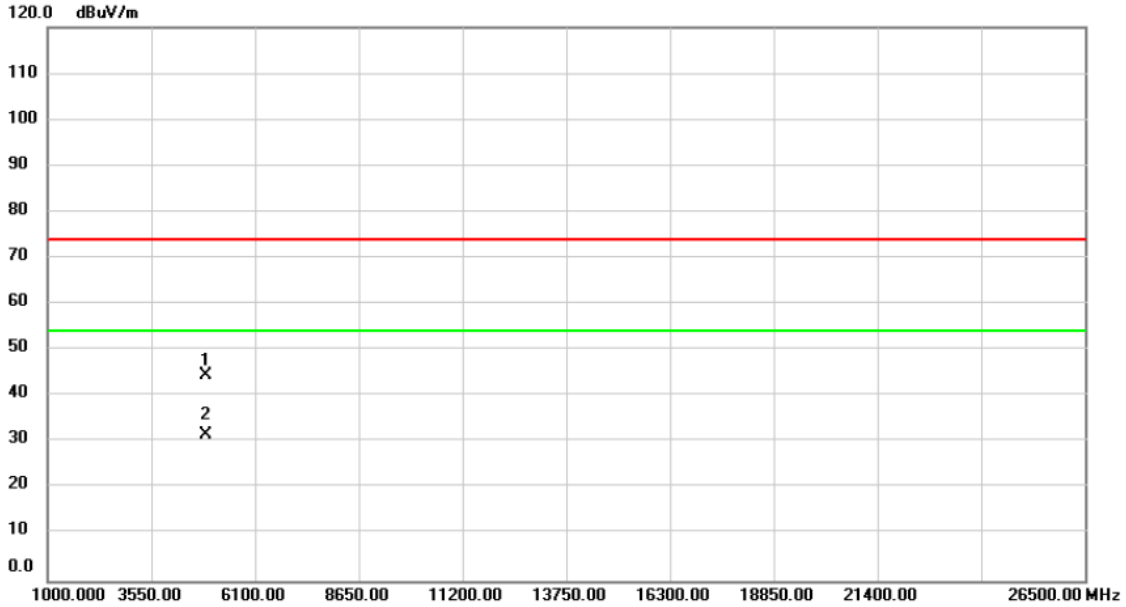

No. Mk.	Freq. MHz	Reading Level dBuV	Correct Factor dB	Measurement dBuV/m	Limit dBuV/m	Margin dB	Detector	Comment
1	4882.000	55.00	-10.39	44.61	74.00	-29.39	peak	
2 *	4882.000	42.16	-10.39	31.77	54.00	-22.23	AVG	

REMARKS:

- (1) Measurement Value = Reading Level + Correct Factor.
- (2) Margin Level = Measurement Value - Limit Value.

Test Mode	TX Mode 2441MHz _CH39_3Mbps	Tested Date	2019/12/10
Test Voltage	DC 48V	Polarization	Horizontal

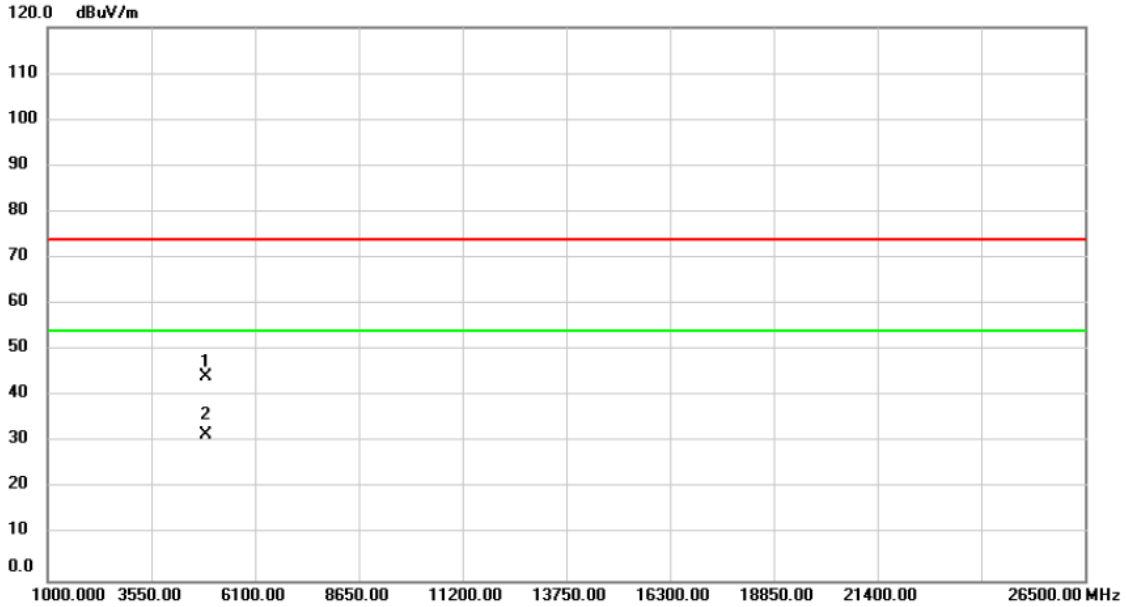

No. Mk.	Freq. MHz	Reading Level dBuV	Correct Factor dB	Measurement dBuV/m	Limit dBuV/m	Margin dB	Detector	Comment
1	4882.000	54.61	-10.39	44.22	74.00	-29.78	peak	
2 *	4882.000	42.18	-10.39	31.79	54.00	-22.21	AVG	

REMARKS:

- (1) Measurement Value = Reading Level + Correct Factor.
- (2) Margin Level = Measurement Value - Limit Value.

Test Mode	TX Mode 2480MHz _CH78_3Mbps	Tested Date	2019/12/10
Test Voltage	DC 48V	Polarization	Vertical

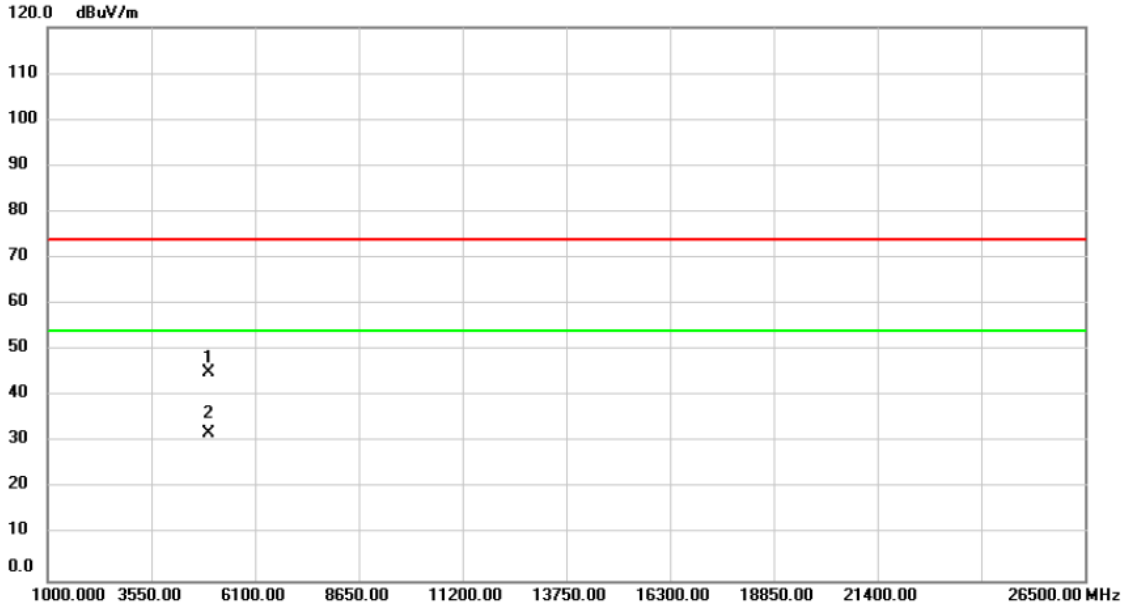

No. Mk.	Freq. MHz	Reading Level dBuV	Correct Factor dB	Measurement dBuV/m	Limit dBuV/m	Margin dB	Detector	Comment
1	4960.000	55.30	-10.19	45.11	74.00	-28.89	peak	
2 *	4960.000	42.11	-10.19	31.92	54.00	-22.08	AVG	

REMARKS:

- (1) Measurement Value = Reading Level + Correct Factor.
- (2) Margin Level = Measurement Value - Limit Value.

Test Mode	TX Mode 2480MHz _CH78_3Mbps	Tested Date	2019/12/10
Test Voltage	DC 48V	Polarization	Horizontal

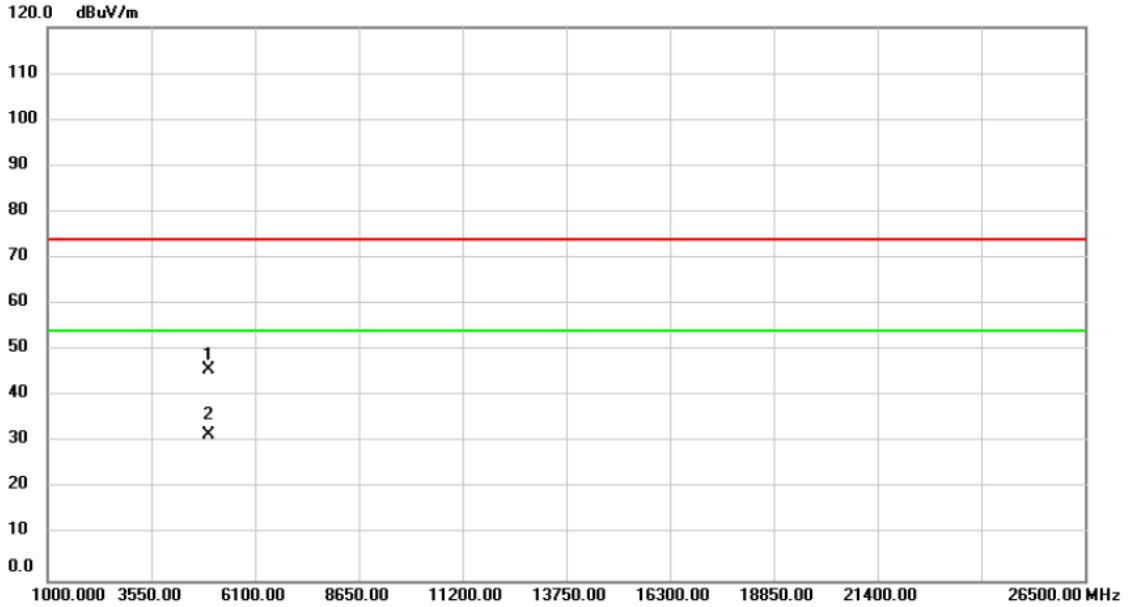

No. Mk.	Freq. MHz	Reading Level dBuV	Correct Factor dB	Measurement dBuV/m	Limit dBuV/m	Margin dB	Detector	Comment
1	4960.000	55.81	-10.19	45.62	74.00	-28.38	peak	
2 *	4960.000	41.96	-10.19	31.77	54.00	-22.23	AVG	

REMARKS:

- (1) Measurement Value = Reading Level + Correct Factor.
- (2) Margin Level = Measurement Value - Limit Value.

APPENDIX D NUMBER OF HOPPING CHANNEL

Test Mode	1/3Mbps
Test Voltage	DC 48V

Test Mode	Number of Hopping Channel	≥ Limit	Test Result
1 Mbps	79	15	Pass
3 Mbps	79	15	Pass

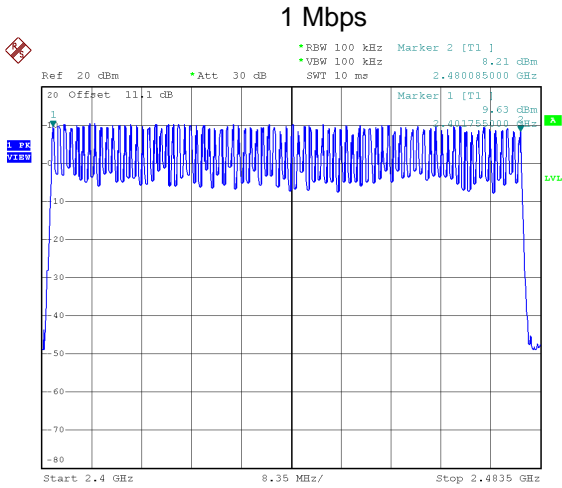

Date: 5.DEC.2019 16:28:53

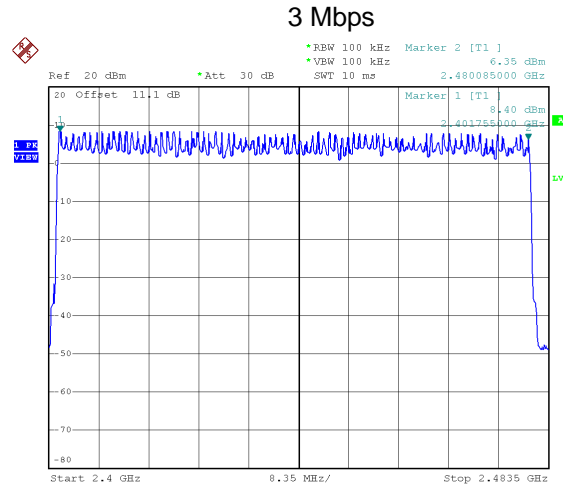

Date: 5.DEC.2019 16:53:27

APPENDIX E AVERAGE TIME OF OCCUPANCY

Test Mode :	TX Mode_1Mbps
Test Voltage	DC 48V

Data Packet	Frequency (MHz)	Pulse Duration (ms)	Dwell Time (s)	Limits (s)	Test Result
DH5	2402 MHz	2.8800	0.3072	0.4000	Pass
DH3	2402 MHz	1.6400	0.2624	0.4000	Pass
DH1	2402 MHz	0.3850	0.1232	0.4000	Pass
DH5	2441 MHz	2.8800	0.3072	0.4000	Pass
DH3	2441 MHz	1.6400	0.2624	0.4000	Pass
DH1	2441 MHz	0.3850	0.1232	0.4000	Pass
DH5	2480 MHz	2.9200	0.3115	0.4000	Pass
DH3	2480 MHz	1.6400	0.2624	0.4000	Pass
DH1	2480 MHz	0.3800	0.1216	0.4000	Pass

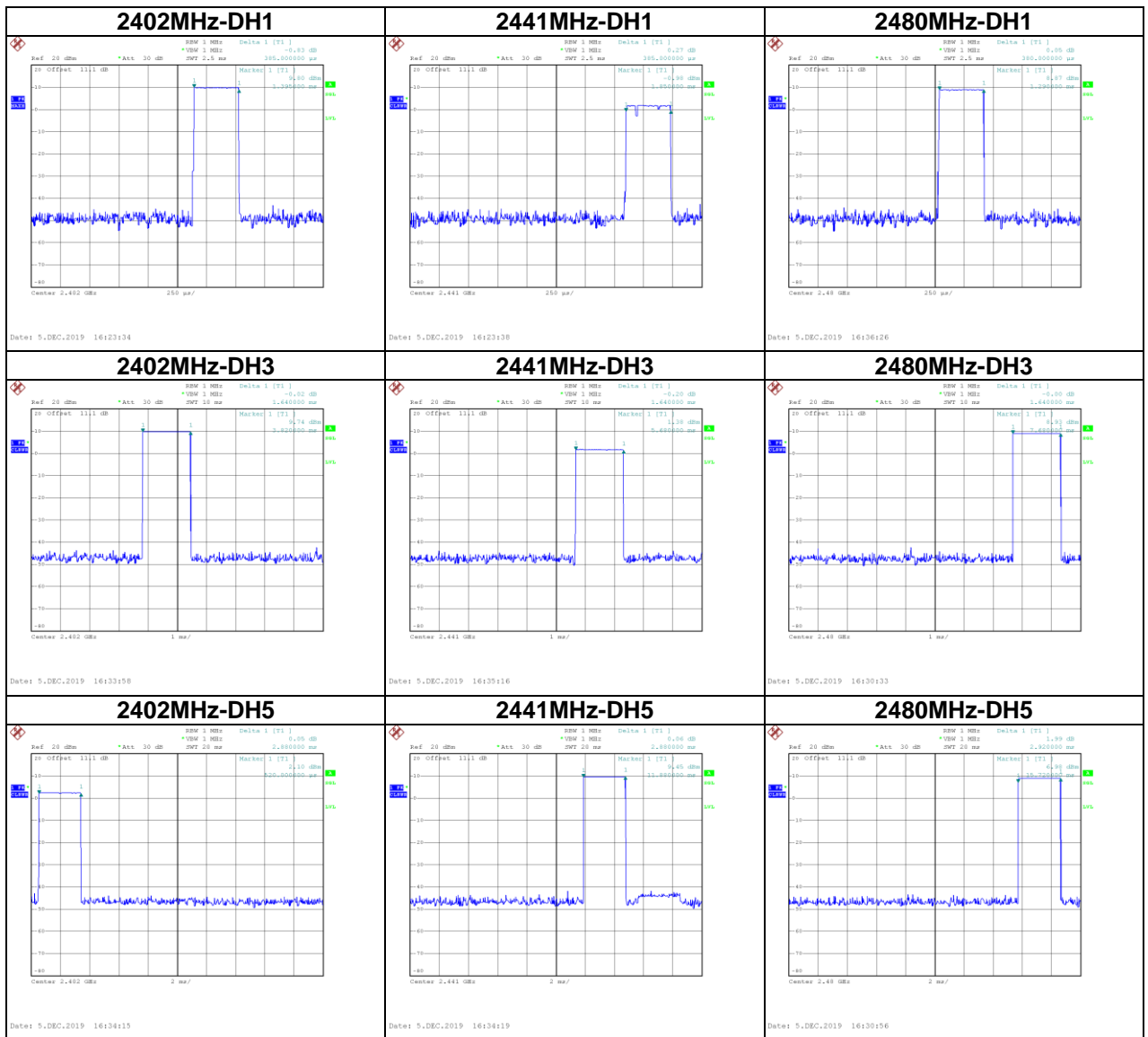

Test Mode :	TX Mode_3Mbps
Test Voltage	DC 48V

Data Packet	Frequency	Pulse Duration(ms)	Dwell Time(s)	Limits(s)	Test Result
DH5	2402 MHz	2.8800	0.3072	0.4000	Pass
DH3	2402 MHz	0.3600	0.0576	0.4000	Pass
DH1	2402 MHz	1.1500	0.3680	0.4000	Pass
DH5	2441 MHz	2.8800	0.3072	0.4000	Pass
DH3	2441 MHz	0.3800	0.0608	0.4000	Pass
DH1	2441 MHz	1.1400	0.3648	0.4000	Pass
DH5	2480 MHz	2.8800	0.3072	0.4000	Pass
DH3	2480 MHz	0.4000	0.0640	0.4000	Pass
DH1	2480 MHz	1.1500	0.3680	0.4000	Pass

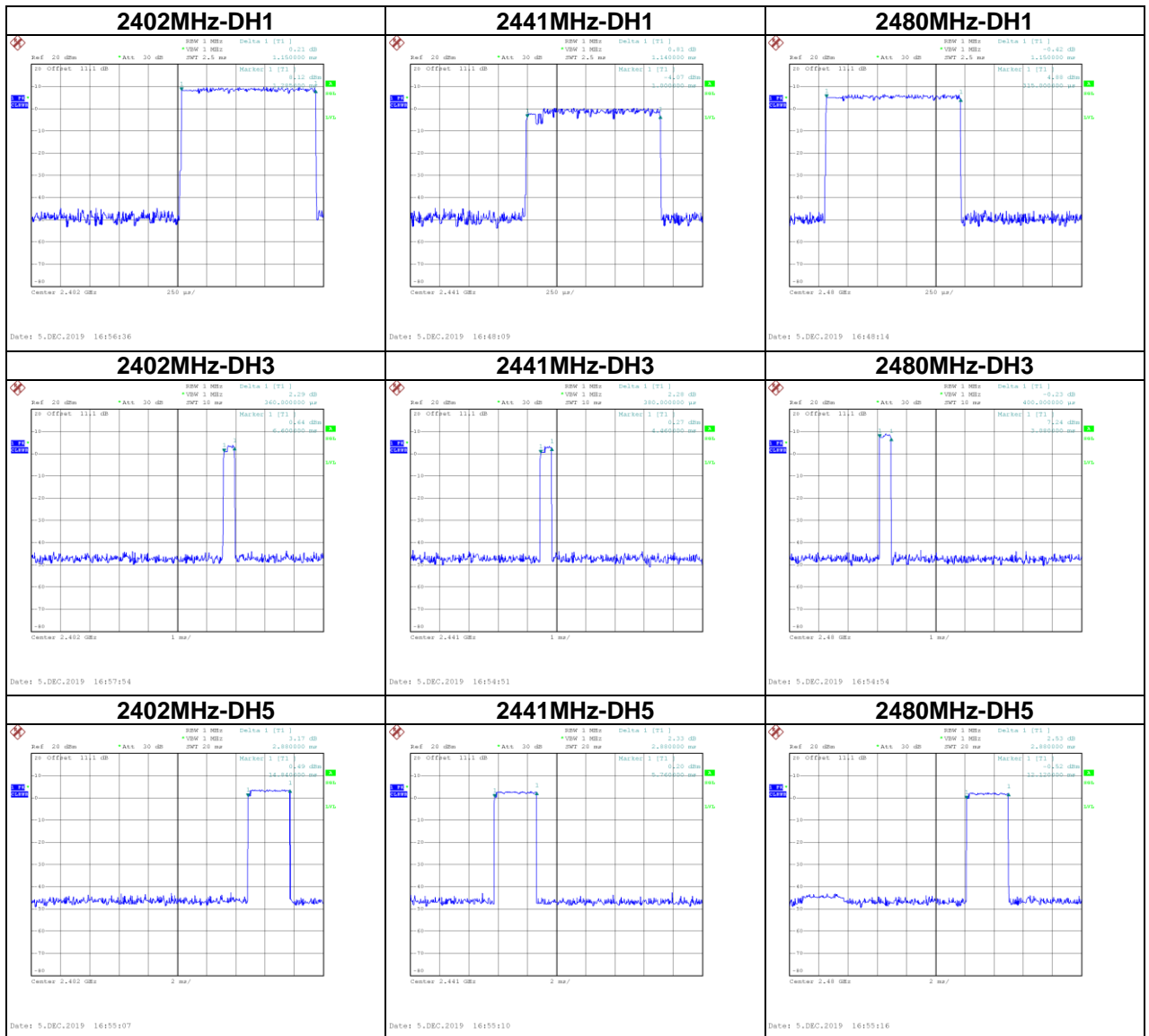

APPENDIX F HOPPING CHANNEL SEPARATION MEASUREMENT

Test Mode :	Hopping on _1Mbps
Test Voltage	DC 48V

Frequency (MHz)	Channel Separation (MHz)	2/3 of 20dB Bandwidth (MHz)	Test Result
2402	0.992	0.637	Pass
2441	0.996	0.637	Pass
2480	0.983	0.635	Pass

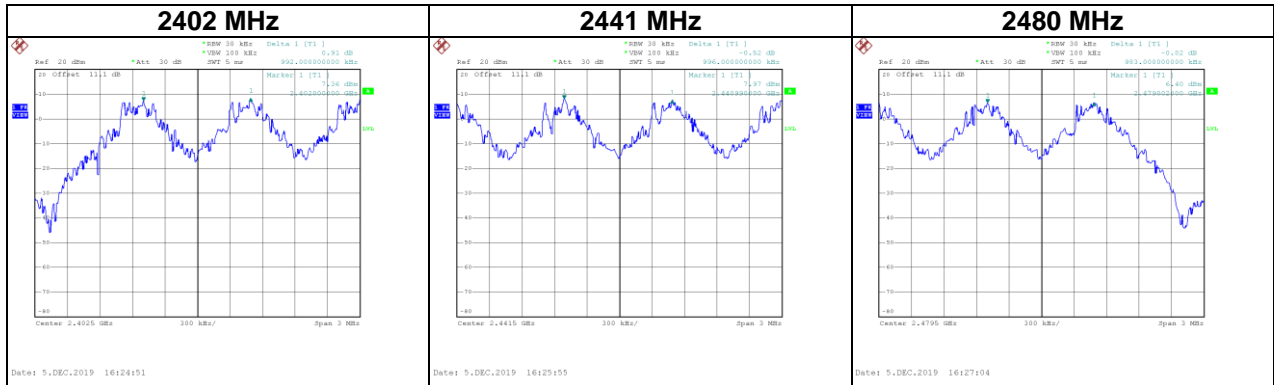

Test Mode :	Hopping on _3Mbps
Test Voltage	DC 48V

Frequency (MHz)	Channel Separation (MHz)	2/3 of 20dB Bandwidth (MHz)	Test Result
2402	1.004	0.875	Pass
2441	0.999	0.869	Pass
2480	1.008	0.869	Pass

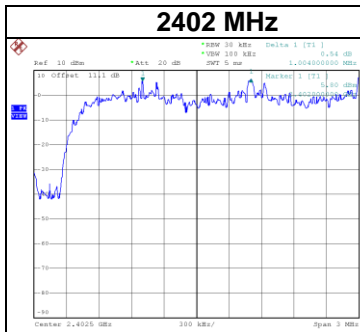

Date: 14,DEC,2019 08:38:35

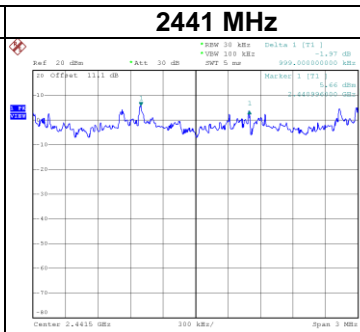

Date: 5,DEC,2019 16:50:35

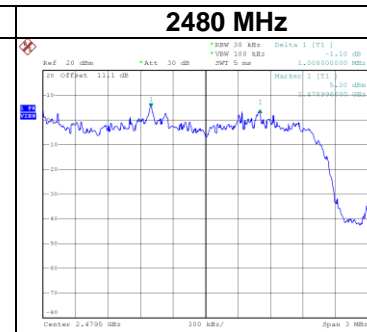

Date: 5,DEC,2019 16:51:39

APPENDIX G BANDWIDTH

Test Mode :	TX Mode _1Mbps
Test Voltage	DC 48V

Frequency (MHz)	20dB Bandwidth (MHz)	99% Occupied BW (MHz)	Test Result
2402	0.956	0.896	Pass
2441	0.956	0.892	Pass
2480	0.952	0.892	Pass

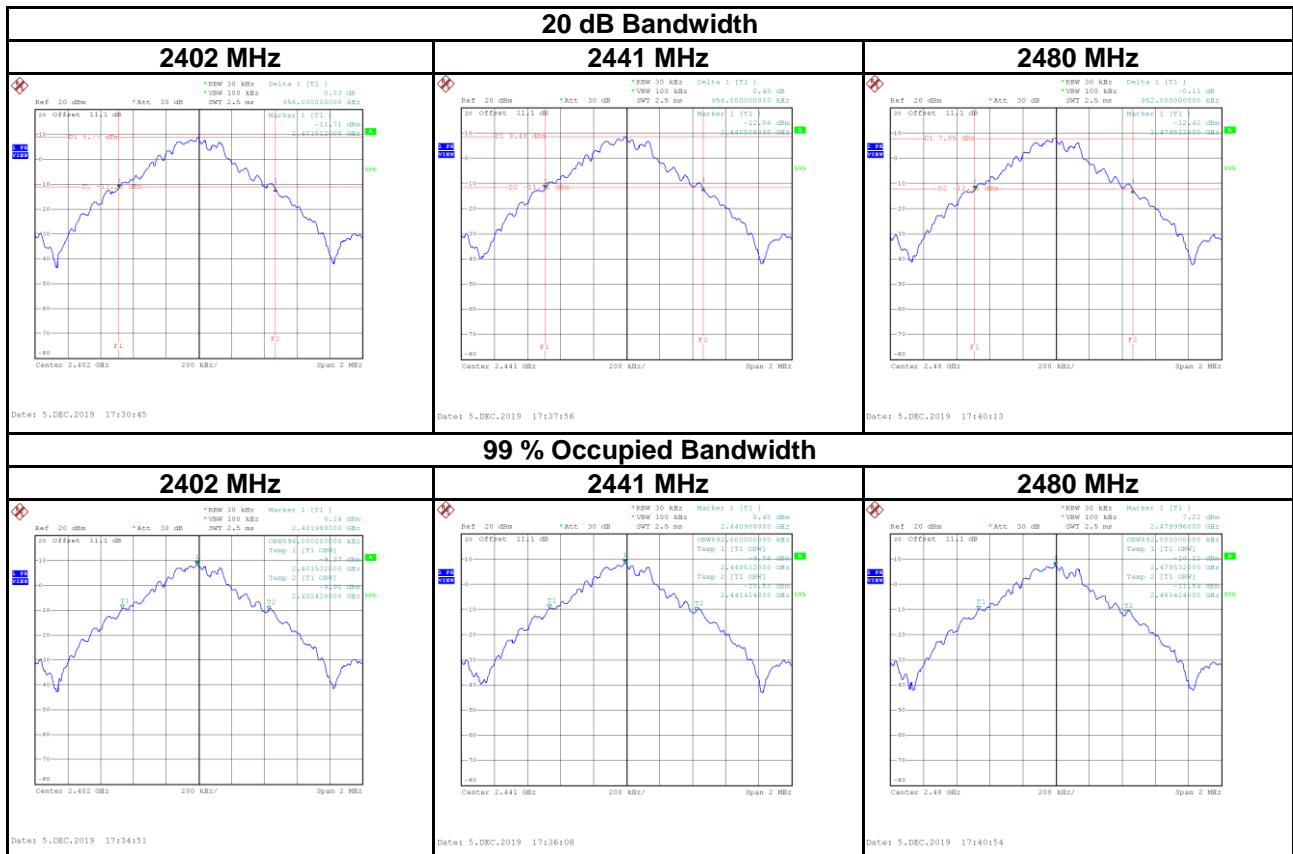

Test Mode :	TX Mode _3Mbps
Test Voltage	DC 48V

Frequency (MHz)	20dB Bandwidth (MHz)	99% Occupied BW (MHz)	Test Result
2402	1.312	1.184	Pass
2441	1.304	1.176	Pass
2480	1.304	1.180	Pass

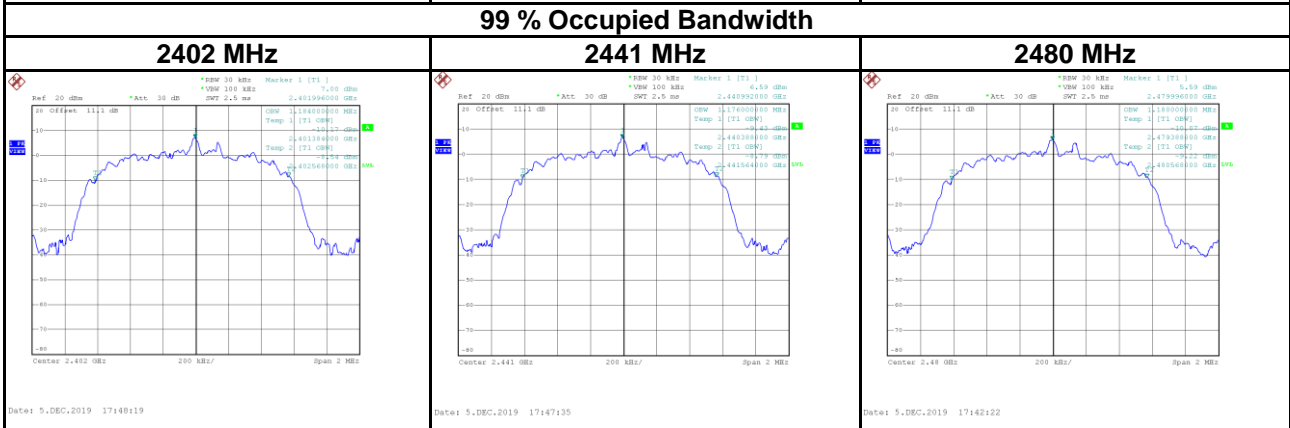
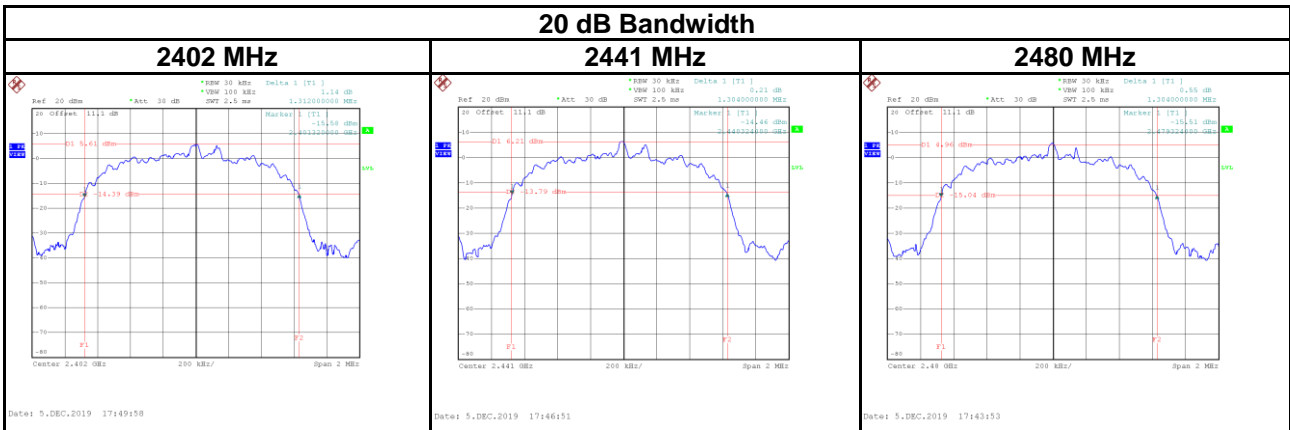

APPENDIX H OUTPUT POWER

Test Mode :	TX Mode _1Mbps	Tested Date	2019/12/6
Test Voltage	DC 48V		

Frequency (MHz)	Conducted Power (dBm)	Conducted Power (W)	Max. Limit (dBm)	Max. Limit (W)	Test Result
2402	0.93	0.0012	21.00	0.1250	Pass
2441	1.08	0.0013	21.00	0.1250	Pass
2480	0.23	0.0011	21.00	0.1250	Pass

Test Mode :	TX Mode _2Mbps	Tested Date	2019/12/6
Test Voltage	DC 48V		

Frequency (MHz)	Conducted Power (dBm)	Conducted Power (W)	Max. Limit (dBm)	Max. Limit (W)	Test Result
2402	5.31	0.0034	21.00	0.1250	Pass
2441	5.04	0.0032	21.00	0.1250	Pass
2480	3.88	0.0024	21.00	0.1250	Pass

Test Mode :	TX Mode _3Mbps	Tested Date	2019/12/6
Test Voltage	DC 48V		

Frequency (MHz)	Conducted Power (dBm)	Conducted Power (W)	Max. Limit (dBm)	Max. Limit (W)	Test Result
2402	5.55	0.0036	21.00	0.1250	Pass
2441	5.32	0.0034	21.00	0.1250	Pass
2480	4.28	0.0027	21.00	0.1250	Pass

APPENDIX I ANTENNA CONDUCTED SPURIOUS EMISSION

Test Mode	1Mbps
Test Voltage	DC 48V

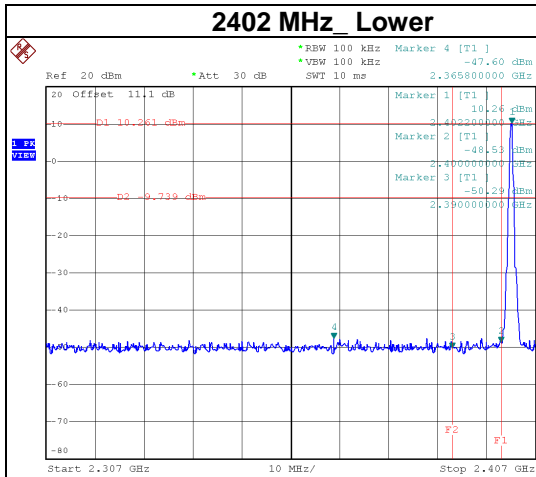

Date: 5.DEC.2019 16:17:15

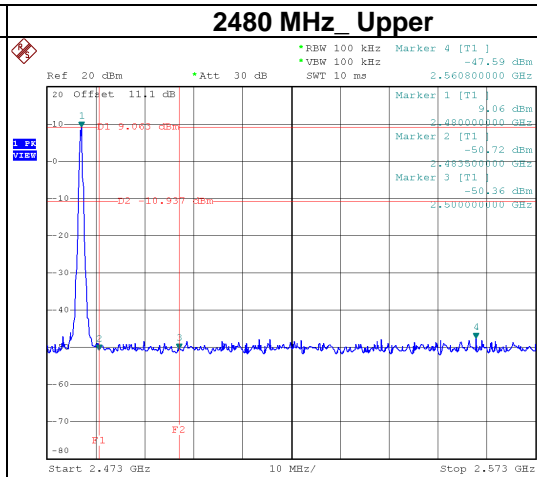

Date: 5.DEC.2019 16:20:57

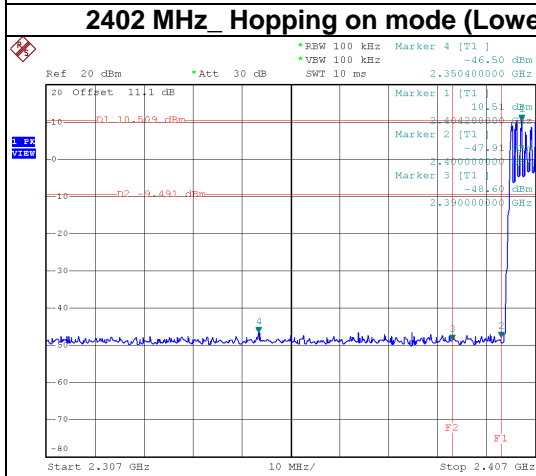

Date: 5.DEC.2019 16:29:26

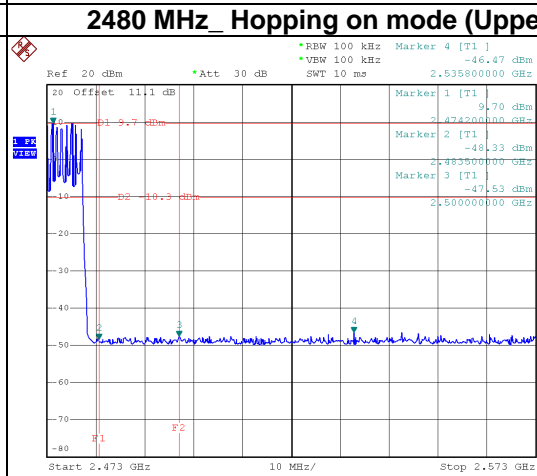

Date: 5.DEC.2019 16:30:00

2402 MHz – 10th Harmonics

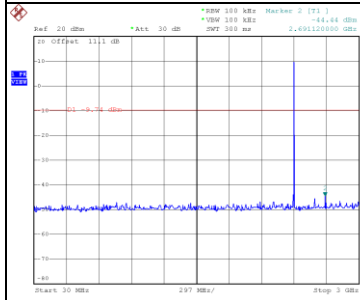

Date: 5,DEC,2019 16:18:03

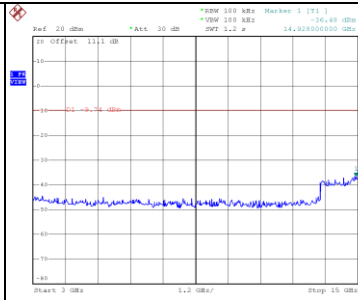

Date: 5,DEC,2019 16:18:09

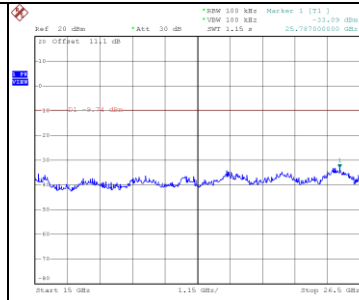

Date: 5,DEC,2019 16:18:16

2441 MHz – 10th Harmonics

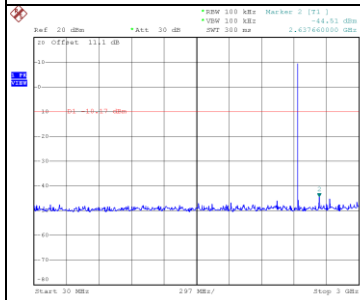

Date: 5,DEC,2019 16:19:37

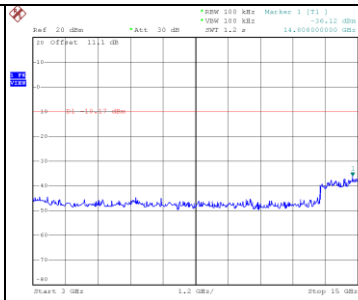

Date: 5,DEC,2019 16:19:44

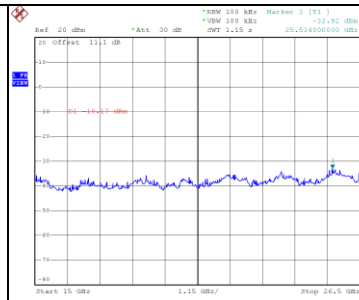

Date: 5,DEC,2019 16:19:50

2480 MHz – 10th Harmonics

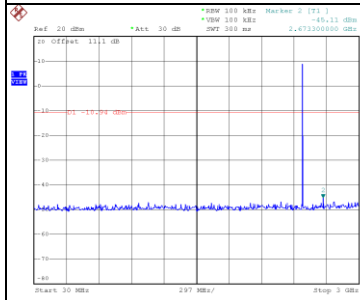

Date: 5,DEC,2019 16:21:50

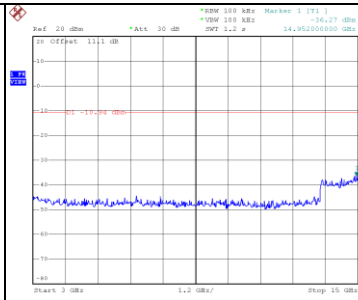

Date: 5,DEC,2019 16:21:56

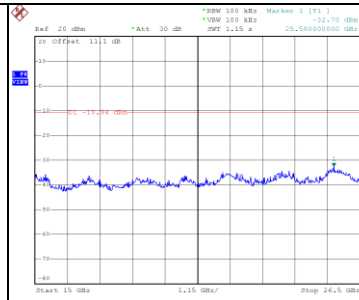

Date: 5,DEC,2019 16:22:03

Test Mode	3Mbps
Test Voltage	DC 48V

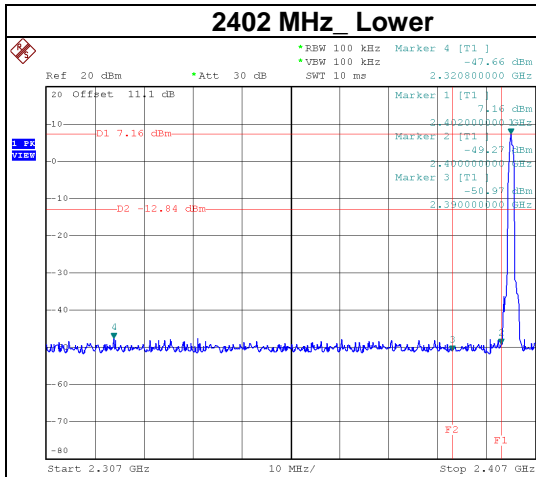

Date: 5.DEC.2019 16:43:27

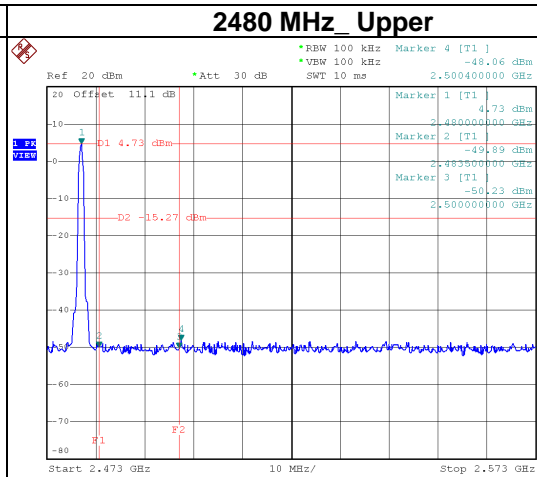

Date: 5.DEC.2019 16:46:24

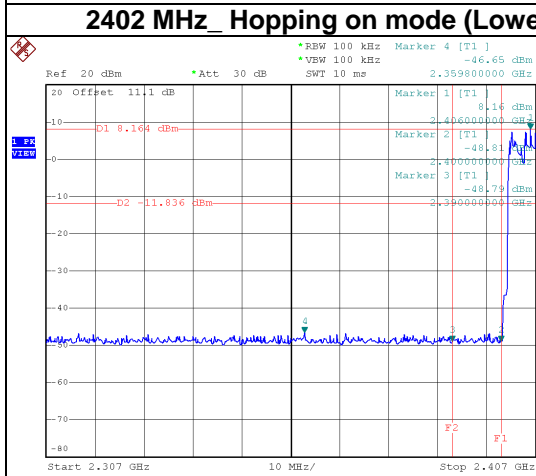

Date: 5.DEC.2019 16:54:01

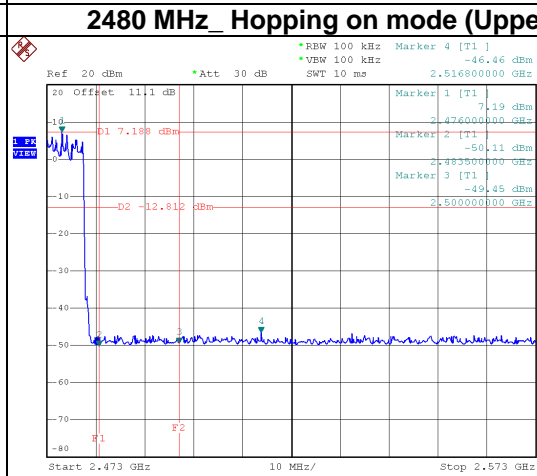

Date: 5.DEC.2019 16:54:35

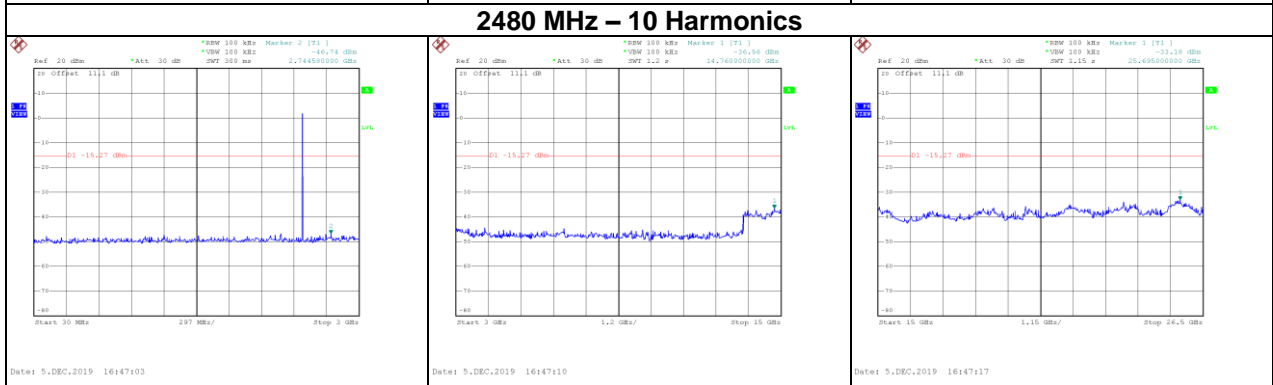
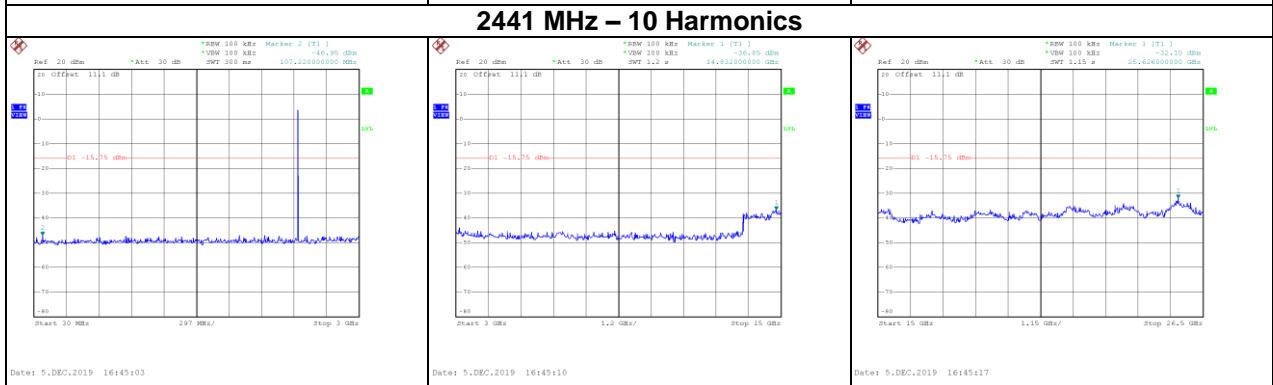
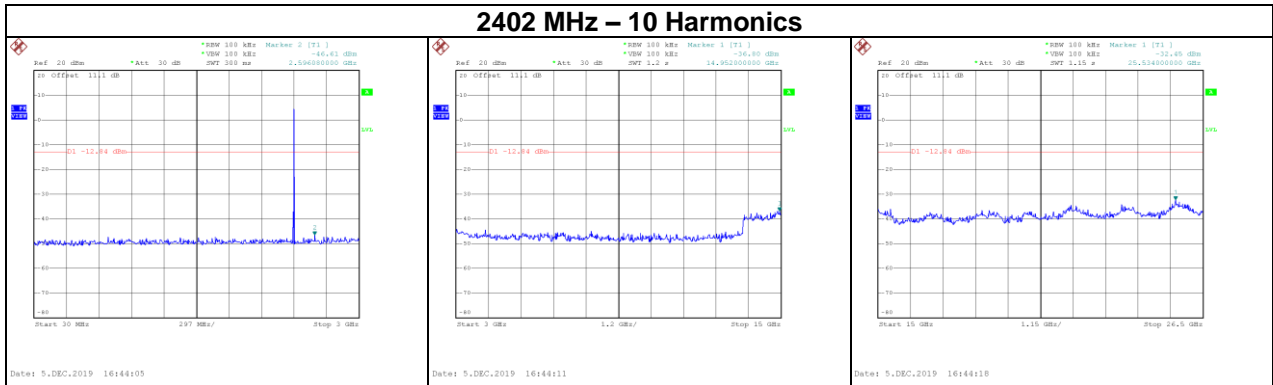

End of Test Report