

FCC Radio Test Report

FCC ID: EROTS770

Report No. : BTL-FCCP-3-2004T143
Equipment : 7 inch Touch Screen Surface mount
Model Name : M201923005, TS-770-B-S, TS-770-W-S
Brand Name : CRESTRON
Applicant : Crestron Electronics, Inc.
Address : 15 Volvo Drive, Rockleigh, NJ 07647

Radio Function : WLAN 2.4 GHz

FCC Rule Part(s) : FCC Part15, Subpart C (15.247)
Measurement Procedure(s) : ANSI C63.10-2013

Date of Receipt : 2020/4/27
Date of Test : 2020/4/27 ~ 2020/5/11
Issued Date : 2020/5/27

The above equipment has been tested and found in compliance with the requirement of the above standards by BTL Inc.

Prepared by :

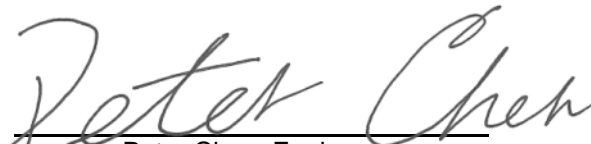
Peter Chen, Engineer



Approved by :

Scott Hsu, Manager

BTL Inc.

No.18, Ln. 171, Sec. 2, Jiuzong Rd., Neihu Dist., Taipei City 114, Taiwan

Tel: +886-2-2657-3299

Fax: +886-2-2657-3331

Web: www.newbtl.com

Declaration

BTL represents to the client that testing is done in accordance with standard procedures as applicable and that test instruments used has been calibrated with standards traceable to international standard(s) and/or national standard(s).

BTL's reports apply only to the specific samples tested under conditions. It is manufacture's responsibility to ensure that additional production units of this model are manufactured with the identical electrical and mechanical components. **BTL** shall have no liability for any declarations, inferences or generalizations drawn by the client or others from **BTL** issued reports.

The report must not be used by the client to claim product certification, approval, or endorsement by NIST, A2LA, or any agency of the U.S. Government.

This report is the confidential property of the client. As a mutual protection to the clients, the public and ourselves, the test report shall not be reproduced, except in full, without our written approval.

BTL's laboratory quality assurance procedures are in compliance with the **ISO/IEC 17025** requirements, and accredited by the conformity assessment authorities listed in this test report.

BTL is not responsible for the sampling stage, so the results only apply to the sample as received.

The information, data and test plan are provided by manufacturer which may affect the validity of results, so it is manufacturer's responsibility to ensure that the apparatus meets the essential requirements of applied standards and in all the possible configurations as representative of its intended use.

Limitation

For the use of the authority's logo is limited unless the Test Standard(s)/Scope(s)/Item(s) mentioned in this test report is (are) included in the conformity assessment authorities acceptance respective.

Please note that the measurement uncertainty is provided for informational purpose only and are not use in determining the Pass/Fail results.

CONTENTS

REPORT ISSUED HISTORY	5
1 SUMMARY OF TEST RESULTS	6
1.1 TEST FACILITY	7
1.2 MEASUREMENT UNCERTAINTY	7
1.3 TEST ENVIRONMENT CONDITIONS	8
1.4 TABLE OF PARAMETERS OF TEXT SOFTWARE SETTING	8
1.5 DUTY CYCLE	9
2 GENERAL INFORMATION	11
2.1 DESCRIPTION OF EUT	11
2.2 TEST MODES	12
2.3 BLOCK DIAGRAM SHOWING THE CONFIGURATION OF SYSTEM TESTED	13
2.4 SUPPORT UNITS	13
3 RADIATED EMISSIONS TEST	14
3.1 LIMIT	14
3.2 TEST PROCEDURE	15
3.3 DEVIATION FROM TEST STANDARD	15
3.4 TEST SETUP	15
3.5 EUT OPERATING CONDITIONS	16
3.6 TEST RESULT – 30 MHZ TO 1 GHZ	17
3.7 TEST RESULT – ABOVE 1 GHZ	17
4 BANDWIDTH TEST	18
4.1 LIMIT	18
4.2 TEST PROCEDURE	18
4.3 DEVIATION FROM TEST STANDARD	18
4.4 TEST SETUP	18
4.5 EUT OPERATING CONDITIONS	18
4.6 TEST RESULT	18
5 OUTPUT POWER TEST	19
5.1 LIMIT	19
5.2 TEST PROCEDURE	19
5.3 DEVIATION FROM TEST STANDARD	19
5.4 TEST SETUP	19
5.5 EUT OPERATING CONDITIONS	19
5.6 TEST RESULT	19
6 POWER SPECTRAL DENSITY	20
6.1 LIMIT	20
6.2 TEST PROCEDURE	20
6.3 DEVIATION FROM TEST STANDARD	20
6.4 TEST SETUP	20
6.5 EUT OPERATING CONDITIONS	20
6.6 TEST RESULT	20
7 ANTENNA CONDUCTED SPURIOUS EMISSIONS TEST	21
7.1 LIMIT	21
7.2 TEST PROCEDURE	21
7.3 DEVIATION FROM TEST STANDARD	21
7.4 TEST SETUP	21
7.5 EUT OPERATING CONDITIONS	21
7.6 TEST RESULT	21

8	LIST OF MEASURING EQUIPMENTS	22
9	EUT TEST PHOTO	23
10	EUT PHOTOS	23
APPENDIX A	RADIATED EMISSIONS - 30 MHZ TO 1 GHZ	24
APPENDIX B	RADIATED EMISSIONS - ABOVE 1 GHZ	27
APPENDIX C	BANDWIDTH	60
APPENDIX D	OUTPUT POWER	65
APPENDIX E	POWER SPECTRAL DENSITY	67
APPENDIX F	ANTENNA CONDUCTED SPURIOUS EMISSIONS	70

REPORT ISSUED HISTORY

Report Version	Description	Issued Date
R00	Original Issue.	2020/5/27

1 SUMMARY OF TEST RESULTS

Test procedures according to the technical standards.

FCC Part 15, Subpart C (15.247)				
Standard(s) Section	Description	Test Result	Judgement	Remark
15.207	AC Power Line Conducted Emissions	-----	N/A	NOTE(3)
15.205 15.209 15.247(d)	Radiated Emissions	APPENDIX A APPENDIX B	Pass	-----
15.247(a)	Bandwidth	APPENDIX C	Pass	-----
15.247(b)	Output Power	APPENDIX D	Pass	-----
15.247(e)	Power Spectral Density	APPENDIX E	Pass	-----
15.247(d)	Antenna conducted Spurious Emission	APPENDIX F	Pass	-----
15.203	Antenna Requirement	-----	Pass	-----

NOTE:

- (1) "N/A" denotes test is not applicable in this Test Report.
- (2) The report format version is TP.1.1.1.
- (3) Input power is supplied by POE.

1.1 TEST FACILITY

The test facilities used to collect the test data in this report:

No. 68-1, Ln. 169, Sec. 2, Datong Rd., Xizhi Dist., New Taipei City 221, Taiwan

The test sites and facilities are covered under FCC RN: 674415 and DN: TW0659.

- C05 CB08 CB11 CB15 CB16
 SR06

No.18, Ln. 171, Sec. 2, Jiuzong Rd., Neihu Dist., Taipei City 114, Taiwan

The test sites and facilities are covered under FCC RN: 325517 and DN: TW1115.

- C03 CB18 CB19

1.2 MEASUREMENT UNCERTAINTY

The reported uncertainty of measurement $y \pm U$, where expanded uncertainty U is based on a standard uncertainty multiplied by a coverage factor of $k = 2$, providing a level of confidence of approximately **95 %**. The measurement instrumentation uncertainty considerations contained in CISPR 16-4-2. The BTL measurement uncertainty is less than the CISPR 16-4-2 U_{cispr} requirement.

A. Radiated emissions test :

Test Site	Measurement Frequency Range	$U, (dB)$
CB15	0.03 GHz ~ 0.2 GHz	4.17
	0.2 GHz ~ 1 GHz	4.72
	1 GHz ~ 6 GHz	5.21
	6 GHz ~ 18 GHz	5.51
	18 GHz ~ 26 GHz	3.69
	26 GHz ~ 40 GHz	4.23

B. Conducted test :

Test Item	$U, (dB)$
Bandwidth	1.13
Output power	1.06
Power Spectral Density	1.20
Conducted Spurious emissions	1.14
Conducted Band edges	1.13

NOTE:

Unless specifically mentioned, the uncertainty of measurement has not been taken into account to declare the compliance or non-compliance to the specification.

1.3 TEST ENVIRONMENT CONDITIONS

Test Item	Environment Condition	Test Voltage	Tested by
Radiated emissions below 1 GHz	22 °C, 65 %	DC 48V	Hunter Chiang
Radiated emissions above 1 GHz	22 °C, 65 %	DC 48V	Hunter Chiang
Bandwidth	24.3 °C, 56 %	DC 48V	Jay Kao
Output Power	24.3 °C, 56 %	DC 48V	Jay Kao
Power Spectral Density	24.3 °C, 56 %	DC 48V	Jay Kao
Antenna conducted Spurious Emission	24.3 °C, 56 %	DC 48V	Jay Kao

1.4 TABLE OF PARAMETERS OF TEXT SOFTWARE SETTING

Test Software	QRCT V4.0.00093			
Mode	2412 MHz	2437 MHz	2462 MHz	Data Rate
IEEE 802.11b	16	16	16	1 Mbps
IEEE 802.11g	12	13	12	6 Mbps
IEEE 802.11n (HT20)	12	13	12	MCS 0
Mode	2422 MHz	2437 MHz	2452 MHz	Data Rate
IEEE 802.11n (HT40)	11	12	11	MCS 0

1.5 DUTY CYCLE

If duty cycle is $\geq 98\%$, duty factor is not required.
 If duty cycle is $< 98\%$, duty factor shall be considered.

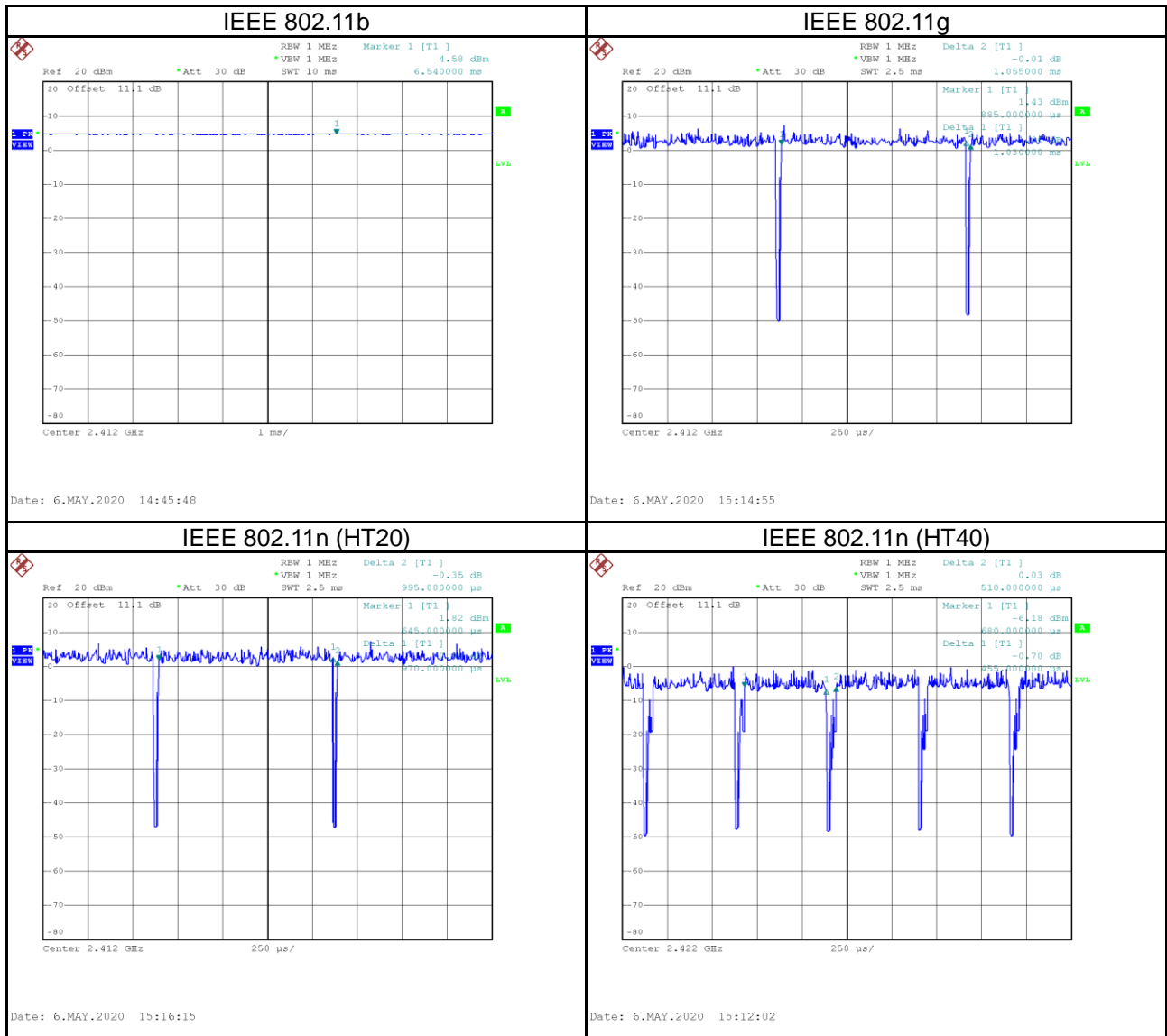

Remark	Delta 1			Delta 2	On Time/Period	10 log(1/Duty Cycle)
Mode	ON (ms)	Numbers (ON)	On Time (B) (ms)	Period (ON+OFF) (ms)	Duty Cycle (%)	Duty Factor (dB)
IEEE 802.11b	1.000	1	1.000	1.000	100.00%	0.00
IEEE 802.11g	1.030	1	1.030	1.055	97.63%	0.10
IEEE 802.11n (HT20)	0.970	1	0.970	0.995	97.49%	0.11
IEEE 802.11n (HT40)	0.455	1	0.455	0.510	89.22%	0.50

NOTE:

For IEEE 802.11g:

For radiated emissions frequency above 1 MHz, the resolution bandwidth of test receiver/spectrum analyzer is 1 MHz and the video bandwidth is 1 kHz (Duty cycle < 98%).

For IEEE 802.11n (HT20):

For radiated emissions frequency above 1 MHz, the resolution bandwidth of test receiver/spectrum analyzer is 1 MHz and the video bandwidth is 1.5 kHz (Duty cycle < 98%).

For IEEE 802.11n (HT40):

For radiated emissions frequency above 1 MHz, the resolution bandwidth of test receiver/spectrum analyzer is 1 MHz and the video bandwidth is 2.2 kHz (Duty cycle < 98%).

2 GENERAL INFORMATION

2.1 DESCRIPTION OF EUT

Equipment	7 inch Touch Screen Surface mount
Model Name	M201923005, TS-770-B-S, TS-770-W-S
Brand Name	CRESTRON
Model Difference	M201923005 includes two series: TS-770-B-S, TS-770-W-S All modes are identical to each other except below: B: Black, W: White, S: Smooth
Power Source	DC voltage supplied from POE.
Power Rating	I/P: 48 VDC 350mA (802.3at type 1), 48 VDC 600mA (802.3at type 2)
Products Covered	N/A
Frequency Range	2400 MHz ~ 2483.5 MHz
Operation Frequency	2412 MHz ~ 2462 MHz
Modulation Technology	IEEE 802.11b: DSSS IEEE 802.11g: OFDM IEEE 802.11n: OFDM
Transfer Rate	IEEE 802.11b: 11/5.5/2/1 Mbps IEEE 802.11g: 54/48/36/24/18/12/9/6 Mbps IEEE 802.11n: up to 150 Mbps
Output Power Max.	IEEE 802.11b: 20.01 dBm (0.1002 W) IEEE 802.11g: 20.64 dBm (0.1159 W) IEEE 802.11n (HT20): 20.83 dBm (0.1211 W) IEEE 802.11n (HT40): 20.62 dBm (0.1153 W)
Test Model	M201923005
Sample Status	Engineering Sample
EUT Modification(s)	N/A

NOTE:

(1) For a more detailed features description, please refer to the manufacturer's specifications or the user's manual.

(2) Channel List:

Channel	Frequency (MHz)	Channel	Frequency (MHz)	Channel	Frequency (MHz)
01	2412	05	2432	09	2452
02	2417	06	2437	10	2457
03	2422	07	2442	11	2462
04	2427	08	2447		

(3) Table for Filed Antenna:

Ant.	Brand	Model Name	Antenna Type	Connector	Gain (dBi)
1	YAGEO	TS WLAN MAIN	PIFA	IPEX	-1.64

2.2 TEST MODES

Test Items	Test mode	Channel	Note
Transmitter Radiated Emissions (below 1GHz)	TX Mode_IEEE 802.11n (HT40)	09	-
Transmitter Radiated Emissions (above 1GHz)	TX Mode_IEEE 802.11b	01/11	Bandedge
	TX Mode_IEEE 802.11g		
	TX Mode_IEEE 802.11n (HT20)	03/09	
	TX Mode_IEEE 802.11n (HT40)		
	TX Mode_IEEE 802.11b	01/06/11	Harmonic
	TX Mode_IEEE 802.11g		
	TX Mode_IEEE 802.11n (HT20)		
		TX Mode_IEEE 802.11n (HT40)	03/06/09
Bandwidth	TX Mode_IEEE 802.11b	01/06/11	-
	TX Mode_IEEE 802.11g		
	TX Mode_IEEE 802.11n (HT20)	03/06/09	
	TX Mode_IEEE 802.11n (HT40)		
Output Power	TX Mode_IEEE 802.11b	01/06/11	-
	TX Mode_IEEE 802.11g		
	TX Mode_IEEE 802.11n (HT20)	03/06/09	
	TX Mode_IEEE 802.11n (HT40)		
Power Spectral Density	TX Mode_IEEE 802.11b	01/06/11	-
	TX Mode_IEEE 802.11g		
	TX Mode_IEEE 802.11n (HT20)	03/06/09	
	TX Mode_IEEE 802.11n (HT40)		
Antenna conducted Spurious Emission	TX Mode_IEEE 802.11b	01/06/11	-
	TX Mode_IEEE 802.11g		
	TX Mode_IEEE 802.11n (HT20)	03/06/09	
	TX Mode_IEEE 802.11n (HT40)		

NOTE:

- (1) The Radiated emissions test was verified based on the worst conducted power and Bandwidth test results reported in the original report.
- (2) For radiated emission band edge test, both Vertical and Horizontal are evaluated, but only the worst case (Vertical) is recorded.
- (3) All X, Y and Z axes are evaluated, but only the worst case (X axis) is recorded.
- (4) There were no emissions found below 30 MHz within 20 dB of the limit.

2.3 BLOCK DIAGRAM SHOWING THE CONFIGURATION OF SYSTEM TESTED

Equipment letters and Cable numbers refer to item numbers described in the tables of clause 2.4.

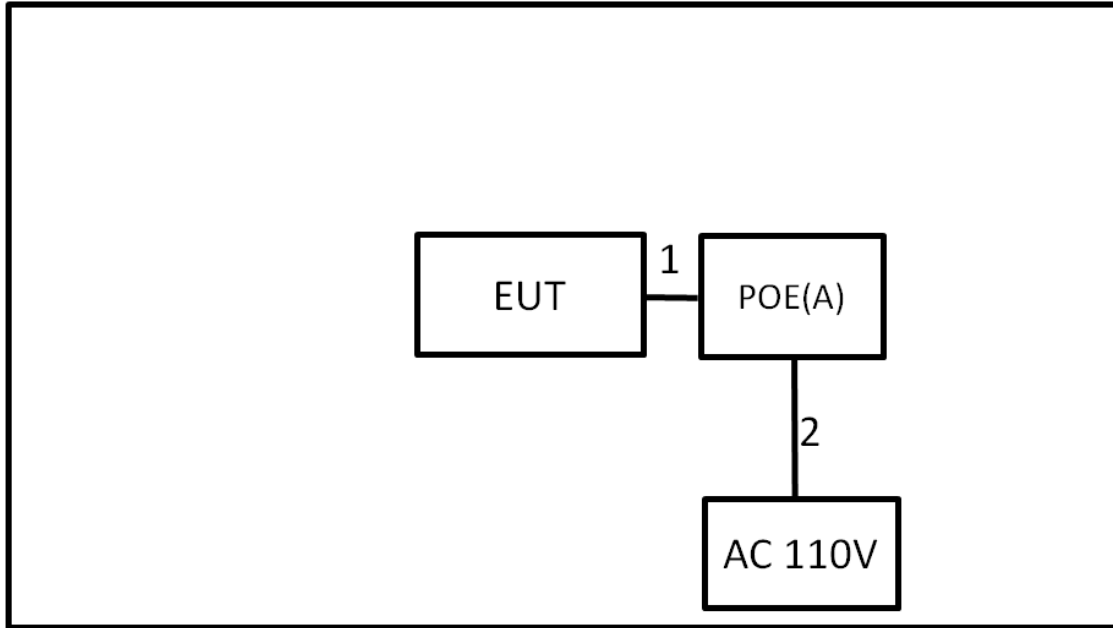

2.4 SUPPORT UNITS

Item	Equipment	Brand	Model No.	Series No.	Remarks
A	MANAGED POE SWITCH	CRESTRON	CEN-SWPOE-16	N/A	Supplied by test requester.

Item	Shielded	Ferrite Core	Length	Cable Type	Remarks
1	YES	NO	2m	RJ45	Supplied by test requester.
2	NO	NO	1m	Power Cable	Furnished by test lab.

3 RADIATED EMISSIONS TEST

3.1 LIMIT

In case the emission fall within the restricted band specified on 15.205, then the 15.209 limit in the table below has to be followed.

LIMITS OF RADIATED EMISSIONS MEASUREMENT (9 kHz to 1000 MHz)

Frequency (MHz)	Field Strength (microvolts/meter)	Measurement Distance (meters)
0.009~0.490	2400/F(KHz)	300
0.490~1.705	24000/F(KHz)	30
1.705~30.0	30	30
30~88	100	3
88~216	150	3
216~960	200	3
960~1000	500	3

LIMITS OF RADIATED EMISSIONS MEASUREMENT (Above 1000 MHz)

Frequency (MHz)	Radiated Emissions (dBuV/m)		Measurement Distance (meters)
	Peak	Average	
Above 1000	74	54	3

NOTE:

- (1) The limit for radiated test was performed according to FCC Part 15, Subpart C.
- (2) The tighter limit applies at the band edges.
- (3) Emission level (dBuV/m)=20log Emission level (uV/m).
- (4) The test result calculated as following:

Measurement Value = Reading Level + Correct Factor

Correct Factor = Antenna Factor + Cable Loss - Amplifier Gain(if use)

Margin Level = Measurement Value - Limit Value

Calculation example:

Reading Level		Correct Factor		Measurement Value
19.11	+	2.11	=	21.22

Measurement Value		Limit Value		Margin Level
21.22	-	54	=	-32.78

Spectrum Parameter	Setting
Attenuation	Auto
Start Frequency	1000 MHz
Stop Frequency	10th carrier harmonic
RBW / VBW (Emission in restricted band)	1MHz / 3MHz for Peak, 1MHz / 1/T for Average

Spectrum Parameter	Setting
Attenuation	Auto
Start ~ Stop Frequency	9KHz~90KHz for PK/AVG detector
Start ~ Stop Frequency	90KHz~110KHz for QP detector
Start ~ Stop Frequency	110KHz~490KHz for PK/AVG detector
Start ~ Stop Frequency	490KHz~30MHz for QP detector
Start ~ Stop Frequency	30MHz~1000MHz for QP detector

3.2 TEST PROCEDURE

- a. The measuring distance of 3 m shall be used for measurements. The EUT was placed on the top of a rotating table 0.8 meter above the ground at a 3 meter semi-anechoic chamber. The table was rotated 360 degrees to determine the position of the highest radiation.(below 1GHz)
- b. The measuring distance of 3 m shall be used for measurements. The EUT was placed on the top of a rotating table 1.5 meter above the ground at a 3 meter semi-anechoic chamber. The table was rotated 360 degrees to determine the position of the highest radiation.(above 1GHz)
- c. The height of the equipment or of the substitution antenna shall be 0.8 m or 1.5 m, the height of the test antenna shall vary between 1 m to 4 m. Both horizontal and vertical polarizations of the antenna are set to make the measurement.
- d. For each suspected emission, the EUT was arranged to its worst case and then the antenna was tuned to heights find the maximum reading (used Bore sight function).
- e. The receiver system was set to peak and average detect function and specified bandwidth with maximum hold mode when the test frequency is above 1GHz.
- f. The initial step in collecting radiated emission data is a receiver peak detector mode pre-scanning the measurement frequency range. Significant peaks are then marked and then Quasi Peak detector mode re-measured.
- g. All readings are Peak unless otherwise stated QP in column of Note. Peak denotes that the Peak reading compliance with the QP Limits and then QP Mode measurement didn't perform. (below 1GHz)
- h. All readings are Peak Mode value unless otherwise stated AVG in column of Note. If the Peak Mode Measured value compliance with the Peak Limits and lower than AVG Limits, the EUT shall be deemed to meet both Peak & AVG Limits and then only Peak Mode was measured, but AVG Mode didn't perform. (above 1GHz)
- i. For the actual test configuration, please refer to the related Item – EUT TEST PHOTO.

3.3 DEVIATION FROM TEST STANDARD

No deviation.

3.4 TEST SETUP

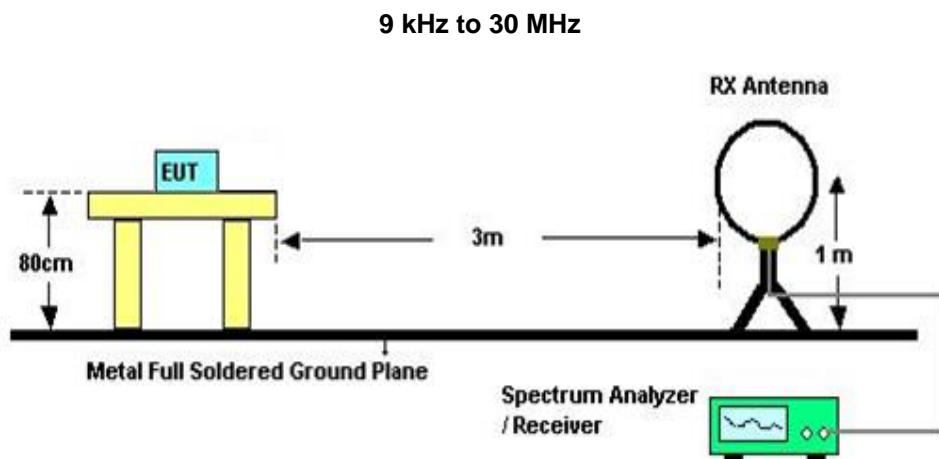

30 MHz to 1 GHz

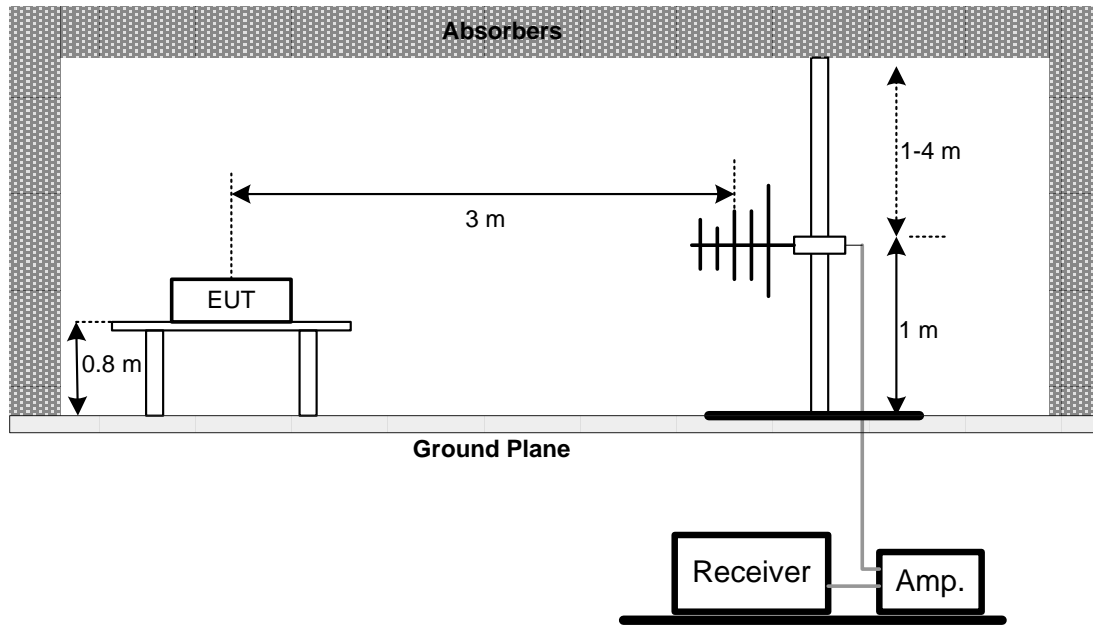

Above 1 GHz

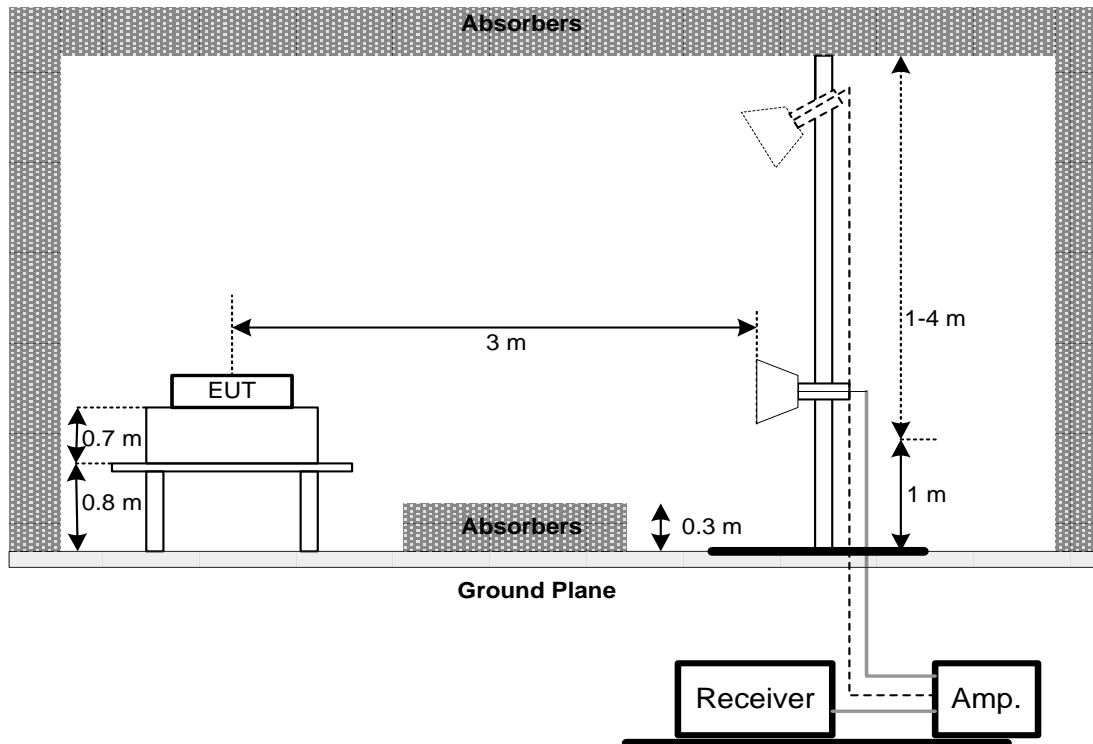

3.5 EUT OPERATING CONDITIONS

The EUT was programmed to be in continuously transmitting mode.

3.6 TEST RESULT – 30 MHZ TO 1 GHZ

Please refer to the APPENDIX A.

3.7 TEST RESULT – ABOVE 1 GHZ

Please refer to the APPENDIX B.

NOTE:

- (1) No limit: This is fundamental signal, the judgment is not applicable.
For fundamental signal judgment was referred to Peak output test.

4 BANDWIDTH TEST

4.1 LIMIT

FCC Part15, Subpart C (15.247)		
Section	Test Item	Limit
15.247(a)	6 dB Bandwidth	500 kHz

4.2 TEST PROCEDURE

- The EUT was directly connected to the spectrum analyzer and antenna output port as show in the block diagram below.
- Spectrum Setting: RBW= 100KHz, VBW=300KHz, Sweep time = 2.5 ms.

4.3 DEVIATION FROM TEST STANDARD

No deviation.

4.4 TEST SETUP



4.5 EUT OPERATING CONDITIONS

The EUT was programmed to be in continuously transmitting mode.

4.6 TEST RESULT

Please refer to the APPENDIX C.

5 OUTPUT POWER TEST**5.1 LIMIT**

FCC Part15, Subpart C (15.247)		
Section	Test Item	Limit
15.247(b)	Maximum Output Power	1 Watt or 30dBm

5.2 TEST PROCEDURE

- a. The EUT was directly connected to the power meter and antenna output port as show in the block diagram below.
- b. The maximum peak conducted output power was performed in accordance with method 9.1.2 of FCC KDB 558074 D01 DTS Meas Guidance.

5.3 DEVIATION FROM TEST STANDARD

No deviation.

5.4 TEST SETUP**5.5 EUT OPERATING CONDITIONS**

The EUT was programmed to be in continuously transmitting mode.

5.6 TEST RESULT

Please refer to the APPENDIX D.

6 POWER SPECTRAL DENSITY

6.1 LIMIT

FCC Part15, Subpart C (15.247)		
Section	Test Item	Limit
15.247(e)	Power Spectral Density	8 dBm (in any 3 kHz)

6.2 TEST PROCEDURE

- a. The EUT was directly connected to the spectrum analyzer and antenna output port as show in the block diagram below.
- b. Spectrum Setting: RBW = 3 kHz, VBW = 10 kHz, Sweep time = Auto.

6.3 DEVIATION FROM TEST STANDARD

No deviation.

6.4 TEST SETUP



6.5 EUT OPERATING CONDITIONS

The EUT was programmed to be in continuously transmitting mode.

6.6 TEST RESULT

Please refer to the APPENDIX E.

7 ANTENNA CONDUCTED SPURIOUS EMISSIONS TEST

7.1 LIMIT

In any 100 kHz bandwidth outside the frequency band in which the spread spectrum or digitally modulated device is operating, the RF power that is produced shall be at least 20 dB below that in the 100 kHz bandwidth within the band that contains the highest level of the desired power, based on either an RF conducted or a radiated measurement, provided that the transmitter demonstrates compliance with the peak conducted power limits.

7.2 TEST PROCEDURE

- a. The EUT was directly connected to the spectrum analyzer and antenna output port as show in the block diagram below.
- b. Spectrum Setting: RBW = 100 kHz, VBW=300 kHz, Sweep time = Auto.
- c. Offset = antenna gain + cable loss.

7.3 DEVIATION FROM TEST STANDARD

No deviation.

7.4 TEST SETUP



7.5 EUT OPERATING CONDITIONS

The EUT was programmed to be in continuously transmitting mode.

7.6 TEST RESULT

Please refer to the APPENDIX F.

8 LIST OF MEASURING EQUIPMENTS

Radiated Emissions						
Item	Kind of Equipment	Manufacturer	Type No.	Serial No.	Calibrated Date	Calibrated Until
1	Preamplifier	EMCI	EMC001340	980555	2020/2/28	2021/2/27
2	Preamplifier	EMCI	EMC02325B	980217	2020/4/10	2021/4/9
3	Preamplifier	EMCI	EMC012645B	980267	2020/4/10	2021/4/9
4	Preamplifier	EMCI	EMC2654045	980030	2020/1/31	2021/1/30
5	Test Cable	EMCI	EMC104-SM-SM-800	150207	2020/4/10	2021/4/9
6	Test Cable	EMCI	EMC104-SM-SM-3000	151205	2020/4/10	2021/4/9
7	Test Cable	EMCI	EMC-SM-SM-7000	180408	2020/4/10	2021/4/9
8	MXE EMI Receiver	Agilent	N9038A	MY55420127	2020/3/24	2021/3/24
9	Signal Analyzer	Agilent	N9010A	MY56480554	2019/6/6	2020/6/5
10	Loop Ant	EMCO	EMCI-LPA600	274	2019/5/31	2020/5/30
11	Horn Ant	SCHWARZBECK	BBHA 9120D	9120D-1342	2019/6/10	2020/6/9
12	Horn Ant	Schwarzbeck	BBHA 9170	187	2019/12/21	2020/12/20
13	Trilog-Broadband Antenna	Schwarzbeck	VULB 9168	000992	2019/5/29	2020/5/28
14	5dB Attenuator	EMCI	EMCI-N-6-05	AT-N0508	2019/5/29	2020/5/28

Bandwidth						
Item	Kind of Equipment	Manufacturer	Type No.	Serial No.	Calibrated Date	Calibrated Until
1	Spectrum Analyzer	R&S	FSP40	100129	2019/5/23	2020/5/22

Output Power						
Item	Kind of Equipment	Manufacturer	Type No.	Serial No.	Calibrated Date	Calibrated Until
1	Power Meter	Anritsu	ML2487A	6K00004714	2019/6/20	2020/6/19
2	Power Sensor	Anritsu	MA2491A	1725282	2019/6/20	2020/6/19

Power Spectral Density						
Item	Kind of Equipment	Manufacturer	Type No.	Serial No.	Calibrated Date	Calibrated Until
1	Spectrum Analyzer	R&S	FSP40	100129	2019/5/23	2020/5/22

Antenna conducted Spurious Emission						
Item	Kind of Equipment	Manufacturer	Type No.	Serial No.	Calibrated Date	Calibrated Until
1	Spectrum Analyzer	R&S	FSP40	100129	2019/5/23	2020/5/22

Remark: "N/A" denotes no model name, no serial no. or no calibration specified.
All calibration period of equipment list is one year.

9 EUT TEST PHOTO

Please refer to document Appendix No.: TP-2004T143-FCCP-1 (APPENDIX-TEST PHOTOS).

10 EUT PHOTOS

Please refer to document Appendix No.: EP-2004T143-1 (APPENDIX-EUT PHOTOS).

APPENDIX A RADIATED EMISSIONS - 30 MHZ TO 1 GHZ

Test Mode	IEEE 802.11n (HT40)	Test Date	2020/5/5
Test Frequency	CH09: 2452 MHz	Polarization	Vertical

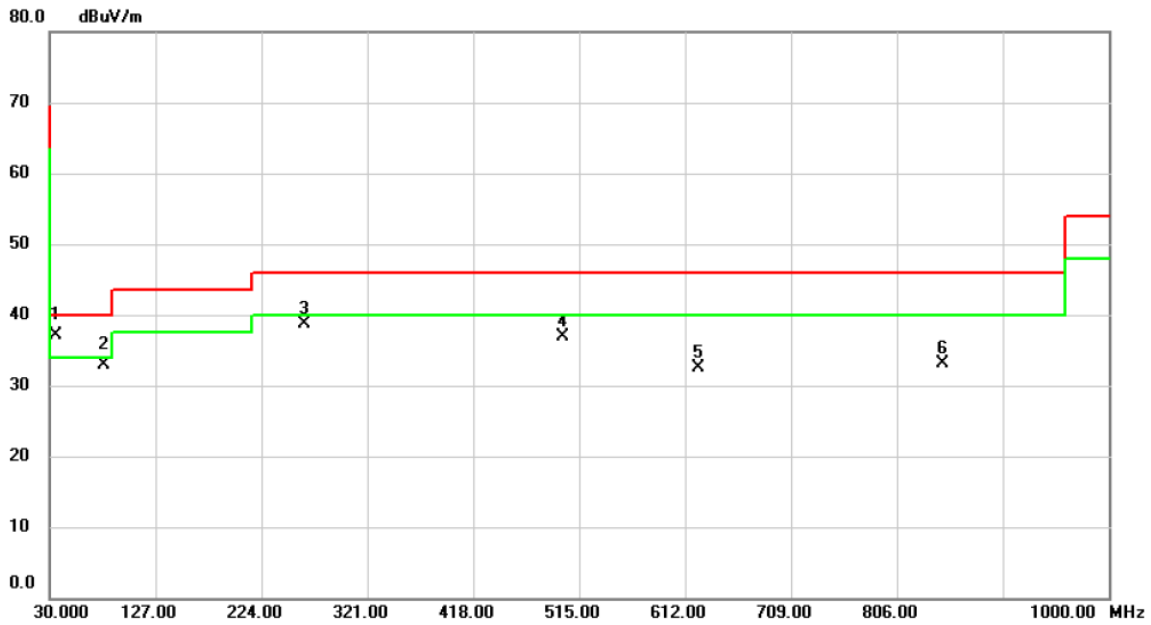

No.	Mk.	Freq.	Reading Level	Correct Factor	Measurement	Limit	Over		
		MHz	dBuV	dB	dBuV/m	dBuV/m	dB	Detector	Comment
1	*	35.8200	46.06	-8.94	37.12	40.00	-2.88	QP	
2		79.4700	45.23	-12.42	32.81	40.00	-7.19	QP	
3		262.8000	47.29	-8.51	38.78	46.00	-7.22	peak	
4		500.4500	39.82	-2.91	36.91	46.00	-9.09	peak	
5		624.6100	32.58	-0.11	32.47	46.00	-13.53	peak	
6		847.7100	29.09	3.93	33.02	46.00	-12.98	peak	

REMARKS:

- (1) Measurement Value = Reading Level + Correct Factor.
- (2) Margin Level = Measurement Value - Limit Value.

Test Mode	IEEE 802.11n (HT40)	Test Date	2020/5/5
Test Frequency	CH09: 2452 MHz	Polarization	Horizontal

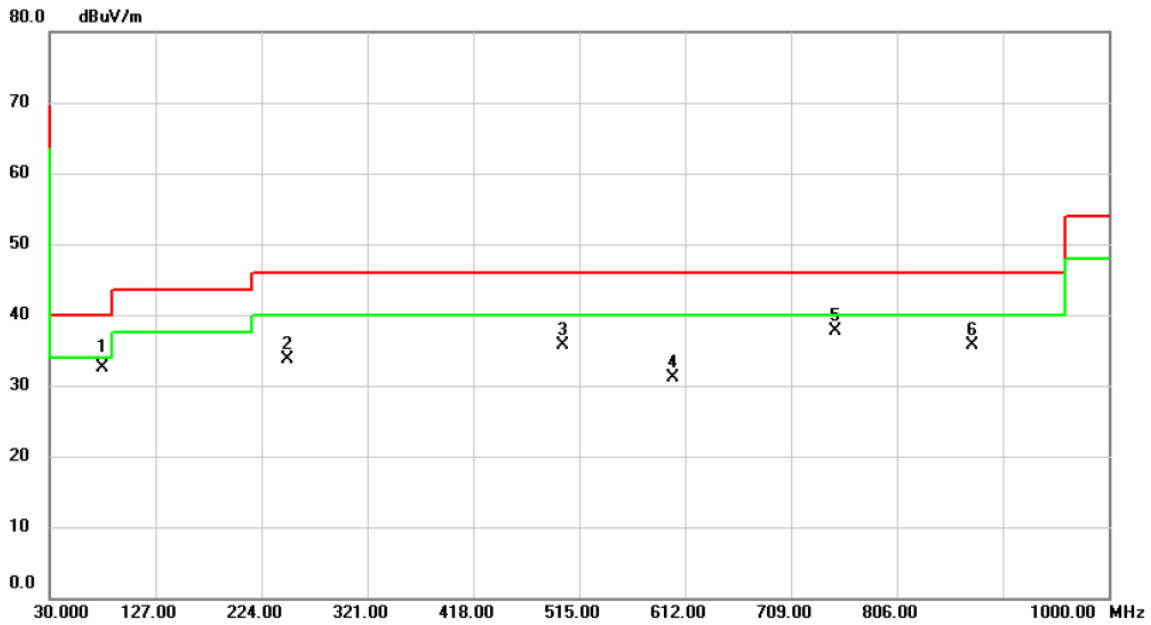

No.	Mk.	Freq.	Reading Level	Correct Factor	Measurement	Limit	Over		
		MHz	dBuV	dB	dBuV/m	dBuV/m	dB	Detector	Comment
1	*	78.5000	44.67	-12.25	32.42	40.00	-7.58	QP	
2		248.2500	42.77	-9.12	33.65	46.00	-12.35	peak	
3		500.4500	38.64	-2.91	35.73	46.00	-10.27	peak	
4		600.3600	31.60	-0.41	31.19	46.00	-14.81	peak	
5		749.7400	35.32	2.31	37.63	46.00	-8.37	peak	
6		874.8700	31.30	4.47	35.77	46.00	-10.23	peak	

REMARKS:

- (1) Measurement Value = Reading Level + Correct Factor.
- (2) Margin Level = Measurement Value - Limit Value.

APPENDIX B RADIATED EMISSIONS - ABOVE 1 GHZ

Test Mode	IEEE 802.11b	Test Date	2020/4/29
Test Frequency	CH01: 2412 MHz	Polarization	Vertical

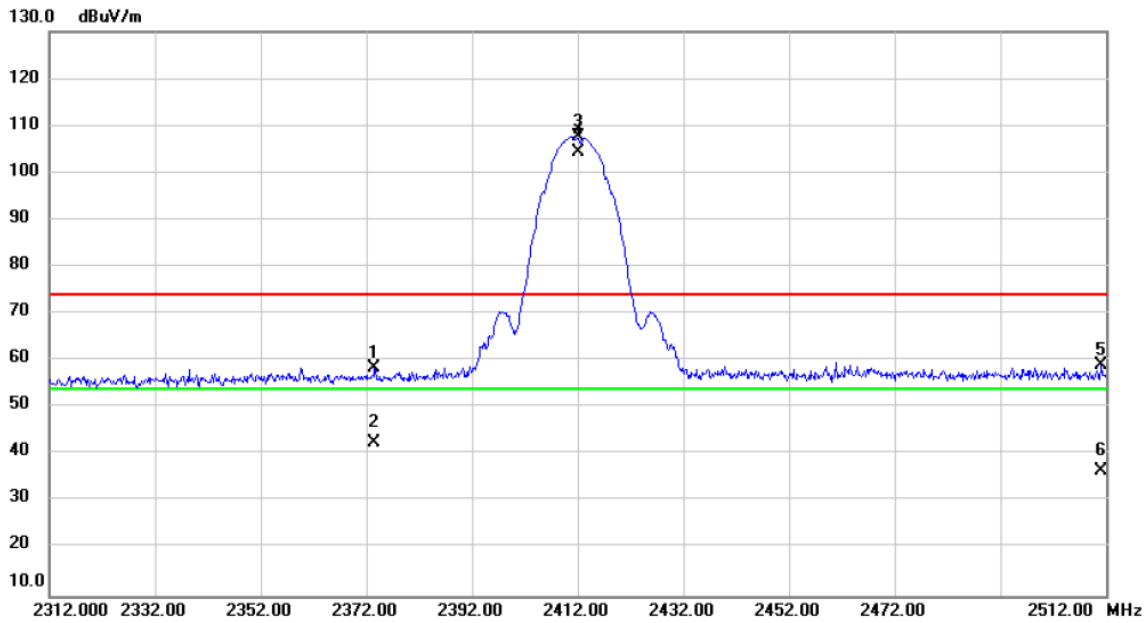

No.	Mk.	Freq.	Reading Level	Correct Factor	Measurement	Limit	Over	Detector	Comment
		MHz	dBuV	dB	dBuV/m	dBuV/m	dB		
1		2373.600	27.24	31.32	58.56	74.00	-15.44	peak	
2		2373.600	11.16	31.32	42.48	54.00	-11.52	AVG	
3	X	2412.000	76.19	31.47	107.66	74.00	33.66	peak	No Limit
4	*	2412.000	72.88	31.47	104.35	54.00	50.35	AVG	No Limit
5		2511.200	27.25	31.85	59.10	74.00	-14.90	peak	
6		2511.200	4.65	31.85	36.50	54.00	-17.50	AVG	

REMARKS:

- (1) Measurement Value = Reading Level + Correct Factor.
- (2) Margin Level = Measurement Value - Limit Value.

Test Mode	IEEE 802.11b	Test Date	2020/4/29
Test Frequency	CH11: 2462 MHz	Polarization	Vertical

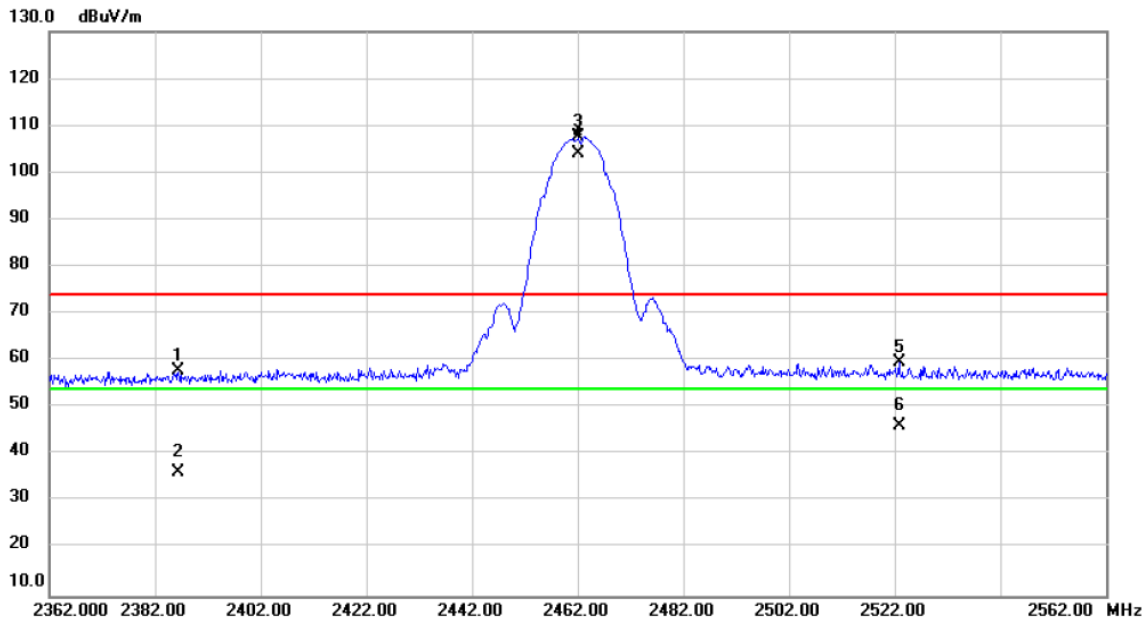

No.	Mk.	Freq.	Reading Level	Correct Factor	Measurement	Limit	Over	Detector	Comment
		MHz	dBuV	dB	dBuV/m	dBuV/m	dB		
1		2386.400	26.33	31.37	57.70	74.00	-16.30	peak	
2		2386.400	4.99	31.37	36.36	54.00	-17.64	AVG	
3	X	2462.000	75.88	31.67	107.55	74.00	33.55	peak	No Limit
4	*	2462.000	72.44	31.67	104.11	54.00	50.11	AVG	No Limit
5		2522.800	27.91	31.89	59.80	74.00	-14.20	peak	
6		2522.800	14.13	31.89	46.02	54.00	-7.98	AVG	

REMARKS:

- (1) Measurement Value = Reading Level + Correct Factor.
- (2) Margin Level = Measurement Value - Limit Value.

Test Mode	IEEE 802.11g	Test Date	2020/4/29
Test Frequency	CH01: 2412 MHz	Polarization	Vertical

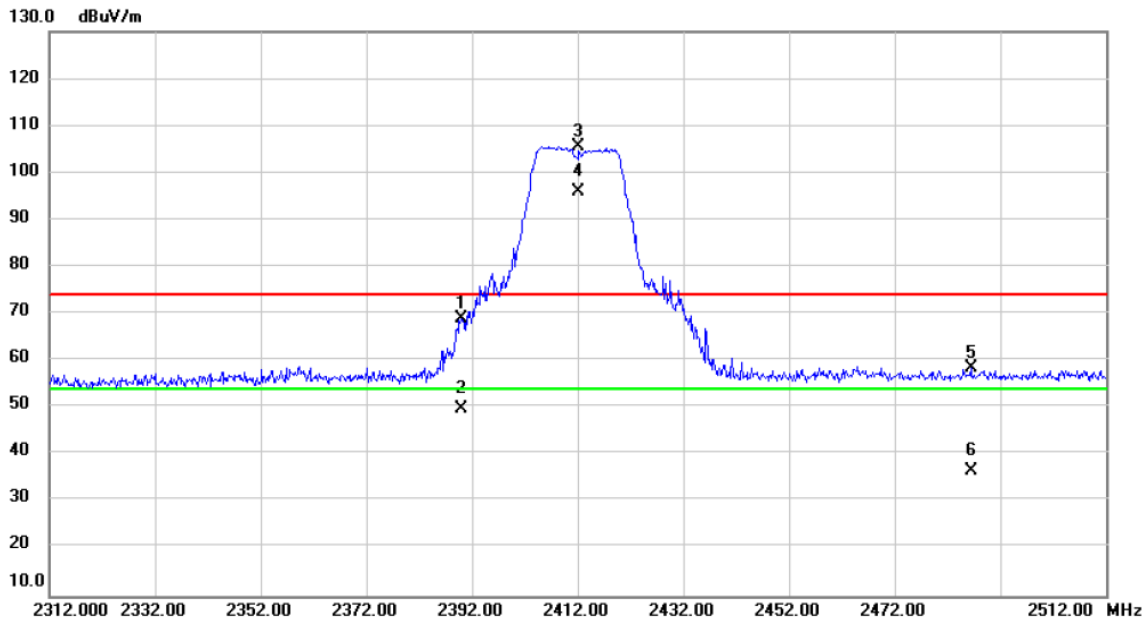

No.	Mk.	Freq. MHz	Reading Level dBuV	Correct Factor dB	Measure- ment dBuV/m	Limit dBuV/m	Over dB	Detector	Comment
1		2390.000	37.61	31.38	68.99	74.00	-5.01	peak	
2		2390.000	18.23	31.38	49.61	54.00	-4.39	AVG	
3	X	2412.000	74.12	31.47	105.59	74.00	31.59	peak	No Limit
4	*	2412.000	64.58	31.47	96.05	54.00	42.05	AVG	No Limit
5		2486.400	26.70	31.77	58.47	74.00	-15.53	peak	
6		2486.400	4.79	31.77	36.56	54.00	-17.44	AVG	

REMARKS:

- (1) Measurement Value = Reading Level + Correct Factor.
- (2) Margin Level = Measurement Value - Limit Value.

Test Mode	IEEE 802.11g	Test Date	2020/4/29
Test Frequency	CH11: 2462 MHz	Polarization	Vertical

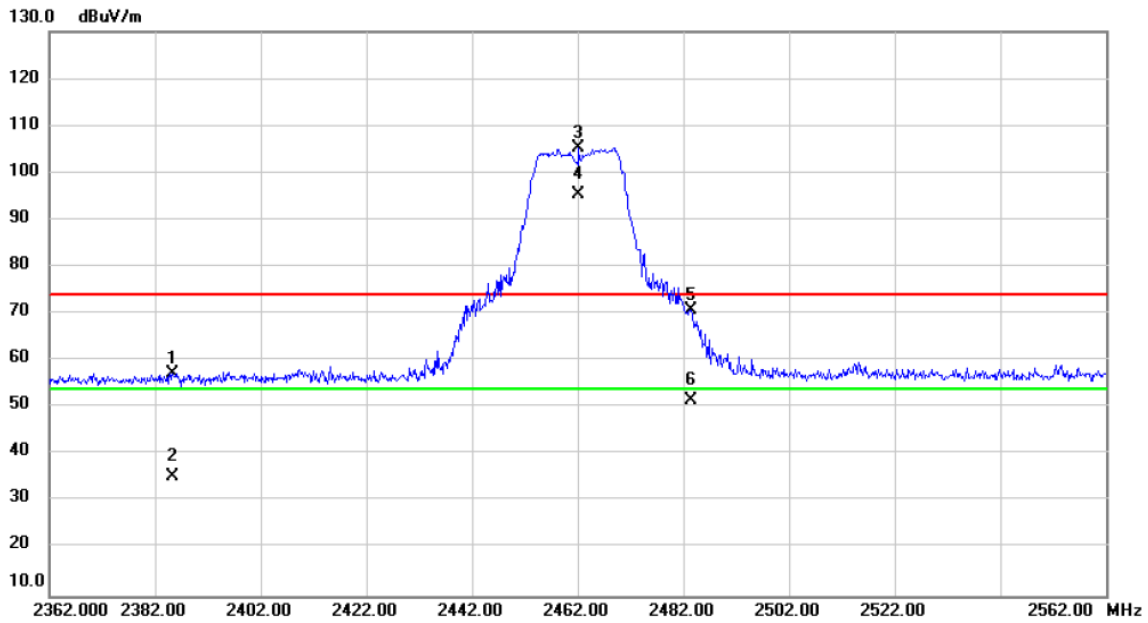

No.	Mk.	Freq.	Reading Level	Correct Factor	Measurement	Limit	Over	Detector	Comment
		MHz	dBuV	dB	dBuV/m	dBuV/m	dB		
1		2385.400	25.99	31.36	57.35	74.00	-16.65	peak	
2		2385.400	4.02	31.36	35.38	54.00	-18.62	AVG	
3	X	2462.000	73.55	31.67	105.22	74.00	31.22	peak	No Limit
4	*	2462.000	63.78	31.67	95.45	54.00	41.45	AVG	No Limit
5		2483.600	38.97	31.76	70.73	74.00	-3.27	peak	
6		2483.600	19.93	31.76	51.69	54.00	-2.31	AVG	

REMARKS:

- (1) Measurement Value = Reading Level + Correct Factor.
- (2) Margin Level = Measurement Value - Limit Value.

Test Mode	IEEE 802.11n (HT20)	Test Date	2020/4/29
Test Frequency	CH01: 2412 MHz	Polarization	Vertical

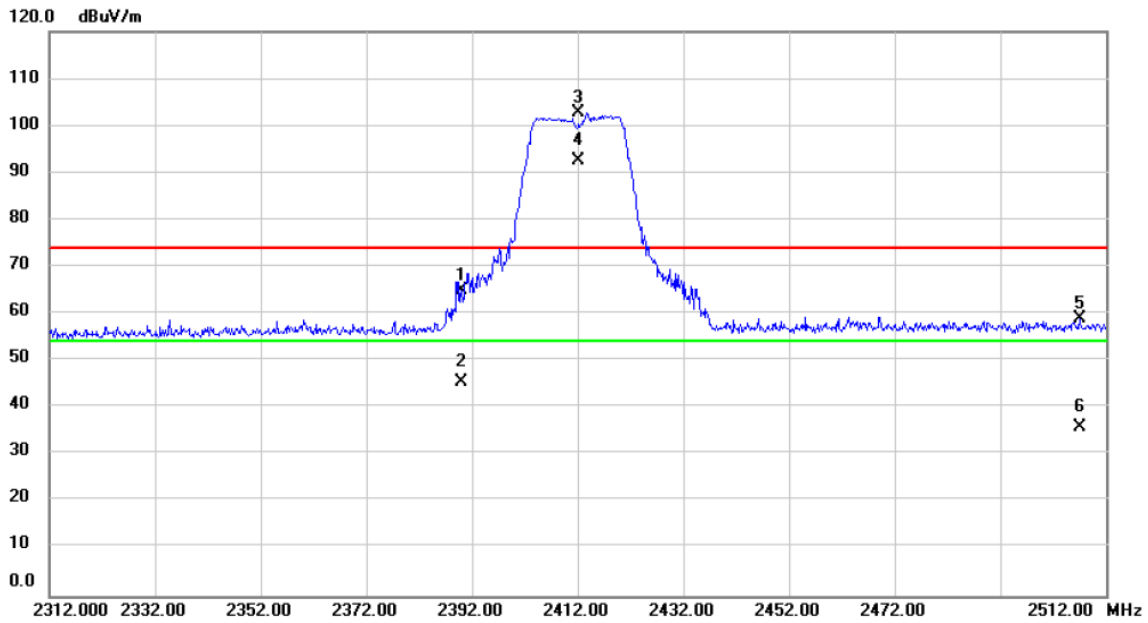

No.	Mk.	Freq.	Reading Level	Correct Factor	Measurement	Limit	Over	Detector	Comment
		MHz	dBuV	dB	dBuV/m	dBuV/m	dB		
1		2390.000	33.46	31.38	64.84	74.00	-9.16	peak	
2		2390.000	14.20	31.38	45.58	54.00	-8.42	AVG	
3	X	2412.000	71.32	31.47	102.79	74.00	28.79	peak	No Limit
4	*	2412.000	61.15	31.47	92.62	54.00	38.62	AVG	No Limit
5		2507.000	27.04	31.84	58.88	74.00	-15.12	peak	
6		2507.000	3.88	31.84	35.72	54.00	-18.28	AVG	

REMARKS:

- (1) Measurement Value = Reading Level + Correct Factor.
- (2) Margin Level = Measurement Value - Limit Value.

Test Mode	IEEE 802.11n (HT20)	Test Date	2020/4/30
Test Frequency	CH11: 2462 MHz	Polarization	Vertical

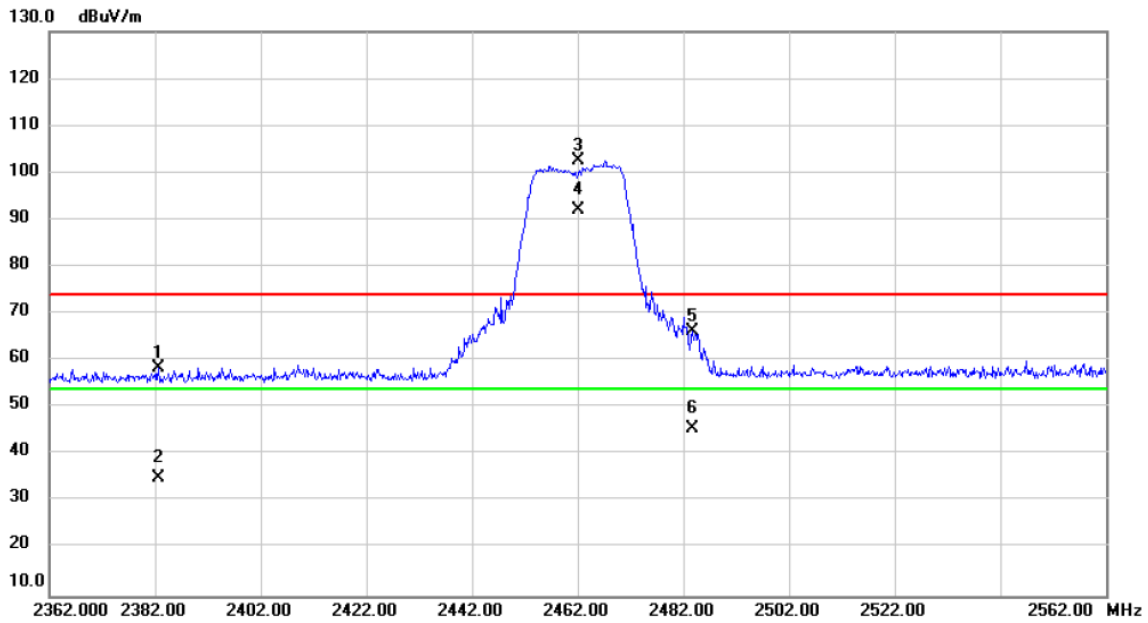

No.	Mk.	Freq.	Reading Level	Correct Factor	Measurement	Limit	Over	Detector	Comment
		MHz	dBuV	dB	dBuV/m	dBuV/m	dB		
1		2382.600	27.08	31.34	58.42	74.00	-15.58	peak	
2		2382.600	3.80	31.34	35.14	54.00	-18.86	AVG	
3	X	2462.000	70.97	31.67	102.64	74.00	28.64	peak	No Limit
4	*	2462.000	60.42	31.67	92.09	54.00	38.09	AVG	No Limit
5		2483.800	34.55	31.76	66.31	74.00	-7.69	peak	
6		2483.800	13.78	31.76	45.54	54.00	-8.46	AVG	

REMARKS:

- (1) Measurement Value = Reading Level + Correct Factor.
- (2) Margin Level = Measurement Value - Limit Value.

Test Mode	IEEE 802.11n (HT40)	Test Date	2020/4/29
Test Frequency	CH03: 2422 MHz	Polarization	Vertical

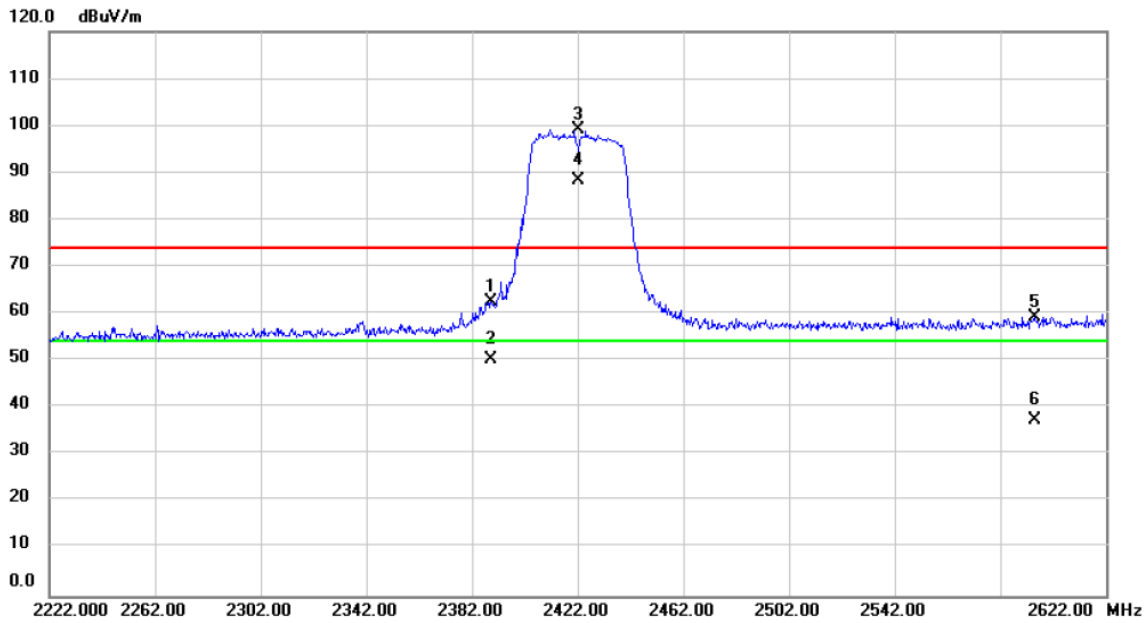

No.	Mk.	Freq. MHz	Reading Level dBuV	Correct Factor dB	Measure- ment dBuV/m	Limit dBuV/m	Over dB	Detector	Comment
1		2389.200	31.05	31.38	62.43	74.00	-11.57	peak	
2		2389.200	18.99	31.38	50.37	54.00	-3.63	AVG	
3	X	2422.000	67.53	31.51	99.04	74.00	25.04	peak	No Limit
4	*	2422.000	56.88	31.51	88.39	54.00	34.39	AVG	No Limit
5		2594.800	27.15	32.10	59.25	74.00	-14.75	peak	
6		2594.800	5.26	32.10	37.36	54.00	-16.64	AVG	

REMARKS:

- (1) Measurement Value = Reading Level + Correct Factor.
- (2) Margin Level = Measurement Value - Limit Value.

Test Mode	IEEE 802.11n (HT40)	Test Date	2020/4/29
Test Frequency	CH09: 2452 MHz	Polarization	Vertical

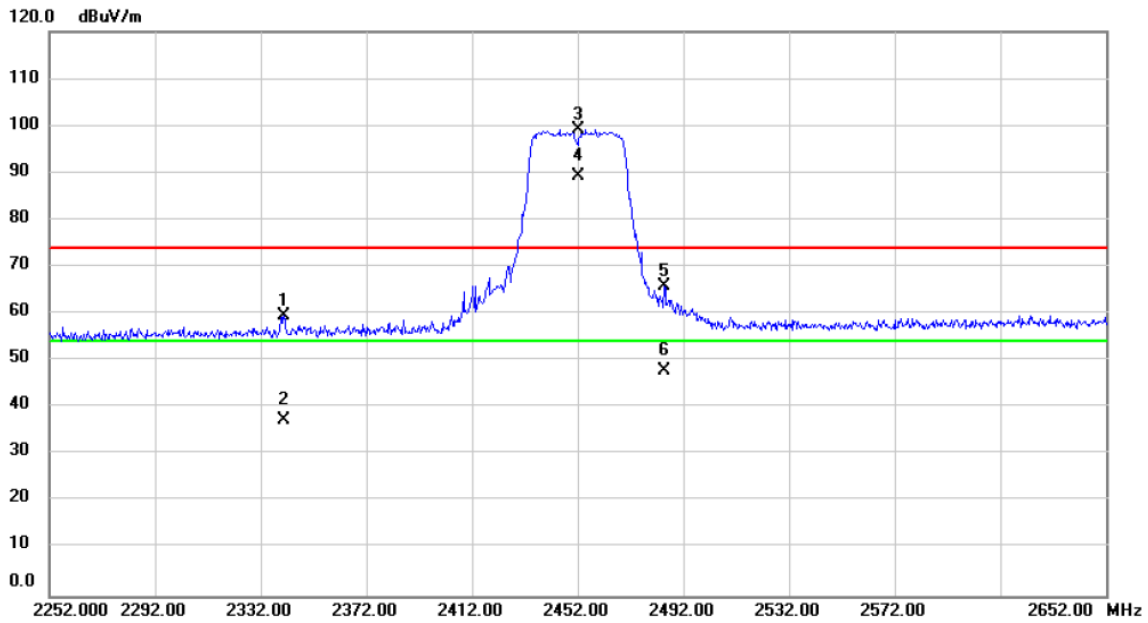

No.	Mk.	Freq.	Reading Level	Correct Factor	Measurement	Limit	Over	Detector	Comment
		MHz	dBuV	dB	dBuV/m	dBuV/m	dB		
1		2340.800	28.40	31.18	59.58	74.00	-14.42	peak	
2		2340.800	6.27	31.18	37.45	54.00	-16.55	AVG	
3	X	2452.000	67.63	31.63	99.26	74.00	25.26	peak	No Limit
4	*	2452.000	57.73	31.63	89.36	54.00	35.36	AVG	No Limit
5		2484.800	34.16	31.76	65.92	74.00	-8.08	peak	
6		2484.800	15.95	31.76	47.71	54.00	-6.29	AVG	

REMARKS:

- (1) Measurement Value = Reading Level + Correct Factor.
- (2) Margin Level = Measurement Value - Limit Value.

Test Mode	IEEE 802.11b	Test Date	2020/4/30
Test Frequency	CH01: 2412 MHz	Polarization	Vertical

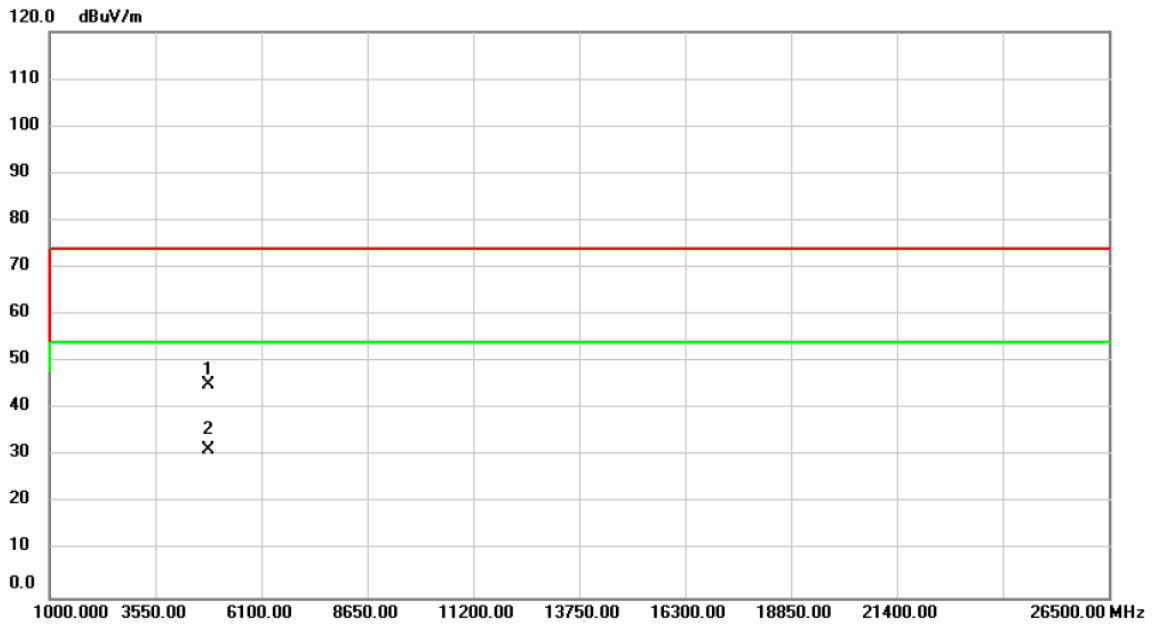

No.	Mk.	Freq.	Reading Level	Correct Factor	Measurement	Limit	Over	Detector	Comment
		MHz	dBuV	dB	dBuV/m	dBuV/m	dB		
1		4824.000	55.94	-10.65	45.29	74.00	-28.71	peak	
2	*	4824.000	41.92	-10.65	31.27	54.00	-22.73	AVG	

REMARKS:

- (1) Measurement Value = Reading Level + Correct Factor.
- (2) Margin Level = Measurement Value - Limit Value.

Test Mode	IEEE 802.11b	Test Date	2020/4/30
Test Frequency	CH01: 2412 MHz	Polarization	Horizontal

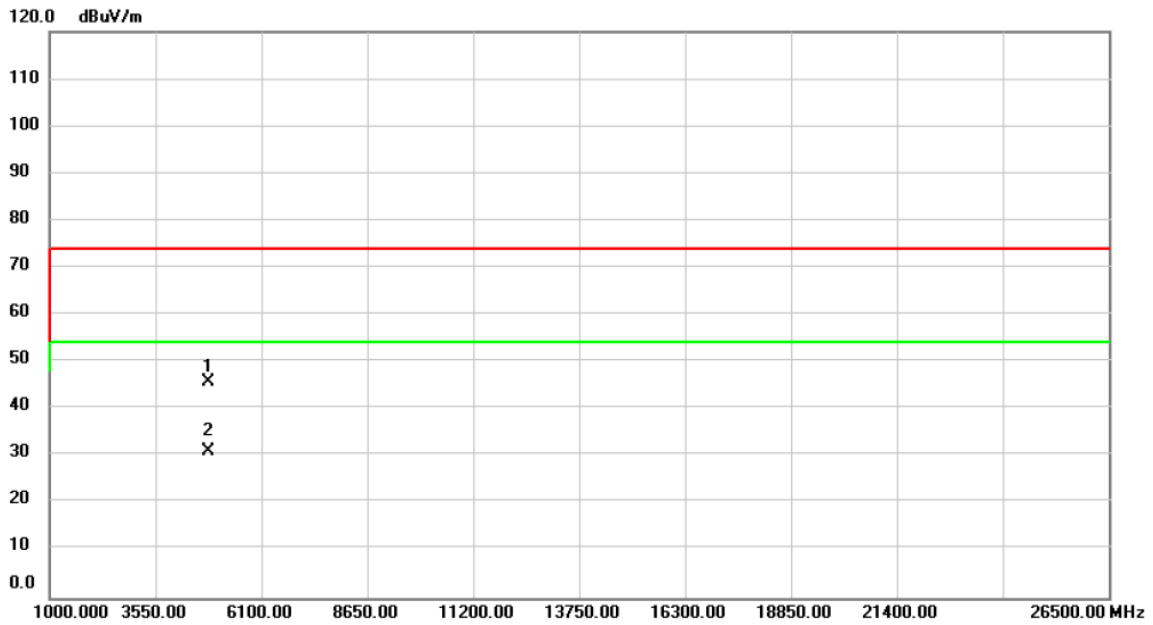

No.	Mk.	Freq.	Reading Level	Correct Factor	Measurement	Limit	Over	Detector	Comment
		MHz	dBuV	dB	dBuV/m	dBuV/m	dB		
1		4824.000	56.41	-10.65	45.76	74.00	-28.24	peak	
2	*	4824.000	41.71	-10.65	31.06	54.00	-22.94	AVG	

REMARKS:

- (1) Measurement Value = Reading Level + Correct Factor.
- (2) Margin Level = Measurement Value - Limit Value.

Test Mode	IEEE 802.11b	Test Date	2020/4/30
Test Frequency	CH06: 2437 MHz	Polarization	Vertical

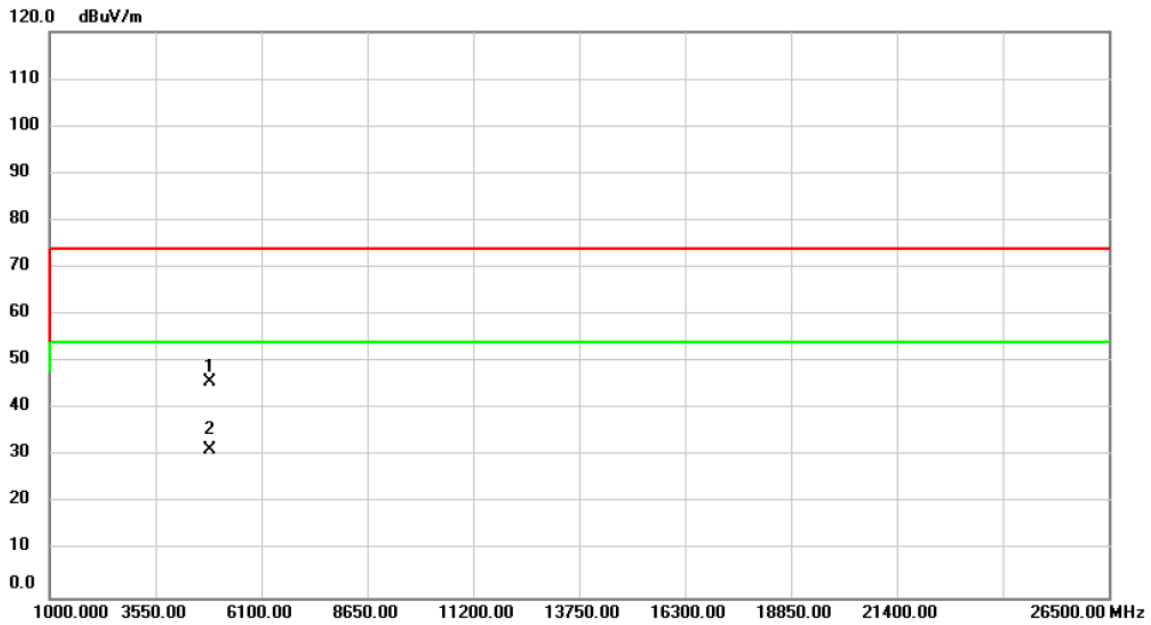

No.	Mk.	Freq.	Reading Level	Correct Factor	Measurement	Limit	Over	Detector	Comment
		MHz	dBuV	dB	dBuV/m	dBuV/m	dB		
1		4874.000	56.38	-10.54	45.84	74.00	-28.16	peak	
2	*	4874.000	41.99	-10.54	31.45	54.00	-22.55	AVG	

REMARKS:

- (1) Measurement Value = Reading Level + Correct Factor.
- (2) Margin Level = Measurement Value - Limit Value.

Test Mode	IEEE 802.11b	Test Date	2020/4/30
Test Frequency	CH06: 2437 MHz	Polarization	Horizontal

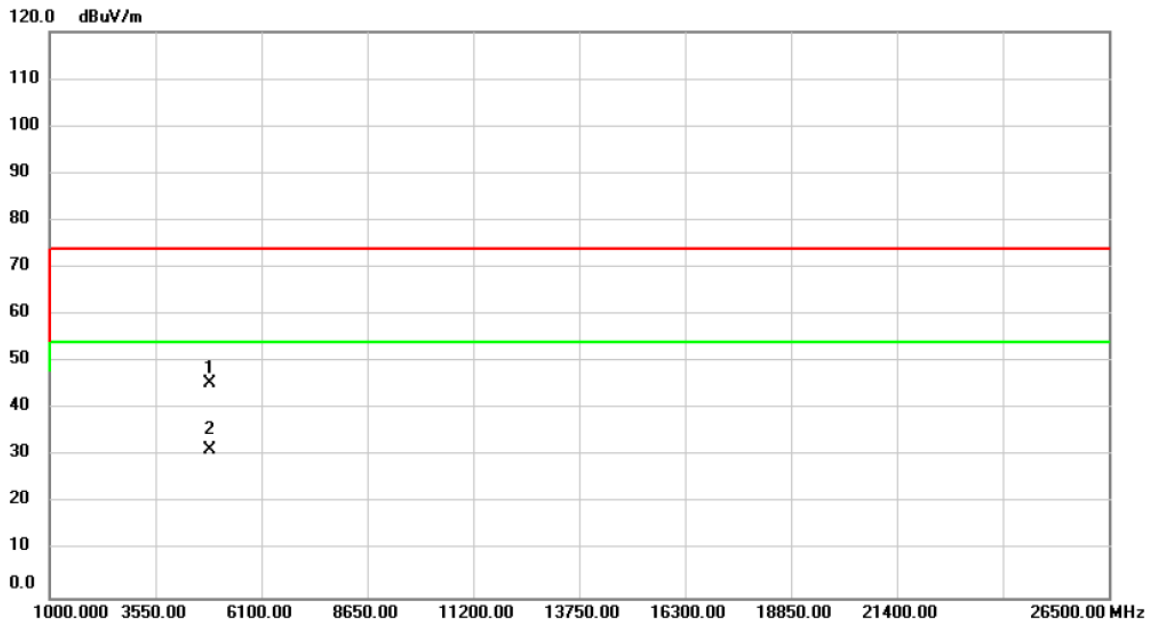

No.	Mk.	Freq.	Reading Level	Correct Factor	Measurement	Limit	Over	Detector	Comment
		MHz	dBuV	dB	dBuV/m	dBuV/m	dB		
1		4874.000	56.09	-10.54	45.55	74.00	-28.45	peak	
2	*	4874.000	42.02	-10.54	31.48	54.00	-22.52	AVG	

REMARKS:

- (1) Measurement Value = Reading Level + Correct Factor.
- (2) Margin Level = Measurement Value - Limit Value.

Test Mode	IEEE 802.11b	Test Date	2020/4/30
Test Frequency	CH11: 2462 MHz	Polarization	Vertical

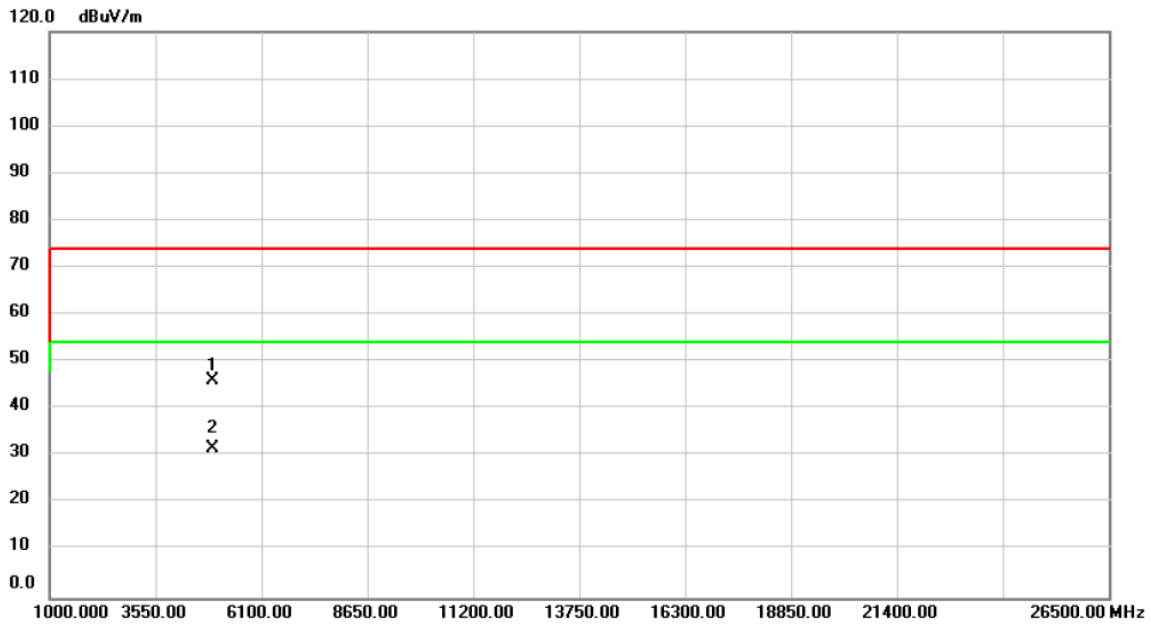

No.	Mk.	Freq.	Reading Level	Correct Factor	Measurement	Limit	Over	Detector	Comment
		MHz	dBuV	dB	dBuV/m	dBuV/m	dB		
1		4924.000	56.36	-10.43	45.93	74.00	-28.07	peak	
2	*	4924.000	42.18	-10.43	31.75	54.00	-22.25	AVG	

REMARKS:

- (1) Measurement Value = Reading Level + Correct Factor.
- (2) Margin Level = Measurement Value - Limit Value.

Test Mode	IEEE 802.11b	Test Date	2020/4/30
Test Frequency	CH11: 2462 MHz	Polarization	Horizontal

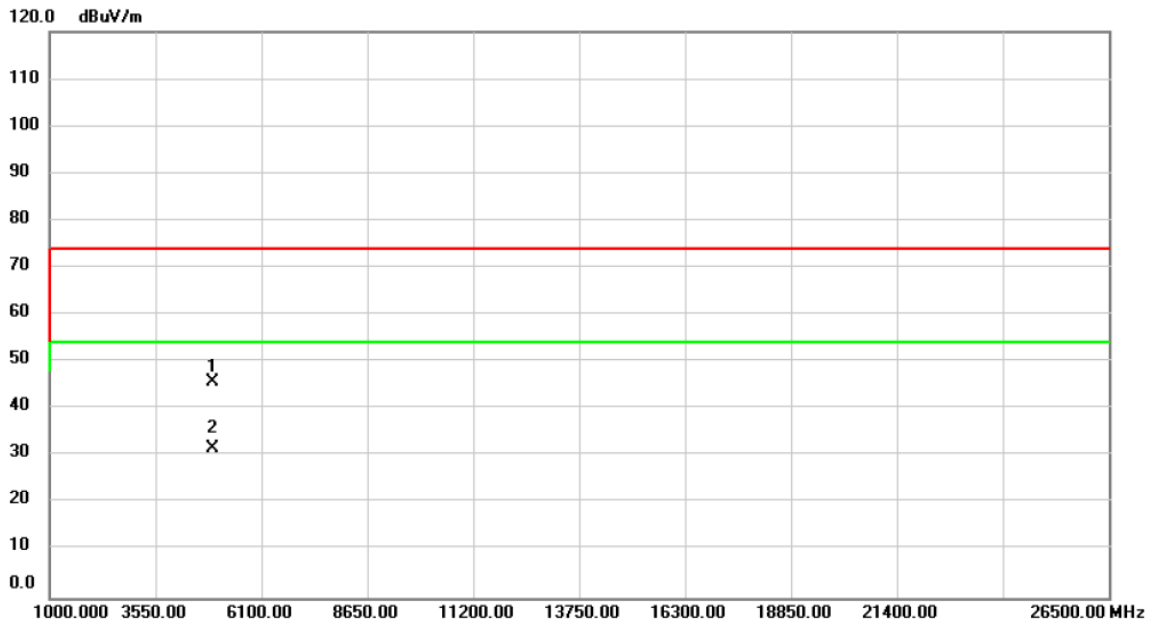

No.	Mk.	Freq.	Reading Level	Correct Factor	Measurement	Limit	Over	Detector	Comment
		MHz	dBuV	dB	dBuV/m	dBuV/m	dB		
1		4924.000	56.16	-10.43	45.73	74.00	-28.27	peak	
2	*	4924.000	42.07	-10.43	31.64	54.00	-22.36	AVG	

REMARKS:

- (1) Measurement Value = Reading Level + Correct Factor.
- (2) Margin Level = Measurement Value - Limit Value.

Test Mode	IEEE 802.11g	Test Date	2020/4/30
Test Frequency	CH01: 2412 MHz	Polarization	Vertical

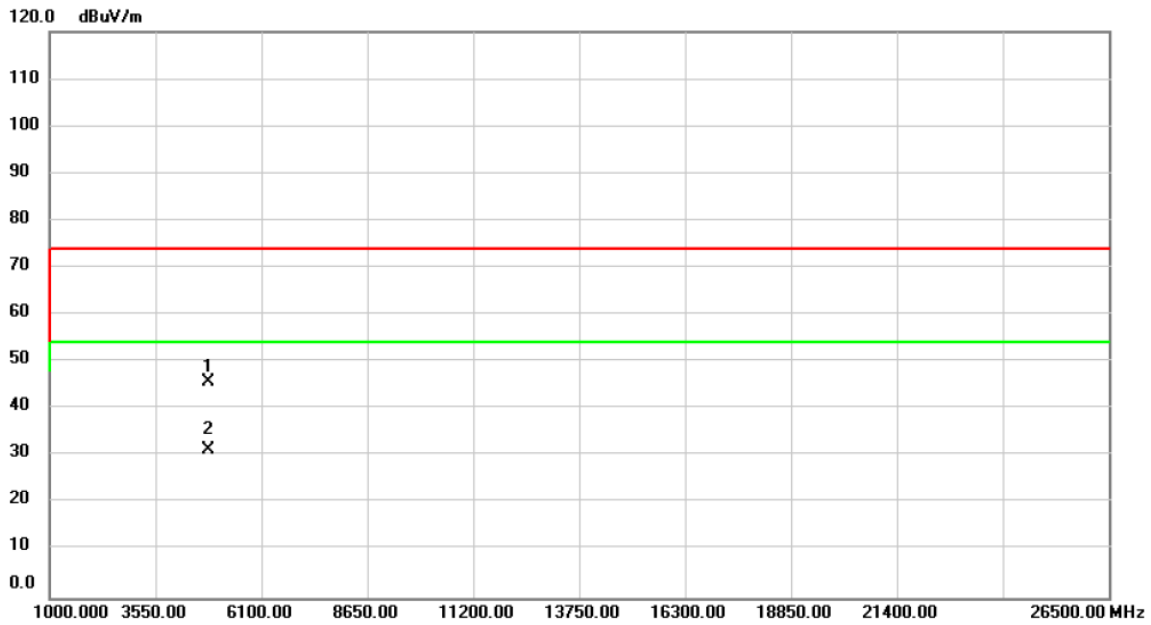

No.	Mk.	Freq.	Reading Level	Correct Factor	Measurement	Limit	Over	Detector	Comment
		MHz	dBuV	dB	dBuV/m	dBuV/m	dB		
1		4824.000	56.28	-10.65	45.63	74.00	-28.37	peak	
2	*	4824.000	42.14	-10.65	31.49	54.00	-22.51	AVG	

REMARKS:

- (1) Measurement Value = Reading Level + Correct Factor.
- (2) Margin Level = Measurement Value - Limit Value.

Test Mode	IEEE 802.11g	Test Date	2020/4/30
Test Frequency	CH01: 2412 MHz	Polarization	Horizontal

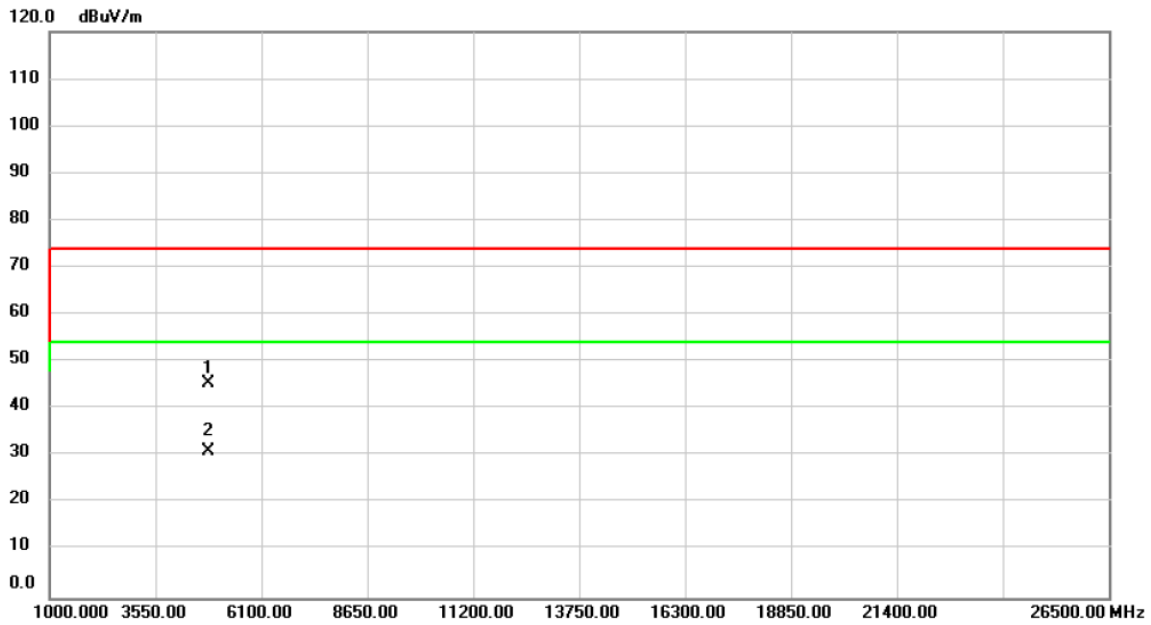

No.	Mk.	Freq.	Reading Level	Correct Factor	Measurement	Limit	Over	Detector	Comment
		MHz	dBuV	dB	dBuV/m	dBuV/m	dB		
1		4824.000	56.07	-10.65	45.42	74.00	-28.58	peak	
2	*	4824.000	41.73	-10.65	31.08	54.00	-22.92	AVG	

REMARKS:

- (1) Measurement Value = Reading Level + Correct Factor.
- (2) Margin Level = Measurement Value - Limit Value.

Test Mode	IEEE 802.11g	Test Date	2020/4/30
Test Frequency	CH06: 2437 MHz	Polarization	Vertical

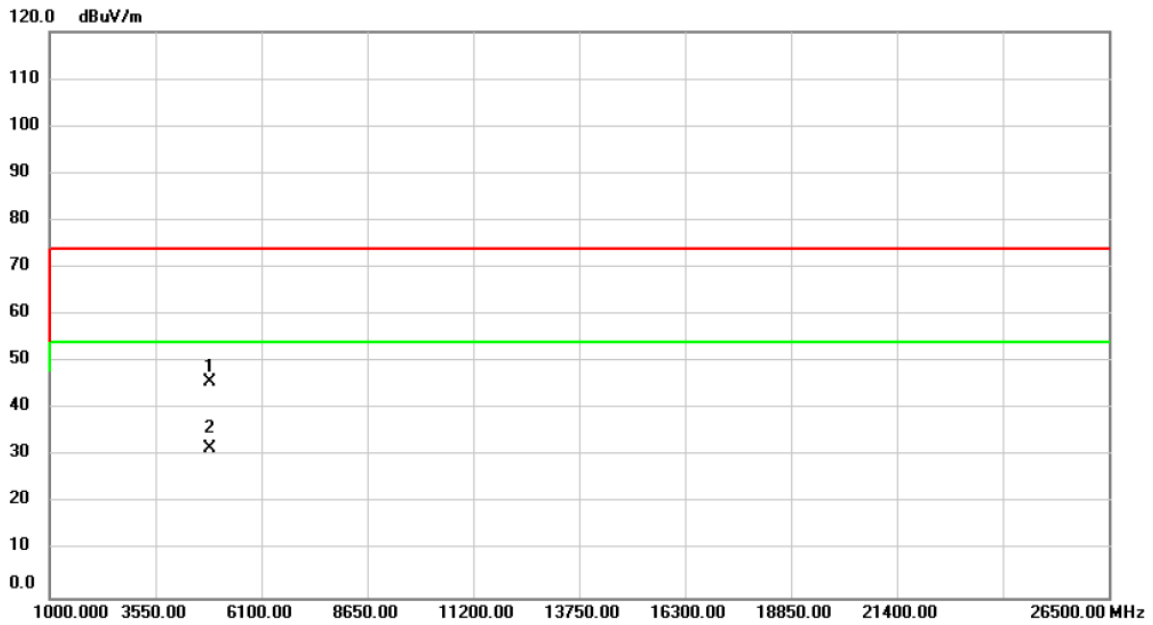

No.	Mk.	Freq.	Reading Level	Correct Factor	Measurement	Limit	Over	Detector	Comment
		MHz	dBuV	dB	dBuV/m	dBuV/m	dB		
1		4874.000	56.16	-10.54	45.62	74.00	-28.38	peak	
2	*	4874.000	42.19	-10.54	31.65	54.00	-22.35	AVG	

REMARKS:

- (1) Measurement Value = Reading Level + Correct Factor.
- (2) Margin Level = Measurement Value - Limit Value.

Test Mode	IEEE 802.11g	Test Date	2020/4/30
Test Frequency	CH06: 2437 MHz	Polarization	Horizontal

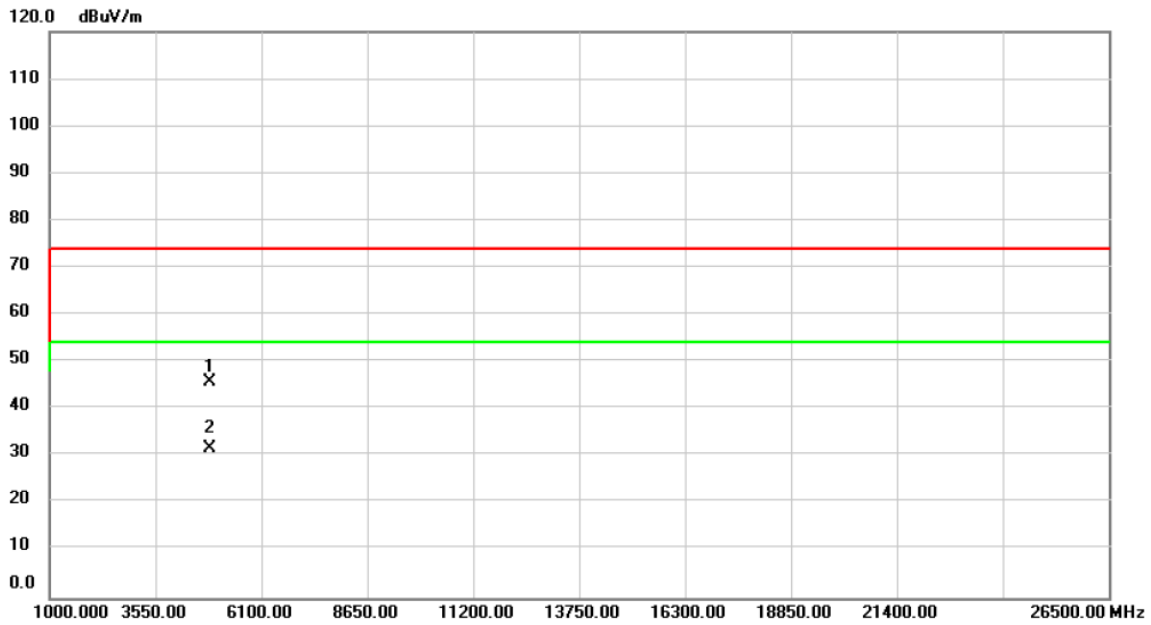

No.	Mk.	Freq.	Reading Level	Correct Factor	Measurement	Limit	Over	Detector	Comment
		MHz	dBuV	dB	dBuV/m	dBuV/m	dB		
1		4874.000	56.30	-10.54	45.76	74.00	-28.24	peak	
2	*	4874.000	42.11	-10.54	31.57	54.00	-22.43	AVG	

REMARKS:

- (1) Measurement Value = Reading Level + Correct Factor.
- (2) Margin Level = Measurement Value - Limit Value.

Test Mode	IEEE 802.11g	Test Date	2020/4/30
Test Frequency	CH11: 2462 MHz	Polarization	Vertical

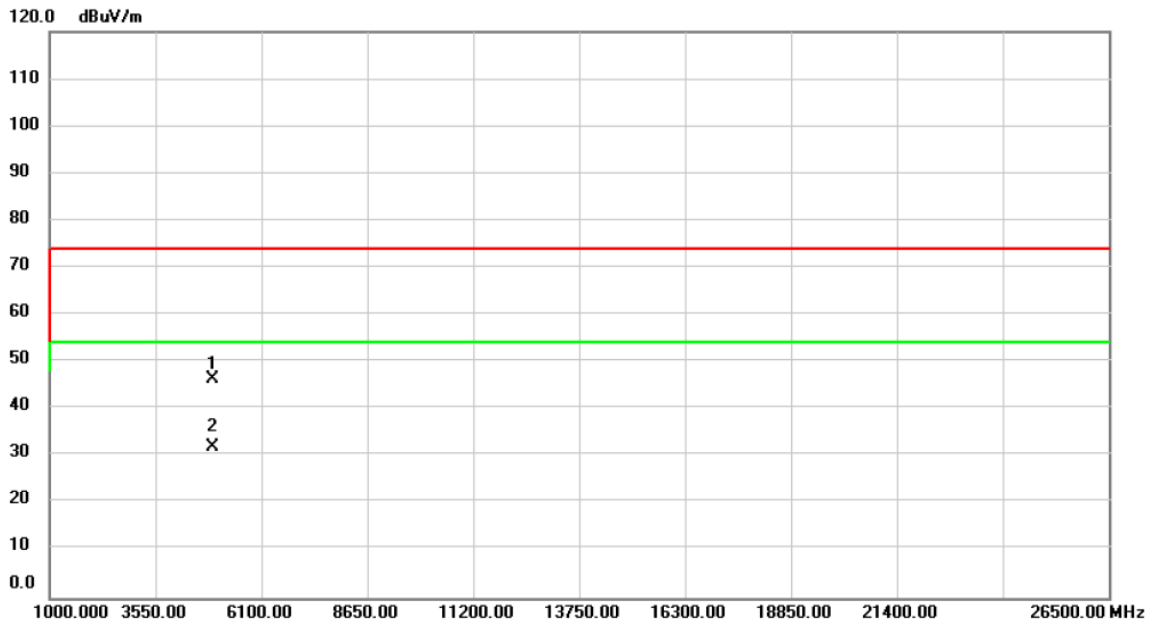

No.	Mk.	Freq.	Reading Level	Correct Factor	Measurement	Limit	Over	Detector	Comment
		MHz	dBuV	dB	dBuV/m	dBuV/m	dB		
1		4924.000	56.93	-10.43	46.50	74.00	-27.50	peak	
2	*	4924.000	42.34	-10.43	31.91	54.00	-22.09	AVG	

REMARKS:

- (1) Measurement Value = Reading Level + Correct Factor.
- (2) Margin Level = Measurement Value - Limit Value.

Test Mode	IEEE 802.11g	Test Date	2020/4/30
Test Frequency	CH11: 2462 MHz	Polarization	Horizontal

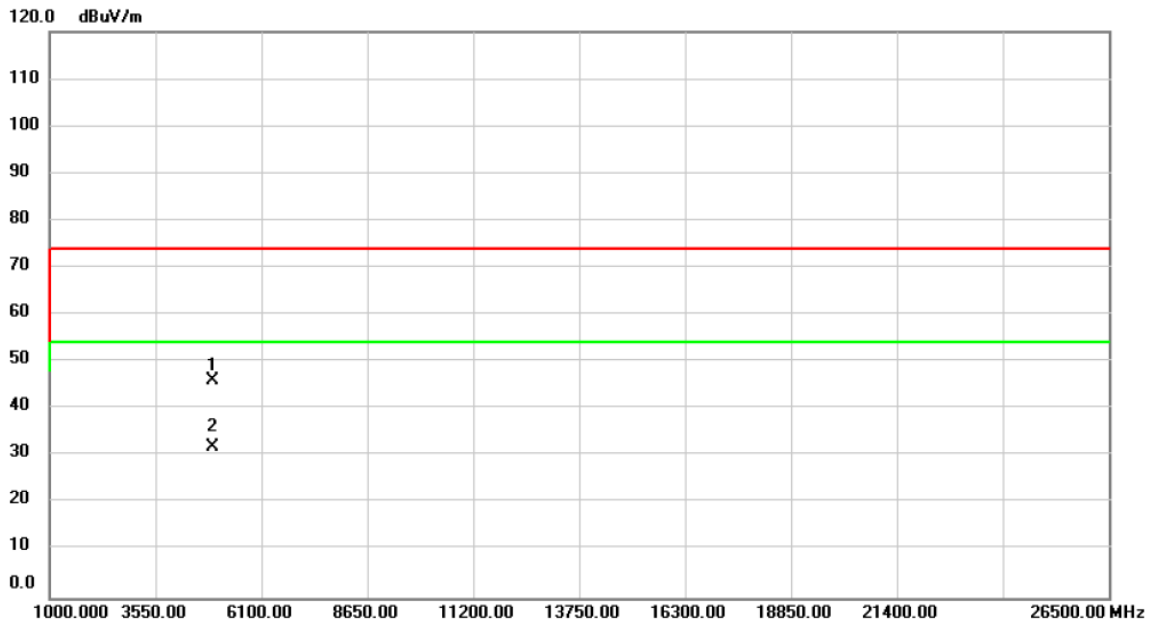

No.	Mk.	Freq.	Reading Level	Correct Factor	Measurement	Limit	Over	Detector	Comment
		MHz	dBuV	dB	dBuV/m	dBuV/m	dB		
1		4924.000	56.54	-10.43	46.11	74.00	-27.89	peak	
2	*	4924.000	42.50	-10.43	32.07	54.00	-21.93	AVG	

REMARKS:

- (1) Measurement Value = Reading Level + Correct Factor.
- (2) Margin Level = Measurement Value - Limit Value.

Test Mode	IEEE 802.11n (HT20)	Test Date	2020/4/30
Test Frequency	CH01: 2412 MHz	Polarization	Vertical

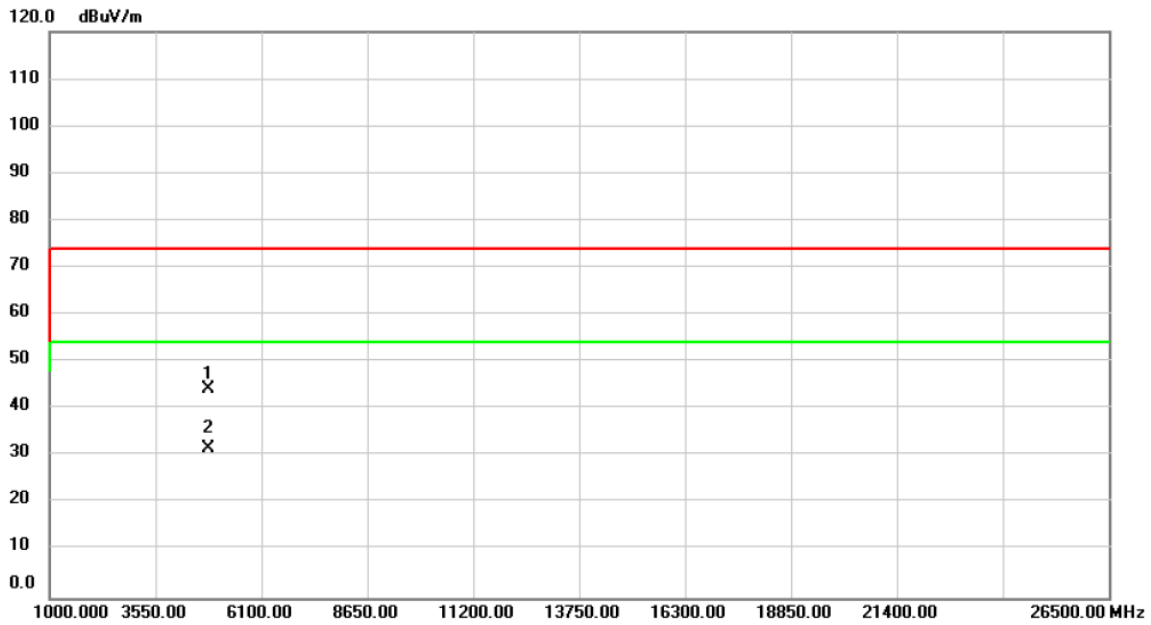

No.	Mk.	Freq.	Reading Level	Correct Factor	Measurement	Limit	Over	Detector	Comment
		MHz	dBuV	dB	dBuV/m	dBuV/m	dB		
1		4824.000	55.01	-10.65	44.36	74.00	-29.64	peak	
2	*	4824.000	42.37	-10.65	31.72	54.00	-22.28	AVG	

REMARKS:

- (1) Measurement Value = Reading Level + Correct Factor.
- (2) Margin Level = Measurement Value - Limit Value.

Test Mode	IEEE 802.11n (HT20)	Test Date	2020/4/30
Test Frequency	CH01: 2412 MHz	Polarization	Horizontal

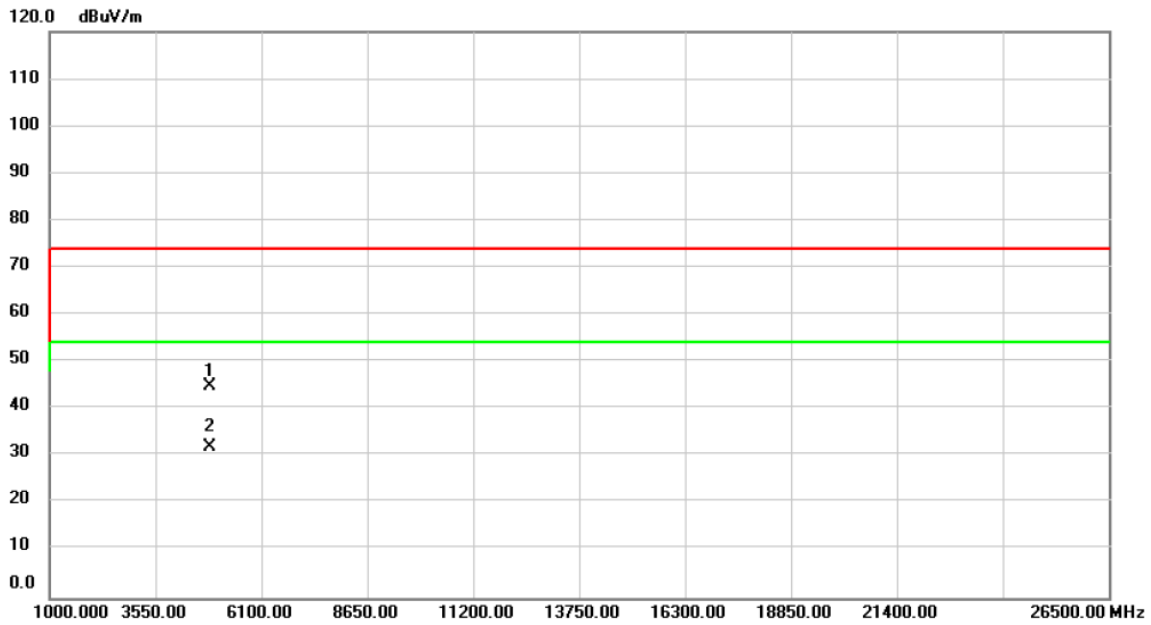

No.	Mk.	Freq.	Reading Level	Correct Factor	Measurement	Limit	Over	Detector	Comment
		MHz	dBuV	dB	dBuV/m	dBuV/m	dB		
1		4874.000	55.34	-10.54	44.80	74.00	-29.20	peak	
2	*	4874.000	42.44	-10.54	31.90	54.00	-22.10	AVG	

REMARKS:

- (1) Measurement Value = Reading Level + Correct Factor.
- (2) Margin Level = Measurement Value - Limit Value.

Test Mode	IEEE 802.11n (HT20)	Test Date	2020/4/30
Test Frequency	CH06: 2437 MHz	Polarization	Vertical

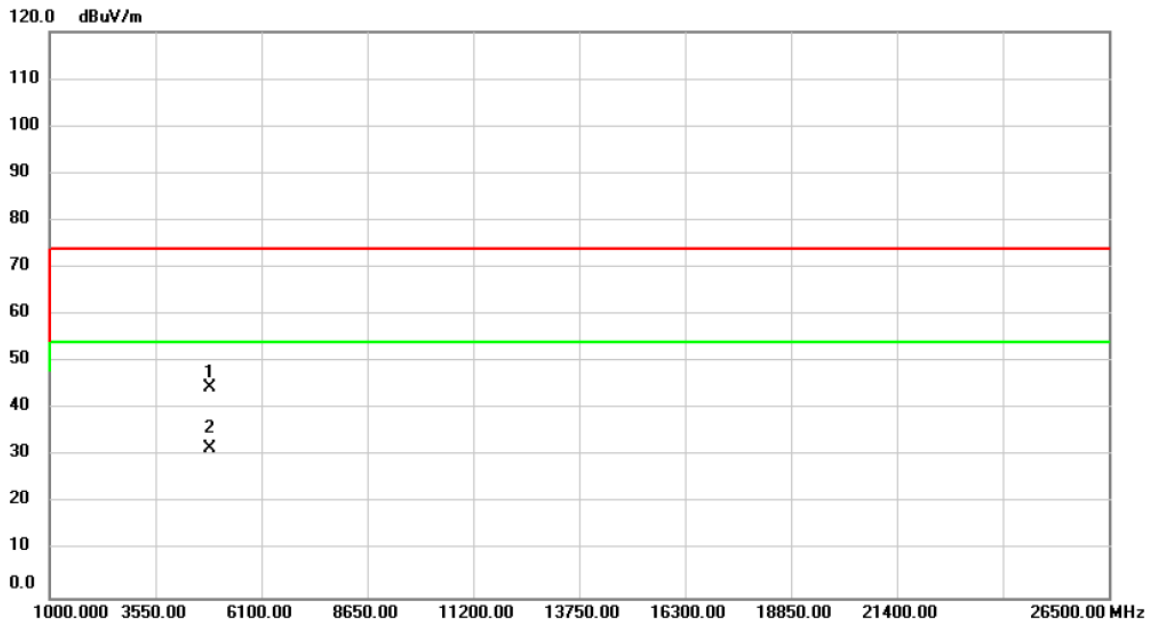

No.	Mk.	Freq.	Reading Level	Correct Factor	Measurement	Limit	Over	Detector	Comment
		MHz	dBuV	dB	dBuV/m	dBuV/m	dB		
1		4874.000	55.13	-10.54	44.59	74.00	-29.41	peak	
2	*	4874.000	42.32	-10.54	31.78	54.00	-22.22	AVG	

REMARKS:

- (1) Measurement Value = Reading Level + Correct Factor.
- (2) Margin Level = Measurement Value - Limit Value.

Test Mode	IEEE 802.11n (HT20)	Test Date	2020/4/30
Test Frequency	CH06: 2437 MHz	Polarization	Horizontal

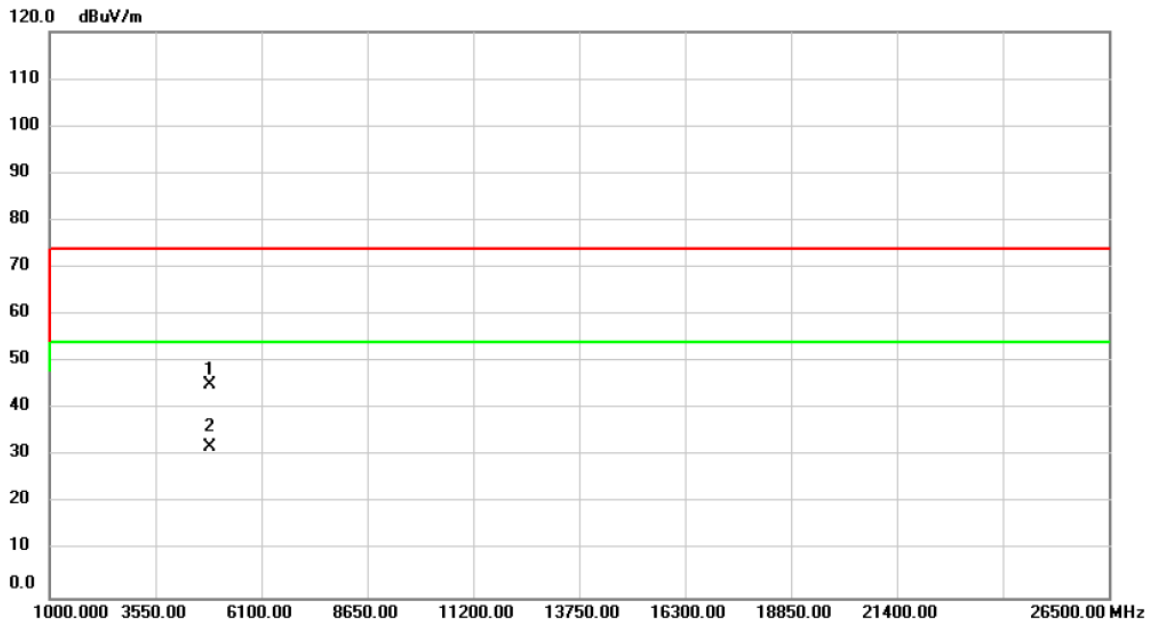

No.	Mk.	Freq.	Reading Level	Correct Factor	Measurement	Limit	Over	Detector	Comment
		MHz	dBuV	dB	dBuV/m	dBuV/m	dB		
1		4874.000	55.62	-10.54	45.08	74.00	-28.92	peak	
2	*	4874.000	42.58	-10.54	32.04	54.00	-21.96	AVG	

REMARKS:

- (1) Measurement Value = Reading Level + Correct Factor.
- (2) Margin Level = Measurement Value - Limit Value.

Test Mode	IEEE 802.11n (HT20)	Test Date	2020/4/30
Test Frequency	CH11: 2462 MHz	Polarization	Vertical

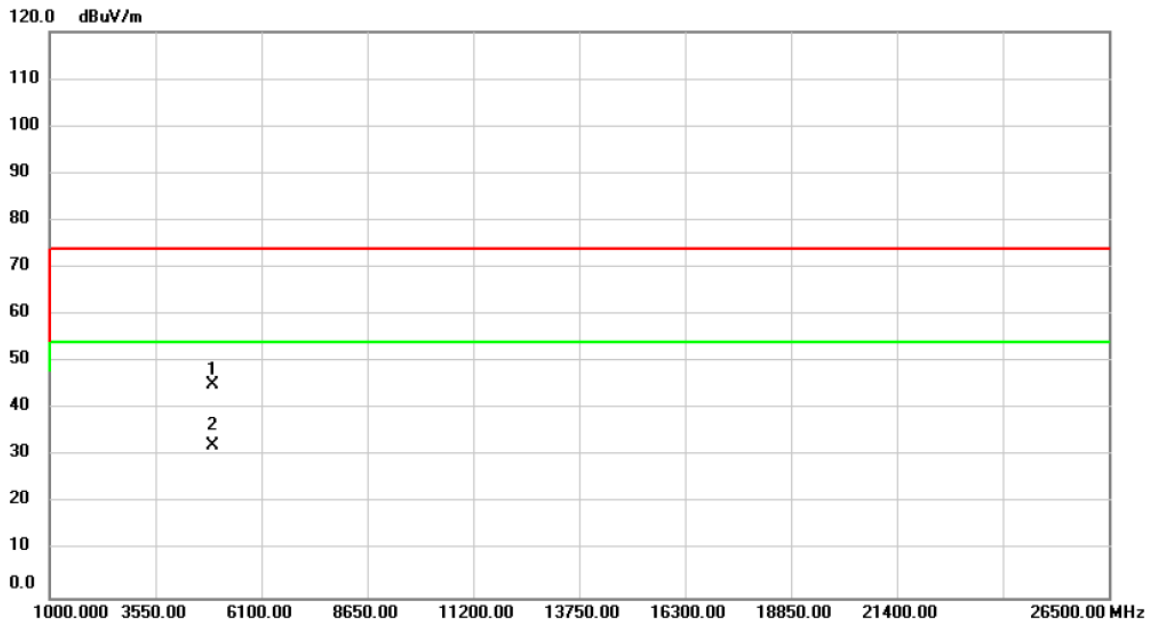

No.	Mk.	Freq.	Reading Level	Correct Factor	Measurement	Limit	Over	Detector	Comment
		MHz	dBuV	dB	dBuV/m	dBuV/m	dB		
1		4924.000	55.52	-10.43	45.09	74.00	-28.91	peak	
2	*	4924.000	42.64	-10.43	32.21	54.00	-21.79	AVG	

REMARKS:

- (1) Measurement Value = Reading Level + Correct Factor.
- (2) Margin Level = Measurement Value - Limit Value.

Test Mode	IEEE 802.11n (HT20)	Test Date	2020/4/30
Test Frequency	CH11: 2462 MHz	Polarization	Horizontal

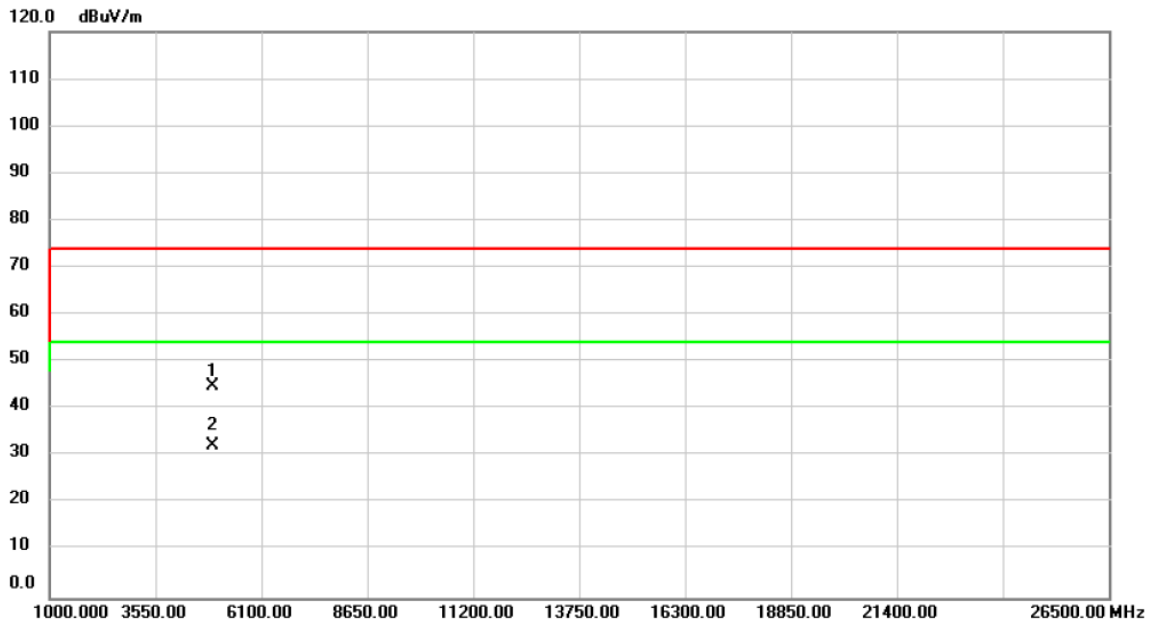

No.	Mk.	Freq.	Reading Level	Correct Factor	Measurement	Limit	Over	Detector	Comment
		MHz	dBuV	dB	dBuV/m	dBuV/m	dB		
1		4924.000	55.23	-10.43	44.80	74.00	-29.20	peak	
2	*	4924.000	42.74	-10.43	32.31	54.00	-21.69	AVG	

REMARKS:

- (1) Measurement Value = Reading Level + Correct Factor.
- (2) Margin Level = Measurement Value - Limit Value.

Test Mode	IEEE 802.11n (HT40)	Test Date	2020/4/29
Test Frequency	CH03: 2422 MHz	Polarization	Vertical

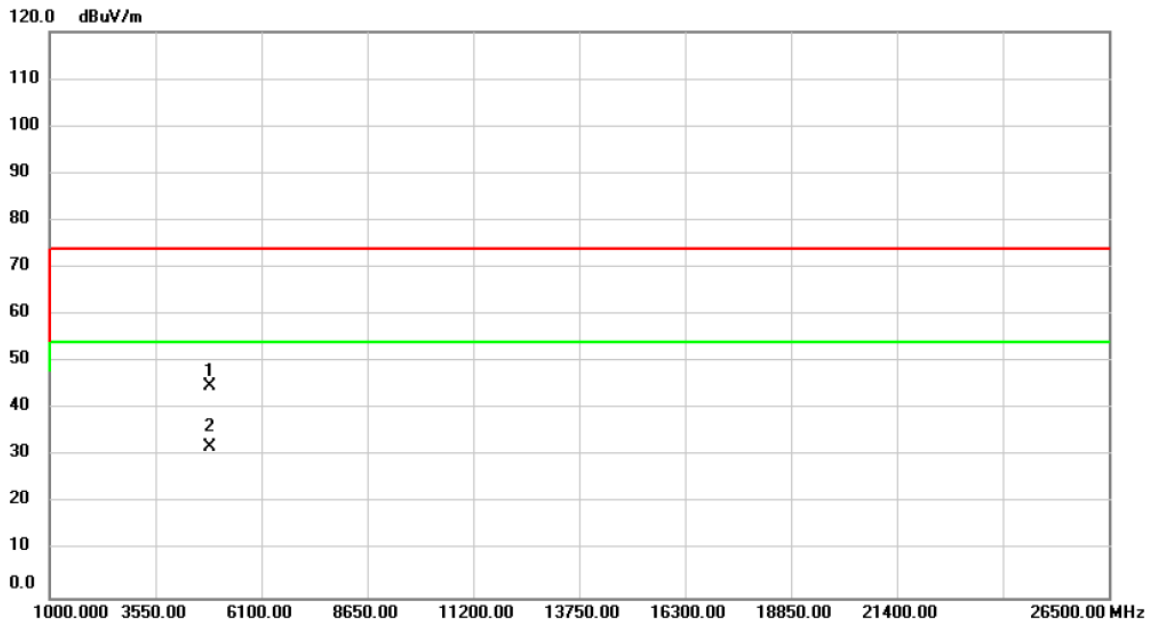

No.	Mk.	Freq.	Reading Level	Correct Factor	Measurement	Limit	Over	Detector	Comment
		MHz	dBuV	dB	dBuV/m	dBuV/m	dB		
1		4844.000	54.47	-9.74	44.73	74.00	-29.27	peak	
2	*	4844.000	41.65	-9.74	31.91	54.00	-22.09	AVG	

REMARKS:

- (1) Measurement Value = Reading Level + Correct Factor.
- (2) Margin Level = Measurement Value - Limit Value.

Test Mode	IEEE 802.11n (HT40)	Test Date	2020/4/29
Test Frequency	CH03: 2422 MHz	Polarization	Horizontal

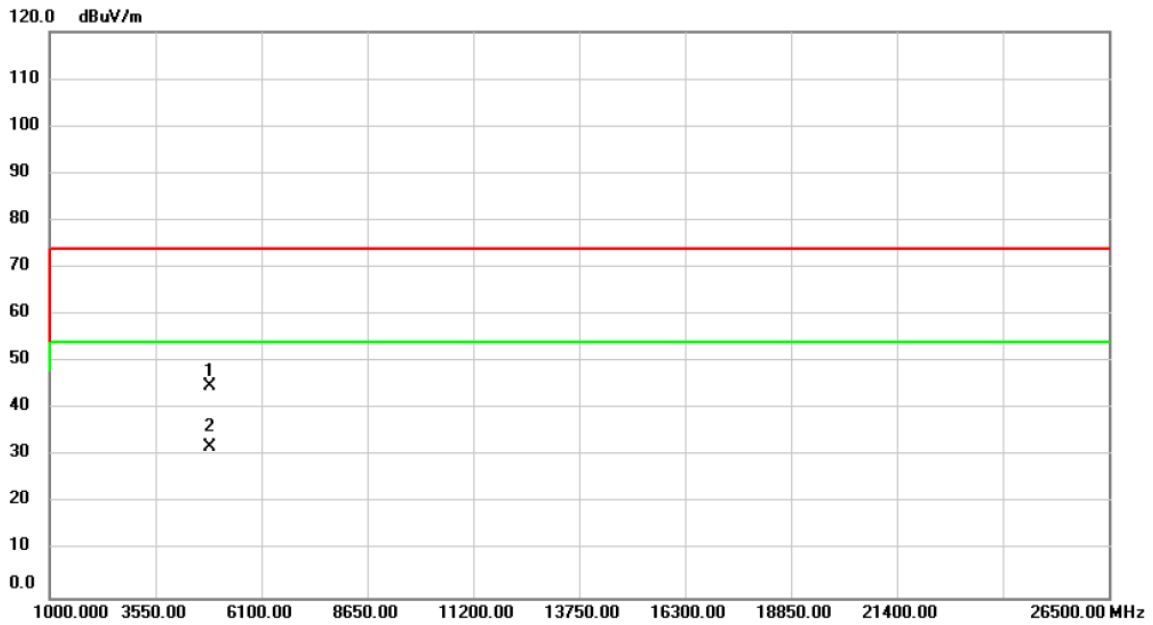

No.	Mk.	Freq.	Reading Level	Correct Factor	Measurement	Limit	Over	Detector	Comment
		MHz	dBuV	dB	dBuV/m	dBuV/m	dB		
1		4844.000	54.55	-9.74	44.81	74.00	-29.19	peak	
2	*	4844.000	41.67	-9.74	31.93	54.00	-22.07	AVG	

REMARKS:

- (1) Measurement Value = Reading Level + Correct Factor.
- (2) Margin Level = Measurement Value - Limit Value.

Test Mode	IEEE 802.11n (HT40)	Test Date	2020/4/29
Test Frequency	CH06: 2437 MHz	Polarization	Vertical

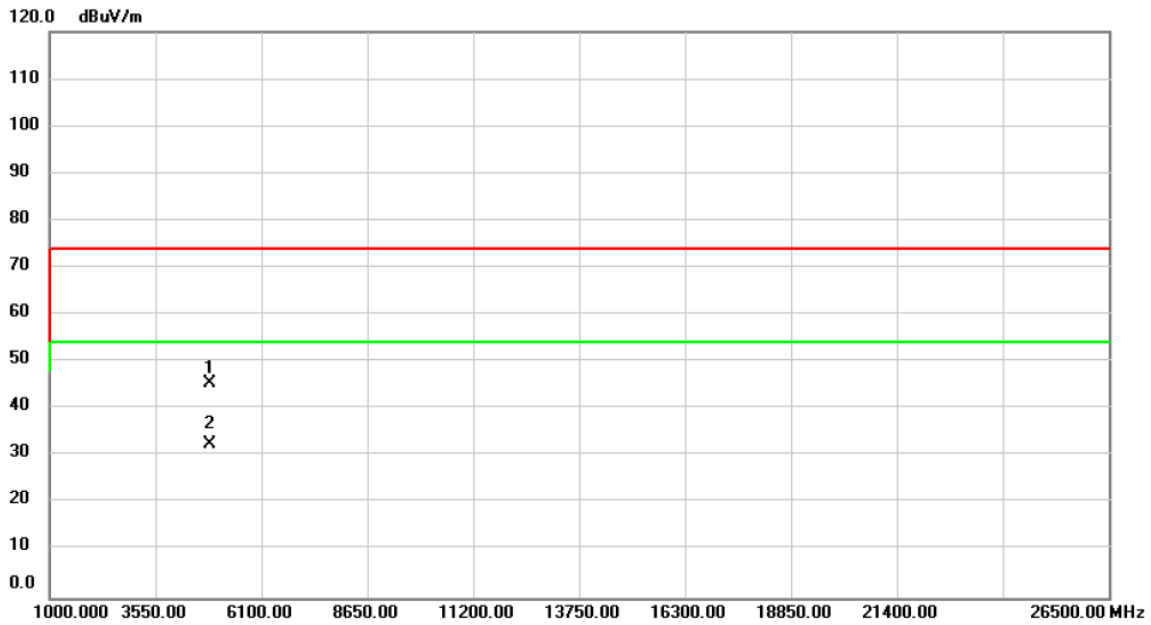

No.	Mk.	Freq.	Reading Level	Correct Factor	Measurement	Limit	Over	Detector	Comment
		MHz	dBuV	dB	dBuV/m	dBuV/m	dB		
1		4874.000	55.24	-9.67	45.57	74.00	-28.43	peak	
2	*	4874.000	42.24	-9.67	32.57	54.00	-21.43	AVG	

REMARKS:

- (1) Measurement Value = Reading Level + Correct Factor.
- (2) Margin Level = Measurement Value - Limit Value.

Test Mode	IEEE 802.11n (HT40)	Test Date	2020/4/29
Test Frequency	CH06: 2437 MHz	Polarization	Horizontal

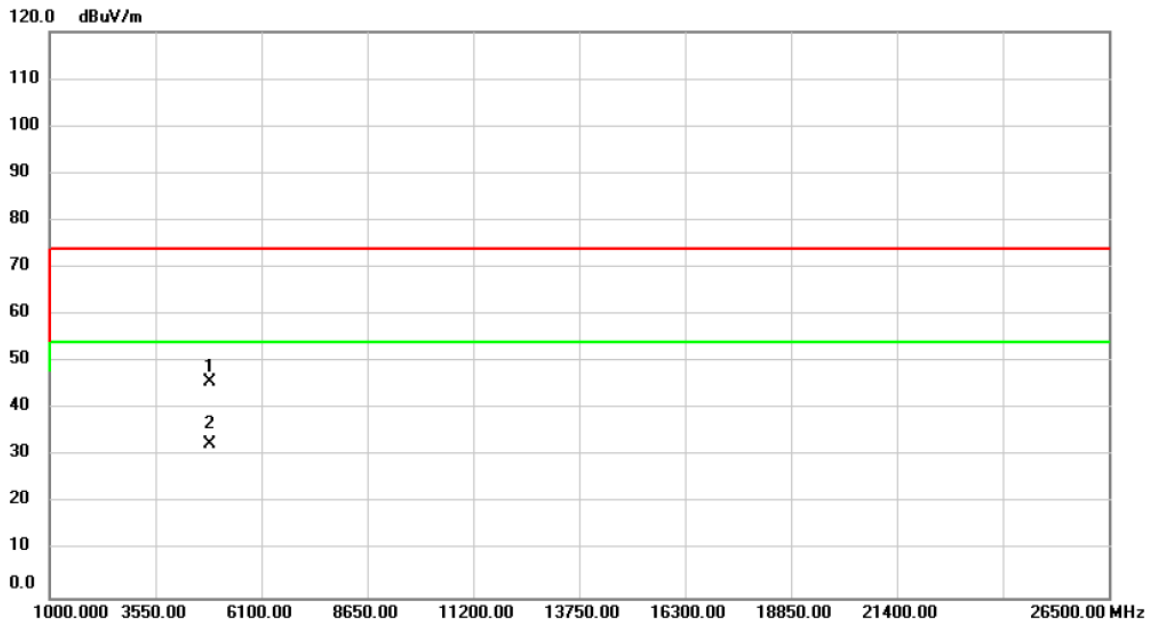

No.	Mk.	Freq.	Reading Level	Correct Factor	Measurement	Limit	Over	Detector	Comment
		MHz	dBuV	dB	dBuV/m	dBuV/m	dB		
1		4874.000	55.39	-9.67	45.72	74.00	-28.28	peak	
2	*	4874.000	42.15	-9.67	32.48	54.00	-21.52	AVG	

REMARKS:

- (1) Measurement Value = Reading Level + Correct Factor.
- (2) Margin Level = Measurement Value - Limit Value.

Test Mode	IEEE 802.11n (HT40)	Test Date	2020/4/29
Test Frequency	CH09: 2452 MHz	Polarization	Vertical

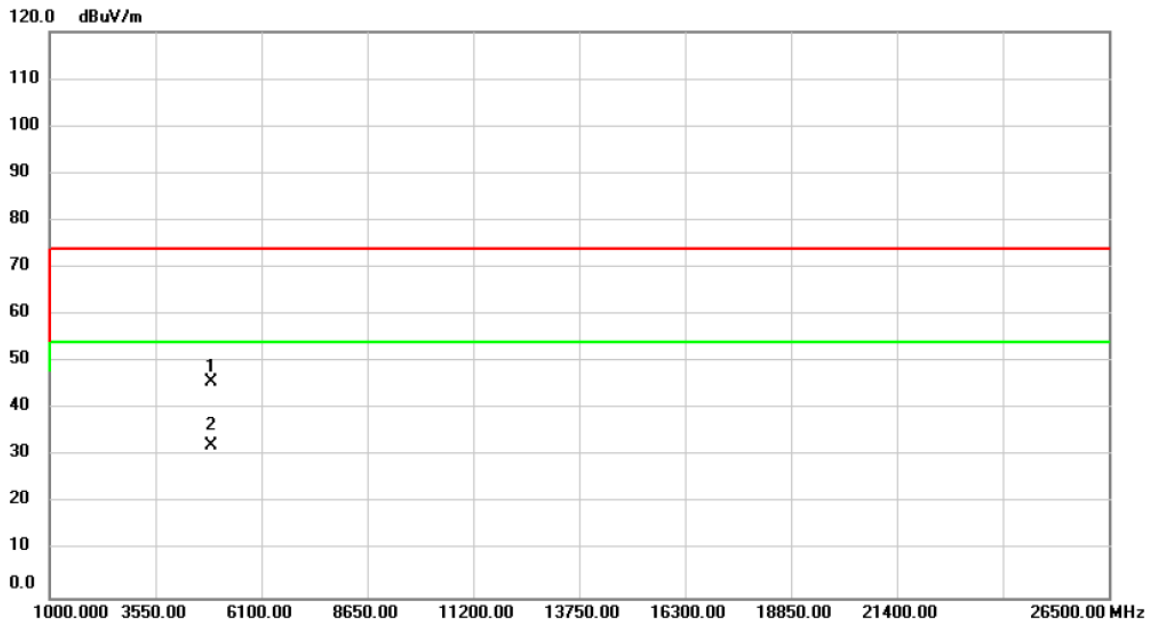

No.	Mk.	Freq.	Reading Level	Correct Factor	Measurement	Limit	Over	Detector	Comment
		MHz	dBuV	dB	dBuV/m	dBuV/m	dB		
1		4904.000	55.44	-9.60	45.84	74.00	-28.16	peak	
2	*	4904.000	42.00	-9.60	32.40	54.00	-21.60	AVG	

REMARKS:

- (1) Measurement Value = Reading Level + Correct Factor.
- (2) Margin Level = Measurement Value - Limit Value.

Test Mode	IEEE 802.11n (HT40)	Test Date	2020/4/29
Test Frequency	CH09: 2452 MHz	Polarization	Horizontal

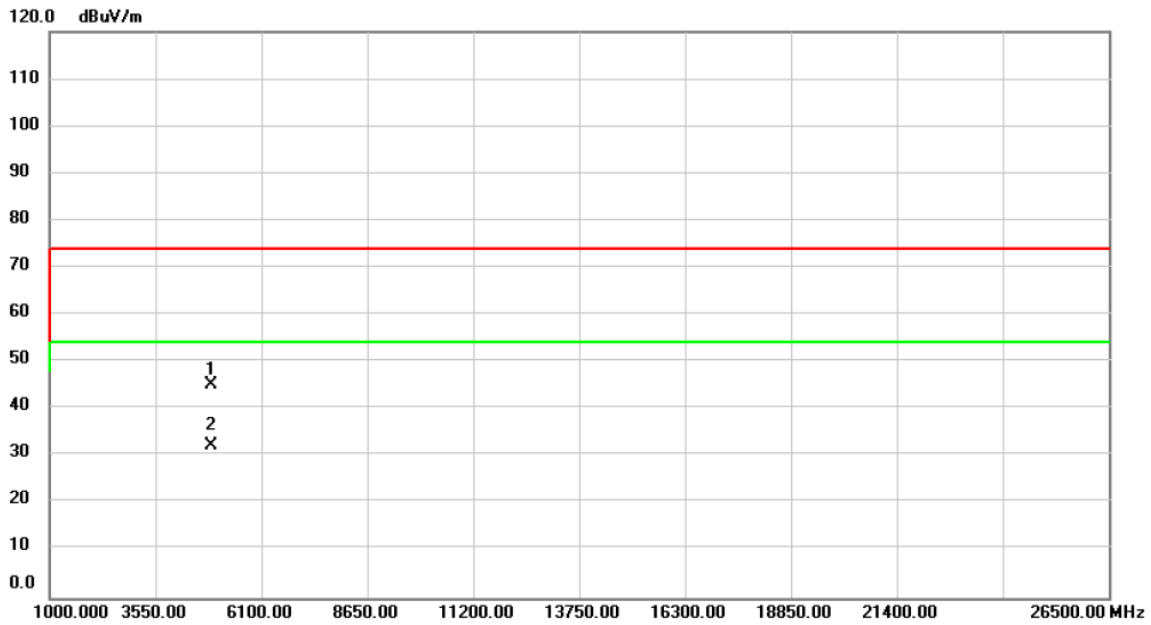

No.	Mk.	Freq.	Reading Level	Correct Factor	Measurement	Limit	Over	Detector	Comment
		MHz	dBuV	dB	dBuV/m	dBuV/m	dB		
1		4904.000	54.87	-9.60	45.27	74.00	-28.73	peak	
2	*	4904.000	41.93	-9.60	32.33	54.00	-21.67	AVG	

REMARKS:

- (1) Measurement Value = Reading Level + Correct Factor.
- (2) Margin Level = Measurement Value - Limit Value.

APPENDIX C BANDWIDTH

Test Mode	IEEE 802.11b
-----------	--------------

Frequency (MHz)	6dB Bandwidth (MHz)	99 % Occupied Bandwidth (MHz)	6 dB Bandwidth Limit (kHz)	Result
2412	9.11	14.16	500	Complies
2437	8.58	14.08	500	Complies
2462	9.54	14.08	500	Complies

6 dB Bandwidth

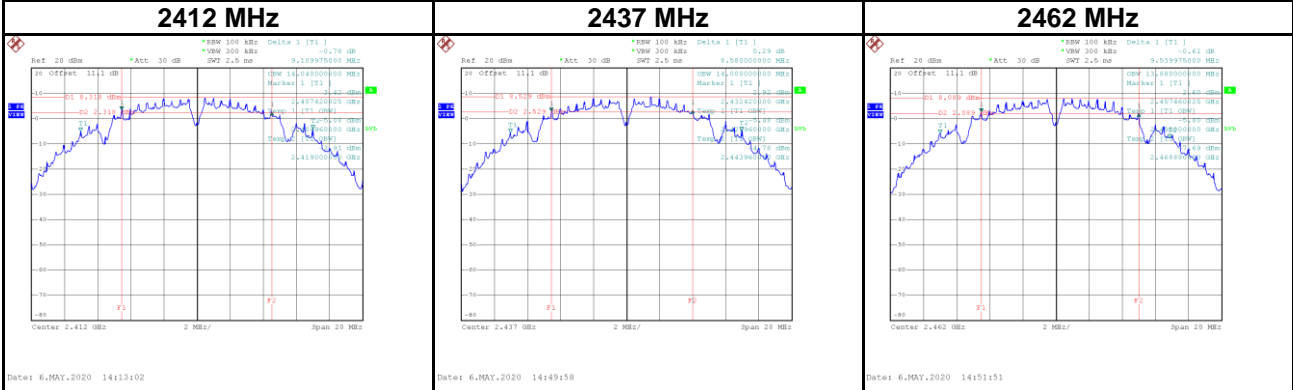

99 % Occupied Bandwidth

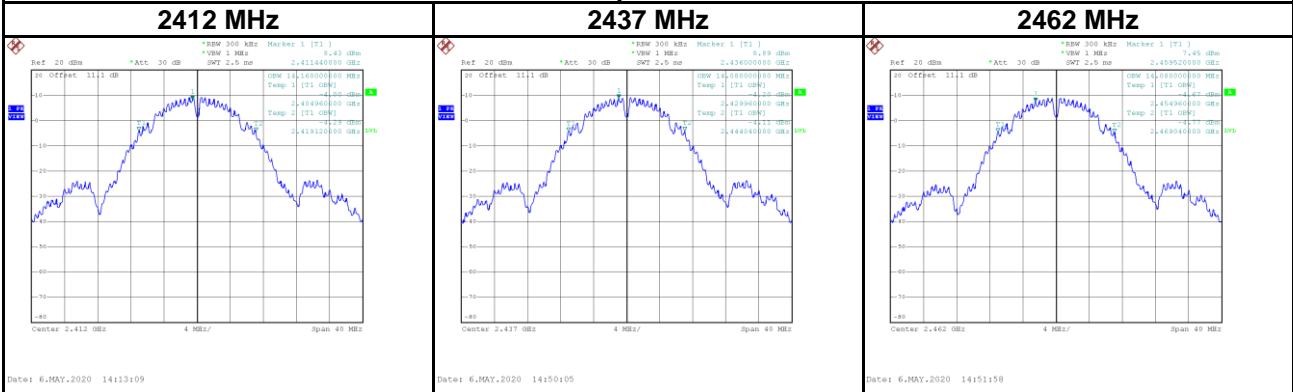

Test Mode	IEEE 802.11g
-----------	--------------

Frequency (MHz)	6dB Bandwidth (MHz)	99 % Occupied Bandwidth (MHz)	6 dB Bandwidth Limit (kHz)	Result
2412	16.42	17.36	500	Complies
2437	16.46	17.60	500	Complies
2462	16.48	17.44	500	Complies

6 dB Bandwidth

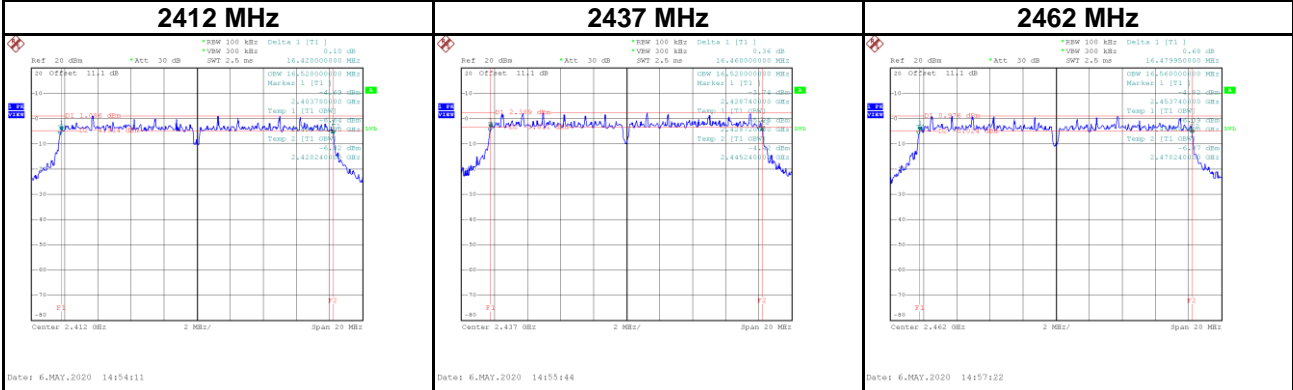

99 % Occupied Bandwidth

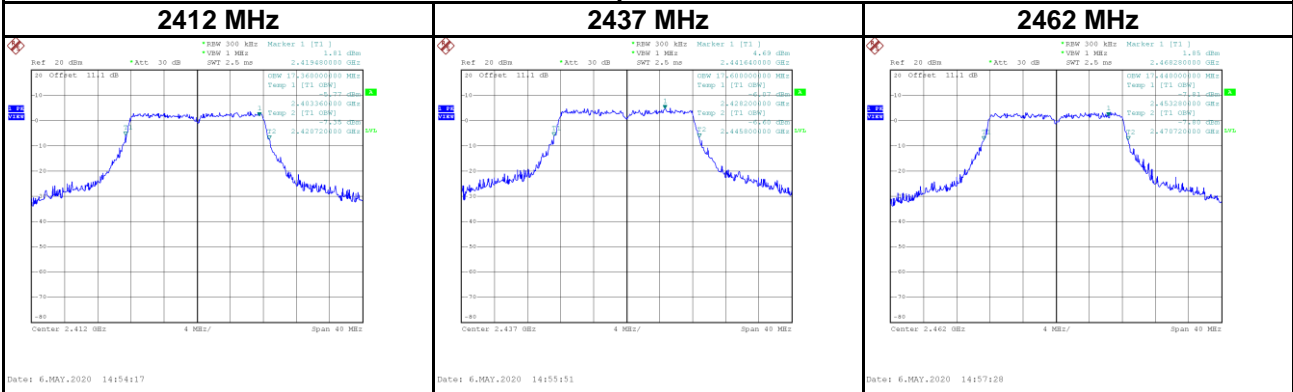

Test Mode	IEEE 802.11n (HT20)
-----------	---------------------

Frequency (MHz)	6dB Bandwidth (MHz)	99 % Occupied Bandwidth (MHz)	6 dB Bandwidth Limit (kHz)	Result
2412	17.62	18.24	500	Complies
2437	17.66	18.48	500	Complies
2462	17.66	18.40	500	Complies

6 dB Bandwidth

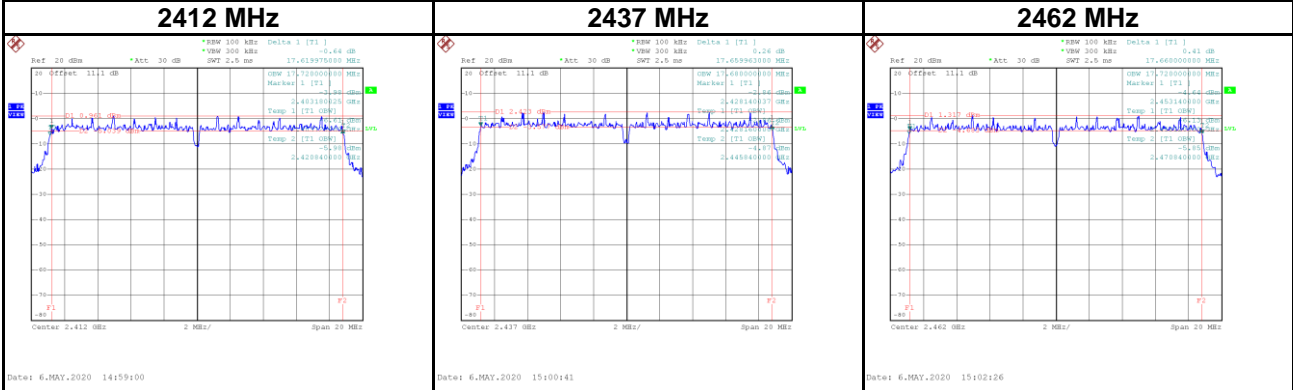

99 % Occupied Bandwidth

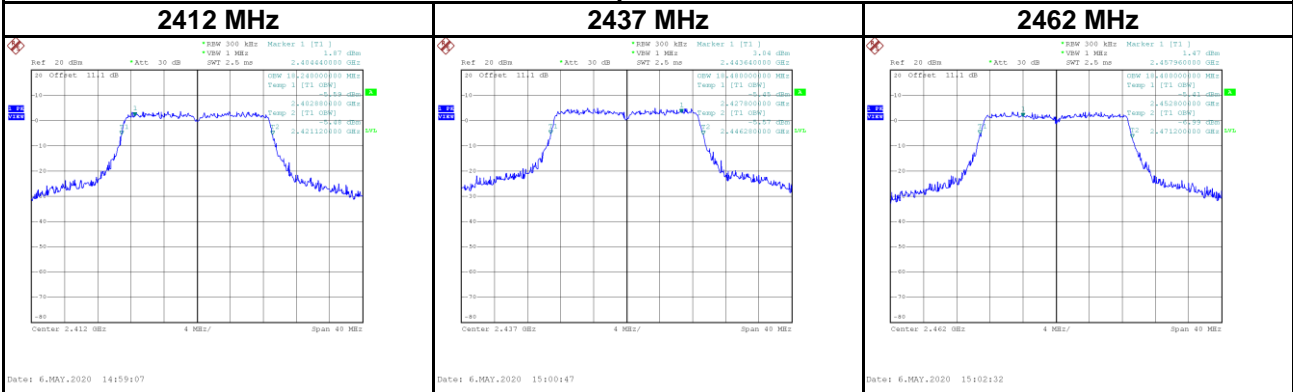

Test Mode	IEEE 802.11n (HT40)
-----------	---------------------

Frequency (MHz)	6dB Bandwidth (MHz)	99 % Occupied Bandwidth (MHz)	6 dB Bandwidth Limit (kHz)	Result
2422	35.28	37.12	500	Complies
2437	35.43	37.44	500	Complies
2452	35.28	37.28	500	Complies

6 dB Bandwidth

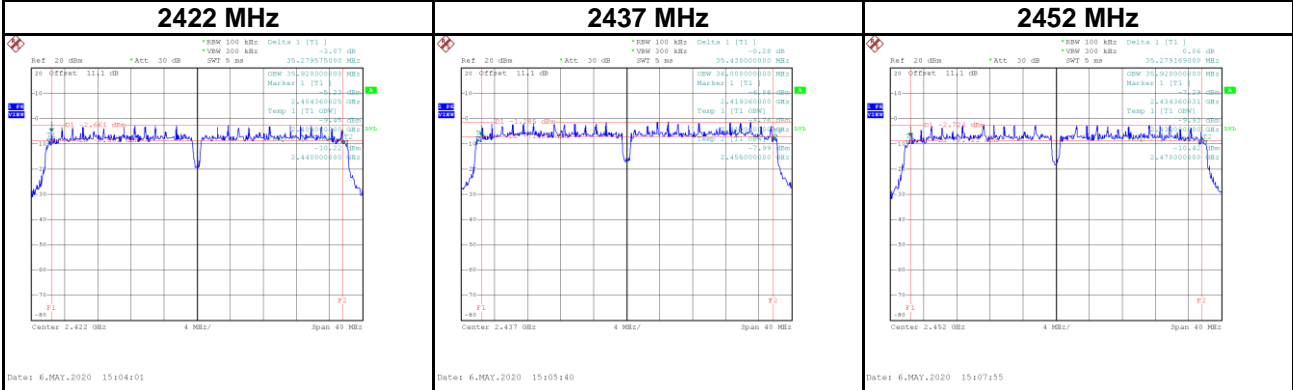

99 % Occupied Bandwidth

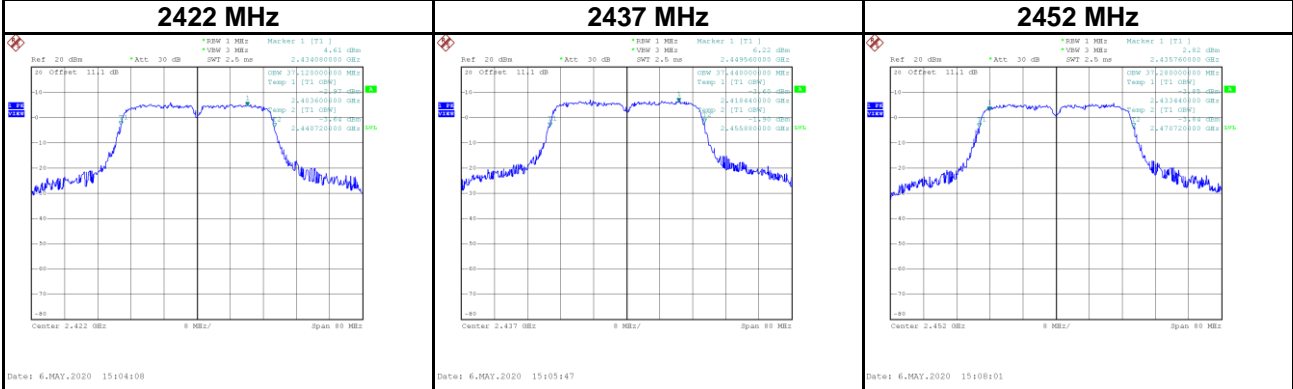

APPENDIX D OUTPUT POWER

Test Mode	IEEE 802.11b	Tested Date	2020/5/6
-----------	--------------	-------------	----------

Frequency (MHz)	Conducted Power (dBm)	Conducted Power (W)	Limit (dBm)	Limit (W)	Result
2412	19.84	0.0964	30.00	1.0000	Complies
2437	20.01	0.1002	30.00	1.0000	Complies
2462	19.44	0.0879	30.00	1.0000	Complies

Test Mode	IEEE 802.11g	Tested Date	2020/5/6
-----------	--------------	-------------	----------

Frequency (MHz)	Conducted Power (dBm)	Conducted Power (W)	Limit (dBm)	Limit (W)	Result
2412	20.14	0.1033	30.00	1.0000	Complies
2437	20.64	0.1159	30.00	1.0000	Complies
2462	20.02	0.1005	30.00	1.0000	Complies

Test Mode	IEEE 802.11n (HT20)	Tested Date	2020/5/6
-----------	---------------------	-------------	----------

Frequency (MHz)	Conducted Power (dBm)	Conducted Power (W)	Limit (dBm)	Limit (W)	Result
2412	20.45	0.1109	30.00	1.0000	Complies
2437	20.83	0.1211	30.00	1.0000	Complies
2462	20.40	0.1096	30.00	1.0000	Complies

Test Mode	IEEE 802.11n (HT40)	Tested Date	2020/5/6
-----------	---------------------	-------------	----------

Frequency (MHz)	Conducted Power (dBm)	Conducted Power (W)	Limit (dBm)	Limit (W)	Result
2422	19.86	0.0968	30.00	1.0000	Complies
2437	20.62	0.1153	30.00	1.0000	Complies
2452	19.73	0.0940	30.00	1.0000	Complies

APPENDIX E POWER SPECTRAL DENSITY

Test Mode | IEEE 802.11b

Frequency (MHz)	Power Density (dBm/3kHz)	Limit (dBm)	Result
2412	-6.70	8.00	Complies
2437	-6.09	8.00	Complies
2462	-6.55	8.00	Complies

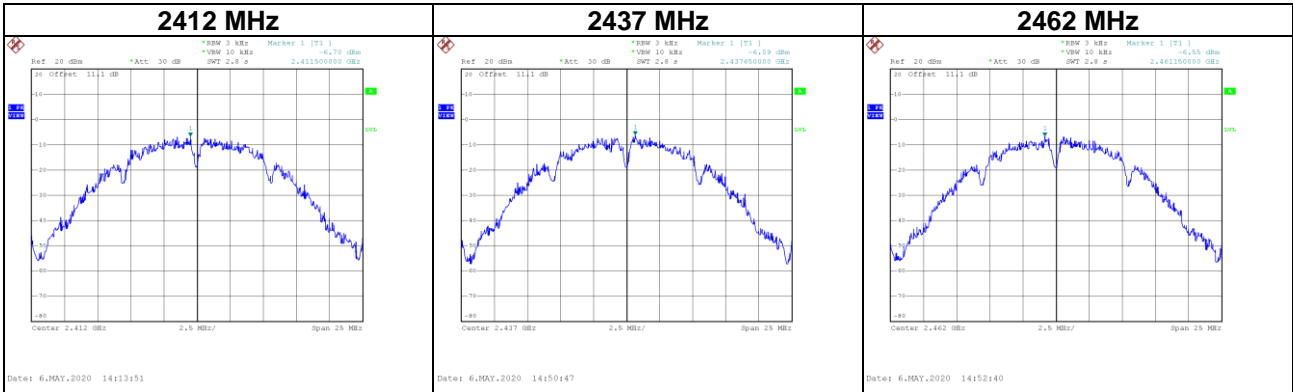

Test Mode | IEEE 802.11g

Frequency (MHz)	Power Density (dBm/3kHz)	Limit (dBm)	Result
2412	-11.86	8.00	Complies
2437	-12.35	8.00	Complies
2462	-13.58	8.00	Complies

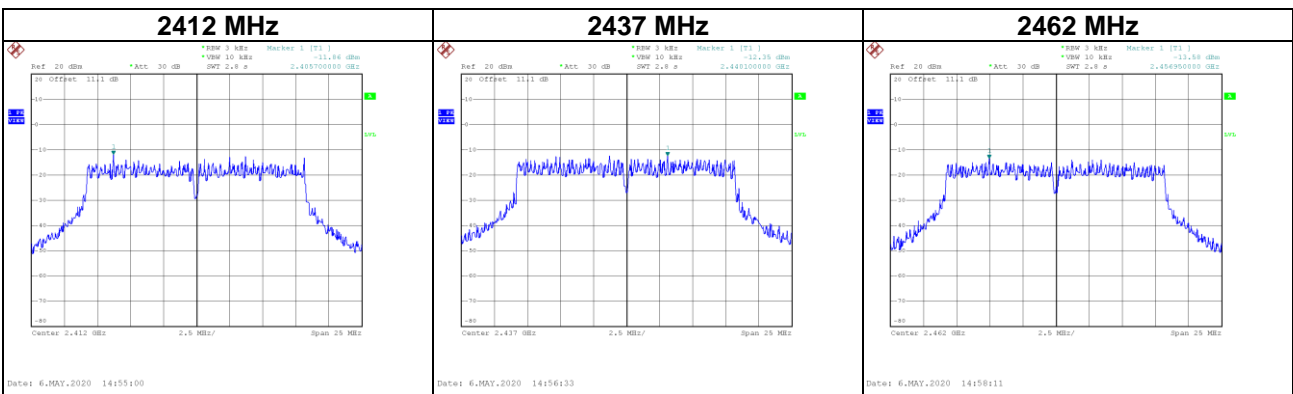

Test Mode	IEEE 802.11n (HT20)
-----------	---------------------

Frequency (MHz)	Power Density (dBm/3kHz)	Limit (dBm)	Result
2412	-13.08	8.00	Complies
2437	-12.30	8.00	Complies
2462	-13.58	8.00	Complies

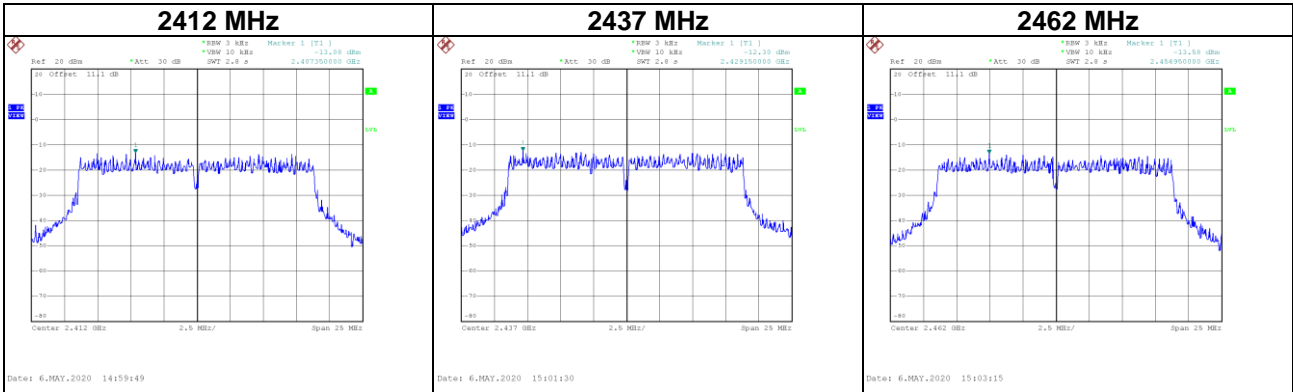

Test Mode	IEEE 802.11n (HT40)
-----------	---------------------

Frequency (MHz)	Power Density (dBm/3kHz)	Limit (dBm)	Result
2422	-18.41	8.00	Complies
2437	-16.15	8.00	Complies
2452	-16.68	8.00	Complies

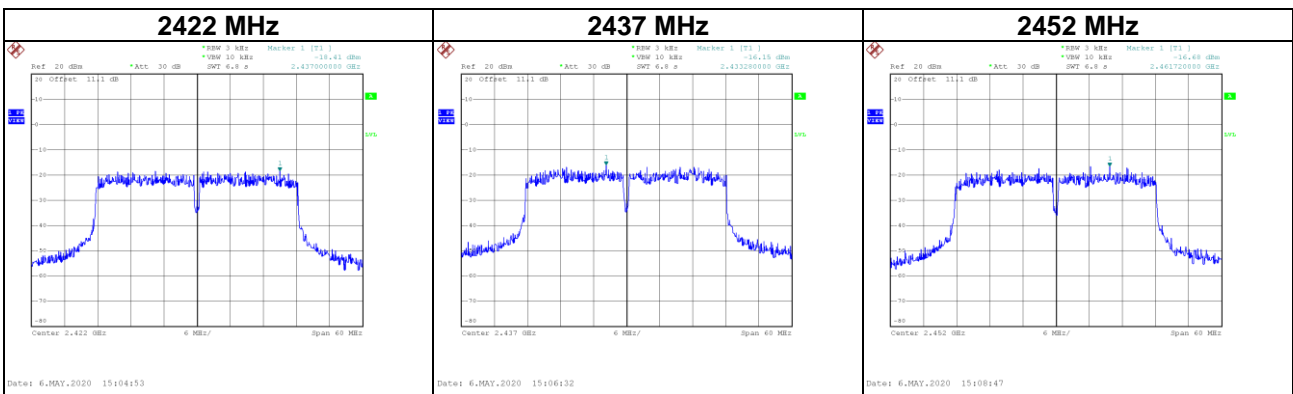

APPENDIX F ANTENNA CONDUCTED SPURIOUS EMISSIONS

Test Mode IEEE 802.11b

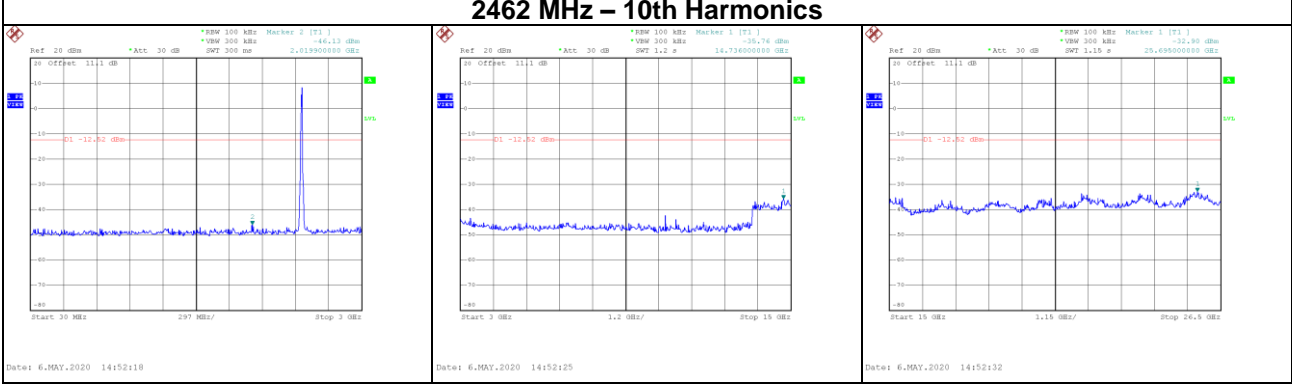
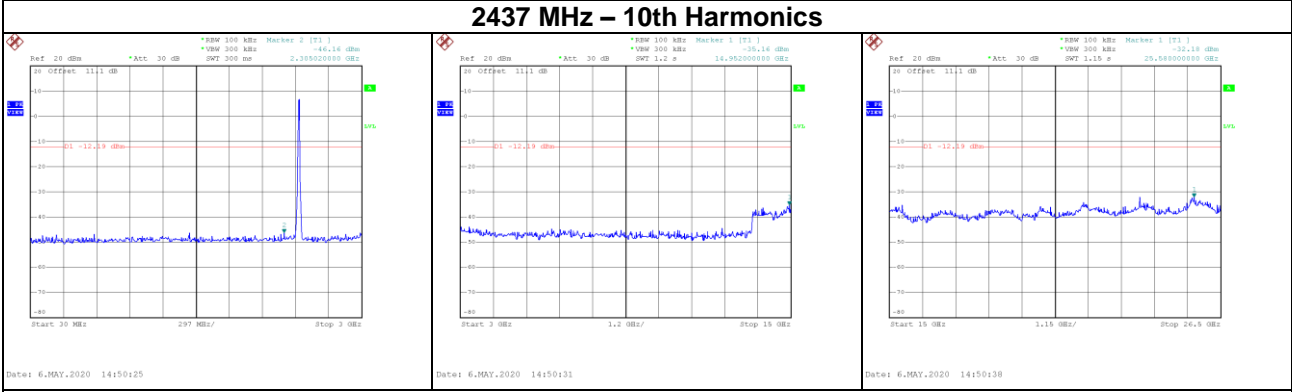
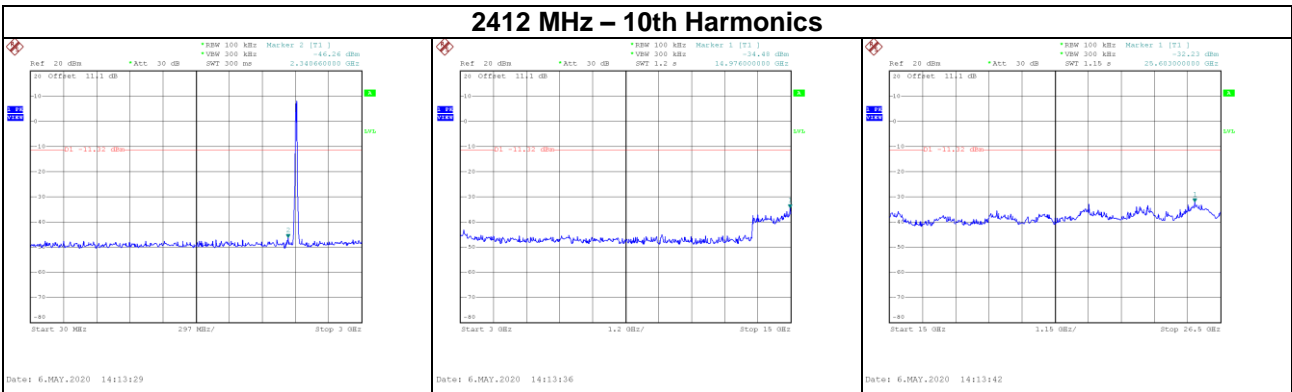
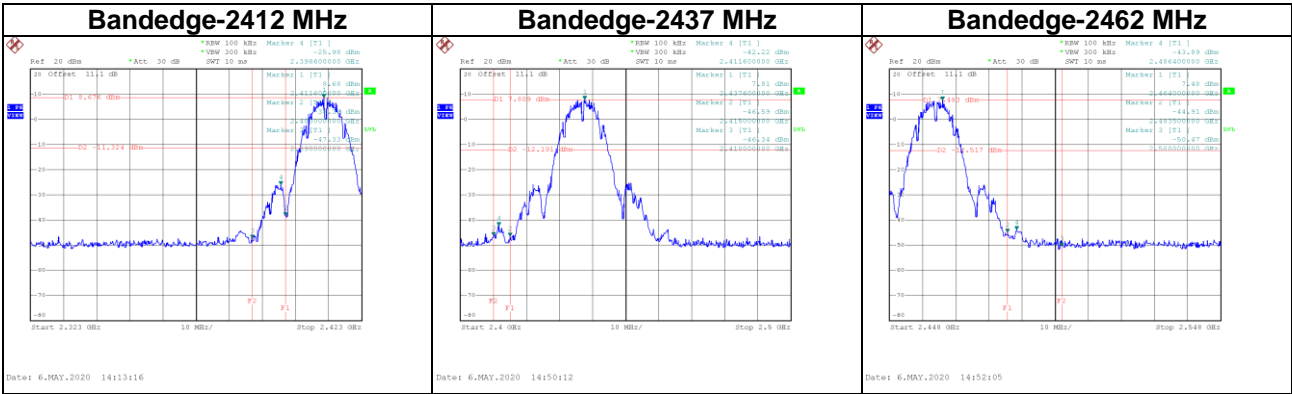

Test Mode | IEEE 802.11g

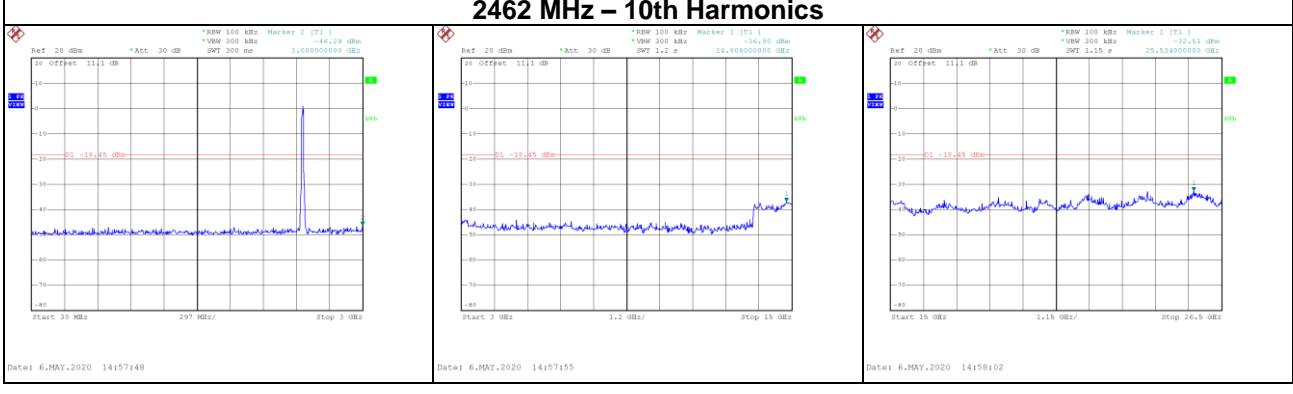
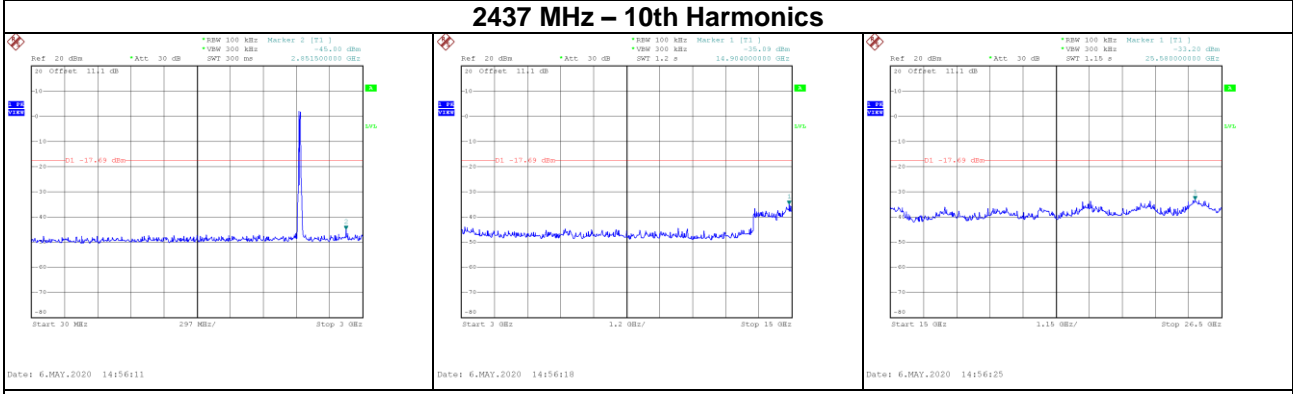
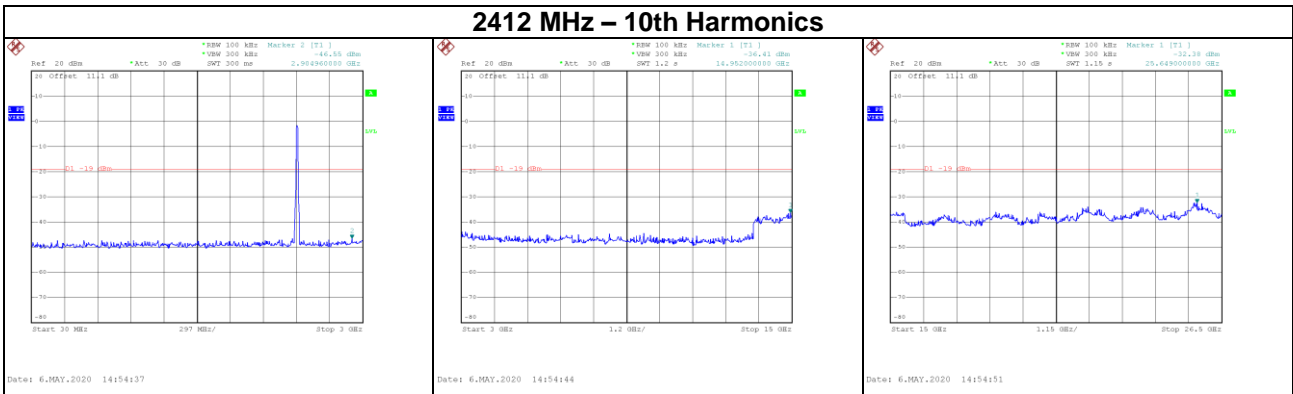
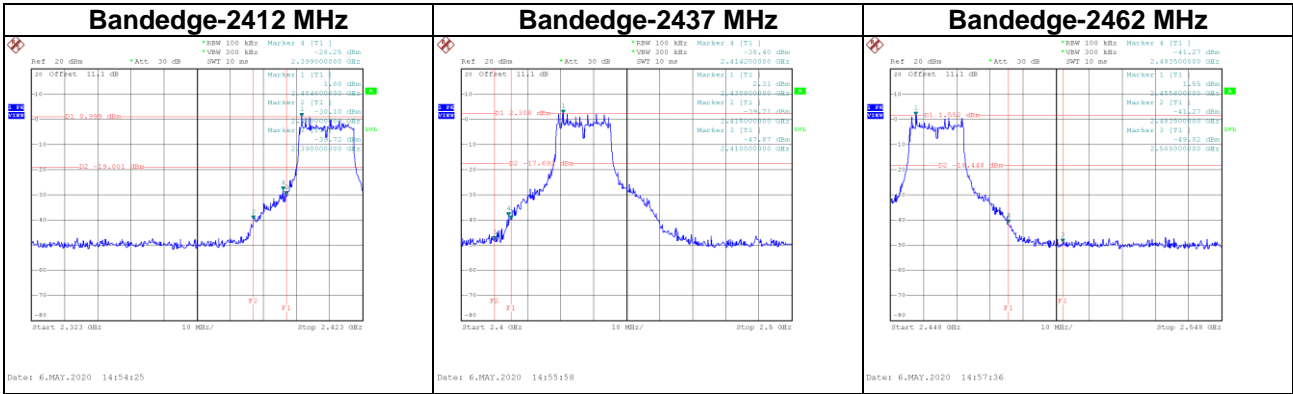

Test Mode | IEEE 802.11n (HT20)

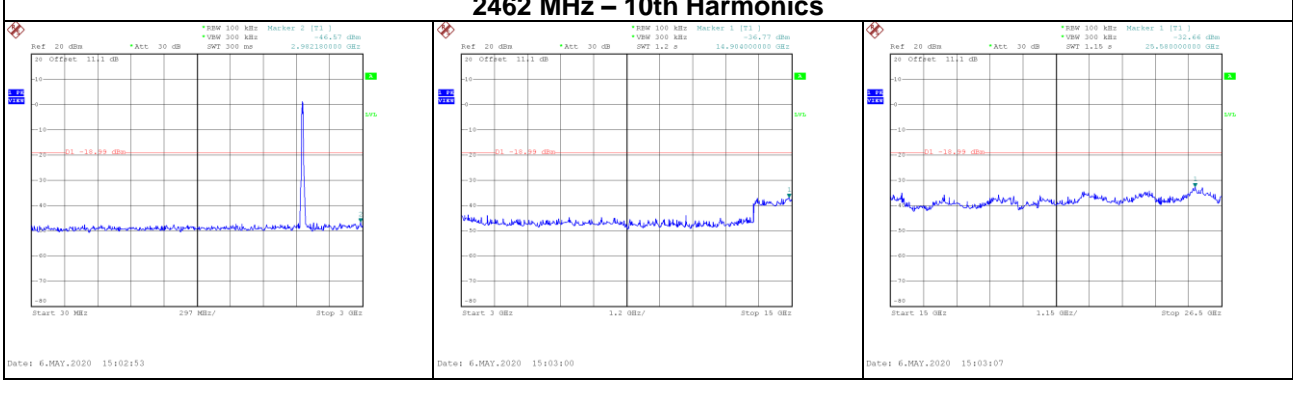
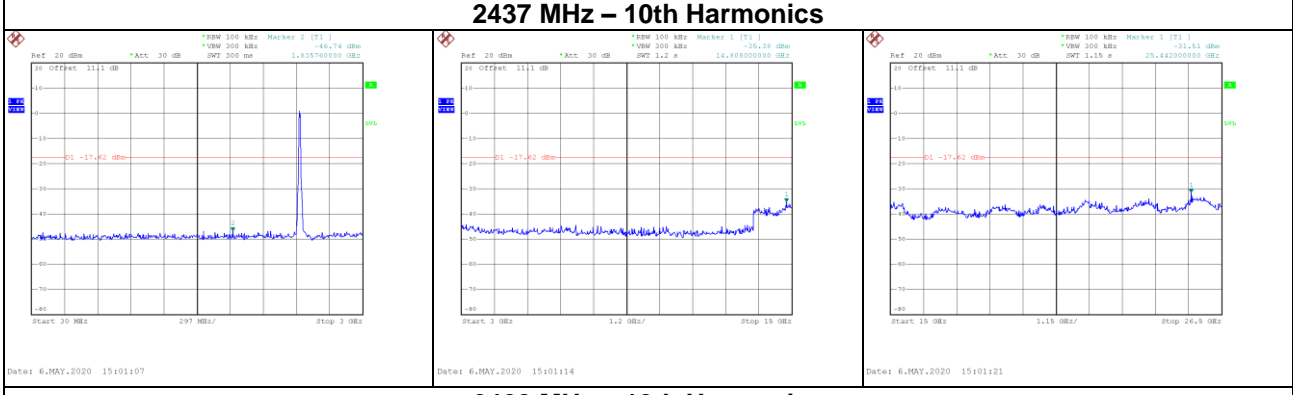
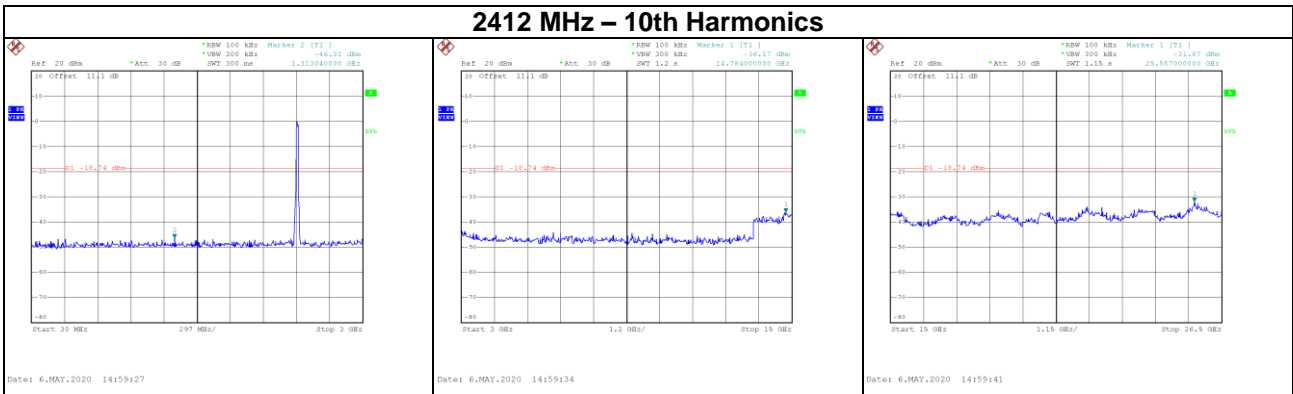
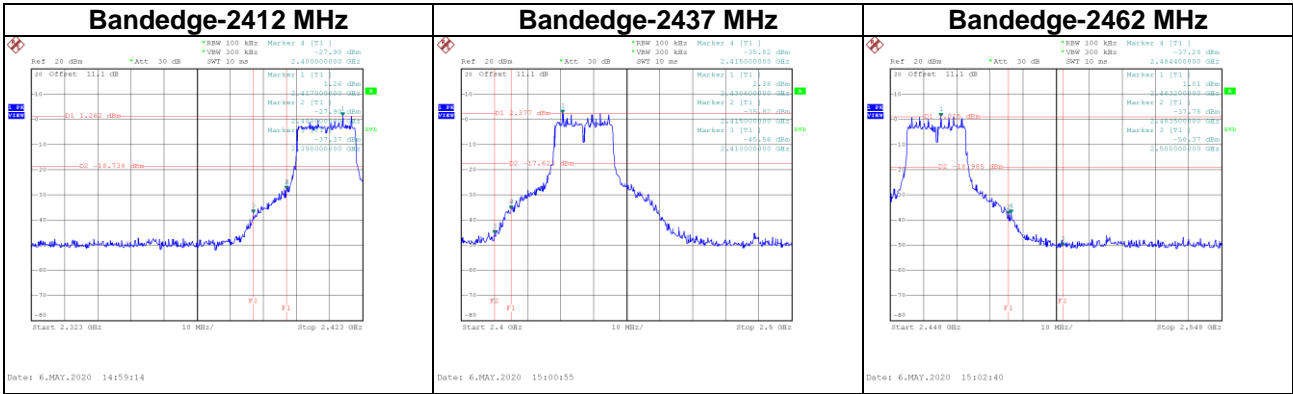

Test Mode IEEE 802.11n (HT40)

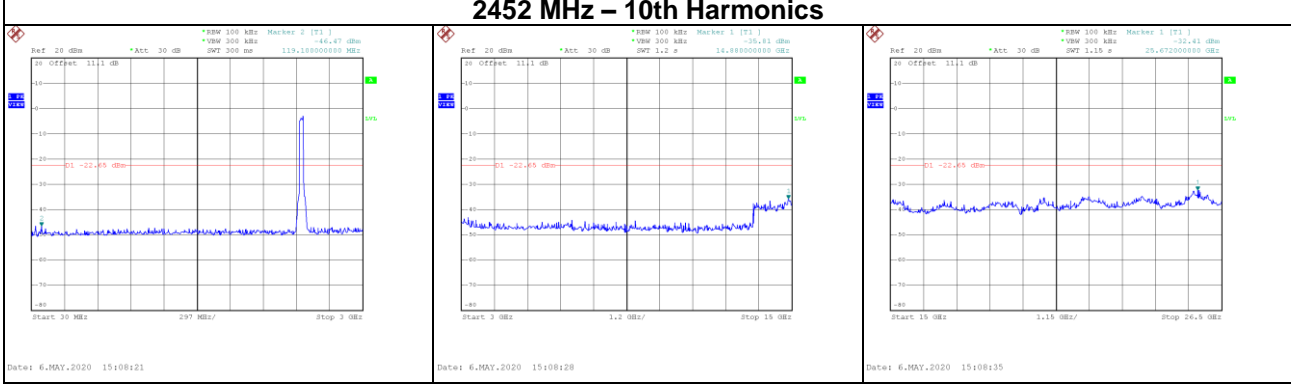
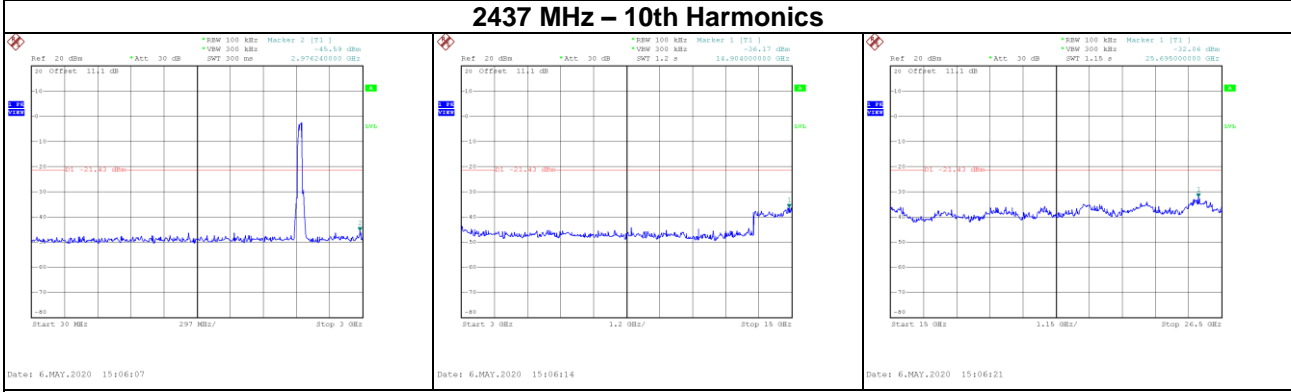
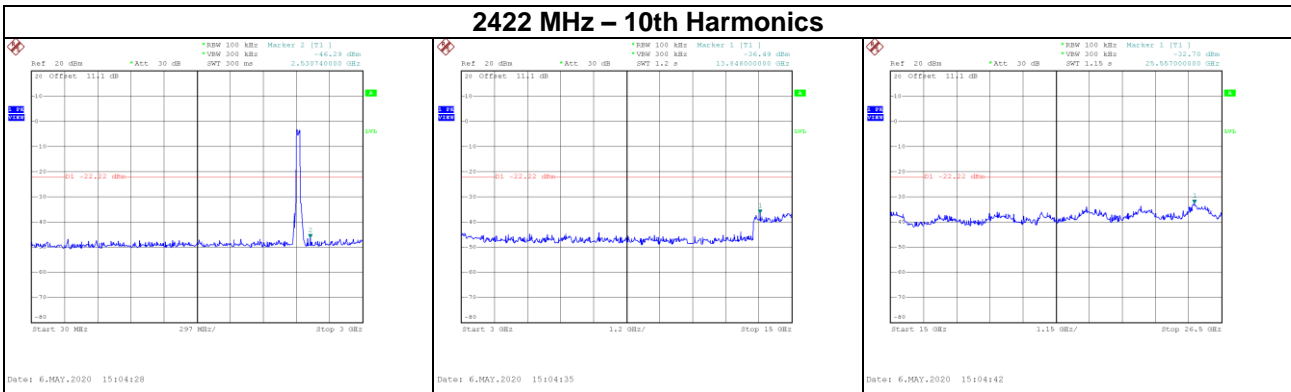
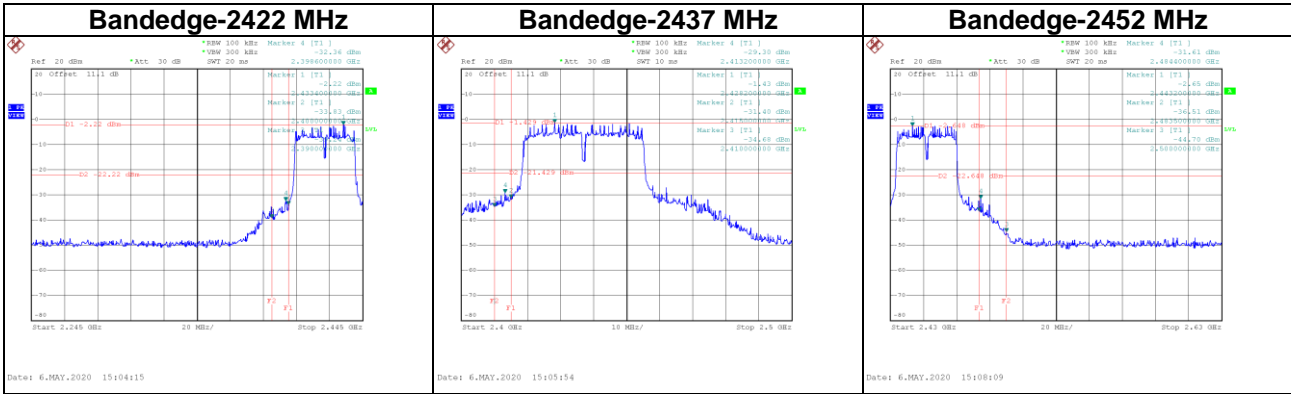

End of Test Report