

TEST REPORT

CERTIFICATE OF CONFORMITY

Standard: 47 CFR FCC Part 15, Subpart E (Section 15.407)

Report No.: RFBEZH-WTW-P23010321-4

FCC ID: EROM202215001

Product: 10.1 in. Wireless Touch Screen

Brand: Crestron Electronics, Inc.

Model No.: M202215001

Series Model: TST-1080

Received Date: 2023/3/2

Test Date: 2023/4/1 ~ 2023/5/19

Issued Date: 2023/5/29

Applicant: Crestron Electronics, Inc.

Address: 15 Volvo Drive, Rockleigh, NJ 07647

Issued By: Bureau Veritas Consumer Products Services (H.K.) Ltd., Taoyuan Branch
Lin Kou Laboratories

Lab Address: No. 47-2, 14th Ling, Chia Pau Vil., Lin Kou Dist., New Taipei City, Taiwan

Test Location (1): No. 19, Hwa Ya 2nd Rd., Wen Hwa Vil., Kewi Shan Dist., Taoyuan City 33383, Taiwan

Test Location (2): B2F., No. 215, Sec. 3, Beixin Rd., Xindian Dist., New Taipei City 231, Taiwan

FCC Registration / 788550 / TW0003

Designation Number (1):

FCC Registration / 427177 / TW0011

Designation Number (2):

Approved by: _____

Jeremy Lin

Date: _____

2023/5/29

Jeremy Lin / Project Engineer

This test report consists of 195 pages in total. It may be duplicated completely for legal use with the approval of the applicant. It should not be reproduced except in full, without the written approval of our laboratory. The test results in the report only apply to the tested sample. The test results in this report are traceable to the national or international standards.



Prepared by : Celine Chou / Senior Specialist

This report is governed by, and incorporates by reference, the Conditions of Testing as posted at the date of issuance of this report at <http://www.bureauveritas.com/home/about-us/our-business/cps/about-us/terms-conditions/> and is intended for your exclusive use. Any copying or replication of this report to or for any other person or entity, or use of our name or trademark, is permitted only with our prior written permission. This report sets forth our findings solely with respect to the test samples identified herein. The results set forth in this report are not indicative or representative of the quality or characteristics of the lot from which a test sample was taken or any similar or identical product unless specifically and expressly noted. Our report includes all of the tests requested by you and the results thereof based upon the information that you provided to us. Measurement uncertainty is only provided upon request for accredited tests. Statements of conformity are based on simple acceptance criteria without taking measurement uncertainty into account, unless otherwise requested in writing. You have 60 days from date of issuance of this report to notify us of any material error or omission caused by our negligence or if you require measurement uncertainty; provided, however, that such notice shall be in writing and shall specifically address the issue you wish to raise. A failure to raise such issue within the prescribed time shall constitute your unqualified acceptance of the completeness of this report, the tests conducted and the correctness of the report contents.

Table of Contents

| | |
|---|-----------|
| Release Control Record | 4 |
| 1 Certificate | 5 |
| 2 Summary of Test Results | 6 |
| 2.1 Measurement Uncertainty | 6 |
| 2.2 Supplementary Information | 6 |
| 3 General Information | 7 |
| 3.1 General Description of EUT | 7 |
| 3.2 Antenna Description of EUT | 9 |
| 3.3 Channel List | 10 |
| 3.4 Test Mode Applicability and Tested Channel Detail | 12 |
| 3.5 Duty Cycle of Test Signal | 14 |
| 3.6 Test Program Used and Operation Descriptions | 16 |
| 3.7 Connection Diagram of EUT and Peripheral Devices | 16 |
| 3.8 Configuration of Peripheral Devices and Cable Connections | 16 |
| 4 Test Instruments | 17 |
| 4.1 RF Output Power | 17 |
| 4.2 Power Spectral Density | 17 |
| 4.3 Emission Bandwidth | 17 |
| 4.4 In-Band Emission Mask | 17 |
| 4.5 Occupied Bandwidth | 17 |
| 4.6 Frequency Stability | 18 |
| 4.7 Contention-based Protocol | 18 |
| 4.8 AC Power Conducted Emissions | 19 |
| 4.9 Unwanted Emissions below 1 GHz | 20 |
| 4.10 Unwanted Emissions above 1 GHz | 21 |
| 5 Limits of Test Items | 22 |
| 5.1 RF Output Power | 22 |
| 5.2 Power Spectral Density | 22 |
| 5.3 Emission Bandwidth | 22 |
| 5.4 In-Band Emission Mask | 22 |
| 5.5 Occupied Bandwidth | 22 |
| 5.6 Frequency Stability | 23 |
| 5.7 Contention-based Protocol | 23 |
| 5.8 AC Power Conducted Emissions | 23 |
| 5.9 Unwanted Emissions below 1 GHz | 23 |
| 5.10 Unwanted Emissions above 1 GHz | 24 |
| 6 Test Arrangements | 25 |
| 6.1 RF Output Power | 25 |
| 6.1.1 Test Setup | 25 |
| 6.1.2 Test Procedure | 25 |
| 6.2 Power Spectral Density | 25 |
| 6.2.1 Test Setup | 25 |
| 6.2.2 Test Procedure | 25 |
| 6.3 Emission Bandwidth | 26 |
| 6.3.1 Test Setup | 26 |
| 6.3.2 Test Procedure | 26 |
| 6.4 In-Band Emission Mask | 26 |
| 6.4.1 Test Setup | 26 |
| 6.4.2 Test Procedure | 26 |
| 6.5 Occupied Bandwidth | 27 |
| 6.5.1 Test Setup | 27 |
| 6.5.2 Test Procedure | 27 |
| 6.6 Frequency Stability | 27 |
| 6.6.1 Test Setup | 27 |



| | | |
|-----------|--|------------|
| 6.6.2 | Test Procedure..... | 27 |
| 6.7 | Contention-based Protocol..... | 28 |
| 6.7.1 | Test Setup..... | 28 |
| 6.7.2 | Test Procedure..... | 28 |
| 6.8 | AC Power Conducted Emissions..... | 29 |
| 6.8.1 | Test Setup..... | 29 |
| 6.8.2 | Test Procedure..... | 29 |
| 6.9 | Unwanted Emissions below 1 GHz..... | 30 |
| 6.9.1 | Test Setup..... | 30 |
| 6.9.2 | Test Procedure..... | 31 |
| 6.10 | Unwanted Emissions above 1 GHz..... | 32 |
| 6.10.1 | Test Setup..... | 32 |
| 6.10.2 | Test Procedure..... | 32 |
| 7 | Test Results of Test Item..... | 33 |
| 7.1 | RF Output Power..... | 33 |
| 7.2 | Power Spectral Density..... | 40 |
| 7.3 | Emission Bandwidth..... | 49 |
| 7.4 | In-Band Emission Mask..... | 55 |
| 7.5 | Occupied Bandwidth..... | 87 |
| 7.6 | Frequency Stability..... | 93 |
| 7.7 | Contention-based Protocol..... | 94 |
| 7.8 | AC Power Conducted Emissions..... | 103 |
| 7.9 | Unwanted Emissions below 1 GHz..... | 109 |
| 7.10 | Unwanted Emissions above 1 GHz..... | 115 |
| 8 | Operational Restrictions for 6 GHz U-NII Devices..... | 193 |
| 9 | Pictures of Test Arrangements..... | 194 |
| 10 | Information of the Testing Laboratories..... | 195 |



Release Control Record

| Issue No. | Description | Date Issued |
|------------------------|-------------------|-------------|
| RFBEZH-WTW-P23010321-4 | Original release. | 2023/5/29 |

1 Certificate

Product: 10.1 in. Wireless Touch Screen

Brand: Crestron Electronics, Inc.

Test Model: M202215001

Series Model: TST-1080

Sample Status: Engineering sample

Applicant: Crestron Electronics, Inc.

Test Date: 2023/4/1 ~ 2023/5/19

Standard: 47 CFR FCC Part 15, Subpart E (Section 15.407)

Measurement ANSI C63.10-2013

procedure:

KDB 987594 D02 U-NII 6 GHz EMC Measurement v01v01

KDB 789033 D02 General UNII Test Procedure New Rules v02r01

KDB 662911 D01 Multiple Transmitter Output v02r01

The above equipment has been tested by **Bureau Veritas Consumer Products Services (H.K.) Ltd., Taoyuan Branch**, and found compliance with the requirement of the above standards. The test record, data evaluation & Equipment Under Test (EUT) configurations represented herein are true and accurate accounts of the measurements of the sample's RF characteristics under the conditions specified in this report.

2 Summary of Test Results

| 47 CFR FCC Part 15, Subpart E (Section 15.407) | | | |
|--|--|--------|---|
| Clause | Test Item | Result | Remark |
| 15.407(a)(8) | RF Output Power | Pass | Meet the requirement of limit. |
| 15.407(a)(8) | Power Spectral Density | Pass | Meet the requirement of limit. |
| 15.407(a)(10) | Occupied Bandwidth | Pass | Meet the requirement of limit. |
| 15.407(b)(9) | AC Power Conducted Emissions | Pass | Minimum passing margin is -14.51 dB at 0.80980 MHz |
| 15.407(b)(9) | Unwanted Emissions below 1 GHz | Pass | Minimum passing margin is -2.1 dB at 488.84 MHz |
| 15.407(b)(6) 15.407(b)(10) | Unwanted Emissions above 1 GHz | Pass | Minimum passing margin is -4.6 dB at 13390.00 MHz |
| 15.407(b)(7) | In-Band Emission Mask | Pass | Meet the requirement of limit. |
| 15.407(d)(6) | Contention-based Protocol | Pass | Meet the requirement of limit. |
| 15.407(g) | Frequency Stability | Pass | Meet the requirement of limit. |
| 15.407(d) | Operational restrictions for 6 GHz U-NII devices | Pass | Declaration by applicant |
| 15.203 | Antenna Requirement | Pass | Antenna connector is ipex not a standard connector. |
| --- | Emission Bandwidth | - | Reference only. |

Note: Determining compliance based on the results of the compliance measurement, not taking into account measurement instrumentation uncertainty.

2.1 Measurement Uncertainty

Where relevant, the following measurement uncertainty levels have been estimated for tests performed on the EUT as specified in CISPR 16-4-2:

| Measurement | Specification | Expanded Uncertainty (k=2) (±) |
|--------------------------------|-----------------|-----------------------------------|
| AC Power Conducted Emissions | 9 kHz ~ 30 MHz | 2.99 dB |
| Unwanted Emissions below 1 GHz | 9 kHz ~ 30 MHz | 2.44 dB |
| | 30 MHz ~ 1 GHz | 2.02 dB |
| Unwanted Emissions above 1 GHz | 1 GHz ~ 18 GHz | 1.01 dB |
| | 18 GHz ~ 40 GHz | 1.15 dB |

The other instruments specified are routine verified to remain within the calibrated levels, no measurement uncertainty is required to be calculated.

2.2 Supplementary Information

There is not any deviation from the test standards for the test method, and no modifications required for compliance.

3 General Information

3.1 General Description of EUT

| | |
|-----------------------|--|
| Product | 10.1 in. Wireless Touch Screen |
| Brand | Crestron Electronics, Inc. |
| Test Model | M202215001 |
| Series Model | TST-1080 |
| Model Difference | Marketing Differentiation |
| Status of EUT | Engineering sample |
| Power Supply Rating | 3.1 ~ 4.35 Vdc from battery or 9 Vdc, 3 A from USB type C port or 24 Vdc, 1.25 A from Wall dock or 24 Vdc, 1.25 A from Table dock |
| Modulation Type | 64QAM, 16QAM, QPSK, BPSK for OFDM 1024QAM for OFDMA in 11ax HE mode |
| Modulation Technology | OFDM, OFDMA |
| Transfer Rate | 802.11a: up to 54 Mbps 802.11ax: up to 2402 Mbps |
| Operating Frequency | 5.955 GHz ~ 6.415 GHz 6.435 GHz ~ 6.525 GHz 6.535 GHz ~ 6.865 GHz 6.875 GHz ~ 7.115 GHz |
| Number of Channel | 802.11a, 802.11ax (HE20): 59 802.11ax (HE40): 29 802.11ax (HE80): 14 802.11ax (HE160): 7 |
| Output Power | 5.955 GHz ~ 6.415 GHz : EIRP: 35.066 mW (15.45 dBm) 6.435 GHz ~ 6.525 GHz : EIRP: 38.232 mW (15.82 dBm) 6.535 GHz ~ 6.865 GHz : EIRP: 38.036 mW (15.80 dBm) 6.875 GHz ~ 7.115 GHz : EIRP: 29.371 mW (14.68 dBm) |
| Resource Unit (RU) | Single RU: 26-tone, 52-tone, 106-tone, 242-tone, 484-tone, 996-tone, 996x2-tone |
| EUT Category | Client Device (controlled of an indoor AP) |

Note:

1. The EUT use following accessories:

| Item | Brand | Model (Part Number) | Spec. |
|------------|----------|---------------------|---|
| Wall Dock | Crestron | TST-1080-DSW | Adapter:NBS30G240125D5 AC Input : 100-240V, 50~60Hz, 0.6A DC Output : 24V 1.25A |
| Table Dock | Crestron | TST-1080-DS | Adapter:NBS30G240125D5 AC Input : 100-240V, 50~60Hz, 0.6A DC Output : 24V 1.25A |

2. The EUT use following Adapters (Support unit) for test:

| Adapter | Brand | Model No. | Spec. |
|-----------|-----------|----------------|---|
| Adapter 1 | Gigastone | PD-7650W | AC Input: 100-240 Vac, 50-60 Hz, 1.5 A USB-C1/C2: 3.3-11 Vdc, 3 A or 5 Vdc, 3 A or 9 Vdc, 3 A or 12 Vdc, 3 A or 15 Vdc, 3 A or 20 Vdc, 3.25 A USB-A: 4.5 Vdc, 5 A or 5 Vdc, 4.5 A or 9 Vdc, 3 A or 12 Vdc, 2.5 A or 20 Vdc, 1.5 A |
| Adapter 2 | Crestron | NBS30G240125D5 | AC input: 100-240 Vac, 50/60 Hz, 0.6 A DC output: 24.0 Vdc, 1.25 A, 30.0 W |

3. There are Bluetooth and WLAN (2.4 GHz & 5 GHz & 6 GHz) technology used for the EUT.

4. WLAN 2.4 GHz & WLAN 5 GHz & WLAN 6 GHz & Bluetooth technology cannot transmit at same time.

5. The above EUT information is declared by manufacturer and for more detailed features description, please refer to the manufacturer's specifications or user's manual.

3.2 Antenna Description of EUT

1. The antenna information is listed as below.

| Antenna No. | Gain (dBi) | | | Antenna Type | Connector Type |
|-------------|------------|---------|---------|--------------|----------------|
| | 6135MHz | 6455MHz | 7015MHz | | |
| 1 | 4.63 | 4.08 | 3.19 | FPC dipole | ipex(MHF) |
| 2 | 3.93 | 4.86 | 3.79 | FPC dipole | ipex(MHF) |

* Detail antenna specification please refer to antenna datasheet and/or antenna measurement report.

2. The EUT incorporates a MIMO function:

| 6 GHz Band | | |
|---|-----------------------|-----|
| Modulation Mode | Tx & Rx Configuration | |
| 802.11a | 2TX | 2RX |
| 802.11ax (HE20) (RU26/52/106/242) | 2TX | 2RX |
| 802.11ax (HE40) (RU26/52/106/242/484) | 2TX | 2RX |
| 802.11ax (HE80) (RU26/52/106/242/484/996) | 2TX | 2RX |
| 802.11ax (HE160) (RU26/52/106/242/484/996/996x2) | 2TX | 2RX |

Note:

1. The EUT device modulation technique OFDM and support Partial RU, but not support channel puncturing reduction mechanisms.
2. The EUT support OFDMA and Partial RU mode, therefore partial RU combination were investigated and the worst case scenario was identified, only chosen the worst case to representative mode in this test report (please to item 3.4 for more details)

3.3 Channel List

U-NII-5:

24 channels are provided for 802.11a, 802.11ax (HE20):

| Channel | Frequency | Channel | Frequency | Channel | Frequency | Channel | Frequency |
|---------|-----------|---------|-----------|---------|-----------|---------|-----------|
| 1 | 5955 MHz | 5 | 5975 MHz | 9 | 5995 MHz | 13 | 6015 MHz |
| 17 | 6035 MHz | 21 | 6055 MHz | 25 | 6075 MHz | 29 | 6095 MHz |
| 33 | 6115 MHz | 37 | 6135 MHz | 41 | 6155 MHz | 45 | 6175 MHz |
| 49 | 6195 MHz | 53 | 6215 MHz | 57 | 6235 MHz | 61 | 6255 MHz |
| 65 | 6275 MHz | 69 | 6295 MHz | 73 | 6315 MHz | 77 | 6335 MHz |
| 81 | 6355 MHz | 85 | 6375 MHz | 89 | 6395 MHz | 93 | 6415 MHz |

12 channels are provided for 802.11ax (HE40):

| Channel | Frequency | Channel | Frequency | Channel | Frequency | Channel | Frequency |
|---------|-----------|---------|-----------|---------|-----------|---------|-----------|
| 3 | 5965 MHz | 11 | 6005 MHz | 19 | 6045 MHz | 27 | 6085 MHz |
| 35 | 6125 MHz | 43 | 6165 MHz | 51 | 6205 MHz | 59 | 6245 MHz |
| 67 | 6285 MHz | 75 | 6325 MHz | 83 | 6365 MHz | 91 | 6405 MHz |

6 channels are provided for 802.11ax (HE80):

| Channel | Frequency | Channel | Frequency | Channel | Frequency | Channel | Frequency |
|---------|-----------|---------|-----------|---------|-----------|---------|-----------|
| 7 | 5985 MHz | 23 | 6065 MHz | 39 | 6145 MHz | 55 | 6225 MHz |
| 71 | 6305 MHz | 87 | 6385 MHz | | | | |

3 channels are provided for 802.11ax (HE160):

| Channel | Frequency | Channel | Frequency | Channel | Frequency |
|---------|-----------|---------|-----------|---------|-----------|
| 15 | 6025 MHz | 47 | 6185 MHz | 79 | 6345 MHz |

U-NII-6:

5 channels are provided for 802.11a, 802.11ax (HE20):

| Channel | Frequency | Channel | Frequency | Channel | Frequency | Channel | Frequency |
|---------|-----------|---------|-----------|---------|-----------|---------|-----------|
| 97 | 6435 MHz | 101 | 6455 MHz | 105 | 6475 MHz | 109 | 6495 MHz |
| 113 | 6515 MHz | | | | | | |

3 channels are provided for 802.11ax (HE40):

| Channel | Frequency | Channel | Frequency | Channel | Frequency |
|---------|-----------|---------|-----------|---------|-----------|
| 99 | 6445 MHz | 107 | 6485 MHz | *115 | 6525 MHz |

1 channel is provided for 802.11ax (HE80):

| Channel | Frequency |
|---------|-----------|
| 103 | 6465 MHz |

1 channel is provided for 802.11ax (HE160):

| Channel | Frequency |
|---------|-----------|
| *111 | 6505 MHz |

U-NII-7:

17 channels are provided for 802.11a, 802.11ax (HE20):

| Channel | Frequency | Channel | Frequency | Channel | Frequency | Channel | Frequency |
|---------|-----------|---------|-----------|---------|-----------|---------|-----------|
| 117 | 6535 MHz | 121 | 6555 MHz | 125 | 6575 MHz | 129 | 6595 MHz |
| 133 | 6615 MHz | 137 | 6635 MHz | 141 | 6655 MHz | 145 | 6675 MHz |
| 149 | 6695 MHz | 153 | 6715 MHz | 157 | 6735 MHz | 161 | 6755 MHz |
| 165 | 6775 MHz | 169 | 6795 MHz | 173 | 6815 MHz | 177 | 6835 MHz |
| 181 | 6855 MHz | | | | | | |

8 channels are provided for 802.11ax (HE40):

| Channel | Frequency | Channel | Frequency | Channel | Frequency | Channel | Frequency |
|---------|-----------|---------|-----------|---------|-----------|---------|-----------|
| 123 | 6565 MHz | 131 | 6605 MHz | 139 | 6645 MHz | 147 | 6685 MHz |
| 155 | 6725 MHz | 163 | 6765 MHz | 171 | 6805 MHz | 179 | 6845 MHz |

5 channels are provided for 802.11ax (HE80):

| Channel | Frequency | Channel | Frequency | Channel | Frequency | Channel | Frequency |
|---------|-----------|---------|-----------|---------|-----------|---------|-----------|
| *119 | 6545 MHz | 135 | 6625 MHz | 151 | 6705 MHz | 167 | 6785 MHz |
| *183 | 6865 MHz | | | | | | |

2 channels are provided for 802.11ax (HE160):

| Channel | Frequency | Channel | Frequency |
|---------|-----------|---------|-----------|
| 143 | 6665 MHz | 175 | *6825 MHz |

U-NII-8:

13 channels are provided for 802.11a, 802.11ax (HE20):

| Channel | Frequency | Channel | Frequency | Channel | Frequency | Channel | Frequency |
|---------|-----------|---------|-----------|---------|-----------|---------|-----------|
| 185 | 6875 MHz | 189 | 6895 MHz | 193 | 6915 MHz | 197 | 6935 MHz |
| 201 | 6955 MHz | 205 | 6975 MHz | 209 | 6995 MHz | 213 | 7015 MHz |
| 217 | 7035 MHz | 221 | 7055 MHz | 225 | 7075 MHz | 229 | 7095 MHz |
| 233 | 7115 MHz | | | | | | |

6 channels are provided for 802.11ax (HE40):

| Channel | Frequency | Channel | Frequency | Channel | Frequency | Channel | Frequency |
|---------|-----------|---------|-----------|---------|-----------|---------|-----------|
| 187 | 6885 MHz | 195 | 6925 MHz | 203 | 6965 MHz | 211 | 7005 MHz |
| 219 | 7045 MHz | 227 | 7085 MHz | | | | |

2 channels are provided for 802.11ax (HE80):

| Channel | Frequency | Channel | Frequency |
|---------|-----------|---------|-----------|
| 199 | 6945 MHz | 215 | 7025 MHz |

1 channel is provided for 802.11ax (HE160):

| Channel | Frequency |
|---------|-----------|
| 207 | 6985 MHz |

Note: * mean these are straddle channels.

3.4 Test Mode Applicability and Tested Channel Detail

| | |
|-------------|---|
| Pre-Scan: | EUT can be used in the following ways: XYZ 3-axis. Pre-scan in these ways and find the worst case as a representative test condition. |
| Worst Case: | X / Y / Z Worst Condition: Y Axis. |

Following channel(s) was (were) selected for the final test as listed below:

| Test Item | EUT Configure Mode | Mode | Tested Channel | Modulation | Data Rate Parameter |
|--|--|-------------------------------------|--|---------------|---------------------|
| RF Output Power / Power Spectral Density / Emission Bandwidth / In-Band Emission Mask / Occupied Bandwidth | B | 802.11a | 1, 45, 93, 97, 105, 113, 117, 149, 181, 185, 209, 233 | BPSK | 6Mb/s |
| | | 802.11ax (HE20) | 1, 45, 93, 97, 105, 113, 117, 149, 181, 185, 209, 233 | BPSK | MCS0 |
| | | 802.11ax (HE40) | 3, 43, 91, 99, 107, 115, 123, 155, 179, 187, 211, 227 | BPSK | MCS0 |
| | | 802.11ax (HE80) | 7, 39, 87, 103, 119, 151, 183, 199, 215 | BPSK | MCS0 |
| | | 802.11ax (HE160) | 15, 47, 79, 111, 143, 175, 207 | BPSK | MCS0 |
| | | 20 MHz Preamble 802.11ax (RU26) | 1 (26/0), 93 (26/8), 97 (26/0), 117 (26/0), 181 (26/8), 233 (26/8) | BPSK | MCS0 |
| | | 20 MHz Preamble 802.11ax (RU52) | 1 (52/37), 93 (52/40), 97 (52/37), 117 (52/37), 181 (52/40), 233 (52/40) | BPSK | MCS0 |
| | | 20 MHz Preamble 802.11ax (RU106) | 1 (106/53), 93 (106/54), 97 (106/53), 117 (106/53), 181 (106/54), 233 (106/53) | BPSK | MCS0 |
| | | 40 MHz Preamble 802.11ax (RU242) | 3 (242/61), 91 (242/62), 99 (242/61), 115 (242/62), 123 (242/61), 179 (242/62), 187 (242/61), 227 (242/62) | BPSK | MCS0 |
| | | 80 MHz Preamble 802.11ax (RU484) | 7 (484/65), 87 (484/66), 103 (484/65), 119 (484/66), 151 (484/66), 183 (484/65), 199 (484/65), 215 (484/66) | BPSK | MCS0 |
| 160 MHz Preamble 802.11ax (RU996) | 15 (996/67), 79 (996/67), 111 (996/67), 143 (996/67), 175 (996/67), 207 (996/67) | BPSK | MCS0 | | |
| Frequency Stability | B | 802.11a | 1 | un-modulation | - |
| Contention-based Protocol | B | 802.11ax (HE20) | 45, 105, 149, 209 | BPSK | MCS0 |
| | | 802.11ax (HE160) | 47, 111, 143, 207 | BPSK | MCS0 |
| AC Power Conducted Emissions | A, B, C | 802.11ax (HE80) | 103 | BPSK | MCS0 |
| Unwanted Emissions below 1 GHz | A, B, C | 802.11ax (HE80) | 103 | BPSK | MCS0 |

| Test Item | EUT Configure Mode | Mode | Tested Channel | Modulation | Data Rate Parameter |
|--------------------------------|--------------------|----------------------------------|--|------------|---------------------|
| Unwanted Emissions above 1 GHz | B | 802.11a | 1, 45, 93, 97, 105, 113, 117, 149, 181, 185, 209, 233 | BPSK | 6Mb/s |
| | | 802.11ax (HE20) | 1, 45, 93, 97, 105, 113, 117, 149, 181, 185, 209, 233 | BPSK | MCS0 |
| | | 802.11ax (HE40) | 3, 43, 91, 99, 107, 115, 123, 155, 179, 187, 211, 227 | BPSK | MCS0 |
| | | 802.11ax (HE80) | 7, 39, 87, 103, 119, 151, 183, 199, 215 | BPSK | MCS0 |
| | | 802.11ax (HE160) | 15, 47, 79, 111, 143, 175, 207 | BPSK | MCS0 |
| | | 20 MHz Preamble 802.11ax (RU26) | 1 (26/0), 93 (26/8), 97 (26/0), 117 (26/0), 181 (26/8), 233 (26/8) | BPSK | MCS0 |
| | | 20 MHz Preamble 802.11ax (RU52) | 1 (52/37), 93 (52/40), 97 (52/37), 117 (52/37), 181 (52/40), 233 (52/40) | BPSK | MCS0 |
| | | 20 MHz Preamble 802.11ax (RU106) | 1 (106/53), 93 (106/54), 97 (106/53), 117 (106/53), 181 (106/54), 233 (106/53) | BPSK | MCS0 |
| EUT Configure Mode: | A | EUT + Adapter 1 | | | |
| | B | EUT + Wall Dock + Adapter 2 | | | |
| | C | EUT + Table Dock + Adapter 2 | | | |

3.5 Duty Cycle of Test Signal

802.11a: Duty cycle = 2.022 ms / 2.03 ms x 100% = 99.6%

802.11ax (HE20): Duty cycle = 5.456 ms / 5.485 ms x 100% = 99.5%

802.11ax (HE40): Duty cycle = 5.456 ms / 5.471 ms x 100% = 99.7%

802.11ax (HE80): Duty cycle = 5.446 ms / 5.472 ms x 100% = 99.5%

802.11ax (HE160): Duty cycle = 5.456 ms / 5.478 ms x 100% = 99.6%

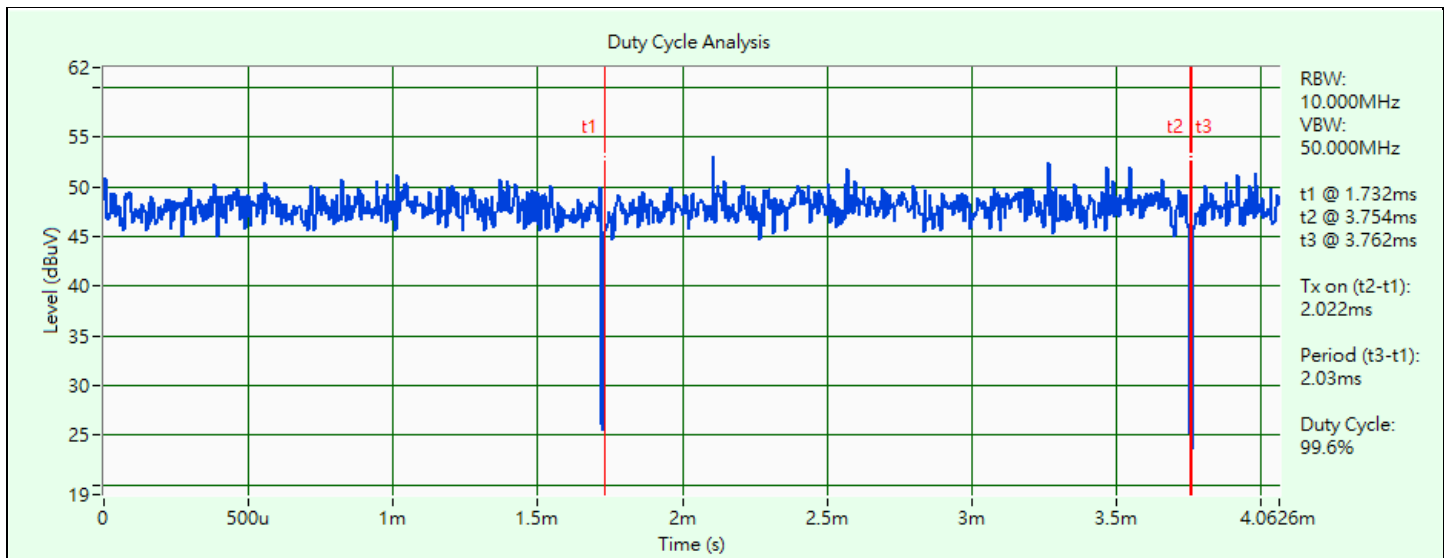

802.11a

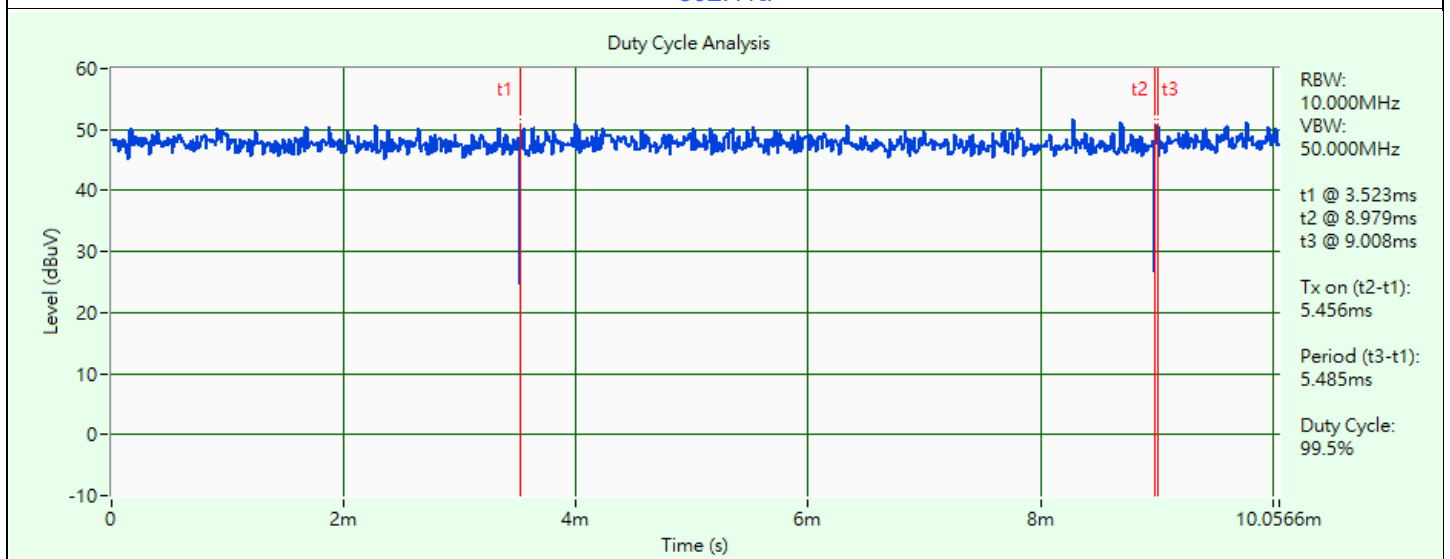

802.11ax (HE20)

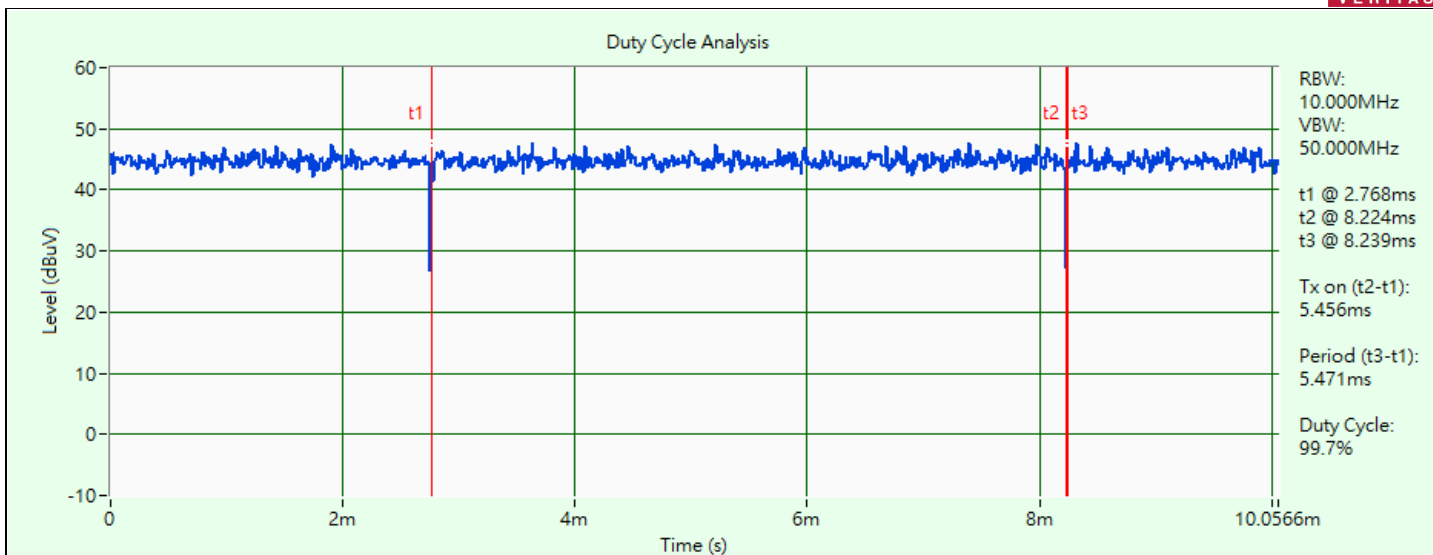

802.11ax (HE40)

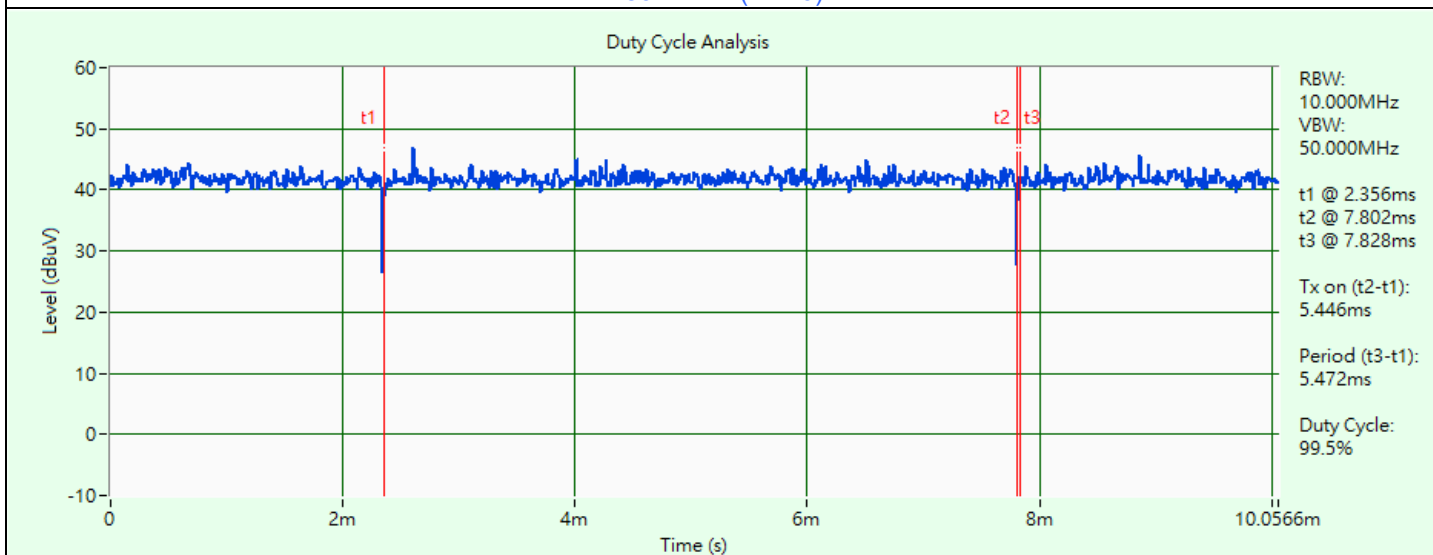

802.11ax (HE80)

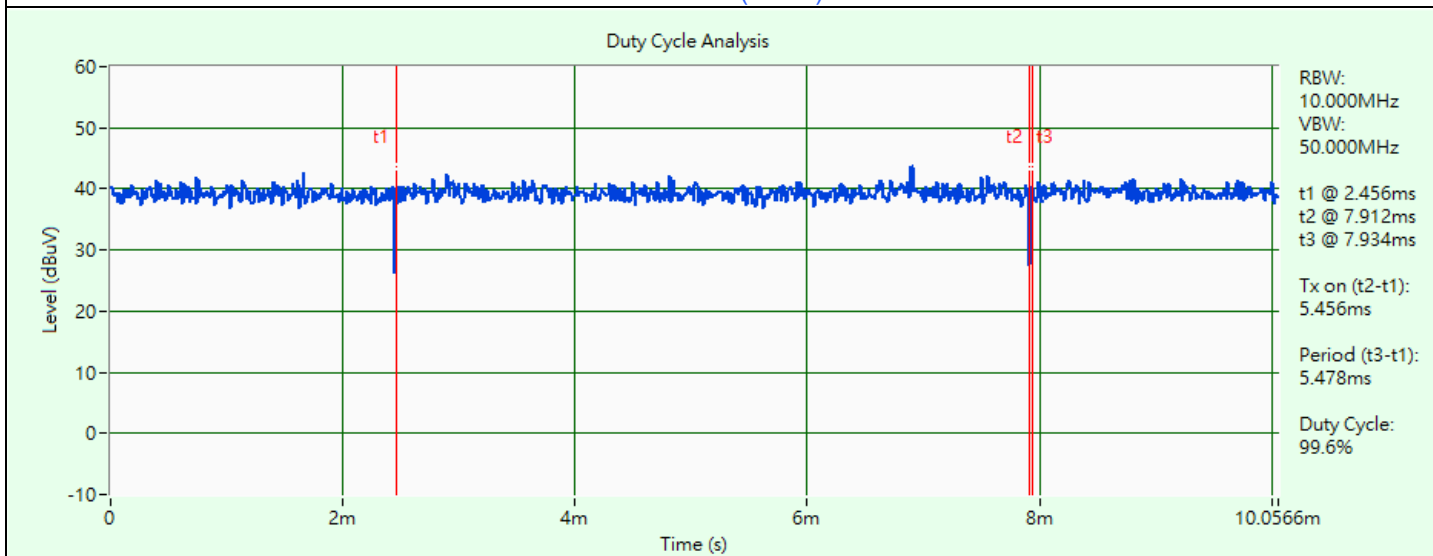

802.11ax (HE160)

3.6 Test Program Used and Operation Descriptions

Controlling software QRCT4.0.00177.0 has been activated to set the EUT under transmission condition continuously at specific channel frequency.

3.7 Connection Diagram of EUT and Peripheral Devices

Test Mode A

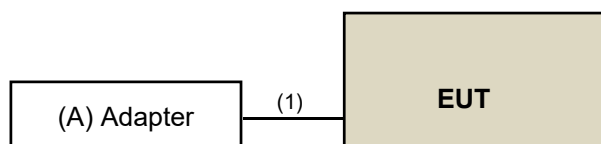

Test Mode B

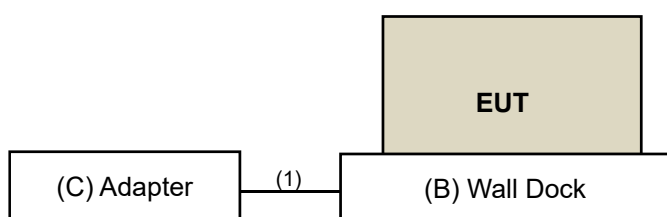

Test Mode C

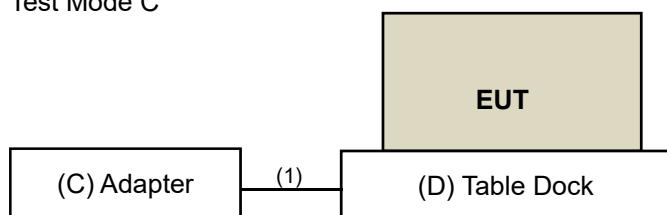

3.8 Configuration of Peripheral Devices and Cable Connections

| ID | Product | Brand | Model No. | Serial No. | FCC ID | Remarks |
|----|------------|-----------|----------------|--------------|--------|-----------------------|
| A | Adapter | Gigastone | PD-7650W | 1622 | N/A | Supplied by applicant |
| B | Wall Dock | CRESTRON | TST-1080-DSW | 2302CRX04649 | N/A | Supplied by applicant |
| C | Adapter | CRESTRON | NBS30G240125D5 | PW-2412WU | N/A | Supplied by applicant |
| D | Table Dock | CRESTRON | TST-1080-DS | 2304JBH05893 | N/A | Supplied by applicant |

| ID | Cable Descriptions | Qty. | Length (m) | Shielding (Yes/No) | Cores (Qty.) | Remarks |
|----|--------------------|------|------------|--------------------|--------------|-----------------------|
| 1 | USB Cable | 1 | 1 | No | No | Supplied by applicant |

4 Test Instruments

The calibration interval of the all test instruments are 12 months and the calibrations are traceable to NML/ROC and NIST/USA.

4.1 RF Output Power

| Description Manufacturer | Model No. | Serial No. | Calibrated Date | Calibrated Until |
|--|-----------|---|--------------------|---------------------|
| USB Wideband Power Sensor KEYSIGHT | U2021XA | MY55050005/MY55190004/MY55190007/MY55210005 | 2022/7/13 | 2023/7/12 |

Notes:

1. The test was performed in Oven room.
2. Tested Date: 2023/4/19 ~ 2023/5/11

4.2 Power Spectral Density

| Description Manufacturer | Model No. | Serial No. | Calibrated Date | Calibrated Until |
|-------------------------------------|----------------------------------|------------|--------------------|---------------------|
| Signal and spectrum analyzer R&S | FSV3044 | 101105 | 2023/2/22 | 2024/2/21 |
| Software BV | ADT_RF Test Software V6.6.5.4 | N/A | N/A | N/A |

Notes:

1. The test was performed in Oven room.
2. Tested Date: 2023/4/19 ~ 2023/5/11

4.3 Emission Bandwidth

Refer to section 4.2 to get information of the instruments.

4.4 In-Band Emission Mask

Refer to section 4.2 to get information of the instruments.

4.5 Occupied Bandwidth

Refer to section 4.2 to get information of the instruments.

4.6 Frequency Stability

| Description Manufacturer | Model No. | Serial No. | Calibrated Date | Calibrated Until |
|--|----------------------------------|------------|--------------------|---------------------|
| AC power supply JIN YIH Technology | 6905S | 1720444 | N/A | N/A |
| Digital Multimeter Fluke | 87-III | 70360742 | 2022/6/23 | 2023/6/22 |
| Signal and spectrum analyzer R&S | FSV3044 | 101105 | 2023/2/22 | 2024/2/21 |
| Software BV | ADT_RF Test Software V6.6.5.4 | N/A | N/A | N/A |
| Temperature & Humidity Chamber TERCHY | HRM-120RF | 931022 | 2022/12/27 | 2023/12/26 |

Notes:

1. The test was performed in Oven room.
2. Tested Date: 2023/4/19 ~ 2023/5/11

4.7 Contention-based Protocol

| Description Manufacturer | Model No. | Serial No. | Calibrated Date | Calibrated Until |
|---|-----------|------------|--------------------|---------------------|
| Combiner / Splitter (Model:ZN2PD-9G) Mini-Circuits | ZN2PD-9G | ZN2PD-9G | 2022/6/9 | 2023/6/8 |
| MXG Vector signal generator KEYSIGHT | N5182B | MY53052282 | 2023/1/6 | 2024/1/5 |
| N9030B - PXA Signal Analyzer KEYSIGHT | N9030B | MY57140488 | 2023/3/6 | 2024/3/5 |
| PXA KEYSIGHT | N9030B | MY57140953 | 2022/7/1 | 2023/6/30 |
| Signal Analyzer R&S | FSV7 | 104056 | 2022/5/20 | 2023/5/19 |

Notes:

1. The test was performed in Adaptivity room.
2. Tested Date: 2023/4/1

4.8 AC Power Conducted Emissions

| Description Manufacturer | Model No. | Serial No. | Calibrated Date | Calibrated Until |
|--------------------------------|-------------------------|----------------|--------------------|---------------------|
| LISN R&S | ESH3-Z5 | 100311 | 2022/9/12 | 2023/9/11 |
| LISN ROHDE & SCHWARZ | ENV216 | 101826 | 2023/3/23 | 2024/3/22 |
| RF Coaxial Cable WOKEN | 5D-FB | Cable-cond1-01 | 2023/1/7 | 2024/1/6 |
| Software BVADT | BVADT_Cond_ V7.3.7.4 | N/A | N/A | N/A |
| Test Receiver Rohde&Schwarz | ESCI | 100613 | 2022/12/5 | 2023/12/4 |
| V-LISN Schwarzbeck | NNBL 8226-2 | 8226-142 | 2022/8/31 | 2023/8/30 |

Notes:

1. The test was performed in HY - Conduction 1.
2. Tested Date: 2023/5/19

4.9 Unwanted Emissions below 1 GHz

| Description Manufacturer | Model No. | Serial No. | Calibrated Date | Calibrated Until |
|--------------------------------------|--------------------------|--|--------------------|---------------------|
| Antenna Tower Max-Full | UNAT_5+ | PAD-CH6-01 | N/A | N/A |
| Antenna Tower Controller Max-Full | MF-7802 | N/A | N/A | N/A |
| Bi_Log Antenna Schwarzbeck | VULB9168 | 9168-616 | 2022/10/26 | 2023/10/25 |
| Loop Antenna EMCI | EM-6879 | 269 | 2022/9/19 | 2023/9/18 |
| Loop Antenna TESEQ | HLA 6121 | 45745 | 2022/7/27 | 2023/7/26 |
| Pre-amplifier EMCI | EMC001340 | 980201 | 2022/9/23 | 2023/9/22 |
| Preamplifier Agilent | 310N | 187226 | 2022/6/14 | 2023/6/13 |
| RF Coaxial Cable EMCI | 5D-NM-BM | 140903+140902 | 2023/1/7 | 2024/1/6 |
| RF Coaxial Cable ETS-Lindgren | EMC104-SM-SM-10000 | Cable-CH1-01(RFC-SMS-100-SMS-120+RFC-SMS-100-SMS-4 | 2022/6/14 | 2023/6/13 |
| | RFC-SMS-100-SMS-24-IN | Cable-CH1-02(RFC-SMS-100-SMS-24) | 2022/6/14 | 2023/6/13 |
| Software BV ADT | ADT_Radiated_V7.6.15.9.5 | N/A | N/A | N/A |
| Test Receiver Agilent | N9038A | MY52260177 | 2022/9/19 | 2023/9/18 |
| Turn Table Max-Full | TT-1510 | N/A | N/A | N/A |
| Turn Table Controller Max-Full | MF-7802 | N/A | N/A | N/A |

Notes:

1. The test was performed in XD - 966 chamber 6.
2. Tested Date: 2023/4/26 ~ 2023/5/5

4.10 Unwanted Emissions above 1 GHz

| Description Manufacturer | Model No. | Serial No. | Calibrated Date | Calibrated Until |
|---------------------------------------|-----------------------------------|---|--------------------|---------------------|
| Antenna Tower Max-Full | UNAT_5+ | PAD-CH6-01 | N/A | N/A |
| Antenna Tower Controller Max-Full | MF-7802 | N/A | N/A | N/A |
| Boresight antenna tower fixture BV | BAF-02 | 8 | N/A | N/A |
| Horn Antenna ETS-Lindgren | 3117 | 00143293 | 2022/11/13 | 2023/11/12 |
| Horn Antenna Schwarzbeck | BBHA 9170 | BBHA9170241 | 2022/10/20 | 2023/10/19 |
| Pre-Amplifier EMCI | EMC 184045 | 980116 | 2022/10/1 | 2023/9/30 |
| Preamplifier Agilent | 83017A | MY39501373 | 2022/6/14 | 2023/6/13 |
| RF Coaxial Cable ETS-Lindgren | EMC104-SM-SM-10000 | Cable-CH1-01(RFC-SMS-100-SMS-120+RFC-SMS-100-SMS-4) | 2022/6/14 | 2023/6/13 |
| | RFC-SMS-100-SMS-24-IN | Cable-CH1-02(RFC-SMS-100-SMS-24) | 2022/6/14 | 2023/6/13 |
| RF Coaxial Cable HUBER+SUHNER | SUCOFLEX 104 | CABLE-CH9-(250795/4) | 2023/1/7 | 2024/1/6 |
| RF Coaxial Cable HUBER+SUHNER&EMCI | SUCOFLEX 104& EMC104-SM-SM8000 | CABLE-CH9-02 (248780+171006) | 2023/1/7 | 2024/1/6 |
| Software BV ADT | ADT_Radiated_ V7.6.15.9.5 | N/A | N/A | N/A |
| Test Receiver Agilent | N9038A | MY52260177 | 2022/9/19 | 2023/9/18 |
| Turn Table Max-Full | TT-1510 | N/A | N/A | N/A |
| Turn Table Controller Max-Full | MF-7802 | N/A | N/A | N/A |

Notes:

1. The test was performed in XD - 966 chamber 6.
2. Tested Date: 2023/4/25 ~ 2023/5/5

5 Limits of Test Items

5.1 RF Output Power

| Operation Band | EUT Category | Limit |
|--|--|-------------------|
| | | Max Average Power |
| U-NII-5 U-NII-6 U-NII-7 U-NII-8 | Client Devices (controlled of an indoor AP) | EIRP 24 dBm |

Per KDB 662911 Method of conducted output power measurement on IEEE 802.11 devices,

Array Gain = 0 dB (i.e., no array gain) for $N_{ANT} \leq 4$;

Array Gain = 0 dB (i.e., no array gain) for channel widths ≥ 40 MHz for any N_{ANT} ;

Array Gain = $5 \log(N_{ANT}/N_{SS})$ dB or 3 dB, whichever is less for 20-MHz channel widths with $N_{ANT} \geq 5$.

For power measurements on all other devices: Array Gain = $10 \log(N_{ANT}/N_{SS})$ dB.

5.2 Power Spectral Density

| Operation Band | EUT Category | Limit |
|--|--|--------------------|
| | | Peak Power Density |
| U-NII-5 U-NII-6 U-NII-7 U-NII-8 | Client Devices (controlled of an indoor AP) | EIRP -1 dBm/MHz |

5.3 Emission Bandwidth

The maximum transmitter channel bandwidth for U-NII devices in the 5.925-7.125 GHz band is 320 MHz.

5.4 In-Band Emission Mask

| Test Item | Frequencies (MHz) | (X) dBc* ¹ |
|---------------|---|-----------------------|
| Emission Mask | At 1 MHz outside of channel edge | 20 |
| | At one channel bandwidth from the channel center* ² | 28 |
| | At one- and one-half times the channel bandwidth away from channel center* ³ | 40 |
| | More than one- and one-half times the channel bandwidth | 40 |

*¹ : The power spectral density must be suppressed by "x" dB

*² : At frequencies between one megahertz outside an unlicensed device's channel edge and one channel bandwidth from the center of the channel, the limits must be linearly interpolated between 20 dB and 28 dB suppression,

*³ : At frequencies between one and one- and one-half times an unlicensed device's channel bandwidth, the limits must be linearly interpolated between 28 dB and 40 dB suppression.

5.5 Occupied Bandwidth

The results are for reference only.

5.6 Frequency Stability

The frequency of the carrier signal shall be maintained within band of operation.

5.7 Contention-based Protocol

Unlicensed indoor low-power devices must detect co-channel radio frequency power that is at least -62 dBm (The threshold is referenced to a 0 dBi antenna gain.) or lower. Additionally, indoor low-power devices must detect co-channel energy with 90% or greater certainty.

5.8 AC Power Conducted Emissions

| Frequency (MHz) | Conducted Limit (dBuV) | |
|-----------------|------------------------|---------|
| | Quasi-peak | Average |
| 0.15 - 0.5 | 66 - 56 | 56 - 46 |
| 0.50 - 5.0 | 56 | 46 |
| 5.0 - 30.0 | 60 | 50 |

Notes:

1. The lower limit shall apply at the transition frequencies.
2. The limit decreases in line with the logarithm of the frequency in the range of 0.15 to 0.50 MHz.

5.9 Unwanted Emissions below 1 GHz

Radiated emissions which fall in the restricted bands must comply with the radiated emission limits specified as below table.

| Frequencies (MHz) | Field Strength (microvolts/meter) | Measurement Distance (meters) |
|-------------------|-----------------------------------|-------------------------------|
| 0.009 ~ 0.490 | 2400/F(kHz) | 300 |
| 0.490 ~ 1.705 | 24000/F(kHz) | 30 |
| 1.705 ~ 30.0 | 30 | 30 |
| 30 ~ 88 | 100 | 3 |
| 88 ~ 216 | 150 | 3 |
| 216 ~ 960 | 200 | 3 |
| Above 960 | 500 | 3 |

Notes:

1. The lower limit shall apply at the transition frequencies.
2. Emission level (dBuV/m) = 20 log Emission level (uV/m).

5.10 Unwanted Emissions above 1 GHz

Radiated emissions which fall in the restricted bands must comply with the radiated emission limits specified as below table.

| Frequencies (MHz) | Field Strength (microvolts/meter) | Measurement Distance (meters) |
|-------------------|-----------------------------------|-------------------------------|
| Above 960 | 500 | 3 |

Notes:

1. The lower limit shall apply at the transition frequencies.
2. Emission level (dBuV/m) = 20 log Emission level (uV/m).
3. For frequencies above 1000 MHz, the field strength limits are based on average detector, however, the peak field strength of any emission shall not exceed the maximum permitted average limits, specified above by more than 20 dB under any condition of modulation.

Limits of unwanted emission out of the restricted bands

| Frequencies (MHz) | EIRP Limit | Equivalent Field Strength at 3 m |
|-------------------------|------------------------|----------------------------------|
| 5925 MHz > F > 7125 MHz | Peak: -7 (dBm/MHz) | 88.2 (dBuV/m) |
| | Average: -27 (dBm/MHz) | 68.2 (dBuV/m) |

Note: The following formula is used to convert the equipment isotropic radiated power (eirp) to field strength:

$$E = \frac{1000000 \sqrt{30P}}{3} \mu\text{V/m, where P is the eirp (Watts).$$

6 Test Arrangements

6.1 RF Output Power

6.1.1 Test Setup

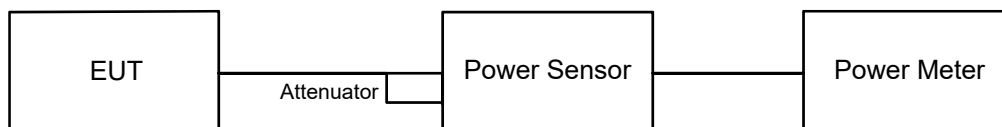

6.1.2 Test Procedure

Method PM is used to perform output power measurement, trigger and gating function of wide band power meter is enabled to measure max output power of TX on burst and set the detector to average. Duty factor is not added to measured value.

6.2 Power Spectral Density

6.2.1 Test Setup

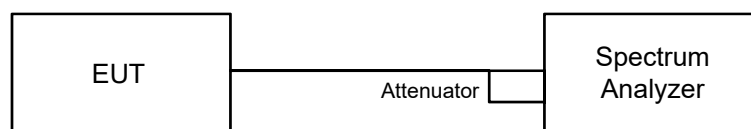

6.2.2 Test Procedure

For specified measurement bandwidth 1 MHz:

Method SA-1

- a. Set span to encompass the entire emission bandwidth (EBW) of the signal.
- b. Set RBW = 1 MHz, Set VBW \geq 3 MHz, Detector = RMS
- c. Sweep points \geq $[2 \times \text{span} / \text{RBW}]$. (This gives bin-to-bin spacing \leq RBW / 2, so that narrowband signals are not lost between frequency bins.)
- d. Sweep time = auto, trigger set to "free run".
- e. Trace average at least 100 traces in power averaging mode.
- f. Record the max value

6.3 Emission Bandwidth

6.3.1 Test Setup

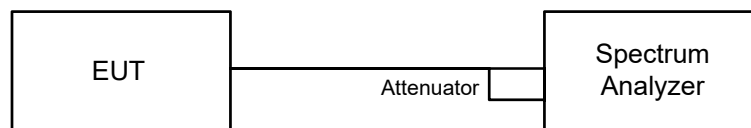

6.3.2 Test Procedure

- Set RBW = approximately 1% of the emission bandwidth.
- Set the VBW > RBW.
- Detector = Peak.
- Trace mode = max hold.
- Measure the maximum width of the emission that is 26 dB down from the peak of the emission. Compare this with the RBW setting of the analyzer. Readjust RBW and repeat measurement as needed until the RBW/EBW ratio is approximately 1%.

6.4 In-Band Emission Mask

6.4.1 Test Setup

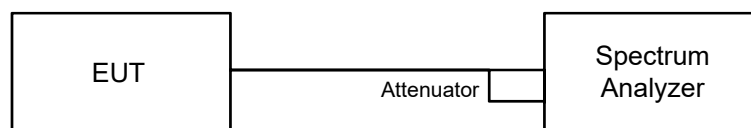

6.4.2 Test Procedure

- Connect output of the antenna port to a spectrum analyzer and adjust appropriate attenuation.
- Measure the 26 dB EBW using the test procedure 12.4.1 of ANSI C63.10-2013. (Determine the channel edge.)
- Measure the power spectral density (for emissions mask reference) using the following procedure:
 - Set the span to encompass the entire 26 dB EBW of the signal.
 - Set RBW = same RBW used for 26 dB EBW measurement.
 - Set VBW $\geq [3 \times \text{RBW}]$.
 - Number of points in sweep $\geq [2 \times \text{span} / \text{RBW}]$.
 - Sweep time = auto.
 - Detector = RMS (i.e., power averaging).
 - Trace average at least 100 traces in power averaging (rms) mode.
 - Use the peak search function on the instrument to find the peak of the spectrum.
- Using the measuring equipment limit line function, develop the emissions mask based on the following requirements. The emissions power spectral density must be reduced below the peak power spectral density (in dB) as follows:
 - Suppressed by 20 dB at 1 MHz outside of the channel edge. (The channel edge is defined as the 26-dB point on either side of the carrier center frequency.)
 - Suppressed by 28 dB at one channel bandwidth from the channel center.
 - Suppressed by 40 dB at one- and one-half times the channel bandwidth from the channel center.
- Adjust the span to encompass the entire mask as necessary and clear trace.
- Trace average at least 100 traces in power averaging (rms) mode.
- Adjust the reference level as necessary so that the crest of the channel touches the top of the emission mask

6.5 Occupied Bandwidth

6.5.1 Test Setup

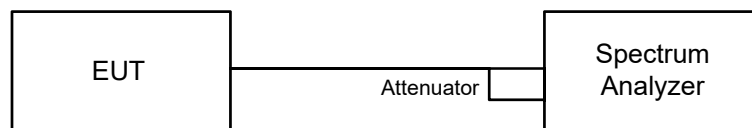

6.5.2 Test Procedure

The transmitter output was connected to the spectrum analyzer through an attenuator. The bandwidth of the fundamental frequency was measured by spectrum analyzer with resolution bandwidth in the range of 1% to 5% of the anticipated emission bandwidth, and a video bandwidth at least 3x the resolution bandwidth and set the detector to Sampling. The width of a frequency band such that, below the lower and above the upper frequency limits, the mean powers emitted are each equal to a specified percentage 0.5% of the total mean power of a given emission.

6.6 Frequency Stability

6.6.1 Test Setup

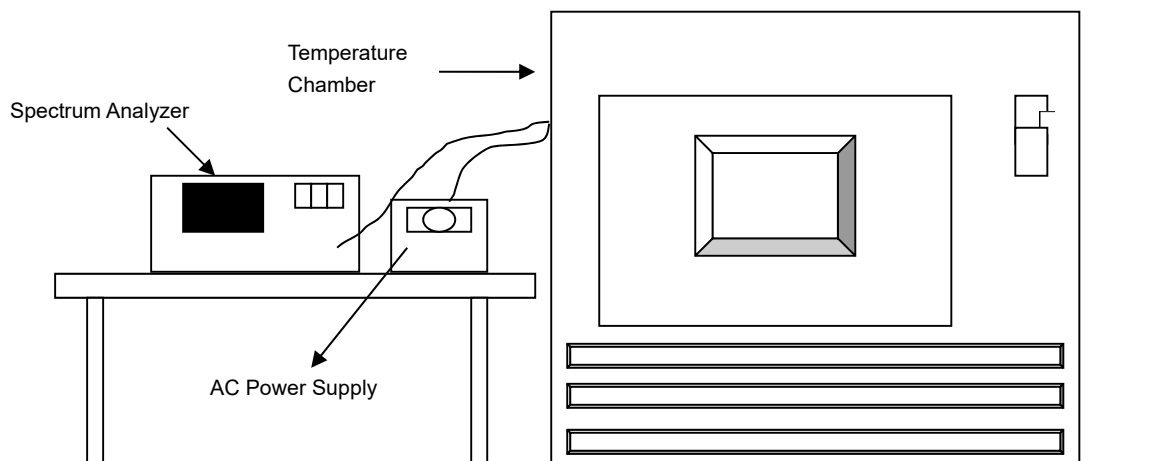

6.6.2 Test Procedure

- The EUT was placed inside the environmental test chamber and powered by nominal AC voltage.
- Turn the EUT on and couple its output to a spectrum analyzer.
- Turn the EUT off and set the chamber to the highest temperature specified.
- Allow sufficient time (approximately 30 min) for the temperature of the chamber to stabilize, turn the EUT on and measure the operating frequency after 2, 5, and 10 Minutes.
- Repeat step (d) with the temperature chamber set to the next desired temperature until measurements down to the lowest specified temperature have been completed.
- The test chamber was allowed to stabilize at +20 degree C for a minimum of 30 Minutes. The supply voltage was then adjusted on the EUT from 85% to 115% and the frequency record.

6.7 Contention-based Protocol

6.7.1 Test Setup

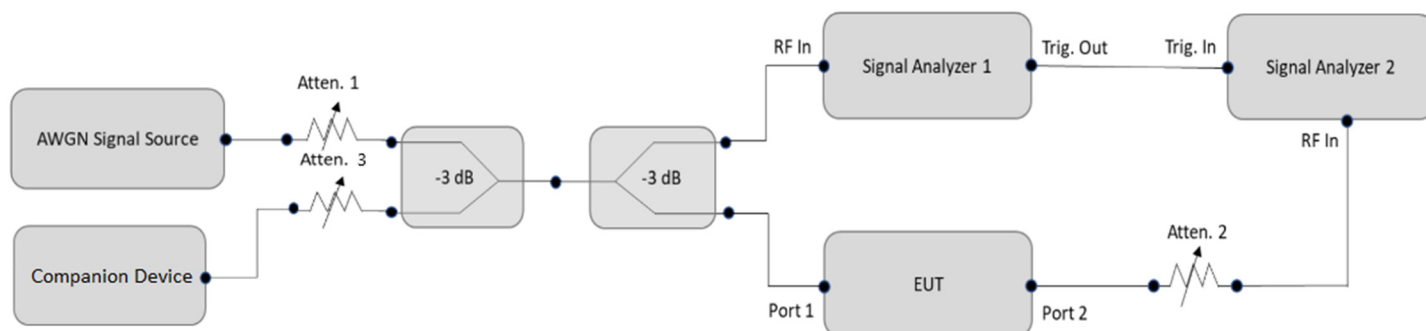

6.7.2 Test Procedure

- Set the signal analyzer center frequency to the nominal EUT channel center frequency. The span range of the signal analyzer shall be between two times and five times the OBW of the EUT. Connect the output port of the EUT to the signal analyzer 2. Ensure that the attenuator 2 provides enough attenuation to not overload the signal analyzer 2 receiver.
- Monitoring the signal analyzer 2, verify the EUT is operating and transmitting with the parameters (set as following section 4.7.5 EUT operating condition).
- Determine number of times detection threshold test as following table,

| If | Number of Tests | Placement of Incumbent Transmission |
|---|--|--|
| $BW_{EUT} \leq BW_{Inc}$ | Once | Same as EUT transmission |
| $BW_{Inc} < BW_{EUT} \leq 2x BW_{Inc}$ | Once | Contained within BW_{EUT} |
| $2x BW_{Inc} < BW_{EUT} \leq 4x BW_{Inc}$ | Twice. (Incumbent transmission is contained within BW_{EUT}) | Closely to the lower edge and upper edge of the EUT Channel |
| $BW_{EUT} > 4x BW_{Inc}$ | Three times | Closely to the lower edge, in the middle and upper edge of the EUT Channel |

- Using an AWGN signal source, generate (but do not transmit, i.e., RF OFF) a 10 MHz-wide AWGN signal. Use step c table to determine the center frequency of the 10 MHz AWGN signal relative to the EUT's channel bandwidth and center frequency.
- Set the AWGN signal power to an extremely low level (more than 20 dB below the -62 dBm threshold). Connect the AWGN signal source, via a 3-dB splitter, to the signal analyzer 1 and the EUT.
- Transmit the AWGN signal (RF ON) and verify its characteristics on the signal analyzer 1.
- Monitor the signal analyzer 2 to verify if the AWGN signal has been detected and the EUT has ceased transmission. If the EUT continues to transmit, then incrementally increase the AWGN signal power level until the EUT stops transmitting.
- (Including all losses in the RF paths) Determine and record the AWGN signal power level (at the EUT's antenna port) at which the EUT ceased transmission. Repeat the procedure at least 10 times to verify the EUT can detect an AWGN signal with 90% (or better) level of certainty.
- Refer to step c table to determine number of times the detection threshold testing needs to be repeated. If testing is required more than once, then go back to step d, choose a different center frequency for the AWGN signal and repeat the process.

6.8 AC Power Conducted Emissions

6.8.1 Test Setup

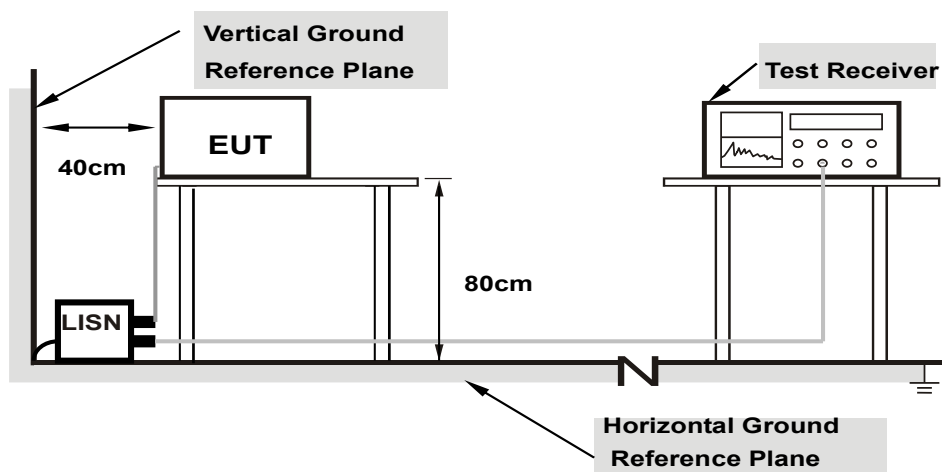

Note: 1.Support units were connected to second LISN.

For the actual test configuration, please refer to the attached file (Test Setup Photo).

6.8.2 Test Procedure

- The EUT was placed on a 0.8 meter to the top of table and placed 0.4 meters from the conducting wall of the shielded room with EUT being connected to the power mains through a line impedance stabilization network (LISN). Other support units were connected to the power mains through another LISN. The two LISNs provide 50 ohm/ 50 uH of coupling impedance for the measuring instrument.
- Both lines of the power mains connected to the EUT were checked for maximum conducted interference.
- The frequency range from 150 kHz to 30 MHz was searched. Emission levels under (Limit – 20 dB) was not recorded.

Note: The resolution bandwidth and video bandwidth of test receiver is 9 kHz for quasi-peak detection (QP) and average detection (AV) at frequency 0.15 MHz-30 MHz.

6.9 Unwanted Emissions below 1 GHz

6.9.1 Test Setup

For Radiated emission below 30 MHz

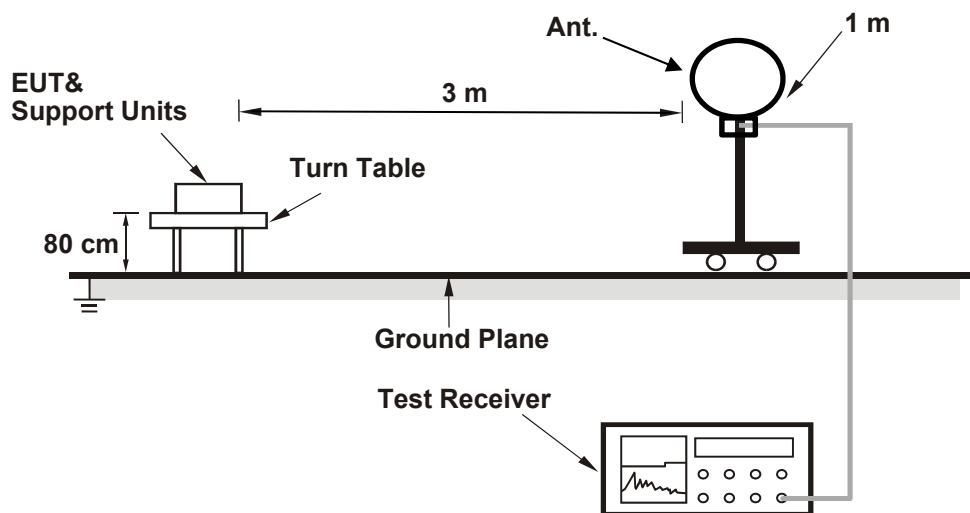

For Radiated emission above 30 MHz

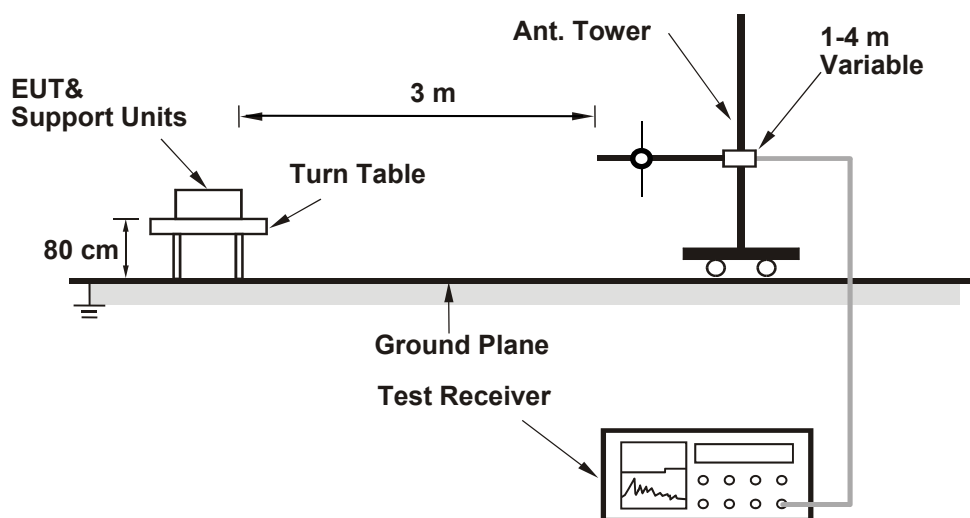

For the actual test configuration, please refer to the attached file (Test Setup Photo).

6.9.2 Test Procedure

For Radiated emission below 30 MHz

- a. The EUT was placed on the top of a rotating table 0.8 meters above the ground at 3 meter chamber room for test. The table was rotated 360 degrees to determine the position of the highest radiation.
- b. The EUT was set 3 meters away from the interference-receiving antenna, which was mounted on the top of a variable-height antenna tower.
- c. Parallel, perpendicular, and ground-parallel orientations of the antenna are set to make the measurement.
- d. For each suspected emission, the EUT was arranged to its worst case and the rotatable table was turned from 0 degrees to 360 degrees to find the maximum reading.
- e. The test-receiver system was set to Quasi-Peak Detect Function and Specified Bandwidth with Maximum Hold Mode, except for the frequency band (9 kHz to 90 kHz and 110 kHz to 490 kHz) set to average detect function and peak detect function.

Notes:

1. The resolution bandwidth and video bandwidth of test receiver/spectrum analyzer is 200 Hz at frequency below 150 kHz.
2. The resolution bandwidth and video bandwidth of test receiver/spectrum analyzer is 9 kHz or 10 kHz at frequency (150 kHz to 30 MHz).
3. All modes of operation were investigated and the worst-case emissions are reported.

For Radiated emission above 30 MHz

- a. The EUT was placed on the top of a rotating table 0.8 meters above the ground at 3 meter chamber room for test. The table was rotated 360 degrees to determine the position of the highest radiation.
- b. The EUT was set 3 meters away from the interference-receiving antenna, which was mounted on the top of a variable-height antenna tower.
- c. The height of antenna is varied from one meter to four meters above the ground to determine the maximum value of the field strength. Both horizontal and vertical polarizations of the antenna are set to make the measurement.
- d. For each suspected emission, the EUT was arranged to its worst case and then the antenna was tuned to heights from 1 meter to 4 meters and the rotatable table was turned from 0 degrees to 360 degrees to find the maximum reading.
- e. The test-receiver system was set to Quasi-peak(QP) detect function, Average(AV) detect function, Peak(PK) detect function and specified bandwidth with maximum hold mode when the test frequency is below 1 GHz.

Notes:

1. The resolution bandwidth and video bandwidth of test receiver/spectrum analyzer is 120 kHz for Quasi-peak detection (QP), Average detection (AV), Peak detection (PK) at frequency (30MHz to 1 GHz).
2. All modes of operation were investigated and the worst-case emissions are reported.

6.10 Unwanted Emissions above 1 GHz

6.10.1 Test Setup

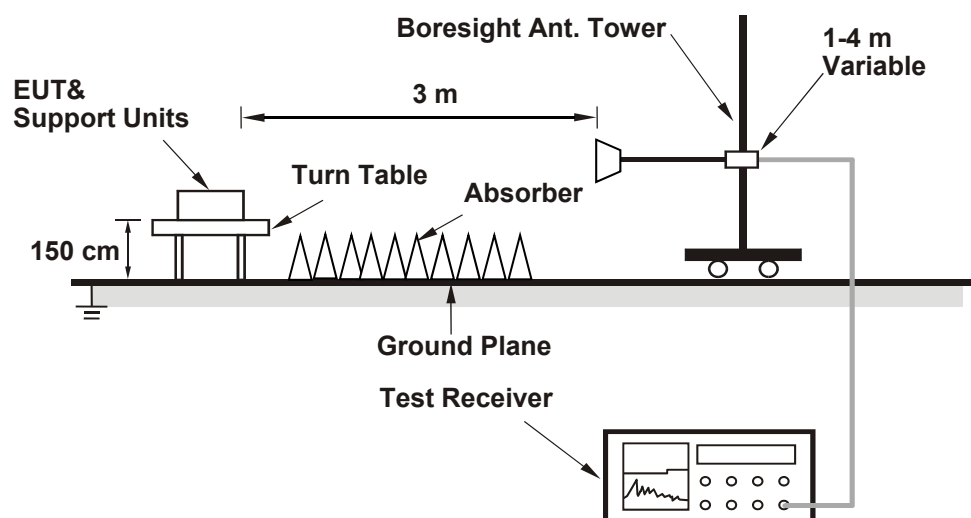

For the actual test configuration, please refer to the attached file (Test Setup Photo).

6.10.2 Test Procedure

- The EUT was placed on the top of a rotating table 1.5 meters above the ground at 3 meter chamber room for test. The table was rotated 360 degrees to determine the position of the highest radiation.
- The EUT was set 3 meters away from the interference-receiving antenna, which was mounted on the top of a variable-height antenna tower.
- The height of antenna is varied from one meter to four meters above the ground to determine the maximum value of the field strength. Both horizontal and vertical polarizations of the antenna are set to make the measurement.
- For each suspected emission, the EUT was arranged to its worst case and then the antenna was tuned to heights from 1 meter to 4 meters and the rotatable table was turned from 0 degrees to 360 degrees to find the maximum reading.
- The test-receiver system was set to peak and average detects function and specified bandwidth with maximum hold mode when the test frequency is above 1 GHz. If the peak reading value also meets average limit, measurement with the average detector is unnecessary.

Notes:

- The resolution bandwidth of test receiver/spectrum analyzer is 1 MHz and the video bandwidth is 3 MHz for Peak detection (PK) and Average detection (AV) at frequency above 1 GHz.
- For fundamental and harmonic signal measurement, the resolution bandwidth of test receiver/spectrum analyzer is 1 MHz and the video bandwidth is $\geq 1/T$ (Duty cycle $< 98\%$) or 10 Hz (Duty cycle $\geq 98\%$) for Average detection (AV) at frequency above 1 GHz.
- All modes of operation were investigated and the worst-case emissions are reported.
- For 802.11ax (HE20) CH233: Integration method
 - For peak emissions measurements:
 - Set RBW = 100 kHz
 - Detection = peak.
 - Max hold.
 - Perform band-power integration across the 1 MHz bandwidth in which the band-edge emission level is to be measured.
 - For average emissions measurements:
 - Set RBW = 100 kHz.
 - Perform band-power integration across the 1 MHz bandwidth in which the band-edge emission level is to be measured.

7 Test Results of Test Item

7.1 RF Output Power

| | | | | | |
|--------------|----------------|---------------------------|--------------|------------|-----------------------|
| Input Power: | 120 Vac, 60 Hz | Environmental Conditions: | 25°C, 60% RH | Tested By: | Harry Hsueh / Alan Wu |
|--------------|----------------|---------------------------|--------------|------------|-----------------------|

802.11a

| Chan. | Chan. Freq. (MHz) | Average Power (dBm) | | Total Power (mW) | Total Power (dBm) | Maximum Gain (dBi) | EIRP (mW) | EIRP (dBm) | EIRP Limit (dBm) | Test Result |
|-------|-------------------|---------------------|---------|------------------|-------------------|--------------------|-----------|------------|------------------|-------------|
| | | Chain 0 | Chain 1 | | | | | | | |
| 1 | 5955 | 3.36 | 1.64 | 3.627 | 5.60 | 4.63 | 10.533 | 10.23 | 24 | Pass |
| 45 | 6175 | 3.18 | 1.60 | 3.525 | 5.47 | 4.63 | 10.237 | 10.1 | 24 | Pass |
| 93 | 6415 | 3.06 | 2.94 | 3.991 | 6.01 | 4.63 | 11.59 | 10.64 | 24 | Pass |
| 97 | 6435 | 3.01 | 2.83 | 3.919 | 5.93 | 4.86 | 12 | 10.79 | 24 | Pass |
| 105 | 6475 | 3.08 | 3.16 | 4.102 | 6.13 | 4.86 | 12.56 | 10.99 | 24 | Pass |
| 113 | 6515 | 3.18 | 3.44 | 4.288 | 6.32 | 4.86 | 13.13 | 11.18 | 24 | Pass |
| 117 | 6535 | 3.13 | 3.36 | 4.224 | 6.26 | 4.86 | 12.934 | 11.12 | 24 | Pass |
| 149 | 6695 | 3.11 | 2.93 | 4.01 | 6.03 | 4.86 | 12.278 | 10.89 | 24 | Pass |
| 181 | 6855 | 3.06 | 2.55 | 3.822 | 5.82 | 4.86 | 11.703 | 10.68 | 24 | Pass |
| 185 | 6875 | 3.00 | 2.48 | 3.765 | 5.76 | 4.86 | 11.528 | 10.62 | 24 | Pass |
| 209 | 6995 | 3.22 | 3.05 | 4.117 | 6.15 | 3.79 | 9.853 | 9.94 | 24 | Pass |
| 233 | 7115 | 3.54 | 3.58 | 4.54 | 6.57 | 3.79 | 10.866 | 10.36 | 24 | Pass |

Notes:

1. Directional gain is the maximum gain of antennas.
2. For U-NII-5, The maximum gain is 4.63 dBi
3. For U-NII-6, The maximum gain is 4.86 dBi
4. For U-NII-7, The maximum gain is 4.86 dBi
5. For U-NII-8, The maximum gain is 3.79 dBi

802.11ax (HE20)

| Chan. | Chan. Freq. (MHz) | Average Power (dBm) | | Total Power (mW) | Total Power (dBm) | Maximum Gain (dBi) | EIRP (mW) | EIRP (dBm) | EIRP Limit (dBm) | Test Result |
|-------|-------------------|---------------------|---------|------------------|-------------------|--------------------|-----------|------------|------------------|-------------|
| | | Chain 0 | Chain 1 | | | | | | | |
| 1 | 5955 | 3.44 | 2.13 | 3.841 | 5.84 | 4.63 | 11.154 | 10.47 | 24 | Pass |
| 45 | 6175 | 4.35 | 2.22 | 4.39 | 6.42 | 4.63 | 12.749 | 11.05 | 24 | Pass |
| 93 | 6415 | 3.34 | 3.25 | 4.271 | 6.31 | 4.63 | 12.403 | 10.94 | 24 | Pass |
| 97 | 6435 | 3.02 | 2.95 | 3.977 | 6.00 | 4.86 | 12.177 | 10.86 | 24 | Pass |
| 105 | 6475 | 3.00 | 3.41 | 4.188 | 6.22 | 4.86 | 12.824 | 11.08 | 24 | Pass |
| 113 | 6515 | 2.65 | 3.22 | 3.94 | 5.95 | 4.86 | 12.064 | 10.81 | 24 | Pass |
| 117 | 6535 | 2.53 | 3.08 | 3.823 | 5.82 | 4.86 | 11.706 | 10.68 | 24 | Pass |
| 149 | 6695 | 3.22 | 2.98 | 4.085 | 6.11 | 4.86 | 12.508 | 10.97 | 24 | Pass |
| 181 | 6855 | 2.94 | 2.32 | 3.674 | 5.65 | 4.86 | 11.25 | 10.51 | 24 | Pass |
| 185 | 6875 | 2.82 | 2.19 | 3.57 | 5.53 | 4.86 | 10.931 | 10.39 | 24 | Pass |
| 209 | 6995 | 3.15 | 3.26 | 4.184 | 6.22 | 3.79 | 10.014 | 10.01 | 24 | Pass |
| 233 | 7115 | 3.43 | 3.66 | 4.526 | 6.56 | 3.79 | 10.832 | 10.35 | 24 | Pass |

Notes:

1. Directional gain is the maximum gain of antennas.
2. For U-NII-5, The maximum gain is 4.63 dBi
3. For U-NII-6, The maximum gain is 4.86 dBi
4. For U-NII-7, The maximum gain is 4.86 dBi
5. For U-NII-8, The maximum gain is 3.79 dBi

802.11ax (HE40)

| Chan. | Chan. Freq. (MHz) | Average Power (dBm) | | Total Power (mW) | Total Power (dBm) | Maximum Gain (dBi) | EIRP (mW) | EIRP (dBm) | EIRP Limit (dBm) | Test Result |
|-------|-------------------|---------------------|---------|------------------|-------------------|--------------------|-----------|------------|------------------|-------------|
| | | Chain 0 | Chain 1 | | | | | | | |
| 3 | 5965 | 6.56 | 4.43 | 7.302 | 8.63 | 4.63 | 21.205 | 13.26 | 24 | Pass |
| 43 | 6165 | 7.01 | 5.03 | 8.208 | 9.14 | 4.63 | 23.836 | 13.77 | 24 | Pass |
| 91 | 6405 | 5.90 | 6.04 | 7.908 | 8.98 | 4.63 | 22.965 | 13.61 | 24 | Pass |
| 99 | 6445 | 5.70 | 6.18 | 7.865 | 8.96 | 4.86 | 24.082 | 13.82 | 24 | Pass |
| 107 | 6485 | 5.84 | 6.20 | 8.006 | 9.03 | 4.86 | 24.514 | 13.89 | 24 | Pass |
| 115 | 6525 | 5.05 | 6.29 | 7.455 | 8.72 | 4.86 | 22.827 | 13.58 | 24 | Pass |
| 123 | 6565 | 5.10 | 6.22 | 7.424 | 8.71 | 4.86 | 22.732 | 13.57 | 24 | Pass |
| 155 | 6725 | 5.88 | 5.54 | 7.454 | 8.72 | 4.86 | 22.824 | 13.58 | 24 | Pass |
| 179 | 6845 | 6.03 | 5.77 | 7.784 | 8.91 | 4.86 | 23.834 | 13.77 | 24 | Pass |
| 187 | 6885 | 7.00 | 6.41 | 9.387 | 9.73 | 3.79 | 22.466 | 13.52 | 24 | Pass |
| 211 | 7005 | 7.09 | 7.20 | 10.365 | 10.16 | 3.79 | 24.807 | 13.95 | 24 | Pass |
| 227 | 7085 | 7.02 | 7.22 | 10.307 | 10.13 | 3.79 | 24.668 | 13.92 | 24 | Pass |

Notes:

1. Directional gain is the maximum gain of antennas.
2. For U-NII-5, The maximum gain is 4.63 dBi
3. For U-NII-6, The maximum gain is 4.86 dBi
4. For U-NII-7, The maximum gain is 4.86 dBi
5. For U-NII-8, The maximum gain is 3.79 dBi

802.11ax (HE80)

| Chan. | Chan. Freq. (MHz) | Average Power (dBm) | | Total Power (mW) | Total Power (dBm) | Maximum Gain (dBi) | EIRP (mW) | EIRP (dBm) | EIRP Limit (dBm) | Test Result |
|-------|-------------------|---------------------|---------|------------------|-------------------|--------------------|-----------|------------|------------------|-------------|
| | | Chain 0 | Chain 1 | | | | | | | |
| 7 | 5985 | 6.55 | 4.47 | 7.318 | 8.64 | 4.63 | 21.252 | 13.27 | 24 | Pass |
| 39 | 6145 | 8.41 | 7.11 | 12.075 | 10.82 | 4.63 | 35.066 | 15.45 | 24 | Pass |
| 87 | 6385 | 7.10 | 8.07 | 11.541 | 10.62 | 4.63 | 33.515 | 15.25 | 24 | Pass |
| 103 | 6465 | 7.59 | 8.29 | 12.486 | 10.96 | 4.86 | 38.232 | 15.82 | 24 | Pass |
| 119 | 6545 | 6.72 | 8.29 | 11.444 | 10.59 | 4.86 | 35.041 | 15.45 | 24 | Pass |
| 151 | 6705 | 7.21 | 8.01 | 11.584 | 10.64 | 4.86 | 35.47 | 15.5 | 24 | Pass |
| 183 | 6865 | 8.24 | 7.60 | 12.422 | 10.94 | 4.86 | 38.036 | 15.8 | 24 | Pass |
| 199 | 6945 | 8.00 | 7.60 | 12.064 | 10.81 | 3.79 | 28.873 | 14.6 | 24 | Pass |
| 215 | 7025 | 7.69 | 8.06 | 12.272 | 10.89 | 3.79 | 29.371 | 14.68 | 24 | Pass |

Notes:

1. Directional gain is the maximum gain of antennas.
2. For U-NII-5, The maximum gain is 4.63 dBi
3. For U-NII-6, The maximum gain is 4.86 dBi
4. For U-NII-7, The maximum gain is 4.86 dBi
5. For U-NII-8, The maximum gain is 3.79 dBi

802.11ax (HE160)

| Chan. | Chan. Freq. (MHz) | Average Power (dBm) | | Total Power (mW) | Total Power (dBm) | Maximum Gain (dBi) | EIRP (mW) | EIRP (dBm) | EIRP Limit (dBm) | Test Result |
|-------|-------------------|---------------------|---------|------------------|-------------------|--------------------|-----------|------------|------------------|-------------|
| | | Chain 0 | Chain 1 | | | | | | | |
| 15 | 6025 | 6.86 | 4.77 | 7.852 | 8.95 | 4.63 | 22.802 | 13.58 | 24 | Pass |
| 47 | 6185 | 8.16 | 7.13 | 11.711 | 10.69 | 4.63 | 34.009 | 15.32 | 24 | Pass |
| 79 | 6345 | 7.29 | 7.82 | 11.411 | 10.57 | 4.63 | 33.138 | 15.2 | 24 | Pass |
| 111 | 6505 | 7.24 | 8.51 | 12.392 | 10.93 | 4.86 | 37.944 | 15.79 | 24 | Pass |
| 143 | 6665 | 7.47 | 8.11 | 12.056 | 10.81 | 4.86 | 36.915 | 15.67 | 24 | Pass |
| 175 | 6825 | 7.85 | 7.43 | 11.629 | 10.66 | 4.86 | 35.608 | 15.52 | 24 | Pass |
| 207 | 6985 | 7.79 | 7.76 | 11.982 | 10.79 | 3.79 | 28.677 | 14.58 | 24 | Pass |

Notes:

1. Directional gain is the maximum gain of antennas.
2. For U-NII-5, The maximum gain is 4.63 dBi
3. For U-NII-6, The maximum gain is 4.86 dBi
4. For U-NII-7, The maximum gain is 4.86 dBi
5. For U-NII-8, The maximum gain is 3.79 dBi

802.11ax (HE20) 26-tone RU

| Chan. | Chan. Freq. (MHz) | Average Power (dBm) | | Total Power (mW) | Total Power (dBm) | Maximum Gain (dBi) | EIRP (mW) | EIRP (dBm) | EIRP Limit (dBm) | Test Result |
|-------|-------------------|---------------------|---------|------------------|-------------------|--------------------|-----------|------------|------------------|-------------|
| | | Chain 0 | Chain 1 | | | | | | | |
| 1 | 5955 | -4.92 | -7.48 | 0.5008 | -3.00 | 4.63 | 1.454 | 1.63 | 24 | Pass |
| 93 | 6415 | -6.22 | -5.21 | 0.5401 | -2.68 | 4.63 | 1.568 | 1.95 | 24 | Pass |
| 97 | 6435 | -6.77 | -5.55 | 0.489 | -3.11 | 4.86 | 1.497 | 1.75 | 24 | Pass |
| 117 | 6535 | -8.42 | -4.89 | 0.4682 | -3.30 | 4.86 | 1.434 | 1.56 | 24 | Pass |
| 181 | 6855 | -6.11 | -7.35 | 0.429 | -3.68 | 4.86 | 1.314 | 1.18 | 24 | Pass |
| 233 | 7115 | -5.50 | -5.33 | 0.5749 | -2.40 | 3.79 | 1.376 | 1.39 | 24 | Pass |

Notes:

1. Directional gain is the maximum gain of antennas.
2. For U-NII-5, The maximum gain is 4.63 dBi
3. For U-NII-6, The maximum gain is 4.86 dBi
4. For U-NII-7, The maximum gain is 4.86 dBi
5. For U-NII-8, The maximum gain is 3.79 dBi

802.11ax (HE20) 52-tone RU

| Chan. | Chan. Freq. (MHz) | Average Power (dBm) | | Total Power (mW) | Total Power (dBm) | Maximum Gain (dBi) | EIRP (mW) | EIRP (dBm) | EIRP Limit (dBm) | Test Result |
|-------|-------------------|---------------------|---------|------------------|-------------------|--------------------|-----------|------------|------------------|-------------|
| | | Chain 0 | Chain 1 | | | | | | | |
| 1 | 5955 | -1.99 | -3.46 | 1.0832 | 0.35 | 4.63 | 3.146 | 4.98 | 24 | Pass |
| 93 | 6415 | -2.53 | -2.64 | 1.103 | 0.43 | 4.63 | 3.203 | 5.06 | 24 | Pass |
| 97 | 6435 | -3.47 | -2.37 | 1.0292 | 0.12 | 4.86 | 3.151 | 4.98 | 24 | Pass |
| 117 | 6535 | -3.17 | -2.46 | 1.0495 | 0.21 | 4.86 | 3.214 | 5.07 | 24 | Pass |
| 181 | 6855 | -2.80 | -3.91 | 0.9313 | -0.31 | 4.86 | 2.852 | 4.55 | 24 | Pass |
| 233 | 7115 | -2.78 | -1.90 | 1.1729 | 0.69 | 3.79 | 2.807 | 4.48 | 24 | Pass |

Notes:

1. Directional gain is the maximum gain of antennas.
2. For U-NII-5, The maximum gain is 4.63 dBi
3. For U-NII-6, The maximum gain is 4.86 dBi
4. For U-NII-7, The maximum gain is 4.86 dBi
5. For U-NII-8, The maximum gain is 3.79 dBi

802.11ax (HE20) 106-tone RU

| Chan. | Chan. Freq. (MHz) | Average Power (dBm) | | Total Power (mW) | Total Power (dBm) | Maximum Gain (dBi) | EIRP (mW) | EIRP (dBm) | EIRP Limit (dBm) | Test Result |
|-------|-------------------|---------------------|---------|------------------|-------------------|--------------------|-----------|------------|------------------|-------------|
| | | Chain 0 | Chain 1 | | | | | | | |
| 1 | 5955 | 1.22 | -0.77 | 2.1619 | 3.35 | 4.63 | 6.278 | 7.98 | 24 | Pass |
| 93 | 6415 | 0.21 | 0.04 | 2.059 | 3.14 | 4.63 | 5.979 | 7.77 | 24 | Pass |
| 97 | 6435 | 0.63 | 0.14 | 2.189 | 3.40 | 4.86 | 6.703 | 8.26 | 24 | Pass |
| 117 | 6535 | 0.35 | -0.38 | 2.0001 | 3.01 | 4.86 | 6.124 | 7.87 | 24 | Pass |
| 181 | 6855 | -0.10 | -0.81 | 1.8071 | 2.57 | 4.86 | 5.533 | 7.43 | 24 | Pass |
| 233 | 7115 | 1.35 | 1.35 | 2.729 | 4.36 | 3.79 | 6.531 | 8.15 | 24 | Pass |

Notes:

1. Directional gain is the maximum gain of antennas.
2. For U-NII-5, The maximum gain is 4.63 dBi
3. For U-NII-6, The maximum gain is 4.86 dBi
4. For U-NII-7, The maximum gain is 4.86 dBi
5. For U-NII-8, The maximum gain is 3.79 dBi

802.11ax (HE40) 242-tone RU

| Chan. | Chan. Freq. (MHz) | Average Power (dBm) | | Total Power (mW) | Total Power (dBm) | Maximum Gain (dBi) | EIRP (mW) | EIRP (dBm) | EIRP Limit (dBm) | Test Result |
|-------|-------------------|---------------------|---------|------------------|-------------------|--------------------|-----------|------------|------------------|-------------|
| | | Chain 0 | Chain 1 | | | | | | | |
| 3 | 5965 | 3.41 | 1.57 | 3.628 | 5.60 | 4.63 | 10.536 | 10.23 | 24 | Pass |
| 91 | 6405 | 2.99 | 3.14 | 4.051 | 6.08 | 4.63 | 11.764 | 10.71 | 24 | Pass |
| 99 | 6445 | 2.77 | 3.29 | 4.025 | 6.05 | 4.86 | 12.324 | 10.91 | 24 | Pass |
| 115 | 6525 | 2.15 | 3.11 | 3.687 | 5.67 | 4.86 | 11.289 | 10.53 | 24 | Pass |
| 123 | 6565 | 2.21 | 3.14 | 3.724 | 5.71 | 4.86 | 11.403 | 10.57 | 24 | Pass |
| 179 | 6845 | 3.13 | 2.84 | 3.979 | 6.00 | 4.86 | 12.184 | 10.86 | 24 | Pass |
| 187 | 6885 | 4.10 | 3.55 | 4.835 | 6.84 | 3.79 | 11.572 | 10.63 | 24 | Pass |
| 227 | 7085 | 4.12 | 4.34 | 5.299 | 7.24 | 3.79 | 12.682 | 11.03 | 24 | Pass |

Notes:

1. Directional gain is the maximum gain of antennas.
2. For U-NII-5, The maximum gain is 4.63 dBi
3. For U-NII-6, The maximum gain is 4.86 dBi
4. For U-NII-7, The maximum gain is 4.86 dBi
5. For U-NII-8, The maximum gain is 3.79 dBi

802.11ax (HE80) 484-tone RU

| Chan. | Chan. Freq. (MHz) | Average Power (dBm) | | Total Power (mW) | Total Power (dBm) | Maximum Gain (dBi) | EIRP (mW) | EIRP (dBm) | EIRP Limit (dBm) | Test Result |
|-------|-------------------|---------------------|---------|------------------|-------------------|--------------------|-----------|------------|------------------|-------------|
| | | Chain 0 | Chain 1 | | | | | | | |
| 7 | 5985 | 3.40 | 1.51 | 3.604 | 5.57 | 4.63 | 10.466 | 10.2 | 24 | Pass |
| 87 | 6385 | 4.21 | 5.17 | 5.925 | 7.73 | 4.63 | 17.206 | 12.36 | 24 | Pass |
| 103 | 6465 | 4.64 | 5.31 | 6.307 | 8.00 | 4.86 | 19.312 | 12.86 | 24 | Pass |
| 119 | 6545 | 3.89 | 5.11 | 5.692 | 7.55 | 4.86 | 17.429 | 12.41 | 24 | Pass |
| 151 | 6705 | 4.33 | 5.11 | 5.954 | 7.75 | 4.86 | 18.231 | 12.61 | 24 | Pass |
| 183 | 6865 | 5.36 | 4.76 | 6.428 | 8.08 | 4.86 | 19.682 | 12.94 | 24 | Pass |
| 199 | 6945 | 5.10 | 4.76 | 6.228 | 7.94 | 3.79 | 14.906 | 11.73 | 24 | Pass |
| 215 | 7025 | 4.75 | 5.16 | 6.266 | 7.97 | 3.79 | 14.997 | 11.76 | 24 | Pass |

Notes:

1. Directional gain is the maximum gain of antennas.
2. For U-NII-5, The maximum gain is 4.63 dBi
3. For U-NII-6, The maximum gain is 4.86 dBi
4. For U-NII-7, The maximum gain is 4.86 dBi
5. For U-NII-8, The maximum gain is 3.79 dBi

802.11ax (HE160) 996-tone RU

| Chan. | Chan. Freq. (MHz) | Average Power (dBm) | | Total Power (mW) | Total Power (dBm) | Maximum Gain (dBi) | EIRP (mW) | EIRP (dBm) | EIRP Limit (dBm) | Test Result |
|-------|-------------------|---------------------|---------|------------------|-------------------|--------------------|-----------|------------|------------------|-------------|
| | | Chain 0 | Chain 1 | | | | | | | |
| 15 | 6025 | 3.74 | 1.84 | 3.893 | 5.90 | 4.63 | 11.305 | 10.53 | 24 | Pass |
| 79 | 6345 | 4.31 | 4.90 | 5.788 | 7.63 | 4.63 | 16.808 | 12.26 | 24 | Pass |
| 111 | 6505 | 4.36 | 5.46 | 6.245 | 7.96 | 4.86 | 19.122 | 12.82 | 24 | Pass |
| 143 | 6665 | 4.51 | 5.22 | 6.151 | 7.89 | 4.86 | 18.834 | 12.75 | 24 | Pass |
| 175 | 6825 | 4.93 | 4.57 | 5.976 | 7.76 | 4.86 | 18.298 | 12.62 | 24 | Pass |
| 207 | 6985 | 4.86 | 4.83 | 6.103 | 7.86 | 3.79 | 14.606 | 11.65 | 24 | Pass |

Notes:

1. Directional gain is the maximum gain of antennas.
2. For U-NII-5, The maximum gain is 4.63 dBi
3. For U-NII-6, The maximum gain is 4.86 dBi
4. For U-NII-7, The maximum gain is 4.86 dBi
5. For U-NII-8, The maximum gain is 3.79 dBi

7.2 Power Spectral Density

| | | | | | |
|--------------|----------------|---------------------------|--------------|------------|-----------------------|
| Input Power: | 120 Vac, 60 Hz | Environmental Conditions: | 25°C, 60% RH | Tested By: | Harry Hsueh / Alan Wu |
|--------------|----------------|---------------------------|--------------|------------|-----------------------|

802.11a

| Chan. | Chan. Freq. (MHz) | PSD (dBm/MHz) | | Total PSD (dBm/MHz) | Directional Gain (dBi) | EIRP PSD (dBm/MHz) | EIRP PSD Limit (dBm/MHz) | Test Result |
|-------|-------------------|---------------|---------|---------------------|------------------------|--------------------|--------------------------|-------------|
| | | Chain 0 | Chain 1 | | | | | |
| 1 | 5955 | -10.60 | -12.64 | -8.49 | 7.30 | -1.19 | -1 | Pass |
| 45 | 6175 | -11.16 | -12.69 | -8.85 | 7.30 | -1.55 | -1 | Pass |
| 93 | 6415 | -11.65 | -12.12 | -8.87 | 7.30 | -1.57 | -1 | Pass |
| 97 | 6435 | -11.76 | -12.12 | -8.93 | 7.49 | -1.44 | -1 | Pass |
| 105 | 6475 | -11.68 | -11.62 | -8.64 | 7.49 | -1.15 | -1 | Pass |
| 113 | 6515 | -11.80 | -11.45 | -8.61 | 7.49 | -1.12 | -1 | Pass |
| 117 | 6535 | -11.89 | -11.50 | -8.68 | 7.49 | -1.19 | -1 | Pass |
| 149 | 6695 | -11.78 | -12.06 | -8.91 | 7.49 | -1.42 | -1 | Pass |
| 181 | 6855 | -11.70 | -12.52 | -9.08 | 7.49 | -1.59 | -1 | Pass |
| 185 | 6875 | -11.76 | -12.39 | -9.05 | 7.49 | -1.56 | -1 | Pass |
| 209 | 6995 | -11.02 | -11.25 | -8.12 | 6.51 | -1.61 | -1 | Pass |
| 233 | 7115 | -10.70 | -10.79 | -7.73 | 6.51 | -1.22 | -1 | Pass |

Notes:

- Method E) 2) a) of power density measurement of KDB 662911 is using for calculating total power density. Total power density is summing entire spectra across corresponding frequency bins on the various outputs by computer.
- Directional gain = $10 \log[(10^{\text{Chain0}/20} + 10^{\text{Chain1}/20})^2 / 2]$
- For U-NII-5, The directional gain is 7.3 dBi
- For U-NII-6, The directional gain is 7.49 dBi
- For U-NII-7, The directional gain is 7.49 dBi
- For U-NII-8, The directional gain is 6.51 dBi

802.11ax (HE20)

| Chan. | Chan. Freq. (MHz) | PSD (dBm/MHz) | | Total PSD (dBm/MHz) | Directional Gain (dBi) | EIRP PSD (dBm/MHz) | EIRP PSD Limit (dBm/MHz) | Test Result |
|-------|-------------------|---------------|---------|---------------------|------------------------|--------------------|--------------------------|-------------|
| | | Chain 0 | Chain 1 | | | | | |
| 1 | 5955 | -10.92 | -12.37 | -8.57 | 7.30 | -1.27 | -1 | Pass |
| 45 | 6175 | -10.91 | -12.06 | -8.44 | 7.30 | -1.14 | -1 | Pass |
| 93 | 6415 | -11.35 | -11.44 | -8.38 | 7.30 | -1.08 | -1 | Pass |
| 97 | 6435 | -11.99 | -12.00 | -8.98 | 7.49 | -1.49 | -1 | Pass |
| 105 | 6475 | -11.70 | -11.53 | -8.60 | 7.49 | -1.11 | -1 | Pass |
| 113 | 6515 | -11.77 | -11.32 | -8.53 | 7.49 | -1.04 | -1 | Pass |
| 117 | 6535 | -11.94 | -11.34 | -8.62 | 7.49 | -1.13 | -1 | Pass |
| 149 | 6695 | -11.36 | -11.92 | -8.62 | 7.49 | -1.13 | -1 | Pass |
| 181 | 6855 | -11.72 | -12.42 | -9.05 | 7.49 | -1.56 | -1 | Pass |
| 185 | 6875 | -11.55 | -12.61 | -9.04 | 7.49 | -1.55 | -1 | Pass |
| 209 | 6995 | -10.97 | -11.20 | -8.07 | 6.51 | -1.56 | -1 | Pass |
| 233 | 7115 | -10.72 | -10.66 | -7.68 | 6.51 | -1.17 | -1 | Pass |

Notes:

- Method E) 2) a) of power density measurement of KDB 662911 is using for calculating total power density. Total power density is summing entire spectra across corresponding frequency bins on the various outputs by computer.
- Directional gain = $10 \log[(10^{\text{Chain0}/20} + 10^{\text{Chain1}/20})^2 / 2]$
- For U-NII-5, The directional gain is 7.3 dBi
- For U-NII-6, The directional gain is 7.49 dBi
- For U-NII-7, The directional gain is 7.49 dBi
- For U-NII-8, The directional gain is 6.51 dBi

802.11ax (HE40)

| Chan. | Chan. Freq. (MHz) | PSD (dBm/MHz) | | Total PSD (dBm/MHz) | Directional Gain (dBi) | EIRP PSD (dBm/MHz) | EIRP PSD Limit (dBm/MHz) | Test Result |
|-------|-------------------|---------------|---------|---------------------|------------------------|--------------------|--------------------------|-------------|
| | | Chain 0 | Chain 1 | | | | | |
| 3 | 5965 | -11.65 | -13.05 | -9.28 | 7.30 | -1.98 | -1 | Pass |
| 43 | 6165 | -11.23 | -12.59 | -8.85 | 7.30 | -1.55 | -1 | Pass |
| 91 | 6405 | -11.80 | -11.65 | -8.71 | 7.30 | -1.41 | -1 | Pass |
| 99 | 6445 | -11.92 | -11.73 | -8.81 | 7.49 | -1.32 | -1 | Pass |
| 107 | 6485 | -11.81 | -11.35 | -8.56 | 7.49 | -1.07 | -1 | Pass |
| 115 | 6525 | -12.21 | -11.12 | -8.62 | 7.49 | -1.13 | -1 | Pass |
| 123 | 6565 | -12.22 | -11.18 | -8.66 | 7.49 | -1.17 | -1 | Pass |
| 155 | 6725 | -11.81 | -12.12 | -8.95 | 7.49 | -1.46 | -1 | Pass |
| 179 | 6845 | -11.72 | -12.22 | -8.95 | 7.49 | -1.46 | -1 | Pass |
| 187 | 6885 | -10.55 | -11.38 | -7.93 | 6.51 | -1.42 | -1 | Pass |
| 211 | 7005 | -10.70 | -10.85 | -7.76 | 6.51 | -1.25 | -1 | Pass |
| 227 | 7085 | -10.97 | -10.77 | -7.86 | 6.51 | -1.35 | -1 | Pass |

Notes:

- Method E) 2) a) of power density measurement of KDB 662911 is using for calculating total power density. Total power density is summing entire spectra across corresponding frequency bins on the various outputs by computer.
- Directional gain = $10 \log[(10^{\text{Chain0}/20} + 10^{\text{Chain1}/20})^2 / 2]$
- For U-NII-5, The directional gain is 7.3 dBi
- For U-NII-6, The directional gain is 7.49 dBi
- For U-NII-7, The directional gain is 7.49 dBi
- For U-NII-8, The directional gain is 6.51 dBi

802.11ax (HE80)

| Chan. | Chan. Freq. (MHz) | PSD (dBm/MHz) | | Total PSD (dBm/MHz) | Directional Gain (dBi) | EIRP PSD (dBm/MHz) | EIRP PSD Limit (dBm/MHz) | Test Result |
|-------|-------------------|---------------|---------|---------------------|------------------------|--------------------|--------------------------|-------------|
| | | Chain 0 | Chain 1 | | | | | |
| 7 | 5985 | -14.22 | -15.40 | -11.76 | 7.30 | -4.46 | -1 | Pass |
| 39 | 6145 | -12.70 | -13.67 | -10.15 | 7.30 | -2.85 | -1 | Pass |
| 87 | 6385 | -13.43 | -12.68 | -10.03 | 7.30 | -2.73 | -1 | Pass |
| 103 | 6465 | -12.81 | -12.57 | -9.68 | 7.49 | -2.19 | -1 | Pass |
| 119 | 6545 | -13.87 | -12.57 | -10.16 | 7.49 | -2.67 | -1 | Pass |
| 151 | 6705 | -12.99 | -13.22 | -10.09 | 7.49 | -2.6 | -1 | Pass |
| 183 | 6865 | -12.51 | -13.10 | -9.78 | 7.49 | -2.29 | -1 | Pass |
| 199 | 6945 | -12.58 | -13.05 | -9.80 | 6.51 | -3.29 | -1 | Pass |
| 215 | 7025 | -13.39 | -12.35 | -9.83 | 6.51 | -3.32 | -1 | Pass |

Notes:

- Method E) 2) a) of power density measurement of KDB 662911 is using for calculating total power density. Total power density is summing entire spectra across corresponding frequency bins on the various outputs by computer.
- Directional gain = $10 \log[(10^{\text{Chain0}/20} + 10^{\text{Chain1}/20})^2 / 2]$
- For U-NII-5, The directional gain is 7.3 dBi
- For U-NII-6, The directional gain is 7.49 dBi
- For U-NII-7, The directional gain is 7.49 dBi
- For U-NII-8, The directional gain is 6.51 dBi

802.11ax (HE160)

| Chan. | Chan. Freq. (MHz) | PSD (dBm/MHz) | | Total PSD (dBm/MHz) | Directional Gain (dBi) | EIRP PSD (dBm/MHz) | EIRP PSD Limit (dBm/MHz) | Test Result |
|-------|-------------------|---------------|---------|---------------------|------------------------|--------------------|--------------------------|-------------|
| | | Chain 0 | Chain 1 | | | | | |
| 15 | 6025 | -16.93 | -18.94 | -14.81 | 7.30 | -7.51 | -1 | Pass |
| 47 | 6185 | -15.74 | -16.16 | -12.93 | 7.30 | -5.63 | -1 | Pass |
| 79 | 6345 | -16.20 | -15.67 | -12.92 | 7.30 | -5.62 | -1 | Pass |
| 111 | 6505 | -16.30 | -15.24 | -12.73 | 7.49 | -5.24 | -1 | Pass |
| 143 | 6665 | -16.19 | -15.61 | -12.88 | 7.49 | -5.39 | -1 | Pass |
| 175 | 6825 | -16.02 | -16.35 | -13.17 | 7.49 | -5.68 | -1 | Pass |
| 207 | 6985 | -16.04 | -16.01 | -13.01 | 6.51 | -6.5 | -1 | Pass |

Notes:

- Method E) 2) a) of power density measurement of KDB 662911 is using for calculating total power density. Total power density is summing entire spectra across corresponding frequency bins on the various outputs by computer.
- Directional gain = $10 \log[(10^{\text{Chain0}/20} + 10^{\text{Chain1}/20})^2 / 2]$
- For U-NII-5, The directional gain is 7.3 dBi
- For U-NII-6, The directional gain is 7.49 dBi
- For U-NII-7, The directional gain is 7.49 dBi
- For U-NII-8, The directional gain is 6.51 dBi

802.11ax (HE20) 26-tone RU

| Chan. | Chan. Freq. (MHz) | PSD (dBm/MHz) | | Total PSD (dBm/MHz) | Directional Gain (dBi) | EIRP PSD (dBm/MHz) | EIRP PSD Limit (dBm/MHz) | Test Result |
|-------|-------------------|---------------|---------|---------------------|------------------------|--------------------|--------------------------|-------------|
| | | Chain 0 | Chain 1 | | | | | |
| 1 | 5955 | -10.60 | -13.93 | -8.94 | 7.30 | -1.64 | -1 | Pass |
| 93 | 6415 | -12.75 | -10.79 | -8.65 | 7.30 | -1.35 | -1 | Pass |
| 97 | 6435 | -12.30 | -11.93 | -9.10 | 7.49 | -1.61 | -1 | Pass |
| 117 | 6535 | -13.55 | -10.61 | -8.83 | 7.49 | -1.34 | -1 | Pass |
| 181 | 6855 | -11.15 | -12.60 | -8.80 | 7.49 | -1.31 | -1 | Pass |
| 233 | 7115 | -11.02 | -10.88 | -7.94 | 6.51 | -1.43 | -1 | Pass |

Notes:

- Method E) 2) a) of power density measurement of KDB 662911 is using for calculating total power density. Total power density is summing entire spectra across corresponding frequency bins on the various outputs by computer.
- Directional gain = $10 \log[(10^{\text{Chain0}/20} + 10^{\text{Chain1}/20})^2 / 2]$
- For U-NII-5, The directional gain is 7.3 dBi
- For U-NII-6, The directional gain is 7.49 dBi
- For U-NII-7, The directional gain is 7.49 dBi
- For U-NII-8, The directional gain is 6.51 dBi

802.11ax (HE20) 52-tone RU

| Chan. | Chan. Freq. (MHz) | PSD (dBm/MHz) | | Total PSD (dBm/MHz) | Directional Gain (dBi) | EIRP PSD (dBm/MHz) | EIRP PSD Limit (dBm/MHz) | Test Result |
|-------|-------------------|---------------|---------|---------------------|------------------------|--------------------|--------------------------|-------------|
| | | Chain 0 | Chain 1 | | | | | |
| 1 | 5955 | -10.99 | -12.45 | -8.65 | 7.30 | -1.35 | -1 | Pass |
| 93 | 6415 | -11.32 | -11.86 | -8.57 | 7.30 | -1.27 | -1 | Pass |
| 97 | 6435 | -12.57 | -11.26 | -8.86 | 7.49 | -1.37 | -1 | Pass |
| 117 | 6535 | -11.91 | -11.54 | -8.71 | 7.49 | -1.22 | -1 | Pass |
| 181 | 6855 | -11.00 | -12.37 | -8.62 | 7.49 | -1.13 | -1 | Pass |
| 233 | 7115 | -11.01 | -10.98 | -7.98 | 6.51 | -1.47 | -1 | Pass |

Notes:

- Method E) 2) a) of power density measurement of KDB 662911 is using for calculating total power density. Total power density is summing entire spectra across corresponding frequency bins on the various outputs by computer.
- Directional gain = $10 \log[(10^{\text{Chain0}/20} + 10^{\text{Chain1}/20})^2 / 2]$
- For U-NII-5, The directional gain is 7.3 dBi
- For U-NII-6, The directional gain is 7.49 dBi
- For U-NII-7, The directional gain is 7.49 dBi
- For U-NII-8, The directional gain is 6.51 dBi

802.11ax (HE20) 106-tone RU

| Chan. | Chan. Freq. (MHz) | PSD (dBm/MHz) | | Total PSD (dBm/MHz) | Directional Gain (dBi) | EIRP PSD (dBm/MHz) | EIRP PSD Limit (dBm/MHz) | Test Result |
|-------|-------------------|---------------|---------|---------------------|------------------------|--------------------|--------------------------|-------------|
| | | Chain 0 | Chain 1 | | | | | |
| 1 | 5955 | -10.74 | -12.94 | -8.69 | 7.30 | -1.39 | -1 | Pass |
| 93 | 6415 | -11.61 | -12.22 | -8.89 | 7.30 | -1.59 | -1 | Pass |
| 97 | 6435 | -11.62 | -11.59 | -8.59 | 7.49 | -1.1 | -1 | Pass |
| 117 | 6535 | -12.36 | -11.87 | -9.10 | 7.49 | -1.61 | -1 | Pass |
| 181 | 6855 | -11.39 | -12.17 | -8.75 | 7.49 | -1.26 | -1 | Pass |
| 233 | 7115 | -10.43 | -10.71 | -7.56 | 6.51 | -1.05 | -1 | Pass |

Notes:

- Method E) 2) a) of power density measurement of KDB 662911 is using for calculating total power density. Total power density is summing entire spectra across corresponding frequency bins on the various outputs by computer.
- Directional gain = $10 \log[(10^{\text{Chain0}/20} + 10^{\text{Chain1}/20})^2 / 2]$
- For U-NII-5, The directional gain is 7.3 dBi
- For U-NII-6, The directional gain is 7.49 dBi
- For U-NII-7, The directional gain is 7.49 dBi
- For U-NII-8, The directional gain is 6.51 dBi

802.11ax (HE40) 242-tone RU

| Chan. | Chan. Freq. (MHz) | PSD (dBm/MHz) | | Total PSD (dBm/MHz) | Directional Gain (dBi) | EIRP PSD (dBm/MHz) | EIRP PSD Limit (dBm/MHz) | Test Result |
|-------|-------------------|---------------|---------|---------------------|------------------------|--------------------|--------------------------|-------------|
| | | Chain 0 | Chain 1 | | | | | |
| 3 | 5965 | -11.76 | -13.25 | -9.43 | 7.30 | -2.13 | -1 | Pass |
| 91 | 6405 | -11.54 | -12.97 | -9.19 | 7.30 | -1.89 | -1 | Pass |
| 99 | 6445 | -12.05 | -12.16 | -9.09 | 7.49 | -1.6 | -1 | Pass |
| 115 | 6525 | -12.35 | -11.21 | -8.73 | 7.49 | -1.24 | -1 | Pass |
| 123 | 6565 | -12.34 | -11.43 | -8.85 | 7.49 | -1.36 | -1 | Pass |
| 179 | 6845 | -11.90 | -12.37 | -9.12 | 7.49 | -1.63 | -1 | Pass |
| 187 | 6885 | -10.63 | -11.57 | -8.06 | 6.51 | -1.55 | -1 | Pass |
| 227 | 7085 | -11.08 | -10.94 | -8.00 | 6.51 | -1.49 | -1 | Pass |

Notes:

- Method E) 2) a) of power density measurement of KDB 662911 is using for calculating total power density. Total power density is summing entire spectra across corresponding frequency bins on the various outputs by computer.
- Directional gain = $10 \log[(10^{\text{Chain0}/20} + 10^{\text{Chain1}/20})^2 / 2]$
- For U-NII-5, The directional gain is 7.3 dBi
- For U-NII-6, The directional gain is 7.49 dBi
- For U-NII-7, The directional gain is 7.49 dBi
- For U-NII-8, The directional gain is 6.51 dBi

802.11ax (HE80) 484-tone RU

| Chan. | Chan. Freq. (MHz) | PSD (dBm/MHz) | | Total PSD (dBm/MHz) | Directional Gain (dBi) | EIRP PSD (dBm/MHz) | EIRP PSD Limit (dBm/MHz) | Test Result |
|-------|-------------------|---------------|---------|---------------------|------------------------|--------------------|--------------------------|-------------|
| | | Chain 0 | Chain 1 | | | | | |
| 7 | 5985 | -14.29 | -15.82 | -11.98 | 7.30 | -4.68 | -1 | Pass |
| 87 | 6385 | -13.60 | -12.90 | -10.23 | 7.30 | -2.93 | -1 | Pass |
| 103 | 6465 | -13.11 | -12.87 | -9.98 | 7.49 | -2.49 | -1 | Pass |
| 119 | 6545 | -14.13 | -12.85 | -10.43 | 7.49 | -2.94 | -1 | Pass |
| 151 | 6705 | -13.12 | -13.51 | -10.30 | 7.49 | -2.81 | -1 | Pass |
| 183 | 6865 | -12.72 | -13.20 | -9.94 | 7.49 | -2.45 | -1 | Pass |
| 199 | 6945 | -12.79 | -13.16 | -9.96 | 6.51 | -3.45 | -1 | Pass |
| 215 | 7025 | -13.63 | -12.53 | -10.03 | 6.51 | -3.52 | -1 | Pass |

Notes:

- Method E) 2) a) of power density measurement of KDB 662911 is using for calculating total power density. Total power density is summing entire spectra across corresponding frequency bins on the various outputs by computer.
- Directional gain = $10 \log[(10^{\text{Chain0}/20} + 10^{\text{Chain1}/20})^2 / 2]$
- For U-NII-5, The directional gain is 7.3 dBi
- For U-NII-6, The directional gain is 7.49 dBi
- For U-NII-7, The directional gain is 7.49 dBi
- For U-NII-8, The directional gain is 6.51 dBi

802.11ax (HE160) 996-tone RU

| Chan. | Chan. Freq. (MHz) | PSD (dBm/MHz) | | Total PSD (dBm/MHz) | Directional Gain (dBi) | EIRP PSD (dBm/MHz) | EIRP PSD Limit (dBm/MHz) | Test Result |
|-------|-------------------|---------------|---------|---------------------|------------------------|--------------------|--------------------------|-------------|
| | | Chain 0 | Chain 1 | | | | | |
| 15 | 6025 | -17.26 | -19.46 | -15.21 | 7.30 | -7.91 | -1 | Pass |
| 79 | 6345 | -16.35 | -16.03 | -13.18 | 7.30 | -5.88 | -1 | Pass |
| 111 | 6505 | -16.56 | -15.79 | -13.15 | 7.49 | -5.66 | -1 | Pass |
| 143 | 6665 | -16.53 | -15.94 | -13.21 | 7.49 | -5.72 | -1 | Pass |
| 175 | 6825 | -16.29 | -16.74 | -13.50 | 7.49 | -6.01 | -1 | Pass |
| 207 | 6985 | -16.34 | -16.29 | -13.30 | 6.51 | -6.79 | -1 | Pass |

Notes:

- Method E) 2) a) of power density measurement of KDB 662911 is using for calculating total power density. Total power density is summing entire spectra across corresponding frequency bins on the various outputs by computer.
- Directional gain = $10 \log[(10^{\text{Chain0}/20} + 10^{\text{Chain1}/20})^2 / 2]$
- For U-NII-5, The directional gain is 7.3 dBi
- For U-NII-6, The directional gain is 7.49 dBi
- For U-NII-7, The directional gain is 7.49 dBi
- For U-NII-8, The directional gain is 6.51 dBi



Spectrum Plot of Maximum Value

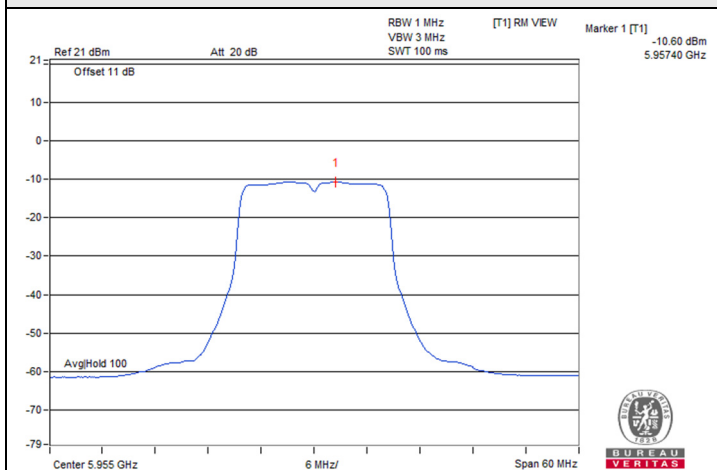

802.11a / Chain 0 : CH 1

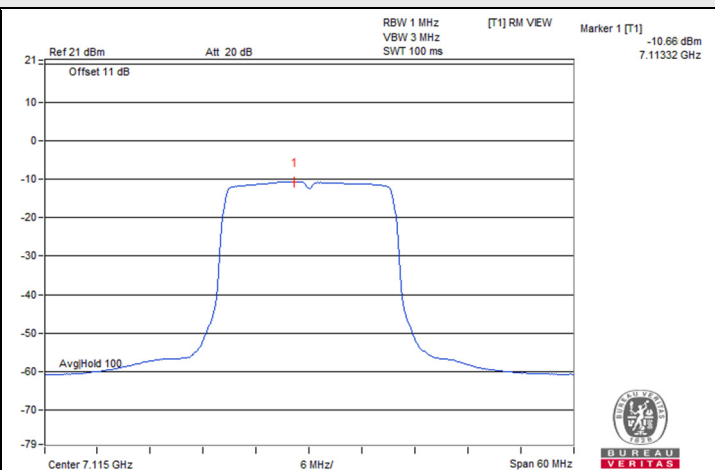

802.11ax (HE20) / Chain 1 : CH 233

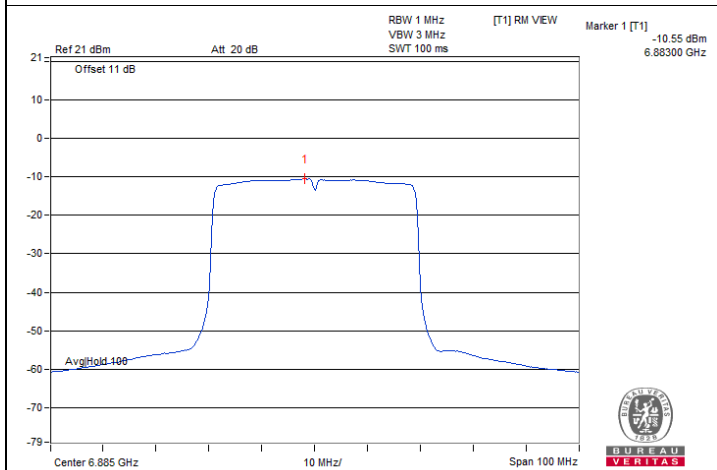

802.11ax (HE40) / Chain 0 : CH 187

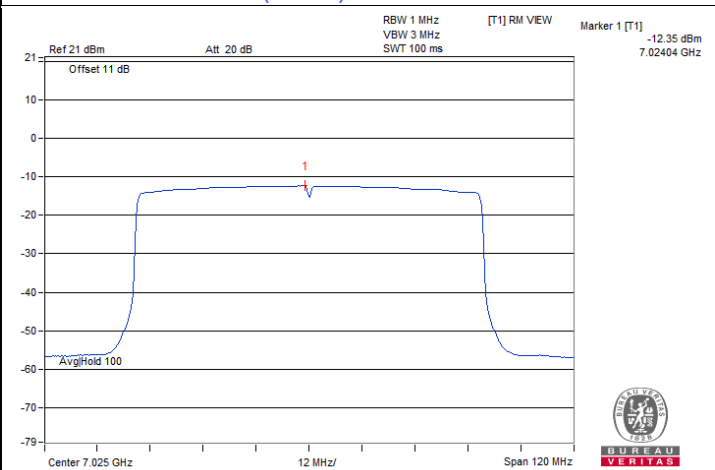

802.11ax (HE80) / Chain 1 : CH 215

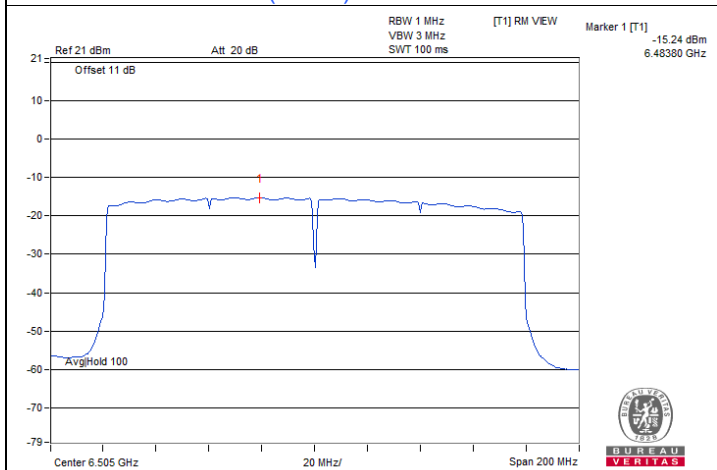

802.11ax (HE160) / Chain 1 : CH 111

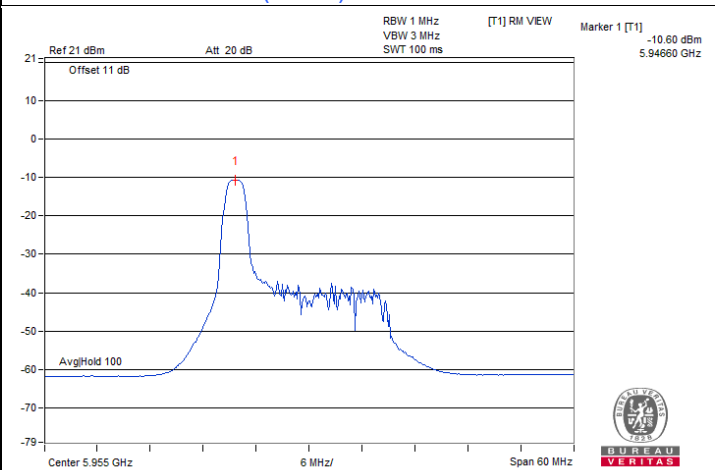

802.11ax (HE20) 26-tone RU / Chain 0 : CH 1@0

Spectrum Plot of Maximum Value

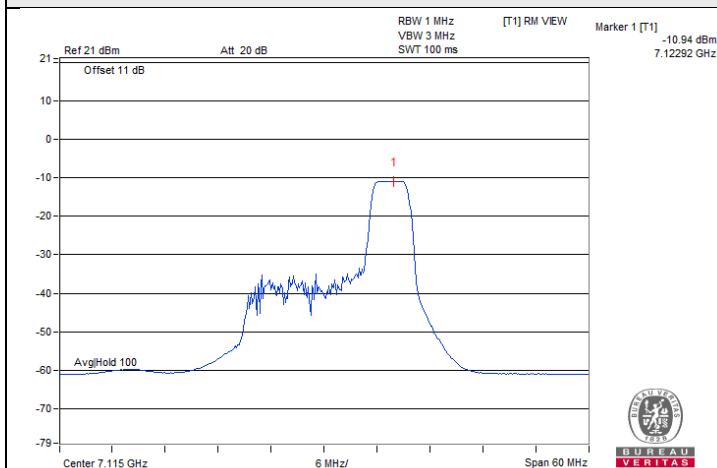

802.11ax (HE20) 52-tone RU / Chain 1 : CH 233@40

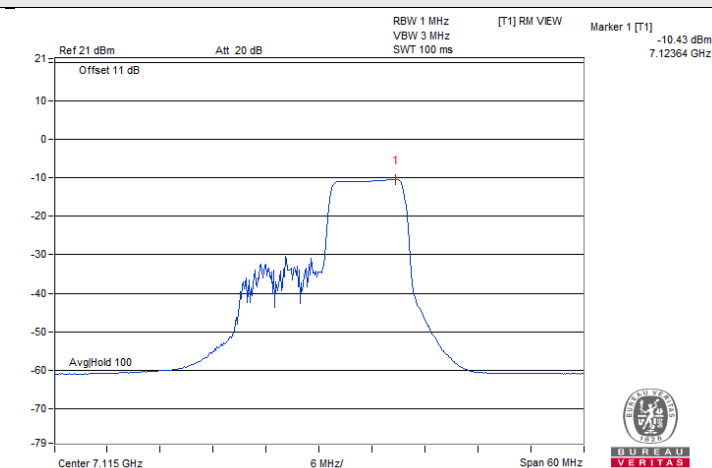

802.11ax (HE20) 106-tone RU / Chain 0 : CH 233@54

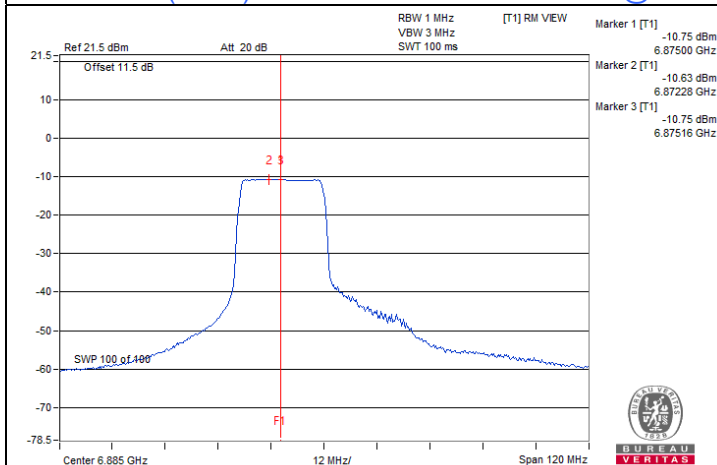

802.11ax (HE40) 242-tone RU / Chain 0 : CH 187@61

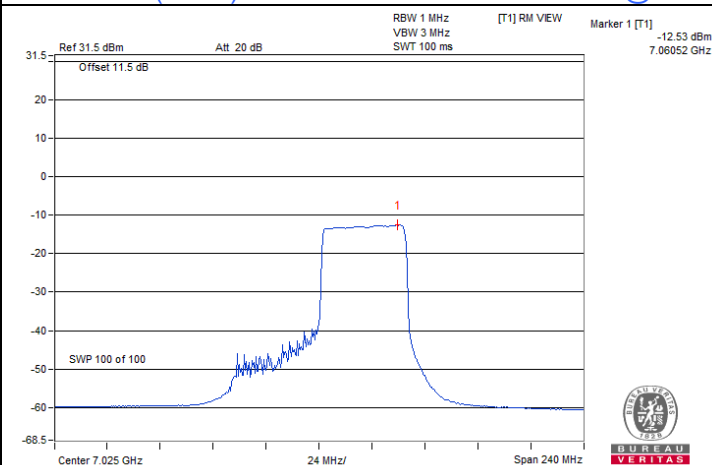

802.11ax (HE80) 484-tone RU / Chain 1 : CH 215@66

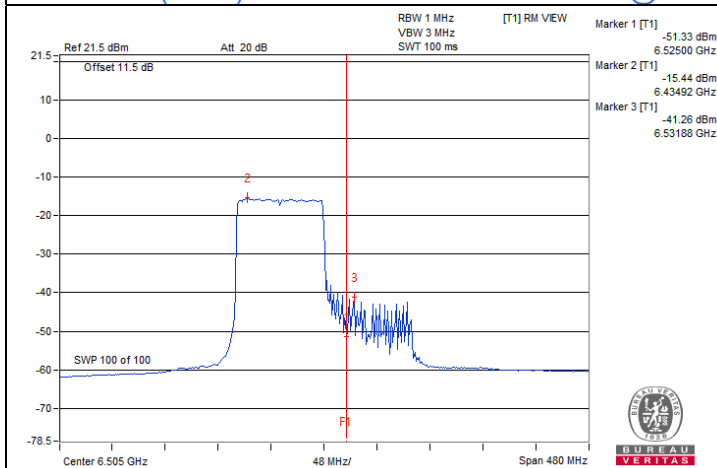

802.11ax (HE160) 996-tone RU / Chain 1 : CH 111@67

7.3 Emission Bandwidth

| | | | | | |
|--------------|----------------|---------------------------|--------------|------------|-----------------------|
| Input Power: | 120 Vac, 60 Hz | Environmental Conditions: | 25°C, 60% RH | Tested By: | Harry Hsueh / Alan Wu |
|--------------|----------------|---------------------------|--------------|------------|-----------------------|

802.11a

| Channel | Frequency (MHz) | 26dB Bandwidth (MHz) | | Maximum Limit (MHz) | Test Result |
|---------|-----------------|----------------------|---------|---------------------|-------------|
| | | Chain 0 | Chain 1 | | |
| 1 | 5955 | 19.73 | 19.59 | 320 | Pass |
| 45 | 6175 | 19.74 | 19.81 | 320 | Pass |
| 93 | 6415 | 19.71 | 19.83 | 320 | Pass |
| 97 | 6435 | 19.75 | 19.60 | 320 | Pass |
| 105 | 6475 | 19.70 | 19.72 | 320 | Pass |
| 113 | 6515 | 19.68 | 19.79 | 320 | Pass |
| 117 | 6535 | 19.70 | 19.88 | 320 | Pass |
| 149 | 6695 | 19.75 | 19.76 | 320 | Pass |
| 181 | 6855 | 19.64 | 19.71 | 320 | Pass |
| 185 | 6875 | 19.65 | 19.58 | 320 | Pass |
| 209 | 6995 | 21.61 | 21.80 | 320 | Pass |
| 233 | 7115 | 19.68 | 19.93 | 320 | Pass |

802.11ax (HE20)

| Channel | Frequency (MHz) | 26dB Bandwidth (MHz) | | Maximum Limit (MHz) | Test Result |
|---------|-----------------|----------------------|---------|---------------------|-------------|
| | | Chain 0 | Chain 1 | | |
| 1 | 5955 | 21.21 | 21.65 | 320 | Pass |
| 45 | 6175 | 21.50 | 21.60 | 320 | Pass |
| 93 | 6415 | 21.47 | 21.63 | 320 | Pass |
| 97 | 6435 | 21.52 | 21.59 | 320 | Pass |
| 105 | 6475 | 21.44 | 21.77 | 320 | Pass |
| 113 | 6515 | 21.45 | 21.81 | 320 | Pass |
| 117 | 6535 | 21.64 | 21.58 | 320 | Pass |
| 149 | 6695 | 21.60 | 21.59 | 320 | Pass |
| 181 | 6855 | 21.60 | 21.84 | 320 | Pass |
| 185 | 6875 | 21.50 | 21.57 | 320 | Pass |
| 209 | 6995 | 21.40 | 21.25 | 320 | Pass |
| 233 | 7115 | 21.59 | 21.67 | 320 | Pass |

802.11ax (HE40)

| Channel | Frequency (MHz) | 26dB Bandwidth (MHz) | | Maximum Limit (MHz) | Test Result |
|---------|-----------------|----------------------|---------|---------------------|-------------|
| | | Chain 0 | Chain 1 | | |
| 3 | 5965 | 40.91 | 41.09 | 320 | Pass |
| 43 | 6165 | 41.54 | 41.21 | 320 | Pass |
| 91 | 6405 | 41.08 | 41.37 | 320 | Pass |
| 99 | 6445 | 41.22 | 41.27 | 320 | Pass |
| 107 | 6485 | 41.58 | 41.14 | 320 | Pass |
| 115 | 6525 | 41.14 | 41.22 | 320 | Pass |
| 123 | 6565 | 41.14 | 41.21 | 320 | Pass |
| 155 | 6725 | 41.13 | 41.17 | 320 | Pass |
| 179 | 6845 | 41.15 | 41.11 | 320 | Pass |
| 187 | 6885 | 40.95 | 41.17 | 320 | Pass |
| 211 | 7005 | 41.05 | 41.10 | 320 | Pass |
| 227 | 7085 | 41.10 | 41.19 | 320 | Pass |

802.11ax (HE80)

| Channel | Frequency (MHz) | 26dB Bandwidth (MHz) | | Maximum Limit (MHz) | Test Result |
|---------|-----------------|----------------------|---------|---------------------|-------------|
| | | Chain 0 | Chain 1 | | |
| 7 | 5985 | 83.70 | 83.10 | 320 | Pass |
| 39 | 6145 | 83.95 | 83.61 | 320 | Pass |
| 87 | 6385 | 83.14 | 83.49 | 320 | Pass |
| 103 | 6465 | 83.71 | 83.45 | 320 | Pass |
| 119 | 6545 | 83.82 | 83.53 | 320 | Pass |
| 151 | 6705 | 83.88 | 83.51 | 320 | Pass |
| 183 | 6865 | 83.28 | 83.75 | 320 | Pass |
| 199 | 6945 | 83.85 | 83.44 | 320 | Pass |
| 215 | 7025 | 83.55 | 83.71 | 320 | Pass |

802.11ax (HE160)

| Channel | Frequency (MHz) | 26dB Bandwidth (MHz) | | Maximum Limit (MHz) | Test Result |
|---------|-----------------|----------------------|---------|---------------------|-------------|
| | | Chain 0 | Chain 1 | | |
| 15 | 6025 | 166.07 | 167.33 | 320 | Pass |
| 47 | 6185 | 167.45 | 168.02 | 320 | Pass |
| 79 | 6345 | 167.73 | 167.94 | 320 | Pass |
| 111 | 6505 | 167.94 | 167.10 | 320 | Pass |
| 143 | 6665 | 168.11 | 167.75 | 320 | Pass |
| 175 | 6825 | 168.65 | 167.73 | 320 | Pass |
| 207 | 6985 | 167.97 | 167.12 | 320 | Pass |

802.11ax (HE20) 26-tone RU

| Channel | Frequency (MHz) | 26dB Bandwidth (MHz) | | Maximum Limit (MHz) | Test Result |
|---------|-----------------|----------------------|---------|---------------------|-------------|
| | | Chain 0 | Chain 1 | | |
| 1 | 5955 | 21.32 | 21.17 | 320 | Pass |
| 93 | 6415 | 21.20 | 20.87 | 320 | Pass |
| 97 | 6435 | 21.52 | 21.27 | 320 | Pass |
| 117 | 6535 | 20.98 | 20.86 | 320 | Pass |
| 181 | 6855 | 21.55 | 21.19 | 320 | Pass |
| 233 | 7115 | 21.07 | 20.96 | 320 | Pass |

802.11ax (HE20) 52-tone RU

| Channel | Frequency (MHz) | 26dB Bandwidth (MHz) | | Maximum Limit (MHz) | Test Result |
|---------|-----------------|----------------------|---------|---------------------|-------------|
| | | Chain 0 | Chain 1 | | |
| 1 | 5955 | 21.19 | 21.12 | 320 | Pass |
| 93 | 6415 | 20.96 | 20.98 | 320 | Pass |
| 97 | 6435 | 21.50 | 21.28 | 320 | Pass |
| 117 | 6535 | 20.89 | 21.20 | 320 | Pass |
| 181 | 6855 | 21.61 | 21.35 | 320 | Pass |
| 233 | 7115 | 21.39 | 21.09 | 320 | Pass |

802.11ax (HE20) 106-tone RU

| Channel | Frequency (MHz) | 26dB Bandwidth (MHz) | | Maximum Limit (MHz) | Test Result |
|---------|-----------------|----------------------|---------|---------------------|-------------|
| | | Chain 0 | Chain 1 | | |
| 1 | 5955 | 22.35 | 21.71 | 320 | Pass |
| 93 | 6415 | 21.89 | 21.53 | 320 | Pass |
| 97 | 6435 | 22.07 | 22.39 | 320 | Pass |
| 117 | 6535 | 21.47 | 21.44 | 320 | Pass |
| 181 | 6855 | 22.11 | 22.03 | 320 | Pass |
| 233 | 7115 | 21.47 | 21.37 | 320 | Pass |

802.11ax (HE40) 242-tone RU

| Channel | Frequency (MHz) | 26dB Bandwidth (MHz) | | Maximum Limit (MHz) | Test Result |
|---------|-----------------|----------------------|---------|---------------------|-------------|
| | | Chain 0 | Chain 1 | | |
| 3 | 5965 | 43.09 | 44.62 | 320 | Pass |
| 91 | 6405 | 42.88 | 43.22 | 320 | Pass |
| 99 | 6445 | 42.67 | 44.89 | 320 | Pass |
| 115 | 6525 | 42.97 | 43.26 | 320 | Pass |
| 123 | 6565 | 43.05 | 44.83 | 320 | Pass |
| 179 | 6845 | 43.01 | 43.03 | 320 | Pass |
| 187 | 6885 | 43.25 | 44.92 | 320 | Pass |
| 227 | 7085 | 43.18 | 43.10 | 320 | Pass |

802.11ax (HE80) 484-tone RU

| Channel | Frequency (MHz) | 26dB Bandwidth (MHz) | | Maximum Limit (MHz) | Test Result |
|---------|-----------------|----------------------|---------|---------------------|-------------|
| | | Chain 0 | Chain 1 | | |
| 7 | 5985 | 88.30 | 85.87 | 320 | Pass |
| 87 | 6385 | 86.76 | 86.32 | 320 | Pass |
| 103 | 6465 | 89.16 | 87.08 | 320 | Pass |
| 119 | 6545 | 85.63 | 84.86 | 320 | Pass |
| 151 | 6705 | 88.28 | 86.22 | 320 | Pass |
| 183 | 6865 | 88.05 | 87.34 | 320 | Pass |
| 199 | 6945 | 86.71 | 88.52 | 320 | Pass |
| 215 | 7025 | 86.20 | 85.36 | 320 | Pass |

802.11ax (HE160) 996-tone RU

| Channel | Frequency (MHz) | 26dB Bandwidth (MHz) | | Maximum Limit (MHz) | Test Result |
|---------|-----------------|----------------------|---------|---------------------|-------------|
| | | Chain 0 | Chain 1 | | |
| 15 | 6025 | 172.29 | 171.12 | 320 | Pass |
| 79 | 6345 | 172.52 | 172.09 | 320 | Pass |
| 111 | 6505 | 172.73 | 172.47 | 320 | Pass |
| 143 | 6665 | 172.39 | 171.92 | 320 | Pass |
| 175 | 6825 | 172.94 | 171.11 | 320 | Pass |
| 207 | 6985 | 172.56 | 171.84 | 320 | Pass |



Spectrum Plot of Maximum Value

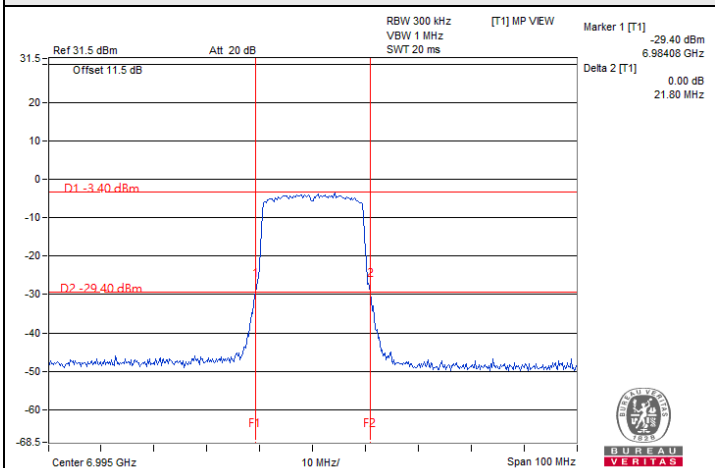

802.11a / Chain 1 : CH 209

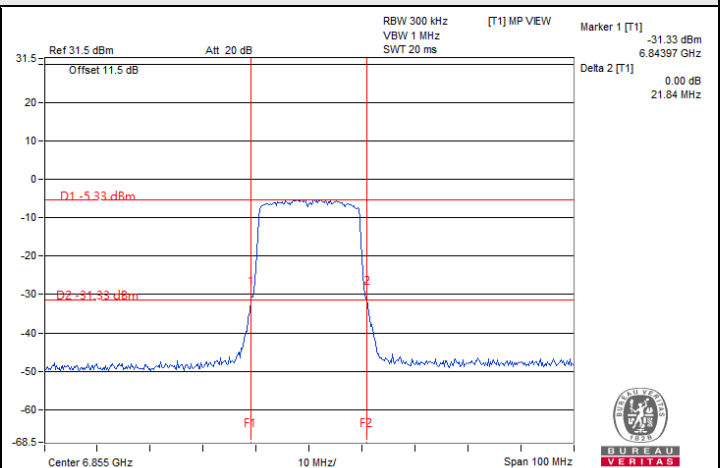

802.11ax (HE20) / Chain 1 : CH 181

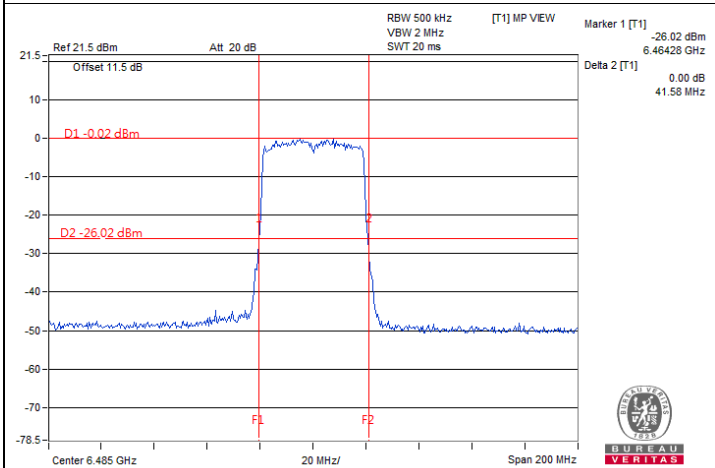

802.11ax (HE40) / Chain 0 : CH 107

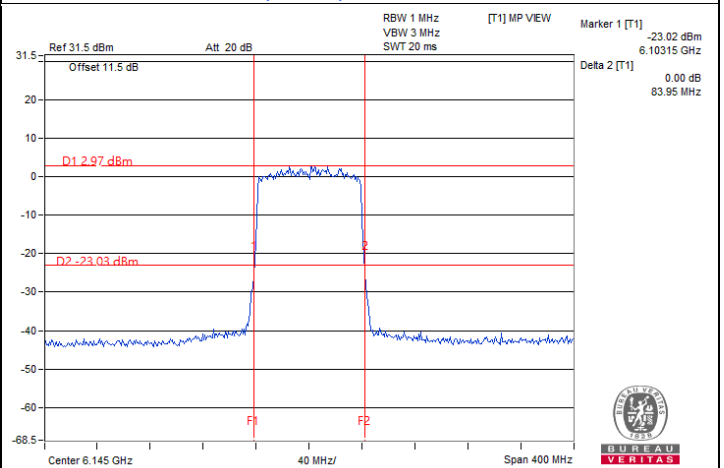

802.11ax (HE80) / Chain 0 : CH 39

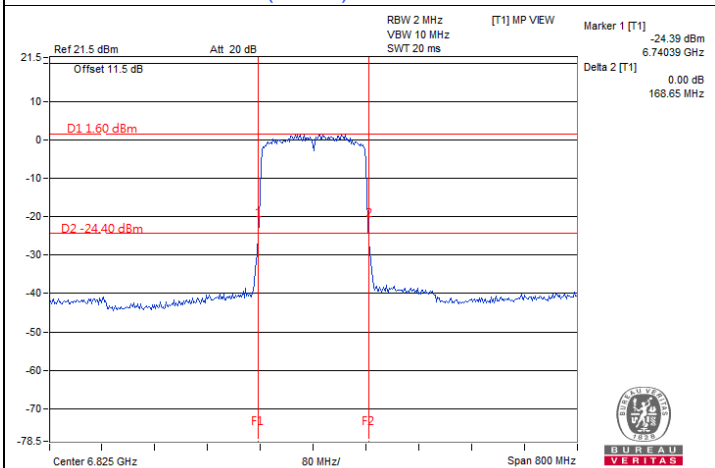

802.11ax (HE160) / Chain 0 : CH 175

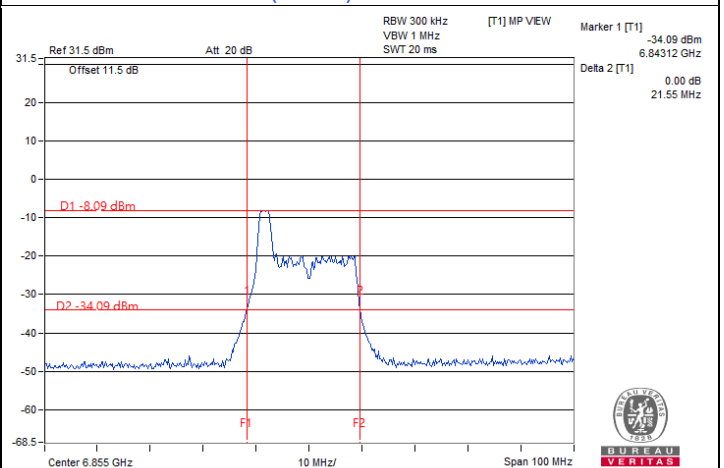

802.11ax (HE20) 26-tone RU / Chain 0 : CH 181@8



Spectrum Plot of Maximum Value

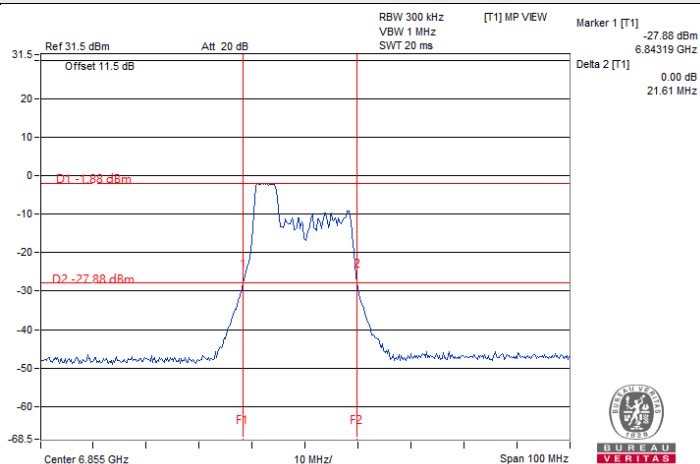

802.11ax (HE20) 52-tone RU / Chain 0 : CH 181@40

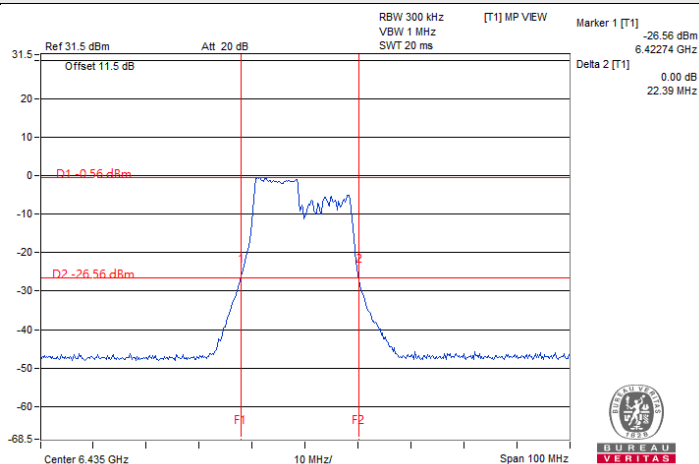

802.11ax (HE20) 106-tone RU / Chain 1 : CH 97@53

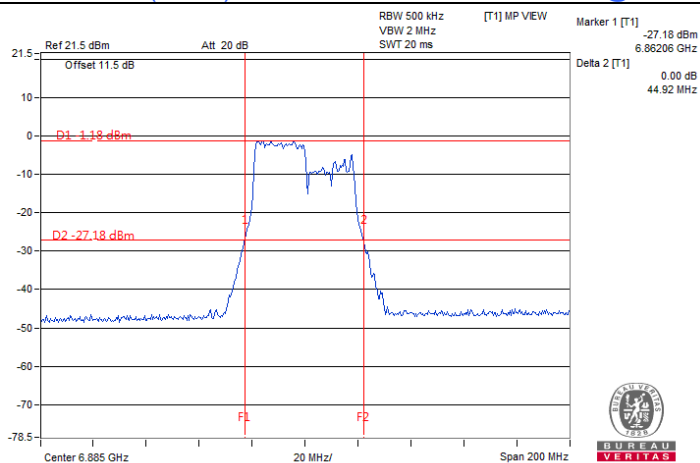

802.11ax (HE40) 242-tone RU / Chain 1 : CH 187@61

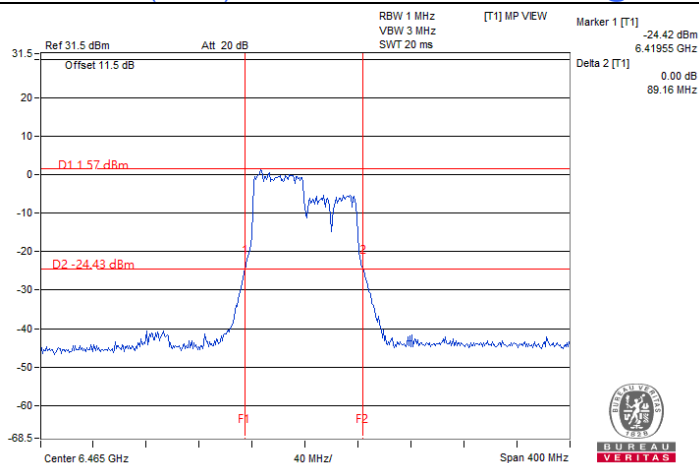

802.11ax (HE80) 484-tone RU / Chain 0 : CH 103@65

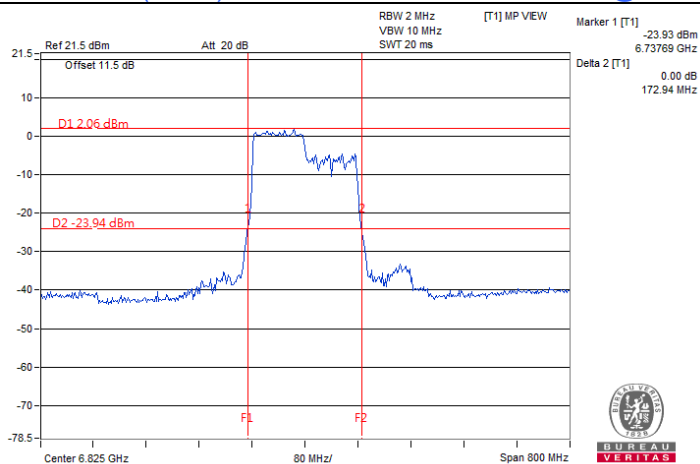

802.11ax (HE160) 996-tone RU / Chain 0 : CH 175@67

7.4 In-Band Emission Mask

| | | | | | |
|--------------|----------------|---------------------------|--------------|------------|-----------------------|
| Input Power: | 120 Vac, 60 Hz | Environmental Conditions: | 25°C, 60% RH | Tested By: | Harry Hsueh / Alan Wu |
|--------------|----------------|---------------------------|--------------|------------|-----------------------|

802.11a

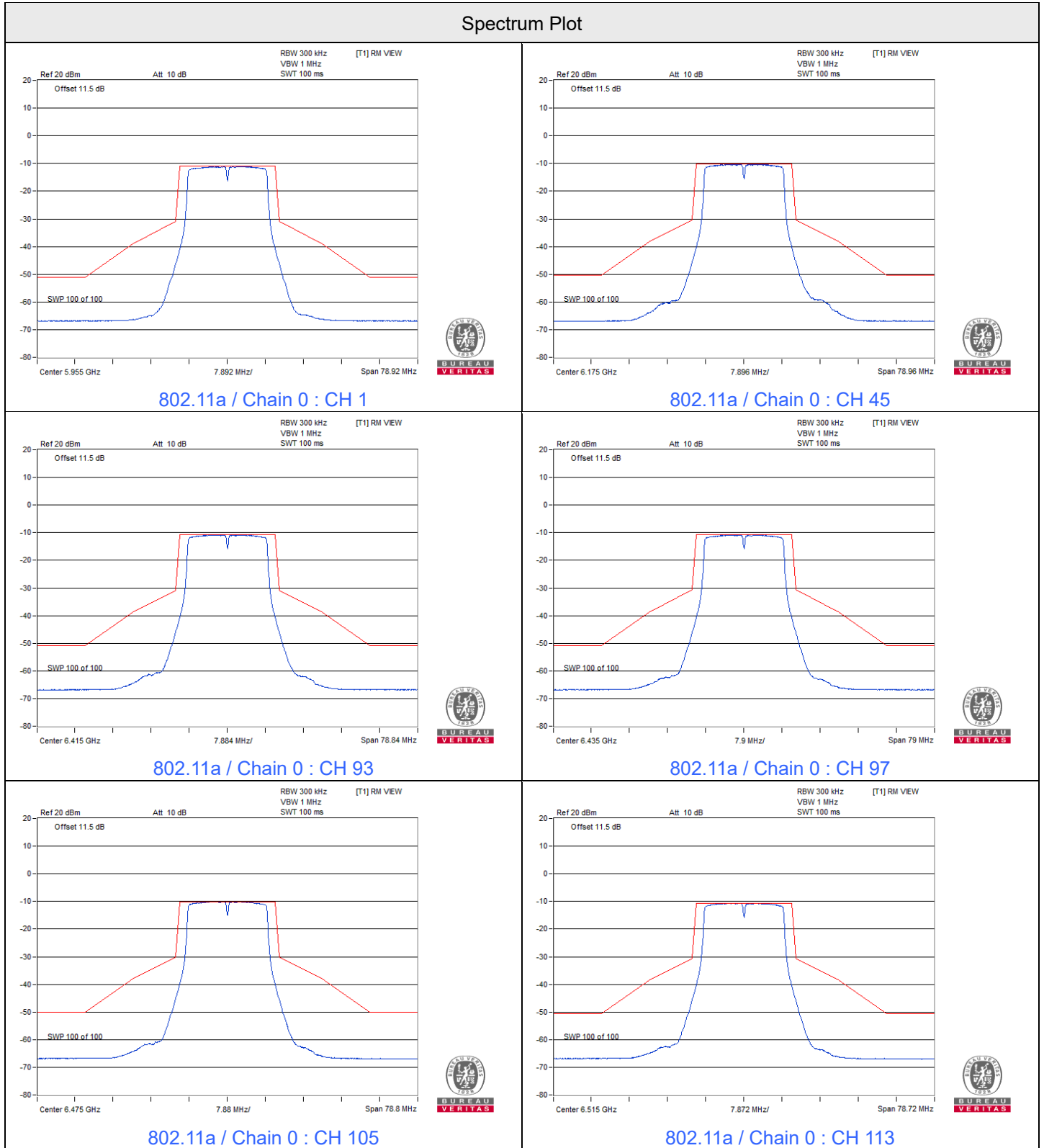

Spectrum Plot

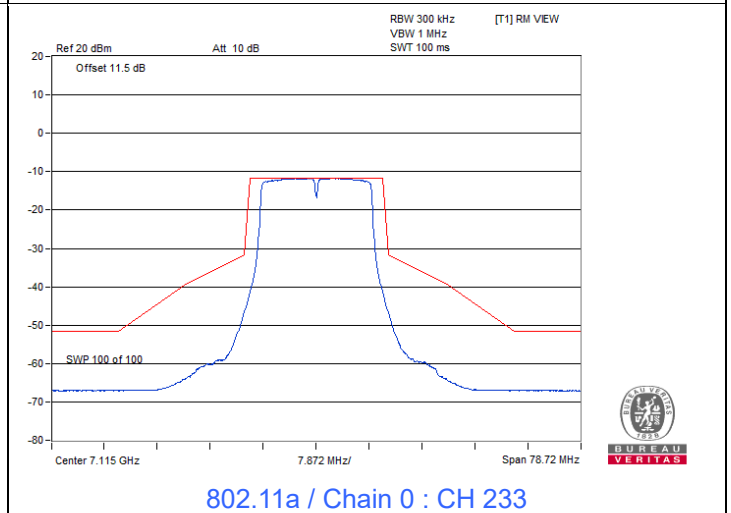
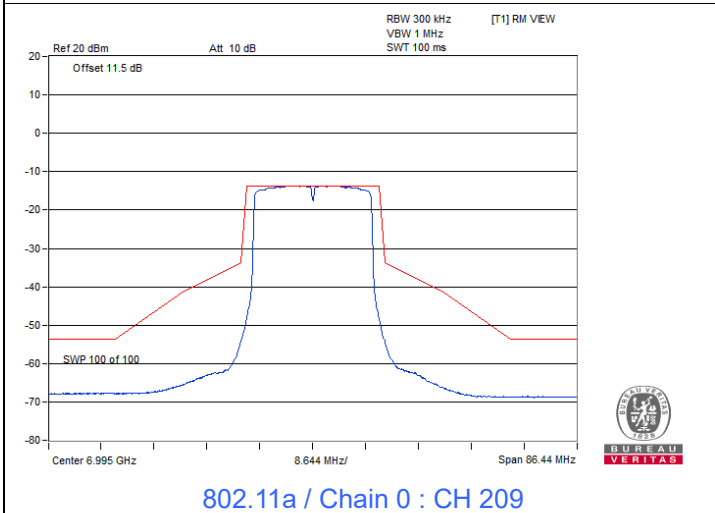
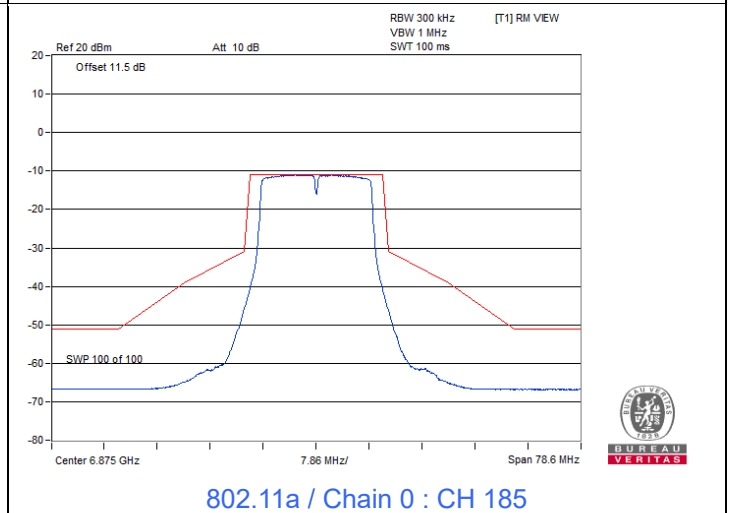
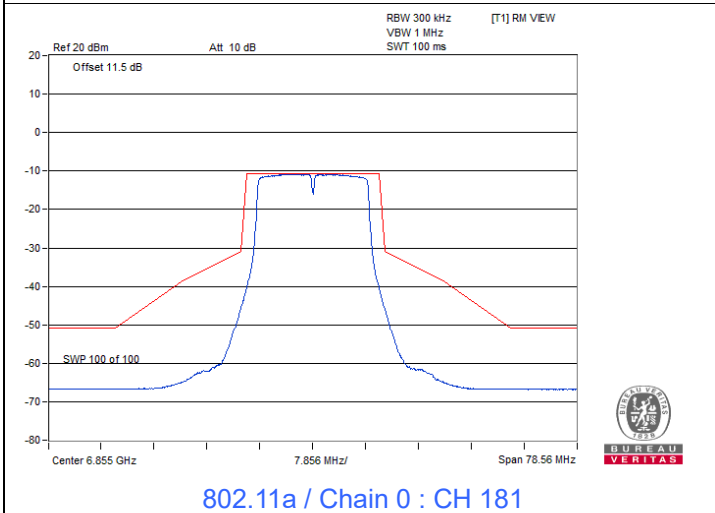
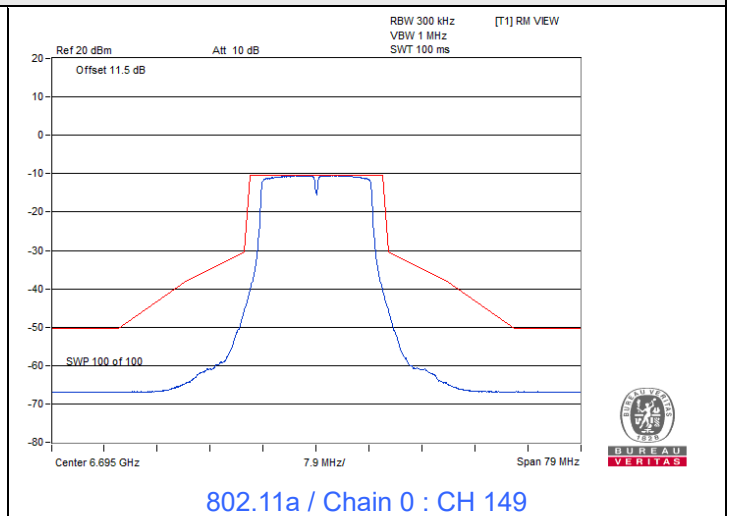
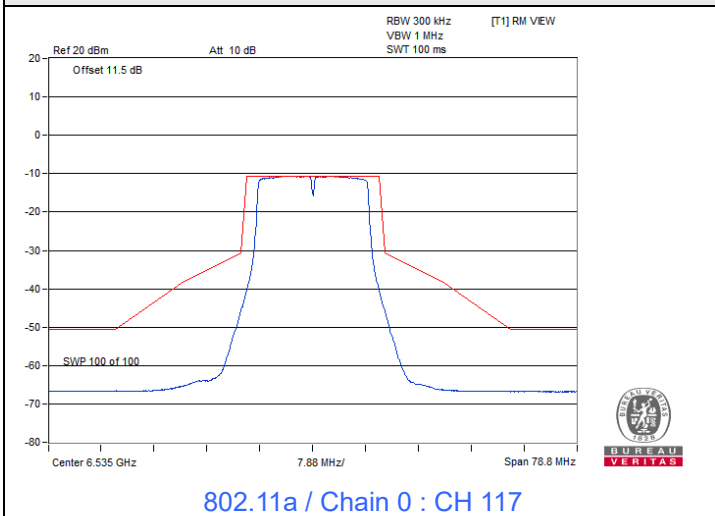

Spectrum Plot

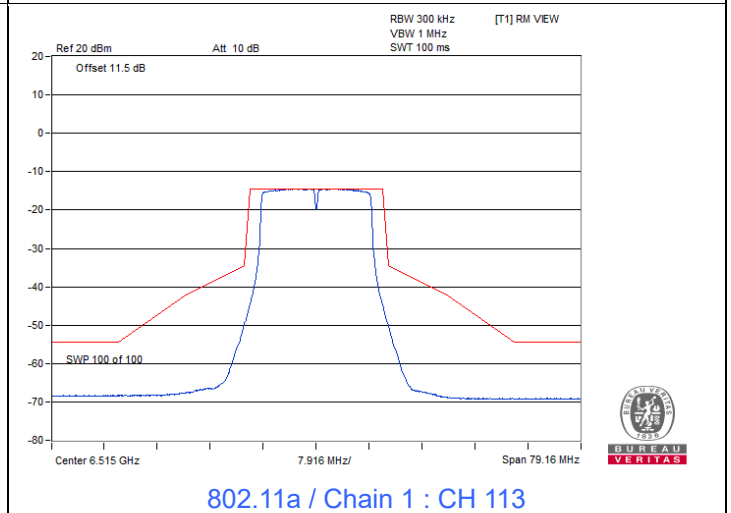
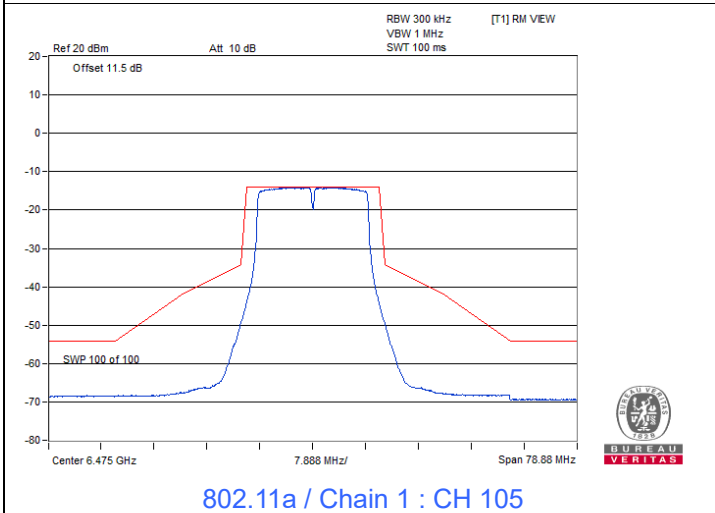
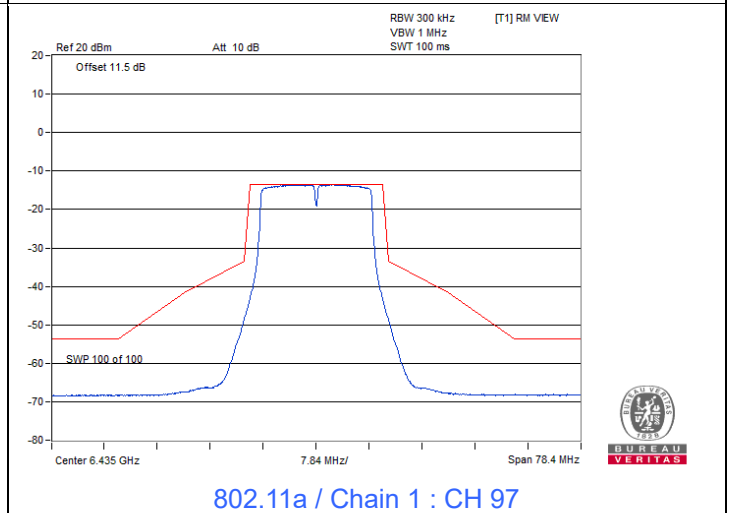
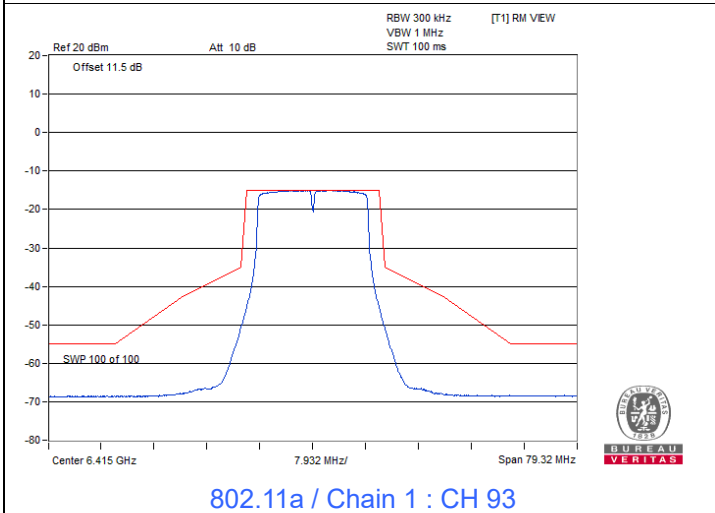
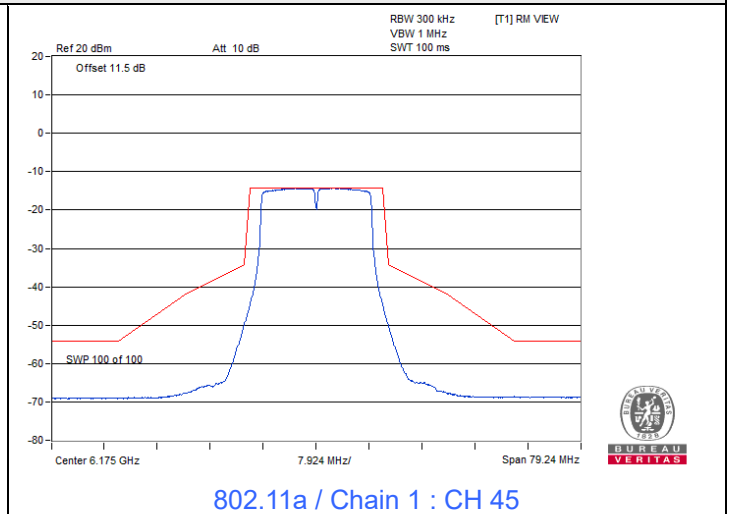
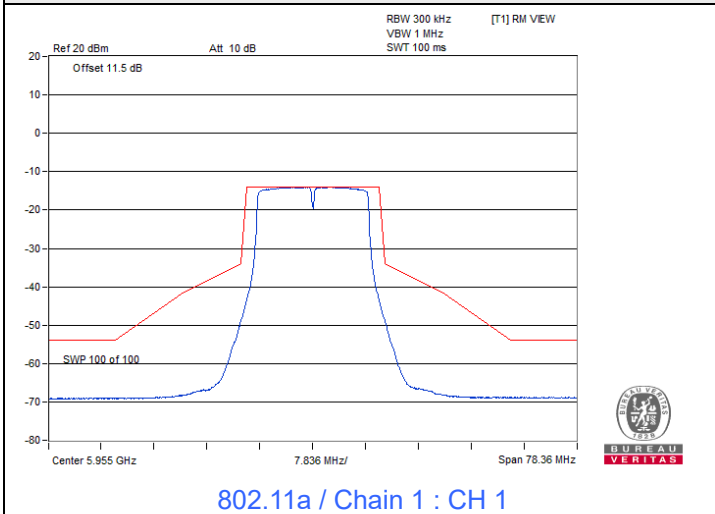

Spectrum Plot

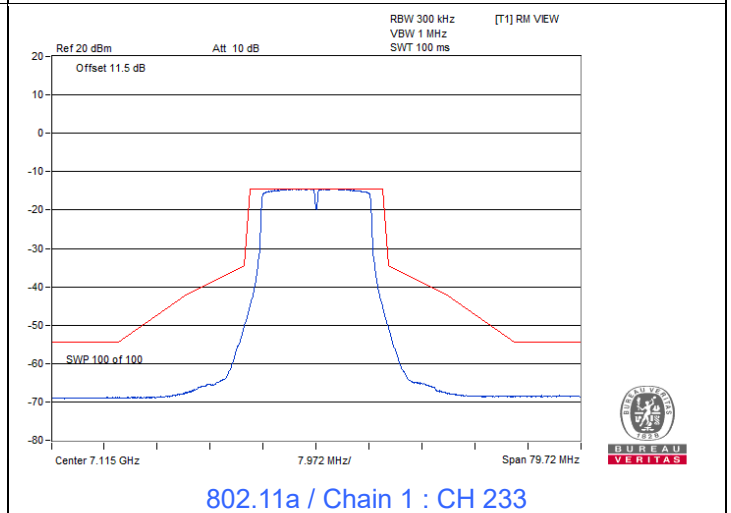
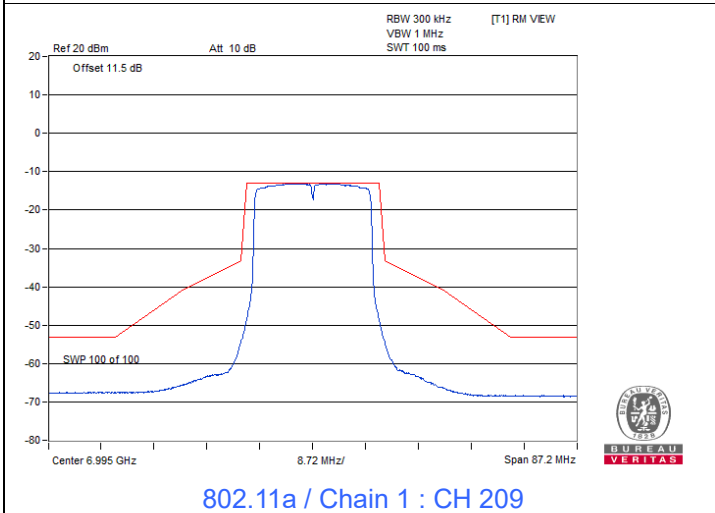
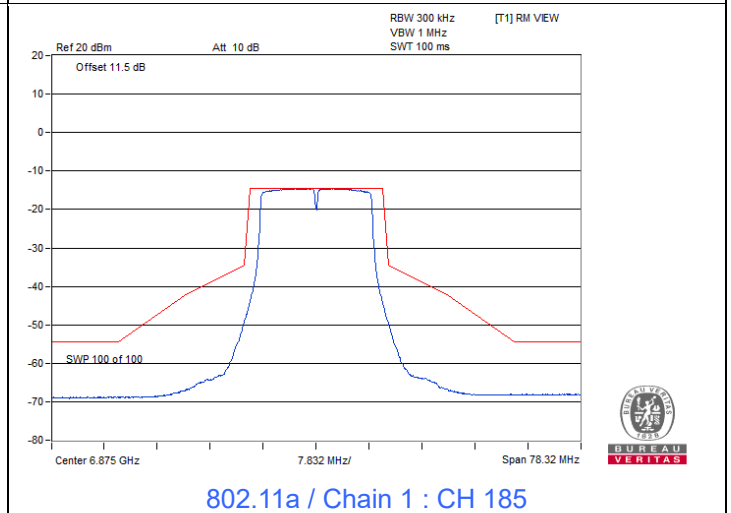
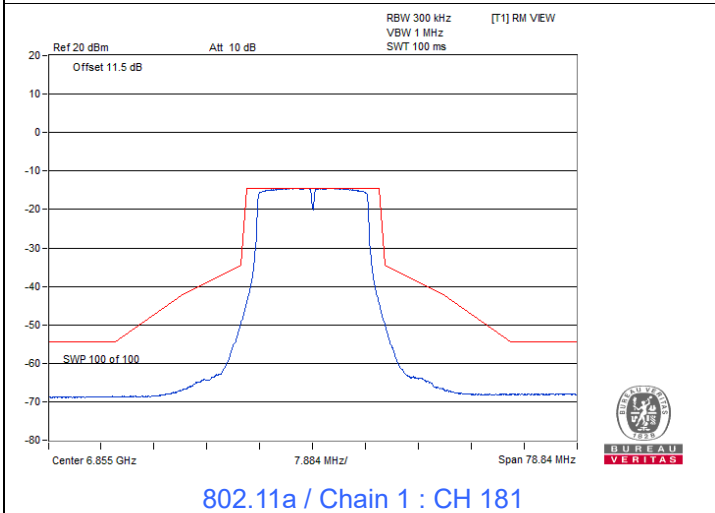
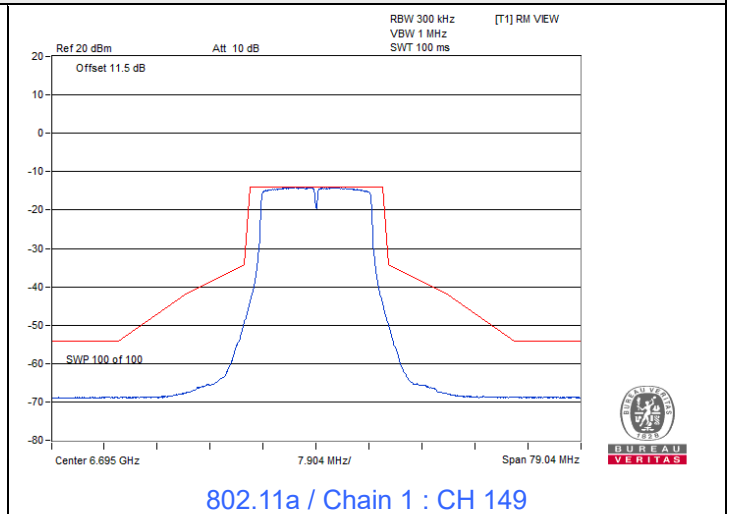
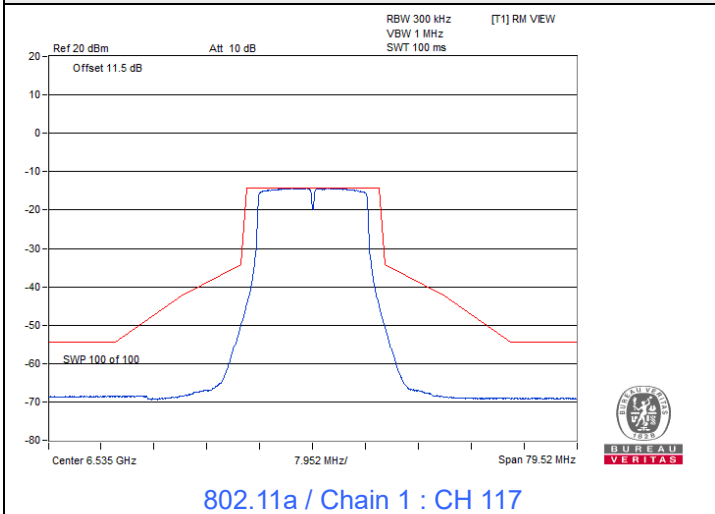

802.11ax (HE20)

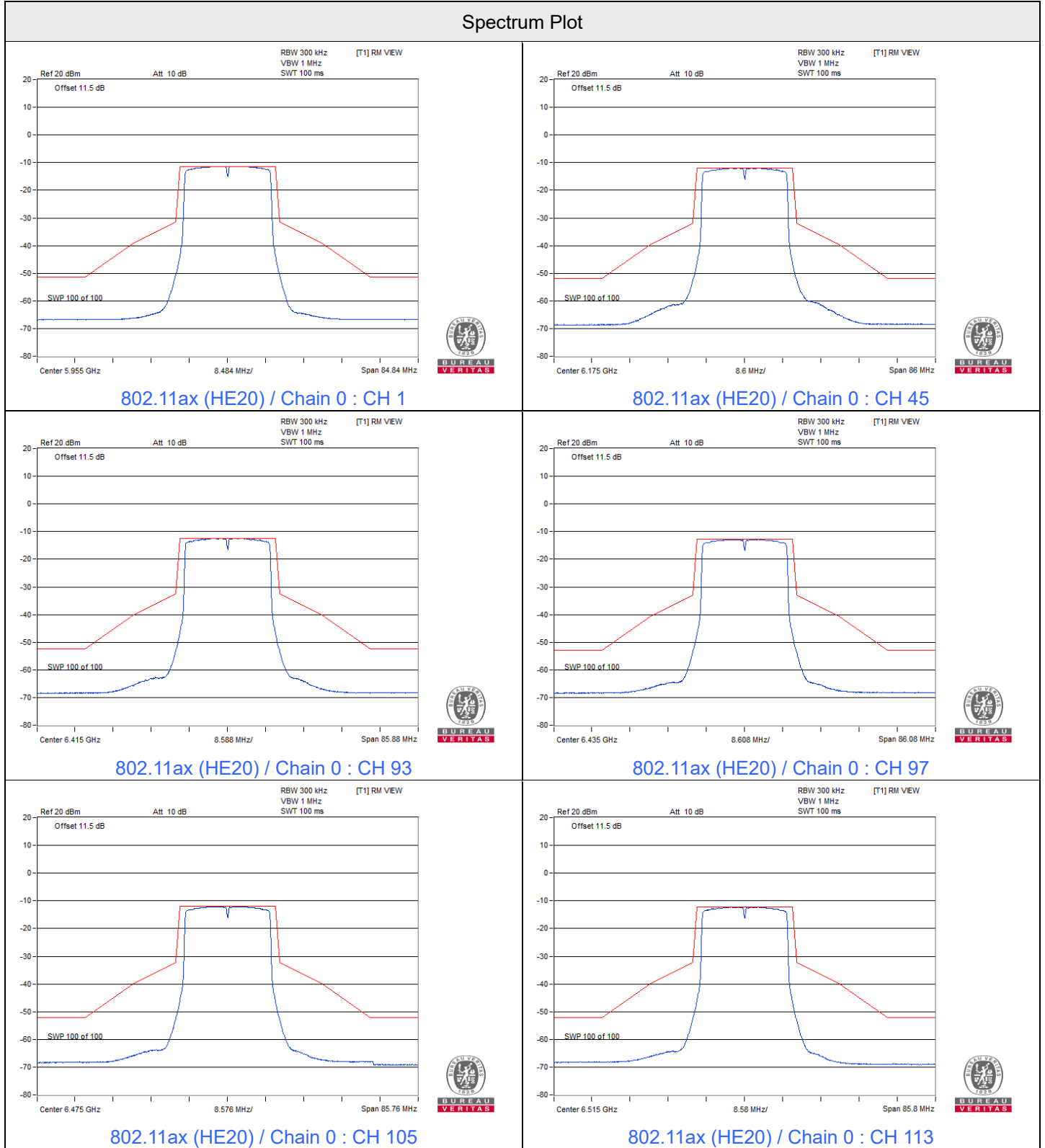

Spectrum Plot

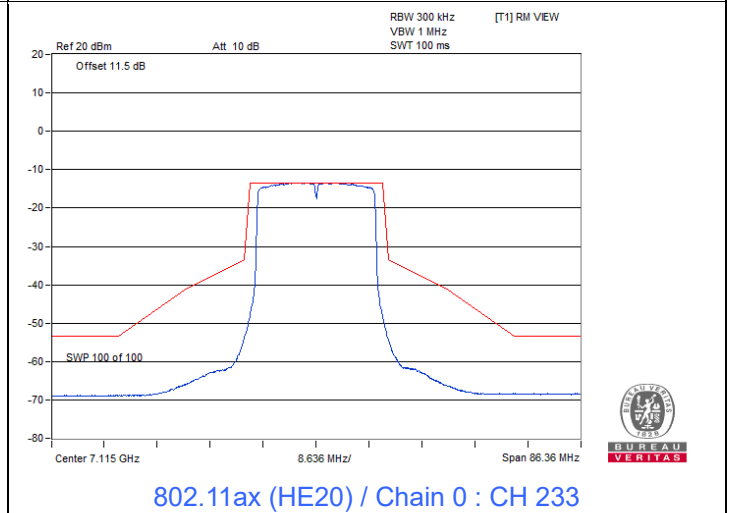
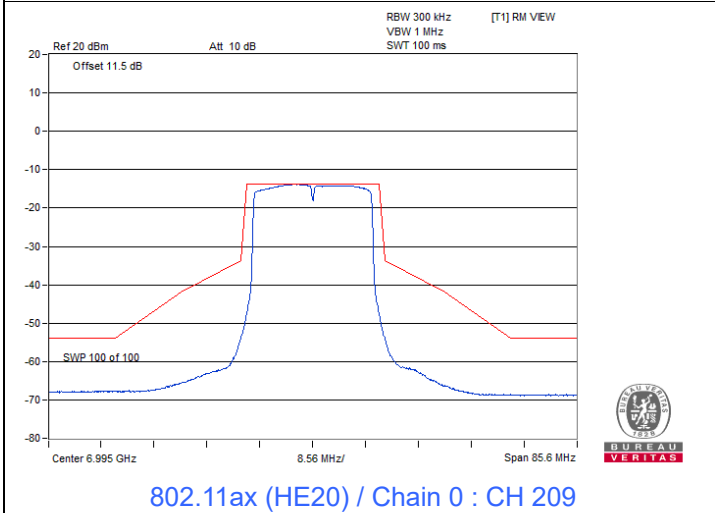
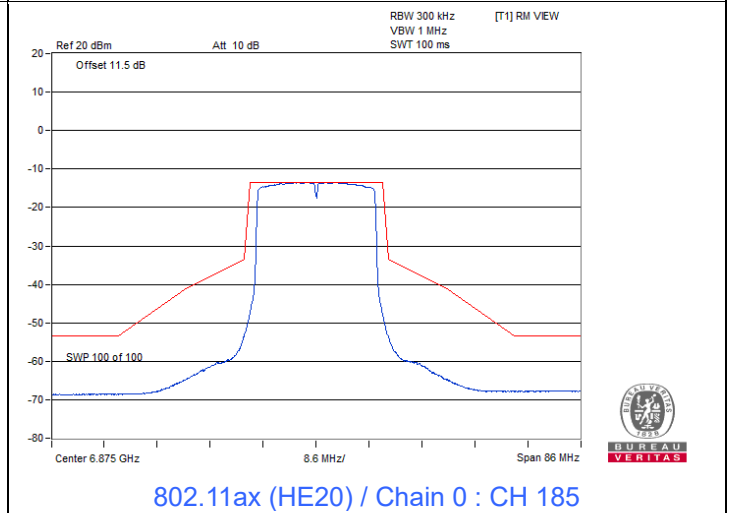
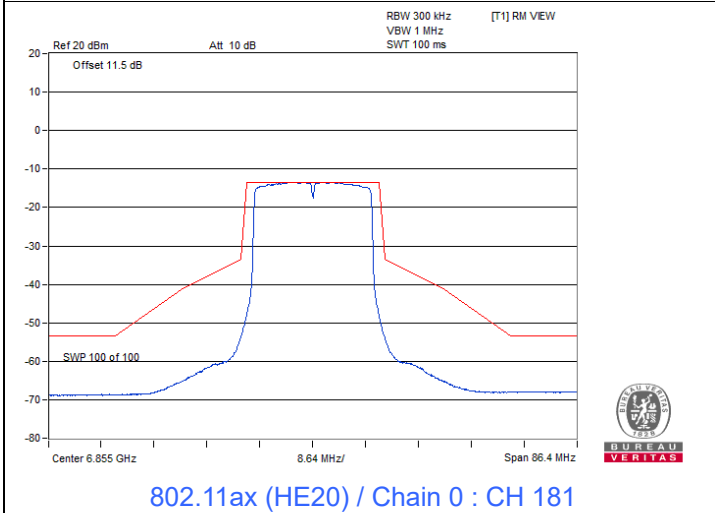
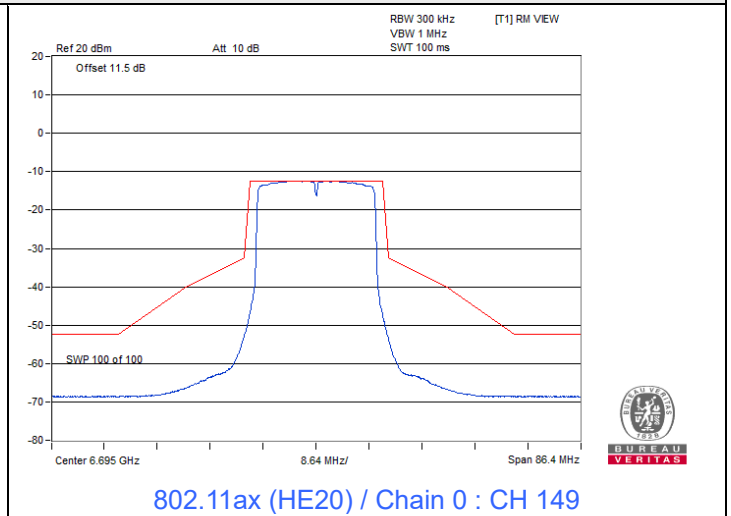
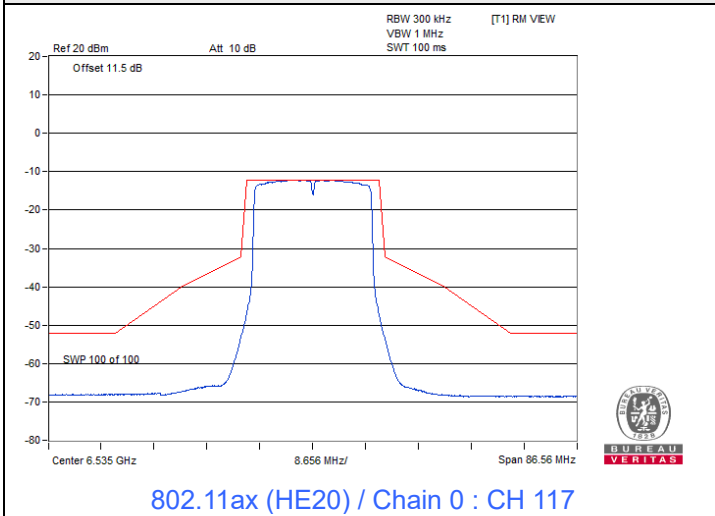

Spectrum Plot

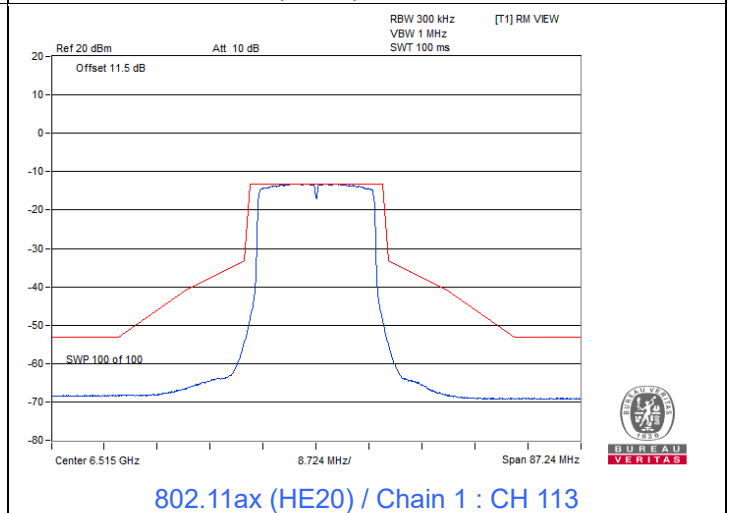
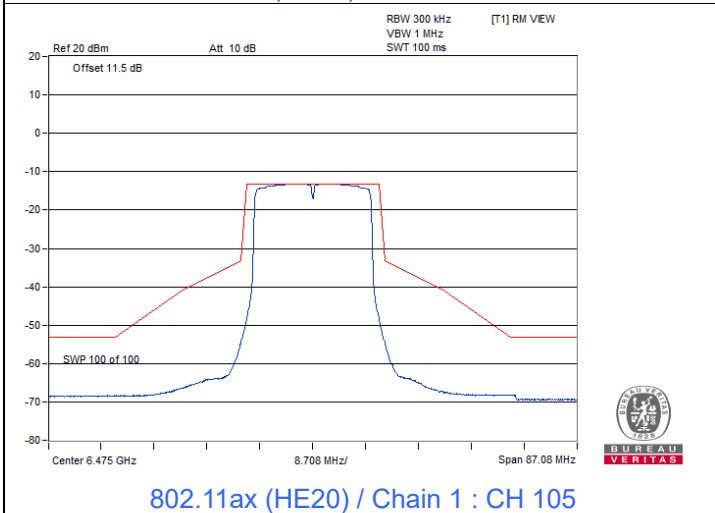
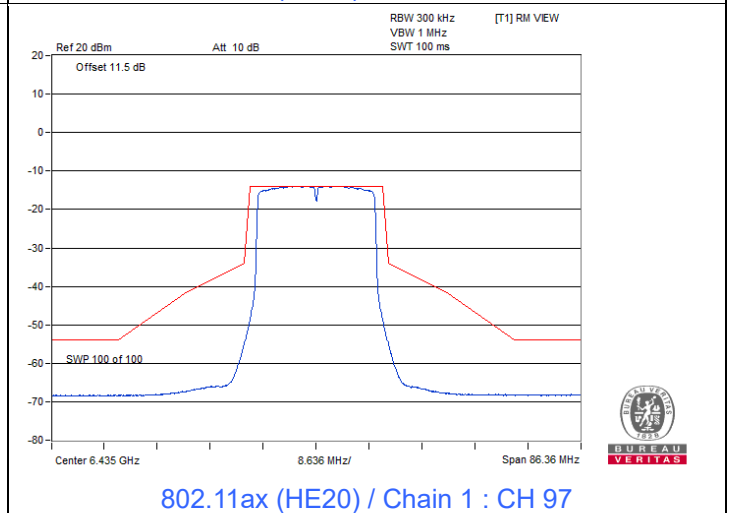
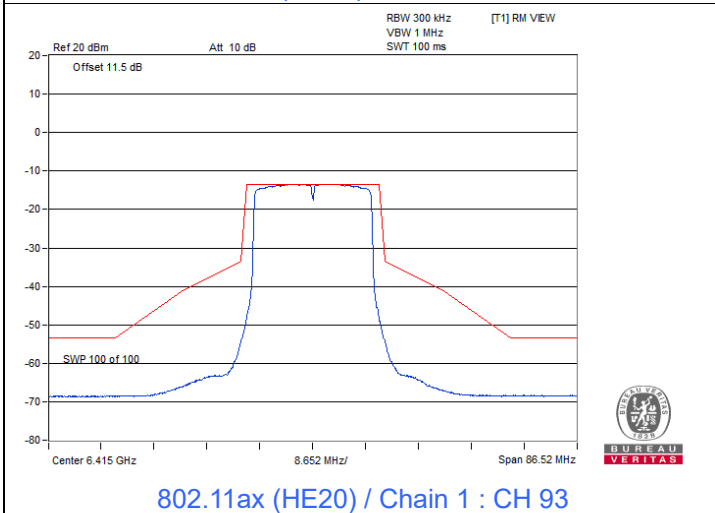
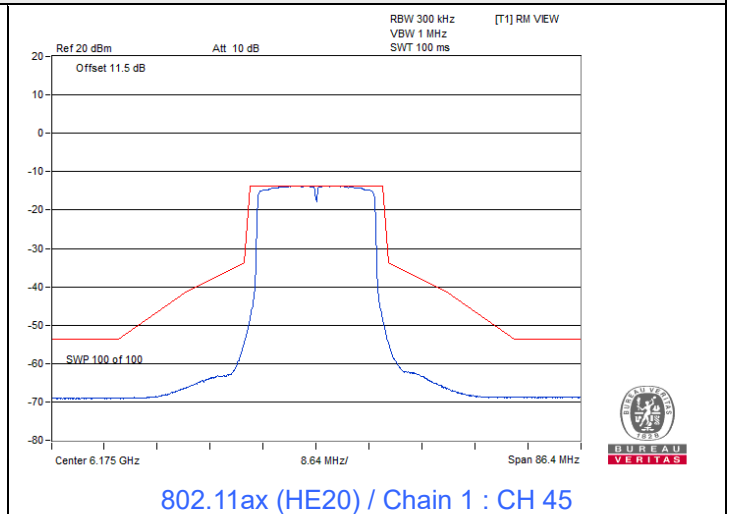
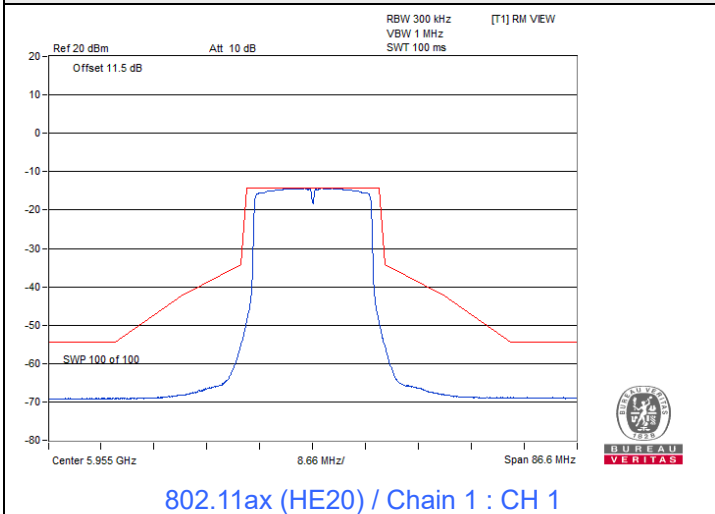

Spectrum Plot

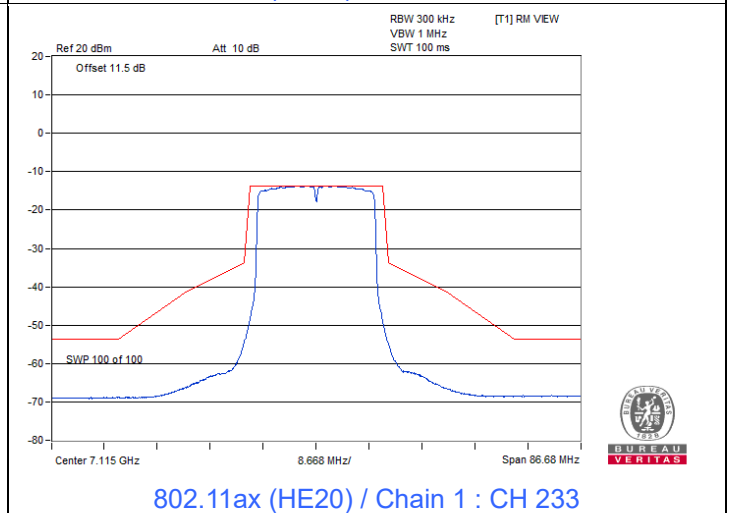
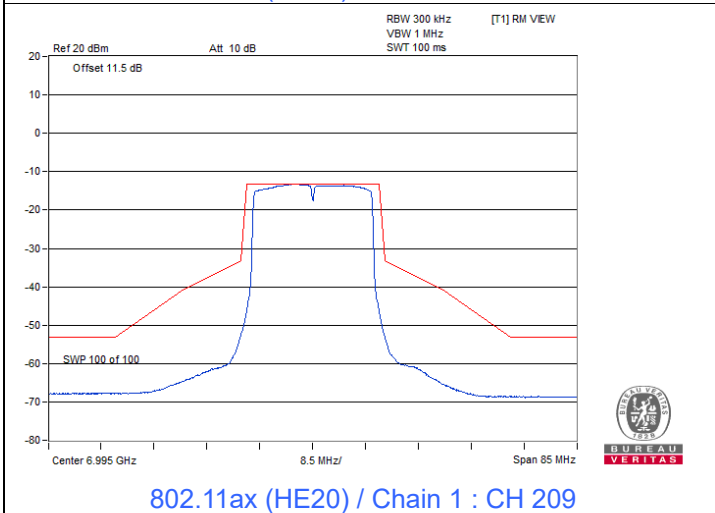
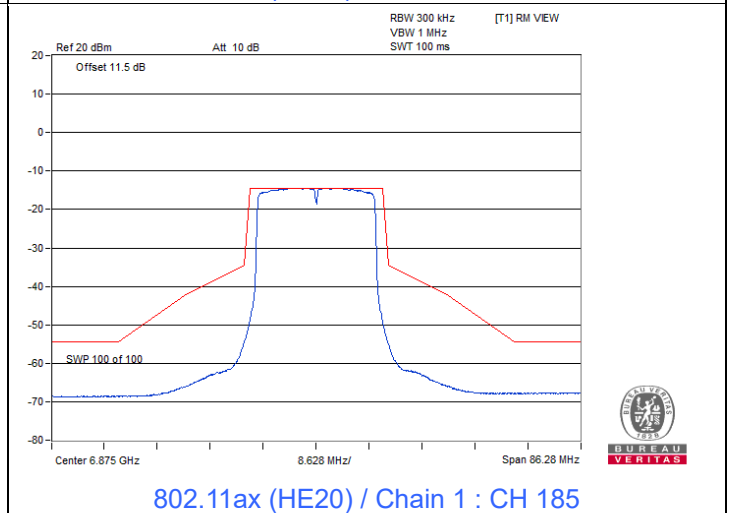
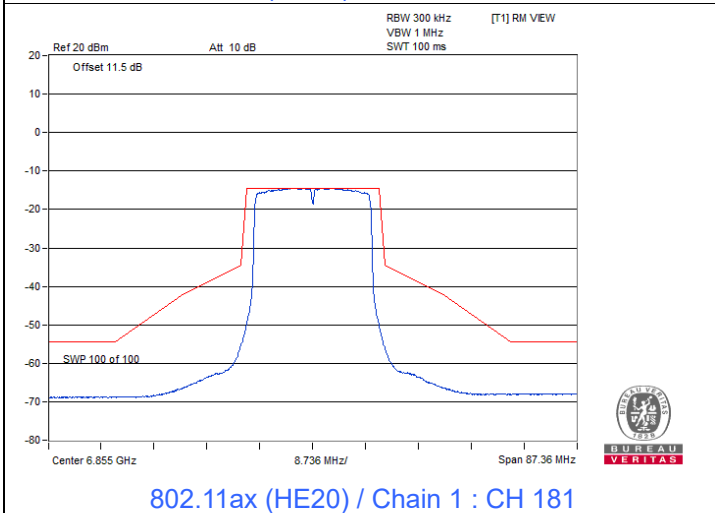
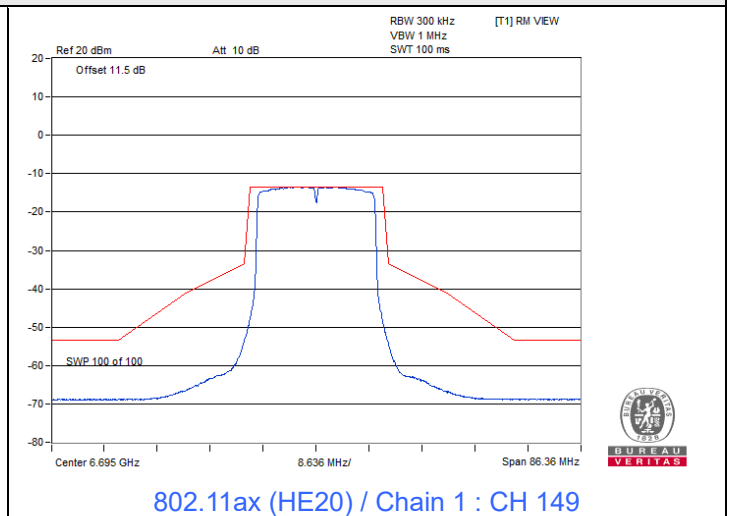
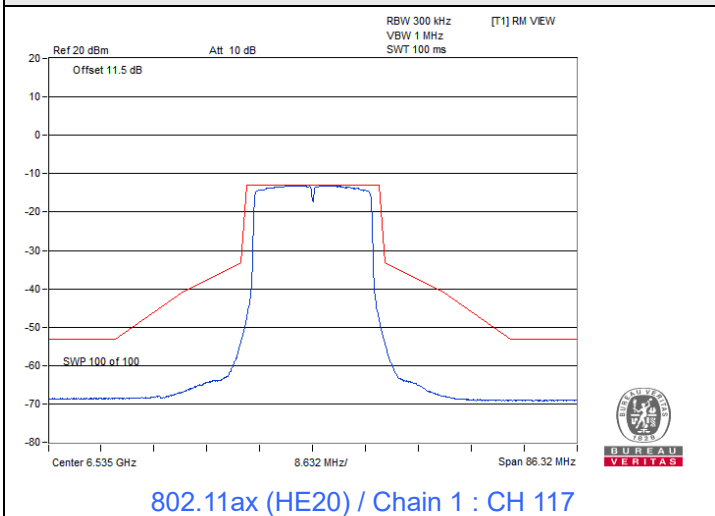



802.11ax (HE40)

Spectrum Plot

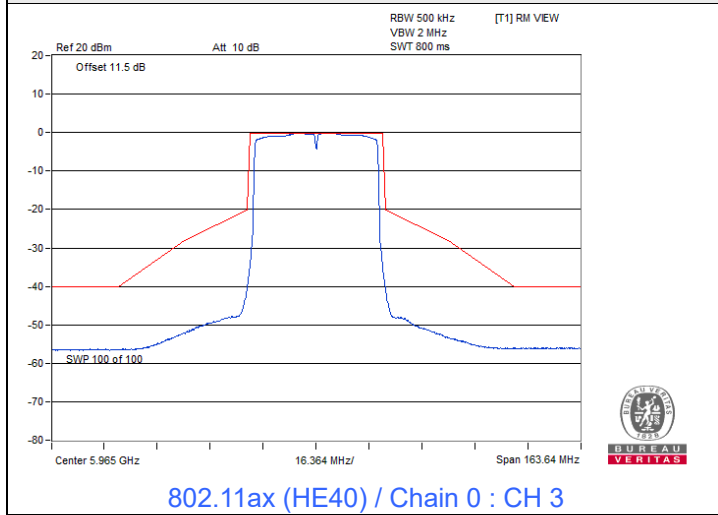

802.11ax (HE40) / Chain 0 : CH 3

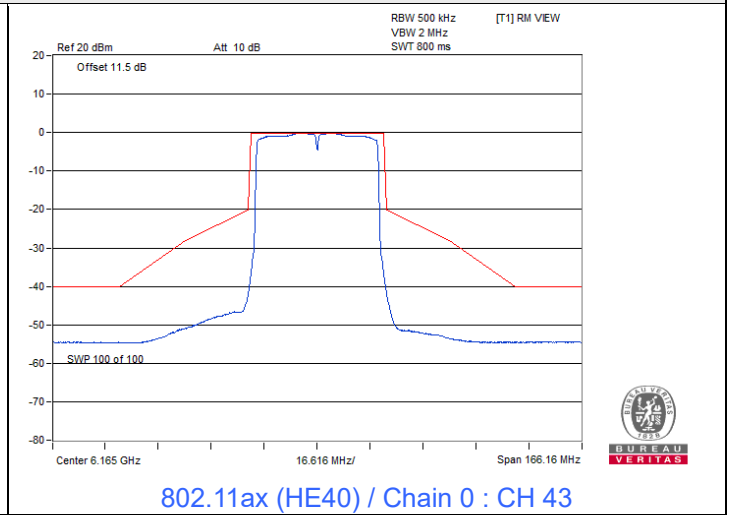

802.11ax (HE40) / Chain 0 : CH 43

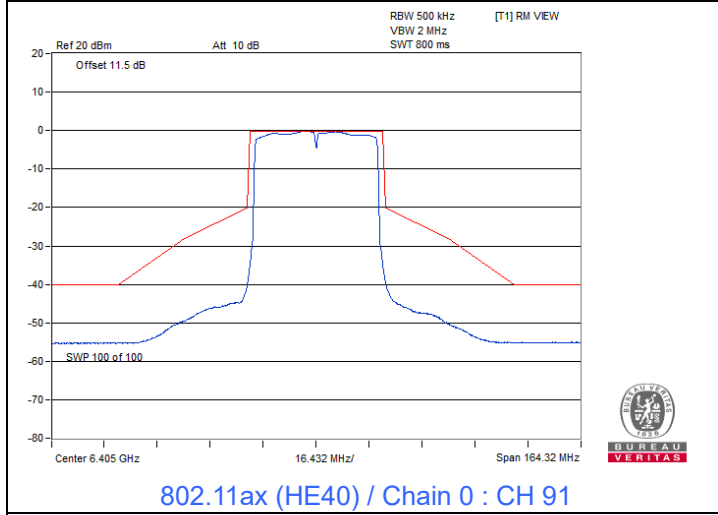

802.11ax (HE40) / Chain 0 : CH 91

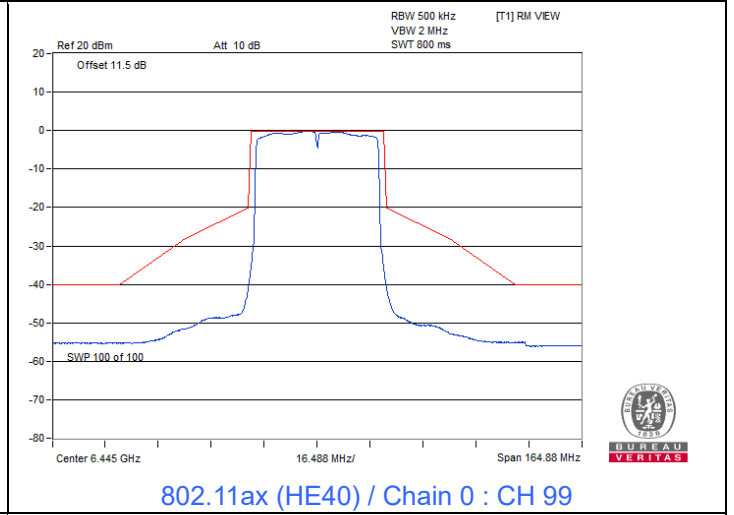

802.11ax (HE40) / Chain 0 : CH 99

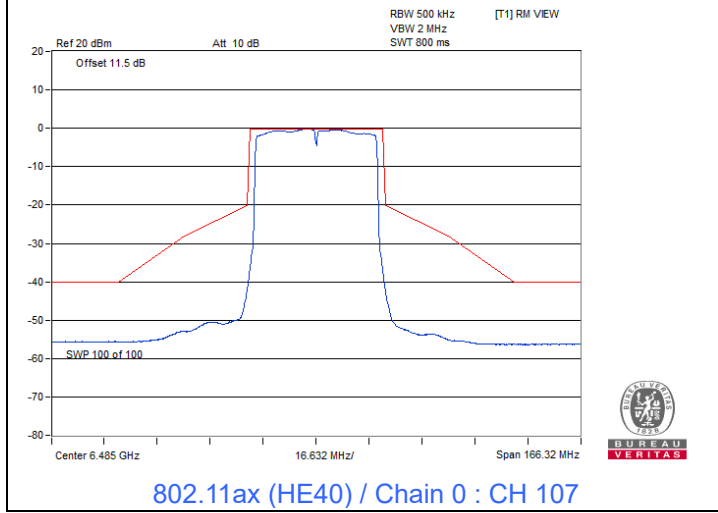

802.11ax (HE40) / Chain 0 : CH 107

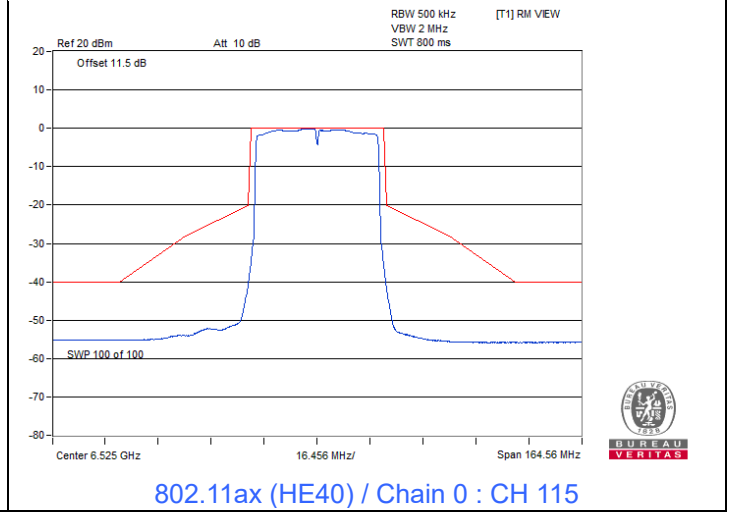

802.11ax (HE40) / Chain 0 : CH 115

Spectrum Plot

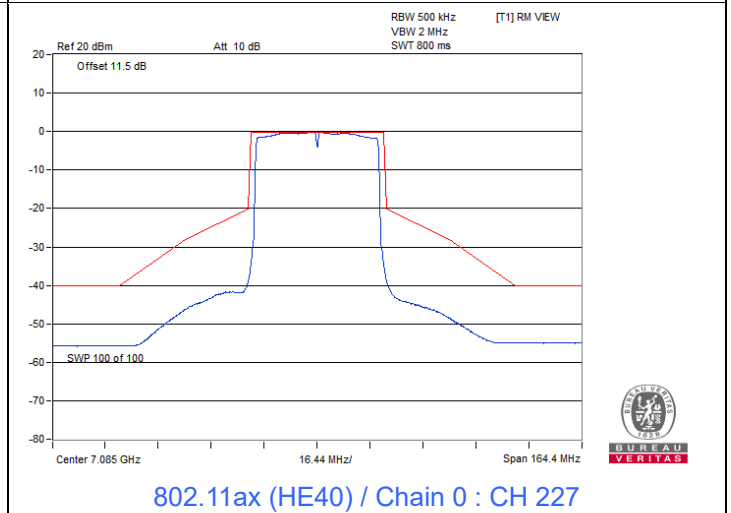
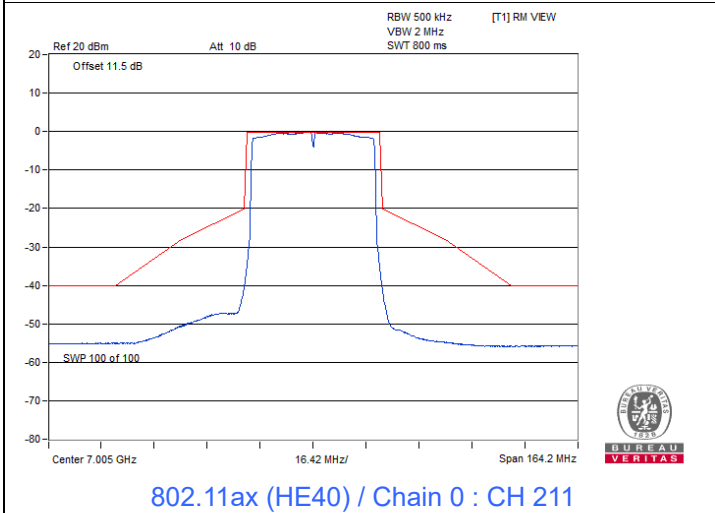
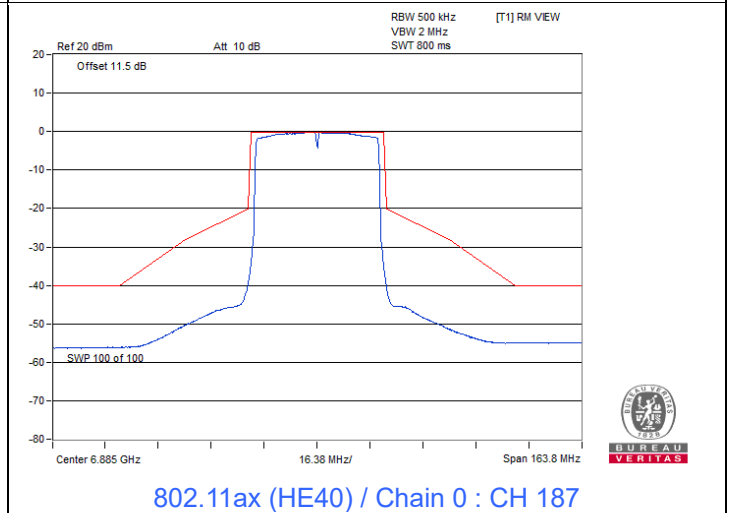
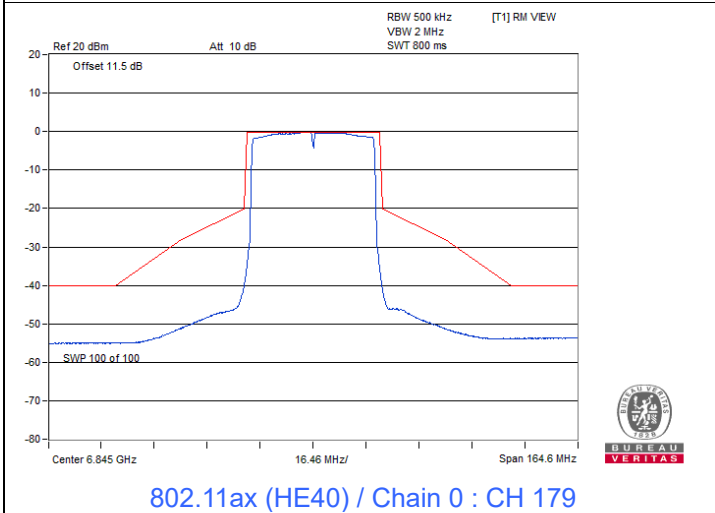
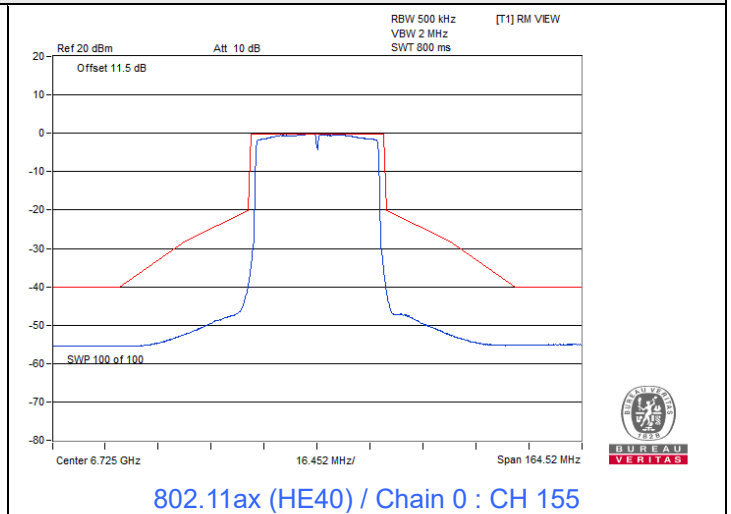
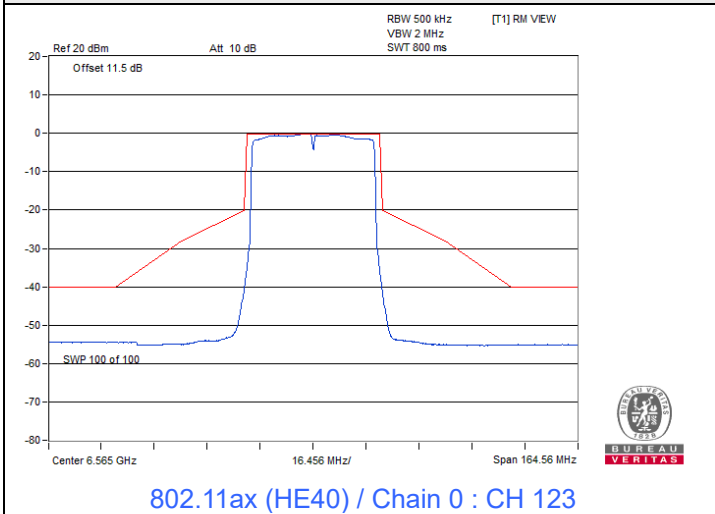

Spectrum Plot

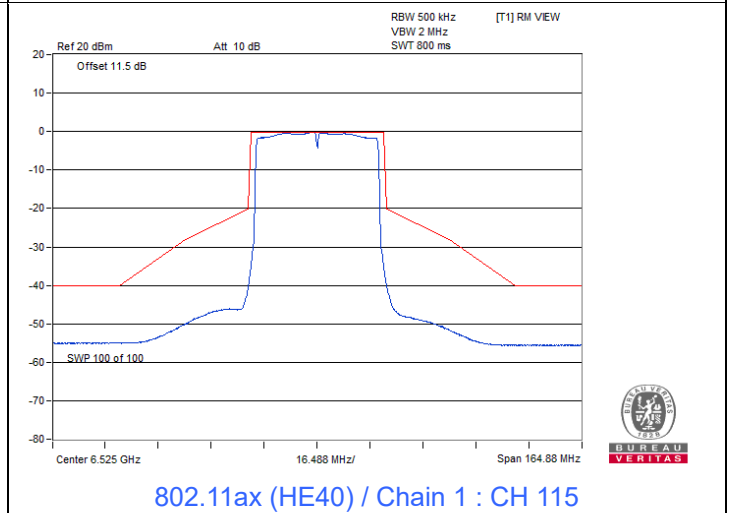
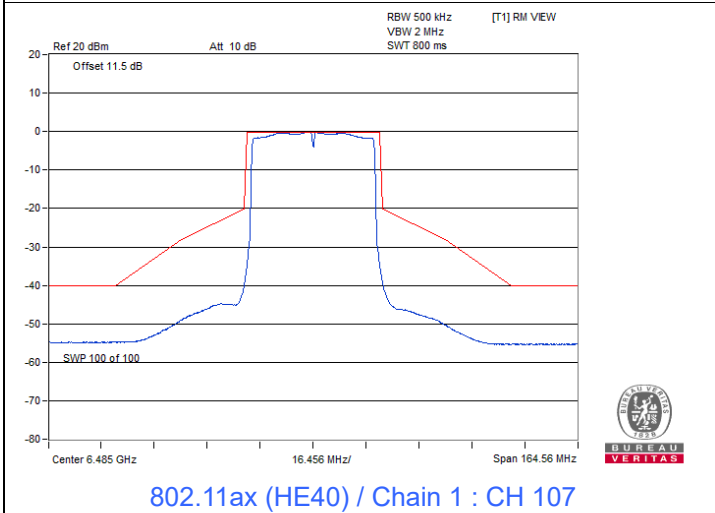
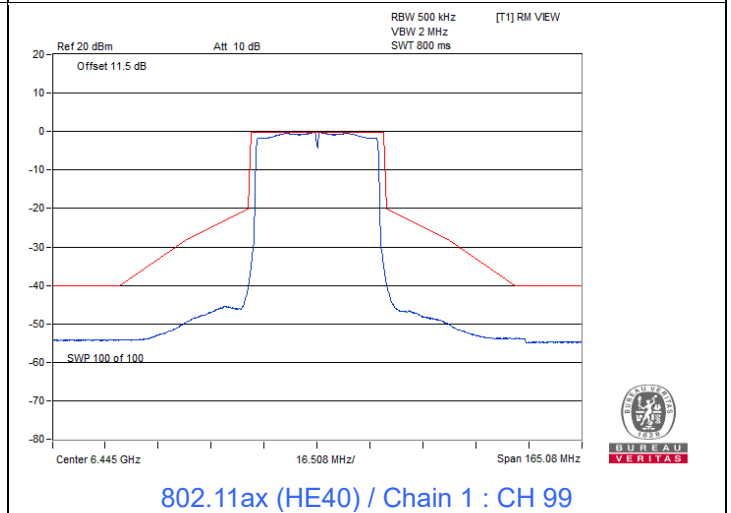
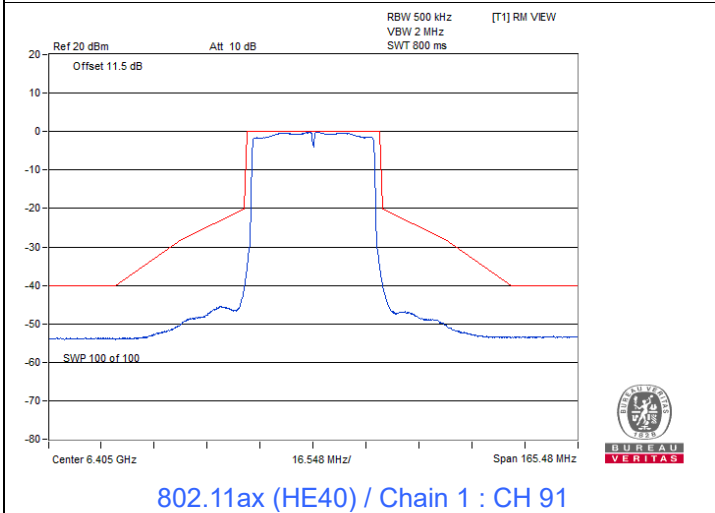
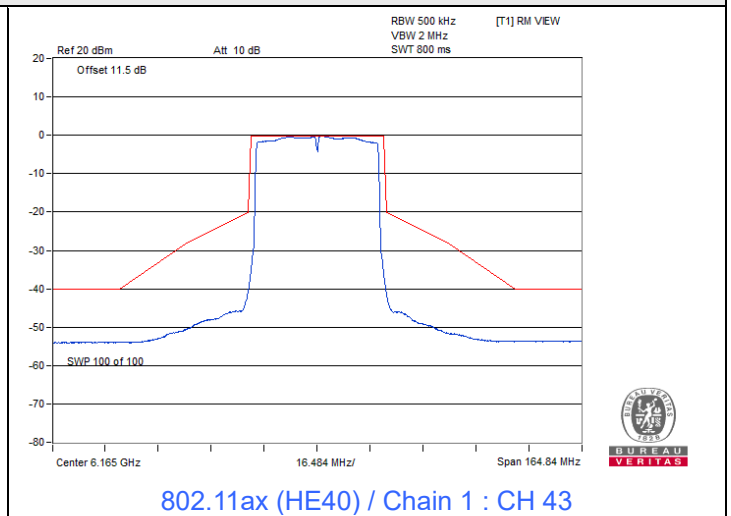
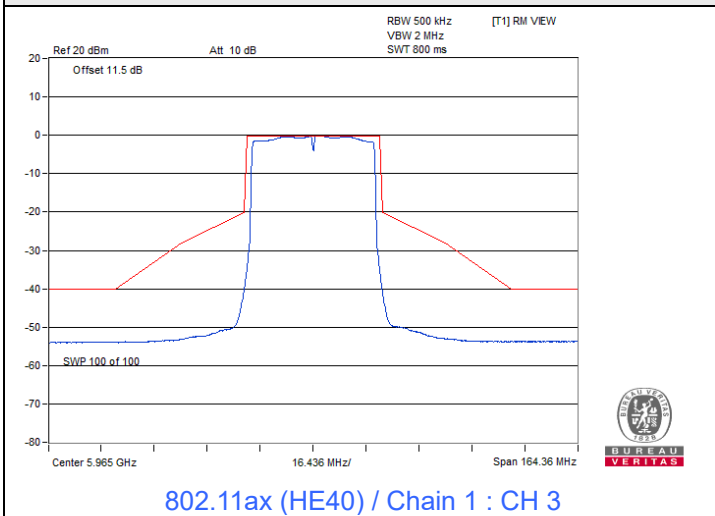

Spectrum Plot

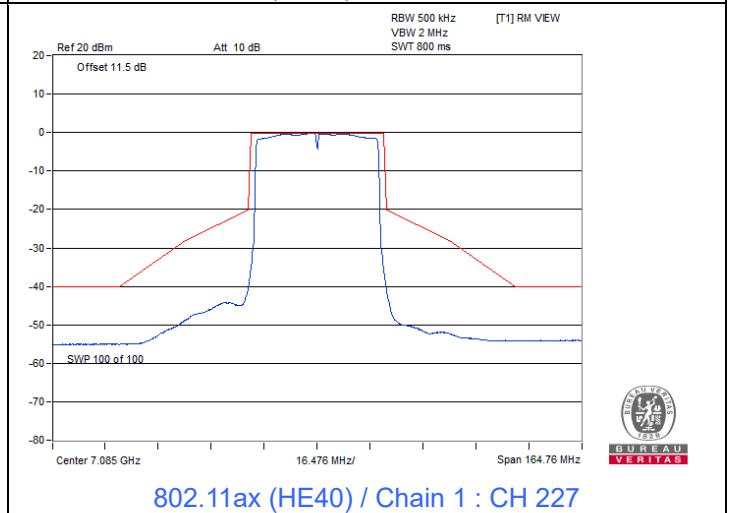
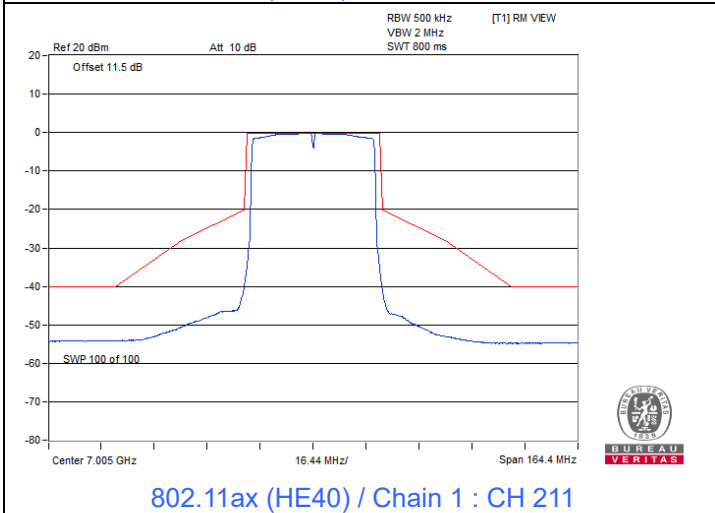
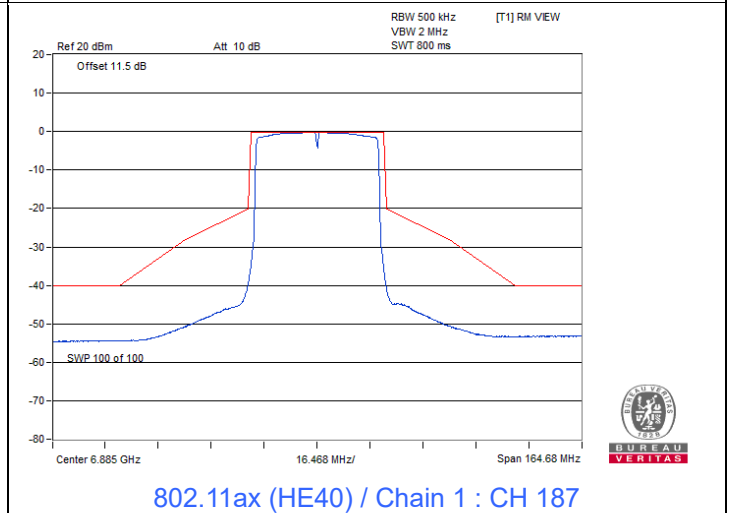
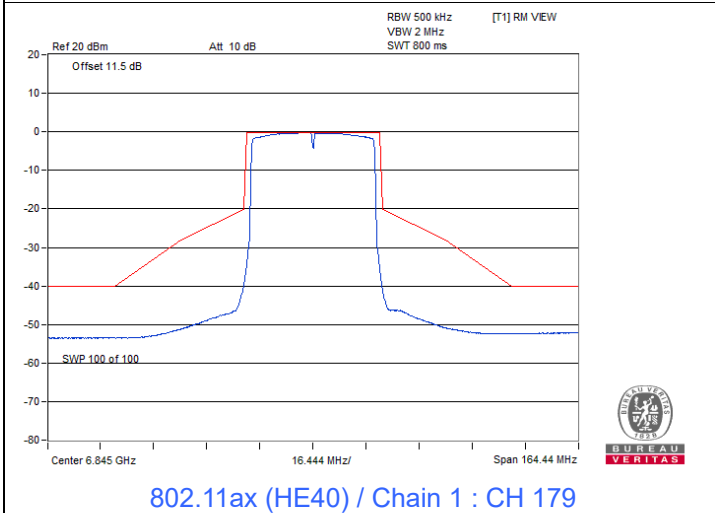
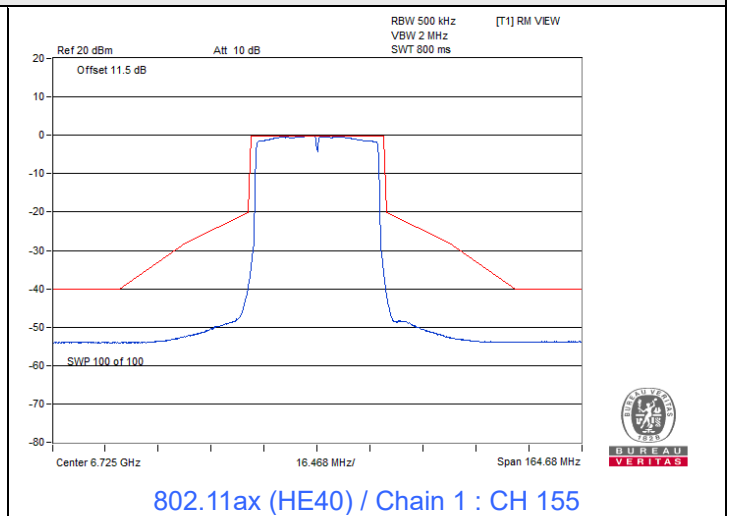
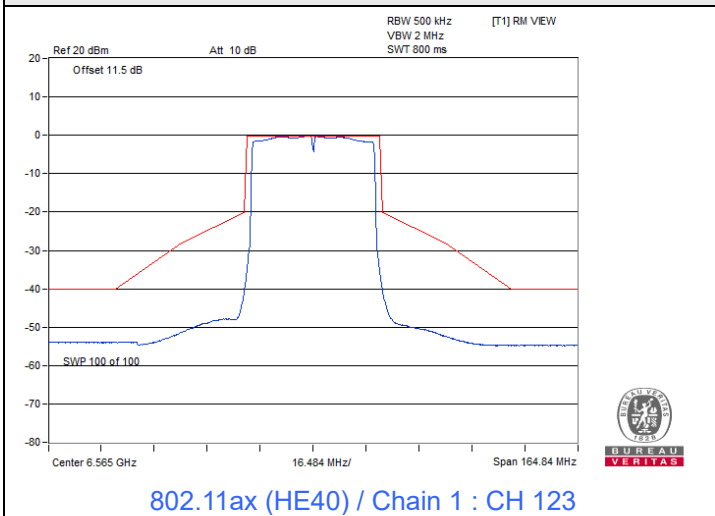

802.11ax (HE80)

Spectrum Plot

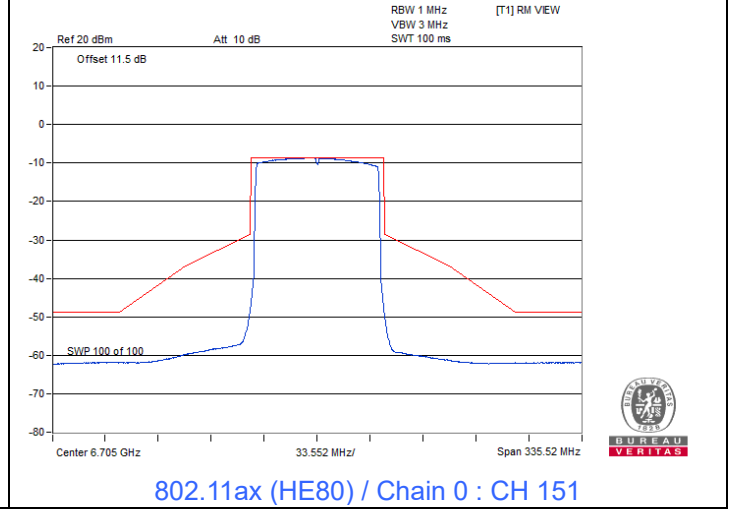
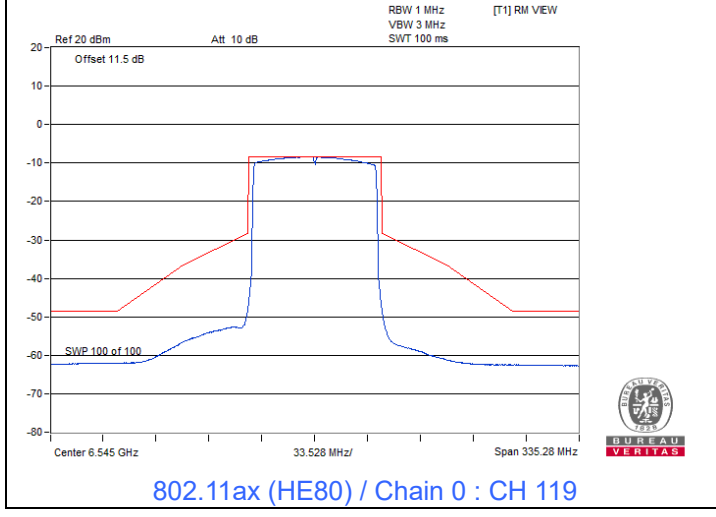
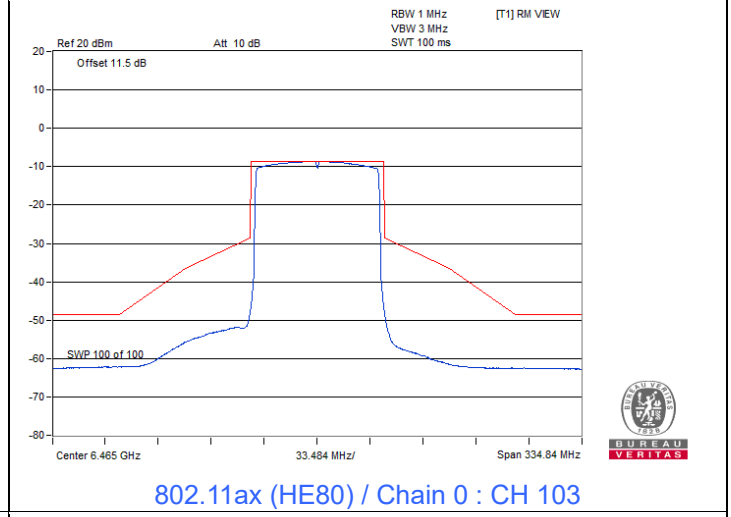
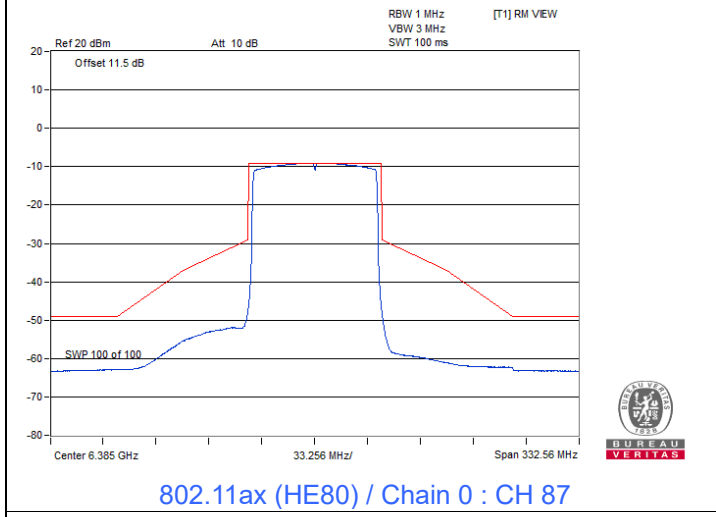
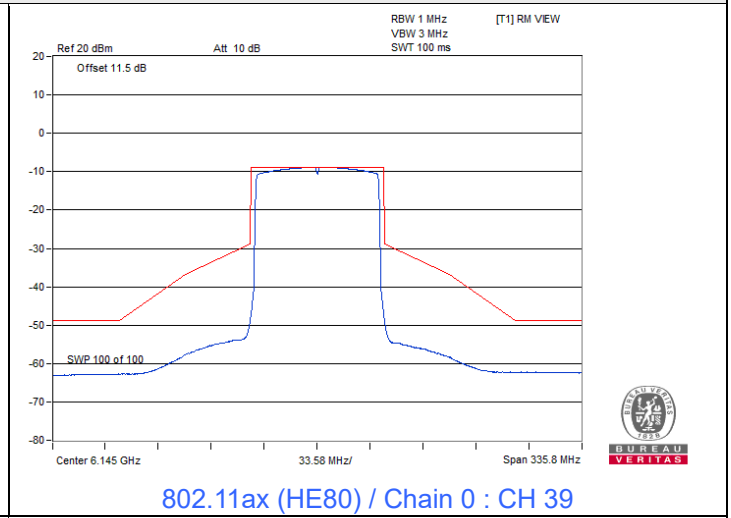
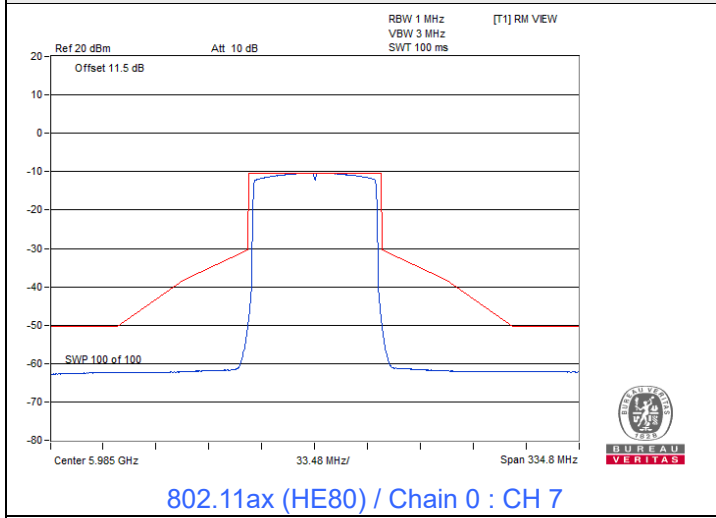

Spectrum Plot

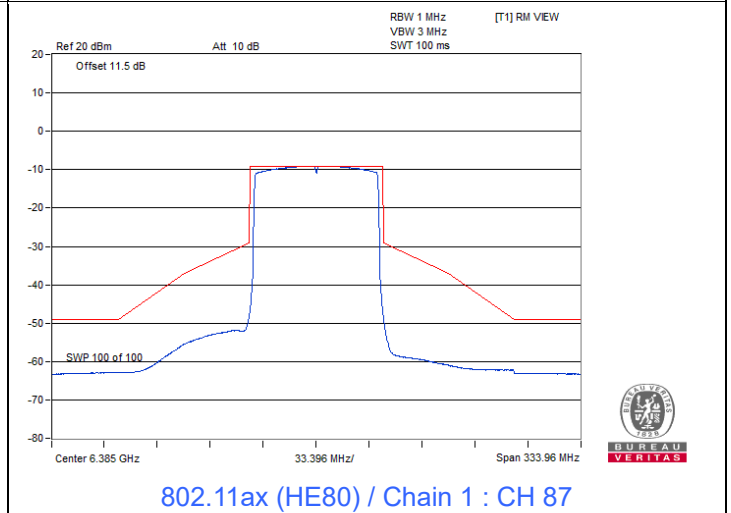
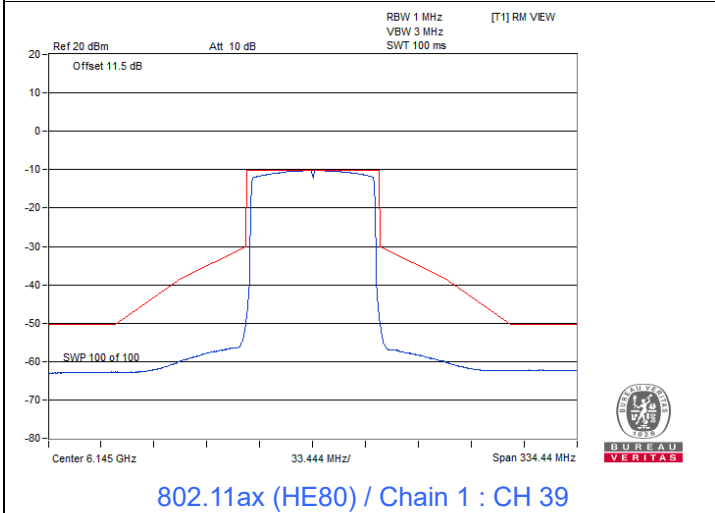
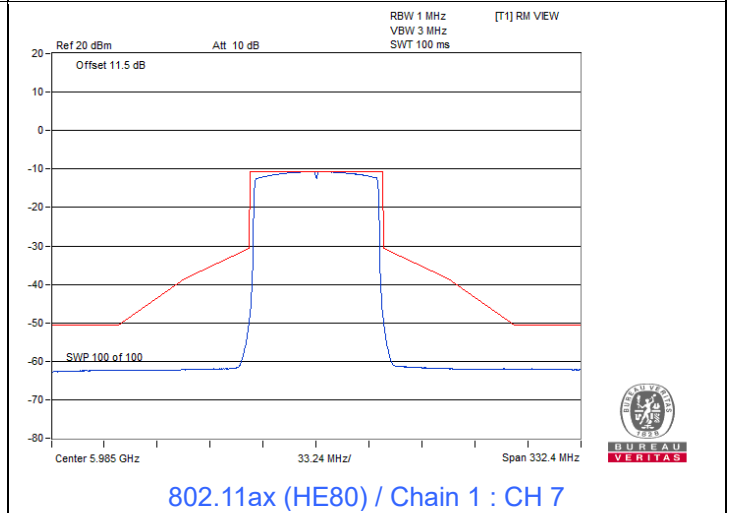
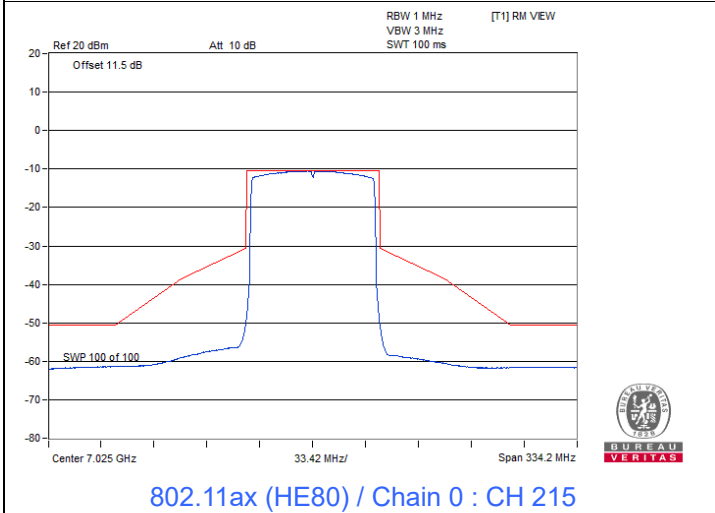
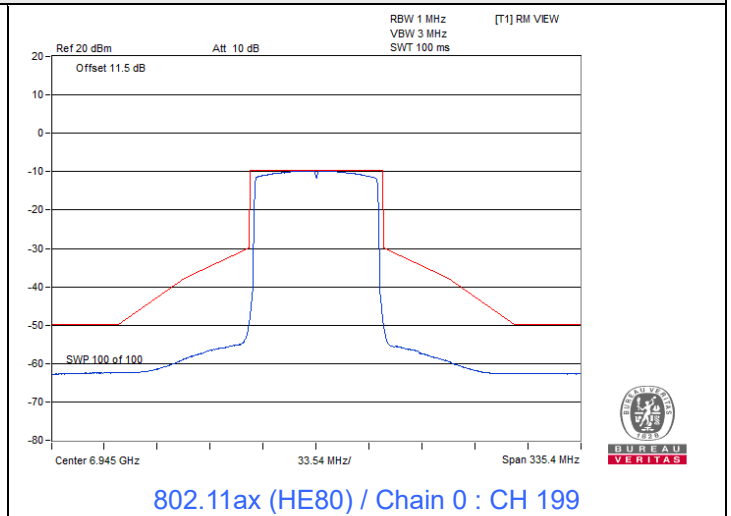
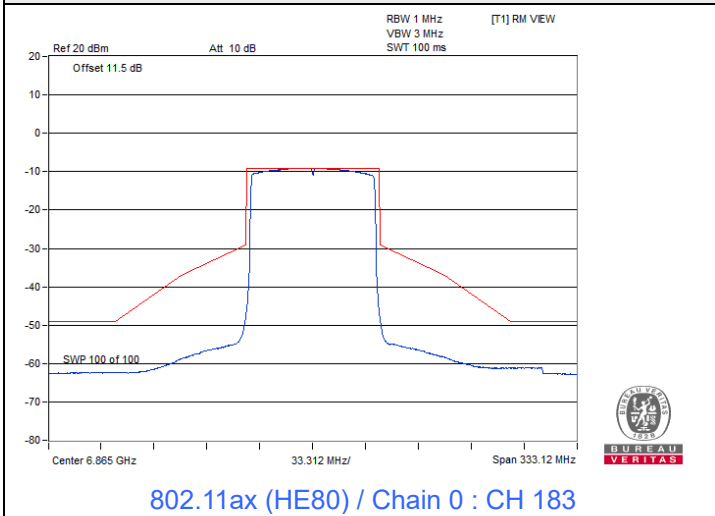

Spectrum Plot

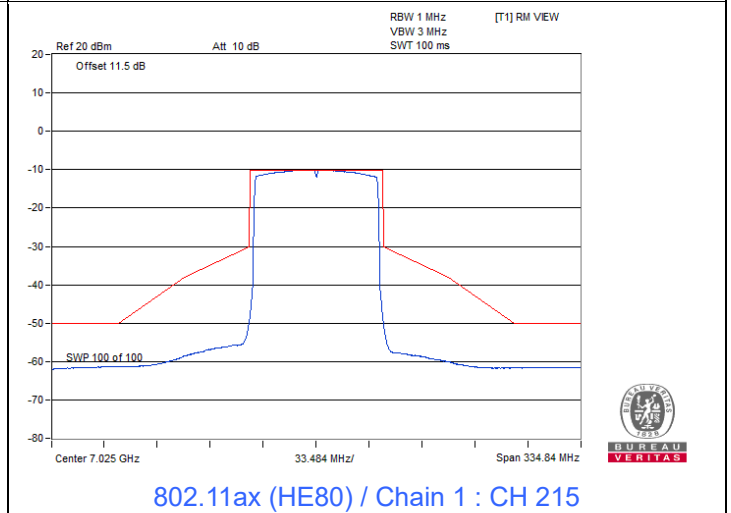
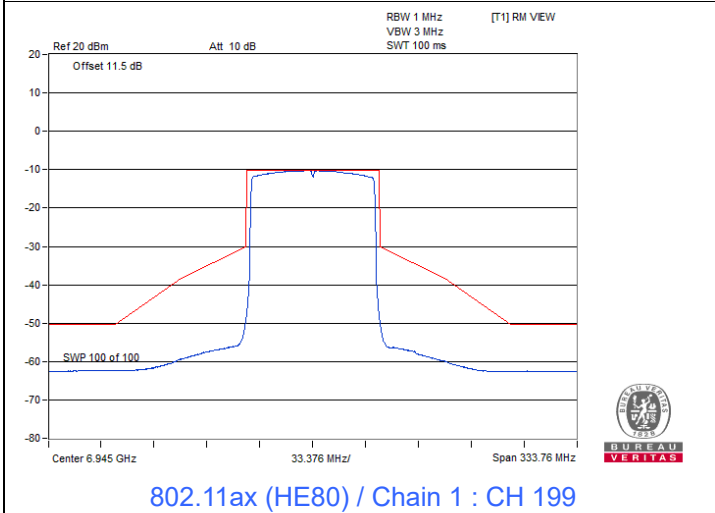
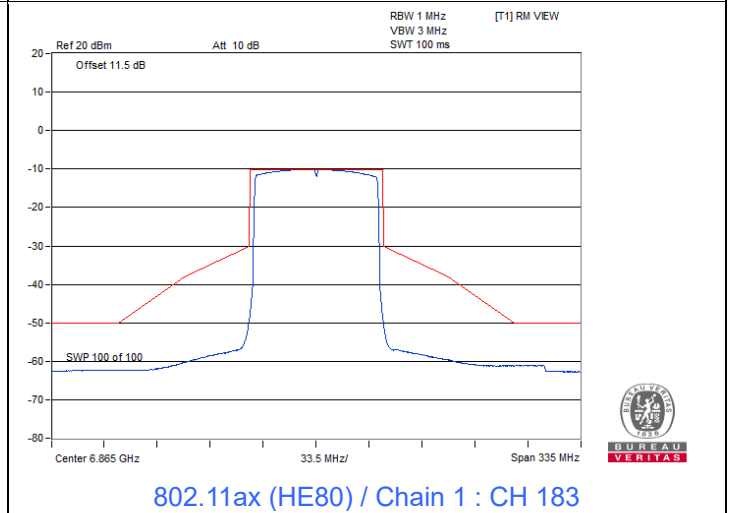
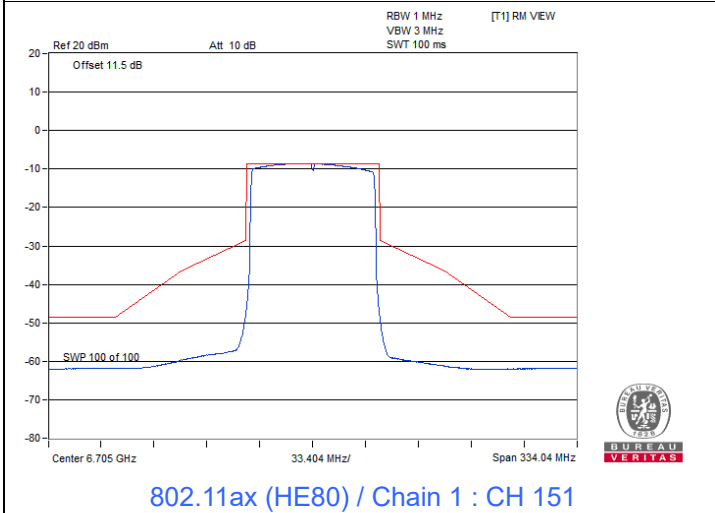
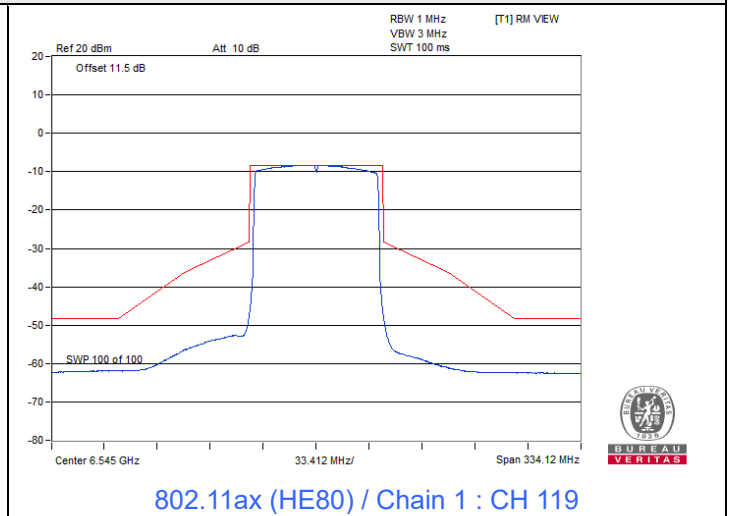
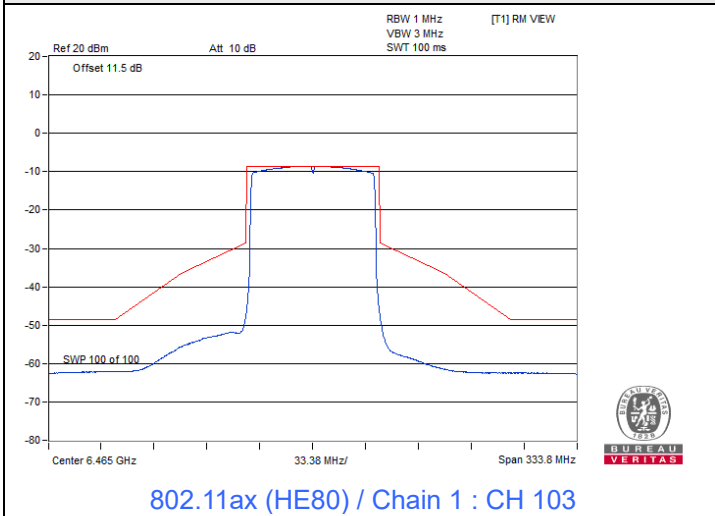

802.11ax (HE160)

Spectrum Plot

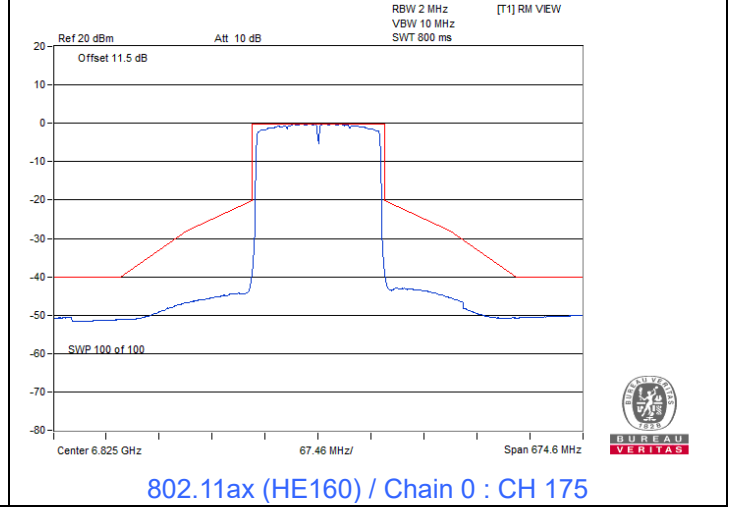
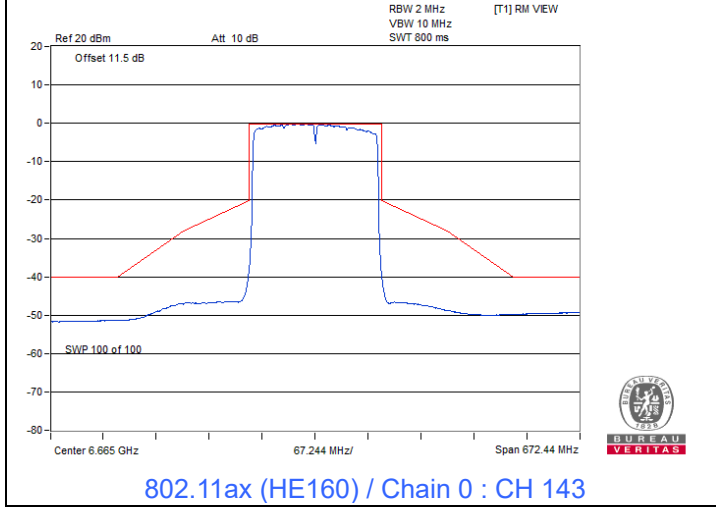
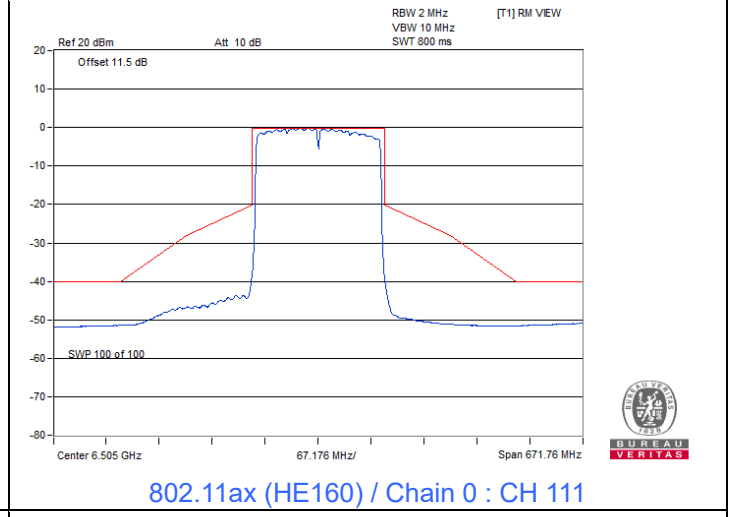
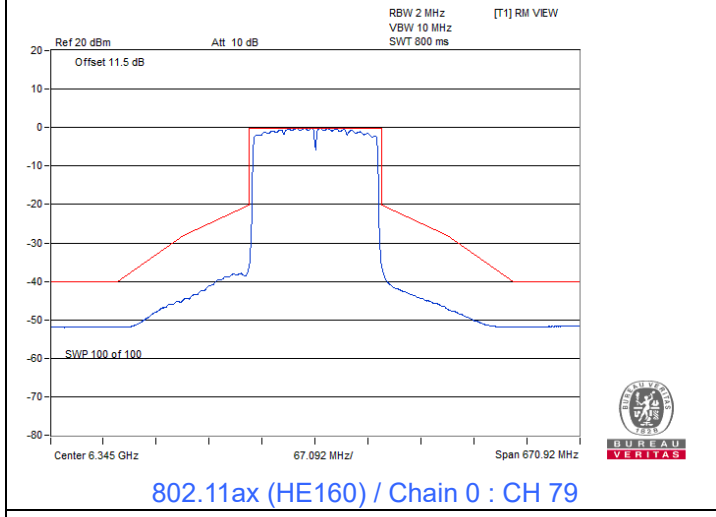
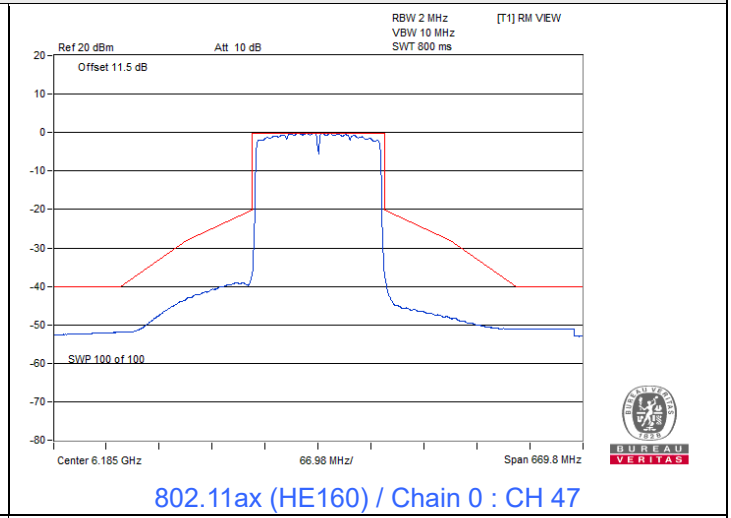
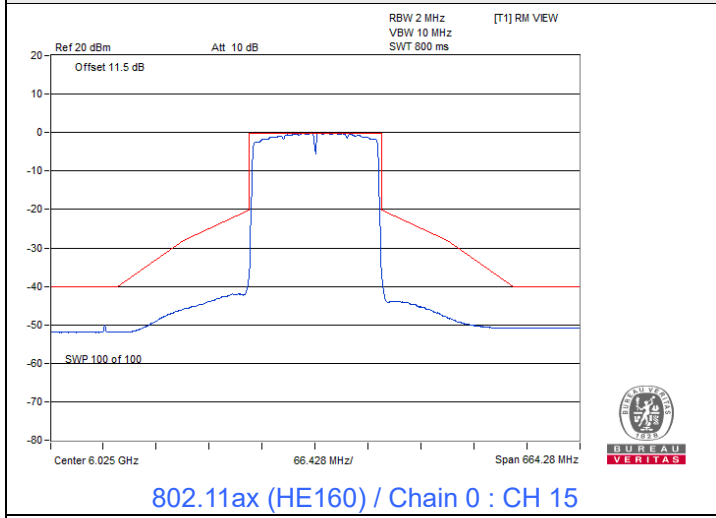

Spectrum Plot

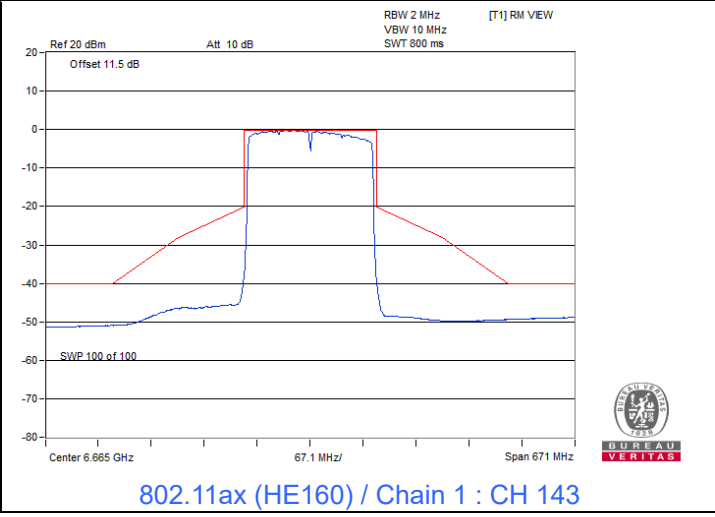
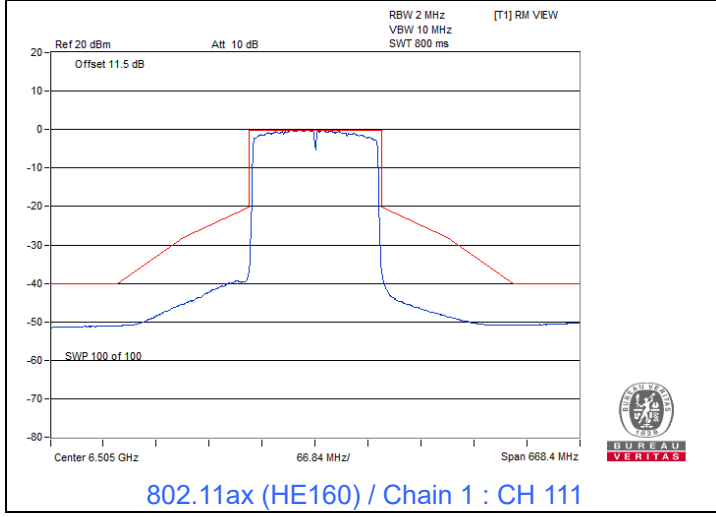
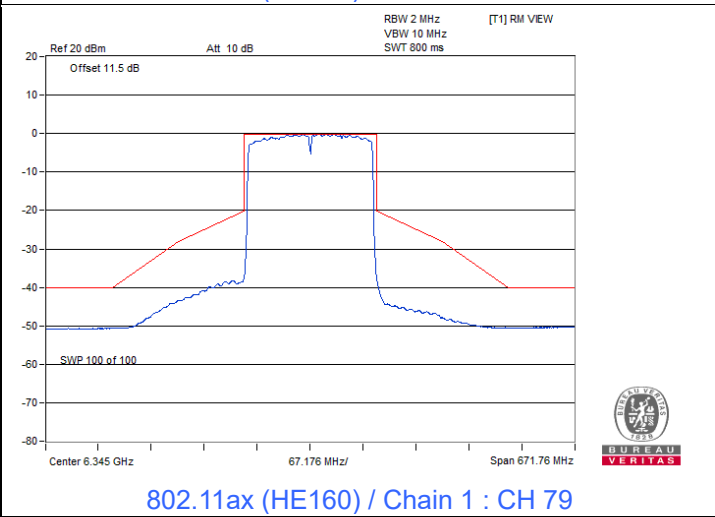
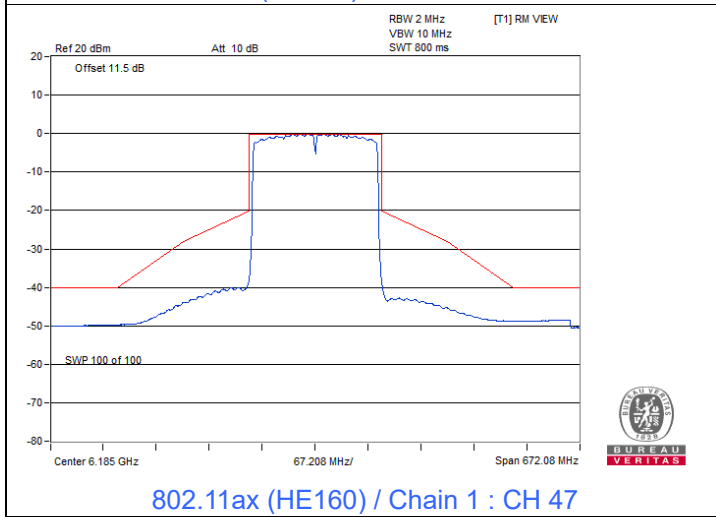
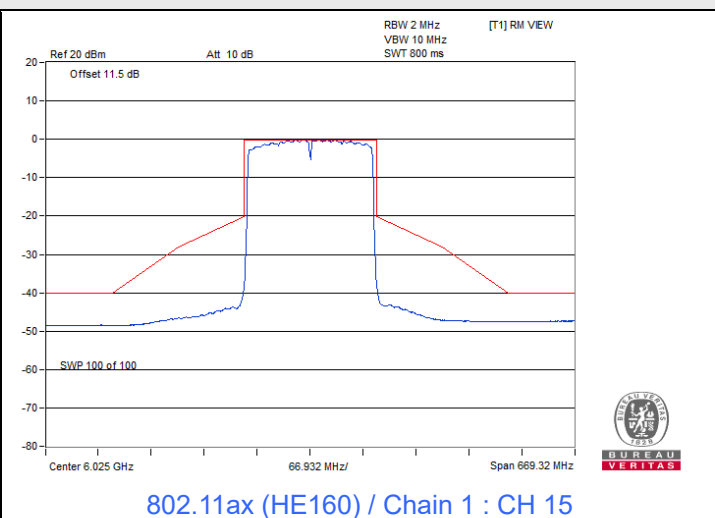
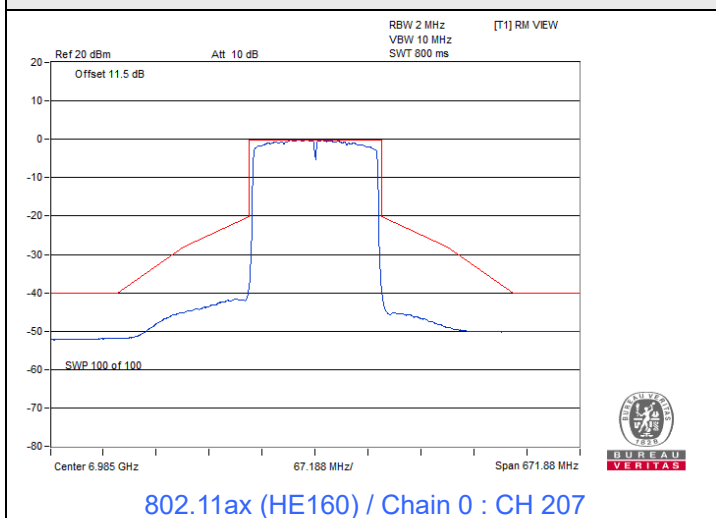



Spectrum Plot

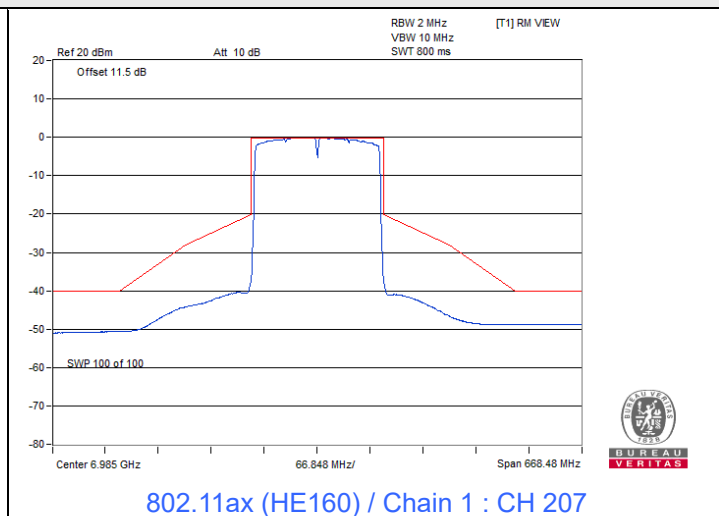
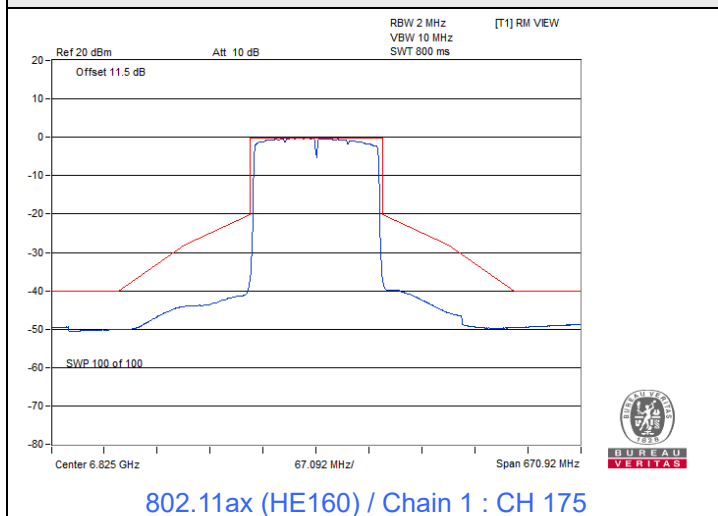

802.11ax (HE20) 26-tone RU

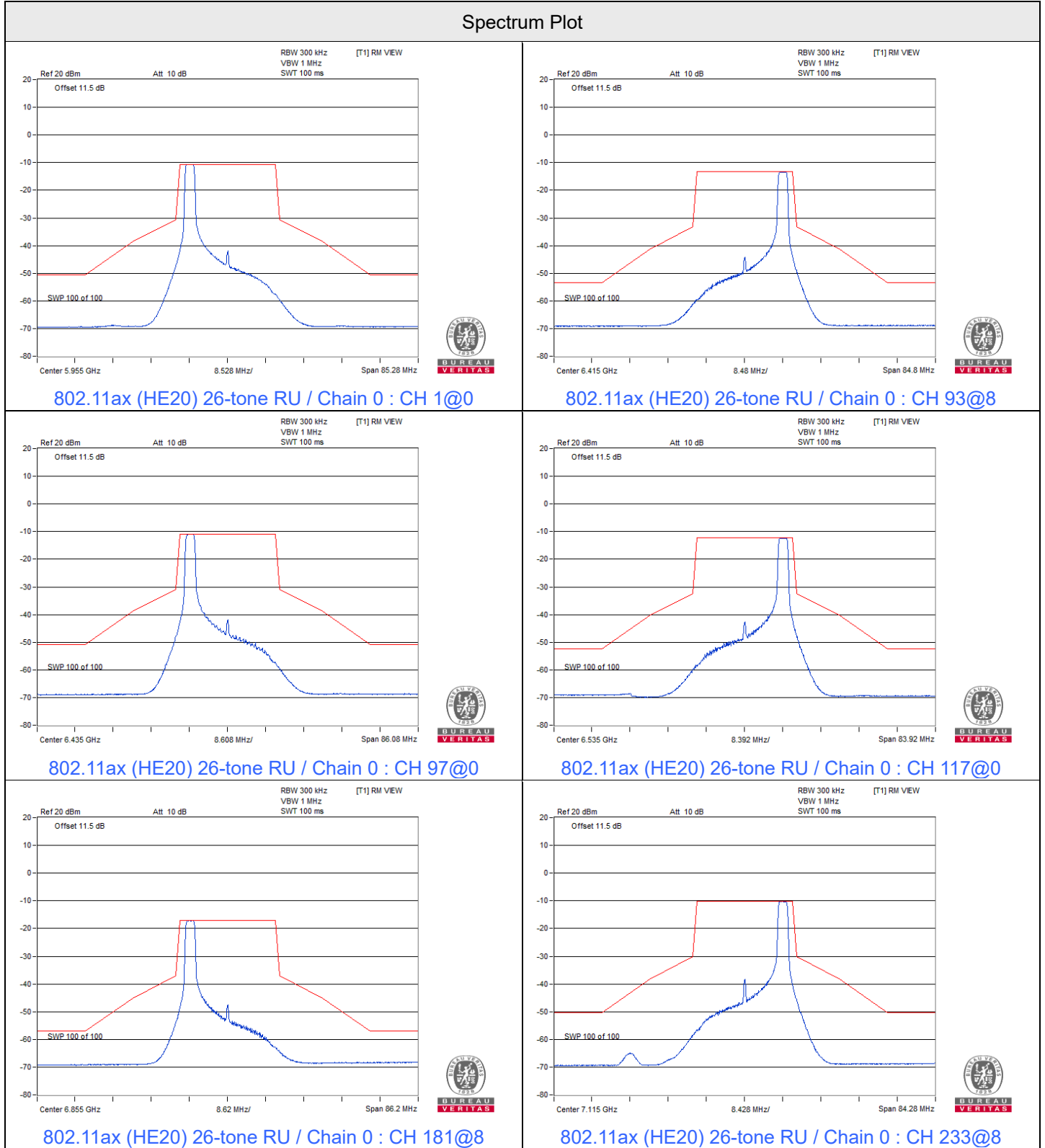

Spectrum Plot

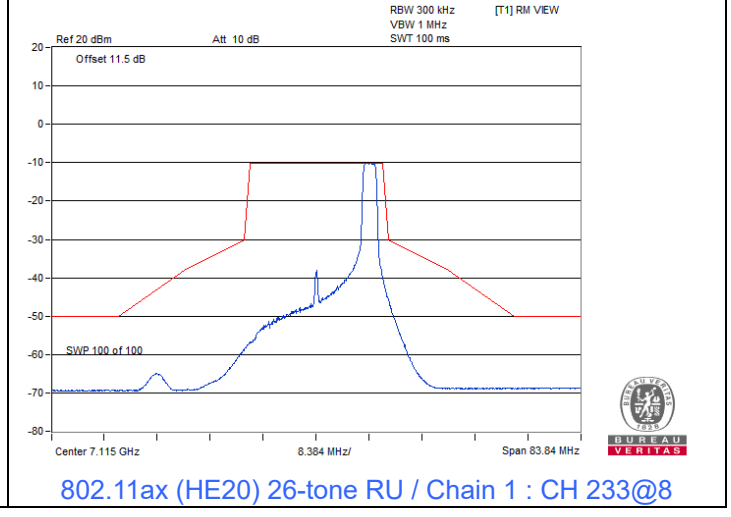
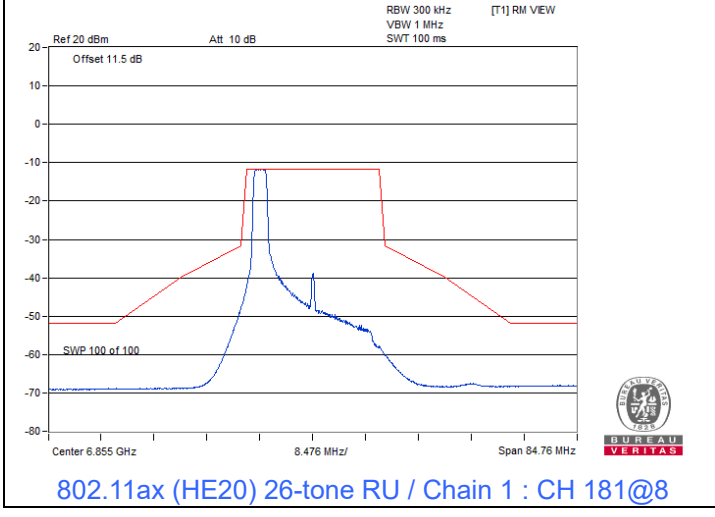
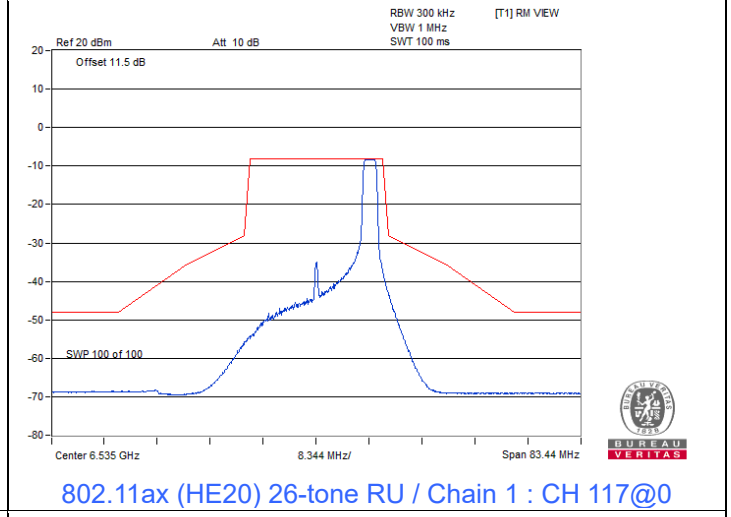
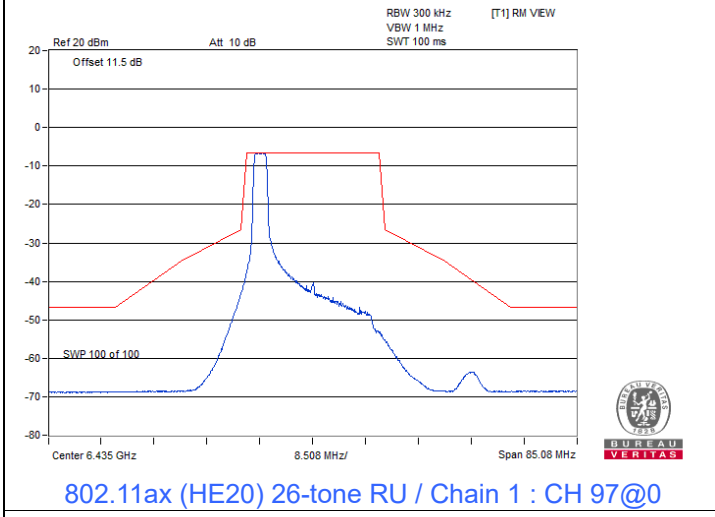
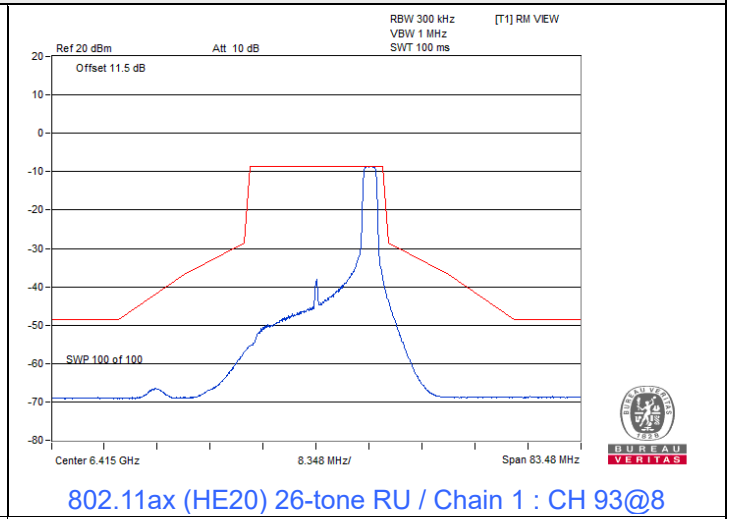
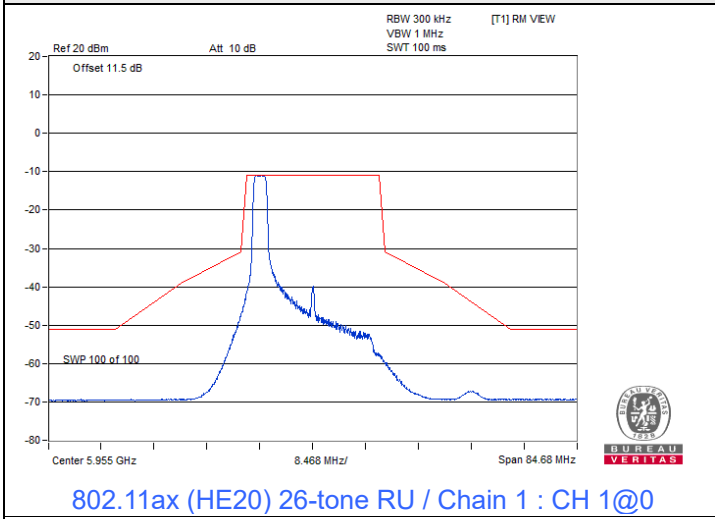

802.11ax (HE20) 52-tone RU

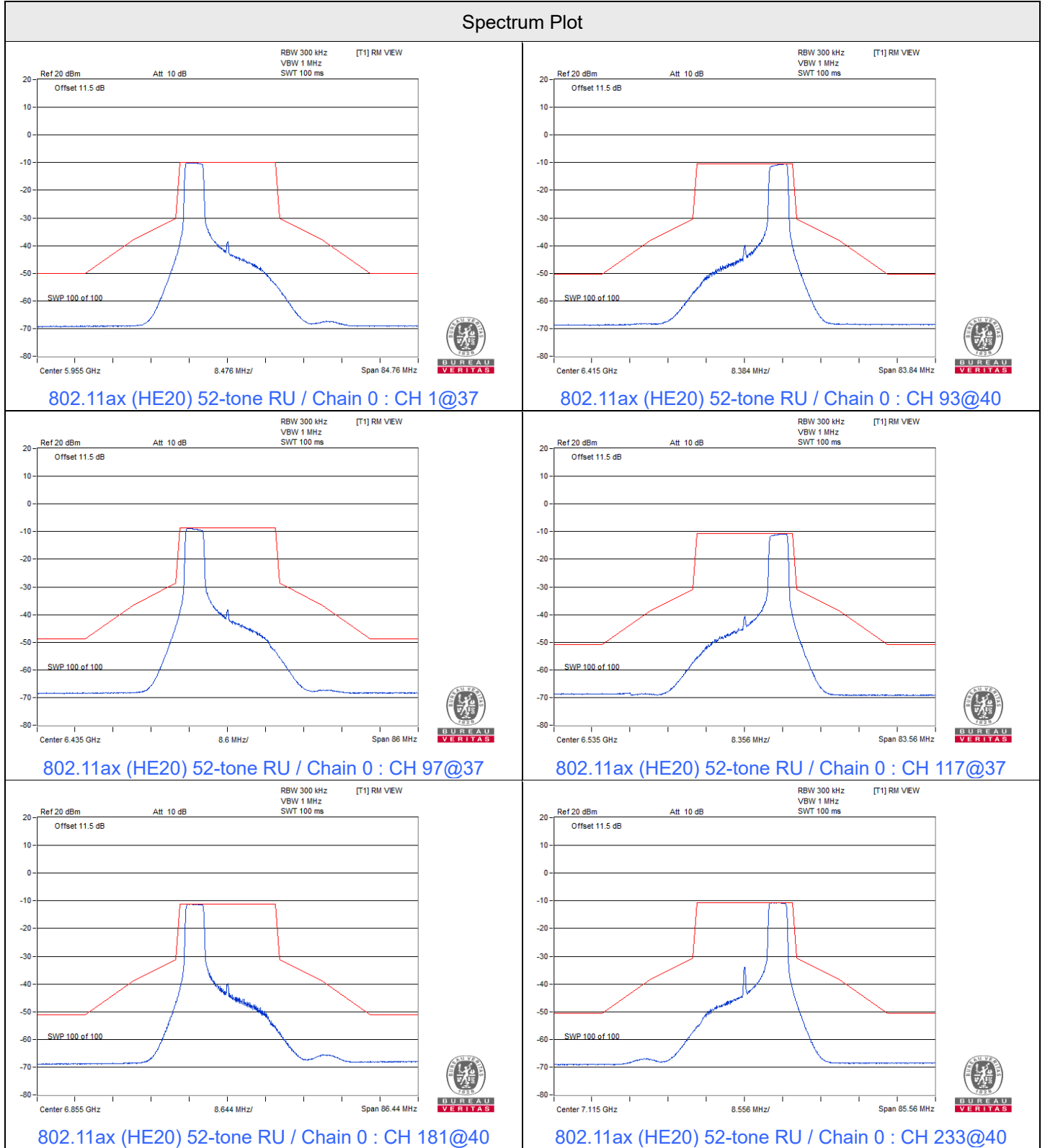

Spectrum Plot

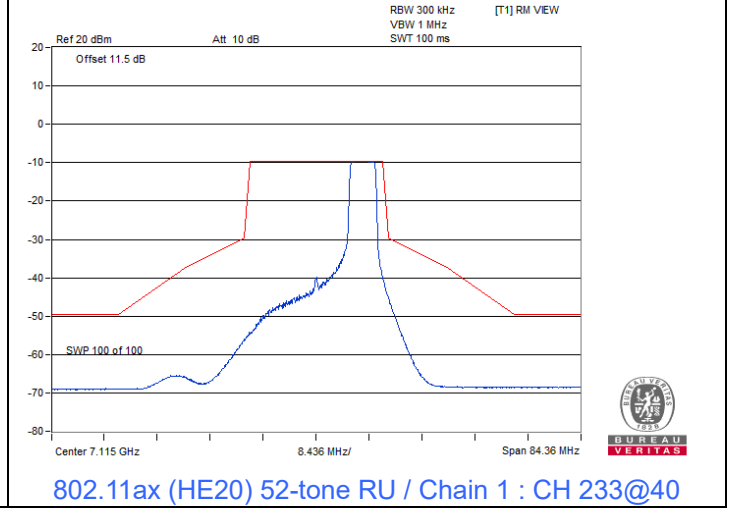
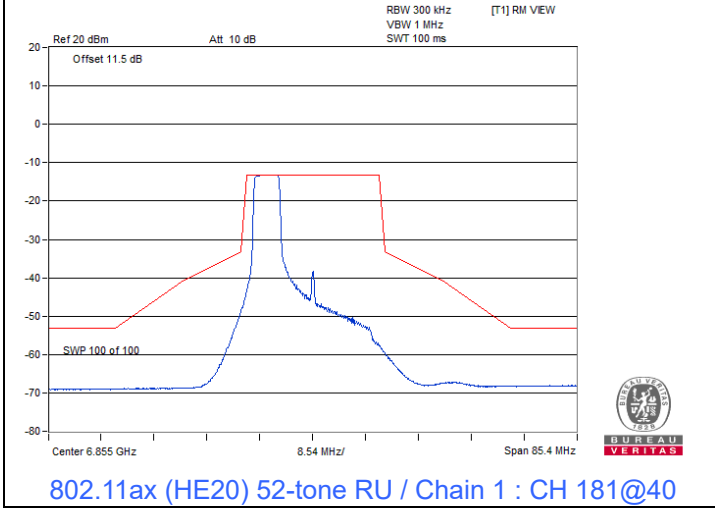
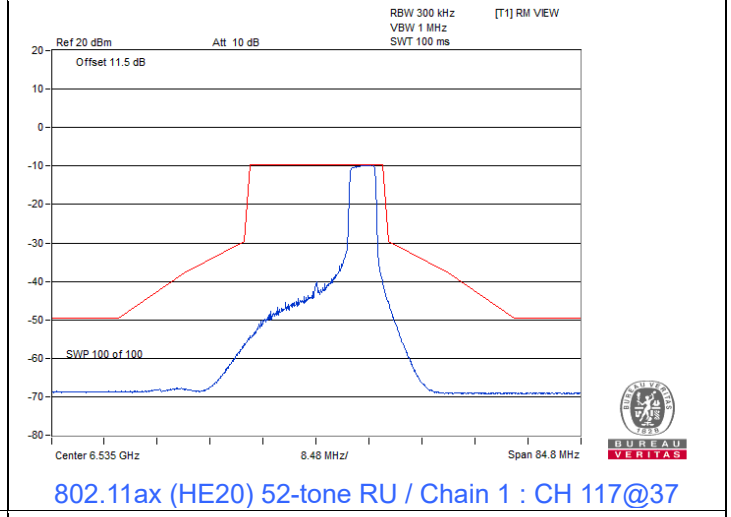
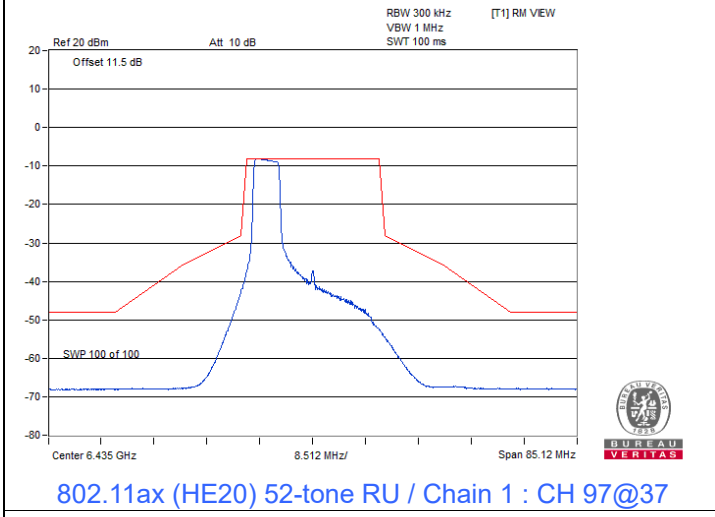
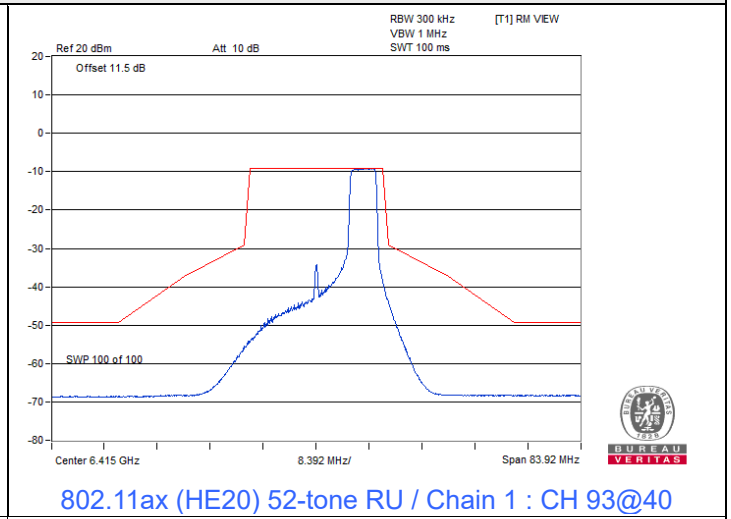
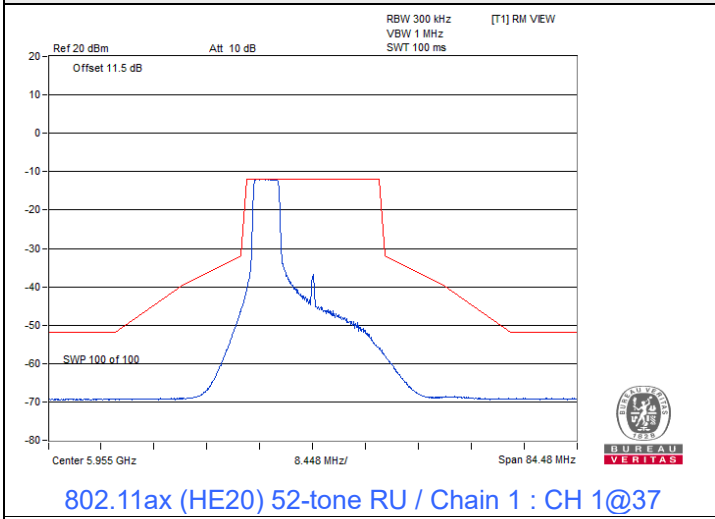

802.11ax (HE20) 106-tone RU

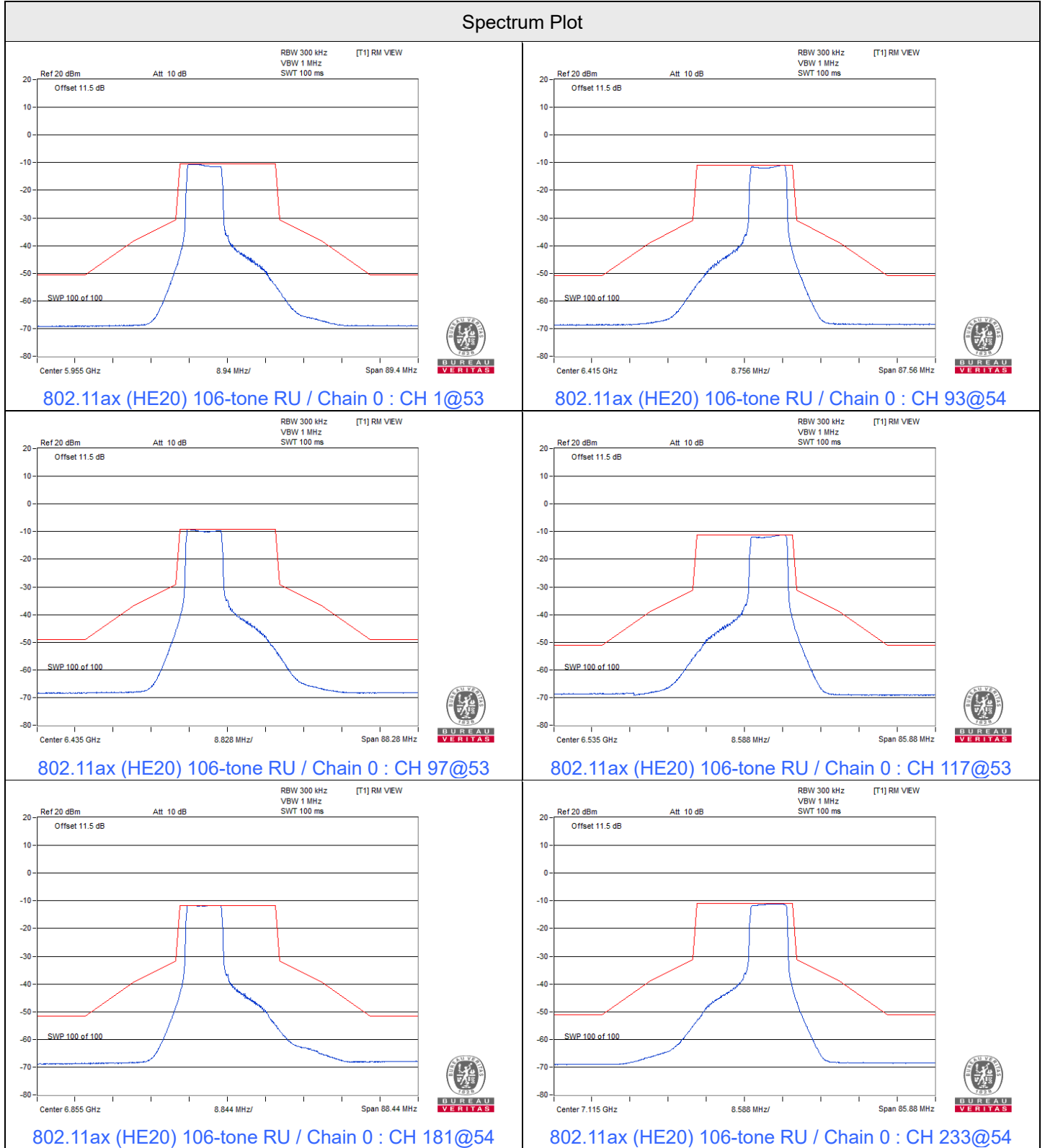

Spectrum Plot

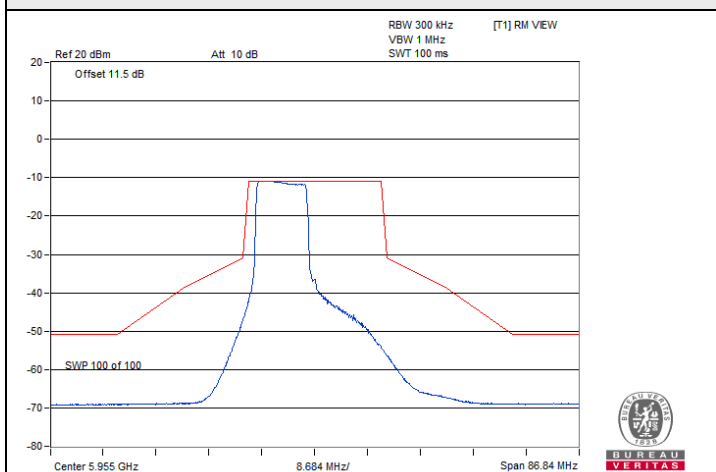

802.11ax (HE20) 106-tone RU / Chain 1 : CH 1@53

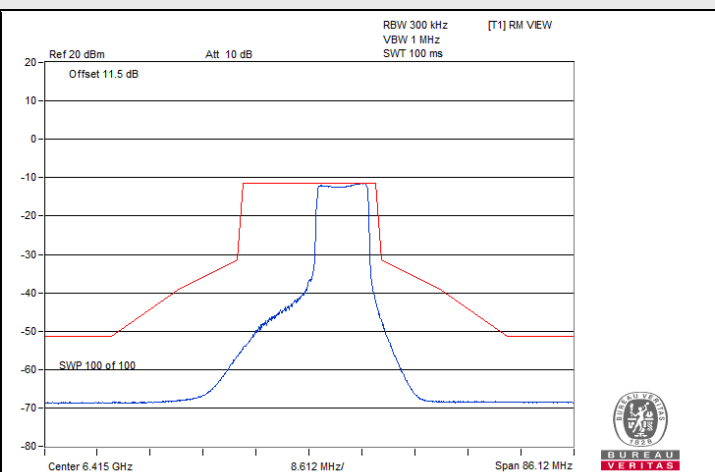

802.11ax (HE20) 106-tone RU / Chain 1 : CH 93@54

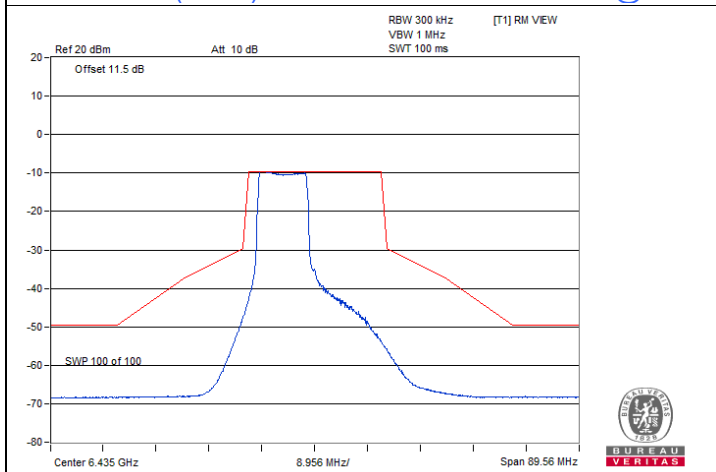

802.11ax (HE20) 106-tone RU / Chain 1 : CH 97@53

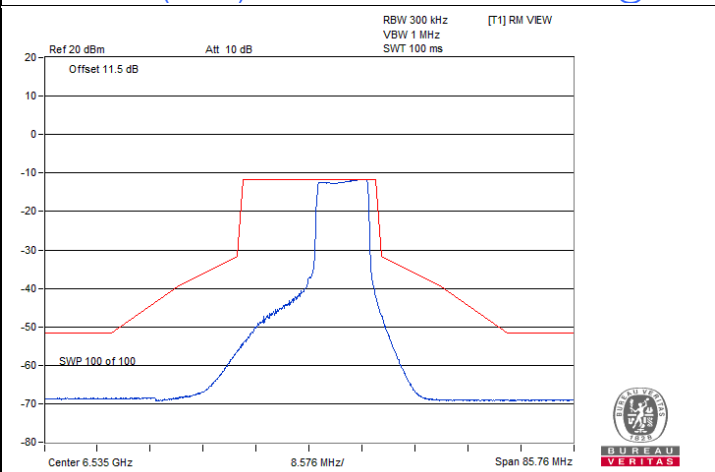

802.11ax (HE20) 106-tone RU / Chain 1 : CH 117@53

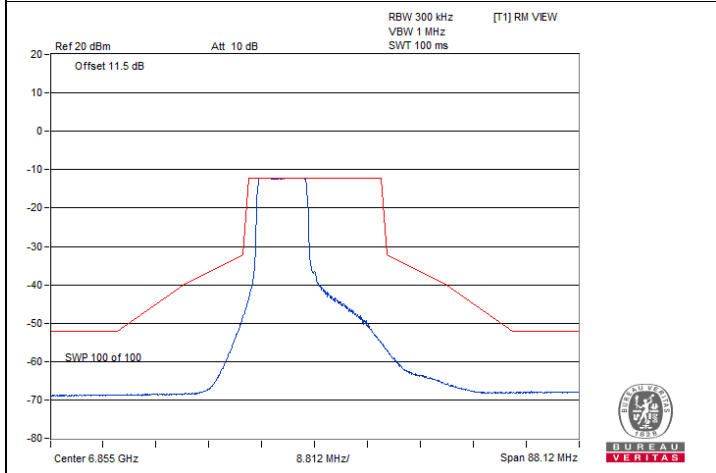

802.11ax (HE20) 106-tone RU / Chain 1 : CH 181@54

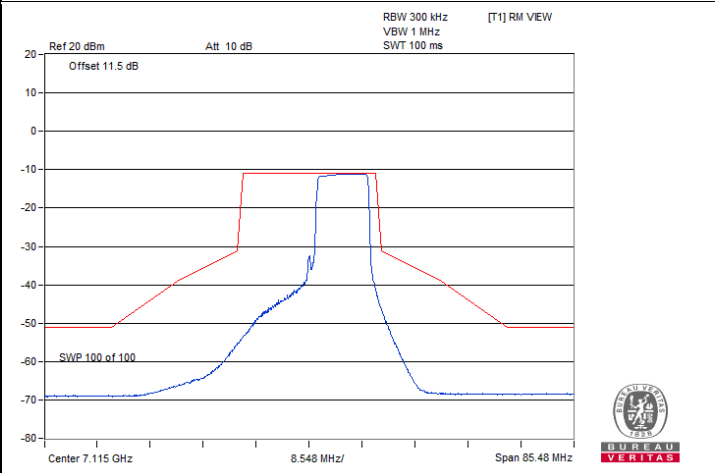

802.11ax (HE20) 106-tone RU / Chain 1 : CH 233@54

802.11ax (HE40) 242-tone RU

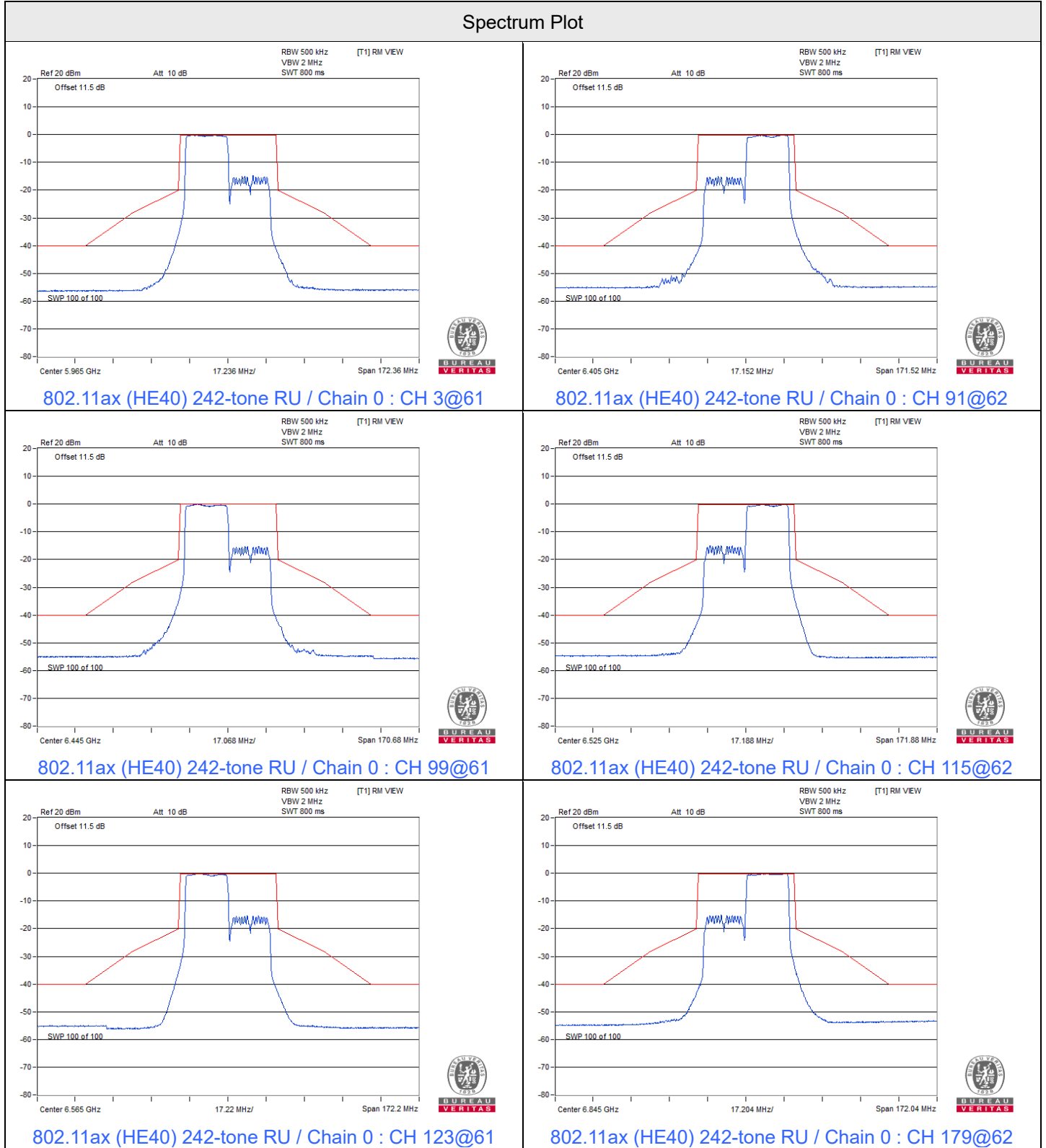

Spectrum Plot

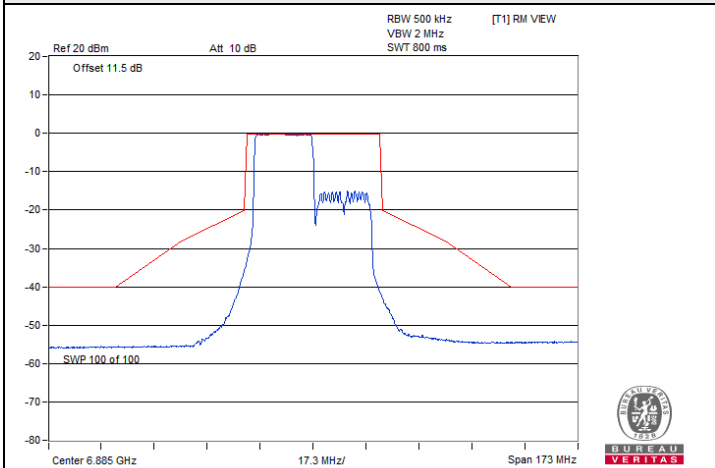

802.11ax (HE40) 242-tone RU / Chain 0 : CH 187@61

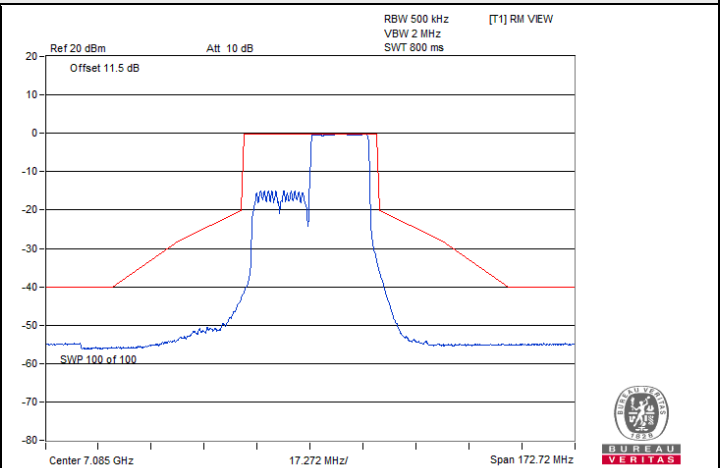

802.11ax (HE40) 242-tone RU / Chain 0 : CH 227@62

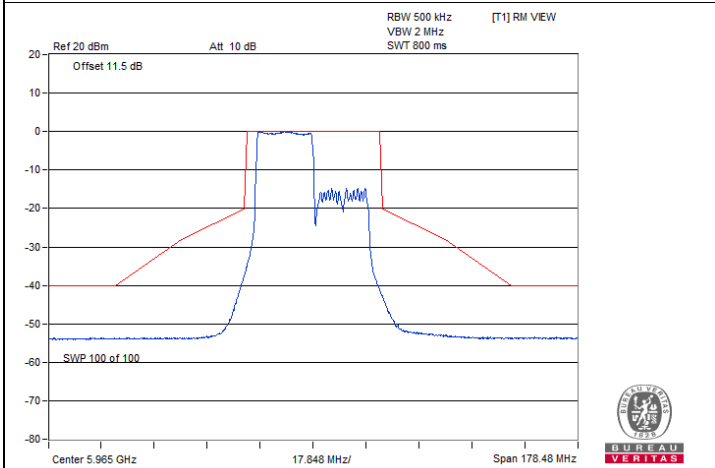

802.11ax (HE40) 242-tone RU / Chain 1 : CH 3@61

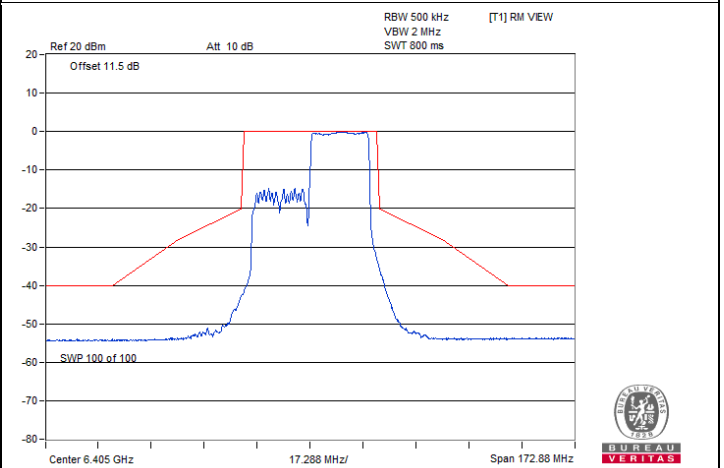

802.11ax (HE40) 242-tone RU / Chain 1 : CH 91@62

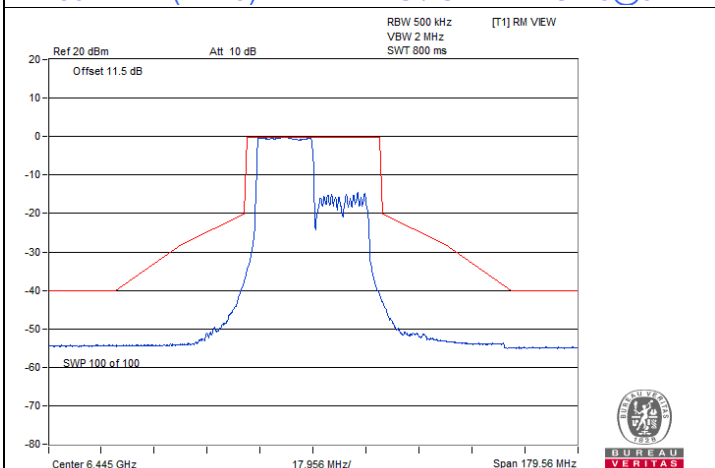

802.11ax (HE40) 242-tone RU / Chain 1 : CH 99@61

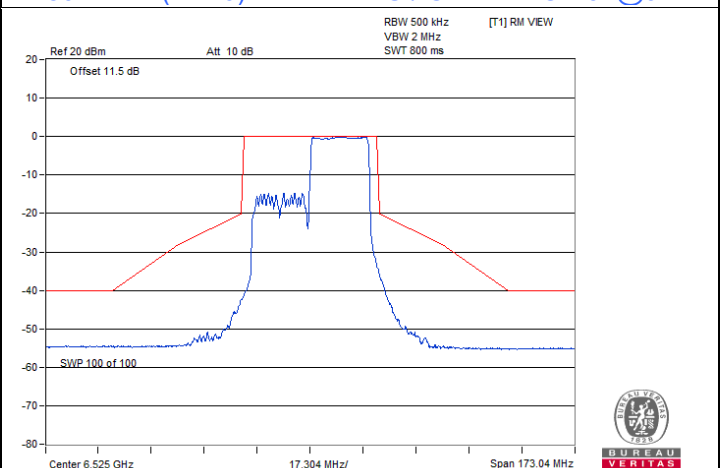

802.11ax (HE40) 242-tone RU / Chain 1 : CH 115@62

Spectrum Plot

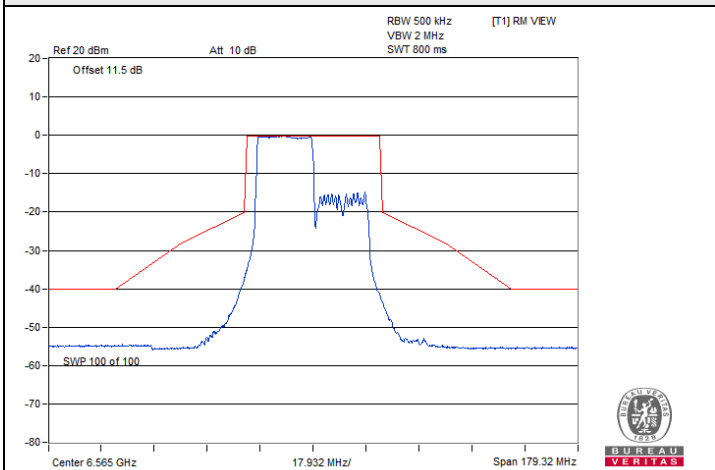

802.11ax (HE40) 242-tone RU / Chain 1 : CH 123@61

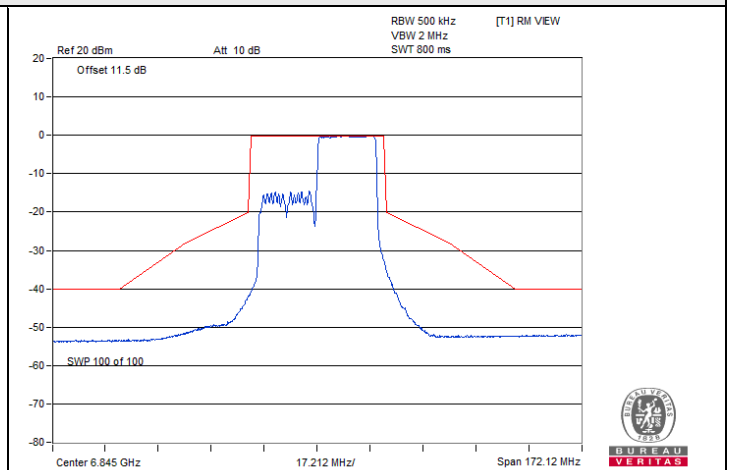

802.11ax (HE40) 242-tone RU / Chain 1 : CH 179@62

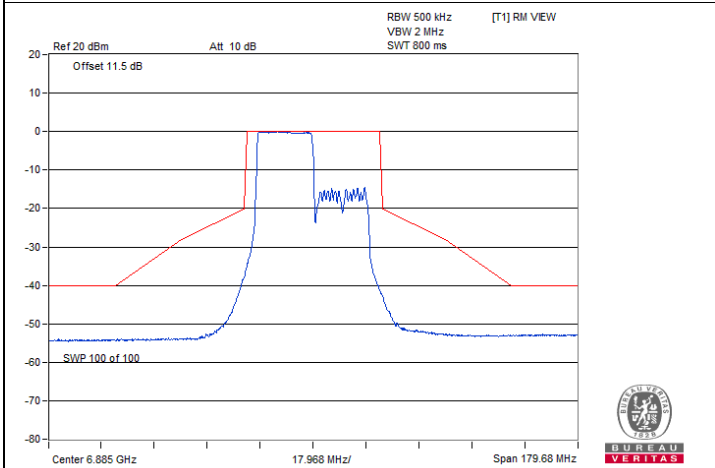

802.11ax (HE40) 242-tone RU / Chain 1 : CH 187@61

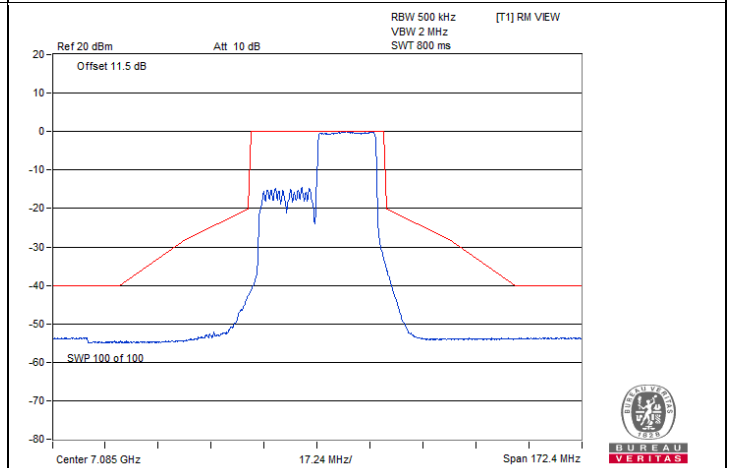

802.11ax (HE40) 242-tone RU / Chain 1 : CH 227@62



802.11ax (HE80) 484-tone RU

Spectrum Plot

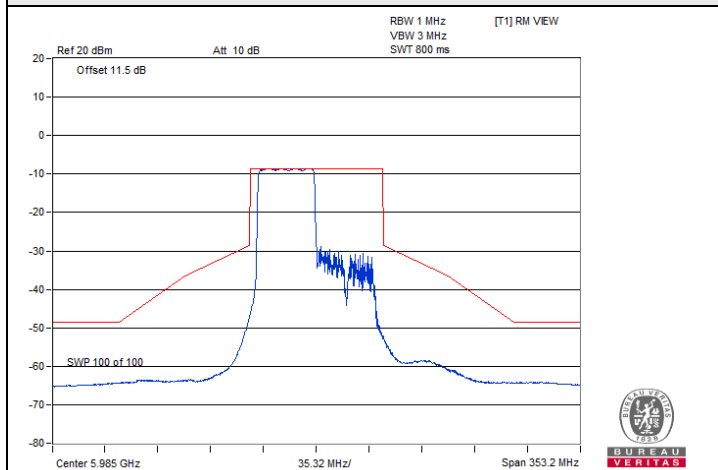

802.11ax (HE80) 484-tone RU / Chain 0 : CH 7@65

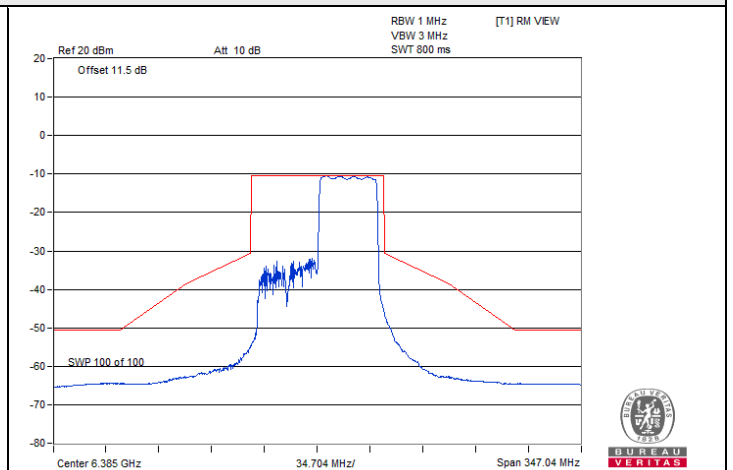

802.11ax (HE80) 484-tone RU / Chain 0 : CH 87@66

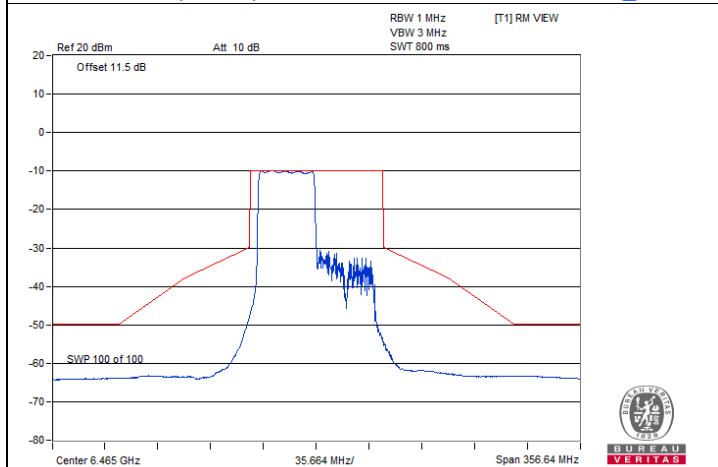

802.11ax (HE80) 484-tone RU / Chain 0 : CH 103@65

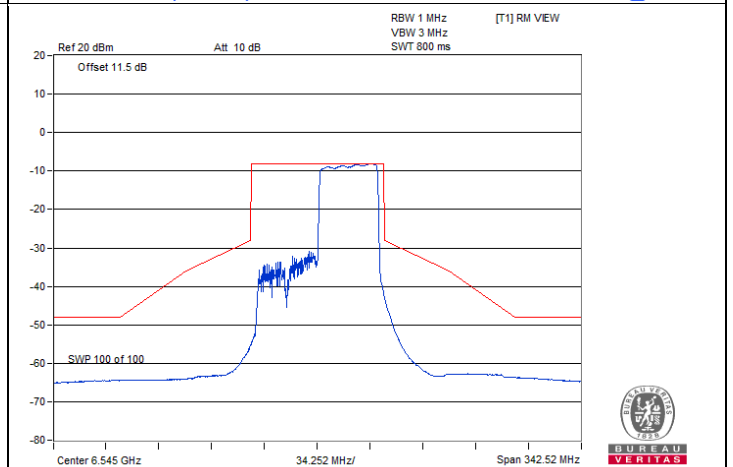

802.11ax (HE80) 484-tone RU / Chain 0 : CH 119@66

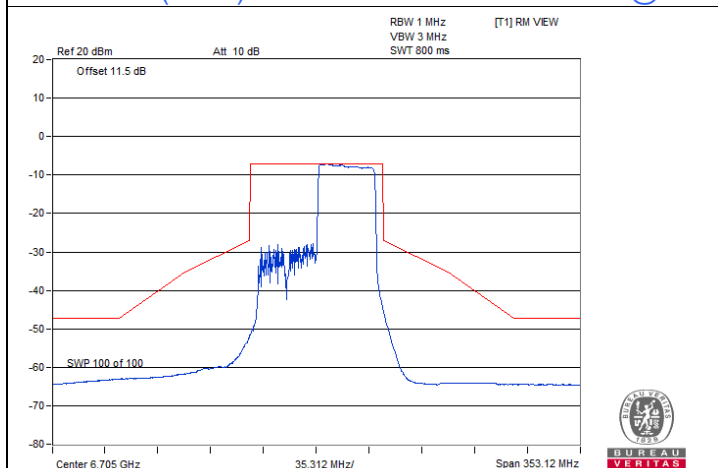

802.11ax (HE80) 484-tone RU / Chain 0 : CH 151@66

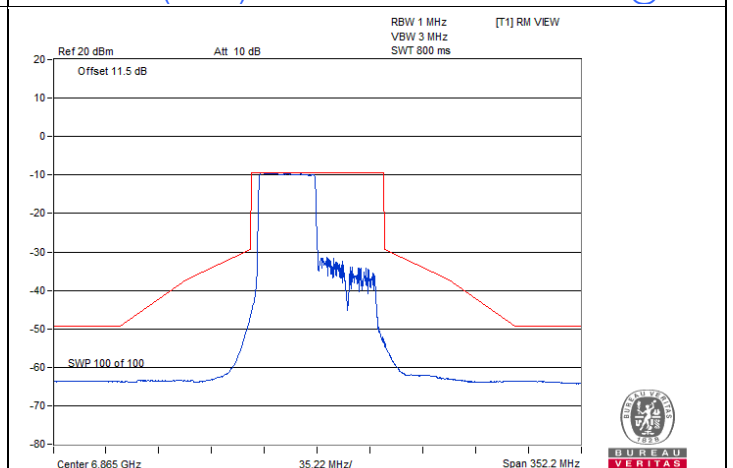

802.11ax (HE80) 484-tone RU / Chain 0 : CH 183@65

Spectrum Plot

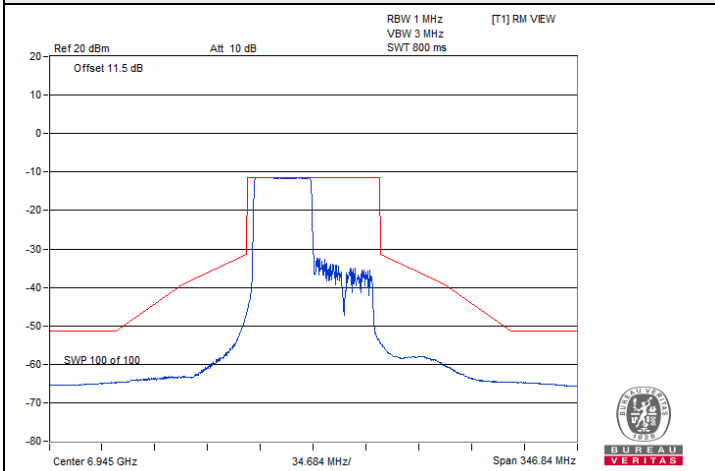

802.11ax (HE80) 484-tone RU / Chain 0 : CH 199@65

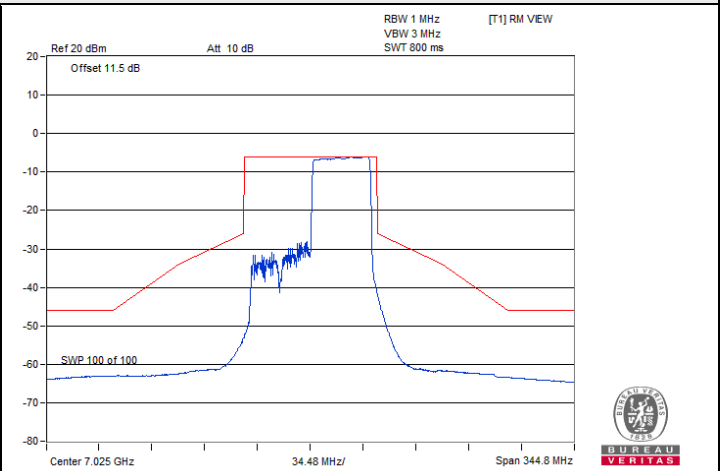

802.11ax (HE80) 484-tone RU / Chain 0 : CH 215@66

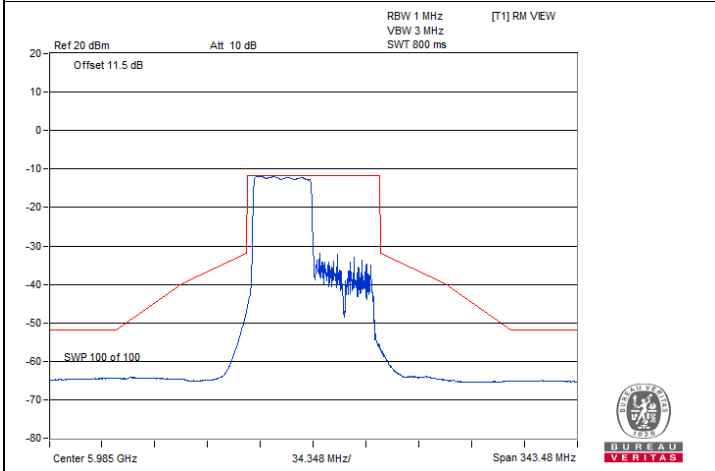

802.11ax (HE80) 484-tone RU / Chain 1 : CH 7@65

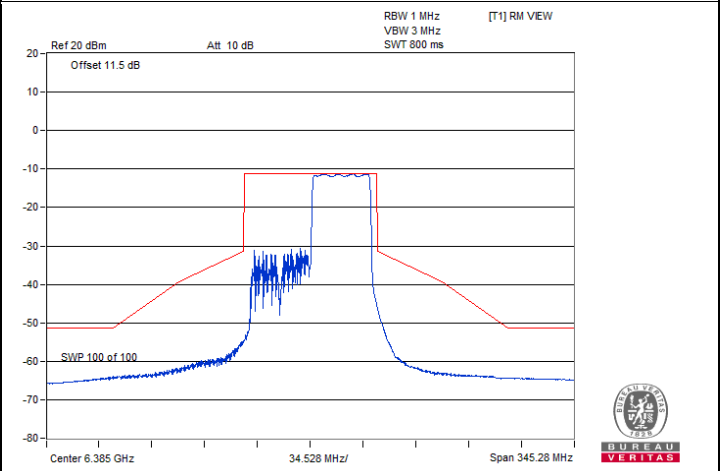

802.11ax (HE80) 484-tone RU / Chain 1 : CH 87@66

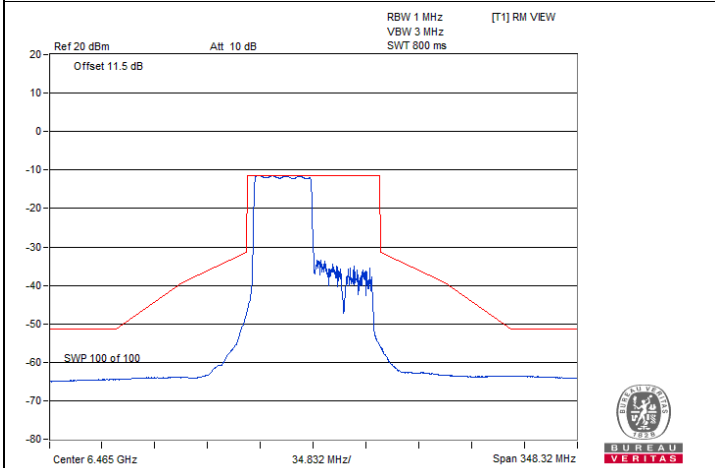

802.11ax (HE80) 484-tone RU / Chain 1 : CH 103@65

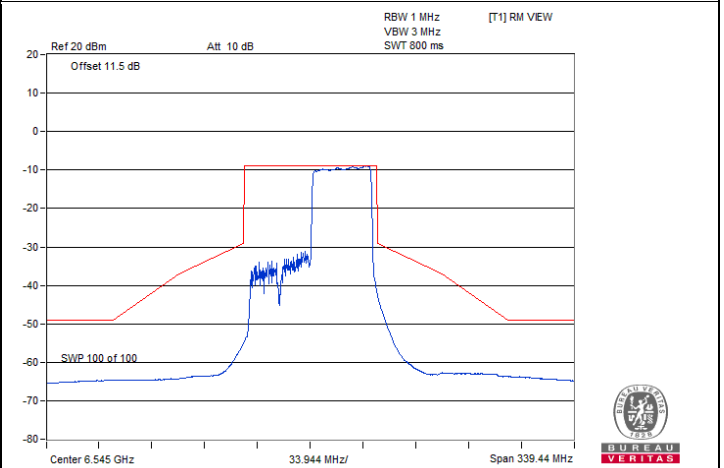

802.11ax (HE80) 484-tone RU / Chain 1 : CH 119@66

Spectrum Plot

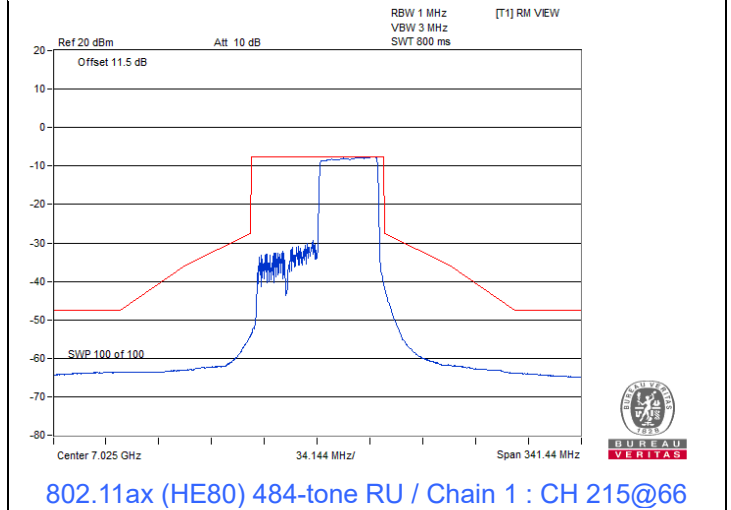
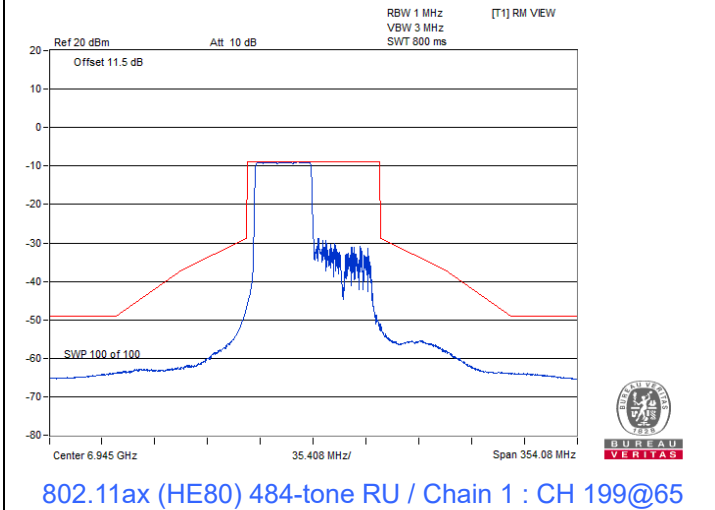
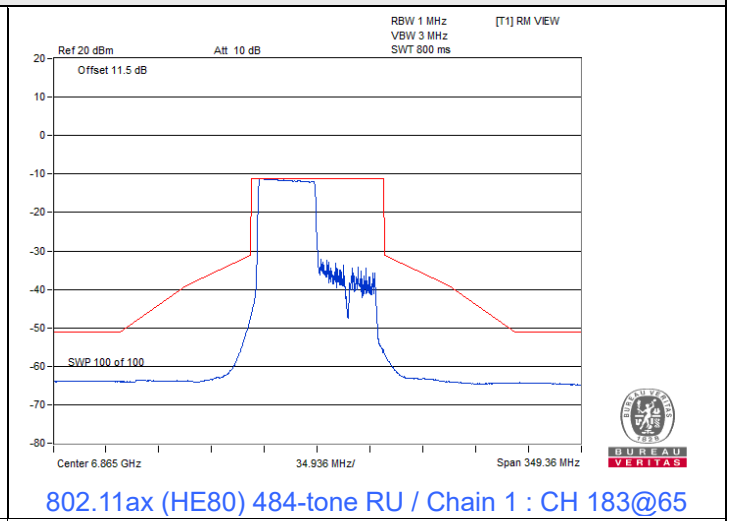
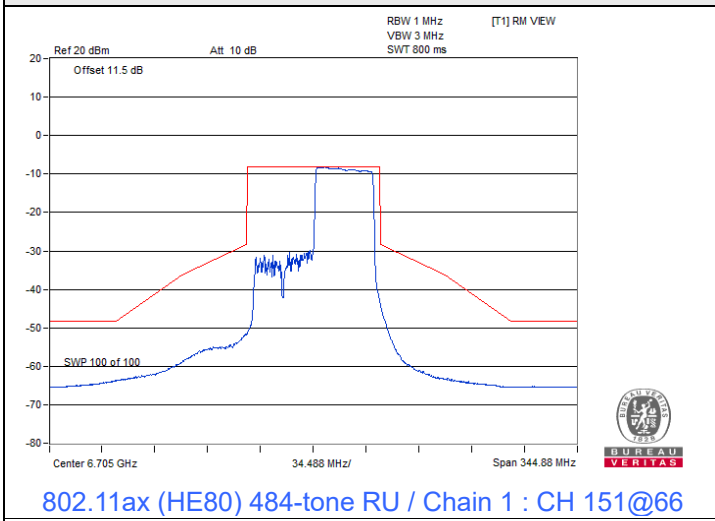

802.11ax (HE160) 996-tone RU

Spectrum Plot

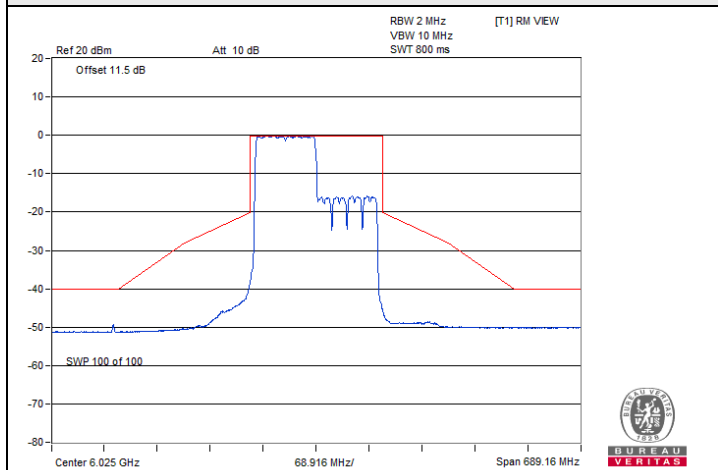

802.11ax (HE160) 996-tone RU / Chain 0 : CH 15@67

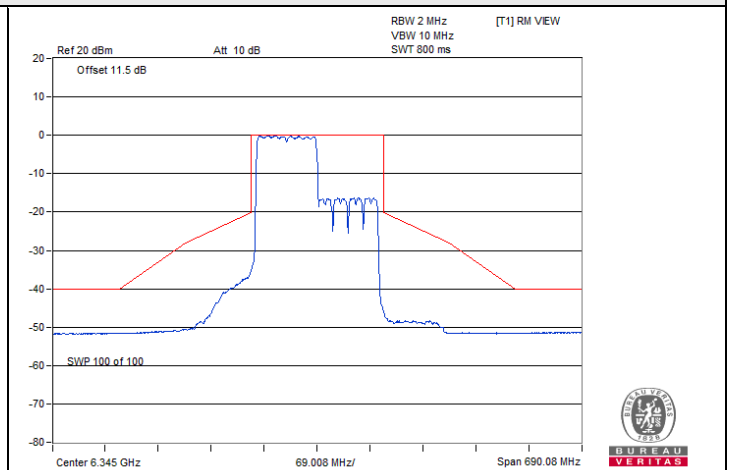

802.11ax (HE160) 996-tone RU / Chain 0 : CH 79@67

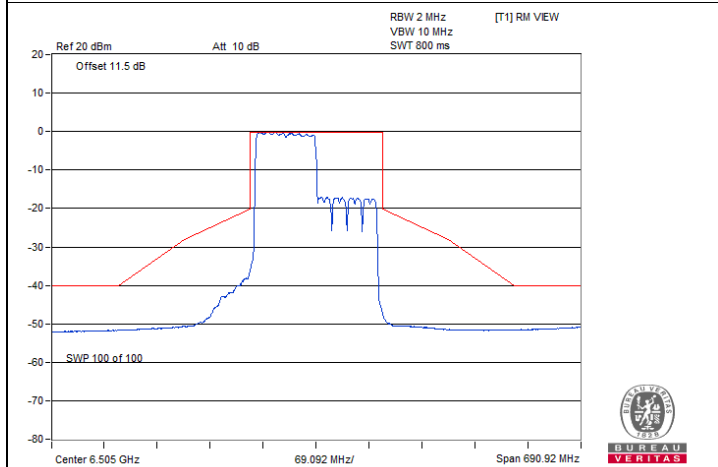

802.11ax (HE160) 996-tone RU / Chain 0 : CH 111@67

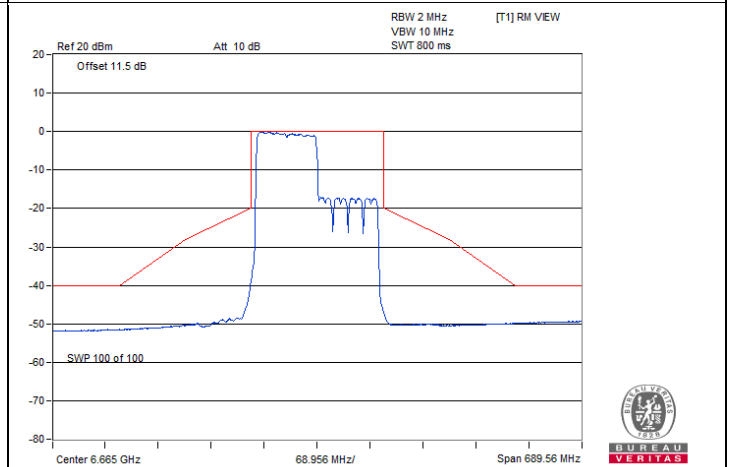

802.11ax (HE160) 996-tone RU / Chain 0 : CH 143@67

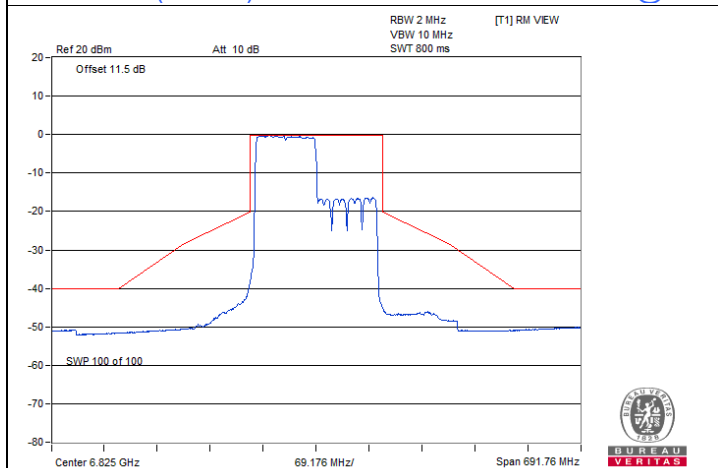

802.11ax (HE160) 996-tone RU / Chain 0 : CH 175@67

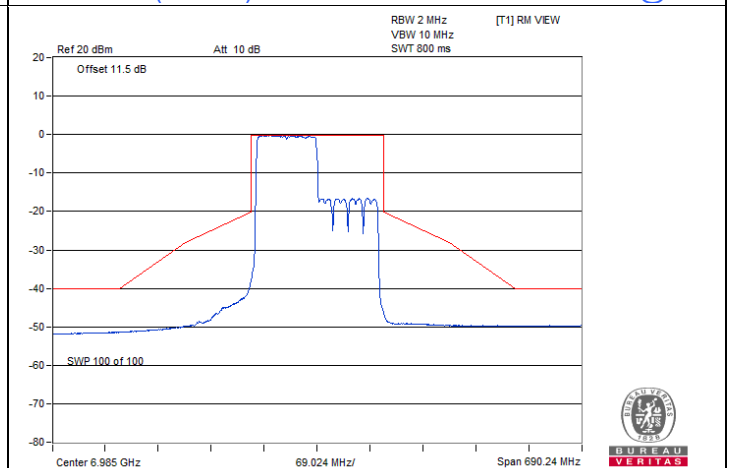

802.11ax (HE160) 996-tone RU / Chain 0 : CH 207@67

Spectrum Plot

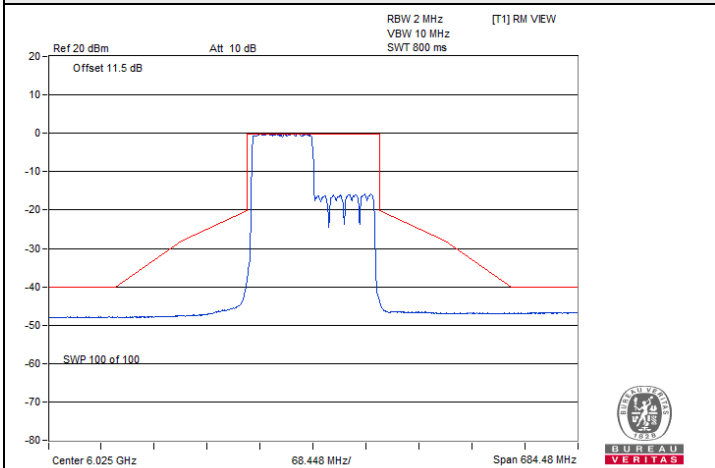

802.11ax (HE160) 996-tone RU / Chain 1 : CH 15@67

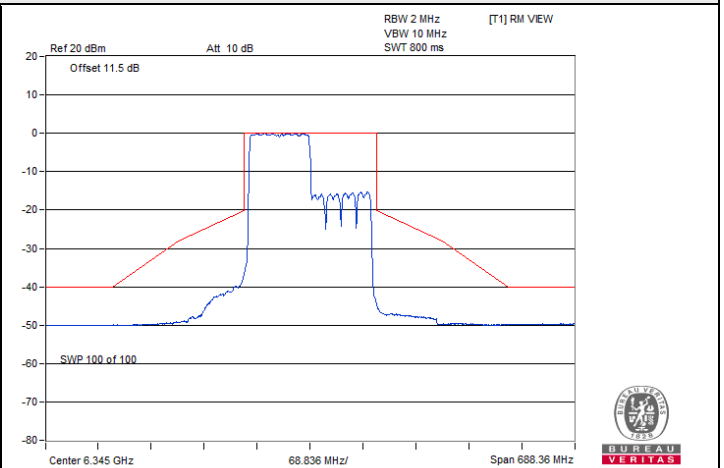

802.11ax (HE160) 996-tone RU / Chain 1 : CH 79@67

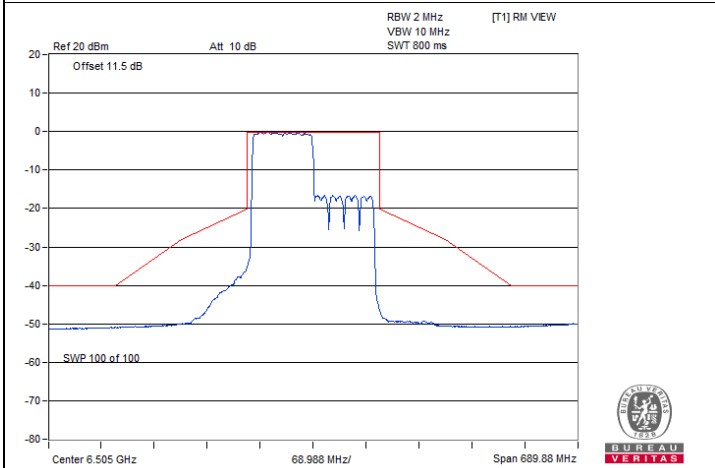

802.11ax (HE160) 996-tone RU / Chain 1 : CH 111@67

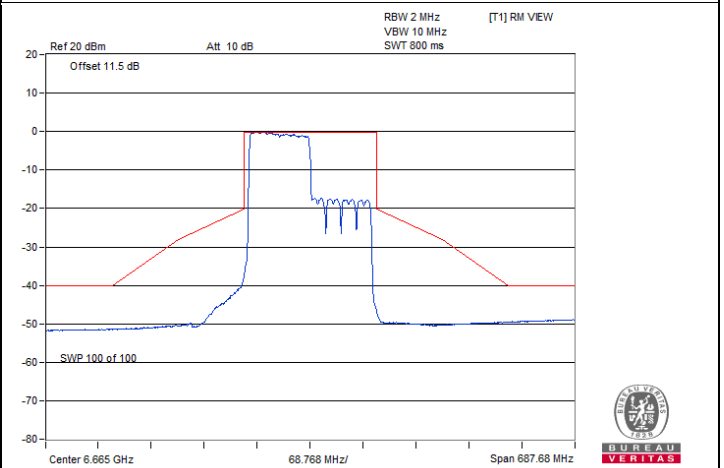

802.11ax (HE160) 996-tone RU / Chain 1 : CH 143@67

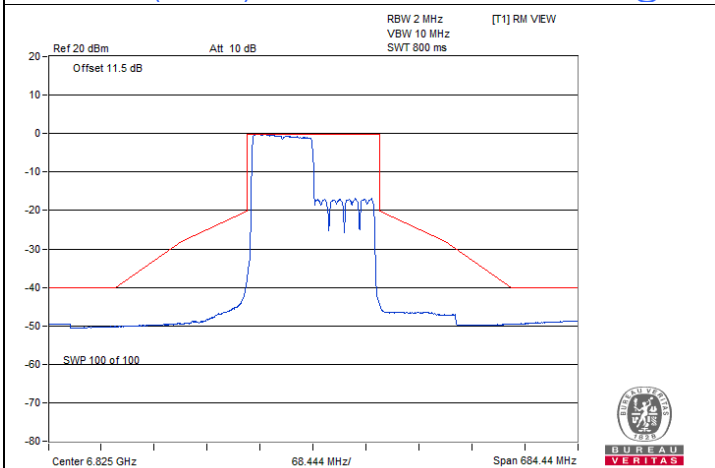

802.11ax (HE160) 996-tone RU / Chain 1 : CH 175@67

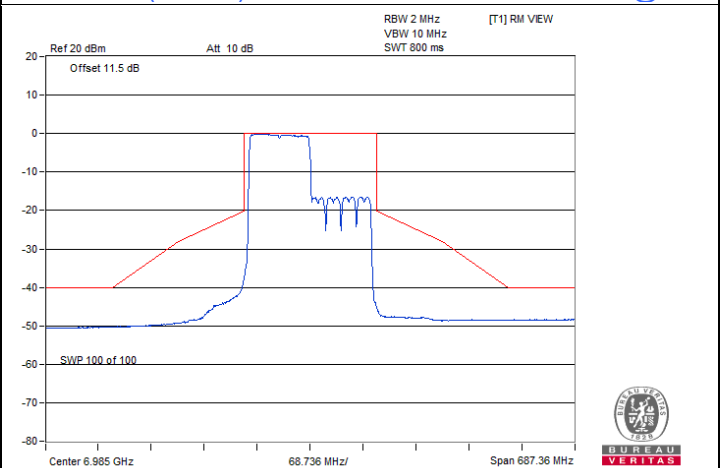

802.11ax (HE160) 996-tone RU / Chain 1 : CH 207@67

7.5 Occupied Bandwidth

| | | | | | |
|--------------|----------------|---------------------------|--------------|------------|-----------------------|
| Input Power: | 120 Vac, 60 Hz | Environmental Conditions: | 25°C, 60% RH | Tested By: | Harry Hsueh / Alan Wu |
|--------------|----------------|---------------------------|--------------|------------|-----------------------|

802.11a

| Channel | Frequency (MHz) | Occupied Bandwidth (MHz) | |
|---------|-----------------|--------------------------|---------|
| | | Chain 0 | Chain 1 |
| 1 | 5955 | 16.44 | 16.44 |
| 45 | 6175 | 16.54 | 16.44 |
| 93 | 6415 | 16.54 | 16.44 |
| 97 | 6435 | 16.44 | 16.44 |
| 105 | 6475 | 16.44 | 16.44 |
| 113 | 6515 | 16.54 | 16.56 |
| 117 | 6535 | 16.54 | 16.44 |
| 149 | 6695 | 16.44 | 16.56 |
| 181 | 6855 | 16.44 | 16.44 |
| 185 | 6875 | 16.54 | 16.56 |
| 209 | 6995 | 18.96 | 18.84 |
| 233 | 7115 | 16.54 | 16.56 |

802.11ax (HE20)

| Channel | Frequency (MHz) | Occupied Bandwidth (MHz) | |
|---------|-----------------|--------------------------|---------|
| | | Chain 0 | Chain 1 |
| 1 | 5955 | 18.94 | 18.96 |
| 45 | 6175 | 18.90 | 18.96 |
| 93 | 6415 | 18.96 | 18.96 |
| 97 | 6435 | 18.96 | 18.96 |
| 105 | 6475 | 18.96 | 18.96 |
| 113 | 6515 | 19.08 | 18.96 |
| 117 | 6535 | 18.96 | 18.96 |
| 149 | 6695 | 18.96 | 18.84 |
| 181 | 6855 | 18.96 | 18.84 |
| 185 | 6875 | 19.08 | 18.96 |
| 209 | 6995 | 18.90 | 18.90 |
| 233 | 7115 | 18.84 | 18.96 |

802.11ax (HE40)

| Channel | Frequency (MHz) | Occupied Bandwidth (MHz) | |
|---------|-----------------|--------------------------|---------|
| | | Chain 0 | Chain 1 |
| 3 | 5965 | 38.16 | 38.16 |
| 43 | 6165 | 37.92 | 37.92 |
| 91 | 6405 | 37.92 | 38.16 |
| 99 | 6445 | 38.16 | 38.16 |
| 107 | 6485 | 38.16 | 37.92 |
| 115 | 6525 | 37.92 | 37.92 |
| 123 | 6565 | 38.16 | 38.16 |
| 155 | 6725 | 38.16 | 38.16 |
| 179 | 6845 | 38.16 | 37.68 |
| 187 | 6885 | 38.16 | 38.16 |
| 211 | 7005 | 38.16 | 38.16 |
| 227 | 7085 | 38.16 | 38.16 |

802.11ax (HE80)

| Channel | Frequency (MHz) | Occupied Bandwidth (MHz) | |
|---------|-----------------|--------------------------|---------|
| | | Chain 0 | Chain 1 |
| 7 | 5985 | 77.28 | 77.28 |
| 39 | 6145 | 77.28 | 77.28 |
| 87 | 6385 | 77.28 | 77.28 |
| 103 | 6465 | 77.28 | 77.28 |
| 119 | 6545 | 77.28 | 77.28 |
| 151 | 6705 | 77.28 | 77.28 |
| 183 | 6865 | 77.04 | 77.28 |
| 199 | 6945 | 77.28 | 77.28 |
| 215 | 7025 | 77.28 | 77.28 |

802.11ax (HE160)

| Channel | Frequency (MHz) | Occupied Bandwidth (MHz) | |
|---------|-----------------|--------------------------|---------|
| | | Chain 0 | Chain 1 |
| 15 | 6025 | 156.48 | 156.48 |
| 47 | 6185 | 156.48 | 156.48 |
| 79 | 6345 | 156.48 | 156.48 |
| 111 | 6505 | 156.48 | 157.44 |
| 143 | 6665 | 156.48 | 156.48 |
| 175 | 6825 | 156.48 | 156.48 |
| 207 | 6985 | 156.48 | 156.48 |

802.11ax (HE20) 26-tone RU

| Channel | Frequency (MHz) | Occupied Bandwidth (MHz) | |
|---------|-----------------|--------------------------|---------|
| | | Chain 0 | Chain 1 |
| 1 | 5955 | 18.66 | 18.84 |
| 93 | 6415 | 18.96 | 18.48 |
| 97 | 6435 | 18.84 | 18.72 |
| 117 | 6535 | 18.48 | 18.60 |
| 181 | 6855 | 18.96 | 18.84 |
| 233 | 7115 | 18.60 | 18.72 |

802.11ax (HE20) 52-tone RU

| Channel | Frequency (MHz) | Occupied Bandwidth (MHz) | |
|---------|-----------------|--------------------------|---------|
| | | Chain 0 | Chain 1 |
| 1 | 5955 | 18.42 | 18.48 |
| 93 | 6415 | 18.36 | 18.24 |
| 97 | 6435 | 18.48 | 18.48 |
| 117 | 6535 | 18.12 | 18.60 |
| 181 | 6855 | 18.48 | 18.36 |
| 233 | 7115 | 18.48 | 18.48 |

802.11ax (HE20) 106-tone RU

| Channel | Frequency (MHz) | Occupied Bandwidth (MHz) | |
|---------|-----------------|--------------------------|---------|
| | | Chain 0 | Chain 1 |
| 1 | 5955 | 18.48 | 18.42 |
| 93 | 6415 | 18.36 | 18.36 |
| 97 | 6435 | 18.36 | 18.48 |
| 117 | 6535 | 18.24 | 18.24 |
| 181 | 6855 | 18.48 | 18.48 |
| 233 | 7115 | 18.36 | 18.24 |

802.11ax (HE40) 242-tone RU

| Channel | Frequency (MHz) | Occupied Bandwidth (MHz) | |
|---------|-----------------|--------------------------|---------|
| | | Chain 0 | Chain 1 |
| 3 | 5965 | 37.92 | 38.16 |
| 91 | 6405 | 37.44 | 37.44 |
| 99 | 6445 | 37.92 | 38.16 |
| 115 | 6525 | 37.44 | 37.92 |
| 123 | 6565 | 37.68 | 37.44 |
| 179 | 6845 | 37.92 | 37.68 |
| 187 | 6885 | 38.16 | 37.44 |
| 227 | 7085 | 37.44 | 37.68 |

802.11ax (HE80) 484-tone RU

| Channel | Frequency (MHz) | Occupied Bandwidth (MHz) | |
|---------|-----------------|--------------------------|---------|
| | | Chain 0 | Chain 1 |
| 7 | 5985 | 77.28 | 76.80 |
| 87 | 6385 | 77.28 | 77.28 |
| 103 | 6465 | 77.28 | 76.80 |
| 119 | 6545 | 76.80 | 76.80 |
| 151 | 6705 | 77.28 | 77.76 |
| 183 | 6865 | 77.76 | 77.28 |
| 199 | 6945 | 77.76 | 77.28 |
| 215 | 7025 | 76.80 | 76.80 |

802.11ax (HE160) 996-tone RU

| Channel | Frequency (MHz) | Occupied Bandwidth (MHz) | |
|---------|-----------------|--------------------------|---------|
| | | Chain 0 | Chain 1 |
| 15 | 6025 | 157.44 | 158.40 |
| 79 | 6345 | 157.44 | 156.48 |
| 111 | 6505 | 157.44 | 157.44 |
| 143 | 6665 | 156.48 | 155.52 |
| 175 | 6825 | 157.44 | 157.44 |
| 207 | 6985 | 157.44 | 159.36 |



Spectrum Plot of Maximum Value

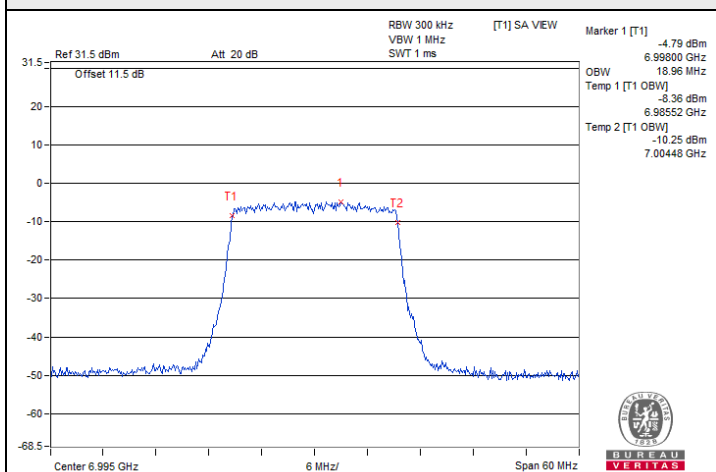

802.11a / Chain 0 : CH 209

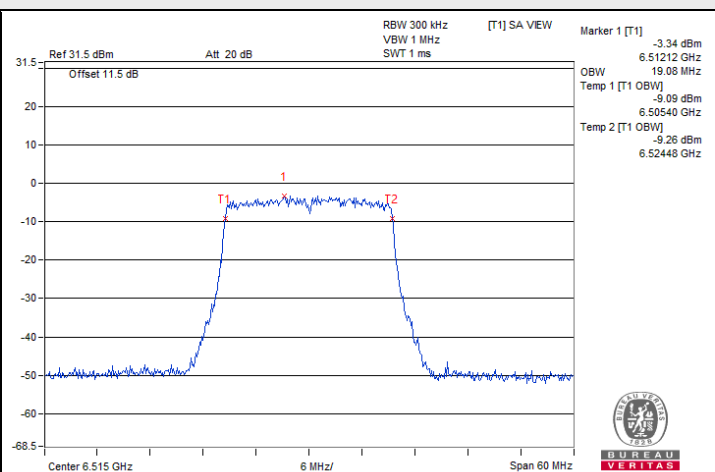

802.11ax (HE20) / Chain 0 : CH 113

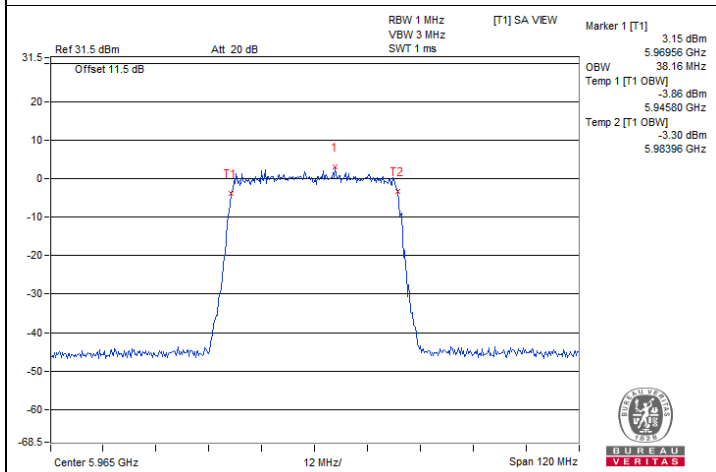

802.11ax (HE40) / Chain 0 : CH 3

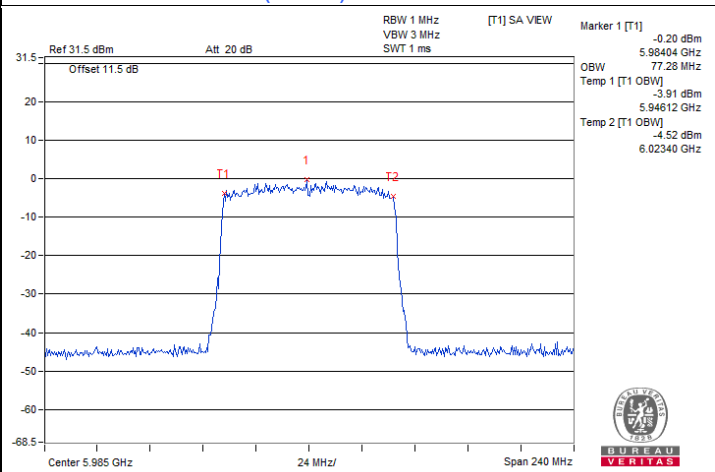

802.11ax (HE80) / Chain 0 : CH 7

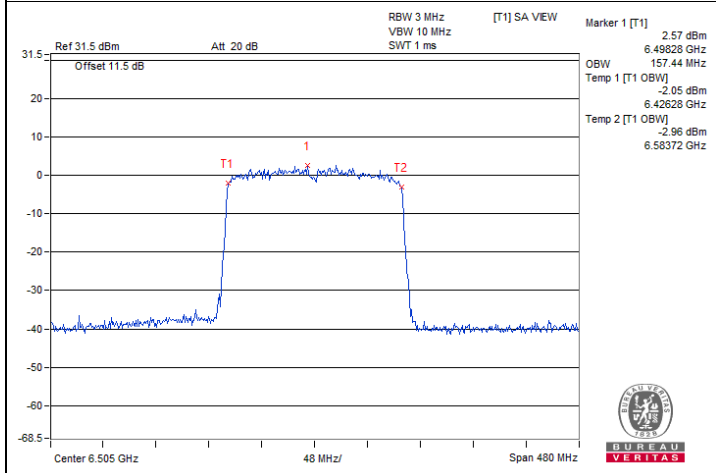

802.11ax (HE160) / Chain 1 : CH 111

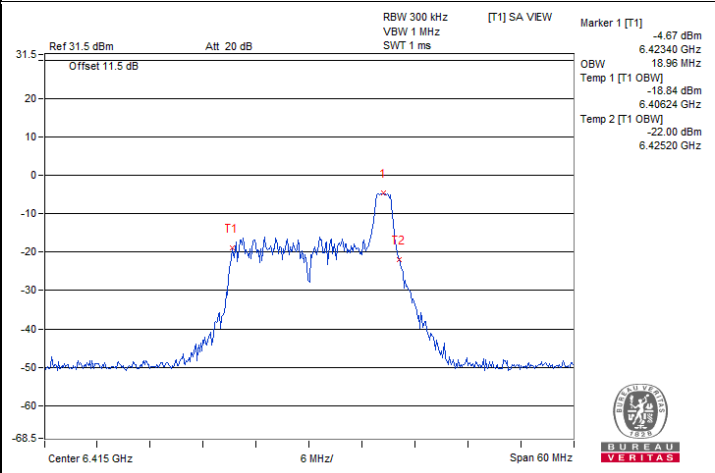

802.11ax (HE20) 26-tone RU / Chain 0 : CH 93@8



Spectrum Plot of Maximum Value

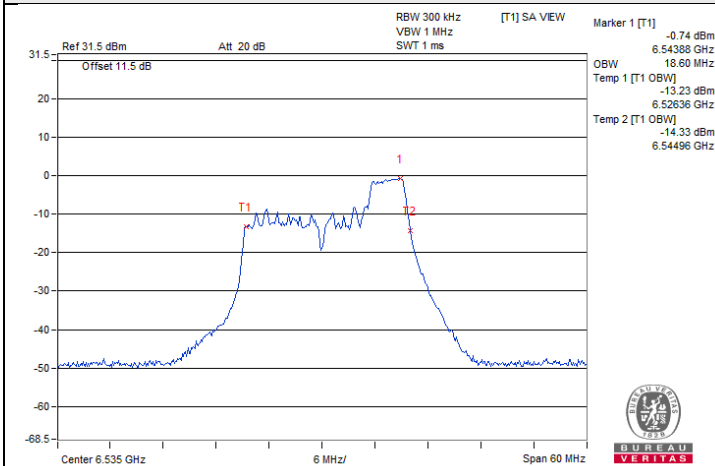

802.11ax (HE20) 52-tone RU / Chain 1 : CH 117@37

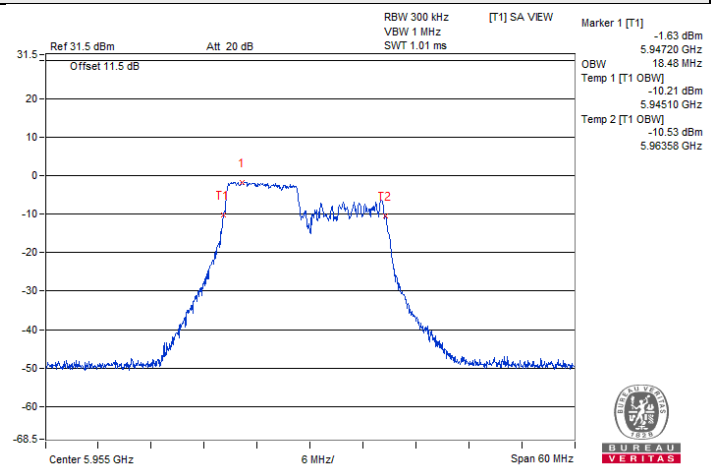

802.11ax (HE20) 106-tone RU / Chain 0 : CH 1@53

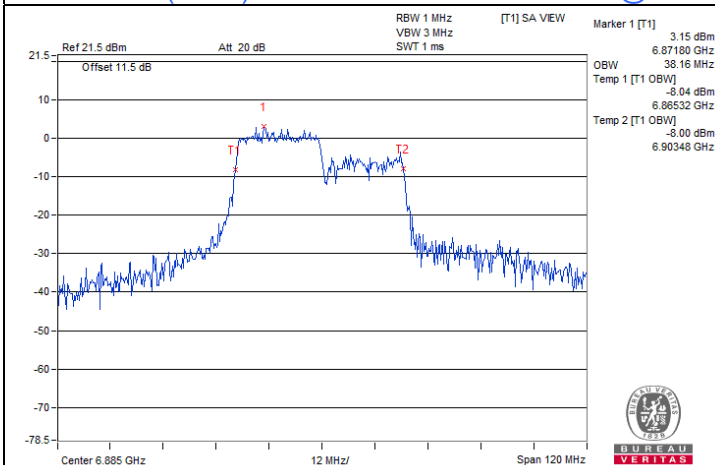

802.11ax (HE40) 242-tone RU / Chain 0 : CH 187@61

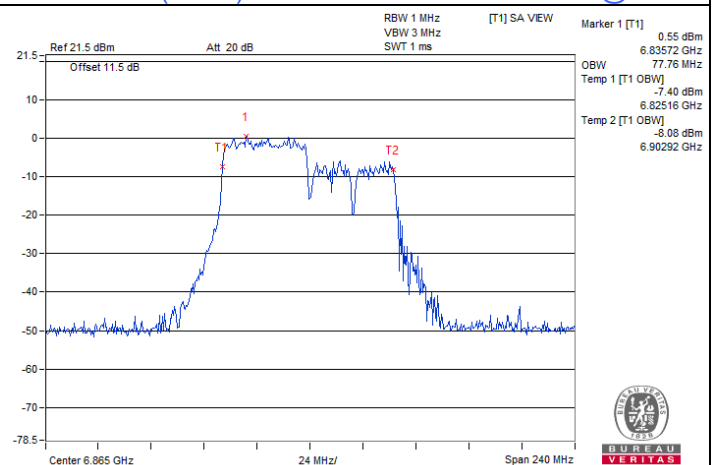

802.11ax (HE80) 484-tone RU / Chain 0 : CH 183@65

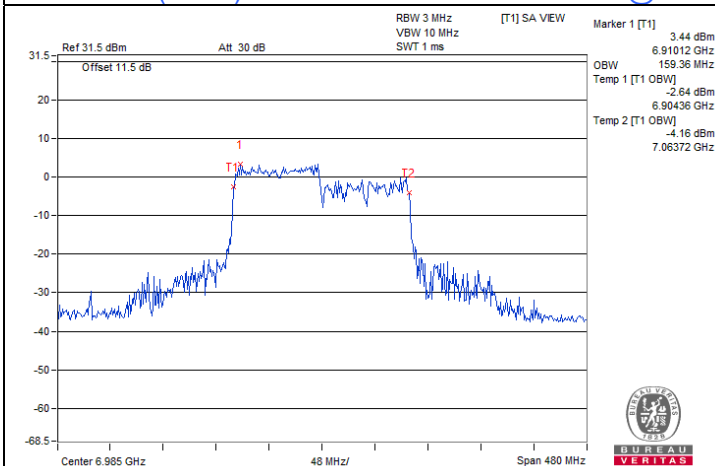

802.11ax (HE160) 996-tone RU / Chain 1 : CH 207@67

7.6 Frequency Stability

| | | | | | |
|--------------|----------------|---------------------------|--------------|------------|-----------------------|
| Input Power: | 120 Vac, 60 Hz | Environmental Conditions: | 25°C, 60% RH | Tested By: | Harry Hsueh / Alan Wu |
|--------------|----------------|---------------------------|--------------|------------|-----------------------|

802.11a

| Frequency Stability Versus Temperature | | | | | | | | | |
|--|--------------------|--------------------------|-------------|--------------------------|-------------|--------------------------|-------------|--------------------------|-------------|
| Operating Frequency: 5955 MHz | | | | | | | | | |
| Temp. (°C) | Power Supply (Vac) | 0 Minute | | 2 Minutes | | 5 Minutes | | 10 Minutes | |
| | | Measured Frequency (MHz) | Test Result | Measured Frequency (MHz) | Test Result | Measured Frequency (MHz) | Test Result | Measured Frequency (MHz) | Test Result |
| 40 | 120 | 5954.9969 | Pass | 5954.9956 | Pass | 5954.9979 | Pass | 5954.9968 | Pass |
| 30 | 120 | 5954.9811 | Pass | 5954.9823 | Pass | 5954.9803 | Pass | 5954.9803 | Pass |
| 20 | 120 | 5954.9877 | Pass | 5954.9908 | Pass | 5954.9874 | Pass | 5954.9888 | Pass |
| 10 | 120 | 5955.0007 | Pass | 5955.0027 | Pass | 5955.0011 | Pass | 5955.0016 | Pass |
| 0 | 120 | 5955.0201 | Pass | 5955.0198 | Pass | 5955.0191 | Pass | 5955.0212 | Pass |

| Frequency Stability Versus Voltage | | | | | | | | | |
|------------------------------------|--------------------|--------------------------|-------------|--------------------------|-------------|--------------------------|-------------|--------------------------|-------------|
| Operating Frequency: 5955 MHz | | | | | | | | | |
| Temp. (°C) | Power Supply (Vac) | 0 Minute | | 2 Minutes | | 5 Minutes | | 10 Minutes | |
| | | Measured Frequency (MHz) | Test Result | Measured Frequency (MHz) | Test Result | Measured Frequency (MHz) | Test Result | Measured Frequency (MHz) | Test Result |
| 20 | 138 | 5954.9911 | Pass | 5954.9936 | Pass | 5954.9905 | Pass | 5954.9911 | Pass |
| | 120 | 5954.9877 | Pass | 5954.9908 | Pass | 5954.9874 | Pass | 5954.9888 | Pass |
| | 102 | 5954.977 | Pass | 5954.9774 | Pass | 5954.9791 | Pass | 5954.9756 | Pass |

7.7 Contention-based Protocol

| | | | |
|---------------------------|--------------|------------|--------------|
| Environmental Conditions: | 23°C, 62% RH | Tested By: | Matthew Yang |
|---------------------------|--------------|------------|--------------|

For Companion Device

| Companion Device Information | | | |
|------------------------------|---------|-----------|---------------------------|
| Product | Brand | Model No. | Software/Firmware Version |
| Router | NETGEAR | RAXE500 | V1.0.10.86_2.0.40 |



| Contention Based Protocol Measurement | | | | | | | | | | | |
|---------------------------------------|-------------------------|----------------|---------------------|------------------------|-------------|--------------------|-------------------------|----------------------|-----------------|---------------|---------|
| Operation Mode | Channel Bandwidth (MHz) | Channel Number | Channel Freq. (MHz) | Injected Signal (AWGN) | | Antenna Gain (dBi) | Path Loss (dB) (Note 3) | Adjusted Power (dBm) | Detection Limit | EUT TX Status | |
| | | | | Freq. (MHz) | Power (dBm) | | | | | | |
| 802.11ax | 20 | 45 | 6175 | 6175 | -74 | 3.93 | 0 | -77.93 | -62 | OFF | |
| | | | | | -78 | 3.93 | 0 | -81.93 | -62 | Minimal | |
| | | | | | -78.07 | 3.93 | 0 | -82 | -62 | ON | |
| | 160 | 47 | 6185 | 6110 | -71 | 3.93 | 0 | -74.93 | -62 | OFF | |
| | | | | | -74 | 3.93 | 0 | -77.93 | -62 | Minimal | |
| | | | | | -78.07 | 3.93 | 0 | -82 | -62 | ON | |
| | | | | 6185 | -66 | 3.93 | 0 | -69.93 | -62 | OFF | |
| | | | | | -70 | 3.93 | 0 | -73.93 | -62 | Minimal | |
| | | | | | -78.07 | 3.93 | 0 | -82 | -62 | ON | |
| | | | | | 6260 | -68 | 3.93 | 0 | -71.93 | -62 | OFF |
| | | | | | | -72 | 3.93 | 0 | -75.93 | -62 | Minimal |
| | | | | | | -78.07 | 3.93 | 0 | -82 | -62 | ON |

Notes:

1. After investigation (consider antenna gain and path loss), the one representative port (Ant. 2) was measured and presented in the report.
2. Adjusted Power (dBm) = Injected Signal (AWGN) Power (dBm) - Antenna Gain (dBi) + Path Loss (dB)
3. Antenna gain values include all the applicable path losses.

| Contention Based Protocol Detection Probability | | | | | | | | | | | | | | | |
|---|-------------------------|-------------------------|-----|-----|-----|-----|-----|-----|-----|-----|-----|------|-----------------------|-----------------|-------------|
| Operation Mode | Channel Bandwidth (MHz) | AWGN Signal Freq. (MHz) | #01 | #02 | #03 | #04 | #05 | #06 | #07 | #08 | #09 | #10 | Detection Probability | Detection Limit | Test Result |
| | | | | | | | | | | | | | | | |
| 160 | 6110 | v | v | v | v | v | v | v | v | v | v | 100% | 90% | Pass | |
| | 6185 | v | v | v | v | v | v | v | v | v | v | 100% | 90% | Pass | |
| | 6260 | v | v | v | v | v | v | v | v | v | v | 100% | 90% | Pass | |

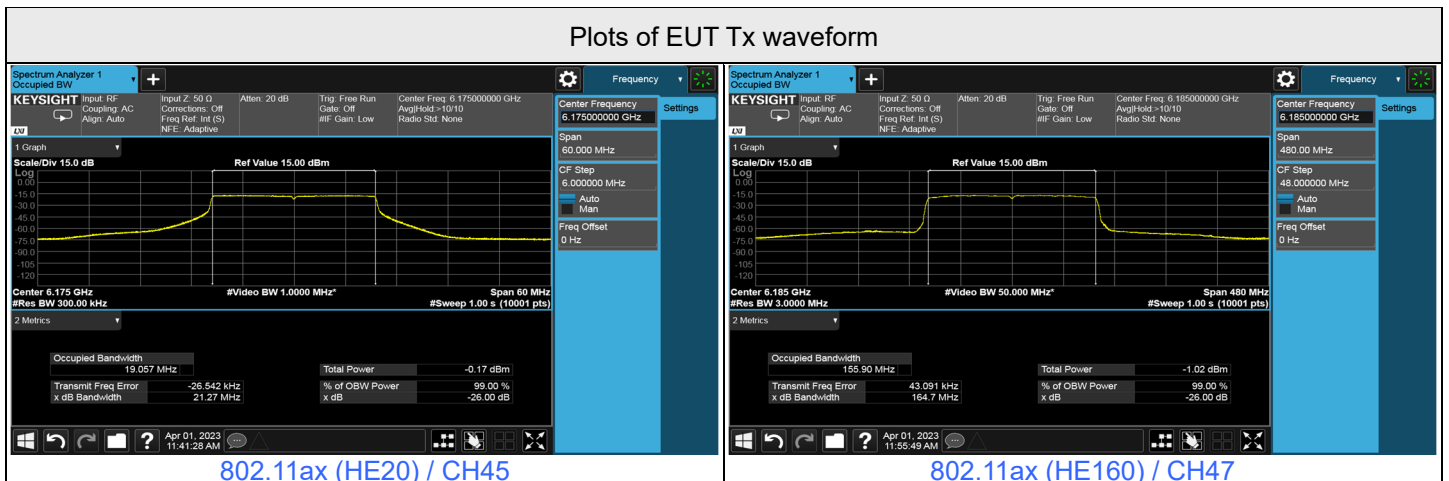

Plots of Injected signal (AWGN) level

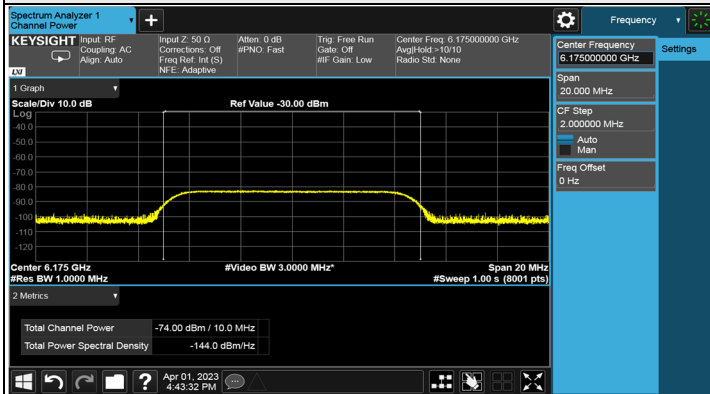

802.11ax (HE20) / CH45

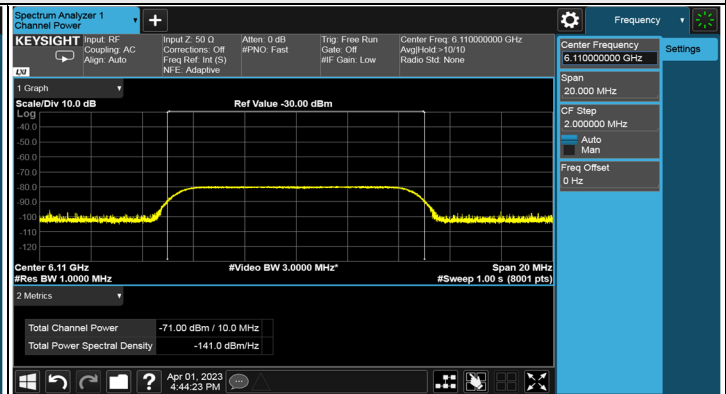

802.11ax (HE160) / CH47(Low Edge)

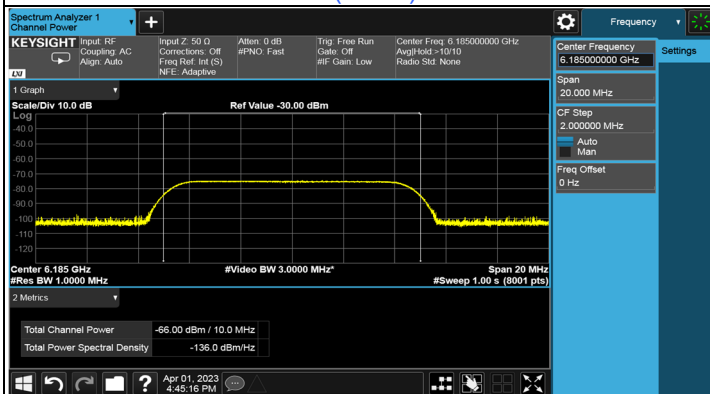

802.11ax (HE160) / CH47(Middle)

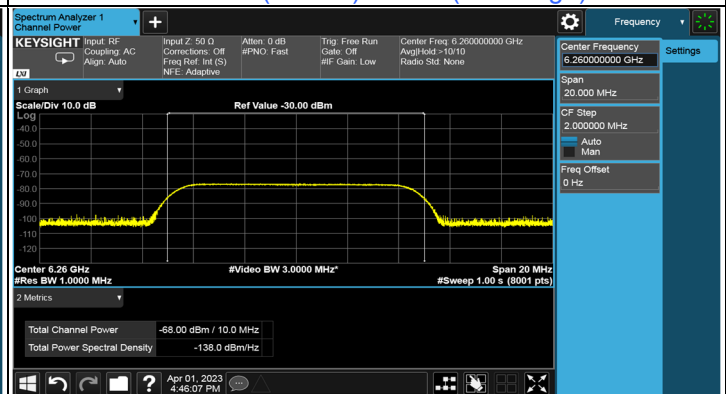

802.11ax (HE160) / CH47(High Edge)

Plots of EUT ceased transmission in the time domain

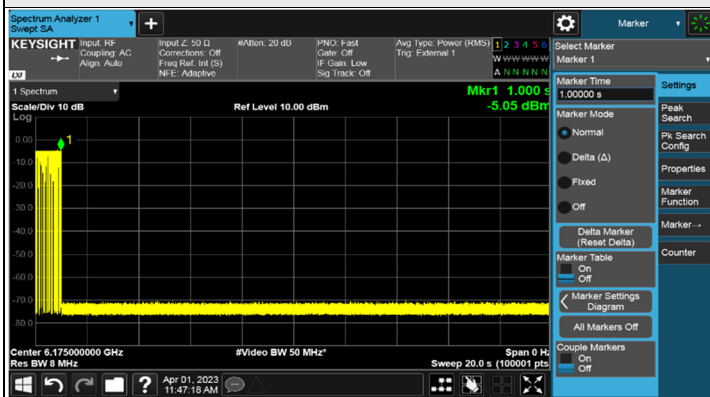

802.11ax (HE20) / CH45

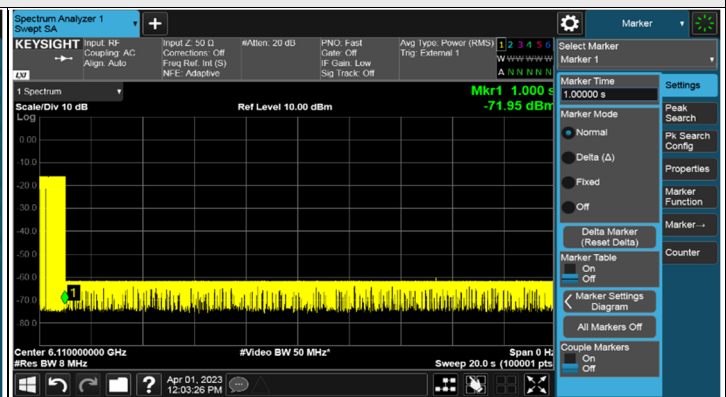

802.11ax (HE160) / CH47(Low Edge)

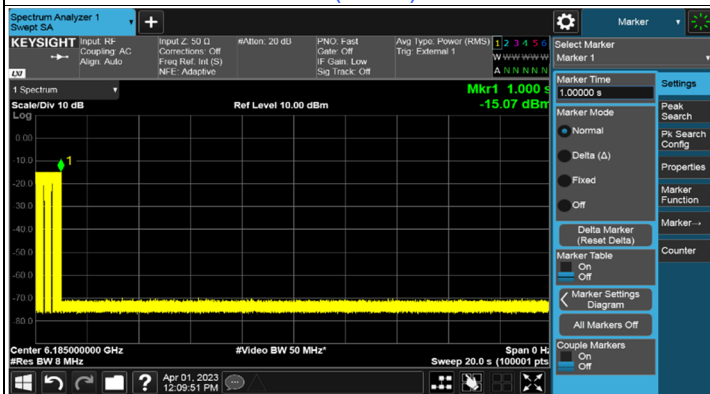

802.11ax (HE160) / CH47(Middle)

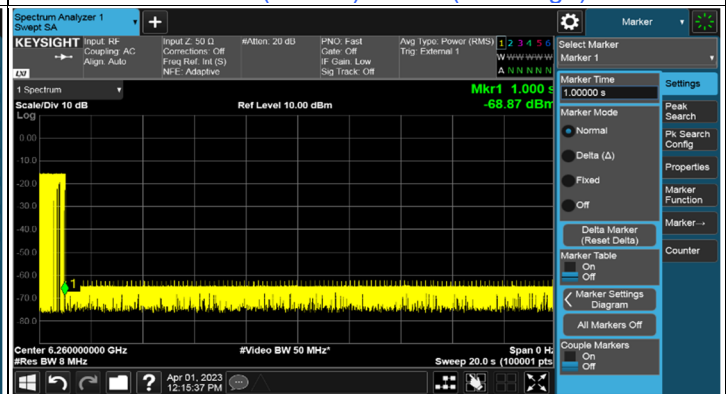

802.11ax (HE160) / CH47(High Edge)



| Contention Based Protocol Measurement | | | | | | | | | | |
|---------------------------------------|-------------------------|----------------|---------------------|------------------------|-------------|--------------------|-------------------------|----------------------|-----------------|---------------|
| Operation Mode | Channel Bandwidth (MHz) | Channel Number | Channel Freq. (MHz) | Injected Signal (AWGN) | | Antenna Gain (dBi) | Path Loss (dB) (Note 3) | Adjusted Power (dBm) | Detection Limit | EUT TX Status |
| | | | | Freq. (MHz) | Power (dBm) | | | | | |
| 802.11ax | 20 | 105 | 6475 | 6475 | -72 | 4.08 | 0 | -76.08 | -62 | OFF |
| | | | | | -76 | 4.08 | 0 | -80.08 | -62 | Minimal |
| | | | | | -77.92 | 4.08 | 0 | -82 | -62 | ON |
| | 160 | 111 | 6505 | 6430 | -66 | 4.08 | 0 | -70.08 | -62 | OFF |
| | | | | | -70 | 4.08 | 0 | -74.08 | -62 | Minimal |
| | | | | | -77.92 | 4.08 | 0 | -82 | -62 | ON |
| | | | | 6505 | -62 | 4.08 | 0 | -66.08 | -62 | OFF |
| | | | | | -66 | 4.08 | 0 | -70.08 | -62 | Minimal |
| | | | | | -77.92 | 4.08 | 0 | -82 | -62 | ON |
| | 6580 | -68 | 4.08 | 0 | -72.08 | -62 | OFF | | | |
| | | -72 | 4.08 | 0 | -76.08 | -62 | Minimal | | | |
| | | -77.92 | 4.08 | 0 | -82 | -62 | ON | | | |

Notes:

1. After investigation (consider antenna gain and path loss), the one representative port (Ant. 1) was measured and presented in the report.
2. Adjusted Power (dBm) = Injected Signal (AWGN) Power (dBm) - Antenna Gain (dBi) + Path Loss (dB)
3. Antenna gain values include all the applicable path losses.

| Contention Based Protocol Detection Probability | | | | | | | | | | | | | | | |
|---|-------------------------|-------------------------|-----|-----|-----|-----|-----|-----|-----|-----|-----|-----|-----------------------|-----------------|-------------|
| Operation Mode | Channel Bandwidth (MHz) | AWGN Signal Freq. (MHz) | #01 | #02 | #03 | #04 | #05 | #06 | #07 | #08 | #09 | #10 | Detection Probability | Detection Limit | Test Result |
| 802.11ax | 20 | 6475 | v | v | v | v | v | v | v | v | v | v | 100% | 90% | Pass |
| | 160 | 6430 | v | v | v | v | v | v | v | v | v | v | 100% | 90% | Pass |
| | | 6505 | v | v | v | v | v | v | v | v | v | v | 100% | 90% | Pass |
| | | 6580 | v | v | v | v | v | v | v | v | v | v | 100% | 90% | Pass |

