



Test Report

FCC Part 15, Subpart C, Section 15.247 Industry Canada RSS-210, Issue 8

Report Number: HTT-B2EX-BATT-Cert

Model: HTT-B2EX-BATT

FCC ID: EROHTT-B2EX
IC: 5683C-HTTB2EX

Date: June 4, 2013

Prepared by: Grace Lin
Grace Lin, Sr. Compliance Engineer

Date: June 4, 2013

Reviewed by: Wayne Owens
Wayne Owens, Director of Program Management

Date: June 4, 2013



Table of Contents

1. GENERAL DESCRIPTION	3
1.1 PRODUCT DESCRIPTION	3
1.2 TEST METHODOLOGY	3
1.3 TEST FACILITY.....	3
1.4 TEST EQUIPMENT.....	4
1.5 EVALUATION SUMMARY	4
2. SYSTEM TEST CONFIGURATION	5
2.1 JUSTIFICATION	5
2.2 BLOCK DIAGRAM.....	5
2.3 EUT EXERCISE SOFTWARE AND MODE(S) OF OPERATION.....	5
2.4 CABLES.....	5
2.5 SPECIAL ACCESSORIES.....	6
2.6 SUPPORT EQUIPMENT	6
2.7 EQUIPMENT MODIFICATIONS	6
3. EVALUATION	7
3.1 ANTENNA REQUIREMENTS.....	7
3.2 DTS BANDWIDTH	8
3.3 99% BANDWIDTH	11
3.4 POWER OUTPUT	13
3.5 BAND EDGE	16
3.6 CONDUCTED SPURIOUS EMISSIONS	18
3.7 POWER SPECTRAL DENSITY	22
3.8 RADIATED SPURIOUS EMISSIONS	25



1. General Description

1.1 Product Description

The equipment under test (EUT) is a Crestron Battery-Powered infiNET EX 2-Button Wireless Keypad operating at 2.4 GHz frequency band, model: HTT-B2EX-BATT, serial number: CNA 8113463.

1.2 Test Methodology

Measurements were performed according to the following procedures and standards:

- 1) ANSI C63.4-2003
- 2) FCC Publication, "Guidance for Performing Compliance Measurements on Digital Transmission Systems (DTS) Operating under §15.247", April 9, 2013
- 3) Industry Canada RSS-Gen Issue 3
- 4) Industry Canada RSS-210 Issue 8

All measurements were performed in a 3-meter semi-anechoic chamber and the control room.

1.3 Test Facility

The 3-meter semi-anechoic chamber used to collect conducted and radiated emission data is located at 22 Link Drive, Rockleigh, New Jersey. This test facility has been placed on file with the FCC, Registration Number: 412871, and Industry Canada, Site Number: 5683C-1.



1.4 Test Equipment

Description	Model	Serial No.	Frequency Range	Calibration Date
R&S EMI Receiver	ESU40	100076	20 Hz – 40 GHz	Dec. 13, 2012
Teseq Bilog Antenna	CBL 6112D	25231	30 MHz – 2 GHz	Dec. 11, 2012
ETS-Lindgren Double Ridge Horn Antenna	3117	00047560	1 GHz – 18 GHz	Feb. 23, 2013
R&S Preamplifier	TS-PR18	100044	30 MHz – 18 GHz	Dec. 11, 2012
ETS-Lindgren Standard Gain Horn Antenna	3160-09	00078911	18 GHz – 26.5 GHz	Feb. 5, 2013*
R&S Preamplifier	TS-PR26	100030	18 GHz – 26.5 GHz	Dec. 11, 2012

*Mechanical inspection

1.5 Evaluation Summary

Rule Section		Description/Parameters	Results
FCC	IC		
§15.203	N/A	Antenna Requirement	Complies
§15.247(a)(2)	§A8.2(a) of RSS-210	DTS Bandwidth, 500 kHz	Complies
N/A	§4.6.1 of RSS-Gen	99% Occupied Bandwidth	(for reporting purpose)
§15.247(b)(3)	§A8.4(4) of RSS-210	Power Output, conducted, 1 Watt (30dBm)	Complies
§15.247(d)	§2.1, §A8.5 of RSS-210	Band Edge	Complies
§15.247(d)	§A8.5 of RSS-210	Conducted Spurious Emissions, 20 dBc	Complies
§15.247(e)	§A8.2(b) of RSS-210	Power Spectral Density (PSD), 8 dBm in any 3 kHz band.	Complies
§15.205, §15.209, §15.247(d)	§2.2, §A8.5 of RSS-210	Radiated Spurious Emissions	Complies
§15.207	§7.2.4 of RSS-Gen	Transmitter AC Power Line Conducted Emissions	Complies

Note:

The channels selected for test were 11, 18, and 26.

2. System Test Configuration

2.1 Justification

In order for a DC power supply to supply power to the EUT and to access the test port, plastic enclosure was removed during measurement. A computer supplied test commands to the gateway through a control system.

2.2 Block Diagram

Block diagram is shown below.

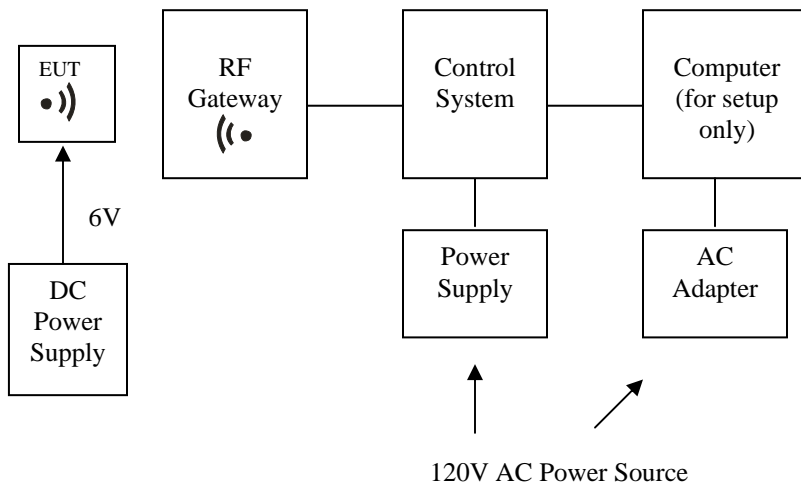

2.3 EUT Exercise Software and Mode(s) of Operation

The EUT was configured to transmit continuously. The firmware loaded in the test sample was *htt-b2ex-batt_0.004.0025.upg*. Channels 11 (2405 MHz), 18 (2440 MHz), and 26 (2480 MHz) were selected for test.

2.4 Cables

Qty	Description	Length (m)	From - To	Shielded/ Unshielded
1	Power Cord	2.4	Power Source – Power Supply	Unshielded
1	Cresnet Cable	2.2	Control System – Gateway	Unshielded
1	Null Modem	4.5	Computer – Control System	Shielded



2.5 *Special Accessories*

There are no special accessories for compliance of this EUT.

2.6 *Support equipment*

Qty	Description	Manufacturer	Model No	Serial No
1	Computer	DELL	PP02X	Service Tag HS5GY61
1	AC Adapter	DELL	LA90PS0-00	CN-0DF266-71615-681-134F
1	Control System	Crestron	QM-RMCRX-BA	3139557
1	Power Supply	Crestron	PW-2420 RU	RoHS140442113/10
1	Gateway	Crestron	CEN-RFGW-EX	SNX106842
1	DC Power Supply	BK Precision	1670	281-2152

2.7 *Equipment Modifications*

There were no modifications installed during compliance measurements.



3. Evaluation

3.1 *Antenna Requirements*

This module is validated with a SMD antenna having antenna gain of 1.9 dBi.

The soldering pads of the SMD antenna is unique in the sense of complying with FCC §15.203, §15.204(b), and §15.204(c).



3.2 DTS Bandwidth

Performance Criterion: The minimum DTS bandwidth shall be at least 500 kHz.

Test Results: Complies

Test Details: Refers to the following block diagram, data table, and receiver screen captures. The EUT was tested in a continuous transmit mode at the maximum power levels.

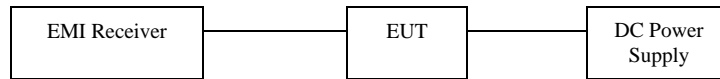

Channel	Frequency (MHz)	DTS Bandwidth (kHz)
11	2405	1602.6
18	2440	1586.6
26	2480	1594.6

Note: The RF level in the plots is relative and is not the indication of RF output power.



DTS Bandwidth, Channel 11:

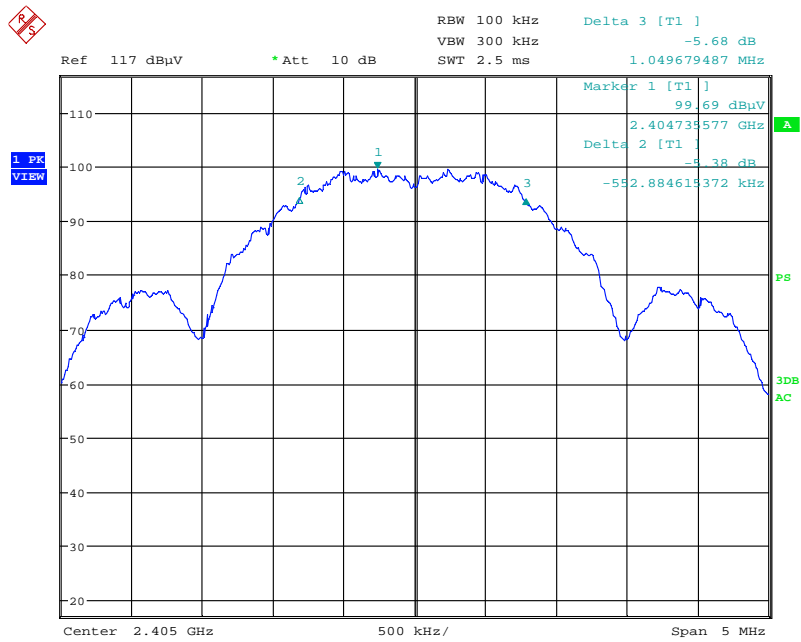

Date: 17.MAY.2013 13:36:05

DTS Bandwidth, Channel 18:

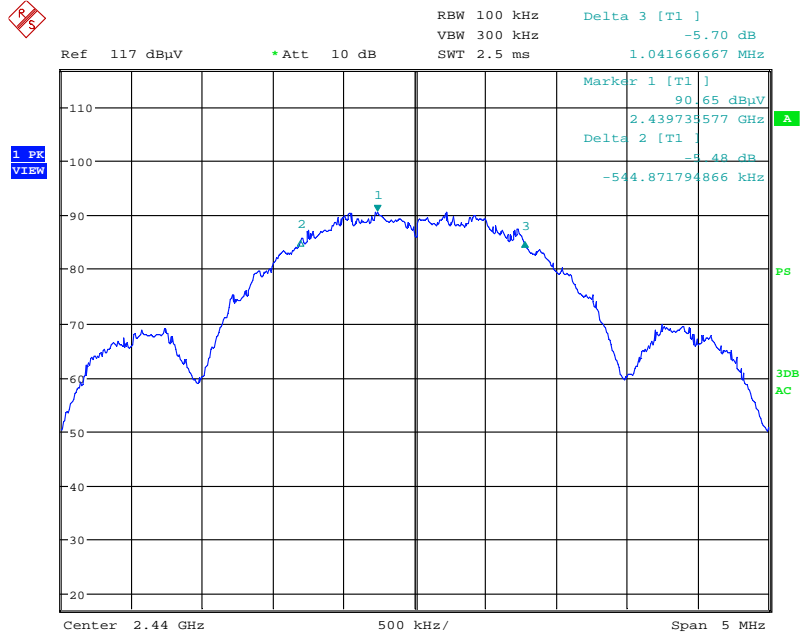

Date: 4.JUN.2013 15:23:13



DTS Bandwidth, Channel 26:

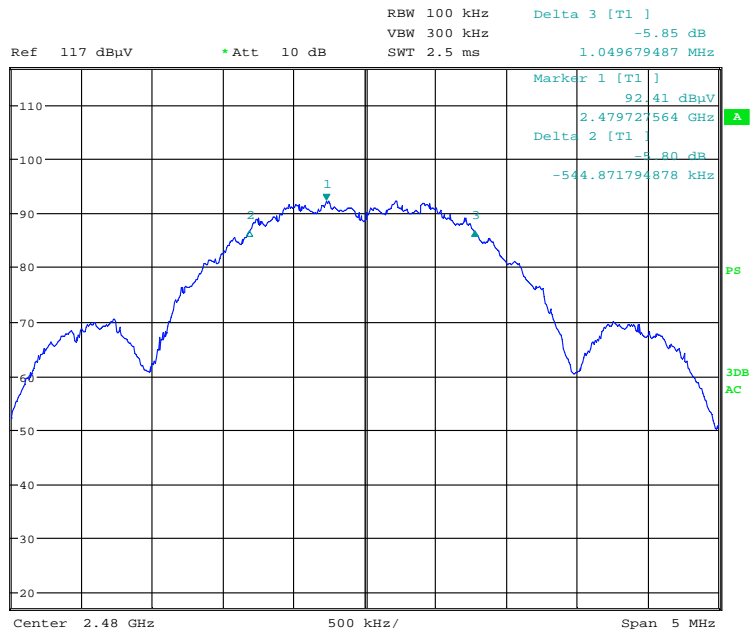

Date: 17.MAY.2013 13:50:46



3.3 99% Bandwidth

Test Details: Refers to the following block diagram, data table, and receiver screen captures. The EUT was tested in a continuous transmit mode at the maximum power levels.



Channel	Frequency (MHz)	99% Bandwidth (MHz)
11	2405	2.44
18	2440	2.44
26	2480	2.44

Note: The RF level in the plots is relative and is not the indication of RF output power.

99% Bandwidth, Channel 11:

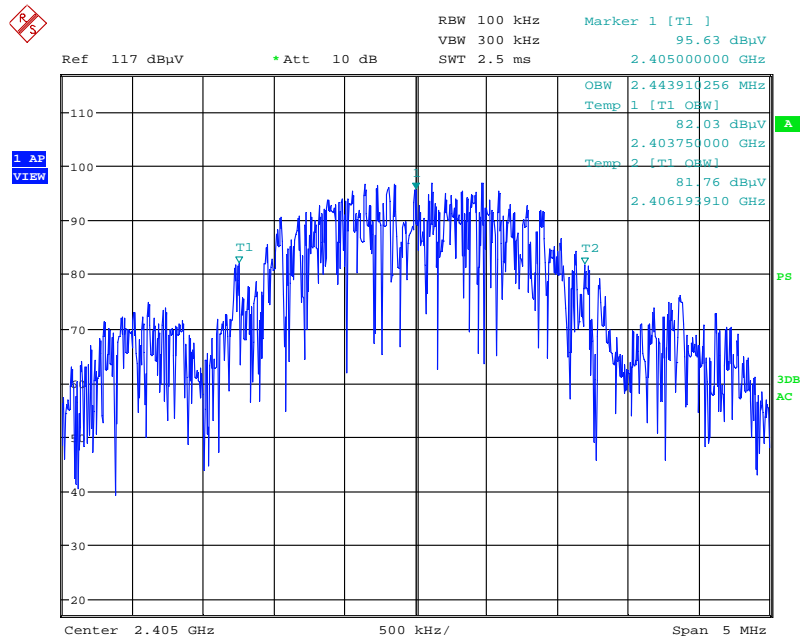

Date: 17.MAY.2013 13:53:55



3.4 Power Output

Performance Criterion: The maximum peak conducted output power shall not exceed 1 Watt.

Test Results: Complies

Test Details: The EUT was tested in a continuous transmit mode with maximum power levels. Refers to the following block diagram, data table, and receiver screen captures.



Channel	Frequency (MHz)	Power Level	Power	
			dBm	mW
11	2405	8	7.20	5.2481
18	2440	8	6.79	4.7753
26	2480	1	0.11	1.0257

Note: The insertion loss was compensated for in the receiver.



Power Output, Channel 11:

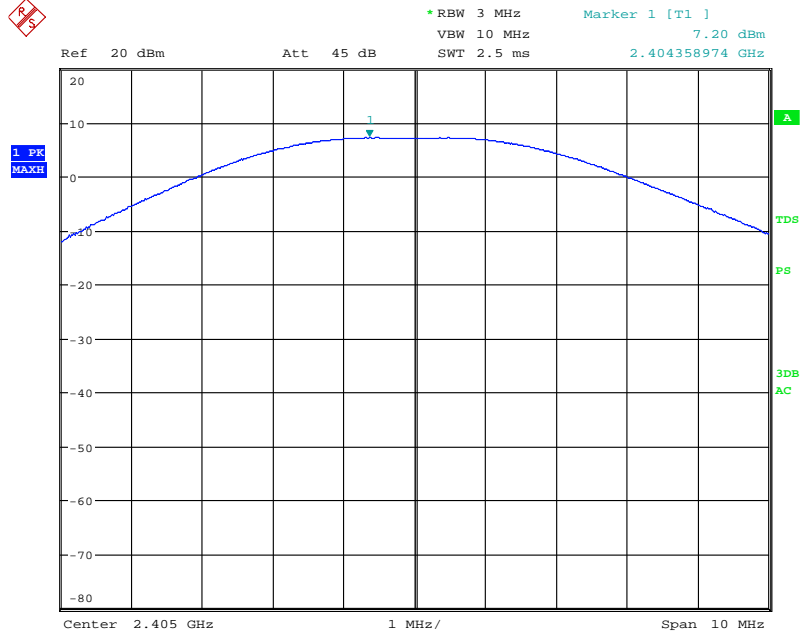

Date: 17.MAY.2013 15:39:20

Power Output, Channel 18:

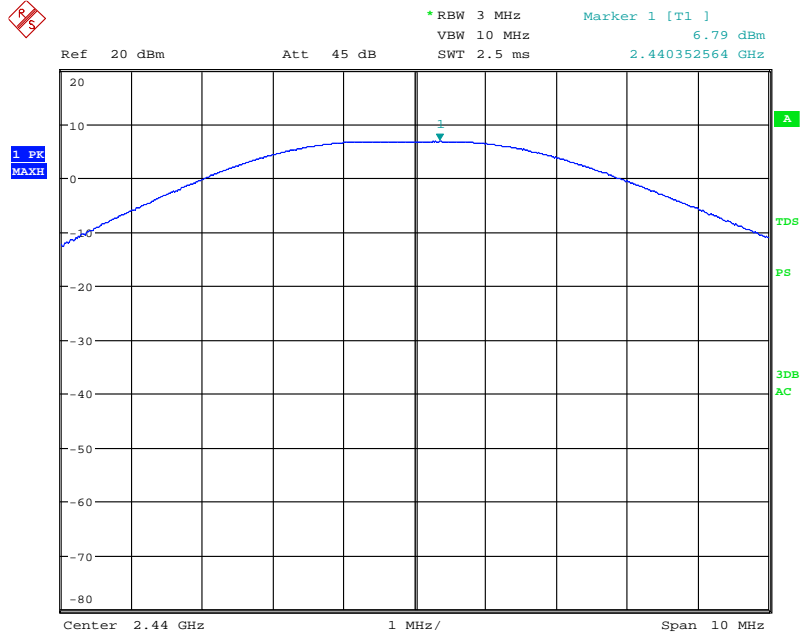

Date: 17.MAY.2013 15:40:44



Power Output, Channel 26:

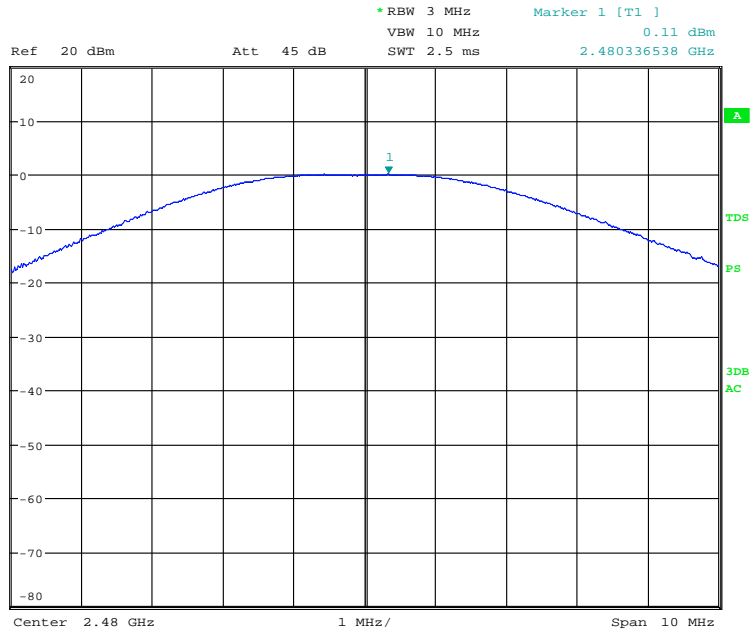

Date: 17.MAY.2013 15:42:27



3.5 *Band Edge*

Performance Criterion: In any 100 kHz bandwidth outside the frequency band, the RF power shall be at least 20 dB below that in the 100 kHz bandwidth within the band.

Test Results: Complies

Test Details: Refers to the following block diagram and receiver screen captures

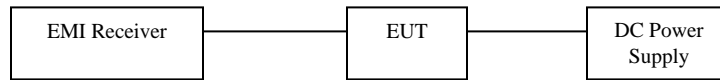



Band Edge:

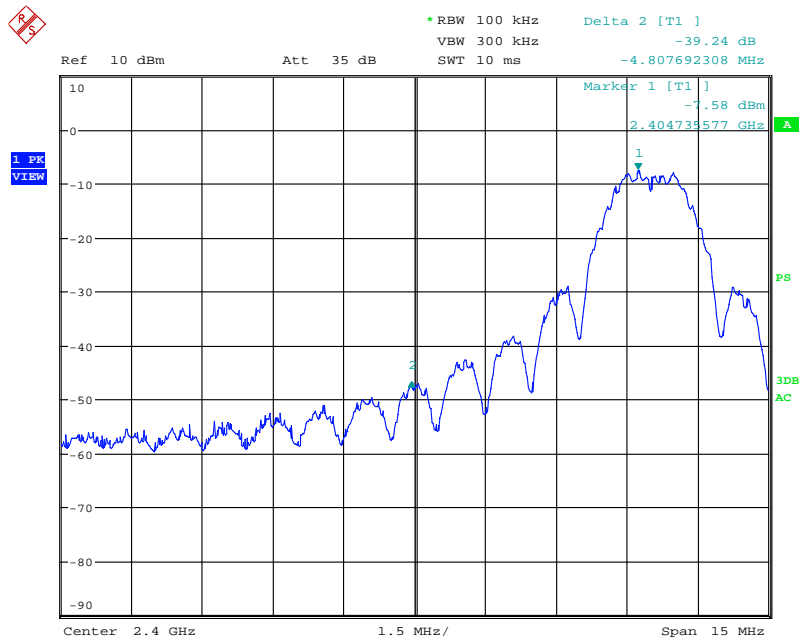

Date: 17.MAY.2013 13:57:01

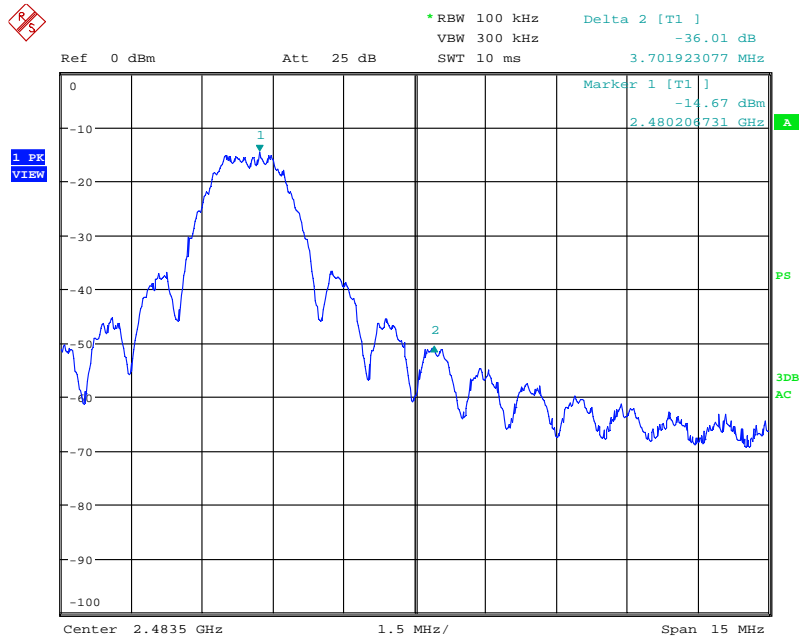

Date: 17.MAY.2013 14:01:30



3.6 *Conducted Spurious Emissions*

Performance Criterion: In any 100 kHz bandwidth outside the frequency band, the radio frequency power shall be at least 20 dB below that in the 100 kHz bandwidth within the band.

Test Results: Complies

Test Details: Refers to the following block diagram and receiver screen captures

Note: The EUT was tested in a continuous transmit mode at the maximum power levels. The RF level in the screen captures is relative and is not the indication of RF output power.





Conducted Spurious Emission – Channel 11

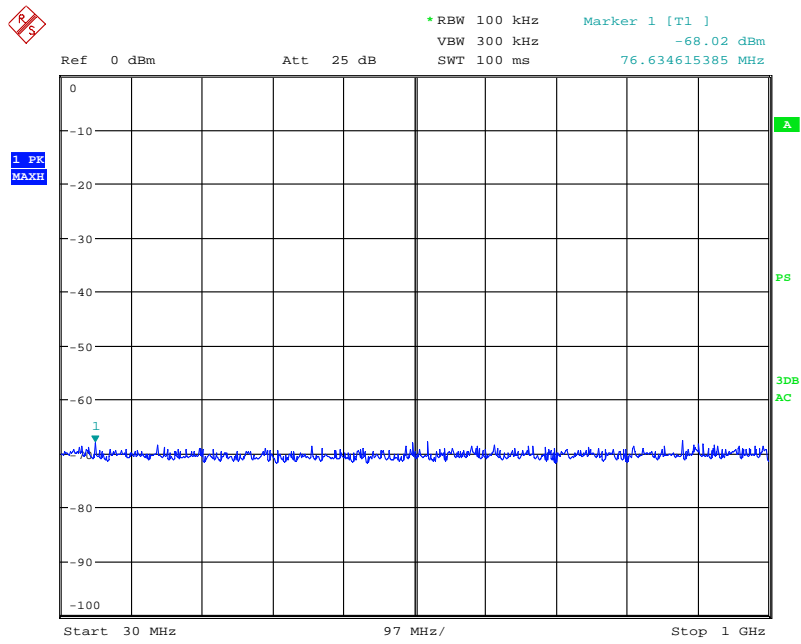

Date: 17.MAY.2013 14:08:41

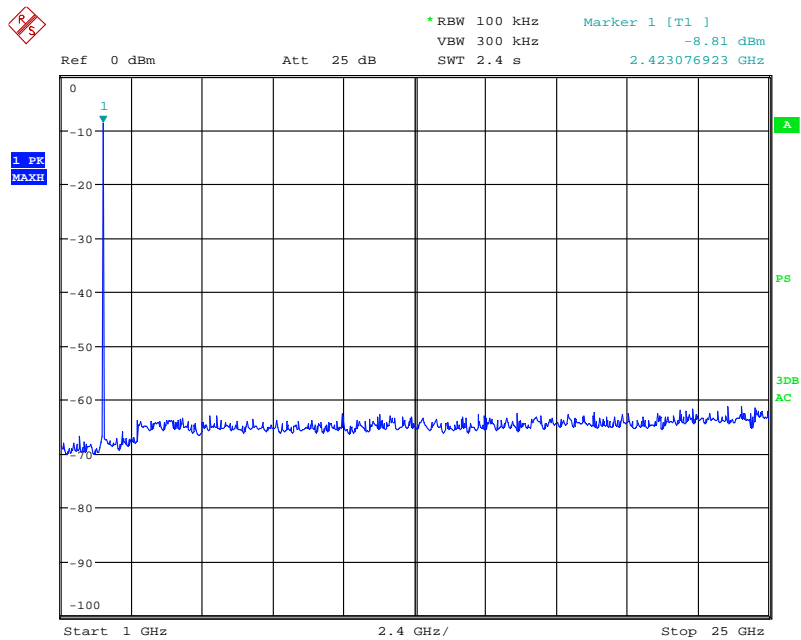

Date: 17.MAY.2013 14:08:16



Conducted Spurious Emission – Channel 18

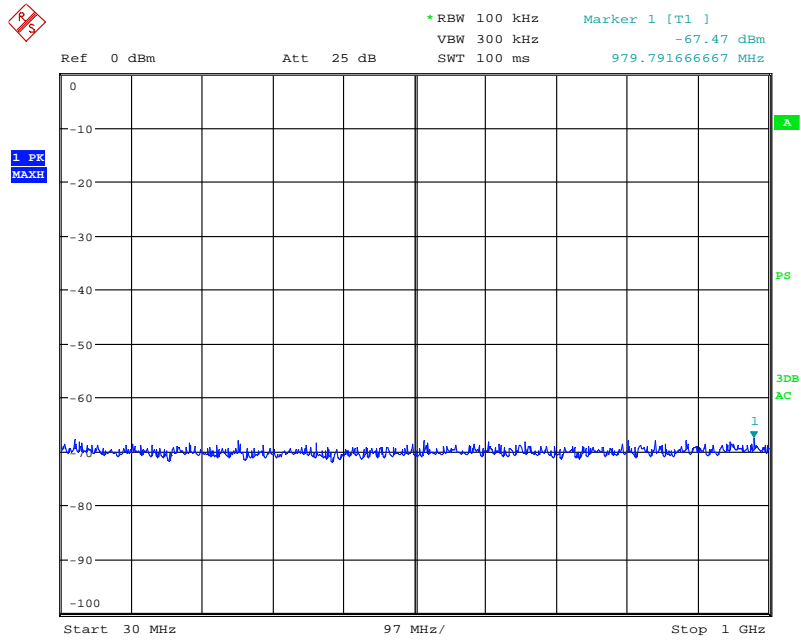

Date: 17.MAY.2013 14:07:26

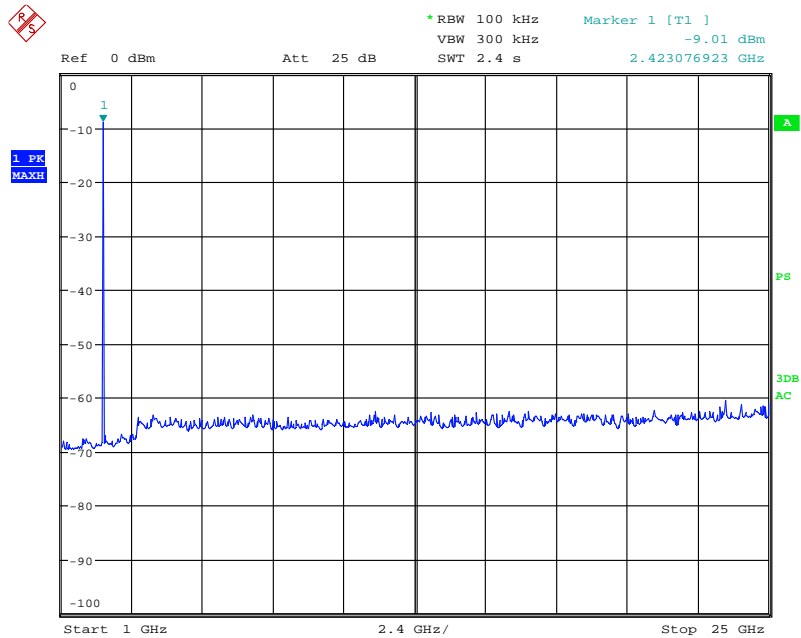

Date: 17.MAY.2013 14:06:51



Conducted Spurious Emission – Channel 26

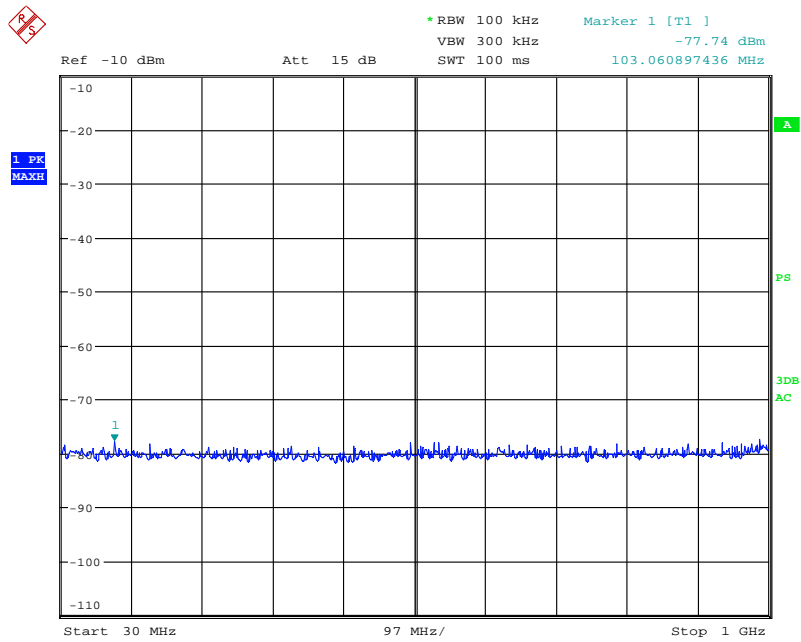

Date: 17.MAY.2013 14:05:26

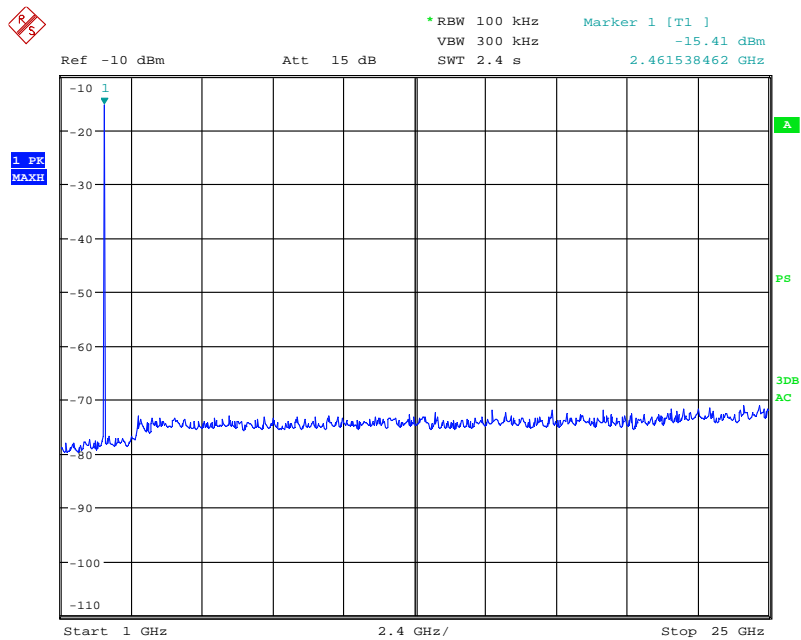

Date: 17.MAY.2013 14:04:07



3.7 Power Spectral Density

Performance Criterion: The power spectral density shall not be greater than 8 dBm in any 3 kHz band.

Test Results: Complies

Test Details: The EUT was tested in a continuous transmit mode with maximum power levels. Refers to the following table and receiver screen captures. The insertion loss was compensated for in the receiver.

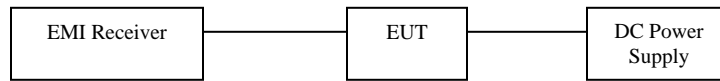

Channel	Frequency (MHz)	Power Spectral Density (dBm)
11	2405	3.43
18	2440	3.22
26	2480	-3.79



Power Spectral Density, Channel 11:

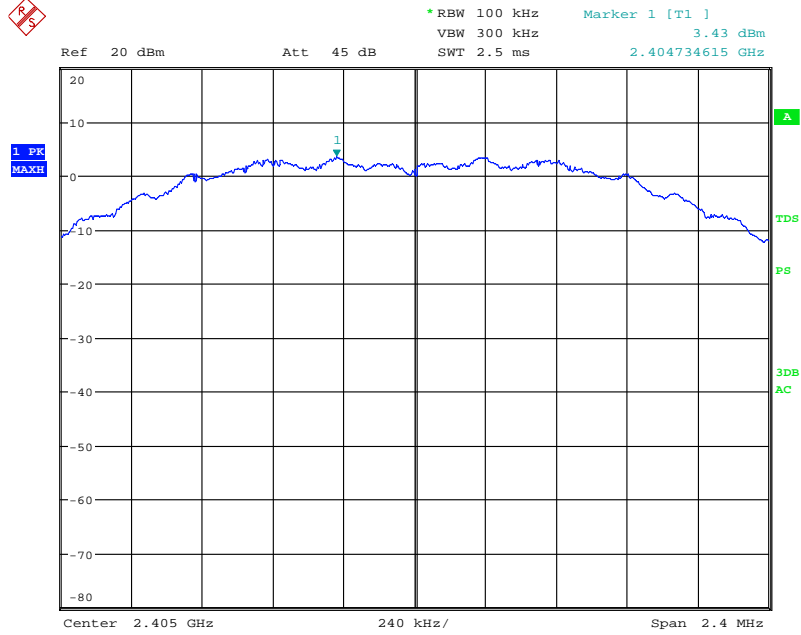

Date: 17.MAY.2013 15:48:18

Power Spectral Density, Channel 18:

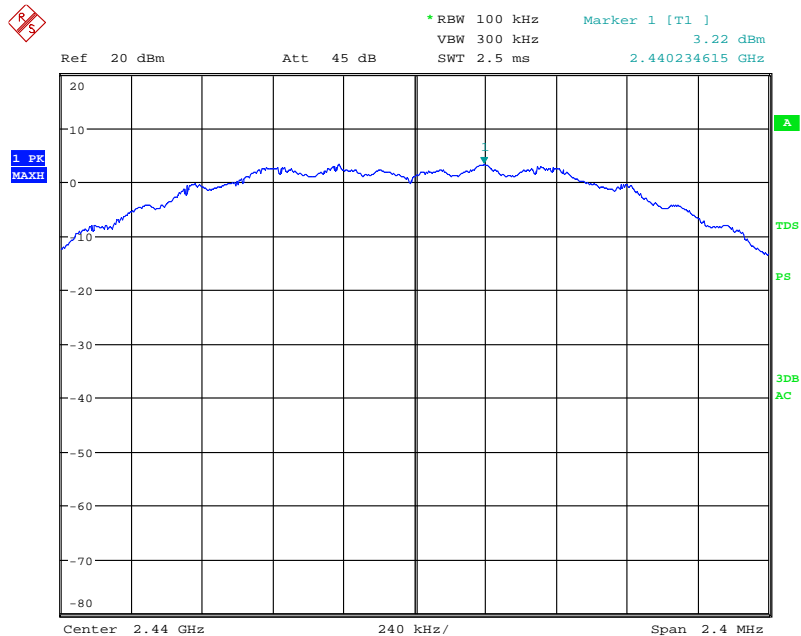

Date: 17.MAY.2013 15:47:08



Power Spectral Density, Channel 26:



Ref 20 dBm Att 45 dB RBW 100 kHz Marker 1 [T1]
VBW 300 kHz -3.79 dBm
SWT 2.5 ms 2.480226923 GHz

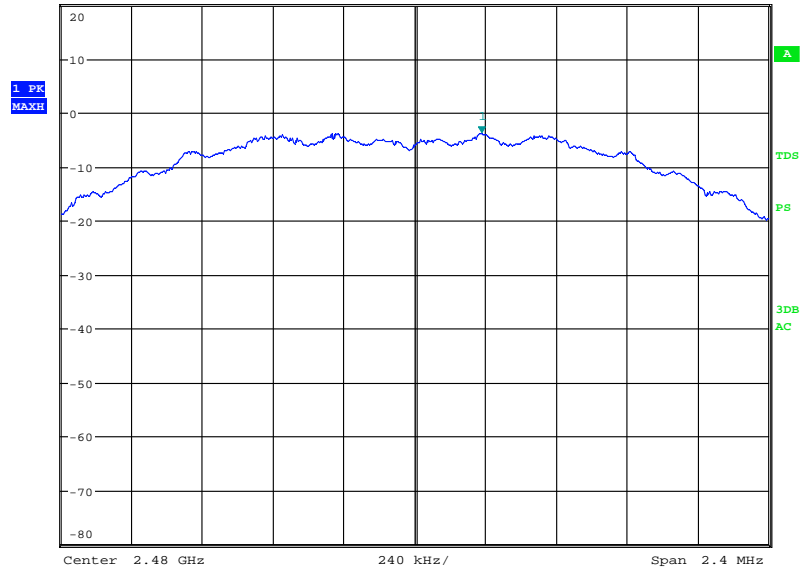

Date: 17.MAY.2013 15:45:44

3.8 Radiated Spurious Emissions

Performance Criterion: Radiated spurious emissions which fall in the restricted bands must comply with the radiated emission limits specified in FCC § 15.209(a) and Table 2 of IC RSS-Gen.

Test Results: Complies

Test Details: Radiated spurious emission was performed from 30 MHz to the tenth harmonics of the carrier. For each scan of radiated emission measurement, the procedures for maximizing emissions were followed. The EUT was rotated and antenna height was varied between 1 m and 4 m in order to maximize the emission. Measurements in both horizontal and vertical polarities were made and the data was recorded. All radiated emission measurements, up to 18 GHz, were performed at 3-meter distance between an antenna and the EUT. All radiated emission measurements, above 18 GHz, were performed at 0.3-meter distance between an antenna and the EUT.

The peak level of radiated emissions above 1 GHz was measured with a resolution bandwidth (RBW) of 1 MHz and a video bandwidth (VBW) of 3 MHz.

For harmonics/spurs that fall in the restricted band, the radiated spurious emissions above 1 GHz were measured with RBW of 1 MHz, VBW of 10 Hz, and Sweep of Auto. The unit was configured for continuous operation.

EUT was tested in three orthogonal orientations (XY, YZ, and ZX planes). XY was the worst case and presented herein

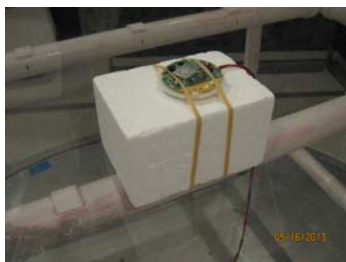

EUT = XY



EUT = YZ



EUT = ZX

Refers to the following block diagram and data table for test data. Antenna factor, cable loss, and preamplifier gain were compensated for in the receiver. A factor of 20 dB/decade applies to measurements made at a closer distance than the limit distance before comparing to the limits. Calculation of duty cycle correction factor is included in the Theory of Operation.

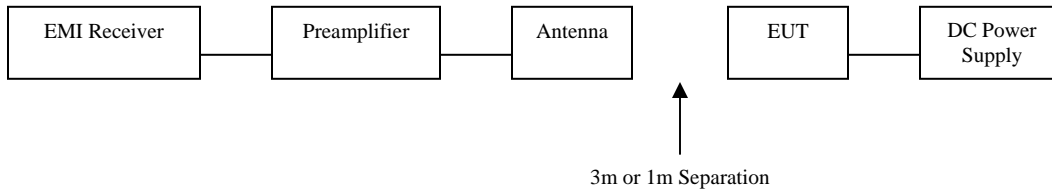

HTT-B2EX-BATT Radiated Spurious Emissions												
Antenna Polarization	Frequency (MHz)	Channel No.	Power Setting (Level)	EUT Orientation	Measured Data (dBuV/m)	Duty Cycle Correction Factor (dB)	Corrected Data	Limit (dBuV/m)	Margin (dB)	Antenna Height (cm)	Turntable Degree	Detector
H	2405	11	8	XY	105.65	-	-	-	-	160.6	150.6	AVE
H	2405	11	8	XY	108.54	-	-	-	-	160.6	150.6	PK
H	2390	11	8	XY	43.80	20.00	23.80	54	30.20	160.6	150.6	AVE
H	2390	11	8	XY	55.70	0.00	55.70	74	18.30	160.6	150.6	PK
H	4810	11	8	XY	37.71	20.00	17.71	54	36.29	121.7	152.4	AVE
H	4810	11	8	XY	51.57	0.00	51.57	74	22.43	121.7	152.4	PK
H	12025	11	8	XY	38.99	20.00	18.99	54	35.01	139.4	206.0	AVE
H	12025	11	8	XY	52.47	0.00	52.47	74	21.53	139.4	206.0	PK
H	19240 (NF)*	11	8	XY	34.80	20.00	14.80	54	39.20	-	-	AVE
H	19240 (NF)*	11	8	XY	47.61	0.00	47.61	74	26.39	-	-	PK
H	2440	18	8	XY	105.78	-	-	-	-	189.7	150.6	AVE
H	2440	18	8	XY	108.60	-	-	-	-	189.7	150.6	PK
H	4880	18	8	XY	37.44	20.00	17.44	54	36.56	133.8	164.9	AVE
H	4880	18	8	XY	49.94	0.00	49.94	74	24.06	133.8	164.9	PK
H	7320	18	8	XY	35.84	20.00	15.84	54	38.16	181.5	90.0	AVE
H	7320	18	8	XY	49.63	0.00	49.63	74	24.37	181.5	90.0	PK
H	12200	18	8	XY	40.03	20.00	20.03	54	33.97	143.2	145.0	AVE
H	12200	18	8	XY	53.43	0.00	53.43	74	20.57	143.2	145.0	PK
H	19520 (NF)*	18	8	XY	34.79	20.00	14.79	54	39.21	-	-	AVE
H	19520 (NF)*	18	8	XY	48.60	0.00	48.60	74	25.40	-	-	90.0
H	2480	26	1	XY	97.45	-	-	-	-	187.5	150.6	AVE
H	2480	26	1	XY	100.22	-	-	-	-	187.5	150.6	PK
H	2483.5	26	1	XY	62.49	20.00	42.49	54	11.51	187.5	150.6	AVE
H	2483.5	26	1	XY	72.80	0.00	72.80	74	1.20	187.5	150.6	PK
H	2483.5	25	8	XY	51.08	20.00	31.08	54	22.92	187.5	150.6	AVE
H	2483.5	25	8	XY	63.05	0.00	63.05	74	10.95	187.5	150.6	PK
H	4960	26	1	XY	34.09	20.00	14.09	54	39.91	133.0	176.8	AVE
H	4960	26	1	XY	47.80	0.00	47.80	74	26.20	133.0	176.8	PK
H	7440 (NF)	26	1	XY	33.50	20.00	13.50	54	40.50	-	-	AVE
H	7440 (NF)	26	1	XY	47.16	0.00	47.16	74	26.84	-	-	PK
H	12400 (NF)	26	1	XY	36.02	20.00	16.02	54	37.98	-	-	AVE
H	12400 (NF)	26	1	XY	49.18	0.00	49.18	74	24.82	-	-	PK
H	19840 (NF)*	26	1	XY	34.10	20.00	14.10	54	39.90	-	-	AVE
H	19840 (NF)*	26	1	XY	47.48	0.00	47.48	74	26.52	-	-	PK
H	22320 (NF)*	26	1	XY	35.06	20.00	15.06	54	38.94	-	-	AVE
H	22320 (NF)*	26	1	XY	49.05	0.00	49.05	74	24.95	-	-	PK

NF: Noise Floor
 *: Tested at 1m

Tested: May 16-17, 2013
 Tested by: Grace Lin