



## Test Report

### FCC Part 15, Subpart C, Section 15.247 Industry Canada RSS-210, Issue 7

Report Number: CWD6660-Cert

Model: CWD6660

FCC ID: EROCWD6660  
IC: 5683C-CWD6660

Date: April 2, 2010

Prepared by: Grace Lin  
Grace Lin, Sr. Compliance Engineer

Date: Apr. 2, 2010

Reviewed by: Wayne Owens  
Wayne Owens, Director of Program Management

Date: Apr. 2, 2010



## Table of Contents

<b>1. GENERAL DESCRIPTION.....</b>	<b>3</b>
1.1 PRODUCT DESCRIPTION .....	3
1.2 TEST METHODOLOGY .....	3
1.3 TEST FACILITY.....	3
1.4 TEST EQUIPMENT.....	4
1.5 EVALUATION SUMMARY .....	4
<b>2. SYSTEM TEST CONFIGURATION.....</b>	<b>5</b>
2.1 JUSTIFICATION .....	5
2.2 BLOCK DIAGRAM.....	5
2.3 EUT EXERCISE SOFTWARE AND MODE(S) OF OPERATION .....	5
2.4 CABLES.....	5
2.5 SPECIAL ACCESSORIES.....	6
2.6 SUPPORT EQUIPMENT .....	6
2.7 EQUIPMENT MODIFICATIONS .....	6
<b>3. EVALUATION .....</b>	<b>7</b>
3.1 ANTENNA REQUIREMENTS.....	7
3.2 6 dB BANDWIDTH .....	8
3.3 99% BANDWIDTH .....	11
3.4 POWER OUTPUT .....	13
3.5 BAND EDGE .....	16
3.6 CONDUCTED SPURIOUS EMISSIONS .....	18
3.7 POWER SPECTRAL DENSITY .....	22
3.8 RADIATED SPURIOUS EMISSIONS .....	25
3.9 RECEIVER RADIATED EMISSIONS .....	28
3.10 RECEIVER AC POWER LINE CONDUCTED EMISSIONS .....	31



## **1. General Description**

### **1.1 Product Description**

The equipment under test (EUT) is a Crestron 2.4GHz two-way RF transceiver module, model: CWD6660.

### **1.2 Test Methodology**

Measurements were performed according to the following procedures and standards:

- 1) ANSI C63.4: 2003
- 2) FCC Procedure, "Measurement of Digital Transmission Systems Operating under Section 15.247", March 23, 2005
- 3) Industry Canada RSS-Gen Issue 2
- 4) Industry Canada RSS-210 Issue 7
- 5) Industry Canada ICES-003 Issue 4

All measurements were performed in a 3-meter semi-anechoic chamber and the control room.

### **1.3 Test Facility**

The 3-meter semi-anechoic chamber used to collect conducted and radiated emission data is located at 22 Link Drive, Rockleigh, New Jersey. This test facility has been placed on file with the FCC, Registration Number: 412871, and Industry Canada, Site Number: 5683C-1.



## 1.4 Test Equipment

Description	Model	Serial No.	Frequency Range	Calibration Date
R&S EMI Receiver	ESU40	100076	20 Hz – 40 GHz	Dec. 22, 2009
Teseq Bilog Antenna	CBL 6112D	25231	30 MHz – 2 GHz	Jan. 28, 2010
ETS-Lindgren Double Ridge Horn Antenna	3117	00047560	1 GHz – 18 GHz	Jan. 27, 2010
R&S Preamplifier	TS-PR18	100044	30 MHz – 18 GHz	Feb. 9, 2010
ETS-Lindgren Standard Gain Horn Antenna	3160-09	00078911	18 GHz – 26.5 GHz	Apr. 3, 2009
R&S Preamplifier	TS-PR26	100030	18 GHz – 26.5 GHz	Feb. 23, 2010
Solar Electronics LISN	9252-50-R-24-N	068546	10 kHz – 50 MHz	Feb. 3, 2010

## 1.5 Evaluation Summary

Rule Section		Description/Parameters	Results
FCC	IC		
§15.203	N/A	Antenna Requirement	Complies
§15.247(a)(2)	§A8.2(a) of RSS-210	6 dB Bandwidth, 500 kHz	Complies
N/A	§4.6.1 of RSS-Gen	99% Occupied Bandwidth	(for reporting purpose)
§15.247(b)(3)	§A8.4(4) of RSS-210	Power Output, conducted, 1 Watt (30dBm)	Complies
§15.247(d)	§2.1, §A8.5 of RSS-210	Band Edge	Complies
§15.247(d)	§A8.5 of RSS-210	Conducted Spurious Emissions, 20 dBc	Complies
§15.247(e)	§A8.2(b) of RSS-210	Power Spectral Density (PSD), 8 dBm in any 3 kHz band.	Complies
§15.205, §15.209, §15.247(d)	§2.2, §2.7, §A8.5 of RSS-210	Radiated Spurious Emissions	Complies
§15.101(b)	§6 of RSS-Gen	Receiver Radiated Emission	Complies
§15.107	§7.2.2 of RSS-Gen	Receiver AC Power Line Conducted Emissions	Complies

**Note:**

The channels selected for test were 11, 18, and 26.

## 2. System Test Configuration

### 2.1 Justification

A DC power supply supplied power to the EUT. A computer supplied test commands.

### 2.2 Block Diagram

Block diagram is shown below.

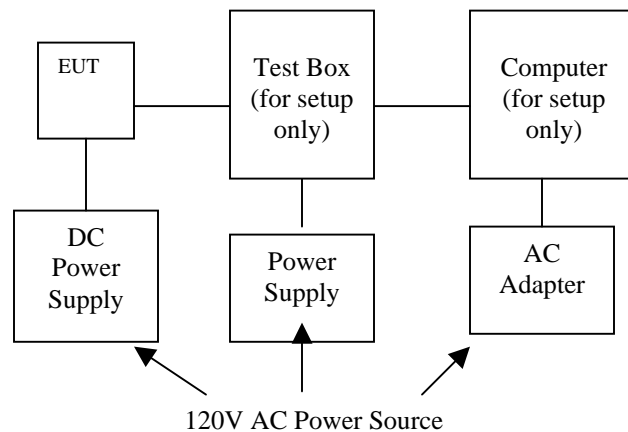

### 2.3 EUT Exercise Software and Mode(s) of Operation

The EUT was configured to transmit continuously. Channels 11 (2405 MHz), 18 (2440 MHz), and 26 (2480 MHz) were selected for test.

### 2.4 Cables

Qty	Description	Length (m)	From - To	Shielded/ Unshielded
1	Power Cord	1.5	Power Source – Computer	Unshielded
1	Cat 6 (crossover)	0.6	Computer – Test Box	Unshielded
1	10-conductor Flat Cable	0.3	Test Box – EUT	Unshielded



## 2.5 *Special Accessories*

There are no special accessories for compliance of this EUT.

## 2.6 *Support equipment*

No	Description	Manufacturer	Model No	Serial No
1	Computer	DELL	PP02X	38707541497
2	AC Adapter	DELL	LA90PS0-00	CN-0DF266-71615-68A-2AB1
3	Test Box	ember	Not Labeled	ember02
4	Power Supply	CUI	3A-161WP12	Not Labeled
5	DC Power Supply	BK Precision	1670	281-2152

## 2.7 *Equipment Modifications*

There were no modifications installed during compliance measurements.



### **3. Evaluation**

#### **3.1 *Antenna Requirements***

This module is validated with a dipole antenna. Antenna's specifications are included in a separate file.

The antennas' reverse polarity SMA (RP-SMA) connectors are unique in the sense of complying with FCC §15.203, §15.204(b), and §15.204(c).



### 3.2 6 dB Bandwidth

**Performance Criterion:** The minimum 6 dB bandwidth shall be at least 500 kHz.

**Test Results:** Complies

**Test Details:** Refers to the following block diagram, data table, and receiver screen captures. The EUT was tested in a continuous transmit mode with maximum power levels of 248 (channels 11 and 18) and 213 (channel 26) at boost mode.

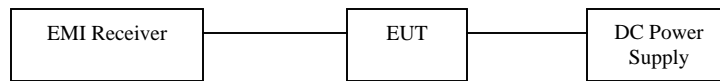

Channel	Frequency (MHz)	6 dB Bandwidth (kHz)
11	2405	1603
18	2440	1571
26	2480	1554

**Note:** The RF level in the plots is relative and is not the indication of RF output power.





### 6 dB Bandwidth, Channel 11:

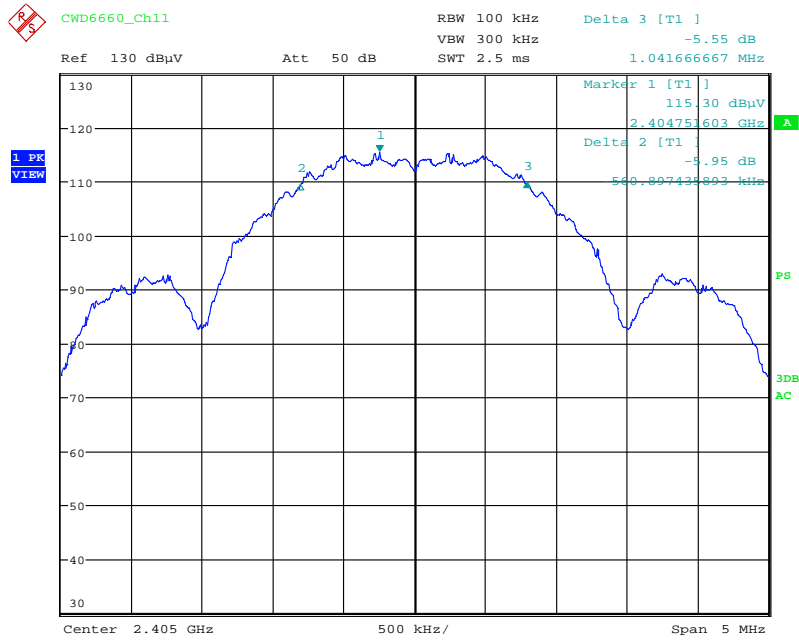

Date: 2.APR.2010 10:37:30

### 6 dB Bandwidth, Channel 18:

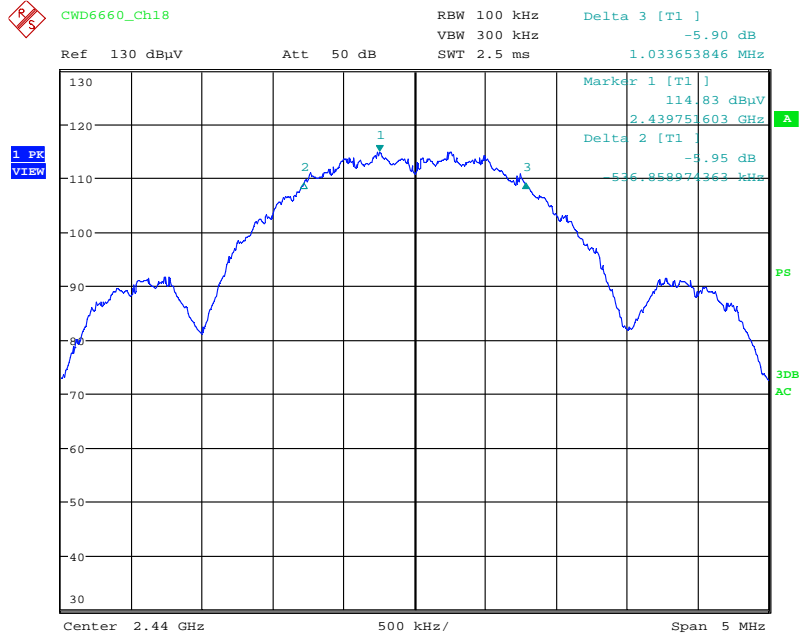

Date: 2.APR.2010 10:29:04



### 6 dB Bandwidth, Channel 26:

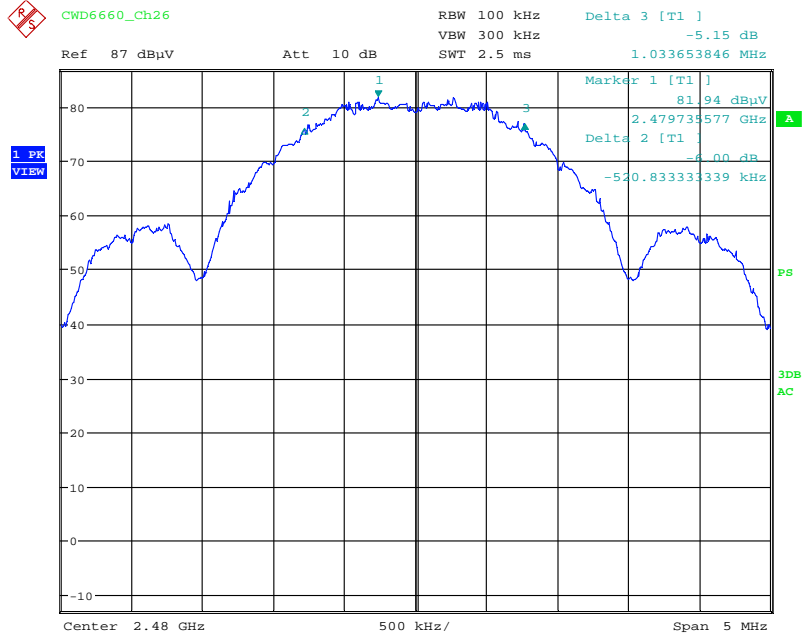

Date: 2.APR.2010 09:43:24

### 3.3 99% Bandwidth

**Test Details:** Refers to the following block diagram, data table, and receiver screen captures. The EUT was tested in a continuous transmit mode with maximum power levels of 248 (channels 11 and 18) and 213 (channel 26) at boost mode.

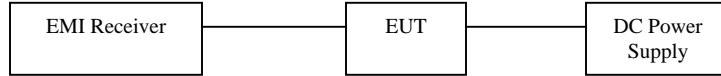

Channel	Frequency (MHz)	99% Bandwidth (MHz)
11	2405	2.356
18	2440	2.348
26	2480	2.388

**Note:** The RF level in the plots is relative and is not the indication of RF output power.

#### 99% Bandwidth, Channel 11:

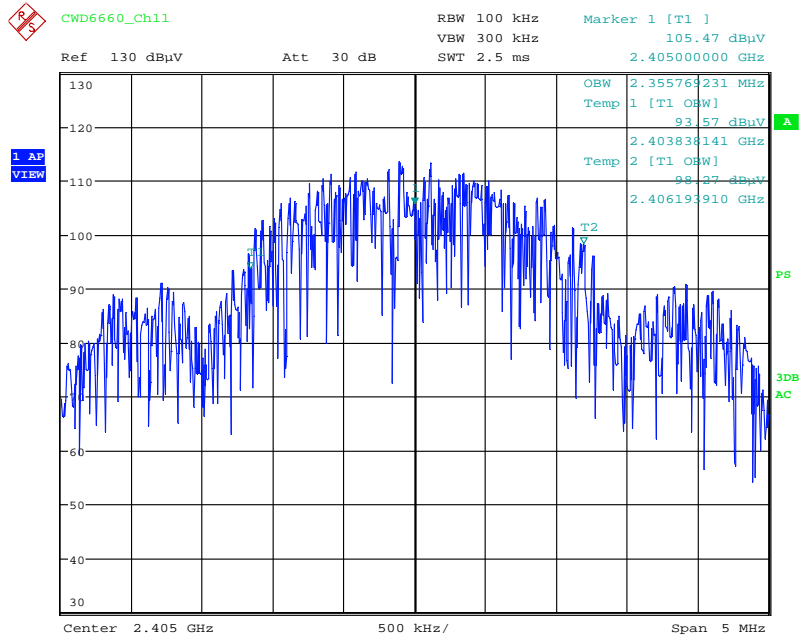

Date: 2.APR.2010 10:35:02



### 99% Bandwidth, Channel 18:

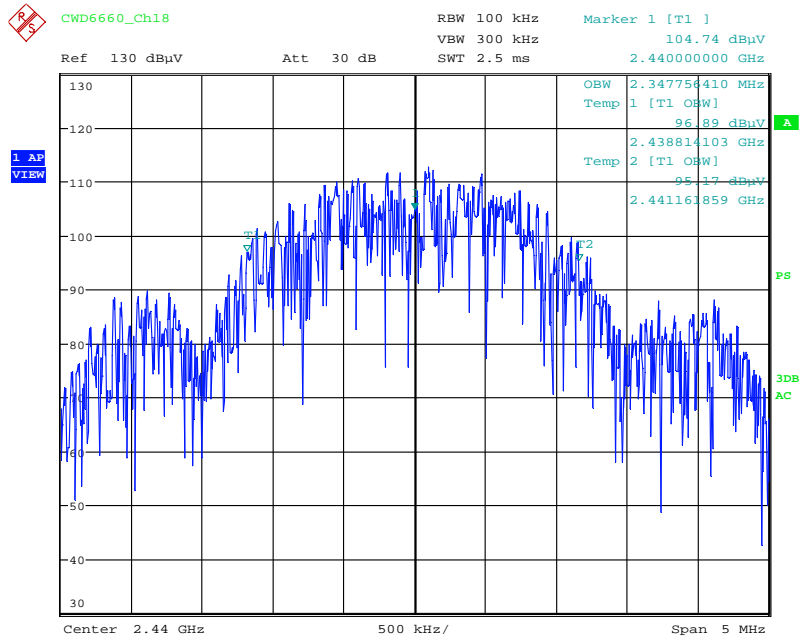

Date: 2.APR.2010 10:30:40

### 99% Bandwidth, Channel 26:

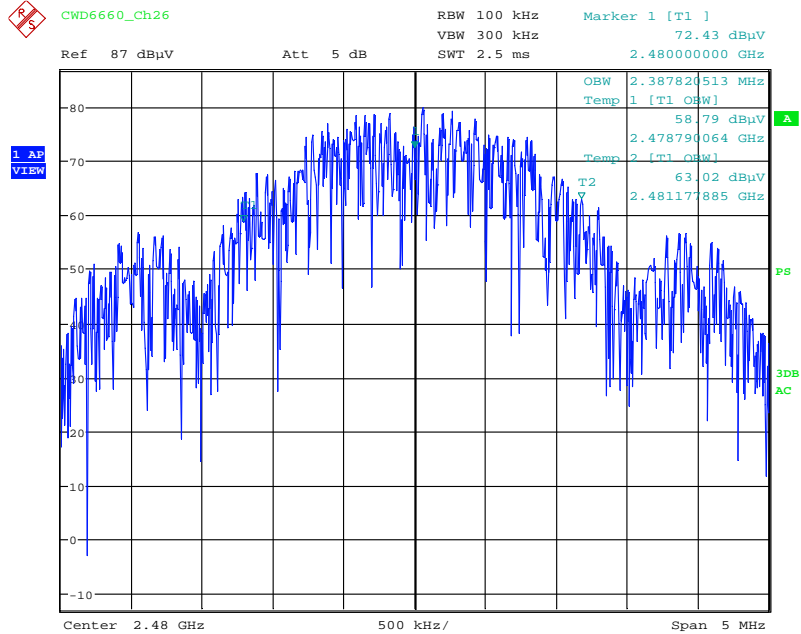

Date: 2.APR.2010 09:47:50



### 3.4 Power Output

**Performance Criterion:** The maximum peak conducted output power shall not exceed 1 Watt.

**Test Results:** Complies

**Test Details:** The EUT was tested in a continuous transmit mode with maximum power levels at boost mode. Refers to the following block diagram, data table, and receiver screen captures.



Channel	Frequency (MHz)	Power Level	Power	
			dBm	mW
11	2405	248	22.13	163.305
18	2440	248	21.56	143.219
26	2480	213	-11.13	0.077

**Note:** The insertion loss was compensated for in the receiver.



### Power Output, Channel 11:

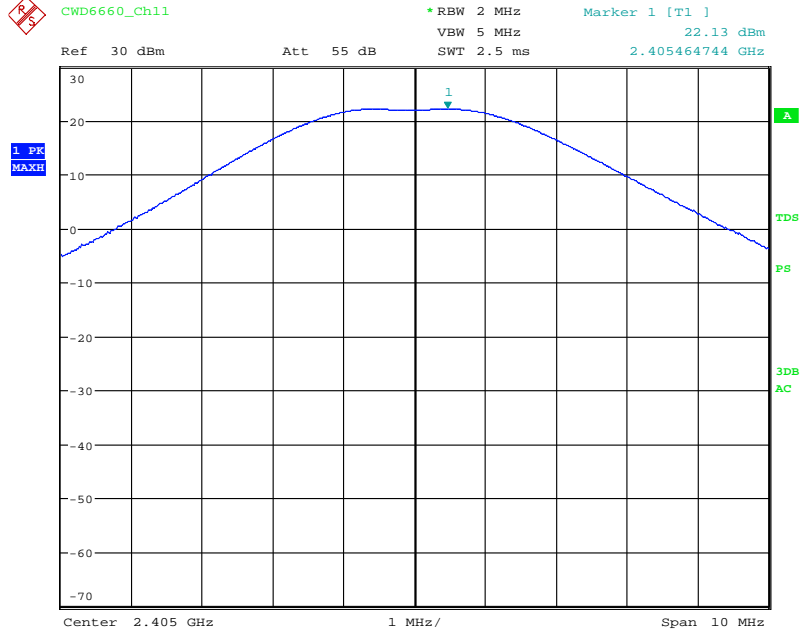

Date: 2.APR.2010 10:50:46

### Power Output, Channel 18:

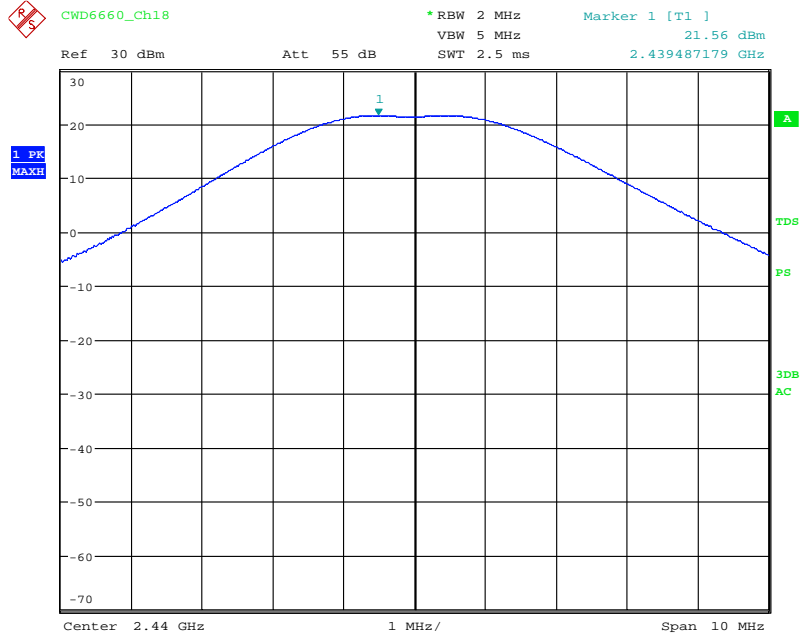

Date: 2.APR.2010 11:22:26



**Power Output, Channel 26:**

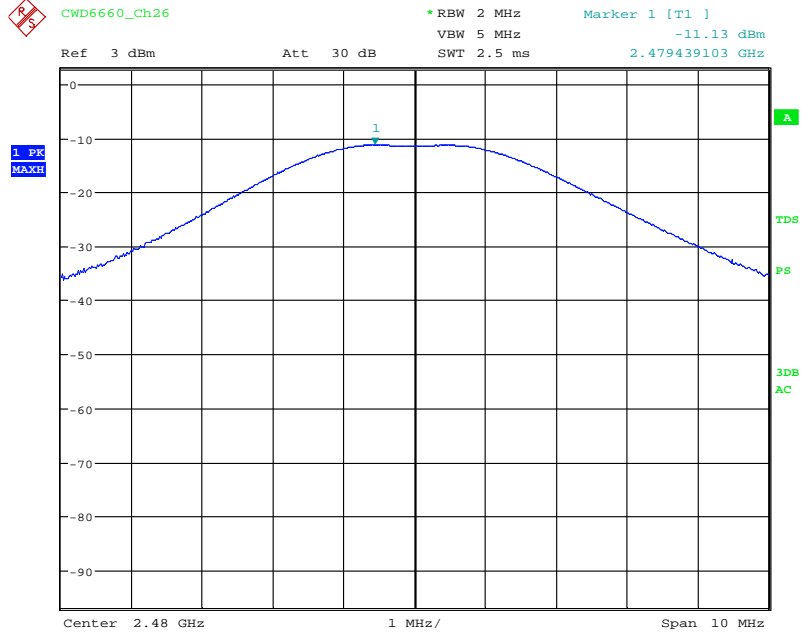

Date: 2.APR.2010 09:52:56



### 3.5 *Band Edge*

**Performance Criterion:** In any 100 kHz bandwidth outside the frequency band, the RF power shall be at least 20 dB below that in the 100 kHz bandwidth within the band.

**Test Results:** Complies

**Test Details:** Refers to the following block diagram and receiver screen captures

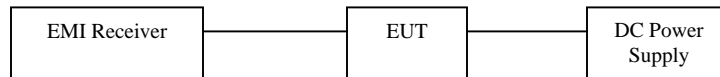





**Band Edge:**

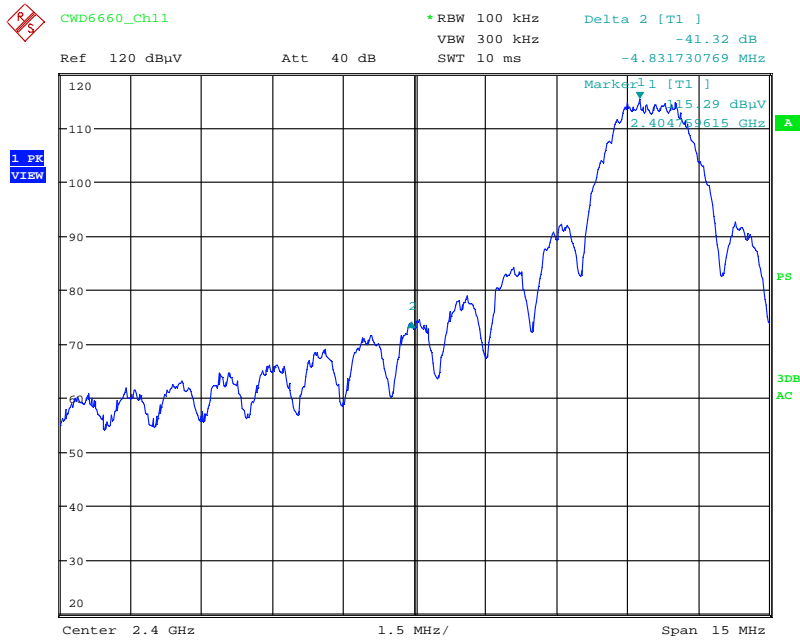

Date: 2.APR.2010 10:46:47



Date: 2.APR.2010 11:28:49



### 3.6 *Conducted Spurious Emissions*

**Performance Criterion:** In any 100 kHz bandwidth outside the frequency band, the radio frequency power shall be at least 20 dB below that in the 100 kHz bandwidth within the band.

**Test Results:** Complies

**Test Details:** Refers to the following block diagram and receiver screen captures

**Note:** The EUT was tested in a continuous transmit mode with maximum power level of 248 (channels 11 and 18) and 213 (channel 26) at boost mode. The RF level in the screen captures is relative and is not the indication of RF output power.





### Conducted Spurious Emission – Channel 11

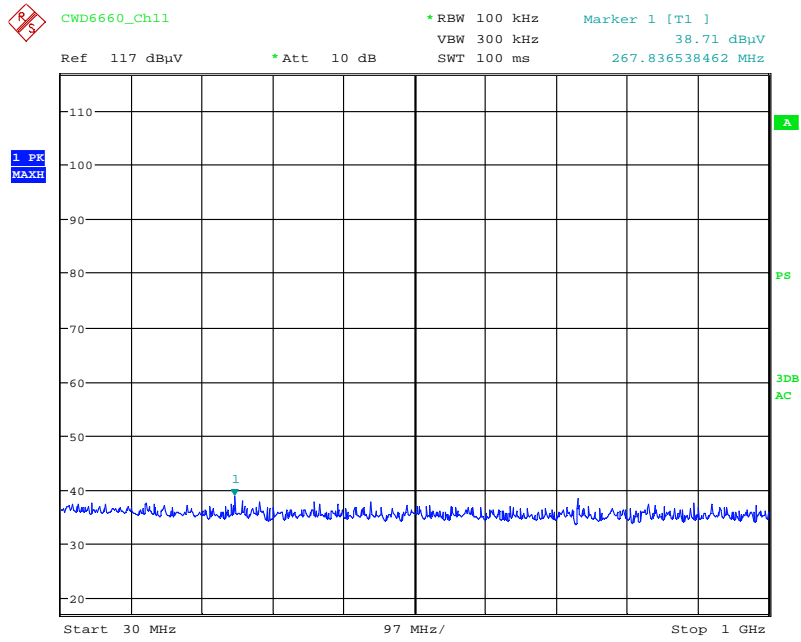

Date: 2.APR.2010 10:42:43

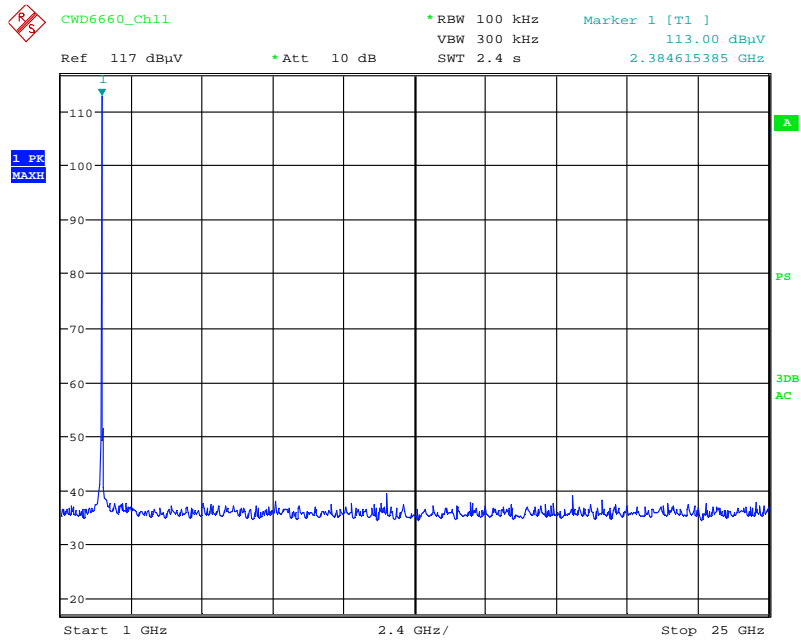

Date: 2.APR.2010 10:41:51



### Conducted Spurious Emission – Channel 18

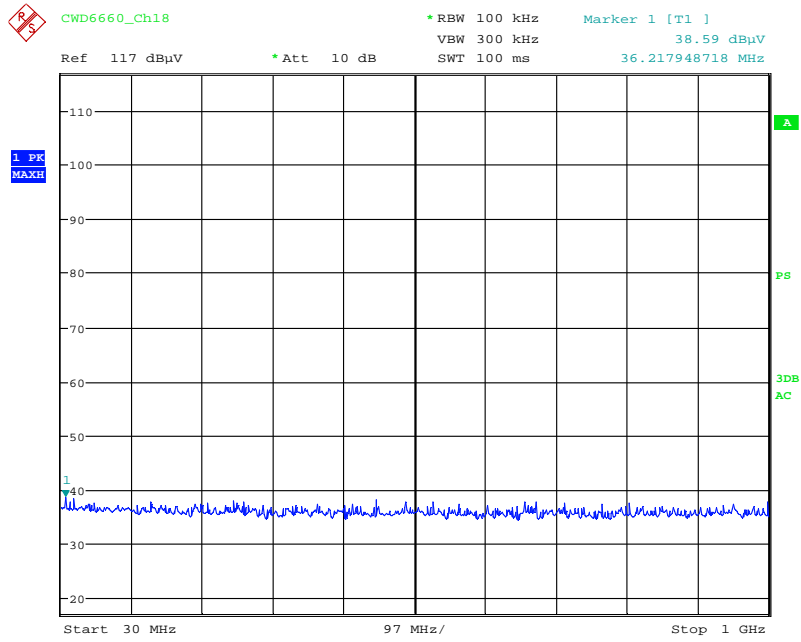

Date: 2.APR.2010 10:25:31

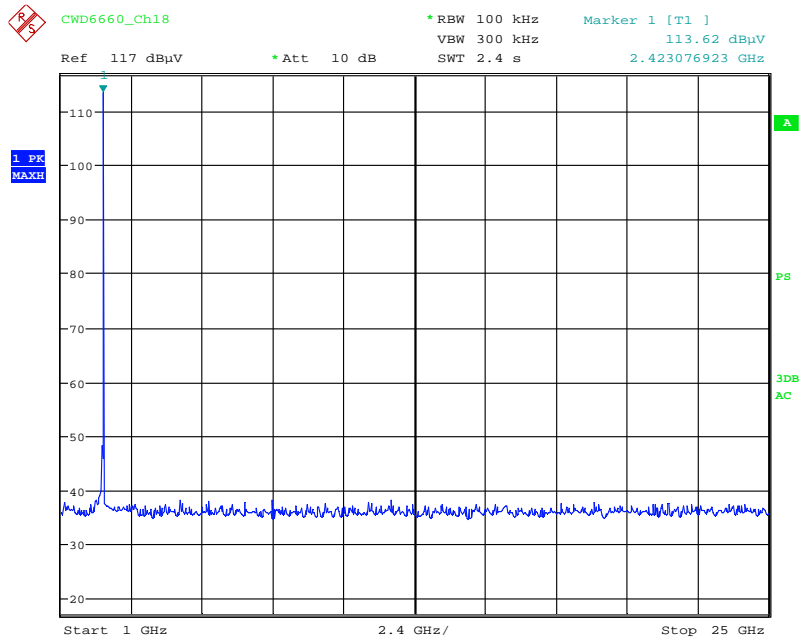

Date: 2.APR.2010 10:24:46



### Conducted Spurious Emission – Channel 26

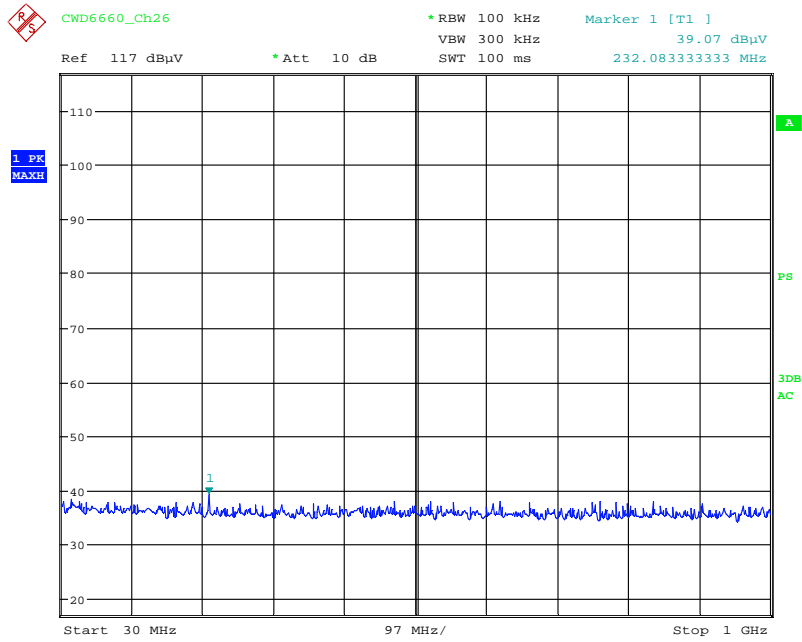

Date: 2.APR.2010 10:19:54

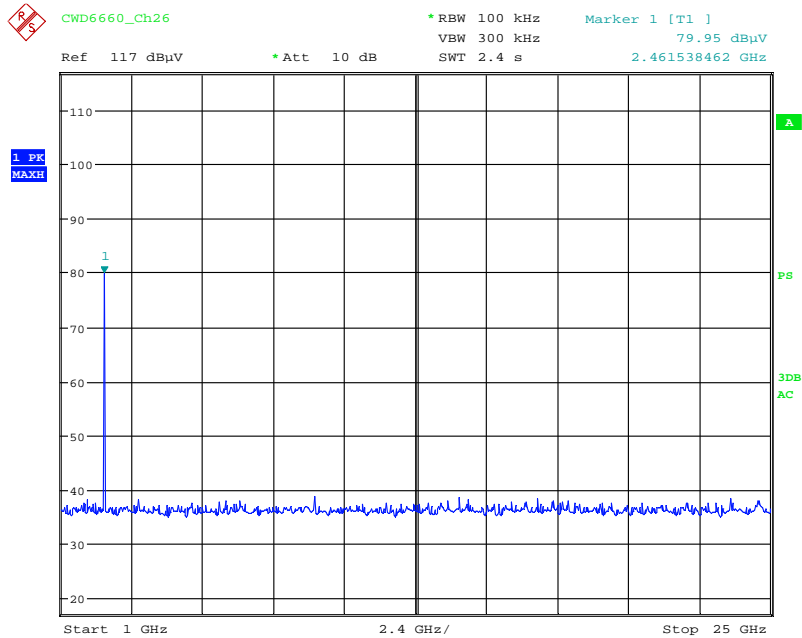

Date: 2.APR.2010 10:20:33



### 3.7 Power Spectral Density

**Performance Criterion:** The power spectral density shall not be greater than 8 dBm in any 3 kHz band.

**Test Results:** Complies

**Test Details:** The EUT was tested in a continuous transmit mode with maximum power level of 248 (channels 11 and 18) and 213 (channel 26). Refers to the following table and receiver screen captures. The insertion loss was compensated for in the receiver.



Channel	Frequency (MHz)	Power Spectral Density (dBm)
11	2405	7.61
18	2440	7.32
26	2480	-25.93



**Power Spectral Density, Channel 11:**

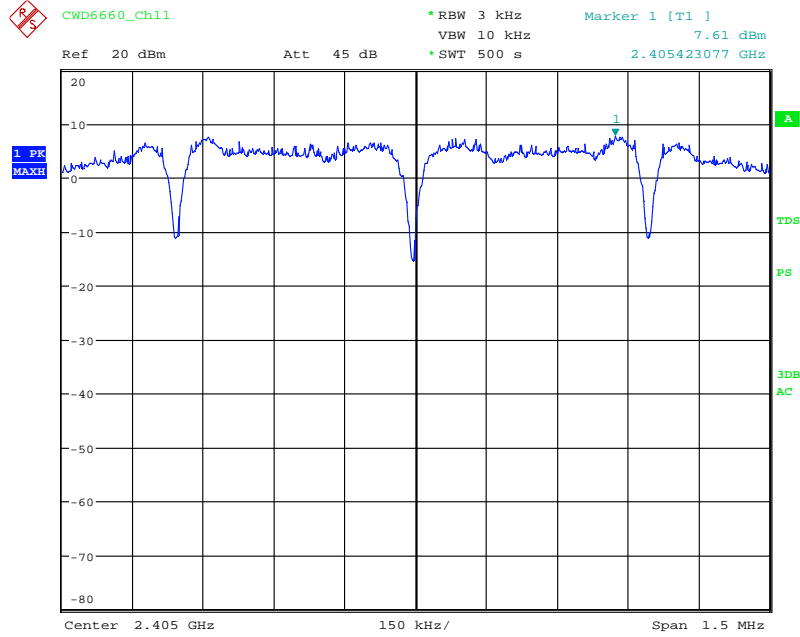

Date: 2.APR.2010 11:07:22

**Power Spectral Density, Channel 18:**

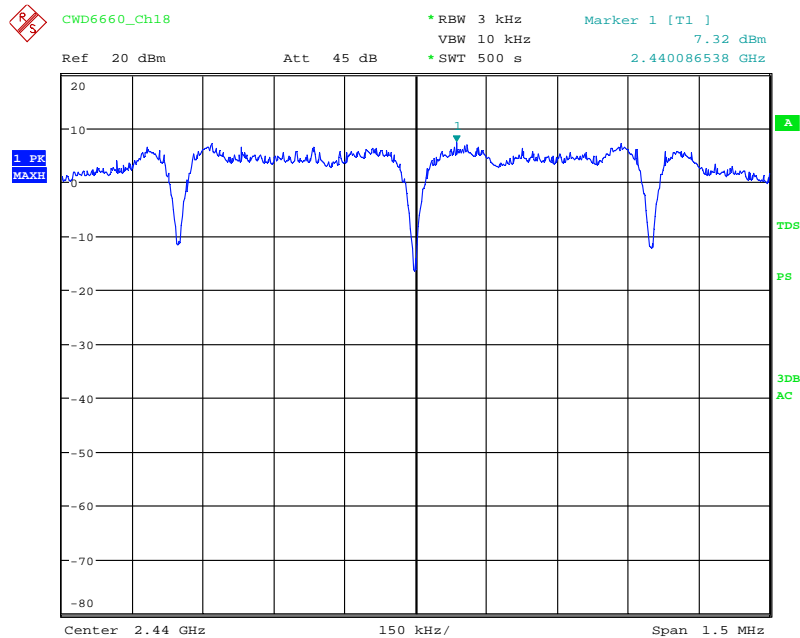

Date: 2.APR.2010 11:18:09



**Power Spectral Density, Channel 26:**

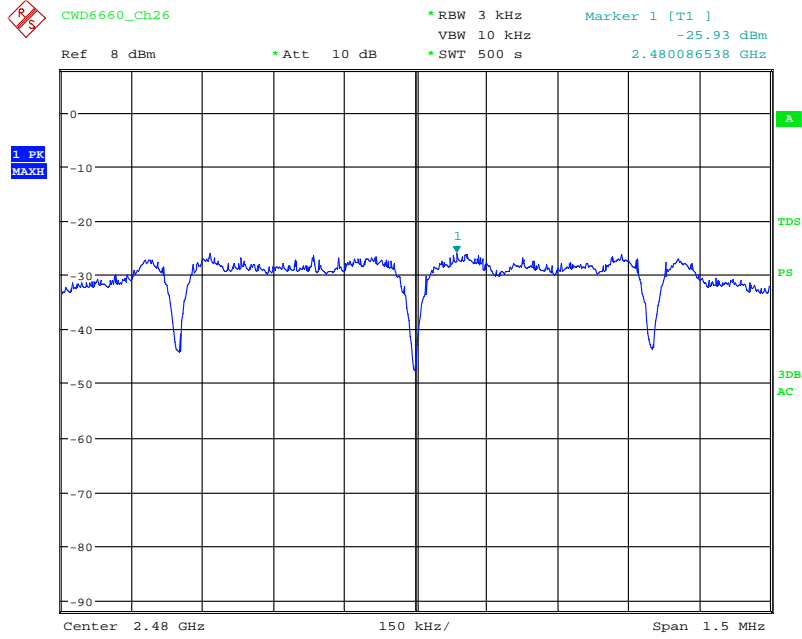

Date: 2.APR.2010 10:15:22



### 3.8 Radiated Spurious Emissions

**Performance Criterion:** Radiated spurious emissions which fall in the restricted bands must comply with the radiated emission limits specified in FCC § 15.209(a) and Table 2 of IC RSS-210.

**Test Results:** Complies

**Test Details:** Radiated spurious emission was performed from 30 MHz to the tenth harmonics of the carrier. For each scan of radiated emission measurement, the procedures for maximizing emissions were followed. The EUT was rotated and antenna height was varied between 1 m and 4 m in order to maximize the emission. Measurements in both horizontal and vertical polarities were made and the data was recorded. All radiated emission measurements, up to 18 GHz, were performed at 3-meter distance between an antenna and the EUT. All radiated emission measurements, above 18 GHz, were performed at 1-meter distance between an antenna and the EUT.

The peak level of radiated emissions above 1 GHz was measured with a resolution bandwidth (RBW) of 1 MHz and a video bandwidth (VBW) of 3 MHz.

For harmonics/spurs that fall in the restricted band, the radiated spurious emissions above 1 GHz were measured with RBW of 1 MHz, VBW of 10 Hz, and Sweep of Auto. The unit was configured for continuous operation.

EUT was tested in three orthogonal orientations (XY, YZ, and ZX planes) with antenna at 0 and 90 degrees.

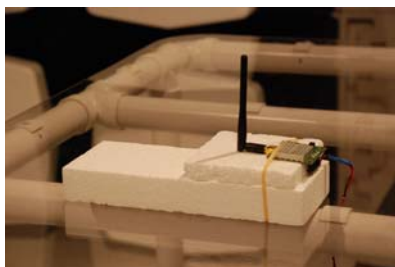

EUT = XY

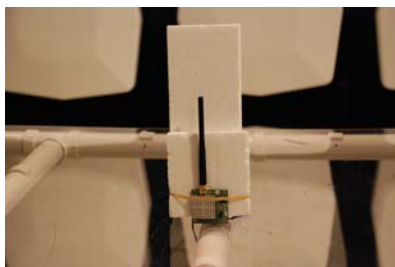

EUT = YZ

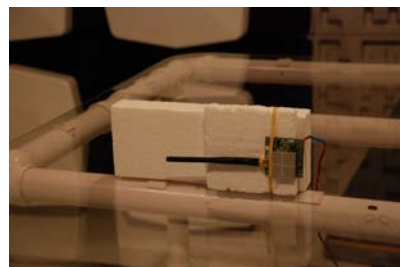

EUT = ZX

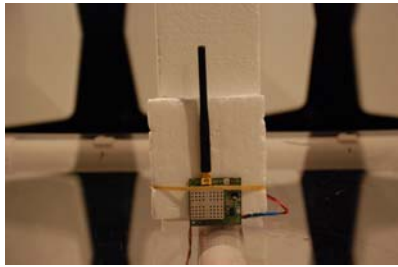

Antenna = 0

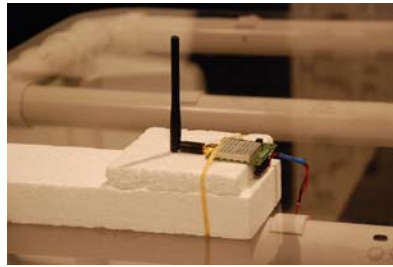

Antenna = 90

Refers to the following block diagram and data table for test data. Antenna factor, cable loss, and preamplifier gain were compensated for in the receiver. A factor of 20 dB/decade applies to measurements made at a closer distance than the limit distance before comparing to the limits.

Duty cycle calculation and screen shots are included in a separate file.

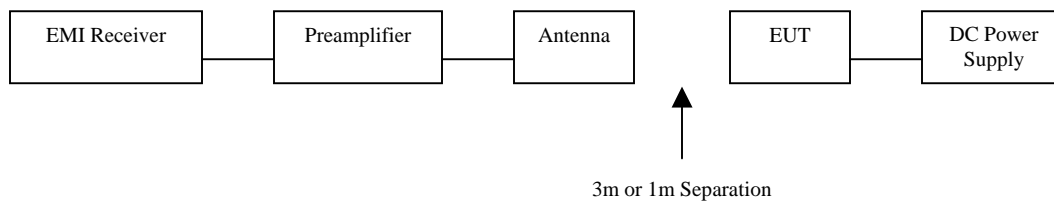



**CWD6660 Radiated Spurious Emissions, Boost Mode**

Antenna Polarization	Frequency (MHz)	Channel No.	Power Setting (Level)	EUT Orientation	EUT Ant Orientation	Measured Data (dBuV/m)	Duty Cycle Correction Factor (dB)	Corrected Data	Limit (dBuV/m)	Margin (dB)	Antenna Height (cm)	Turttable Degree	Detector
V	2405	11	248	YZ	0	121.54	-	-	-	-	136.6	9.7	AVE
V	2405	11	248	YZ	0	125.68	-	-	-	-	136.6	9.7	PK
V	2390	11	248	YZ	0	58.14	7.5	50.64	54	3.36	136.6	9.7	AVE
V	2390	11	248	YZ	0	68.99	0	68.99	74	5.01	136.6	9.7	PK
V	4810	11	248	YZ	0	40.63	7.5	33.13	54	20.87	106.9	359.9	AVE
V	4810	11	248	YZ	0	52.39	0	52.39	74	21.61	106.9	359.9	PK
V	12025 (NF)	11	248	YZ	0	40.66	7.5	33.16	54	20.84	-	-	AVE
V	12025 (NF)	11	248	YZ	0	51.56	0	51.56	74	22.44	-	-	PK
V	19240 (NF)*	11	248	YZ	0	35.90	7.5	28.40	54	25.60	-	-	AVE
V	19240 (NF)*	11	248	YZ	0	50.52	0	50.52	74	23.48	-	-	PK
V	2440	18	248	YZ	0	121.17	-	-	-	-	109.7	172.9	AVE
V	2440	18	248	YZ	0	123.48	-	-	-	-	109.7	172.9	PK
V	4880	18	248	YZ	0	39.50	7.5	32.00	54	22.00	148.0	14.2	AVE
V	4880	18	248	YZ	0	51.61	0	51.61	74	22.39	148.0	14.2	PK
V	7320	18	248	YZ	0	53.91	7.5	46.41	54	7.59	152.5	6.4	AVE
V	7320	18	248	YZ	0	65.87	0	65.87	74	8.13	152.5	6.4	PK
V	12200 (NF)	18	248	YZ	0	41.18	7.5	33.68	54	20.32	-	-	AVE
V	12200 (NF)	18	248	YZ	0	52.50	0	52.50	74	21.50	-	-	PK
V	19520 (NF)*	18	248	YZ	0	35.01	7.5	27.51	54	26.49	-	-	AVE
V	19520 (NF)*	18	248	YZ	0	49.28	0	49.28	74	24.72	-	-	PK
V	2480	26	213	YZ	0	89.96	-	-	-	-	106.4	178.1	AVE
V	2480	26	213	YZ	0	92.77	-	-	-	-	106.4	178.1	PK
V	2483.5	26	213	YZ	0	57.41	7.5	49.91	54	4.09	106.4	178.1	AVE
V	2483.5	26	213	YZ	0	69.37	0	69.37	74	4.63	106.4	178.1	PK
V	2483.5	25	243	YZ	0	60.67	7.5	53.17	54	0.83	106.5	359.9	AVE
V	2483.5	25	243	YZ	0	72.85	0	72.85	74	1.15	106.5	359.9	PK
V	2483.5	24	248	YZ	0	58.83	7.5	51.33	54	2.67	131.8	12.6	AVE
V	2483.5	24	248	YZ	0	69.66	0	69.66	74	4.34	131.8	12.6	PK
V	4960	26	213	YZ	0	33.41	7.5	25.91	54	28.09	113.8	22.2	AVE
V	4960	26	213	YZ	0	47.69	0	47.69	74	26.31	113.8	22.2	PK
V	7440	26	213	YZ	0	34.69	7.5	27.19	54	26.81	116.3	22.2	AVE
V	7440	26	213	YZ	0	49.45	0	49.45	74	24.55	116.3	22.2	PK
V	12400 (NF)	26	213	YZ	0	40.23	7.5	32.73	54	21.27	-	-	AVE
V	12400 (NF)	26	213	YZ	0	54.55	0	54.55	74	19.45	-	-	PK
V	19840 (NF)*	26	213	YZ	0	33.94	7.5	26.44	54	27.56	-	-	AVE
V	19840 (NF)*	26	213	YZ	0	48.55	0	48.55	74	25.45	-	-	PK
V	22320 (NF)*	26	213	YZ	0	35.02	7.5	27.52	54	26.48	-	-	AVE
V	22320 (NF)*	26	213	YZ	0	49.78	0	49.78	74	24.22	-	-	PK

NF: Noise Floor  
 \*: Tested at 1m

Tested: March 31-April 2, 2010  
 Tested by: Grace Lin

### 3.9 Receiver Radiated Emissions

**Performance Criterion:** Receiver radiated emissions must meet the requirements of Table 1 of IC RSS-Gen. Receivers operating above 960 MHz or below 30 MHz are exempt from complying with the technical provisions of FCC Part 15 Subpart B.

**Test Results:** Complies

**Test Details:** Radiated emission was performed from 30 MHz to the fifth harmonics of the carrier. For each scan of radiated emission measurement, the procedures for maximizing emissions were followed. The EUT was rotated and antenna height was varied between 1 m and 4 m in order to maximize the emission. Measurements in both horizontal and vertical polarities were made and the data was recorded. All radiated emission measurements, up to 18 GHz, were performed at 3-meter distance between an antenna and the EUT.

For the measurement of radiated emission at the frequency range 30-1000MHz, measurement was made by using a quasi-peak detector with a 120 kHz bandwidth. For the frequency range above 1 GHz, measurement was made using an average detector with a 1 MHz bandwidth.

EUT was tested in three orthogonal orientations (XY, YZ, and ZX planes) with antenna at 0 and 90 degrees.

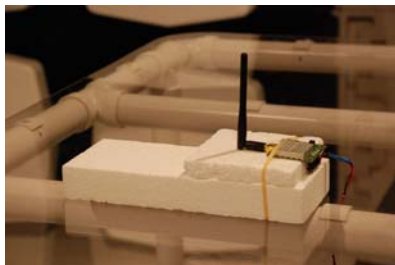

EUT = XY

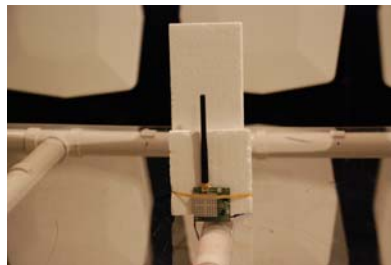

EUT = YZ

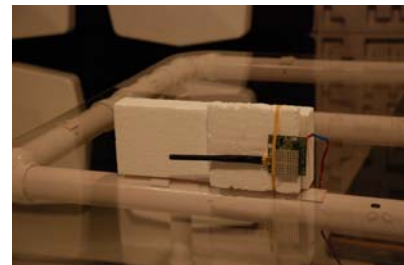

EUT = ZX

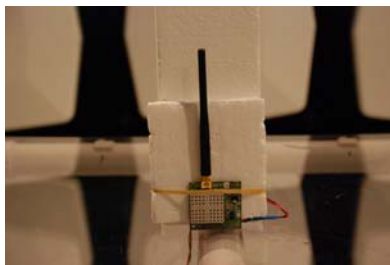

Antenna = 0

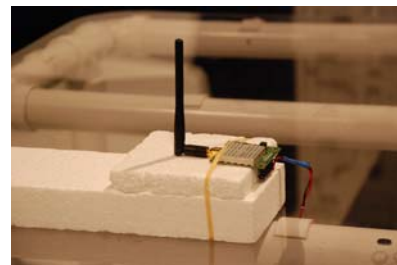

Antenna = 90



Refers to the following block diagram and receiver screen captures for test data. Antenna factor, cable loss, and preamplifier gain were compensated for in the receiver.

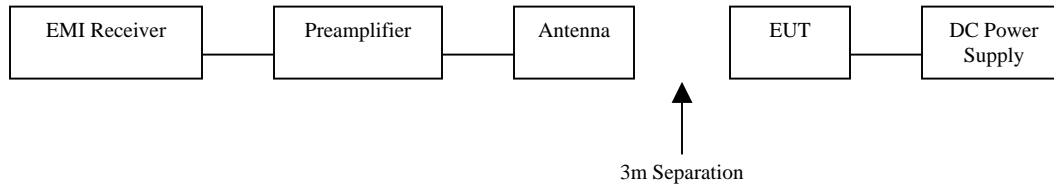

### Receiver Radiated Emission, 30MHz-1GHz:

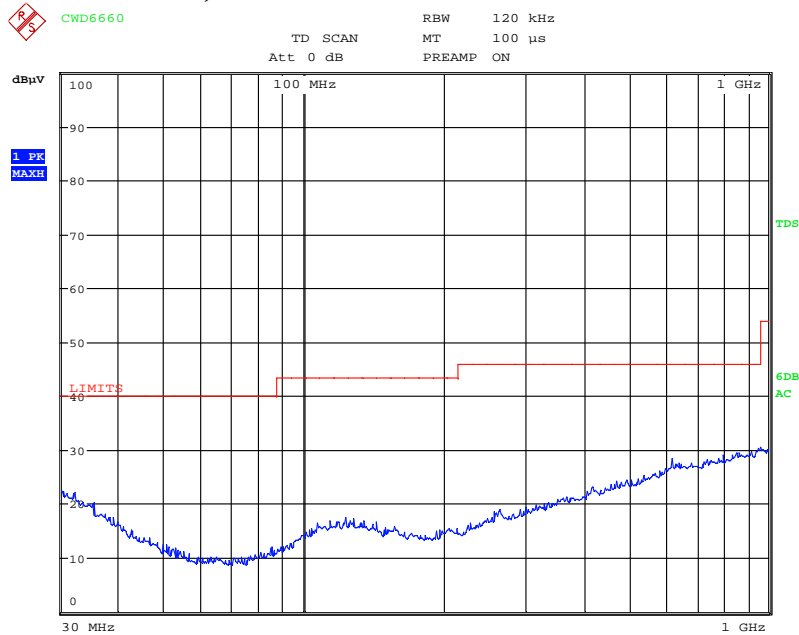

Date: 30.MAR.2010 14:13:14



**Receiver Radiated Emission, 1GHz-12.5GHz:**

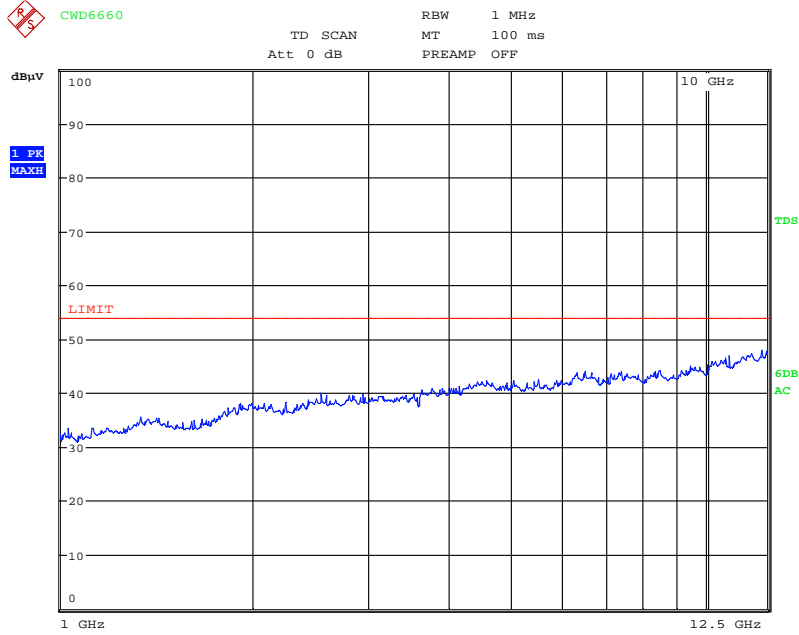

Date: 1.APR.2010 15:23:11

**Receiver Radiated Emission, 1GHz-12.5GHz, RBW=120kHz:**

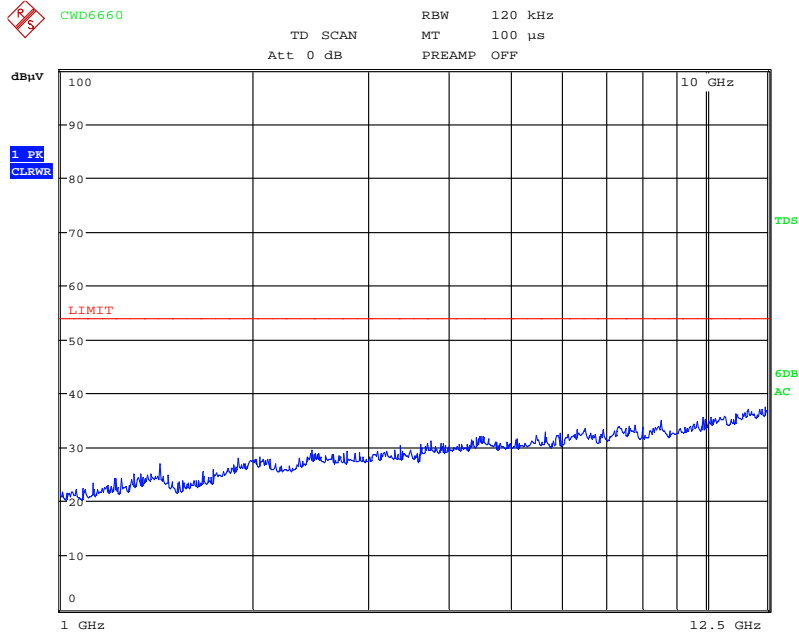

Date: 1.APR.2010 15:27:17



### 3.10 Receiver AC Power Line Conducted Emissions

**Performance Criterion:** AC power line conducted emissions shall not exceed the limits specified in FCC § 15.107 and Table 2 of IC RSS-Gen.

**Test Results:** Complies.

**Test Details:** AC power line conducted emissions were performed from 150 kHz to 30 MHz and measured with a resolution bandwidth of 9 kHz. EUT was set in the receiving mode. Refers to the following screen captures (using a peak detector) and block diagram.

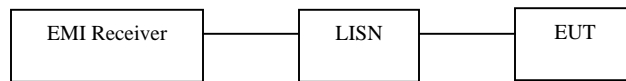

#### Line 1:

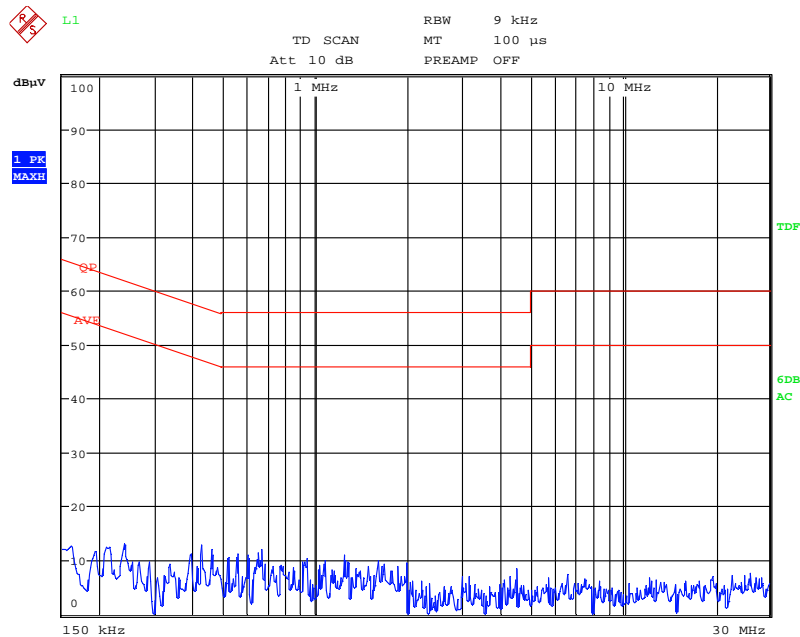

Date: 30.MAR.2010 09:59:07



Line 2:

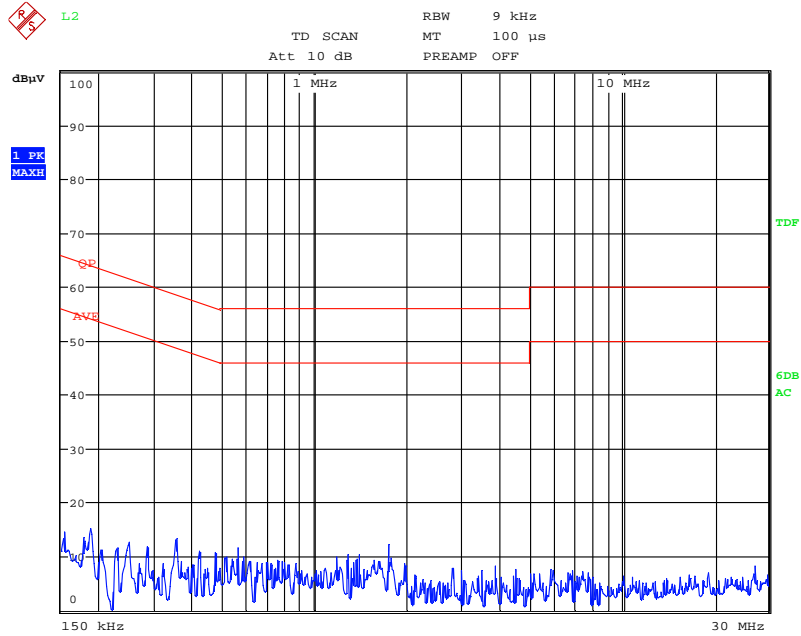

Date: 30.MAR.2010 09:59:50