

Paragon^{PD}
Data Base Station
Technical Manual
Version 2.01

Preliminary, for Internal Use Only

The entire contents of this manual and the Radio Installation Software described in this manual are copyright 2001 by DATARADIO Inc.

Copyright DATARADIO Inc.
May 2001

Part no.: 120 20170-201

Table of Contents

1. PRODUCT OVERVIEW	1
1.1 INTENDED AUDIENCE	1
1.2 GENERAL DESCRIPTION	1
1.2.1 Features:.....	1
1.3 FACTORY TECHNICAL SUPPORT	2
1.4 PRODUCT WARRANTY	2
1.5 REPLACEMENT PARTS	2
1.5.1 Factory Repair.....	2
1.5.2 Model Designation.....	3
1.6 RADIO SERIES I OR II.....	3
1.7 PACKAGING.....	4
2. INSTALLATION.....	4
2.1 OVERVIEW	4
2.2 LOCATION	4
2.3 ELECTRICAL	4
2.3.1 Radio Assembly Power	7
2.3.2 BDLC ^{PD} assembly Power.....	8
2.4 ANTENNA	8
2.4.1 Overview.....	8
2.4.2 Cabling and Connection.....	8
2.5 COMPLETING THE PHYSICAL INSTALLATION.....	8
2.6 CHECKING OUT NORMAL OPERATION.....	9
3. OPERATING DESCRIPTION.....	9
3.1 RADIO ASSEMBLY	9
3.1.1 Front panels.....	9
3.1.1.1 Receiver module	9
3.1.1.2 Exciter module.....	10
3.1.1.3 Power Amp module	10
3.1.1.4 Speaker panel.....	10
3.1.1.5 Dual Power Supply module	11
3.1.1.5.1 Rear Connections	11
3.1.2 Radio Assembly, rear panel.....	11
3.1.2.1 Backplane PCB	11
3.2 BDLC ^{PD}	12
3.2.1 BDLC ^{PD} Front panel.....	12
3.2.1.1 Front Switches	12
3.2.1.1.1 Reset.....	12
3.2.1.1.2 PF 1.....	12
3.2.1.2 LEDs and Indications.....	14
3.2.1.2.1 Radio Network Indicators	14
3.2.1.2.2 RS-232 Port Indicators.....	14
3.2.1.2.3 Check and Power	15
3.2.1.2.4 Alarm Indicators.....	15
3.2.2 BDLC ^{PD} Rear panel.....	16
3.2.2.1 Signal Levels.....	16
3.2.2.2 Pin Functions	16
4. WINRIS PROGRAM	18
4.1 OPERATION	18
4.2 TO CONNECT AND START WINRIS.....	18
4.3 WINDOW	19

4.4	FUNCTIONS.....	20
4.4.1	“Station Reset” button.....	20
4.4.2	Configuration to a file	20
4.4.2.1	“Get” button.....	21
4.4.2.2	“Get As” button.....	21
4.4.3	Configuration from a File.....	21
4.4.3.1	“Put From” button.....	21
4.4.4	Special Functions.....	21
4.4.4.1	Banner Field.....	22
4.4.4.2	Comments	22
4.4.4.3	Password.....	22
4.4.5	Test Functions.....	22
4.4.5.1	DSR signal is High indicator	22
4.4.5.2	CTS signal is High indicator.....	23
4.4.5.3	Channel Selection	23
4.4.5.4	TXON Tests.....	23
4.4.5.4.1	Unmodulated Carrier.....	23
4.4.5.4.2	Modulated Carrier	23
4.4.5.5	Ping Button	24
4.4.6	Status Bar	24
5.	TESTING AND TROUBLE-SHOOTING	25
5.1	EQUIPMENT REQUIRED.....	25
5.2	RECOMMENDED CHECKS.....	25
6.	RADIO PROGRAMMING AND ADJUSTMENTS.....	29
6.1	SERIES I 800MHZ RADIO PROGRAMMING	29
6.1.1	Recommended Items	29
6.1.2	Introduction	29
6.1.3	File Creation.....	30
6.1.4	Programming the EPROM.....	31
6.1.5	EPROM Installation	32
6.1.6	Channel Selection via DIP Switches.....	32
6.2	SERIES I 800MHZ RADIO TUNING	33
6.2.1	Test Equipment	33
6.2.2	Receiver Module (T885).....	34
6.2.2.1	Initial Setup.....	34
6.2.2.2	Synthesizer Alignment	34
6.2.2.3	Front-End Alignment	34
6.2.2.4	SINAD and Linearity Check.....	35
6.2.2.5	RSSI Adjustment	35
6.2.3	Exciter Module (T881).....	36
6.2.3.1	Initial Setup.....	36
6.2.3.2	Synthesizer Alignment.....	36
6.2.3.3	TX Frequency Error Adjustment.....	36
6.2.3.4	Low Frequency Balance Adjustment	37
6.2.3.5	Exciter Power Output.....	37
6.2.4	Power Amplifier Module (T889).....	38
6.2.4.1	Power Amplifier Power Out.....	38
6.2.4.2	Forward Power Alarm Level.....	38
6.2.4.3	Reverse Power Alarm Level (Optional).....	38
6.3	SERIES II RADIO PROGRAMMING.....	41
6.3.1	Recommended Items	41
6.3.2	Module Programming.....	41
6.3.3	Channel Selection via DIP Switches.....	44
6.4	SERIES II RADIO TUNING.....	45
6.4.1	Test Equipment	45

6.4.2	Receiver module (T855 & T835).....	45
6.4.2.1	Initial Setup.....	45
6.4.2.2	Synthesizer Alignment.....	46
6.4.2.3	Front-End Alignment.....	46
6.4.2.4	SINAD and Linearity Check.....	46
6.4.2.5	RSSI Adjustment (UHF: T855).....	47
6.4.2.6	RSSI Adjustment (VHF: T835).....	48
6.4.3	Exciter Module (T857, T837 or T881).....	49
6.4.3.1	Initial Setup.....	49
6.4.3.2	Synthesizer Alignment.....	49
6.4.3.3	TX Frequency Error Adjustment.....	49
6.4.3.4	Low-Frequency Balance Adjustment.....	50
6.4.3.5	Exciter Power Output.....	51
6.4.4	Power Amplifier Module (T859 or T839).....	51
6.4.4.1	Power Amplifier Power Output.....	51
6.4.4.2	Forward Power Alarm Level.....	51
6.4.4.3	Reverse Power Alarm Level (Optional).....	51
6.4.4.4	Tait T859 (UHF) Standard Tuning Procedure.....	52
6.4.4.5	Tait T859 Tuning for Best Efficiency.....	52
7.	SPECIFICATIONS.....	58

APPENDIX 1 - PARAGON^{PD} DEVIATION ADJUST.....	57
--	-----------

FIGURE 1 – TYPICAL RADIO AND POWER SUPPLY ASSEMBLIES, FRONT VIEW.....	5
FIGURE 2 - BDLC ^{PD} , FRONT VIEW.....	5
FIGURE 3 – TYPICAL RADIO AND POWER SUPPLIES ASSEMBLY, REAR VIEW.....	6
FIGURE 4 - BDLC ^{PD} , REAR VIEW.....	6
FIGURE 5 - BDLC ^{PD} 'S REAR CONNECTION, SWITCH AND FUSE.....	8
FIGURE 6 - RECEIVER MODULE FRONT PANEL.....	9
FIGURE 7 - EXCITER MODULE, FRONT PANEL.....	10
FIGURE 8 - POWER AMP MODULE, FRONT PANEL.....	10
FIGURE 9 - SPEAKER PANEL.....	11
FIGURE 10 - DUAL POWER SUPPLY REAR CONNECTIONS.....	11
FIGURE 11 - BDLC ^{PD} MEMBRANE SWITCHES.....	12
FIGURE 12 - RF INDICATORS.....	14
FIGURE 13 - RS-232 PORT LED INDICATORS.....	15
FIGURE 14 - ALARMS LED INDICATORS.....	15
FIGURE 15 - BDLC ^{PD} Y CABLE AND PINOUT.....	17
FIGURE 16 - WINRIS MAIN SCREEN.....	19
FIGURE 17 - “SELECT PORT” DIALOG WINDOW.....	20
FIGURE 18 - SERIES I RECEIVER SYSTEM INFORMATION.....	30
FIGURE 19 - SERIES I CHANNEL INFORMATION.....	31
FIGURE 20 - CHANNEL SELECTION VIA INTERNAL DIP SWITCHES.....	33
FIGURE 21 - T885 RECEIVER TUNING CONTROL LOCATION.....	39
FIGURE 22 - T881 EXCITER TUNING CONTROLS LOCATION.....	40
FIGURE 23 - RECEIVER SYSTEM INFORMATION.....	42
FIGURE 24 - RECEIVER CHANNEL INFORMATION SCREEN.....	42
FIGURE 25 - EXCITER SYSTEM INFORMATION SCREEN.....	43
FIGURE 26 - EXCITER CHANNEL INFORMATION SCREEN.....	43
FIGURE 27 - BACKPLANE DIP SWITCHES EXAMPLE - CHANNEL 5 SELECTED.....	44
FIGURE 28 - T855 AND T885, RSSI CURVE: VOLT TO DBM.....	47
FIGURE 29 - T835, RSSI CURVE: VOLT TO DBM.....	48
FIGURE 30 – T800-50-0001 BACKPLANE AND TEST PINS LOCATION.....	48
FIGURE 31 - T859 TUNING SETTINGS.....	52

FIGURE 32 - T855 RECEIVER TUNING CONTROLS LOCATION	53
FIGURE 33 - T857 EXCITER TUNING CONTROLS LOCATIONS	54
FIGURE 34 - T835 RECEIVER TUNING CONTROLS LOCATION	55
FIGURE 35 - T837 EXCITER TUNING CONTROLS LOCATION	56
TABLE 1 - POWER SUPPLY LEDs INDICATIONS	7
TABLE 2- TX MODE SELECTION LEDs INDICATIONS	13
TABLE 3 - TEST TRANSMISSIONS.....	13
TABLE 4 - RS-232 LED FUNCTION SELECTION SEQUENCE.....	14
TABLE 5 - RS-232 SIGNAL LEVELS.....	16
TABLE 6 - DTE PORT 9-PIN FUNTIONS	16
TABLE 7 - DTE PORT 25-PIN FUNCTIONS	16
TABLE 8 – CARRIER DEVIATIONS FOR TONE OR DATA MODULATION.....	23
TABLE 9 - KEY LATCH INDICATIONS.....	24
TABLE 10 - CHECKLIST A (AFTER INSTALLATION).....	26
TABLE 11 - CHECKLIST B (GENERAL).....	27

WHAT'S NEW IN VERSION 2.0

History

Preliminary - Version 2.01: May 2001

- First release of SRRC4FSK HC modulation model for the 800MHz model, with on-air speeds of 16.0 and 14.4 Kbps that accommodate 12.5 kHz channel spacing. Relevant changes made to:
 - Section 1.2.1 "Features"
 - Section 1.5.2 "Model Designation"
 - Table 3 "Test transmissions"
 - Table 10 "Checklist B (General)"
 - Section 7 "Specifications"
- Clarification of fuse type used, section 2.3.1

Version 2.0: May 2001

- First release covering, in addition to the DGFSK model, the SRRC4FSK modulated model with speeds of up to 25.6 Kbps. Relevant changes made to:
 - Section 1.2.1 "Features"
 - Section 1.5.2 "Model Designation"
 - Table 3 "Test transmissions"
- This version introduces the following changes:
 - Section 1.6 "Radio Series I or II":
 - Revised description
 - Section 2.3 "Electrical":
 - Clarification of amperage requirement
 - Figure 4 "BDLC^{PD}, rear view". Re-tracing of top fan wiring to correspond to factory routing.
 - Section 3.1.1 "Receiver":
 - Endnote added to clarify troubleshooting characteristic.
 - Section 3.1.1.5 "Dual Power Supply", clarification of "OL" (overload) LED function.
 - Figure 10 "Dual Power Supply Rear Connection" corrected to correspond to the voltage printed on the connector label.
 - Section 4 "WinRIS" program detailed.
 - Table 8 "Carrier deviations for Tone or Data Modulation". Now incorporates in a single table the details previously available as Table 8 and Table 10.
 - Table 10 "Checklist B, (General)", steps 6 and 7 revised to merge values for the two models.
 - Table 11 "Checklist B, (Paragon/PD)" steps 6,7 and 10 revised
 - Figure 20 "Channel Selection via internal DIP switches", clarifies the use of switch 8.

- Section 6.2.3.5 and 6.4.3.5 "Exciter Power Output" correction of output power to 4 Watts.
- Figure 21 "T885 Receiver tuning control location", clarification of RSSI test point location.
- Section 7 "Specifications":
 - Rx and Tx "Current Consumption" values revised.
 - Base Station "Power Consumption" specification added.
- Supersedes Paragon/PD Addendum 124 20170-001a, dated February 2001.
- Supersedes Technical Support Bulletin TSB ATL007, dated 17 April, 2001 and titled "New Deviation Settings for 800MHz Gemini^{PD} and Paragon^{PD} with 4 level FSK Modulation".

Version 1.0: May 2000

- First released version, DGFSK modulated model, and speeds up to 19200 b/s.

Definitions

The following terms are used throughout this document.

Asynchronous	Information that can be sent at random times, and not synchronized to a clock. Transmission characters begin with a “start” bit and end with a “stop” bit.
AVL	Automatic Vehicle Location. Optional feature that involves using GPS (Global Positioning System) signals from the mobile unit by the Host PC.
BDLC^{PD}	Base Station Data Link Controller (PD = Parallel decode). An async radiomodem designed to control the base station in mobile systems. A component of Paragon ^{PD} .
DBA	Dataradio’s Dynamic Bandwidth Allocation protocol designed for short-inquiry/long response applications such as dispatch systems. Latest enhancements include support for occasional long messages inbound, and for Out-of-Band data for AVL reports with no extra overhead.
DCE	Data Communications Equipment. This designation defines the direction (input or output) of the various RS-232 interface signals. Modems are always wired as DCE.
DTE	Data Terminal Equipment. This designation defines the direction (input or output) of the various RS-232 interface signals. Most user equipment, as well as PCs, are wired as DTE.
Gemini^{PD}	High specs mobile radiomodem. (PD = Parallel Decode)
Network Speed	This is the <i>bit rate</i> on the RF link between units. Could be different from COM port <i>baud rate</i> .
Paragon^{PD}	Factory-integrated industrial-grade data base station using Parallel Decode technology. Used in VIS mobile networks.
Parallel Decode	Technology featuring dual receivers for added data decode sensitivity in multipath and fading environments.
Refarming	FCC’s strategy for using the radio spectrum more efficiently to meet future communications requirements.
Radio Assembly	Radio modules used in Paragon ^{PD} and available in two distinct series depending on radio’s frequency band.
RS-232	Industry–standard interface for serial data transfer.
VIS	Vehicular Information Solutions. Dataradio’s name for a series of products specially designed for mobile data.
WinRIS	Windows Radio Installation Software. This software allows basic tests, unit configuration and troubleshooting.

1. PRODUCT OVERVIEW

This document provides the information required for the setting up, operation, testing and troubleshooting of the DATARADIO Paragon^{PD} radio-modem base station.

1.1 Intended Audience

This document is intended for engineering, installation, and maintenance personnel.

1.2 General Description

Paragon^{PD} product is a factory-integrated industrial-grade data base station used in mobile networks and is designed specifically to fit the needs of vehicular applications.

It features dual receivers for added data decode sensitivity in multi-path and fading environments.

When used with Dataradio's state-of-the-art Gemini^{PD} mobile data solution, the system delivers unequalled high-speed data performance and unmatched effective throughput.

All Paragon^{PD} models are supplied in a rack-mount configuration that includes:

- A Paragon^{PD} Radio assembly
- A contemporary, high-speed Dataradio "Base Station Data Link Controller" (BDLC^{PD}).

Paragon^{PD} units do not include the optional wire line modem(s). Duplexer and backup power units are custom furnished items. The laptop PC and its application software are user-supplied items.

1.2.1 Features:

- Dual receivers Parallel Decode technology
- SRRC4FSK modulation capable of 25600 and 19200 b/s in 25 kHz or 16000 and 14400 b/s in 12.5 kHz channel spacing
- Sophisticated DSP-based modem design provides added system performance and fewer retries
- Available in VHF, UHF and 800 MHz radio bands
- Power output of 20W to 70W for Paragon^{PD}'s 800 MHz and of 20W to 100W for VHF and UHF
- Supports high-efficiency Dataradio DBA over-the-air protocol
- Over-the-air compatible with MobilPac/R DGFSK and SRRC4FSK modulated Gemini^{PD} mobile products *
- Modular design in a rugged die-cast aluminum chassis
- Full-duplex operation
- Paragon^{PD} units are factory-configured based on each customer's network system requirements
- Flash programmable firmware upgradability.

* Networks must use common modulation scheme, bit and baud rates

1.3 Factory Technical Support

The Technical Support departments of DATARADIO provide customer assistance on technical problems and serve as an interface with factory repair facilities. They can be reached in the following ways:

DATARADIO Inc.
5500 Royalmount Ave, suite 200
Town of Mount Royal
Quebec, Canada H4P 1H7

Technical support hours: Monday to Friday 9:00 AM to 5:00 PM, Eastern Time

phone: +1 514 737-0020
fax: +1 514 737-7883

Email address: support@dataradio.com

or

DATARADIO Corp.
6160 Peachtree Dunwoody RD., suite C-200
Atlanta, Georgia 30328

Technical support hours: Monday to Friday 8:30 AM to 5:30 PM, Eastern Time

phone: 1 770 392-0002
fax: 1 770 392-9199

Email address: drctech@dataradio.com

1.4 Product Warranty

Warranty information may be obtained by contacting your sales representative.

1.5 Replacement Parts

This product is usually not field-serviceable, except by the replacement of individual radio modules. Specialized equipment and training is required to repair logic, modem boards and radio modules.

Contact Technical Support for service information before returning equipment. A Technical Support representative may suggest a solution eliminating the need to return equipment.

1.5.1 Factory Repair

When returning equipment for repair, you must request an RMA (Returned Material Authorization) number. The Tech Support representative will ask you several questions to clearly identify the problem. Please give the representative the name of a contact person, who is familiar with the problem, should a question arise during servicing of the unit.

Customers are responsible for shipping charges for returned units. Units in warranty will be repaired free of charge unless there is evidence of abuse or damage beyond the terms of the warranty. Units out of warranty will be subject to service charges. Information about these charges is available from Technical Support.

1.5.2 Model Designation

To correctly identify your Paragon^{PD} unit, check its catalog number label located on the rear of the BDLC^{PD} adjacent to the power connector.

The first four digits designate the model:

- BDDD = Paragon^{PD} (DGFSK)
- BDD4 = Paragon^{PD} (SRRC4FSK)

The next three digits designate the Band used:

- 83X = VHF, 100W
- 85X = UHF, 100W
- 88X = 800 MHz, 70W

The next digit designates the RF band of operation:

For the 83X band:

- 1 = 136 – 156 MHz
- 2 = 148 – 174 MHz

For the 85X band:

- 1 = 400 – 440 MHz
- 2 = 440 – 480 MHz
- 3 = 480 – 520 MHz

For the 88X band:

- 1 = 800 – 880 MHz (RX)
850 – 870 MHz (TX)
- 2 = 870 – 960 MHz (RX)
(TX, 5W only)

The next digit designates the RF Bandwidth used:

For the 83X band:

- 0 = 25 kHz full channel, 2.5 ppm*
- 5 = 12.5 kHz half channel, 2.5 ppm*
- 6 = 12.5 kHz half channel, 2.0 ppm* (U.S. model only)

For the 85X band:

- 0 = 25 kHz full channel, 1 ppm*
- 5 = 12.5 kHz half channel, 1 ppm*

For the 88X band:

- 0 = 25 kHz full channel, 1.5 ppm*
- 5 = 12.5 kHz half channel, 1.5 ppm*

* denotes Frequency Stability

The next digit designates the transmitter power:

- 005 = 5 watt transmitter
- 070 = 70 watt transmitter (850-870 MHz only)
- 100 = 100 watt transmitter

The next and last digit designates the Power Source:

- 0 = Power supply deleted on order
- 2 = heavy-duty 120 VAC dual supplies

1.6 Radio Series I or II

System-engineered installations use one of two complements of Paragon^{PD} radio modules. To identify the radio series model, check the part number on the manufacturer's label at the back of the Receiver and Exciter:

- T8nn-nn identifies a Series I model.
- T8nn-nn-nnnn identifies a Series II model.
where "n" denotes a number.

Examples:

- T881-10 is a Series I Exciter (850–870 MHz)
- T881-10-0000 is a Series II Exciter (850–870 MHz)

They are assembled on a common chassis:

Series I models:

- 800 MHz frequency range radios
- Frequency programming is done via EPROM. (This model does not use the programming port of Series II models).

Series I models will not be available after the Series II models receive FCC's and IC's approvals.

Series II models:

- VHF and UHF frequency range radios. The 800MHz Series II models are pending FCC & IC approvals.
- Frequency programming is done using software via a programming port located on the speaker front panel.

1.7 Packaging

Each Paragon^{PD} product normally leaves the factory packaged as follows:

- A Series I or II Dataradio base station “Radio assembly”
- A dual power supply assembly
- A Dataradio BDLC^{PD} model
- A Radio Interface Cable to link the Radio assembly to the BDLC^{PD}:
 - 18-inch long “Y” cable; DB-25 female to dual DB-25 female (p/n 730 03374-102) for connection between backplane PCBs and BDLC^{PD}.
- One standard seven-foot 120VAC power cord
- Two DC power cables to connect the radio assembly to the dual power supply assembly.
- Courtesy small parts kit

Frequently, Paragon^{PD} product components are field-assembled prior to customer delivery. The cabinetry may then be supplied in one of several custom rack-mount configurations that may also include fan, backhaul modems, duplexer/filters/combiners, and ancillary equipment.

If damage has occurred to the equipment during shipment, file a claim with the carrier immediately.

2. Installation

2.1 Overview

The cabinet and rack-mount housing the Paragon^{PD}'s Radio assembly and the BDLC^{PD} is generally installed in a sheltered facility. Occasionally located adjacent to the nerve center of the user's network, it is often located near tower sites or at remote locations where it operates unattended.

Furnishings needed include power, cabling and installation of antenna, landline or microwave modem and host PC or portable computer. Details of these are outside the scope of this manual. This manual covers the radio assembly and the BDLC^{PD} that includes the modem.

2.2 Location

Be sure to place the Paragon^{PD} in such a way that:

- The LEDs can be seen (as an aid in troubleshooting)
- Access to the antenna connector and to the back connectors is possible without removing the unit
- Sufficient air may flow around the unit to provide adequate cooling.

2.3 Electrical

Standard 120 VAC electrical power is required. It should be capable of providing at least 10A per power Paragon^{PD} (<6A) and ancillary equipment.

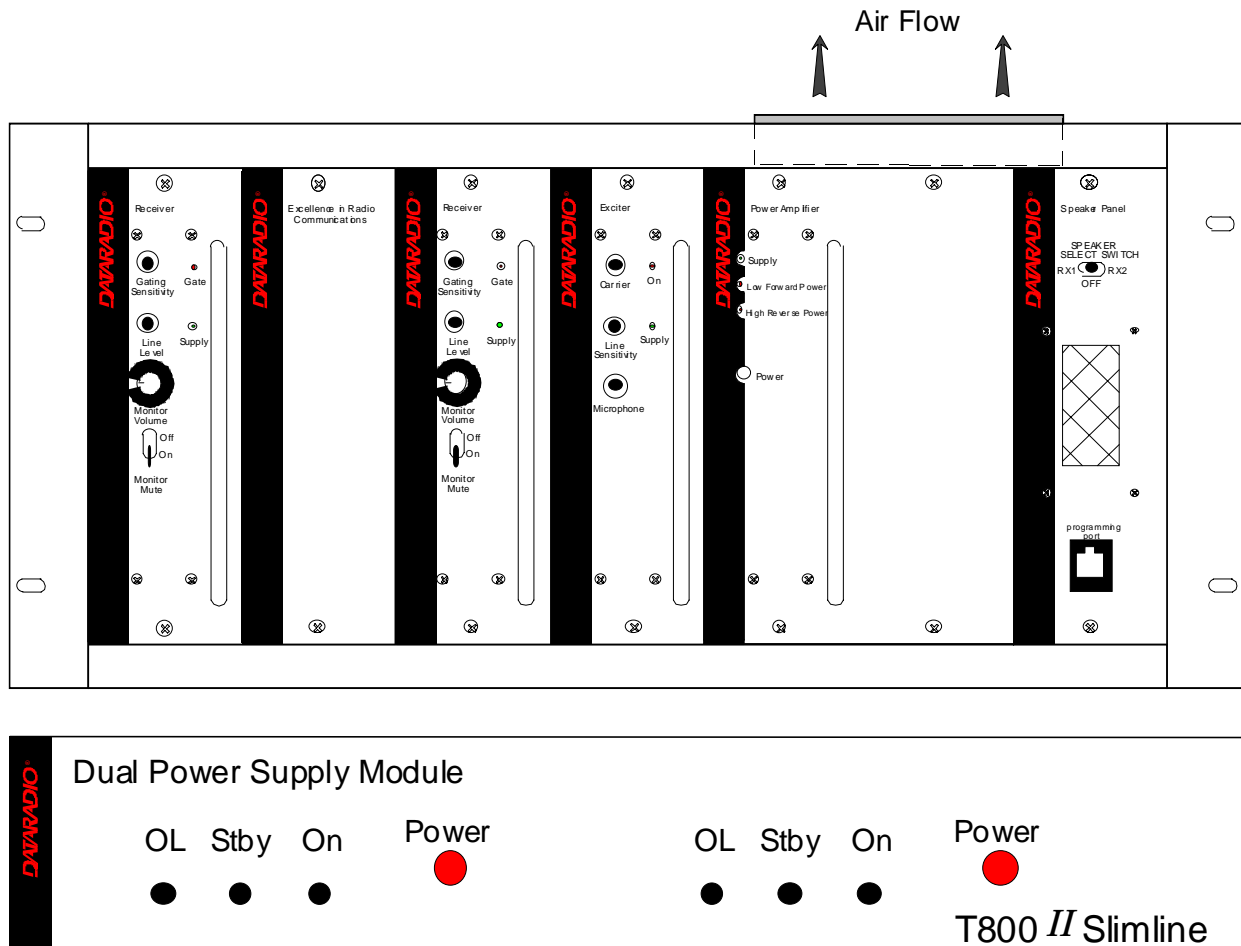

Figure 1 – Typical radio and power supply assemblies, front view

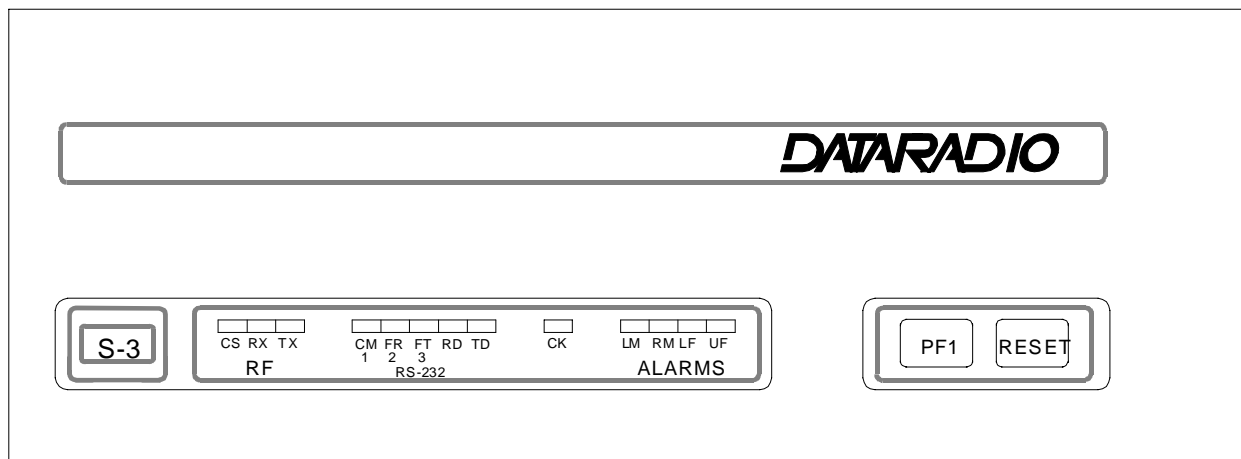

Figure 2 - BDLCPD, front view

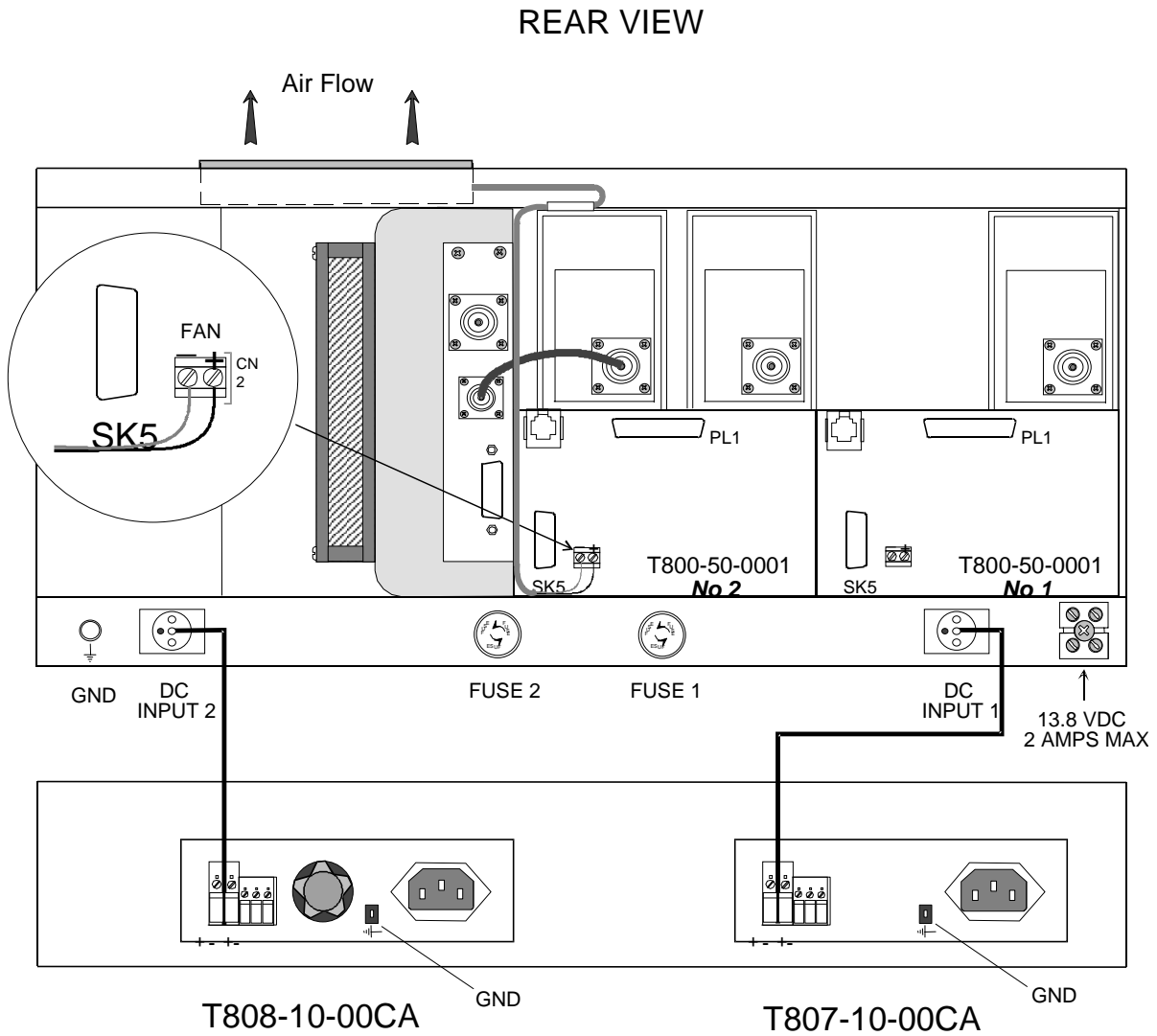

Figure 3 – Typical radio and power supplies assembly, rear view

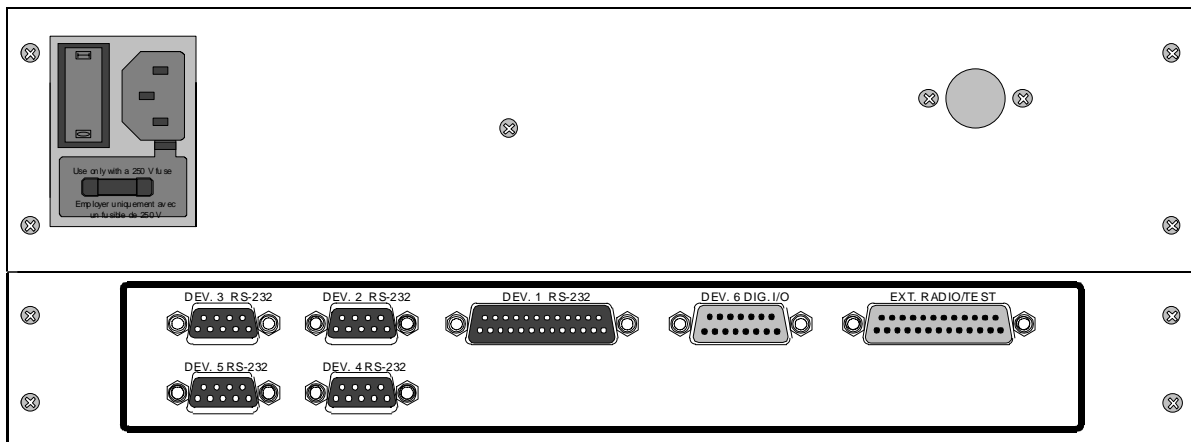

Figure 4 - BDLC^{PD}, rear view

2.3.1 Radio Assembly Power

Referring to Figure 3, the Radio assembly unit receives two separate 13.8 VDC power inputs from a “T800 Slimline” dual power supply typically rack-mounted right below the main assembly radio chassis.

The T800 is made up of two separate power supply units joined in a single chassis:

- A T807 using convection cooling is rated up to 15A at 13.8VDC. It supplies all the radio modules other than the Power Amplifier.
- A T808 using convection and fan cooling is rated up to 25A at 13.8VDC. It supplies only the Power Amplifier module.

Normally used at room ambient temperatures, they can operate within specifications over a range of -10 to +60 °C.

Note: Internal over-temperature protection shuts down the main transformer above 105 degrees Celsius.

Both power supply modules are internally connected to ground via their individual, rear-connected, seven-foot standard 120 VAC power cords. Nevertheless, each requires a separate secure electrical ground connection. Individual grounding tabs are provided next to the power connectors.

Similarly, the Radio Assembly chassis requires a secure ground connection. A threaded grounding binding post fitted with a knurled binding-nut is provided on the chassis next to DC input 2.

Separate grounding leads with appropriate connectors are supplied (either in the courtesy small-parts kit or with one end fastened to the equipment.

A- For each of the power supply modules:

1. Fit one end of the grounding lead’s push-on connector onto the grounding tab.

B- For the Radio Assembly chassis:

1. Install the grounding lead’s lug over the binding post and firmly hand-tighten the binding-nut.

For both A and B

2. Fit the slotted connector (on the other end of each of the grounding connector) under a conveniently located screw on the rack frame or other support surface. Scrape away paint if needed to ensure clean contact.
3. Apply anti-corrosion compound where paint scraping was done.
4. Ensure by testing continuity that a secure electrical and mechanical connection is achieved.

If a -DC rail (0V) is installed as part of the system, the grounding leads may alternatively be fitted to the rail terminal.

Caution:

Improper grounding between power supply case and rack frame may result in harmful voltage potentials and/or miscellaneous power supply switching noise problems in both receivers and transmitter.

Press both red power buttons located on the front of the module to have complete power distribution to the Radio assembly.

The power supply front panel LEDs indications are:

Table 1 - Power Supply LEDs Indications

LED	Color	Indication
On	Green	Power enabled *
Stby	Red	Power disabled *
OL	Steady Red	Current Overload
On & OL	Flashing green and red respectively	Over voltage

* To remove voltage from the power supply PCB, disconnect the main power cords.

For LEDs descriptions, see section 3.2.1.2

The Radio assembly is fused at the rear of the chassis:

- Fuse 1 is a 32-volt MDL 10A (Cartridge 6x32mm, slow-blow)
- Fuse 2 is a 32-volt MDL 30A (Cartridge 6x32mm, slow blow)

2.3.2 BDLC^{PD} assembly Power

The BDLC^{PD} assembly uses a standard 120 VAC power cord. Plug this cord to the rear power outlet shown in Figure 6.

To check or install a fuse:

1. Open the slide-out fuse drawer located below the power connector.
2. Use a fine bladed screwdriver or a knife blade and gently pry open.
3. Hold the fuse support in one hand and with the other, lift the center plastic retainer until it releases the fuse sliding base.
4. Replace or install a 250V, 2A fuse.
5. To complete the procedure, push the sliding fuse base until it snaps under the retainer.
6. Re-insert the fuse drawer in its housing and push until it is fully seated and closed.

When ready to apply power, use the ON-OFF toggle power switch adjacent to the power connector.

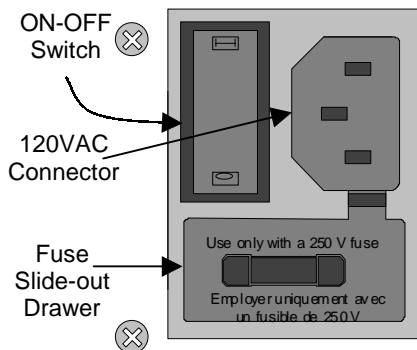

Figure 5 - BDLC^{PD}'s rear connection, switch and fuse

2.4 Antenna

2.4.1 Overview

Paragon^{PD} commonly uses three antennas (one transmit and two receive) unless a duplexer is used with one of the receive antennas; then only two antennas would be needed. They should be mounted according to any guidelines supplied with the antennas. For antennas placement and spacing, consult System Engineering.

2.4.2 Cabling and Connection

- 1- Route good quality 50-ohm double-shielded coaxial cable(s) (e.g. RG-214 or HeliAx) from the selected antenna position(s) to the Paragon^{PD} Radio assembly.
- 2- Terminate the RX-1 and RX-2 cable ends at the Receiver modules rear position with an N-type connector.
- 3- Similarly, terminate the TX cable end at the Power Amp's module rear position with an N-type connector.

Caution:

When terminating RF cables use brand-name crimping tools (such as AMP, Jensen, Crimp-Master, etc...) of the correct size for the cable and type of connector used.

Common pliers are NOT acceptable.

2.5 Completing the physical Installation.

Paragon^{PD} products are factory-configured to user's requirements and are shipped ready to run.

After new installations:

- Re-check that all connections are secure on radio and BDLC^{PD} assemblies (antennas, PC, power cords etc.)
- Check that fuses are inserted.
- Turn both BDLC^{PD} and radio power ON.

You are now ready to check for normal operation and to run the Windows Radio Installation Software (WinRIS) program for testing or trouble-shooting.

Any change(s) to the settings must be done via files saved on diskette and loaded into the unit using the WinRIS program.

2.6 Checking out Normal Operation

- 1- Check that power is applied.
- 2- Check Radio assembly lights for proper operation as per section 3.1.1
- 3- Check for proper operation of the BDLC^{PD}'s LEDs as per section 3.2.1.2.
- 4- Using the WinRIS program (described in section 4), and an in-line wattmeter, check the forward & reflected power to confirm antenna installations.
- 5- Using the WinRIS, check the RF link with a mobile station that can be heard, by using the WinRIS "Ping" feature. See section 4.4.5.5

If user application and a mobile station are available, test the installation by going through a normal sequence of transmitting and receiving messages.

3. Operating Description

3.1 Radio Assembly

The Radio assembly component of each Paragon product is made up of high performance synthesized radio base station designed for single operation. Referring to Figure 1 on page 5, the Radio Assembly's modules are commonly installed in a standard, 19-inch wide rack frame.

3.1.1 Front panels

The complement of modules is identical for:

Series I, (800 MHz model) and
Series II, (VHF and UHF models)*

* 800 MHz models will be available as Series II at a future date)

- 2 Receivers
- Exciter
- Power Amplifier
- Speaker panel
- Dual Power Supply

3.1.1.1 Receiver module

The RX1 and RX2 receivers' use identical front panel controls and indicators. These are:

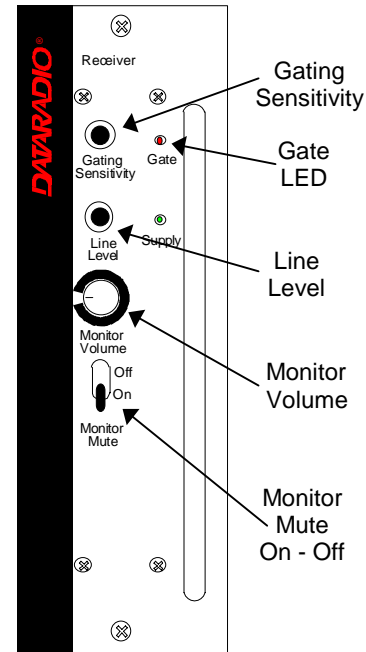

Figure 6 - Receiver module front panel

- Gating Sensitivity - sets the RF signal level required to open the mute gate and allow audio to pass to the speaker¹.
- Gate LED - indicates the status of the mute circuit. It is lit when a signal above the mute threshold is received¹.
- Supply LED - is lit when DC power is applied. Fast Flashes when linked with PGM800Win. Slow Flashes indicates VCO (synthesizer) out of lock. Unequal Flashes indicates internal communication error.
- Line Level - Not used
- Monitor Volume - The audio output delivers up to one watt to the speaker. Always set

¹ "Gating Sensitivity" and "Gate LED" are not functionally used except to allow listening to incoming receptions as a trouble-shooting aid.

Depending on the sensitivity adjustment, the Gate LED lights and a relay can be heard on incoming RF signals.

volume knob to minimum when not in use to reduce current consumption.

- Monitor Mute Switch - opens the mute, allowing continuous monitoring of the audio signal.
On = audio muted

3.1.1.2 Exciter module

The Exciter's front panel controls and indicators are:

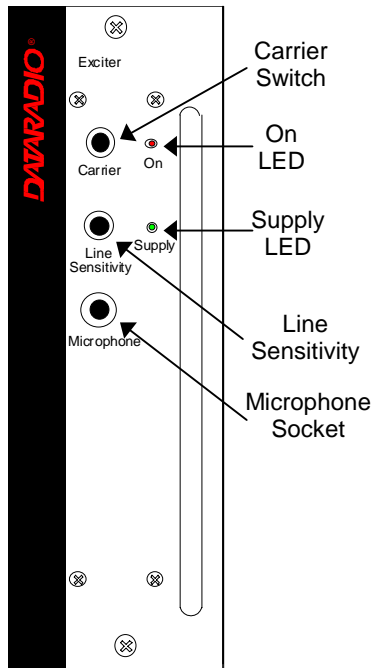

Figure 7 - Exciter module, front panel

- Carrier Switch - momentarily keys the transmitter ON while pressed (used for test purposes only).
- On LED - is lit when transmitting
- Line Sensitivity – not used.
- Supply LED - is lit when DC power is applied. Fast Flashes when linked with PGM800Win. Slow Flashes indicates VCO (synthesizer) out of lock. Unequal Flashes indicates internal communication error.
- Microphone Socket – not used.

3.1.1.3 Power Amp module

The Power Amp front panel and indicators are:

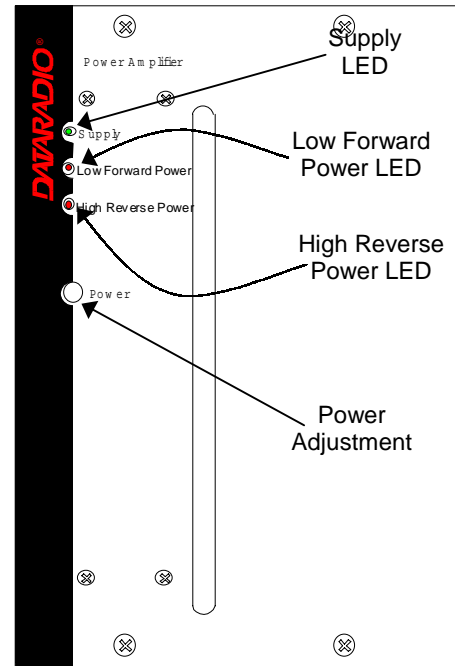

Figure 8 - Power Amp module, front panel

- Supply LED - is lit when DC power is applied.
- Low Forward Power LED - is lit when forward power is below the level set, normally 80% of nominal forward power.
- High Reverse Power LED - is lit when high reverse power is detected (e.g. VSWR= 3:1).
- Power - sets the PA output power:
 - VHF & UHF: 20 – 100 Watts
 - 800: 20-70 Watts

3.1.1.4 Speaker panel

Referring to Figure 9, the speaker panel is fitted with a 4Ω speaker.

Both series of radio assemblies share the same front panel fitted with an RJ11 connector. This connector is used to allow programming the radio from the front of the unit via a programming lead. This feature is exclusive to the Series II modules.

If the speaker panel needs to be removed, a mirror programming port connector is provided on both backplanes.

Programming for Series I 800MHz units is done via EPROM and is detailed in section 6.1. The RJ11 front port is covered (not used).

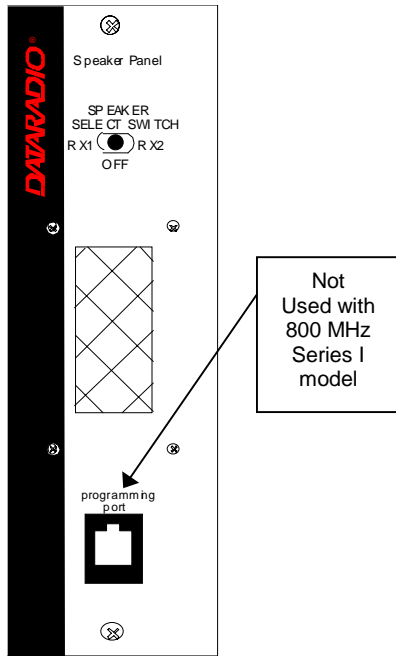

Figure 9 - Speaker panel

3.1.1.5 Dual Power Supply module

The Dual Power Supply module is made up of two separate power supply units coupled in a single chassis.

Refer to Table 1 on page 7 for tabular listing of power supply LEDs indicators.

Refer to Figure 1 for the front panel LED layout.

This module has:

- Two “Power” red-colored pushbutton switches - Push in for ON and release out for OFF. Control complete power distribution to the Radio assembly
- Two “ON” LEDs - light green when push button(s) is (are) ON; DC power is distributed to radio modules. Flash green in conjunction with the “OL” LED (flashing red) when an over voltage condition is present.

- Two “Stby”- Standby voltage LED, lights red when push button is off; AC power is applied but DC is not distributed to radio modules. To remove presence of voltage, disconnect both power cords.
- Two “OL” LEDs - Monitor current overload, light steady red when supply exceeds current limit set; nominally 25Amps (T808 model). Flashes red in conjunction with the ON LED (flashing green) when an over voltage condition is present.

3.1.1.5.1 Rear Connections

Referring to Figure 10, (convection-cooled model shown; fan-cooled model not illustrated), the rear connections for each of the power supply are:

Fail Alarm –

Off: Power supply OK; approx. +Vout (via 1k resistor - typ. 13.8V).

ON: Power supply failure; approx. -Vout (via 11k resistors - typ. 0V)

+ Remote – Not used for Paragon

- Sense – Not used for Paragon

-VE – main ground (0V)

+13.8V – Mains DC output supply

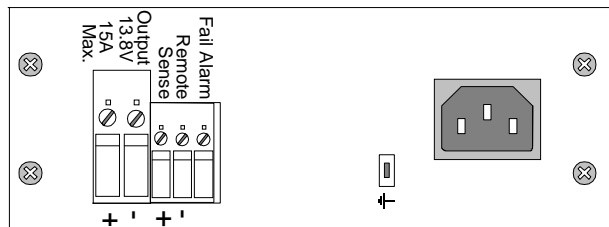

Figure 10 - Dual Power Supply rear connections

Note: more power supply installation details are covered in section 2.3.1

3.1.2 Radio Assembly, rear panel

3.1.2.1 Backplane PCB

Referring to Figure 3, two main backplanes are used. Their main components are:

- RJ11 connector – Mirrors the one on the front of the Speaker panel (series connected

to both backplanes). Used for programming the Radio Assembly whenever the speaker panel has been removed.

This feature is exclusive to the Series II model. Series I model's programming is done externally via EPROMs.

- DB-25M plug at PL1 (one side of the “Y” cable on each PCB) – used to supply the receive signal to the BDLC^{PD}'s single “EXT.RADIO/TEST” DB-25F plug.
- Two channel-select DIP switches (SW1 and SW2)
This feature is exclusive to the Series II model.
- Cooling fan driver – CN2 located on back-plane connects to the horizontally-mounted fan on top of the Radio assembly and activated by BDLC's PTT signal.
- Coaxial relay driver – not used.

3.2 BDLC^{PD}

The rack-mounted BDLC^{PD} is housed in a steel case. It has no user serviceable parts. Unit's configuration is stored in flash memory (EEPROM).

3.2.1 BDLC^{PD} Front panel

Referring to Figure 2, the front panel of the BDLC^{PD} has two cutouts across its length.

A- The *left* cutout groups the unit's type label and ten LED indicators:

- The S3 label designates the BDLC^{PD} as a “three Serial-port” model
(Ports 4 and 5 are reserved for future use)
- The RF group of 3 LEDs
- The RS-232 group of 5 LEDs
- A single CK LED
- The ALARMS group of 4 LEDs

B- The *right* cutout groups two tactile (membrane) switches (PF1 and RESET).

3.2.1.1 Front Switches

Referring to Figure 11, the BDLC^{PD} uses two membrane-type switches labeled:

- RESET
- PF 1

These switches indicate contact by emitting a short BEEP tone when pressed.

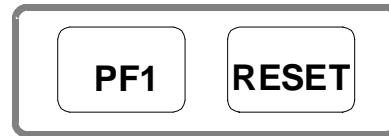

Figure 11 - BDLC^{PD} membrane switches

3.2.1.1.1 Reset

Pressing Reset produces the same result as powering OFF and ON again. It restarts the micro-processor, the peripherals and invokes the on-board diagnostics. BDLC^{PD}'s radio modules' internal flash-memories are read and their values are loaded in system SRAM CPU flash-memory.

Normally, pressing Reset results in one short BEEP tone followed by all LEDs coming ON for about four seconds. Then, the LEDs flash in a “ripple” pattern for close to two seconds indicating diagnostics are in progress. At the end of this period, all LEDs should be OFF except CK that should flash about six to eight times per second.

Expect an additional two seconds delay for CK to start flashing and the UF indicator to come ON if the radio assembly is not connected or not powered (see section 3.2.1.2.4 for Alarm details).

3.2.1.1.2 PF 1

PF 1 is a multi-function switch:

- It clears LED error indications
- It initiates test transmissions
- It sets the function of the RS-232 LEDs

3.2.1.1.2.1 Clearing Errors

Major and minor error LED indications remain lit on the front panel until:

- The unit is RESET
- The unit is powered OFF and ON again
- PF 1 is pressed

The PF 1 switch can be pressed at any time to clear an error display without affecting normal operations.

3.2.1.1.2.2 Test Transmissions

To select a pattern and begin transmission, start by pressing and holding PF1. It beeps once, all five RS232 LEDs light; listen for a second beep followed by a third beep. After two seconds, the unit beeps and goes in “TX Select” mode with only the three rightmost RS-232 LEDs now used as selection indicators. Only release PF1 after the third beep.

Following release:

- Start of selection must be made within two seconds. If not, the unit will default to pattern one and start test transmitting.
- PF1 may be pressed more than once. The number of times it is pressed determines the type of pattern that will be transmitted according to Table 3.
- Each pressing of PF1 extends the two-second timer.
- The three rightmost RS-232 LEDs display are used to indicate TX mode selection as shown in Table 2.

Table 2- TX mode selection LEDs indications

TX pattern selected	Binary TX mode LED indications		
	FT LED	RD LED	TD LED
1	Off	Off	On
2	Off	On	Off
3	Off	On	On
4	On	Off	Off
5	On	Off	On
6	On	On	Off
7	On	On	On

Once the type of transmission is selected, stop pressing PF1, allow the two-seconds timer to run down. Automatically, the BDLC^{PD} turns its transmitter ON, sends the selected “test pattern” for 55 seconds and turns its transmitter OFF.

The TX LED in the RF group of indicators lights in red while test transmitting. Pressing PF1 while the 55 seconds test is in progress stops the test.

At the end of test transmission, BDLC^{PD} operation returns to normal and the RX LED lights in green (monitoring normal transmitter activity).

Table 3 - Test Transmissions

# times PF1 is pressed	DGFSK Paragon ^{PD}		
	9600 b/s	16000 b/s	19200 b/s
1	2400 Hz Dotting	4000 Hz Dotting	4800 Hz Dotting
2	4800 Hz	8000 Hz	9600 Hz
3	100 Hz Square wave		
4	Random data		
5	Unmod		
6	1000 Hz sine beacon mode		
7	1000 Hz sine wave Adjustment tone		

# times PF1 is pressed	SRRC4FSK Paragon ^{PD}			
	14400 b/s	16000 b/s	19200 b/s	25600 b/s
1	1800 Hz Dotting*	2000 Hz Dotting*	2400 Hz Dotting*	3200 Hz Dotting*
2	Do not use			
3	100 Hz Square wave			
4	Random data			
5	Unmod			
6	1000 Hz sine beacon mode			
7	1000 Hz sine wave Adjustment tone			

* Dotting with reduced amplitude

Notes:

- For DGFSK models, a dotting pattern consists of an alternating series of bits.
For the SRRC4FSK models, only the lowest-level symbol's modulation is used.
- The square wave is used to check transmitter low frequency balance.
- The 1000 Hz sine can be used for transmitter distortion measurements.
- Pattern 6 produces a transmission of approximately 55 seconds followed by about 55 seconds of silence.
Initial transmission in a sequence may be shorter than 55 seconds. TX LED stays steadily red for duration of the test. Press PF1 to terminate beacon mode.

3.2.1.1.2.3 RS-232 LED Function Selection

The PF 1 button is used to select the RS-232 display mode as follows:

- If pressed *ONCE* (do not hold pressed):
 - Clears Alarm indications
 - CK LED stops flashing for 2 seconds
 - During this time, one or all of the RS-232 numbered LEDs (see Figure 13) will light. If one LED lights, it denotes the port to which the subsequent display applies. If all numbered LEDs light, it denotes that the normal 3-port display mode is active.

The selected display remains active until manually changed or until RESET is pressed or until power up.

Table 4 - RS-232 LED Function Selection Sequence

RS-232 LED Function Selection Sequence	
ALL	} TX LED in RF group lights with any and all transmission
1	
2	
3	
4 (reserved)	
5 (reserved)	} TX LED in RF group only lights with an ACK or DATA transmission
ALL	
1	
2	
3	
4 (reserved)	
5 (reserved)	

- If, during the 2 seconds period that CK is not flashing, PF 1 is pressed a second time, the LED functions will advance one step from top to bottom through the available options in the order shown in Table 4.
- PF 1 may be pressed repeatedly during the 2 second period (extended with each press) to advance to the desired numbered LED function option.

Once the desired RS-232 LED function is selected, stop pressing PF1, allow the two-seconds timer to run down. The BDLC^{PD} returns to normal operation using the newly selected display.

3.2.1.2 LEDs and Indications

LEDs are used to indicate the operation status of the BDLC^{PD}. Although capable of displaying three colors, only the green and red colors are used for the BDLC^{PD}. They are grouped by their function:

- RF Group, displays radio channel status in green
- RS-232 Group, displays serial port status in green except the TX LED that also uses red
- ALARM Group, displays fault status in red

3.2.1.2.1 Radio Network Indicators

The Radio Network LEDs are useful when troubleshooting as an indication of network activity. It can help isolate transmission problems.

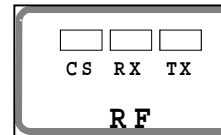

Figure 12 - RF indicators

- CS** Carrier Sense - Steady light indicates that an incoming radio data signal is being detected by the DSP modem. CS signal is not user-adjustable.
- RX** Receive Data – Flashing light indicates unit is internally receiving data from the radio network.
- TX** Transmitter ON – blinks green indicates (depending on display mode selected):
 - That a data packet or ACK (packet acknowledgment) is being transmitted.
 - That an idle packet, data packet or ACK is being sent. *Test transmission display is done in red.*

3.2.1.2.2 RS-232 Port Indicators

The RS-232 LEDs normally indicate port activity on the port selected. See section 3.2.1.1.2.3 above for instructions for selecting display mode.

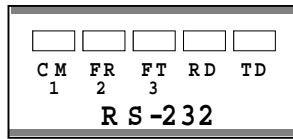

Figure 13 - RS-232 Port LED indicators

- CM** Command Mode - LED lights and remains lit while the selected port is accessing the Command Processor. It lights ON and OFF while being configured.
- FR** Flow Control on Receive - the BDLC^{PD} has received a flow control signal from the device connected to it. When it lights, BDLC^{PD} has stopped sending data to the DTE. When LED goes out, the port terminal is again ready to receive data.
- FT** Flow Control on Transmit - the BDLC^{PD} has sent a flow control signal to the DTE asking it to stop sending data. The LED remains lit as long as the terminal is being held off.
- RD** Receive Data - when lit, it shows that the Receive Data pin 3 on the RS-232 interface connector is active. Since all BDLC^{PD} are configured as DCE, it means that the DTE is receiving data from the BDLC^{PD}.
- TD** Transmit Data - shows the status of Transmit Data pin 2 of the RS-232 interface. When lit, the DTE is sending data to the BDLC^{PD}.

3.2.1.2.3 Check and Power

- CK** Check:
 - Normally flashing rapidly (about 6 cps), indicates microprocessors are working correctly and power is applied.
 - Not flashing indicates unit is not functioning.
 - Blinking slowly (1 cps), indicates the parameters contents of the flash memory have been corrupted. The unit automati-

cally loads its set of factory default parameters and starts beeping at 20 seconds intervals.

May also indicate DSP-modem re-initialization has occurred

3.2.1.2.4 Alarm Indicators

All alarm conditions will cause the BDLC^{PD} to light one or more of the LED indicators. LEDs remain ON when lit until cleared by either pressing PF 1 (without affecting operation of the unit) or RESET (cycling unit OFF and ON).

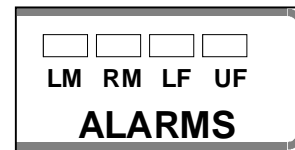

Figure 14 - ALARMS LED indicators

- LM** Local Minor Alarm - when lit, indicates the presence of any of the following minor faults:
 - Parity, framing or overrun error at any RS-232 port.
 - Out of buffers. No memory available to accept data from a local terminal device. Usually denotes a flow control problem.
 - Flash memory error. At power-up or reset, the unit detected a change in non-volatile memory.
- RM** Remote Minor Alarm - when lit, indicates any of the Local Minor Alarm listed above have taken place at the remote end of the link (i.e. the mobile the local base station is currently communicating with). It will also light when a protocol error has been detected on the network.

In a network using the “Host Link Active” (MSC) feature, the RM LED, flashing in-sync with the CK LED, indicates that the link is down.

LF Link Failure - when lit, indicates that the base station fails to receive an ACK for a packet sent and for all subsequent retries. Some data has possibly been lost. LF is not functional if all active ports are set to NAR mode.

Link fails are inevitable during normal operation (mobiles temporarily out of range, in a tunnel, parked in a dead spot, etc.). A lit LF LED is not normally cause for concern.

UF Unit Failure - when lit, the unit requires attention:

- The BDLC^{PD} is not operable;

It may indicate detection of a system software error trap.

- The BDLC^{PD} is operable;

Indicates that on power-up, invalid data was detected in the serial EEPROM chip (located in the radio modules). It may also indicate that connection to the radio modules is incorrect or that radio power is not applied.

The LM, RM and UF alarms also sound a beep when a fault occurs. The LF alarm is silent.

3.2.2 BDLC^{PD} Rear panel

Referring to Figure 4, the rear panel of the BDLC^{PD} has the following set of chassis connectors:

- Four DE-9F connectors:
 - DEV2 - usually connected to Dataradio's WinRIS program (DMP/Setup 19200). Can also be used with special user's application such as telephone modem. *Note: connection to a telephone requires the use of a DCE Cross-over cable.*
 - DEV3 - Dedicated (9600)
 - DEV4 and DEV5 - not used
- One DB-25F connector
 - DEV1 - Connects to user's application.
 - a) DMP 19200 for single-site installations
 - b) MSCP 19200 for multi-site installations

- One DA-15M connector:
 - DEV6 Digital I/O - not used
- One DB-25M connector:
 - EXT RADIO/TEST - connects to the Radio assembly (see Figure 15)

3.2.2.1 Signal Levels

In the description of data signals in Table 7, the following conventions are used:

Table 5 - RS-232 Signal levels

Term	Alternates	Signal level
ON	Asserted, spacing	+3 to +15 V
OFF	Dropped, marking	-3 to -15 V

3.2.2.2 Pin Functions

Table 6 - DTE Port 9-pin functions

DE-9 F pin #	Function (RS-232 signal levels)
1	DCD - from Paragon ^{PD} , normally asserted
2	RXD - data from Paragon ^{PD}
3	TXD - data to Paragon ^{PD}
4	DTR - to Paragon ^{PD} , handshaking
5	Ground
6	DSR - from Paragon ^{PD} , tied to VCC through current limiting resistor
7	RTS - to Paragon ^{PD} , handshaking
8	CTS - from Paragon ^{PD} , handshaking
9	Reserved

Table 7 - DTE Port 25-pin functions

DB-25F pin #	Function (RS-232 signal levels)
1 and 7	Ground
2	TXD - data to BDLC ^{PD}
3	RXD - data from BDLC ^{PD}
4	RTS - to BDLC ^{PD} , must be asserted
5	CTS - from BDLC ^{PD} , handshaking
6	DSR - from BDLC ^{PD} , always +8V
8	DCD - from BDLC ^{PD} , always asserted
9	RI - from BDLC ^{PD} , always -8V
20	DTR - to BDLC ^{PD} , handshaking

We recommend the use of shielded 9-wire or 25-wire cables with all pins connected.

Dataradio recommends the use of secure (i.e. password protected and/or dial-back) modems in any installation where dialup access is provided.

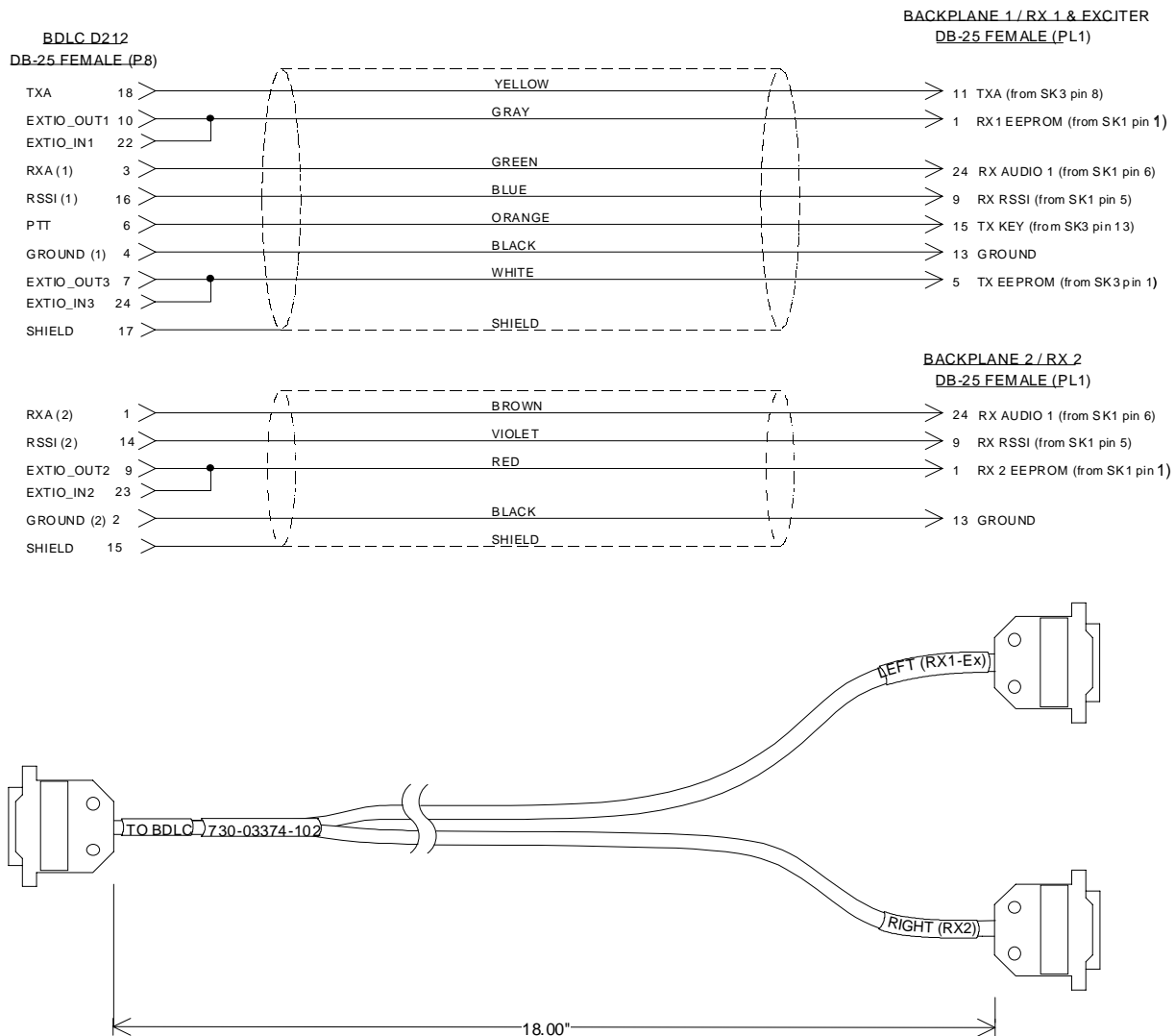

Figure 15 - BDLC^{PD} Y cable and pinout

Important note:

The aggregate total baud rate for all active ports on a BDLC^{PD} must not exceed 30,000 for Paragon^{PD}. Sustained simultaneous operation on devices 1 and 3, using the factory settings for these ports, may result in lost characters.

Using the factory settings, device 3 is intended only for use during configuration and should not be used simultaneously with data traffic on device 1. For special user application done while the BDLC^{PD} is active, use either device 2, or set device 3 to 2400 bauds.

4. WinRIS program

The Windows Radio Installation Software (WinRIS) program is used to:

- Check and troubleshoot Paragon^{PD}.
- Save an existing configuration.
- Upload files for field configuring of units (Requires intervention with technical support).

To run the program, you will need:

- A PC or portable computer running a 32-bit MS-Windows application:

Win ME
Win2000
Win NT
Win 9x

(For Win 95, if *COMCTL32.DLL* has been updated to the most recent version and copied to the `\windows\system\` directory).

Note:

WinRIS does not operate under:

- Win CE (embedded in PocketPC)
- 16-bit Windows 3.x
- A hard disk.
- An available COM port.
- A serial mouse, with its own driver installed is strongly recommend however most actions can also be done using keyboard command

4.1 Operation

This support program can be run in MS-Windows © mode.

DO NOT have more than one copy of this program loaded at any given time in separate windows. Doing so creates COM port sharing conflicts and failure to run the program alone results in unexpected transmissions.

Only left mouse button operation is supported.

Any command or selection shown in gray is either unavailable or is awaiting another action before activating.

Help in the program is available at all points by pressing the F1 key. If a subject is highlighted, the help displayed will be context sensitive.

4.2 To connect and start WinRIS

Gemini^{PD}'s and Paragon^{PD}'s share a common WinRIS program available on diskette, Datadio p/n 980 03392-00n.

Refer to the WinRIS Readme.txt file for details on how to set the MS-Windows environment, and how to connect, install and run this program.

In summary, before starting the WinRIS when running MS-Windows, click on "Start", then on "Run". Type the relevant path and variables on the command line (or select by browsing) leading to:

WinRIS.EXE COM[x], [speed],8,n,1

(where x is the PC COM port to be used) Of course, the executable command may be used alone without any variable added.

Click on "OK".

It is also possible to create a PC desktop shortcut icon for WinRIS:

- Start by right clicking anywhere on the desktop,
- Select New,
- Select Shortcut and type the path as detailed above directly on the command line (with or without variables).
- Click Next,
- Type in an applicable name for the shortcut icon,
- Click Next
- Select an icon (your choice) and
- Click on Finish.

Command line settings override the environment variable, if any.

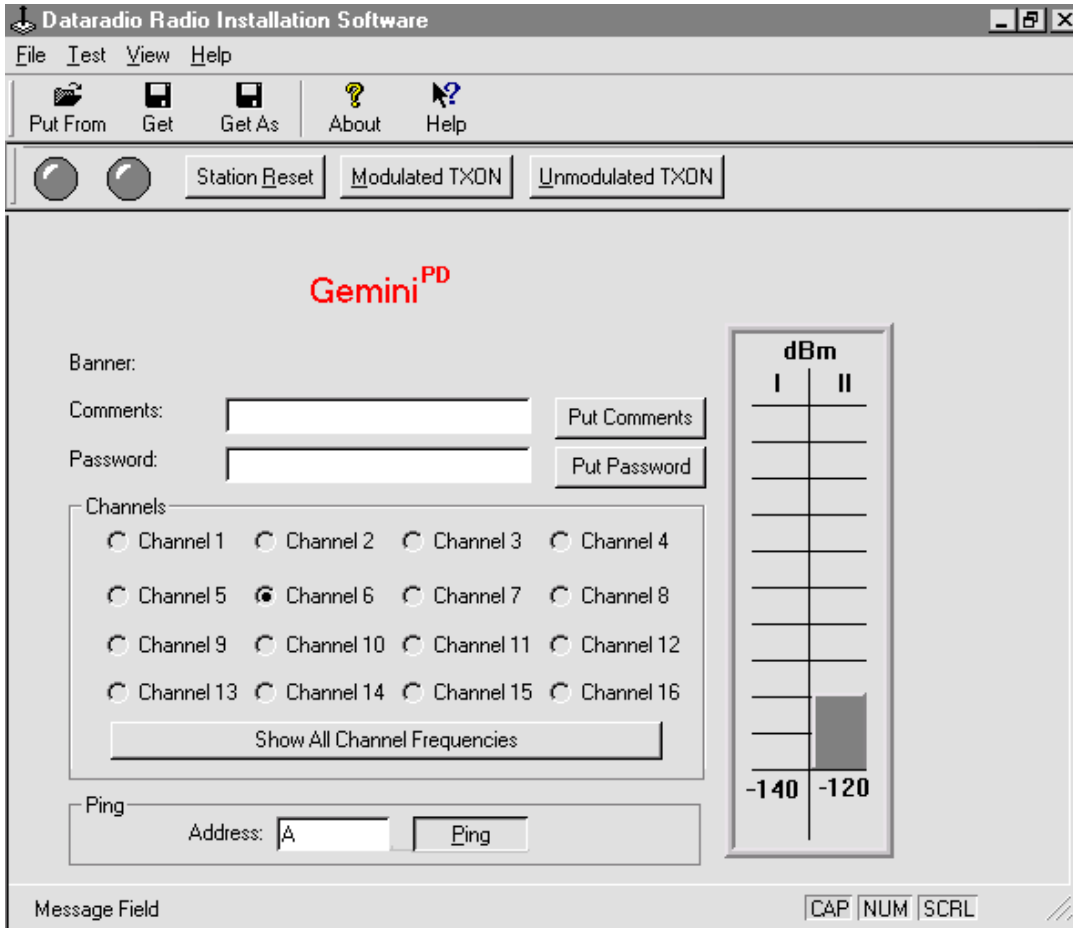

Figure 16 - WinRIS main screen

4.3 Window

This program uses one main display screen only. Placing the cursor over a Toolbar or Button generates a ScreenTip. Referring to

Figure 16, starting from top and moving down to the bottom, the screen display is made up of:

- A **Menu bar**, containing the menu names listed below. They give access to command options. Unavailable commands are shown in light gray color. **Shortcut keys** are listed whenever available.

File menu lists the:

- **Put From** command (Ctrl+O)
 - **Get** command (Ctrl+S)
 - **Get As** command
- and below a command separator, the:
- **Exit** command

- **Test** menu lists the:
 - **Modulated** command
 - **UnModulated** command
- **View** menu lists the:
 - **Toolbar** checked command
 - **Status bar** checked command
- **Help** menu lists the:
 - **Help Topics** command

and below a command separator, the:

 - **About WinRIS** command

- A **Toolbar** row, located immediately below the menu bar containing buttons (each

bearing an icon) for commonly used tasks as follows:

- **Put From** button
- **Get** button
Get As button
and to the right of a bar separator, the:
 - **About** button and the
 - Context-sensitive **Help** button
- An **Indicator and Button bar**, located immediately below the Toolbar row, it contains two circular indicators
 - **DSR signal is High** indicator
 - **CTS signal is High** indicator

and three buttons for commonly used tasks as follows.

- **Station Reset** button
- **Modulated TXON** button
- **Unmodulated TXON** button
- A **Product field**, displays product type being used after a connection to the product has been established. *Illustration used indicates a Gemini^{PD} product connection.*
- A **Data section**, containing the Banner plus the Comments and Password fields and their related Put buttons.
- A **Channel(s) section**, to select and activate a channel for Gemini^{PD} products. The “Channels” selection and the “Show All Channel Frequencies” button functions are disabled for Paragon^{PD} as it uses a single channel.
- A **Test section**, with a **Ping** button and the relevant address field.
- A **Status bar**, for displaying standard user-messages. Other messages appear in dialog window boxes or warning windows.
- The RSSI Bar Graph on the right side of the window is exclusive to Gemini^{PD} and is disabled when connected to Paragon^{PD}.

4.4 Functions

The WinRIS program is used to:

- Save an existing configuration from a unit to a file.
- Take a configuration from a file and upload it to a unit
- Check Paragon^{PD}'s transmit functions
- Test and/or trouble-shoot installations

4.4.1 “Station Reset” button

The **Station Reset** button is the only button available when first starting the program and is used to initiate the connection process.

- Press **Station Reset**.
- Enter **Port** and **Baud rate** information in the **Select Port** sub-window.

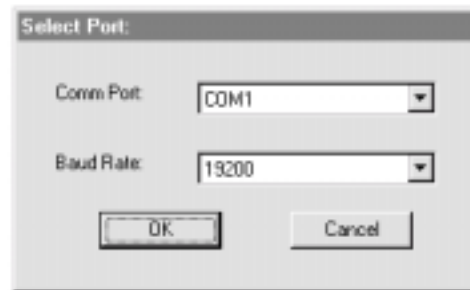

Figure 17 - “Select Port” dialog window

- Press OK to validate the selection (or Cancel to exit back to the main screen).
- When connection is established, all test buttons and fields valid for the product identified are activated.

The Station Reset button is also pressed as a last step after doing a “Put From”. The Station Reset button causes downloaded parameters from a file or diskette to take effect in the connected unit.

Pressing Station Reset is not required after doing any Comments or Password configuration change as these have their own Put Comments and Put Password buttons.

Station Reset does not break the connection.

4.4.2 Configuration to a file

Saving the unit’s configuration to a file allows the user to:

- Subsequently restore the configuration.
- Safeguard a copy as documentation of the configuration.

Note: The configuration and status files are ASCII files and may be e-mailed or faxed to technical support when requested to do so.

Warning:

Do not make any changes to these files. Any changes made to the configurations MUST be done at factory or by Dataradio system engineering.

4.4.2.1 “Get” button

On the menu bar, select “File”, then the “Get” command or press the “Get” button on the Toolbar to:

- Establish linking
- Download and automatically save the connected unit’s configuration setting to a file named with the unit’ serial number: The WinRIS status bar will then report “*All parameters are successfully retrieved and saved in file [unit’ s/n].BP2.* Any previous configuration in the program is overwritten.

If you do not wish to overwrite an existing configuration or prefer to name the file yourself, use the “Get As” button.

4.4.2.2 “Get As” button

After communication is established using the Connect button, press the Get As button to:

- Open the “File, Save As” window with the ASCII file *.bp2 (already selected). Save the connected BDLC^{PD}’s operating characteristics (configuration setting) to a file, directory or drive of your choice.
The program will ask before overwriting an existing file.
- Status bar reports “*All parameters are successfully retrieved and saved in [filename]*”.

4.4.3 Configuration from a File

Loading a configuration from a file to a unit is useful to:

- Restore the operating characteristics of a unit (Requires intervention with technical support.)
- Carry out field updates using Dataradio system engineering supplied diskette(s).

Warning:

Do not make any changes to these files. Any changes made to the configurations MUST be done at factory or by Dataradio system engineering.

4.4.3.1 “Put From” button

- 1- On the menu bar, select “File”, then the “Put From” command or press the “Put From” button on the Toolbar.
- 2- In the “Open” window, locate the drive, directory and file name of the relevant file.
 - This may be a configuration saved earlier from a unit.
 - It can also be from a Dataradio (factory or system engineering) diskette.
- 4- Select the appropriate file
- 5- Press the “OK” button.
The status bar reports: “[filename] is downloading into unit” and up to 30 seconds later displays: “All parameters are saved. Apply Station Reset to take effect!”
- 6- Press the “Station Reset” button. See section 4.4.1 for details.

4.4.4 Special Functions

The following WinRIS fields and buttons are used to gather specific information concerning the connected unit:

- **Banner** field
- **Comments** field and **Put Comments** button
- **Password** and **Put Password** button

4.4.4.1 Banner Field

This field displays a string made up of the serial number of the connected unit followed by the firmwares used and their version number.

Format is:

[serial number]:firmware 1 name, its version #, firmware 2 name, its version #.

The serial number portion uniquely identifies the unit. It is a variable length, maximum eight-character alphabetic string assigned at the time of manufacture. It is identical to the serial number printed on the label of the unit. This number cannot be changed and is used as part of the on-air protocol.

Paragon^{PD}'s firmwares reside in flash EPROM and are designed to allow field upgrades.

When contacting your supplier, give the full banner string and the version of the WinRIS used. You will find the version number by selecting the "Help" menu option, then "About WinRIS" command or pressing the "About" button on the Toolbar.

The "Banner" field is blank prior to doing a "Get", "Get As" or "Put From".

4.4.4.2 Comments

- 1- Type comments directly in the "Comments" field. These can be text up to 24 characters. Use this field to enter user-convenient description(s) (customer name, location, etc...).
- 2- Press the button "Put Comments" to make the entry permanent. This field may be left blank.

On subsequent "Get", "Get As" or "Put From", this field displays entered comments. If no comment was entered, the field will remain blank.

4.4.4.3 Password

The password feature is useful where two (or more) fleets share the same radio channel. Mobiles without the proper password would still

receive the message but the contents would not be intelligible.

- 1- Type your password directly in the "Password" field. It is a string of 32 hexadecimal characters (exactly).
- 2- Press the button "Put Password" to make the entry permanent. This field may be left blank.

On subsequent "Get", "Get As" or "Put From", this field displays entered comments. If no comment was entered, the field will remain blank.

Password information is NOT retrieved and saved to a file, along with the configuration.

Clearing a Password is done by entering 32 zeros.

The Dataradio supplied password algorithm is designed to thwart the casual observer only. It provides a limited form of data privacy. Therefore, if your security requirements are high, Dataradio urges you to use external encryption technology such as Data Encryption Standard (DES) in the Host and Mobiles computers.

4.4.5 Test Functions

The following WinRIS functions and buttons are used to carry out testing or trouble-shooting on a connected unit:

- DSR signal is High indicator
- CTS signal is High indicator
- TXON (Modulated)
- TXON (Unmodulated)
- Ping Address and Ping button

While a button is in-use for test transmissions, all others are inoperative.

4.4.5.1 DSR signal is High indicator

The "Data Set Ready" (DSR) indicator light, located on the button bar (leftmost), is an RS-232 protocol port indication. When lit, it indicates proper connection and that the value is

High. The DMP protocol used requires that DSR be normally asserted.

4.4.5.2 CTS signal is High indicator

The “Clear-to-Send” (CTS) indicator light, located on the button bar (second indicator from the left), is an RS-232 protocol port indication. When lit, it indicates proper connection and that the value is High. The DMP protocol used requires that CTS be normally asserted.

4.4.5.3 Channel Selection

Paragon^{PD} uses its default radio channel. No channel selection being available, all channels are grayed-out and the “Show All Channel Frequencies” button is disabled.

4.4.5.4 TXON Tests

TXON test functions are selected by choosing “Test” from the file menu, then “Modulated” or “UnModulated” command or by pressing the relevant button on the Toolbar.

4.4.5.4.1 Unmodulated Carrier

Unmodulated carrier gives a clear carrier and is frequently used for checking:

- Frequency error
- Forward and reverse power

Press the TXON (Unmodulated) button to transmit an unmodulated 20-seconds test signal on the channel selected or until the button is pressed again.

The functions of all the other buttons are inoperative during test transmissions.

Power check:

- 1- Connect an in-line power meter between the radio and the antenna.

Measure the forward (nominal 40W for UHF model and 35W for 800MHz model) and reflected power levels by powering TX ON (<5% of forward power or as specified by System Eng.).

4.4.5.4.2 Modulated Carrier

Test transmission generates a carrier modulated with 1kHz sinewave, at deviation level that de-

pends on model and network speed as shown in Table 8.

This function is frequently used for checking frequency deviation.

Press the TXON (Modulated) button to begin transmitting a 20-seconds modulated test signal on the channel or until the button is pressed again.

The functions of all the other buttons are inoperative during test transmissions.

Table 8 – Carrier deviations for Tone or Data Modulation

Network Speed (b/s)		Carrier Modulation	
		Tone	Data
		Typical deviation in kHz TX test tone in ()	Absolute Maximum deviation * in kHz
SRRC4FSK	25kHz Channel Spacing (800MHz)		
	25600	± 3.7 (1000 Hz)	± 5.7
	19200	± 4.3 (1000 Hz)	± 6.2
	12.5kHz Channel Spacing (800MHz)		
	16000	± 2.4 (1000 Hz)	± 3.5
	14400	± 2.8 (1000 Hz)	± 4.0
	Full Channel (UHF)		
	25600	±4.0 (1000 Hz)	±6.0
	19200	±4.5 (1000 Hz)	±6.5
	Half Channel (UHF)		
16000	±1.6 (1000 Hz)	±2.4	
14400	±2.0 (1000 Hz)	±2.9	
DGFSK	Full Channel		
	19200	± 4.0 (1000 Hz)	± 4.7
	16000	± 4.0 (1000 Hz)	± 4.7
	9600	± 3.0 (1000 Hz)	± 3.6
	Half Channel		
9600	± 2.5 (1000 Hz)	± 2.9	

* Deviation shown may seem higher than normal, however they fall within the following appropriate FCC's masks limits: "C", "G", "D" or "H".

4.4.5.5 Ping Button

The Ping function checks connectivity by testing the ability of Paragon^{PD} to communicate with a mobile unit by sending a short transmission query and receiving a confirming response.

1- Specify the ping address

Addresses may be entered by typing directly in the “Ping Address” field in two ways:

- Numerically, the valid address range is 1-126.
- As an “Alpha-Mapped-Nibble” (AMN) address, consisting of upper case letters in the range A-P. The valid address range is A to GN.
- The base address is usually: 1.
- The program may display one of the following messages on the status bar:
 - For Paragon^{PD} product:
 - “Ping address is not in AMN or number format”
 - or
 - For Gemini^{PD} product:
 - “Ping address is not in the range A – GN”
 - In either case, check that the address entered is within the acceptable range, is of a valid format and correctly typed.

2- Press the Ping button to start ping testing. The time remaining to test transmit is displayed on the status bar.

3- The program sends a test query and continues transmitting pings at brief intervals.

As soon as a Ping test signal is returned from the address selected, the status bar displays:

- “Ping Successful” and pinging stops.
- If no ping signal is received after 60 seconds, ping testing stops and the status bar displays “Ping Failed”.

4.4.6 Status Bar

The Status Bar is located along the bottom edge of the WinRIS window. To display or hide the bar, check or uncheck the command in the “View” menu.

The left area of the status bar describes actions of menu items as you navigate using the directional arrows. This area also shows messages describing actions of toolbar buttons as you depress them, before releasing them. If after viewing the description of the toolbar button command you wish not to execute the command, then release the mouse button while the pointer is off the toolbar button.

Warning and Caution messages appear in pop-up sub-windows. To close these message boxes, press the ESC key.

Three boxes on the right of the status bar indicate which of the following keys is latched down:

Indicator	Description
CAP	The Caps Lock key is latched down.
NUM	The Num Lock key is latched down.
SCRL	The Scroll Lock key is latched down.

Table 9 - Key latch indications

5. Testing and Trouble-Shooting

The checks described below should be done at time of installation, annual intervals or whenever deterioration in performance is noted.

5.1 Equipment Required

- In-line watt meter (150W & 10 W ranges)
- Radio service monitor (IFR-120B with option 03: 30KHz IF filter or equivalent).
- RG-214 or RG-223 cable with N-Type male connector to connect ParagonPD to the service monitor.

Important note: Before proceeding make sure that the service monitor has been calibrated recently and has warmed up for at least the time specified by its manufacturer.

Some reported frequency and deviation problems have actually been erroneous indications from service monitors that have not adequately warmed up. This is particularly likely when field service is done during winter months.

5.2 Recommended Checks

- A) After an installation
1. LED Indications
 2. Save “unit config” to a file
 3. Transmitter Output Power
 4. Transmitter Reflected Power
 5. RF Link test between Paragon^{PD} and mobile unit(s)

- B) For annual maintenance & trouble-shooting

Same checks as A) plus:

6. Carrier Frequency Error
7. TX Deviation
8. Low Frequency Balance
9. 12 dB SINAD
10. Receiver distortion
11. RSSI check

Transmissions for some of the tests above are initiated by pressing the PF1 membrane button located on the front of the BDLC. For details on its use, refer to Table 3 and section 3.2.1.1.2.2 on page 13 above.

Table 10 - Checklist A (after installation)

CHECKLIST A (Paragon ^{PD}) Recommended Check out after Installation				
Step	ACTION	EXPECTED RESULTS at 25°C	MEASURE WITH	IF NOT?
1	Normal Power-up Sequence	BDLC ^{PD} beeps once, all LEDs come ON for about four seconds, the green LEDs then flash in a "ripple" pattern for close to two seconds. All LEDs go OFF except the CK that should flash 6 to 8 times per second. For functions, see section 3.2.1.2		
2	Connect and save unit config Press WinRIS Get button	as per section 4.4.2		
3	Transmitter Output Power Press TX (Unmod)	VHF/UHF: 100 watts 800 : 70 watts +10%, -10% Factory-settable down to 10 watts as per customer request.	Service monitor set to read power or 150W in-line wattmeter installed as close as possible to the unit antenna connector.	¹ Refer to Checklist B
4	Transmitter Reflected Power Press TXON (Unmod)	<5% of forward power or as specified by Syst. Eng.	10W in-line wattmeter	Check for bad connections, damaged coax cable, etc.
5	RF Link test "Ping" a mobile	"Ping Successful"	as per sections 4.4.5.5	- Mobile is out of range - Refer to factory technical support.

¹ (unless unit has been set a lower value). Note that readings less than 100 watts for VHF/UHF or 70 watts for 800 MHz models, may be due to losses in cables used for testing. Check also your wattmeter frequency calibration curve. Do not be too ready to condemn the transmitter or the RF feedline & antenna installation.

Table 11 - Checklist B (General)

CHECKLIST B (Paragon ^{PD}) General Check out (part1 of 2)				
Paragon ^{PD} units are set and characterized at the factory to optimize performances. It is not recommended to try readjusting units unless it is really required. Misadjusting a unit may result in significant performance losses.				
Step	ACTION	EXPECTED RESULTS at 25°C	MEASURE WITH	IF NOT?
1	Normal Power-up Sequence	BDLC ^{PD} beeps once, all LEDs come ON for about four seconds, the green LEDs then flash in a "ripple" pattern for close to two seconds. All LEDs go OFF except the CK that should flash 6 to 8 times per second. For functions, see section 3.2.1.2		
2	Connect and save unit config Press WinRIS Get button		as per section 4.4.2	
3	Transmitter Output Power Press TX ON (Unmod)	VHF/UHF: 100 watts 800: 70 watts +10%, -10% Factory-settable down to 10 watts as per customer request.	Service monitor set to read power or 150W in-line wattmeter installed as close as possible to the unit antenna connector.	Adjust "Power" on the front panel of the "Power Amp" (see Figure 8)
4	Transmitter Reflected Power Press TXON (Unmod)	<5% of forward power or as specified by Syst. Eng.	10 W in-line wattmeter	Check for bad connections, damaged coax cable, etc.
5	Carrier Frequency Error Press TX (Unmod)	< ±300 Hz	Service monitor set to read frequency error	Adjust TCXO (see inside Exciter module) Figure 22 & Figure 35
6	TX Deviation Press TXON (Modulated) Carrier will be modulated with a 1 kHz tone.	SRRC4FSK modulation, 25kHz Ch. spacing (800): 25.6 kb/s: ±3.7 kHz 19.2 kb/s ±4.3 kHz 12.5kHz Ch. spacing (800): 16.0 kb/s ±2.4 kHz 14.4 kb/s ±2.8 kHz Full Channel (UHF): 25.6 kb/s: ±4.0 kHz 19.2 kb/s: ±4.5 kHz Half Channel (UHF): 16.0 kb/s ±1.6 kHz 14.4 kb/s ±2.0 kHz ----- DGFSK modulation, Full Channel 19.2 and 16 kb/s: ±4.0 kHz 9.6 kb/s: ±3.0 kHz Half Channel 9.6 kb/s: ±2.5 kHz Tolerance is +5%, -10% for all bit rates.	Service monitor set to read deviation (IF filter set to Mid or 30 kHz position)	Adjust according to Appendix 1 - ParagonPD Deviation adjust on page 57
7	Low Frequency Balance Initiate a TX Random data test via BDLC ^{PD} 's PF1 (See Table 3)	a) Record deviation level read from step 6 b) Record deviation read from TX Random test c) Difference between a) and b) must be: < 500 Hz (2 FSK) < 1.8 kHz (4 FSK)	Service monitor set to read deviation (IF filter set to Mid or 30 kHz position, all audio filtering disabled)	Refer to Section 6.2.3.4 for Series I and section 6.4.3.4 for Series II

CHECKLIST B (Paragon ^{PD})				
General Check out (part2 of 2)				
<p>Paragon^{PD} units are set and characterized at the factory to optimize performances. It is not recommended to try readjusting units unless it is really required. Misadjusting unit may result in significant performance losses.</p>				
Step	ACTION	EXPECTED RESULTS at 25°C	MEASURE WITH	IF NOT?
Set the service monitor to generate on the selected receive frequency. Verify alternately for both receivers. The carrier should be modulated with a 1.0 kHz tone at deviation level specified below:				
8	<p>12 dB SINAD (Dataradio wide band measurement method: no audio filtering)</p> <ul style="list-style-type: none"> - For Full channel unit, set deviation to ±3 kHz. - For Half channel unit, set deviation to ±1.5 kHz 	Better than -110 dBm (including cable loss)	<ul style="list-style-type: none"> - Backplane corresponding to the receiver being verified: SK1, Pin 6 (see Figure 30) - Service monitor (IFR) set to SINAD - IFR IF filter set to MID position or 30 kHz wide filter. 	Refer to section 6.2.2 for Series I and to section 6.4.2 below for Series II
9	<p>Receiver distortion (Dataradio wide band measurement method: no audio filtering)</p> <ul style="list-style-type: none"> - Set service monitor RF Gen output to -70 dBm - <i>Deviation level as per SINAD above.</i> 	≤ 5.5 %	<ul style="list-style-type: none"> - Backplane corresponding to the receiver being verified: SK1, Pin 6 (see Figure 30) - Service monitor (IFR) set to SINAD - IFR IF filter set to MID position or 30 kHz wide filter. 	Refer to section 6.2.2 for Series I and to section 6.4.2 below for Series II
10	<p>RSSI Vary & measure the RF level output as shown in sections 6.2.2.5 and 6.4.2.5.</p>	<p>UHF & 800 MHz: at -110dBm: 1.2 VDC (+0.2V -0.45 VDC) at -90dBm: 4.0 VDC (±0.20VDC) at -80dBm: 5.0 VDC (+0.20 -0.35VDC)</p> <p>VHF: at -120dBm: 3VDC (+0.2V -0.45 VDC) at -105dBm: 4VDC (±0.20VDC) At -90dBm: 5VDC (+0.2V -0.25 VDC)</p>	<ul style="list-style-type: none"> - Backplane corresponding to the receiver being verified: SK1, Pin 5 (see Figure 30) - DC Voltmeter measurement 	Refer to section 6.2.2.5 for Series I and to sections 6.4.2.5 or 6.4.2.6 for Series II

6. Radio Programming and Adjustments

All receiver procedures detailed in this section should be done twice: once for the “Main” (or RX1) receiver module and a second time for the “Auxiliary” (or RX2) receiver module. Connect to the relevant module and its corresponding backplane PCB as required.

Both Series of Paragon^{PD} radio module assemblies share the same backplane PCBs. Refer to section 3.1.2.1 for details. Programming for Series I is done via EPROMs while Series II uses of the RJ11 connector present on the front of the Speaker panel and mirrored on both backplane boards (see section 6.3 below).

6.1 Series I 800MHz Radio Programming

This procedure describes the steps needed to program the Paragon^{PD}'s Tait T800 Series I radio (half & full channel) used in all Paragon^{PD} 800 MHz versions. This procedure is a supplement to the Tait programming procedure.

6.1.1 Recommended Items

T800win programming kit for Series I:

- PGM800Win programming software user's manual
- PGM800Win Windows based programming software
- EPROM Programmer BP MicroSystems's model CP-1128 (suggested model)
- EPROM Programmer software BP MicroSystems's (Version 3.08 or later)
- 27C64 EPROM (150 nanoseconds or faster)
- 486 PC or better, Ms-Windows 3.1 © or later
- Standard 25-pin parallel cable (terminated Male/Female)

6.1.2 Introduction

Before starting programming, have a PC running MS-Windows and the Tait PGM800Win software for Series I Base station. It will be needed to generate a binary file required in programming the EPROM.

This program supports the use of a mouse but may be used without one if required. Keyboard access follows the conventional MS-Windows © method as briefly described below:

- Press and hold the “Alt” key while pressing the relevant hotkey (indicated by an underlined letter on the menu command).
- On a drop-down menu, press only the hotkey letter without pressing the “Alt” key.
- Use the “Tab” key to cycle available fields and the “Enter” key to validate entries. *E.g. Pressing “Alt”+F opens the File drop-down menu and pressing “A” opens the Save As directory service box.*

For full description of the programming procedure, refer to the T800 Programming Software User's Manual.

- Receiver VCO and front-end alignment will be required when new receiver frequency is programmed outside the radio tuning range: ± 3 MHz from previous center frequency.
- Exciter alignment will be required when new transmitter frequency is programmed outside the radio tuning range: ± 4 MHz from previous center frequency.

6.1.3 File Creation

1. In WIN 3.x: Start by clicking on File, then on Run, type the path or browse to select the Tait program, click OK to run PGM800Win executable program.
In WIN 9x: click on Start, then on Run, type the path or browse to select, click OK to run PGM800Win.
2. In the Tait program's Menu bar, click on "View". On the drop-down menu, make sure that a check mark is present in front of the "T800 EPROM" option. If not, click this option to activate it and click on "View" again to verify that a check mark is now present.
3. Select File, New and choose the relevant unit model to program. Click on OK. The program displays a dual-tabbed virtual file folder.
4. Click the System Information tab; enter the unit's serial number in the relevant field. In the *User Remarks* field, you may enter user comments as required (up to 16 characters). Use as a notepad (customer name, location, technical info etc...). Refer to Figure 18.

Click the Channel Information tab; click the relevant frequency field to make it active and type in the required channel number in the frequency field. Refer to Figure 19

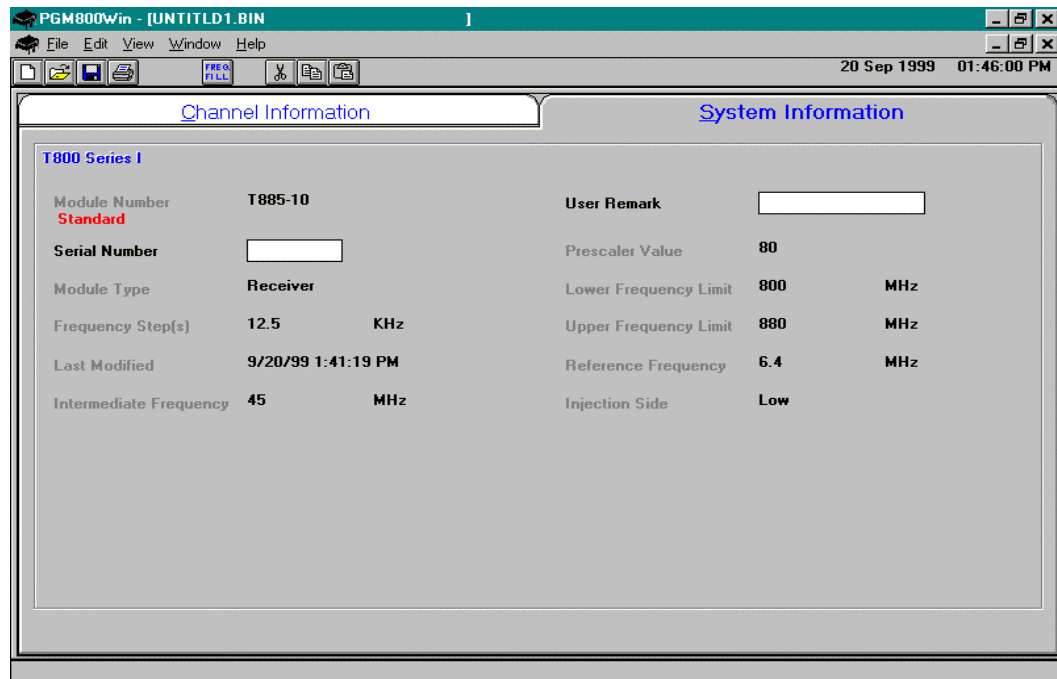

Figure 18 - Series I Receiver System Information

Warning:

DO NOT enter anything in the CTCSS fields. If there is already something in any of those fields, erase their content(s). The indication should be 00.0

5. Select File, Save As. Enter an appropriate name in the "Filename" field. Always use the suffix .bin for these binary files. Choose the relevant drive and directory to save under and click on OK.
6. Repeat file creation procedure for the Exciter, the main receiver and for the diversity receiver modules as required.

7. Select File, Exit to leave the program.

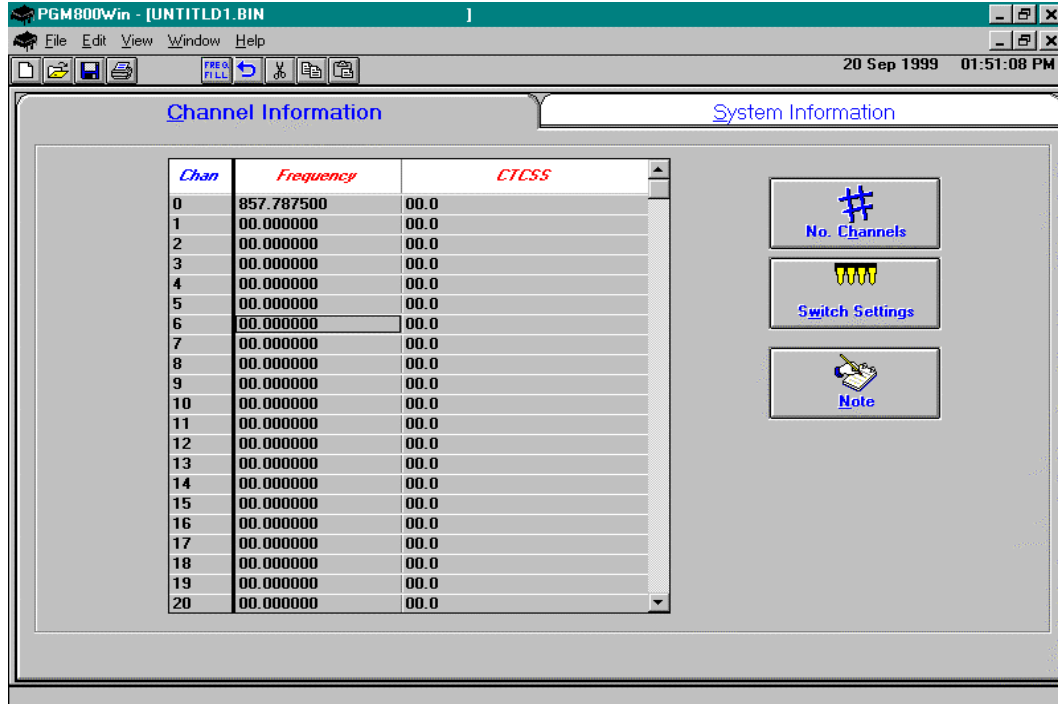

Figure 19 - Series I Channel Information

6.1.4 Programming the EPROM

Connect a straight 25-pin ribbon parallel cable between the PC's LPT1 port and the EPROM programmer. Apply power to it.

At the DOS prompt, type bp.exe to open the EPROM program software.

Paragon^{PD} uses three 27C64 EPROMs (150 nanoseconds or faster) in the Exciter and Receivers modules. Repeat the following procedure for each EPROM as needed.

Carefully grasp between thumb and index the 27C64 EPROM chip to be tested and gently insert it with a rocking motion in the EPROM Programmer socket until well seated.

Navigate the programmer's screen using the keyboard directional arrows. The left and right keys move through the available options and the up and down arrows select the function.

1. Move to and select "Buffer"
2. In the sub-menu, move to and select "Load"
3. Press ENTER
4. In the opened box, type in the directory path where the file created in paragraph 6.1.3 above is located. In the list of filenames, move to the appropriate file and press ENTER once to complete the selection and press ENTER a second time to load the file. This closes the directory service box. The message "Load successful" displays until directional arrows are pressed again.
5. Move to and choose "Select"
6. Press ENTER

7. A selection box opens, in the “Device Selector:” field, type M27C64A. Move to and choose the brand of EPROM. Press ENTER to close the selection box. The program is now ready to configure the EPROM and the name of the device is displayed at the bottom of the screen.
8. Move to and select “Device”
9. In the now opened sub-menu, move to and select “Program”.
10. Press ENTER. The program loads the binary file into the EPROM (approximately fifteen seconds). The message “Function complete” displays until directional arrows are pressed again. *
11. Move to and select “Buffer”
12. In the now opened sub-menu, move to and select “Clear”
13. Press ENTER. The program displays at the bottom of the screen: “All buffers cleared”
14. Press ENTER
15. Move to and select “Quit”
16. Press ENTER
17. Remove configured EPROM from the EPROM Programmer

* If an “Error” message (and warning beep) appears during the procedure, it normally indicates improper erasure of the EPROM. Replace it with a fresh one and start from the beginning. The removed EPROM will need to be cycled through an EPROM eraser.

6.1.5 EPROM Installation

Warning

Always use a grounding strap and wear an anti-static bracelet when working with sensitive circuitry or components susceptible to static discharge or transients damage.

1. Remove power to the radio
2. Unscrew #1 Pozidriv screw on the front panel to slide out the module.
3. Unscrew the fourteen #2 Pozidriv screws on the handle side and remove cover.
4. Using a small flat-bladed screwdriver, carefully slide the blade between the EPROM socket and the chip (IC1) itself. Gently pry the chip away from its base and remove. The removed EPROM will need to be cycled through an EPROM eraser. Refer to Figure 21 on page 39.
5. Install the appropriate EPROM by carefully grasping the chip between thumb and index and gently inserting it with a rocking motion in its socket until well seated.
6. Select the channel configured in the EPROM as detailed in the next section.

6.1.6 Channel Selection via DIP Switches

Channel selection is done via DIP switches inside each module.

Example: To select channel 5, the DIP switch settings are as shown in Figure 20 below.

Notes:

- For channel 1 (one), switch #1 must be OFF and switches #2 through #7 must be ON.
- Always have switch #8 set to OFF.

- The EPROM and DIP switches locations are identical in both receiver and exciter modules (refer to Figure 21 and to Figure 22).

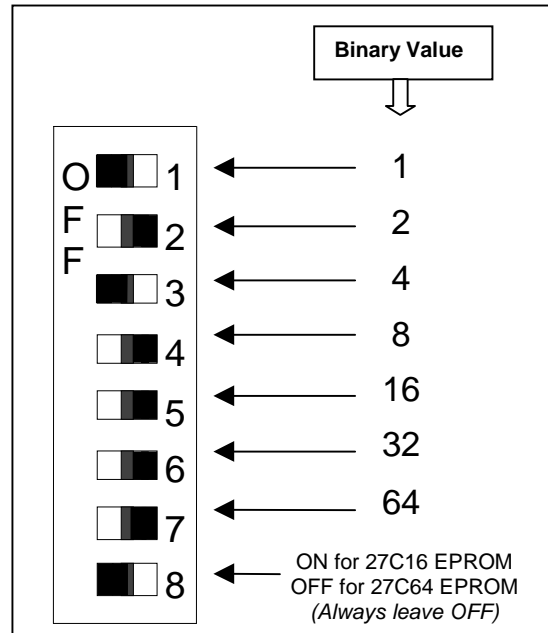

Figure 20 - Channel Selection via internal DIP switches

6.2 Series I 800MHz Radio Tuning

This section covers some basic tuning and verification for the 800 MHz Series I base station modules.

Note: Usually, this section is not done unless called for in section 6.1 “Series I - Radio Programming” or in Table 11 “Checklist B”.

6.2.1 Test Equipment

You will need the following test equipment:

- Digital multimeter and probes (e.g. Fluke 77)
- Digital or analog calibrated Oscilloscope (X1, X2 selectable)
- Calibrated COM-120B (with .001ppm TCXO and 30kHz IF options)
- 3 feet long double shielded N-M to BNC-M cable (RG-214 or RG-223)
- 2x 'BNC' to 'N' type adapters (e.g. Amphenol, Greenpar).
- Bird RF power meter with 150W / 50 ohm dummy load (optional)
- 1x Torx screwdriver #10
- Pozidriv screwdriver #1 & #2
- 1x six-inch adjustable wrench
- RF tuning/trimming tools.
- Extender Rail Kit for Series II chassis (T800-13-0000)
- 1x 6" coax cable N-M to BNC-M (provided with Paragon^{PD} to connect the exciter and PA)

6.2.2 Receiver Module (T885)

Note 1: Refer to Figure 21, page 39 for locating tuning controls

Note 2: When the synthesizer is unlocked, the front panel green LED called "Supply" will be flashing showing that it needs to be re-tuned.

6.2.2.1 Initial Setup

This initial setup will be used during each receiver alignment procedures that follow:

1. Remove the receiver (T885) module from the Paragon^{PD} rack frame
2. Remove the receiver top cover (nearest the handle).
3. Connect the ParagonPD Extender Rail kit between the RX module and the empty chassis receiver slot.
4. Set the multimeter to read DC Volts.
5. Apply power to the Paragon^{PD}.

6.2.2.2 Synthesizer Alignment

Single channel: Connect the multimeter to the long lead of L1 in the VCO (this measures the synthesizer loop voltage). Tune VCO trimmer C6 for a synthesizer loop voltage of 7V (working range is between 3V to 10V).

Multiple channels: Select the middle channel via the EPROM PCB DIP switch.

Adjust the VCO loop to 7V.

All channels should lie within the upper and lower limits of 10V and 3V respectively.

6.2.2.3 Front-End Alignment

- 1) IFR COM120B settings:
 - a) Connect a 3 feet long double shielded cable (N-M to BNC-M) between the IFR T/R output and the receiver antenna connector.
 - b) Select the generator mode (GEN button) and set to the main receiver channel frequency
 - c) Select and turnon GEN2
 - d) Set the FM Deviation to $\pm 3\text{kHz}$ (full channel) or $\pm 1.5\text{kHz}$ (half channel) using 1 kHz sine
 - e) Select SINAD meter
- 2) Monitor the SINAD by connecting an X1 scope probe to the Demod O/P test point (close to PL103 in the first section from the module front panel) or on the relevant backplane board at SK1 pin 6 (see Figure 30 for test point location).
- 3) Adjust the helical resonators #H1 to #H3 for best SINAD.
- 4) Continually decrease the RF level to reach 12dB SINAD, then re-do steps 3) and 4) again. (minimum requirement to reach is 12 dB SINAD for -110 dBm)
- 5) Perform the SINAD linearity tests described in the next paragraphs below. If it fails to pass the requirement, contact your Dataradio technical support.

WARNING: Do not attempt to re-tune the IF stages (i.e. L312 to L318).
These adjustments do not need to be re-adjusted after frequency re-programming. Touching these coils will have a direct impact on the DSP modem coefficient settings and may significantly reduce the radio performances over data.

6.2.2.4 SINAD and Linearity Check

1. Apply the following settings to the IFR:
 - Generator mode, Output T/R
 - IFR TX frequency to match the main radio RX frequency
 - Filter set to wide band (no audio filter)
 - Select Gen2 (Modulating tone fixed to 1KHz). All other Gen must be off, except for “wideband”.
 - Set deviation to $\pm 3.0\text{KHz}$ for full channel or $\pm 1.5\text{KHz}$ for half channel radios.
2. Lower the RF level to get a 12dB SINAD reading. Level must be better than **-110dBm** (including cable loss).
3. Offset the IFR TX frequency 2KHz (full channel) or 1kHz (half channel) *above* the main radio RX frequency, record the SINAD reading. It should remain within 1.5dB from the on frequency SINAD reading.
4. Offset the IFR TX frequency 2KHz (full channel) or 1kHz (half channel) *below* the main radio RX frequency, record the SINAD reading. It should remain within 1.5dB from the on-frequency SINAD reading.

Note:

If one of the above requirements is not met, try to re-tune the front-end. If it is still “failed”, contact your Dataradio technical support.

6.2.2.5 RSSI Adjustment

1. Apply an on-channel signal from the RF generator at a level of -110dBm modulated by a 1 kHz tone at a deviation of $\pm 3\text{kHz}$ (full channel) or $\pm 1.5\text{kHz}$ (half channel).
2. Adjust RV301 (RSSI level) to give 2.0V RSSI output when measured with a multimeter at SK301 pin 2 or on the relevant backplane board at SK1 pin 5 (see Figure 30 for test point location).
3. Vary the RF level and check the RSSI output voltage (Figure 28):
 - 1) At -120 dBm: 1.2 VDC (+0.20 -0.45VDC)
 - 2) At -90 dBm: 4.0 VDC (+0.20 -0.20 VDC)
 - 3) At -80dBm: 5.0 VDC (+0.20 - 0.35VDC)

If the requirement cannot be reached, contact your Dataradio technical support.

6.2.3 Exciter Module (T881)

Note 1: Refer to Figure 22 on page 40 for locating tuning controls.

Note 2: When the synthesizer is unlocked, the front panel green LED called "Supply" will be flashing showing that it needs to be re-tuned.

6.2.3.1 Initial Setup

1. Shut down power to the base station
2. Prepare the multimeter to read DC Volts.
3. Remove the exciter (T881) module from the base station rack frame
4. Remove the exciter top cover (nearest the handle).
5. Connect the Paragon^{PD} Extender Rail kit between the exciter module and the empty chassis exciter slot.
6. Connect a 3 feet long double shielded cable (N-M to BNC-M) between the IFR T/R output and the exciter antenna connector.
7. Apply power to the base station

6.2.3.2 Synthesizer Alignment

Single channel: Connect the multimeter to the long lead of L1 in the VCO (this measures the synthesizer loop voltage). Tune VCO trimmer C6 for a synthesizer loop voltage of 7VDC.

Multiple channels: Adjust the VCO loop to 7V using the middle frequency channel. All channels should lie within the upper and lower limits of 10V and 3V respectively.

Note: Normally, the fast TX key option is installed and the synthesizer is always energized.

Where that option was not fitted, key the transmitter by pressing the front panel Carrier button to make the above adjustment possible.

6.2.3.3 TX Frequency Error Adjustment

1. Apply the following settings to the IFR:
 - Receiver mode
 - IFR RX frequency to match the main radio TX frequency
 - IF Filter (BW) set to 30KHz
 - Zoom the RF Error window: select 10Khz range
2. Key the transmitter by pressing the front panel TX-key button and measure the carrier output frequency. It should be within ± 300 Hz. If it is not, adjust the TCXO to trim to meet the requirement, preferably within 100Hz.

6.2.3.4 Low Frequency Balance Adjustment

1. Apply the following settings to the IFR:
 - Receiver mode and Oscilloscope display (Source: Demod Out Connector).
 - IFR RX frequency to match the radio transmit frequency
 - IF Filter set to 30KHz
 - Zoom the Deviation window: select 10kHz Range and DC coupling.
2. Select the active or, the lowest (in the case of multi-channel base) frequency channel (via dip switch)
3. Transmit a square wave by pressing the BDLC^{PD}'s PF1 button and following the procedure outlined in section 3.2.1.1.2.2. Adjust RV-105 (REF MOD) close to the microphone connector, for best wave shape; no damping, no overshoot. Record the deviation read.
4. If transmission has not ended by itself, press PF1 again to stop it. For single-channel unit, proceed to step 8.
5. For multi-channel unit, select the highest frequency channel. Transmit a square wave by pressing the BDLC^{PD}'s PF1 button and following the procedure outlined in section 3.2.1.1.2.2. Record deviation again.
6. The difference in deviation between the two channels should be less than ± 300 Hz. If not, re-adjust RV105 to "average" the square wave shape on both channels until the spec is met.
7. To confirm the adjustment, select the active, or the lowest frequency channel. Compare the deviation produced between:
 - 1000 Hz sine wave adjust tone and
 - Random dataThe difference should be lower than 300 Hz. For multi-channel unit, repeat this step on the highest frequency channel.
8. Select the active channel. Transmit a TX ON (Modulated) adjustment tone by pressing the BDLC^{PD}'s PF1 button and following the procedure outlined in section 3.2.1.1.2.2. Make sure that deviation level read on the IFR correspond to model and bit rate in use (see Table 8 – Carrier deviations for Tone or Data Modulation). Re-adjust deviation as necessary referring to Checklist B - page 27.

6.2.3.5 Exciter Power Output

1. Apply the following settings to the IFR:
 - Receiver mode, Output T/R
 - IFR RX frequency to match the main radio TX frequency
 - IF Filter set to 30KHz
 - Select auto range in the *Power reading* window
 - Connect the coaxial cable from the IFR T/R to the Exciter output connector
2. Key the Exciter by pressing the module PTT button. The output power must be:
 - 800MHz (T881) = 4W \pm 300mW.
3. If 4Watts is not reached, adjust helical #L300 for maximum power output (which should be at least 7W); adjust RV356 down to 4W.

6.2.4 Power Amplifier Module (T889)

1. Re-install the exciter module into the Paragon rack frame
2. Connect the Exciter module to the Power Amplifier
3. Connect the Power Amplifier output to the IFR T/R connector or to a stand-alone BIRD style power meter, terminated with a 150W dummy load.

6.2.4.1 Power Amplifier Power Out

1. Set RV63 (Power adjustment, access on the front panel) fully clockwise.
2. Key the transmitter from the exciter Carrier button. The power output should exceed 90W.
3. Adjust RV69 (Driver power, access from the left end side) until the output power drops to 90W.
4. Adjust RV63 (Power) to reduce power output to its nominal value (70W) or lower as required.
5. Cable loss should be included in the reading.

6.2.4.2 Forward Power Alarm Level

1. Power up the T889 and adjust RV63 (Power) so that the output power is at the alarm level required, usually 20% lower than nominal value (e.g. 40W if the PA normally operates at 50W).
2. Adjust RV48 (Forward power Alarm set) so that the forward power alarm LED lights.
3. Adjust RV63 (Power) for the normal operating power level.

6.2.4.3 Reverse Power Alarm Level (Optional)

1. Power up the T889 and adjust RV63 (Power) for the normal operating power level.
2. Place a known mismatch of the required value (e.g. 3:1 VSWR) and adjust RV52 (reverse power alarm set) so that the reverse power alarm LED lights.

Example: A VSWR of 3:1 can be simulated by connecting an undetermined 3 dB pad to the PA output. This will result in a loss of 6 dB.

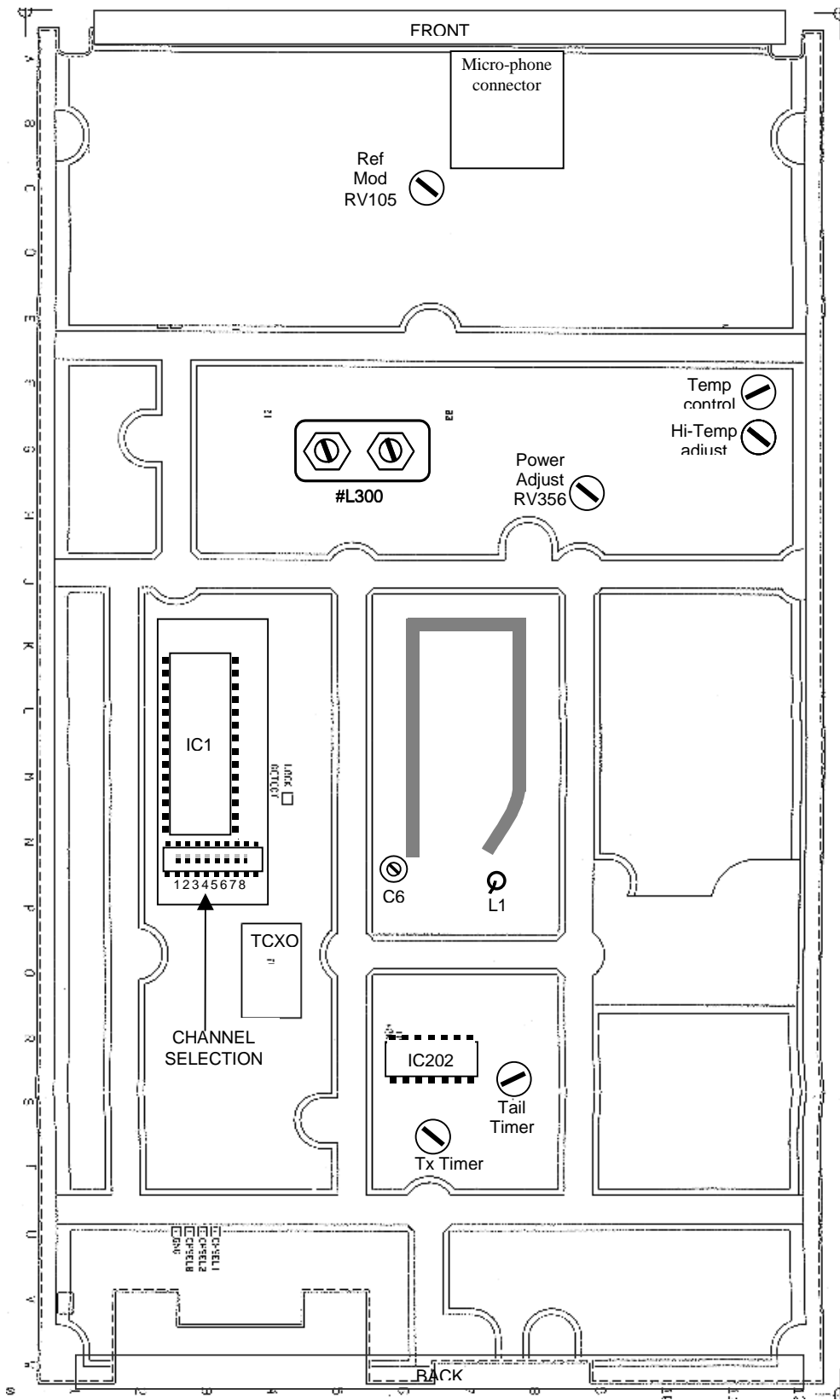

Figure 22 - T881 Exciter tuning controls location

6.3 Series II Radio Programming

This procedure describes the steps needed to program the UHF & VHF model that uses the Paragon^{PD} base station radios (half & full channels).

6.3.1 Recommended Items

- 486 PC or better, MS-Windows 3.1 © or later
- T800win programming kit for Series II:
 - PGM800Win programming software user's manual
 - PGM800Win Windows based programming software
 - T800-01-0002 programming cable (DB-25 to RJ-45 cable)
- Standard 25-pin parallel cable (terminated Male/Female)

6.3.2 Module Programming

Before starting programming, have a PC running MS-Windows © and the Tait PGM800Win software for Series II Base station.

This program supports the use of a mouse but may be used without one if required. Keyboard access follows the conventional MS-Windows © method as briefly described below:

- Press and hold the “Alt” key while pressing at the same time the relevant hotkey as indicated by an underlined letter on the menu command.
- On a drop-down menu, press only the hotkey without pressing the “Alt” key.
- Use the “Tab” key to cycle available fields and the “Enter” key to validate entries. *E.g. Pressing “Alt”+F opens the File drop-down menu and pressing “A” opens the Save As directory service box.*

Receiver VCO and front-end alignment will be required when new receiver frequency is programmed outside the radio tuning range:

UHF = ± 2.5 MHz from previous center frequency.

VHF = ± 1.5 MHz from previous center frequency.

Exciter and PA alignment will be required when new transmitter frequency is programmed outside the radio tuning range:

VHF & UHF = ± 4 MHz from previous center frequency.

1. Connect the PC, via the supplied programming lead, to the speaker panel's front-mounted RJ11 connector.
2. Run Tait PGM800Win program and follow instructions found in the T800 Programming Software User's Manual to select the proper module to be programmed.
3. Program required channel's frequencies.
 - Do not program any CTCSS tones on channels.
 - Do not change any other parameters.
 - Refer to Figure 23, Figure 24, Figure 25 and Figure 26 for screen program examples.
4. Save the base station programming info to a file for further reference.

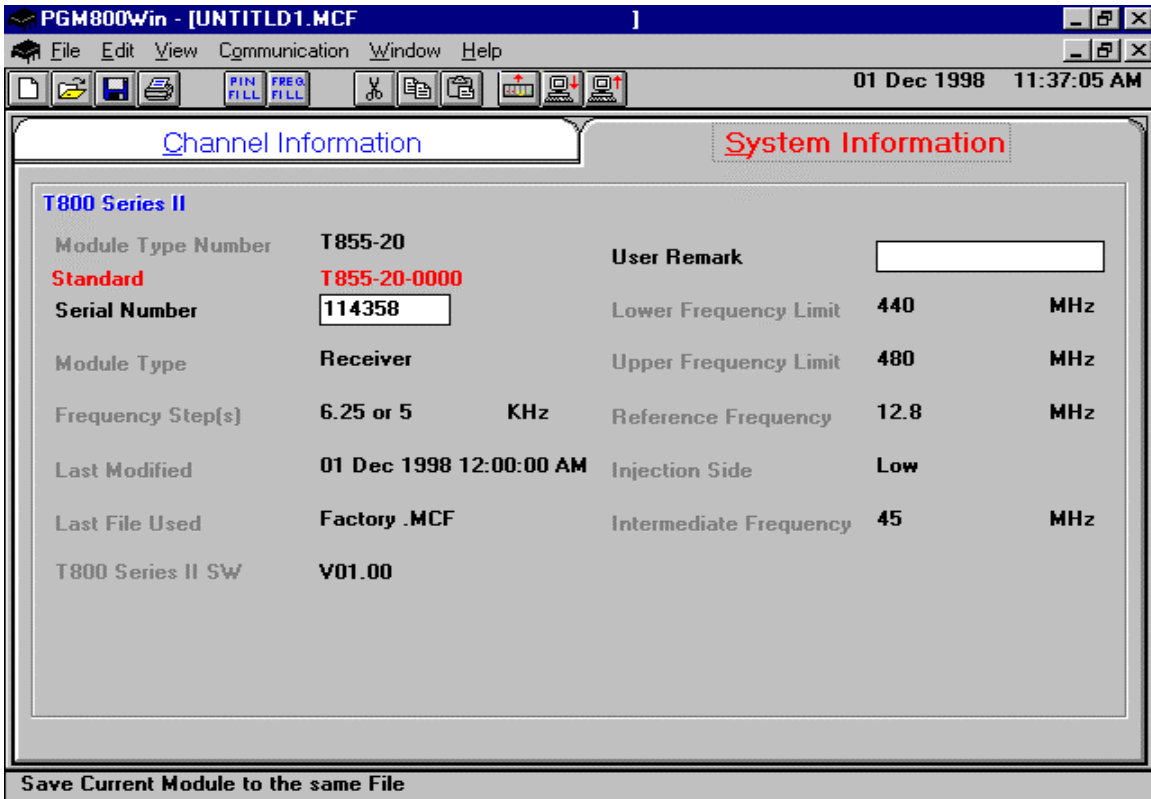

Figure 23 - Receiver System Information

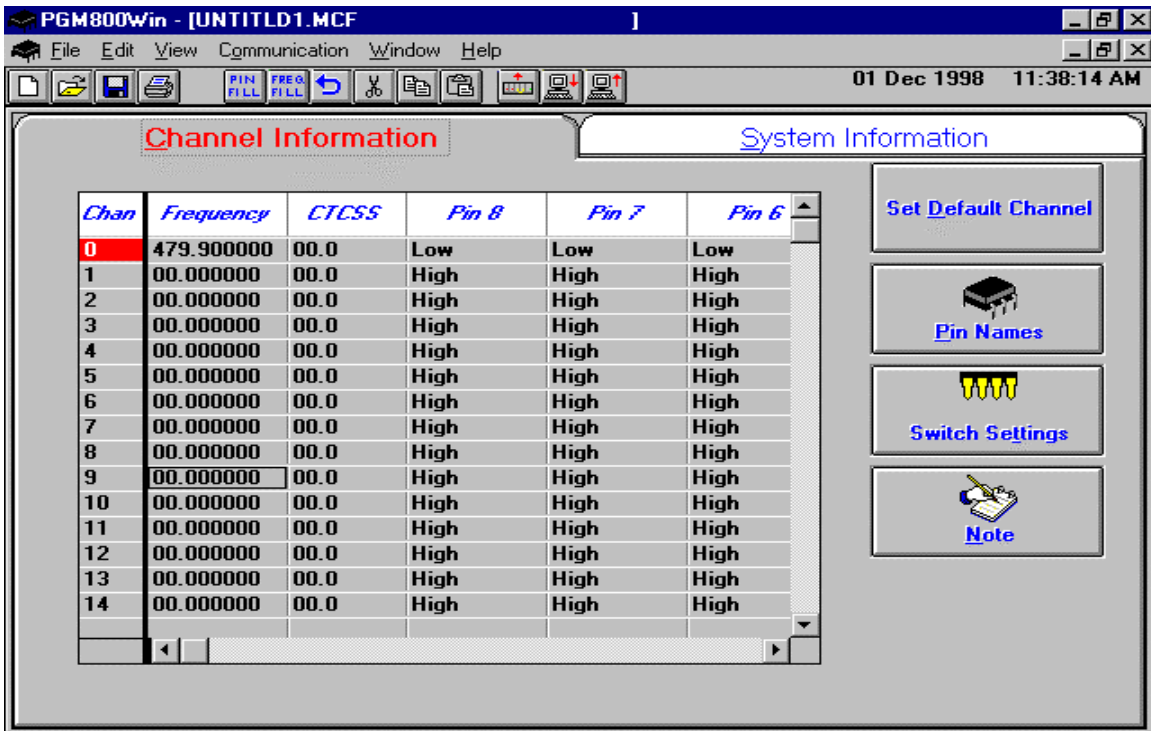

Figure 24 - Receiver Channel Information screen

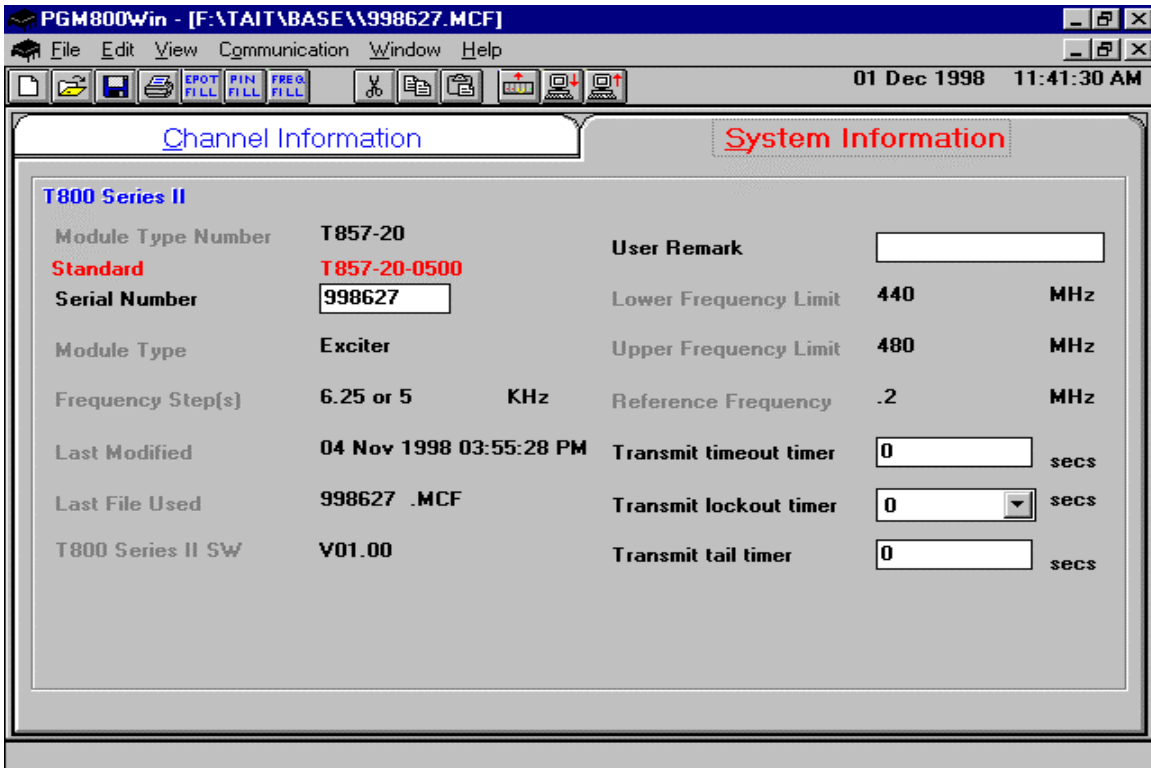

Figure 25 - Exciter System Information screen

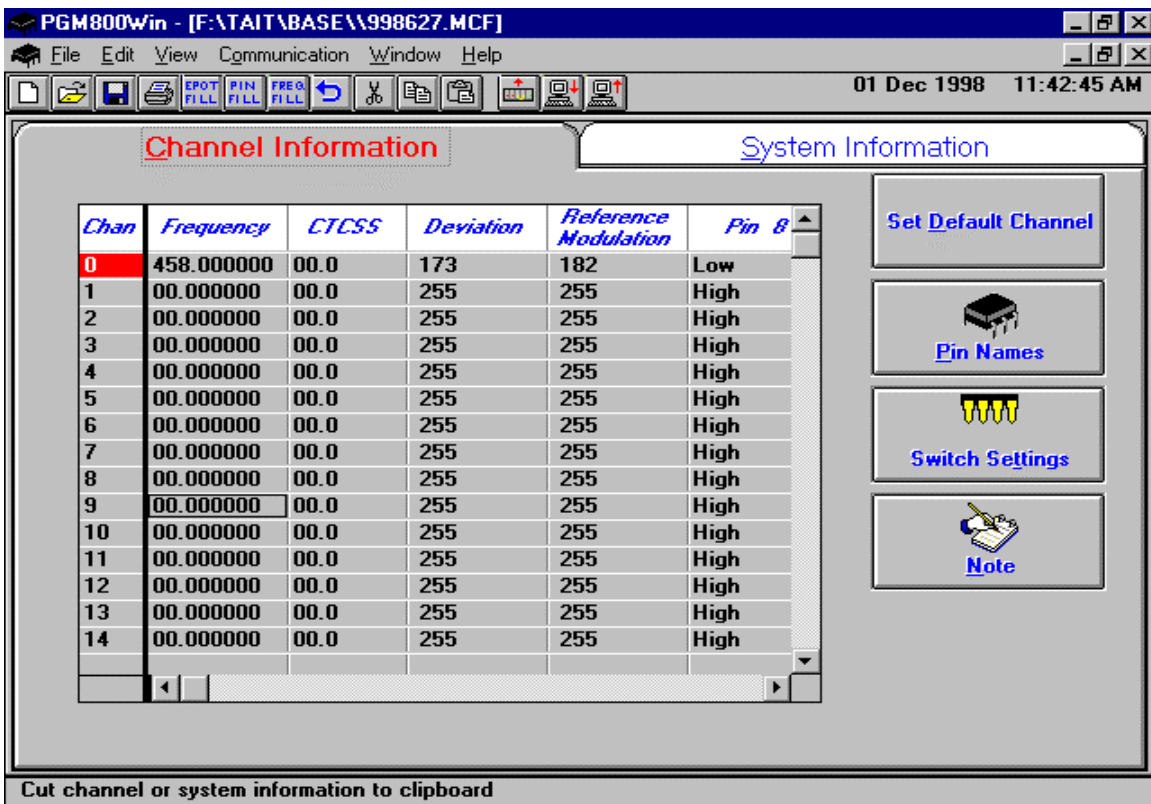

Figure 26 - Exciter Channel Information screen

6.3.3 Channel Selection via DIP Switches

The backplane-mounted DIP switch settings override the default channel programmed by PGM800Win.

To set a default channel via the software, all DIP switches must be set to “OFF” (i.e. 00000000).

When a switch is “Off”, its binary count is active; when a switch is “ON” its binary count is inactive.

The various DIP switch combinations of ON or OFF make up a binary total, which identifies the channel number. To select a channel, set the appropriate DIP switch or switches to “OFF” to make the binary count total the channel number you want. Set all other switches to “ON”.

It is recommended to set both SW1 (RX) and SW2 (TX) to the same settings on both back plane boards.

Example: To select channel 5, set the DIP switches as shown below:

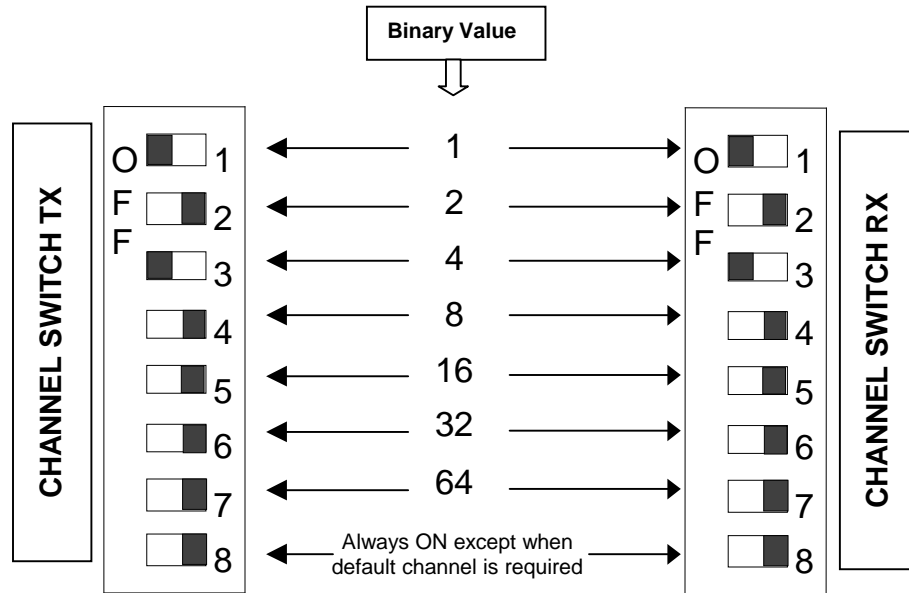

Figure 27 - Backplane DIP switches example - Channel 5 selected

6.4 Series II Radio Tuning

This section covers some basic radio tuning and verification for VHF (T83x-xx-nnnn) and UHF (T85x-xx-nnnn) Series II base station modules.

Note: Usually, this section is not done unless called for in section 6.3 “Series II - Radio Programming” or in Table 11 “Checklist B”.

6.4.1 Test Equipment

- Digital multimeter & probes (e.g. Fluke 77)
- 1 HP 34330A Shunt 30A (UHF only, used for transmitter current measurement)
- Digital or analog calibrated Oscilloscope & scope probes (X1, X2 selectable)
- Calibrated COM-120B (.001ppm TCXO and 30kHz IF options)
- 3 feet long double shielded N-M to BNC-M cable (RG-214 or RG-223)
- 2x 'BNC' to 'N' type adapters (e.g. Amphenol, Greenpar).
- Bird RF power meter with 150W / 50 ohm dummy load (optional)
- 1x Torx screwdriver #10
- Pozidriv screwdriver #1 & #2
- 1x Six inch adjustable wrench
- RF tuning/trimming tools.
- Extender Rail Kit for Series II chassis (T800-13-0000)
- 1x 6" coax cable N-M to BNC-M (comes with the radio to connect the exciter to the PA)

6.4.2 Receiver module (T855 & T835)

Note 1: Refer to Figure 32 (T855) and to Figure 34 (T835) for locating tuning controls.

Note 2: When the synthesizer is unlocked, the front panel green LED called "Supply" will flash indicating that it needs re-tuning.

Warning,

The LED will also flash when the unit is in setup mode while connected to the PGM800win program.

6.4.2.1 Initial Setup

This initial setup will be used during all receiver alignment procedures described below:

1. Remove the receiver (T855 or T835) module from the Paragon^{PD} rack frame
2. Remove the receiver top cover (nearest the handle).
3. Connect the Paragon^{PD} Extender Rail Kit for Series II to the empty chassis receiver slot.
4. Prepare the multimeter to DC Volts.
5. Apply power to the Paragon^{PD}.

6.4.2.2 Synthesizer Alignment

Single channel: Connect the multimeter to the long lead of L1 in the VCO (this measures the synthesizer loop voltage).

1. T855 (UHF) Tune VCO trimmer C6 for a synthesizer loop voltage of 10V DC.
2. T835 (VHF). Tune VCO trimmer CV1 for a synthesizer loop voltage of 9VDC.

Multiple channels:

1. T855 (UHF) Adjust the VCO loop to 10V using the middle channel.
2. T835 (VHF) Adjust the VCO loop to 9V using the middle frequency channel.
3. All channels should lie within the upper and lower limits of respectively

All channels should lie within the upper and lower limits of 16V and 3V respectively for the T855 and within 13V and 5V for the T835.

6.4.2.3 Front-End Alignment

1. IFR COM120B settings:
 - a) Connect a 3 feet long double shielded cable (N-M to BNC-M) between the IFR T/R output and the receiver antenna connector.
 - b) Select the generator mode (GEN button) and set to the main receiver channel frequency
 - c) Select and turnon GEN2
 - d) Set the FM Deviation to $\pm 3\text{kHz}$ (full channel) or $\pm 1.5\text{kHz}$ (half channel) using 1KHz sine
 - e) Select SINAD meter
 - f) Use a X1 scope probe connected to SINAD input and monitor the Discriminator O/P on the backplane at SK1 pin 6 (RX-audio1). Alternately, it is also possible to monitor at the receiver TP314 (T855) or at the receiver IC350 pin 7 (T835).
2. Adjust the helical resonators for best SINAD: #FL410 and #FL420 (T855) or L410, L420, L460 and L470 (T835).
3. Continually decrease the RF level to reach 12dB SINAD, then re-do step 2) & 3) again. (minimum requirement to reach is 12dB SINAD for -110dBm)
4. Perform the SINAD linearity tests described in paragraph 6.4.2.4. If it fails to pass the requirement, contact your Dataradio technical support.

WARNING: Do NOT attempt to re-tune the IF stages

(i.e. L310 to L390 for T855, CV318 or L330 to L360 for T835).

These adjustments do not need to be re-adjusted after frequency re-programming. Touching these coils will have a direct impact on the modem DSP coefficient settings and may reduce significantly the radio performances over data.

6.4.2.4 SINAD and Linearity Check

1. Apply the following settings to the IFR:
 - a) Generator mode, Output T/R

- b) IFR TX frequency to match the main radio RX frequency
 - c) Filter set to wide band (no audio filter)
 - d) Select Gen2 (Modulating tone fixed to 1KHz). All other Gen must be off.
 - e) Set deviation to $\pm 3.0\text{KHz}$ for full channel or $\pm 1.5\text{KHz}$ for half channel radios.
 - f) Use a X1 scope probe connected to IFR SINAD input and monitor the Discriminator O/P on the backplane at SK1 pin 6 (RX-audio1). Alternately, it is also possible to monitor at the receiver TP314 (T855) or at the receiver IC350 pin 7 (T835)
2. Lower the RF level to get a 12dB SINAD reading. Level must be better than **-110dBm** (including cable loss).
 3. Offset the IFR TX frequency 2kHz (full channel) or 1kHz (half channel) above the main radio RX frequency, record the SINAD reading. It should remain within 1dB from the on frequency SINAD reading. For T855, use above values, for T835 use 1.5kHz (full channel) or 0.8kHz (half channel).
 4. Offset the IFR TX frequency 2KHz (full channel) or 1kHz (half channel) below the main radio RX frequency, record the SINAD reading. It should remain within 1dB from the on-frequency SINAD reading. For T855, use above values, for T835 use 1.5kHz (full channel) or 0.8kHz (half channel).

Note: If one of the above requirements is not met, try to re-tune the front-end. If still failed, contact your Dataradio technical support.

6.4.2.5 RSSI Adjustment (UHF: T855)

- Apply an on-channel signal from the RF generator at a level of -110dBm modulated by a one kHz tone at a deviation of $\pm 3\text{kHz}$ (full channel) or $\pm 1.5\text{kHz}$ (half channel).
- Adjust RV320 (RSSI level) to give 2.0V RSSI output at SK330 pin 2 or on backplane SK1 pin 5 when measured with a voltmeter (See Figure 30 for test point location).
- Vary the RF level and check the RSSI output voltage (Figure 28):
 - 1) At -120 dBm: 1.2 VDC (+0.20 -0.45VDC)
 - 2) At -90 dBm: 4.0 VDC (+0.20 -0.20 VDC)
 - 3) At -80dBm: 5.0 VDC (+0.20 - 0.35VDC)

If the requirement cannot be reached, contact your Dataradio technical support.

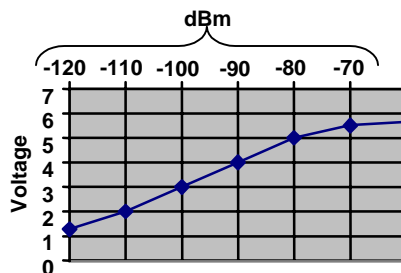

Figure 28 - T855 and T885, RSSI Curve: volt to dBm

6.4.2.6 RSSI Adjustment (VHF: T835)

Note: This check is only recommended for Paragon/R model running DBA protocol 3.06.009 series or later.

- Apply an on-channel signal from the RF generator at a level of -100dBm with deviation of ± 3 kHz (full channel) or ± 1.5 kHz (half channel) at 1kHz tone.
- Adjust RV320 (RSSI level) to give 4.5V RSSI output at RSSI test point (near quad. Coil L360) or on backplane SK1 pin 5 when measured with a voltmeter
- Vary the RF level and check the RSSI output voltage :
 - 1) At -120 dBm: 3.0 VDC (+0.20 -0.45VDC)
 - 2) At -105 dBm: 4.0 VDC (+0.20 -0.20 VDC)
 - 3) At -90dBm: 5.0 VDC (+0.20 - 0.25VDC)

If the requirement cannot be reached, contact your Dataradio technical support.

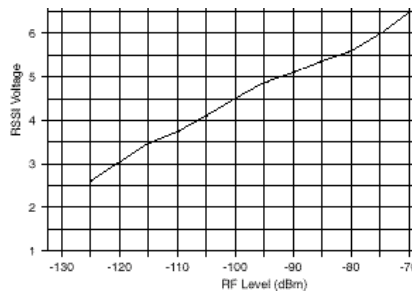

Figure 29 - T835, RSSI Curve: Volt to dBm

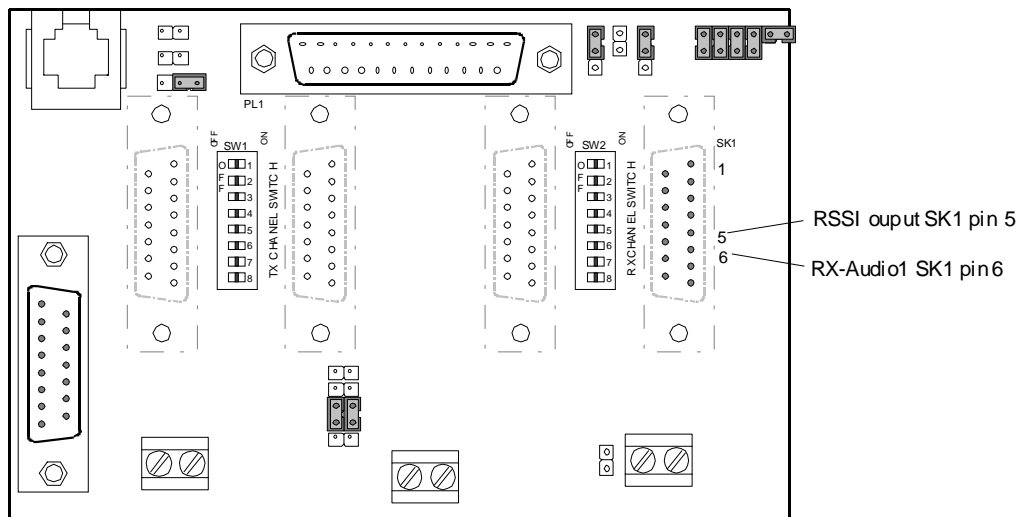

Figure 30 – T800-50-0001 Backplane and test pins location

6.4.3 Exciter Module (T857, T837 or T881)

Note 1: Refer to Figure 33 (T857) and to Figure 35 (T837) for locating tuning controls and components. *T881 series II will be included in a later release.*

Note 2: When the synthesizer is unlocked, the front panel green LED called "Supply" will flash indicating that it needs re-tuning.

Warning: The LED will also flash when the unit is in setup mode while connected to the PGM800win program.

6.4.3.1 Initial Setup

1. Shut down power to the base station
2. Prepare the multimeter to DC Volts.
3. Remove the exciter (T857 or T837) module from the base station rack frame
4. Remove the exciter top cover (nearest the handle).
5. Connect a 3 feet long double shielded cable (N-M to BNC-M) between the IFR T/R output and the exciter antenna connector.
6. Connect the Paragon^{PD} Extender Rail Kit to the empty chassis exciter slot.
7. Apply power to the base station

6.4.3.2 Synthesizer Alignment

Single channel: Connect the multimeter to the long lead of L1 in the VCO (this measures the synthesizer loop voltage).

1. T857 (UHF) Tune VCO trimmer C6 for a synthesizer loop voltage of 10V DC.
2. T837 (VHF). Tune VCO trimmer CV1 for a synthesizer loop voltage of 9VDC.

Multiple channels:

1. T857 (UHF) Adjust the VCO loop to 10V using the middle channel.
2. T837 (VHF) Adjust the VCO loop to 9V using the middle frequency channel.

All channels should lie within the upper and lower limits of 16V and 3V respectively for the T857 and within 13V and 5V for the T837.

Note:

Normally, the fast TX key option is installed and the synthesizer is always energized. In the case where that option was not fitted, key the transmitter by pressing the front panel Carrier button to make the above adjustment possible.

6.4.3.3 TX Frequency Error Adjustment

1. Apply the following settings to the IFR:
 - Receiver mode
 - IFR RX frequency to match the main radio TX frequency
 - IF Filter set to 30KHz
 - Zoom the RF Error window: select 10Khz range

2. Key the transmitter by pressing the front panel TX-Key button and measure the carrier output frequency. It should be within ± 300 Hz. If it is not, adjust the TCXO to trim to meet the requirement, preferably within 100Hz.

6.4.3.4 Low-Frequency Balance Adjustment

PGM800Win controls this adjustment. Electronic potentiometer (256 step) is used to allow channel adjustment of two-point modulation (Low freq. balance).

1. Apply the following settings to the IFR:
 - Receiver mode and Oscilloscope display (Source Demod out connector, DC coupled).
 - IFR RX frequency to match the radio transmit frequency
 - IF Filter set to 30KHz
 - Zoom the Deviation window: select 10kHz Range and DC coupling.
2. Select the active or, the lowest (in the case of multi-channel base) frequency channel (via dip switch)
3. Transmit a square wave by pressing the BDLC^{PD}'s PF1 button and following the procedure outlined in section 3.2.1.1.2.2. You can also run both programs on the same computer if two serial COM ports are available.
4. Adjust IC220 via PGM800Win "reference modulation" to obtain the best square wave, no damping, no overshoot. (You can use either the mouse or up and down arrow keys). Record the deviation read.
5. If transmission has not ended by itself, press BDLC^{PD} PF1 to stop it. For single-channel unit, proceed to step 8.
6. For multi-channel unit, select the highest frequency channel. Transmit a square wave by pressing the BDLC^{PD}'s PF1 button and following the procedure outlined in section 3.2.1.1.2.2. Record deviation again.
7. The difference in deviation between the two channels should be less than ± 300 Hz. If not, re-adjust IC220 to "average" the square wave shape on both channels until the spec is met.
8. To confirm the adjustment, select the active, or the lowest frequency channel. Compare the deviation produced between:
 - 1000 Hz sine wave adjust tone and
 - Random dataThe difference should be lower than 300 Hz. For multi-channel unit, repeat this step on the highest frequency channel.
8. Select the active channel. Transmit a TX ON (Modulated) adjustment tone by pressing the BDLC^{PD}'s PF1 button and following the procedure outlined in section 3.2.1.1.2.2. Make sure that deviation level read on the IFR correspond to model and bit rate in use (see Table 8 – Carrier deviations for Tone or Data Modulation). Re-adjust deviation as necessary referring to the related Checklist (B for Paragon^{PD} - page 27

6.4.3.5 Exciter Power Output

1. Apply the following settings to the IFR:
 - Receiver mode, Output T/R
 - IFR RX frequency to match the main radio TX frequency
 - IF Filter set to 30KHz
 - Select auto range in the *Power reading* window
 - Connect the coaxial cable from the IFR T/R to the Exciter output connector
2. Key the Exciter by pressing the module PTT button. The output power must be:
 - VHF (T837) = 800 mW \pm 200mW
 - UHF (T857) = 1W \pm 300mW
 - 800 (T881) = 4W \pm 300mW

6.4.4 Power Amplifier Module (T859 or T839)

- Re-install the exciter module into the Paragon^{PD} rack frame
- Connect the Exciter module to the Power Amplifier.
- Connect the Power Amplifier output to the IFR T/R connector or to a stand-alone BIRD style power meter, terminated with a 150W dummy load.
- Forward and reverse power alarm set (control) are identified on the PA cover.

6.4.4.1 Power Amplifier Power Output

- Key the transmitter on the exciter and adjust the PA output for 100W using front panel power control. If power cannot be reached, refer to section 6.4.4.4 for T859 UHF model or to Tait T839 service manual for T839 model. Cable loss should be included in the reading.

6.4.4.2 Forward Power Alarm Level

1. Power up the PA and adjust front panel power control so that the output power is at the alarm level required, usually 20% lower than nominal value (e.g. 40W if the PA normally operates at 50W).
2. Adjust the forward power alarm set (T859: RV48 or T839: RV101) so that the forward power alarm LED lights.
3. Adjust front panel power control (T859: RV63 or T839: RV109) for the normal operating power level

6.4.4.3 Reverse Power Alarm Level (Optional)

1. Power up the PA and adjust the front panel power control for the normal operating power level.
2. Place a known mismatch of the required value (e.g. 3:1 VSWR) and adjust the reverse power alarm set (T859: RV52 or T839: RV105) so that the reverse power alarm LED lights.

Example:

A VSWR of 3:1 can be simulated by connecting an unterminated 3dB pad to the PA output. This will result in a return loss of 6dB.

6.4.4.4 Tait T859 (UHF) Standard Tuning Procedure

1. For sets with serial numbers following 217262, set RV69 (driver power level) fully clockwise.
2. For all units, preset the tuning controls as shown in Figure 31









	450MHz	485MHz	520MHz
CV32, CV51, CV57			
CV34, CV35			
CV8, CV1			

Figure 31 - T859 Tuning Settings

3. Set RV63 (front panel power control) fully clockwise.
4. Key on the exciter (press PTT button).
5. Adjust CV1 for maximum output.
6. Adjust CV8 for maximum output.
7. Adjust CV32 for maximum output.
8. Adjust CV51 and CV57 for maximum output.
9. Adjust CV34 and CV35 for maximum output.
10. Recheck all settings. The power output should exceed 110W.
11. For sets with serial numbers following 217262, adjust RV69 (driver power level) until the output power drops to 110W.
12. For all units, adjust RV63 to reduce the power output to the required level (normally 100W).

6.4.4.5 Tait T859 Tuning for Best Efficiency

1. Insert a Shunt current device (HP 34330A Shunt 30A) between the power supply red wire and its 13.8Vdc output, then connect the shunt to the multimeter (VDC scale)
2. While transmitting, monitor the current. It should remain under 22A.
3. Retune CV32, CV51 and CV57 towards maximum capacitance to obtain minimum supply current, but do not exceed a maximum drop of 0.5A per control.
4. Check that the supply current is <22A for 100W output power.

Note:

These control settings are normally very close to minimum supply current. If the current is reduced too far, maximum power output will drop and 2f rejection may degrade.

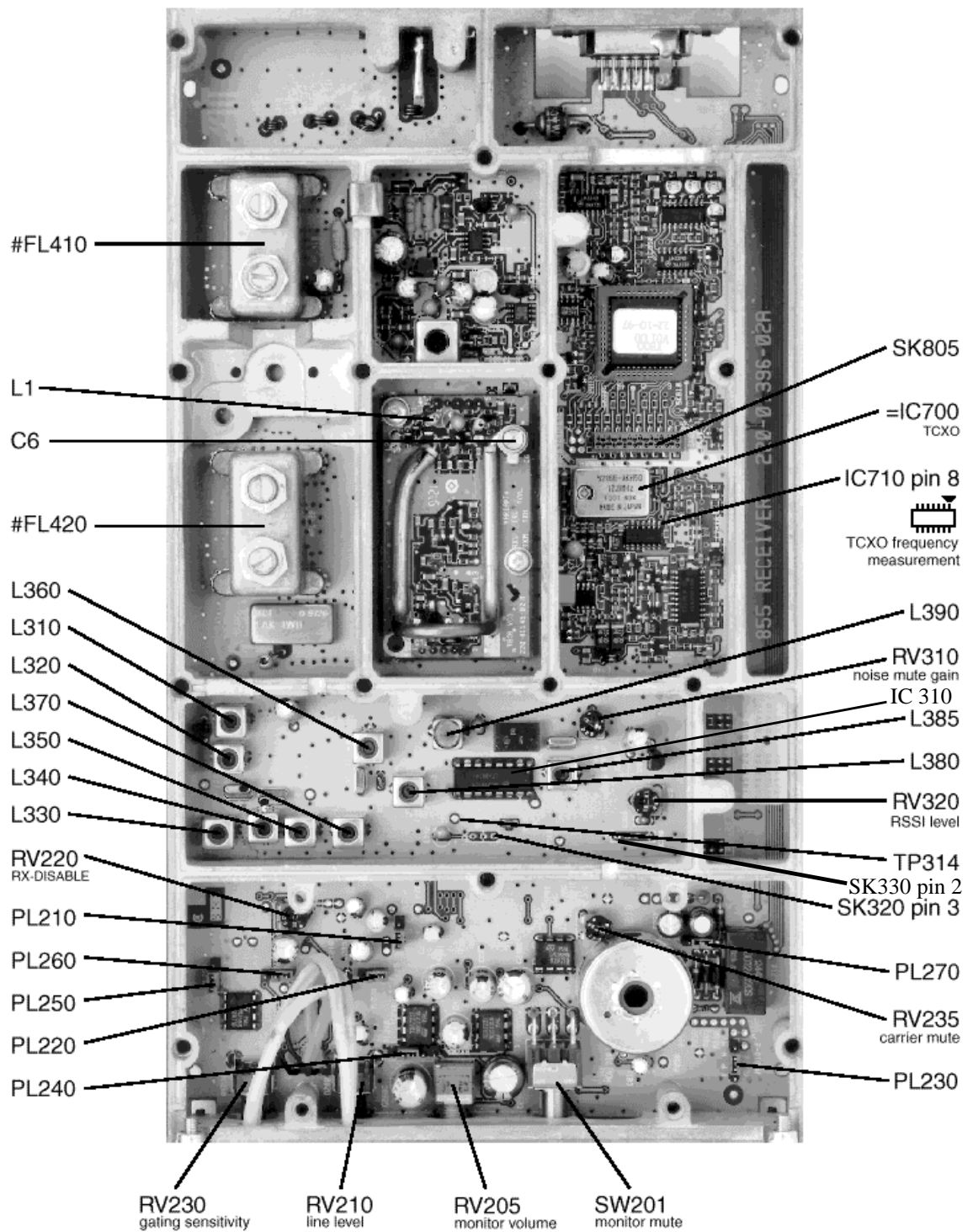

Figure 32 - T855 Receiver Tuning Controls Location

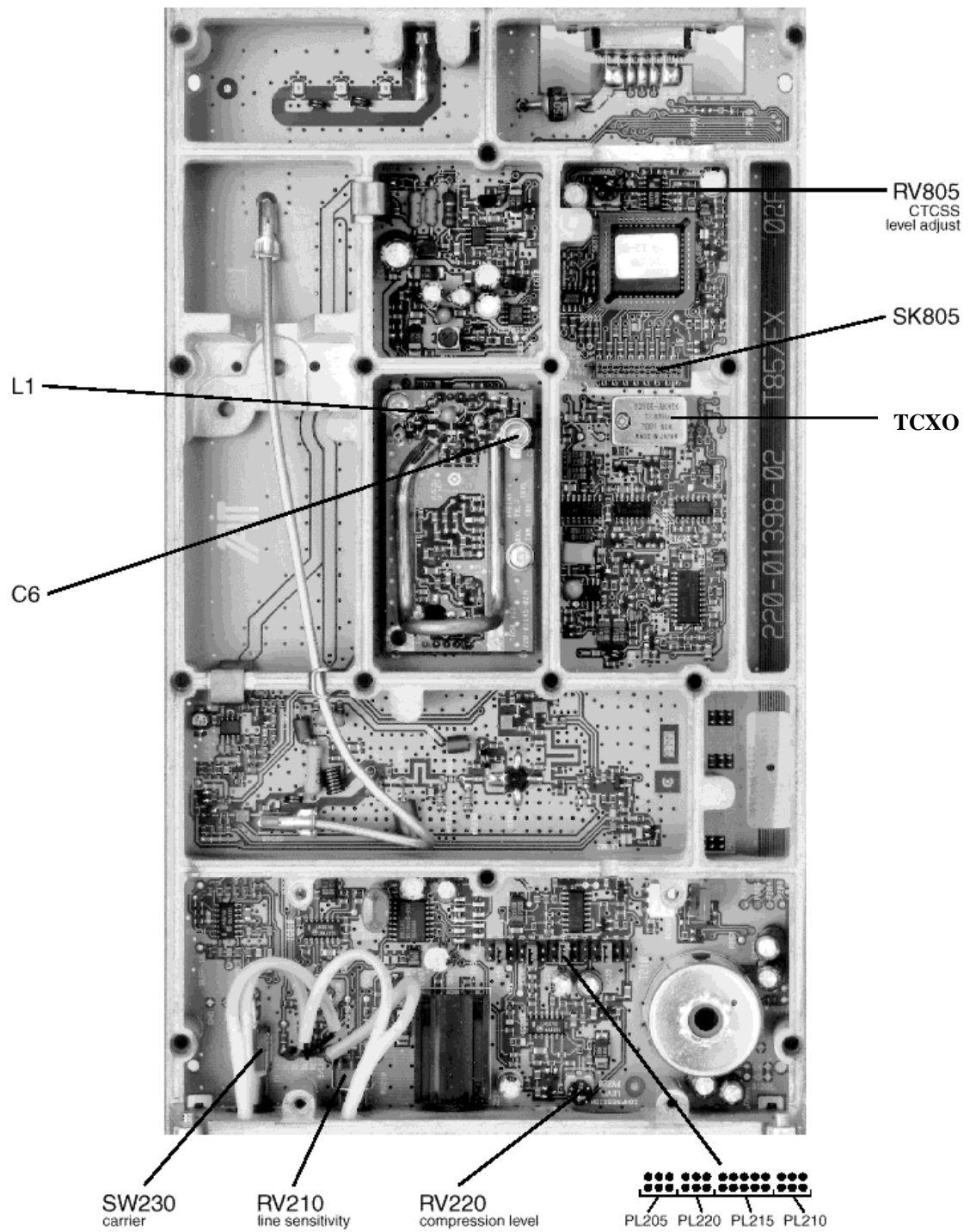

Figure 33 - T857 Exciter Tuning Controls Locations

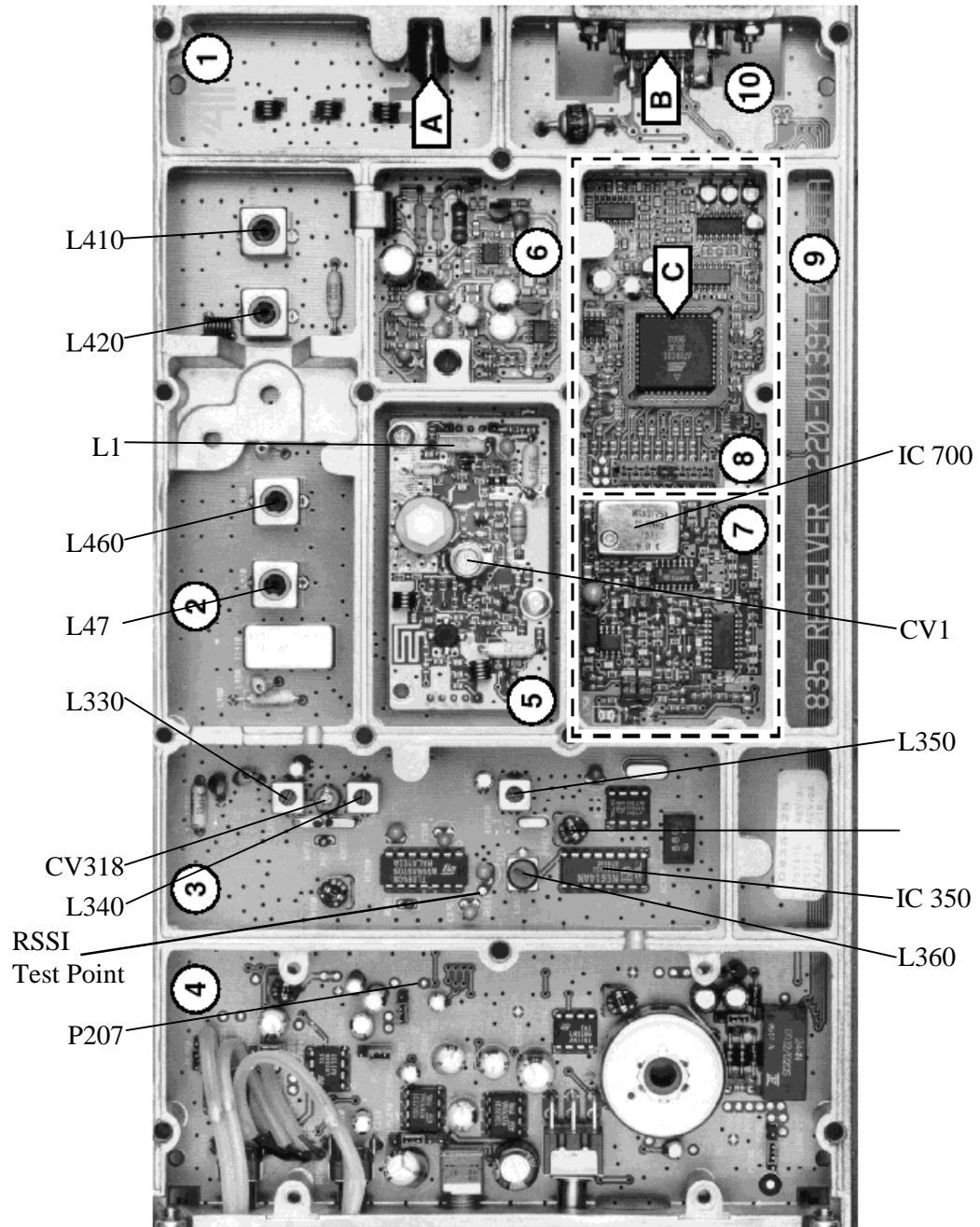

Figure 34 - T835 Receiver Tuning Controls Location

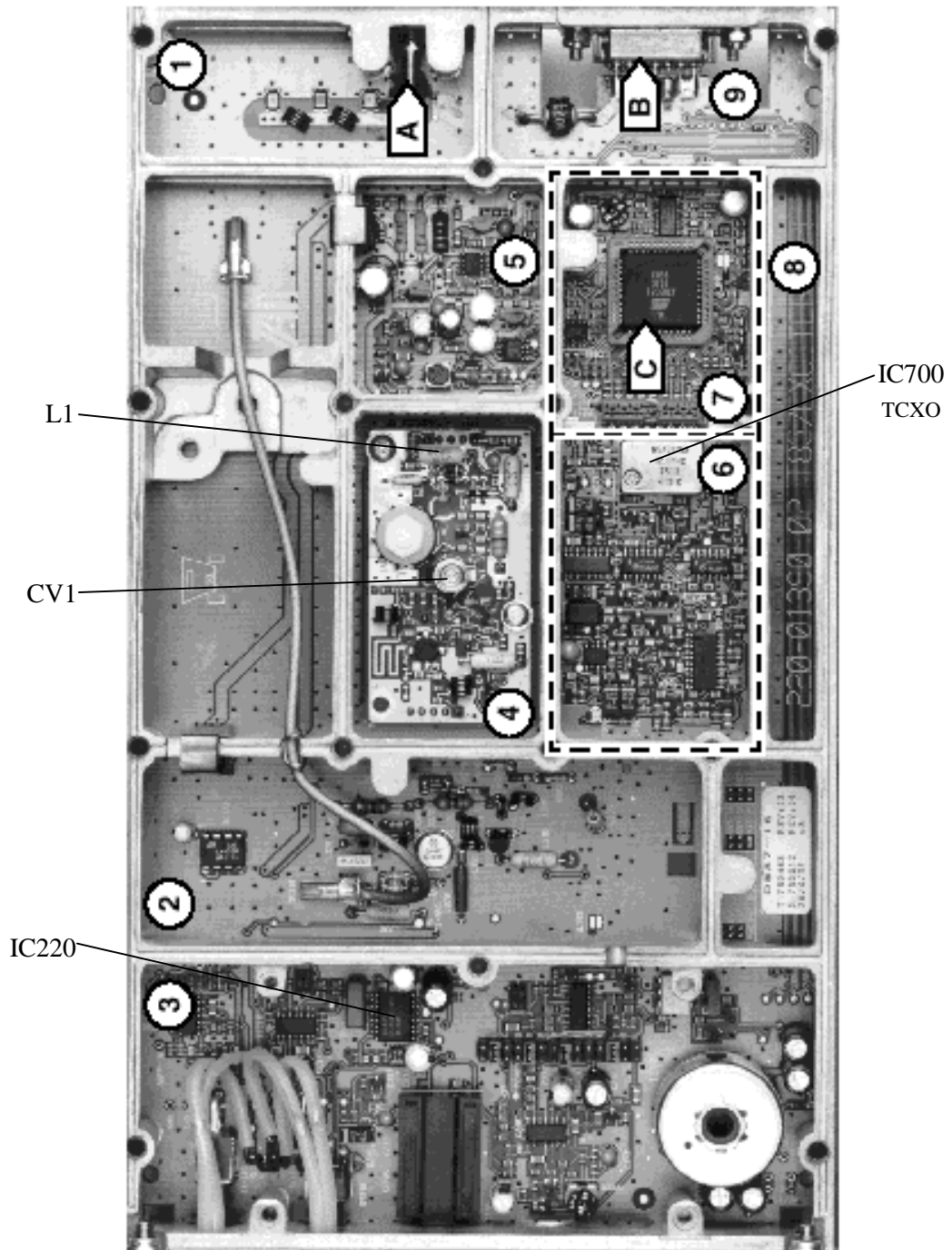

Figure 35 - T837 Exciter Tuning Controls Location

Appendix 1 - Paragon^{PD} Deviation adjust

1. Using the WinRIS, press *TX ON (Modulated)* and record deviation level as read on the IFR.
2. Using Windows Notepad, Edit the .bp2 file named with the corresponding BDLC^{PD} serial number (e.g. abcd.bp2). “Save as” to another file name and keep it in case something goes wrong while changing a parameter.
3. Locate the line labeled “Dev0 Par85=” and record the value beside the “=” sign. This is the corresponding parameter value to the deviation read in step 1.
4. Apply the following formula to determine the new parameter value to be set:
(New Par85 value) = [(initial Par85 value) X (target deviation) / (deviation read)] + 2
5. Change the value in the file, “Save as” using the BDLC^{PD} serial number file name.
6. Run the WinRIS again and do a “Put From”. From the opened window, select the file that you just made the change to and then press “OK”
7. Again, check deviation level while pressing *TX ON (Modulated)*.
 - If the level is now correct, press *Stationreset* to make the change permanent.
 - Otherwise do step 5 again, changing the value entered in the file by 1 or 2 digit(s) up or down, fine-tuning directly the Par85 (DSP deviation) parameter. Do steps 6 and 7 again to confirm acceptance.

This last step may have to be repeated once or twice while varying the entered value up or down. If unable to obtain the correct level after editing up and/or down by no more than 2, contact System Engineering.

7. Specifications

GENERAL

	VHF	UHF	800 MHz (Series I)
Frequency	136 -156 MHz 148 -174 MHz	400 - 440 MHz ¹ 440 - 480 MHz 480 - 520 MHz	Rx 800 - 880 MHz Tx 850 - 870 MHz ----- Rx 870 – 960 MHz Tx 870 – 960 MHz 5W only
RF/Modem Assembly Size	19.0" W x 17.5.0" H x 12.5" D + 2.0" connector allowance		
Frequency Stability	2.5 ppm	1.0 ppm	1.5 ppm
Rx Current Consumption @ 13.8 VDC	1.5A max. (Two receivers)		
Tx Current Consumption @ 13.8 VDC	21A DC max. @ 100W	24A DC max. @ 100W	24A DC max. @ 70W
Base Station Power Consumption @ 115 VAC	6A max.		
Channel spacing	12.5 or 25 kHz		
Operating Temperature Range	-30°C to +60°C (deleted power supply, catalog number ending with a 0) -10°C to +60°C (with standard Dual Power Supply assembly, catalog number ending with a 2)		

RECEIVER

Selectivity @ 25 kHz @ 12.5 kHz	95 dB 89 dB	90 dB 85 dB	85 dB 80 dB
Sensitivity @ 12 dB SINAD	-117 dBm		
Spurious Response	100 dB		
Intermodulation - EIA 25 kHz - EIA 300-096 12.5 kHz	85 dB 80 dB	85 dB 85 dB	
Hum and Noise - EIA - ETS 300-096	N/A	55 dB 50 dB	50 dB 45 dB

TRANSMITTER

Rated Continuous RF Power	100W	100W	70W
Range of Adjustment	20 – 100 W	20 – 100 W	20 – 70 W
Spurious Emissions - transmit - standby	-36 dBm to 1 GHz/-30 dBm to 4 GHz -57 dBm to 1 GHz/-47 dBm to 4 GHz		
Hum and Noise - narrow - Wide	-50 dB -55 dB	-50 dB -55 dB	-45 dB -50 dB
VSWR Stability	5:1 mismatch		
Transmitter Sideband Noise @ +/-25 kHz @ +/- 1 MHz	-95 dBc -105 dBc	-95 dBc -105 dBc	-88 dBc -100 dBc

¹ **WARNING:** The frequency band 406 to 406.1 MHz is reserved for use by distress beacons and should not be programmed into the unit.

FCC / IC CERTIFICATIONS
DGFSK modulation

		FCC	IC (DOC) *
VHF	136 - 156 MHz	CASTEL0007	737195375A
	148 - 174 MHz	CASTEL0002	737195376A
UHF	400 - 440 MHz ¹	CASTEL0021	3993195401A
	440 - 480 MHz	CASTEL0023	
	480 - 520 MHz	CASTEL0025	N/A
800 MHz	800 - 870 MHz	CAS8IPT889BW (100 Watts) CAS8IPT881 (5Watts)	737194358

FCC / IC CERTIFICATIONS
SRRC4FSK modulation

		FCC	IC (DOC) *
UHF	400 - 440 MHz ¹	EOTBDD4T85-1	3993195401A
	440 - 480 MHz	EOTBDD4T85-2	
	480 - 520 MHz	EOTBDD4T85-3	N/A
800 MHz Series I	800 - 870 MHz	EOTBDD4T889 (100 Watts) EOTBDD4T881 (5Watts)	737194358
800 MHz Series II	800 - 870 MHz	Pending	737194358

* Operating under Class II permissive change

1 **WARNING:** The frequency band 406 to 406.1 MHz is reserved for use by distress beacons and should not be programmed into the unit.