



element

Starkey Laboratories, Inc.

Multi-Function Accessory

Bluetooth Radio

SAR Evaluation Report # STAK0117.10

Evaluated to the following SAR specification:

FCC 2.1093:2018

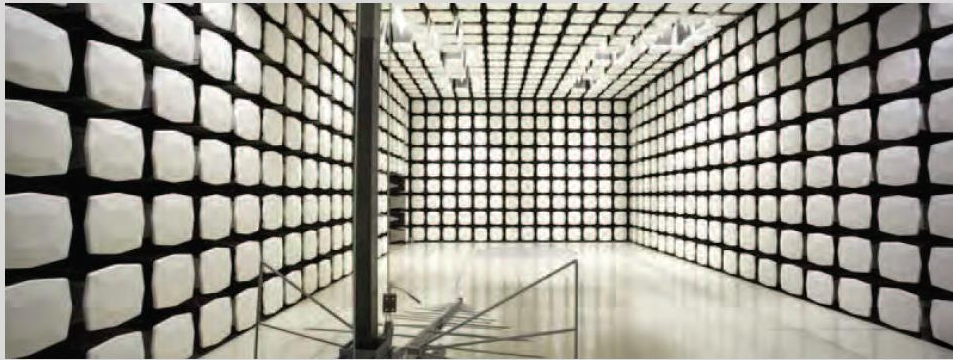

NVLAP Lab Code: 200630-0

This report must not be used to claim product certification, approval, or endorsement by NVLAP, NIST, or any agency of the federal government of the United States of America. This Report shall not be reproduced, except in full without written approval of the laboratory.

EAR-Controlled Data - This document contains technical data whose export and reexport/retransfer is subject to control by the U.S. Department of Commerce under the Export Administration Act and the Export Administration Regulations. The Department of Commerce's prior written approval may be required for the export or re-export/retransfer of such technical data to any foreign person, foreign entity or foreign organization whether in the United States or abroad.

More: <https://www.bis.doc.gov/index.php/forms-documents/regulations-docs/14-commerce-country-chart/fileT>

CERTIFICATE OF TEST



Last Date of Test: July 20, 2018
Starkey Laboratories, Inc.
Model: Multi-Function Accessory

Applicable Standard

Test Description	Specification	Test Method	Pass/Fail
SAR Evaluation	FCC 2.1093:2018	FCC KDB 865664 D01 v01r04 FCC KDB 865664 D02 v01r02 FCC KDB 447498 D01 v06 IEEE Std 1528:2013	Pass

Highest SAR Values:

Frequency Bands (GHz)	Body (W/kg) 1g	Limit (W/kg)	Exposure Environment
		1g	
2.4	0.003	1.6	General Population

Deviations From Test Standards

None

Approved By:

Don Facteau, Systems Architect

REVISION HISTORY



Revision Number	Description	Date	Page Number
00	None		

ACCREDITATIONS AND AUTHORIZATIONS



United States

FCC - Designated by the FCC as a Telecommunications Certification Body (TCB). Certification chambers, Open Area Test Sites, and conducted measurement facilities are listed with the FCC.

A2LA - Accredited by A2LA to ISO / IEC 17065 as a product certifier. This allows Element to certify transmitters to FCC and IC specifications.

NVLAP - Each laboratory is accredited by NVLAP to ISO 17025

Canada

ISED - Recognized by Innovation, Science and Economic Development Canada as a Certification Body (CB). Certification chambers and Open Area Test Sites are filed with ISED.

European Union

European Commission – Within Element, we have a EU Notified Body validated for the EMCD and RED Directives.

Australia/New Zealand

ACMA - Recognized by ACMA as a CAB for the acceptance of test data.

Korea

MSIT / RRA - Recognized by KCC's RRA as a CAB for the acceptance of test data.

Japan

VCCI - Associate Member of the VCCI. Conducted and radiated measurement facilities are registered.

Taiwan

BSMI – Recognized by BSMI as a CAB for the acceptance of test data.

NCC - Recognized by NCC as a CAB for the acceptance of test data.

Singapore

IDA – Recognized by IDA as a CAB for the acceptance of test data.

Israel

MOC – Recognized by MOC as a CAB for the acceptance of test data.

Hong Kong

OFCA – Recognized by OFCA as a CAB for the acceptance of test data.

Vietnam

MIC – Recognized by MIC as a CAB for the acceptance of test data.

SCOPE

For details on the Scopes of our Accreditations, please visit:

<http://portlandcustomer.element.com/ts/scope/scope.htm>

<http://gsi.nist.gov/global/docs/cabs/designations.html>

FACILITIES



California Labs OC01-17 41 Tesla Irvine, CA 92618 (949) 861-8918	Minnesota Labs MN01-10 9349 W Broadway Ave. Brooklyn Park, MN 55445 (612)-638-5136	New York Labs NY01-04 4939 Jordan Rd. Elbridge, NY 13060 (315) 554-8214	Oregon Labs EV01-12 6775 NE Evergreen Pkwy #400 Hillsboro, OR 97124 (503) 844-4066	Texas Labs TX01-09 3801 E Plano Pkwy Plano, TX 75074 (469) 304-5255	Washington Labs NC01-05 19201 120 th Ave NE Bothell, WA 98011 (425)984-6600
NVLAP					
NVLAP Lab Code: 200676-0	NVLAP Lab Code: 200881-0	NVLAP Lab Code: 200761-0	NVLAP Lab Code: 200630-0	NVLAP Lab Code:201049-0	NVLAP Lab Code: 200629-0
Innovation, Science and Economic Development Canada					
2834B-1, 2834B-3	2834E-1, 2834E-3	N/A	2834D-1, 2834D-2	2834G-1	2834F-1
BSMI					
SL2-IN-E-1154R	SL2-IN-E-1152R	N/A	SL2-IN-E-1017	SL2-IN-E-1158R	SL2-IN-E-1153R
VCCI					
A-0029	A-0109	N/A	A-0108	A-0201	A-0110
Recognized Phase I CAB for ACMA, BSMI, IDA, KCC/RRA, MIC, MOC, NCC, OFCA					
US0158	US0175	N/A	US0017	US0191	US0157

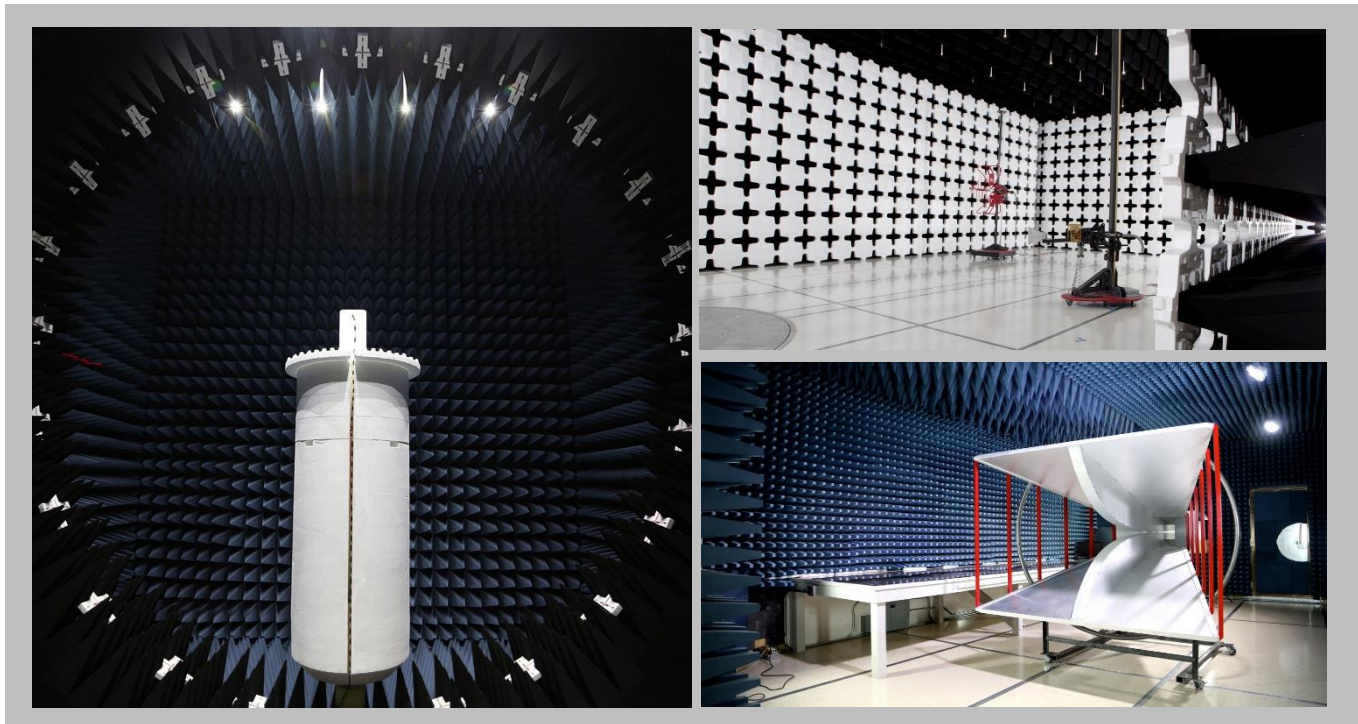

PRODUCT DESCRIPTION

Client and Equipment Under Test (EUT) Information

Company Name:	Starkey Laboratories, Inc.
Address:	6600 Washington Ave. SO.
City, State, Zip:	Eden Prairie, MN 55344
Test Requested By:	Bill Mitchell
Model:	Multi-Function Accessory
First Date of Test:	June 26, 2018
Last Date of Test:	July 20, 2018
Receipt Date of Samples:	June 18, 2018
Equipment Design Stage:	Production
Equipment Condition:	No Damage
Purchase Authorization:	Verified

Information Provided by the Party Requesting the Test

Functional Description of the EUT:

The EUT is remote microphone device that contains two radios: a Bluetooth and a Bluetooth LE. This test report contains measured SAR data for the Bluetooth radio which is a 2450MHz FHSS radio that operates and has one antenna. No external devices will be used with the EUT.

Location of transmit antenna(s):

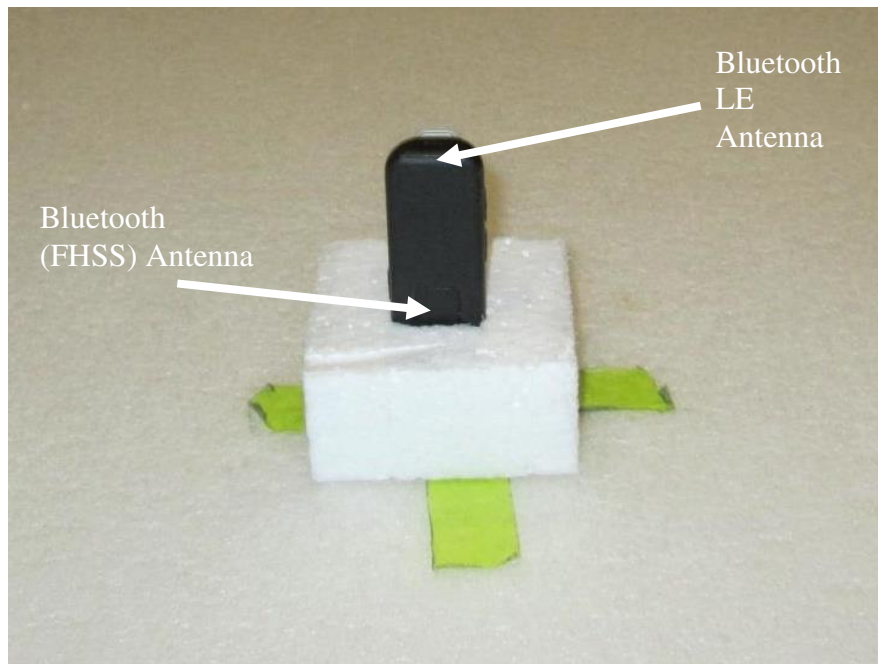



PRODUCT DESCRIPTION

Testing Locations

All available sides were tested. The EUT will be used with a clip. All six sides were measured with a clip. Testing was done with a 0 cm spacing to the phantom.

Simultaneous Transmission

The Bluetooth radio can transmit simultaneously with the Bluetooth LE contained in the device. Per FCC KDB 447498 D01 v06, the estimated standalone SAR for the Bluetooth LE radio is calculated as follows:

Conducted Output Power (mW)	Test Separation (mm)	Factor (7.5 for 1g) (18.75 for 10g)	Transmit Frequency (GHz)	Estimated Standalone SAR (W/kg)
7.344	5	7.5	2.442	0.3060

The measured SAR of the Bluetooth radio is then summed with the estimated SAR of the Bluetooth LE radio for comparison to the limit:

Measured SAR from Bluetooth radio (W/kg)	Estimated SAR from Bluetooth LE radio (W/kg)	Sum of measured and estimated SAR values (W/kg)	SAR Limit (W/kg)
0.003	0.306	0.309	1.6

When the sum of the SAR is less than the limit as it is in this case, no further evaluation of the simultaneous transmission condition is required. It is deemed to comply with the SAR requirements.

Testing Objective:

To demonstrate compliance of the radio with the SAR requirements of FCC 2.1093:2018.

Scaling:

Power

Rated conducted power of the Classic Bluetooth Radio is 0 dBm, antenna gain is -5 dBi. Radiated power is -5 dBm e.i.r.p. The scaling factor used can be found under the test results section.

Duty Cycle

The EUT was transmitting at nearly 100% duty cycle.

CONFIGURATIONS



Configuration STAK0117- 1

EUT			
Description	Manufacturer	Model/Part Number	Serial Number
Multi-function Accessory	Starkey Laboratories, Inc.	900	182010052A

Configuration STAK0117- 7

EUT			
Description	Manufacturer	Model/Part Number	Serial Number
Multi-function Accessory	Starkey Laboratories, Inc.	900	182010051A

Peripherals in test setup boundary			
Description	Manufacturer	Model/Part Number	Serial Number
USB to Serial Controller	CSR	CN510020V5A	361820
Power Supply (Laptop)	Lenovo	ADLX90NCT2A	11S45N0311Z1ZLZ633M0T4
Laptop (Lenovo)	Lenovo	ThinkPad T430	11306

Cables					
Cable Type	Shield	Length (m)	Ferrite	Connection 1	Connection 2
Serial Cable	No	0.2m	No	USB to Serial Controller	Multi-Function Accessory
USB Cable (USB to Serial Controller)	No	1.8m	Yes	USB to Serial Controller	Laptop
AC Cable (Laptop)	No	1.0m	No	AC Mains	AC Adapter (Lenovo Laptop)
DC Cable (Laptop)	No	1.8m	Yes	AC Adapter (Lenovo Laptop)	Laptop (Lenovo)

MODIFICATIONS



Equipment Modifications

Item	Date	Test	Modification	Note	Disposition of EUT
1	6/26/2018	Output Power	Tested as delivered to Test Station.	No EMI suppression devices were added or modified during this test.	EUT remained at Element following the test.
2	7/20/2018	SAR Evaluation	Tested as delivered to Test Station.	No EMI suppression devices were added or modified during this test.	Scheduled testing was completed.

TISSUE – EQUIVALENT LIQUID DESCRIPTION



VERSION

Characterization of tissue-equivalent liquid dielectric properties

Per IEEE 1528: 2013, Section 5.3.2, the permittivity and conductivity of the tissue material should be measured at least within 24 hours of any full-compliance test. The measured values must be within +/- 5% of the target values. The temperature variation in the liquid during SAR measurements must be within +/- 2 degrees C of that recorded when the dielectric properties were measured.

The dielectric parameters of the tissue-equivalent liquids were measured within 24 hours of the start of testing using the SPEAG DAKS:200 dielectric assessment kit. The dielectric measurements were made across the frequency range of the liquid. The attached data sheets show that the dielectric parameters of the liquid were within the required 5% tolerances.

Target values of dielectric parameters

Per KDB 865664 D01 v01r04, Appendix A:

“The head tissue dielectric parameters recommended by IEEE Std 1528-2013 have been incorporated in the following table. These head parameters are derived from planar layer models simulating the highest expected SAR for the dielectric properties and tissue thickness variations in a human head. Other head and body tissue parameters that have not been specified in IEEE Std 1528 are derived from tissue dielectric parameters computed from the 4-Cole-Cole equations described above and extrapolated according to the head parameters specified in IEEE Std 1528.”

Target Frequency (MHz)	Head		Body	
	ϵ_r	σ (S/m)	ϵ_r	σ (S/m)
150	52.3	0.76	61.9	0.80
300	45.3	0.87	58.2	0.92
450	43.5	0.87	56.7	0.94
835	41.5	0.90	55.2	0.97
900	41.5	0.97	55.0	1.05
915	41.5	0.98	55.0	1.06
1450	40.5	1.20	54.0	1.30
1610	40.3	1.29	53.8	1.40
1800 – 2000	40.0	1.40	53.3	1.52
2450	39.2	1.80	52.7	1.95
3000	38.5	2.40	52.0	2.73
5800	35.3	5.27	48.2	6.00

(ϵ_r = relative permittivity, σ = conductivity and $\rho = 1000 \text{ kg/m}^3$)

TISSUE – EQUIVALENT LIQUID DESCRIPTION



Composition of Ingredients for Liquid Tissue Phantoms

Element uses tissue-equivalent liquids prepared by SPEAG and confirmed by them to be within +/- 5% from the target values. Their recipes are based upon the following formulations as found in IEEE 1528:2013 Annex C (head) and IEC 62209-2:2010 Annex E (body):

The following tissue formulations are provided for reference only as some of the parameters have not been thoroughly verified. The composition of ingredients may be modified accordingly to achieve the desired target tissue parameters required for routine SAR evaluation:

HEAD

**Table C.1—Suggested recipes for achieving target dielectric parameters:
300 MHz to 900 MHz**

Frequency (MHz)	300	450	450	450	835	835	900	900	900	900
Reference	[B118]	[B118]	[B172]	[B74]	[B118]	[B74]	[B118]	[B196]	[B172]	[B74]
Ingredients (% by weight)										
1,2-Propanediol	—	—	—	—	—	—	—	64.81	—	—
Bactericide	0.19	0.19	0.50	—	0.10	—	0.10	—	0.50	—
Diacetin	—	—	48.90	—	—	—	—	—	49.20	—
DGBE	—	—	—	—	—	—	—	—	—	—
HEC	0.98	0.98	—	—	1.00	—	1.00	—	—	—
NaCl	5.95	3.95	1.70	1.96	1.45	1.25	1.48	0.79	1.10	1.35
Sucrose	55.32	56.32	—	—	57.00	—	56.50	—	—	—
Triton X-100	—	—	—	—	—	—	—	—	—	—
Tween 20	—	—	—	49.51	—	48.39	—	—	—	48.34
Water	37.56	38.56	48.90	48.53	40.45	50.36	40.92	34.40	49.20	50.31

**Table C.2—Suggested recipes for achieving target dielectric parameters:
1450 MHz to 2000 MHz**

Frequency (MHz)	1450	1800	1800	1800	1800	1800	1900	1900	1950	2000
Reference	[B118]	[B118]	[B196]	[B196]	[B172]	[B74]	[B118]	[B196]	[B74]	[B118]
Ingredients (% by weight)										
1,2-Propanediol	—	—	—	—	—	—	—	—	—	—
Bactericide	—	—	—	—	0.50	—	—	—	—	—
Diacetin	—	—	—	—	49.43	—	—	—	—	—
DGBE	45.51	47.00	13.84	44.92	—	—	44.92	13.84	45.00	50.00
HEC	—	—	—	—	—	—	—	—	—	—
NaCl	0.67	0.36	0.35	0.18	0.64	0.50	0.18	0.35	—	—
Sucrose	—	—	—	—	—	—	—	—	—	—
Triton X-100	—	—	30.45	—	—	—	—	30.45	—	—
Tween 20	—	—	—	—	—	45.27	—	—	—	—
Water	53.82	52.64	55.36	54.90	49.43	54.23	54.90	55.36	55.00	50.00

TISSUE – EQUIVALENT LIQUID DESCRIPTION



**Table C.3—Suggested recipes for achieving target dielectric parameters:
2100 MHz to 5800 MHz**

Frequency (MHz)	2100	2100	2450	2450	3000	5200	5800
Reference	[B118]	[B196]	[B196]	[B172]	[B196]		
Ingredients (% by weight)							
1,2-Propanediol	—	—	—		—	—	—
Bactericide	—	—	—	0.50	—	—	—
Diacetin	—	—	—	49.75	—	—	—
DGBE	50.00	7.99	7.99	—	7.99	—	—
HEC	—	—	—	—	—	—	—
NaCl	—	0.16	0.16	—	0.16	—	—
Sucrose	—	—	—	—	—	—	—
Triton X-100	—	19.97	19.97	—	19.97	17.24	17.24
Diethylenglycol monohexylether	—	—	—	—	—	17.24	17.24
Water	50.00	71.88	71.88	49.75	71.88	65.52	65.52

BODY

Frequency (MHz)	30	50		144		450		835	900	
Recipe source number	3	3	2	2	3	2	4	2	2	4
Ingredients (% by weight)										
Deionised water	48,30	48,30	53,53	55,12	48,30	48,53	56	50,36	50,31	56
Tween			44,70	43,31		49,51		48,39	48,34	
Oxidised mineral oil							44			44
Diethylenglycol monohexylether										
Triton X-100										
Diacetin	50,00	50,00		50,00						
DGBE										
NaCl	1,60	1,60	1,77	1,57	1,60	1,96		1,25	1,35	
Additives and salt	0,10	0,10			0,10					

Frequency (MHz)	1 800		2 450	4 000	5 000	5 200	5 800	6 000
Recipe source number	2	4	4	4	4	1	1	4
Ingredients (% by weight)								
Deionised water	54,23	56	56	56	56	65,53	65,53	56
Tween	45,27							
Oxidised mineral oil		44	44	44	44			44
Diethylenglycol monohexylether						17,24	17,24	
Triton X-100						17,24	17,24	
Diacetin								
DGBE								
NaCl	0,50							
Additives and salt								

TISSUE – EQUIVALENT LIQUID



Date:	07/20/2018	Temperature:	23.8°C
Tissue:	Body, MSL2450, 2450MHz	Liquid Temperature:	23.5°C
Tested By:	Ethan Schoonover	Relative Humidity:	42.7
Job Site:	EV08	Bar. Pressure:	1023

TEST SPECIFICATIONS

Specification:	Method:
FCC 2.1093:2018	FCC KDB 865664 D01 v01r04 FCC KDB 865664 D02 v01r02 IEEE Std 1528:2013

RESULTS

Frequency (MHz)	Actual Values		Target Values		Deviation (%)	
	Relative Permittivity	Conductivity	Relative Permittivity	Conductivity	Relative Permittivity	Conductivity
2450	50.97	2.028	52.7	1.95	3.28	-4

Frequency (MHz)	Relative Permittivity	Conductivity
2000	52.54	1.433
2000	52.54	1.433
2050	52.36	1.494
2100	52.15	1.557
2100	52.15	1.557
2150	51.95	1.622
2200	51.78	1.688
2250	51.62	1.755
2250	51.62	1.755
2300	51.46	1.823
2350	51.3	1.891
2400	51.14	1.959
2400	51.14	1.959
2450	50.97	2.028
2500	50.8	2.098
2550	50.63	2.168
2550	50.63	2.168
2600	50.45	2.24
2650	50.27	2.313
2700	50.09	2.387
2700	50.09	2.387
2750	49.91	2.463
2800	49.73	2.542
2850	49.55	2.62
2850	49.55	2.62
2900	49.37	2.696
2950	49.18	2.772

SAR SYSTEM VERIFICATION DESCRIPTION



REQUIREMENT

Per IEEE 1528, Section 8.2.1, “System checks are performed prior to compliance tests and the results must always be within $\pm 10\%$ of the target value corresponding to the test frequency, liquid, and the source used. The target values are 1 g or 10 g averaged SAR values measured on systems having current system validation and calibration status, and using the system check setup as shown in Figure 14. These target values should be determined using a standard source.”

TEST DESCRIPTION

Within 24 hours of a measurement, then every 72 hours thereafter, Element used the system validation kit (calibrated reference dipole) to test whether the system was operating within its specifications. The validation was performed in the indicated bands by making SAR measurements of the reference dipole with the phantom filled with the tissue-equivalent liquid. First, a signal generator and power amplifier were used to produce a 100mW level as measured with a power meter at the antenna terminals of the dipole (X). Then, the reference dipole was positioned below the bottom of the phantom and centered with its axis parallel to the longest side of the phantom. A low loss and low relative permittivity spacer was used to establish the correct distance between the center axis of the reference dipole and the liquid.

For the reference dipoles, the spacing distance s is given by:

$s = 15\text{mm}$, $\pm 0.2\text{mm}$ for $300\text{MHz} \leq f \leq 1000 \text{ MHz}$:

$s = 10\text{mm}$, $\pm 0.2\text{mm}$ for $1000\text{MHz} \leq f \leq 6000\text{MHz}$

The measured 1 g and 10 g spatial average SAR values were normalized to a 1W dipole input power for comparison to the calibration data. The results are summarized in the attached table. The deviation is less than 10% in all cases, indicating that the system performance check was within tolerance.

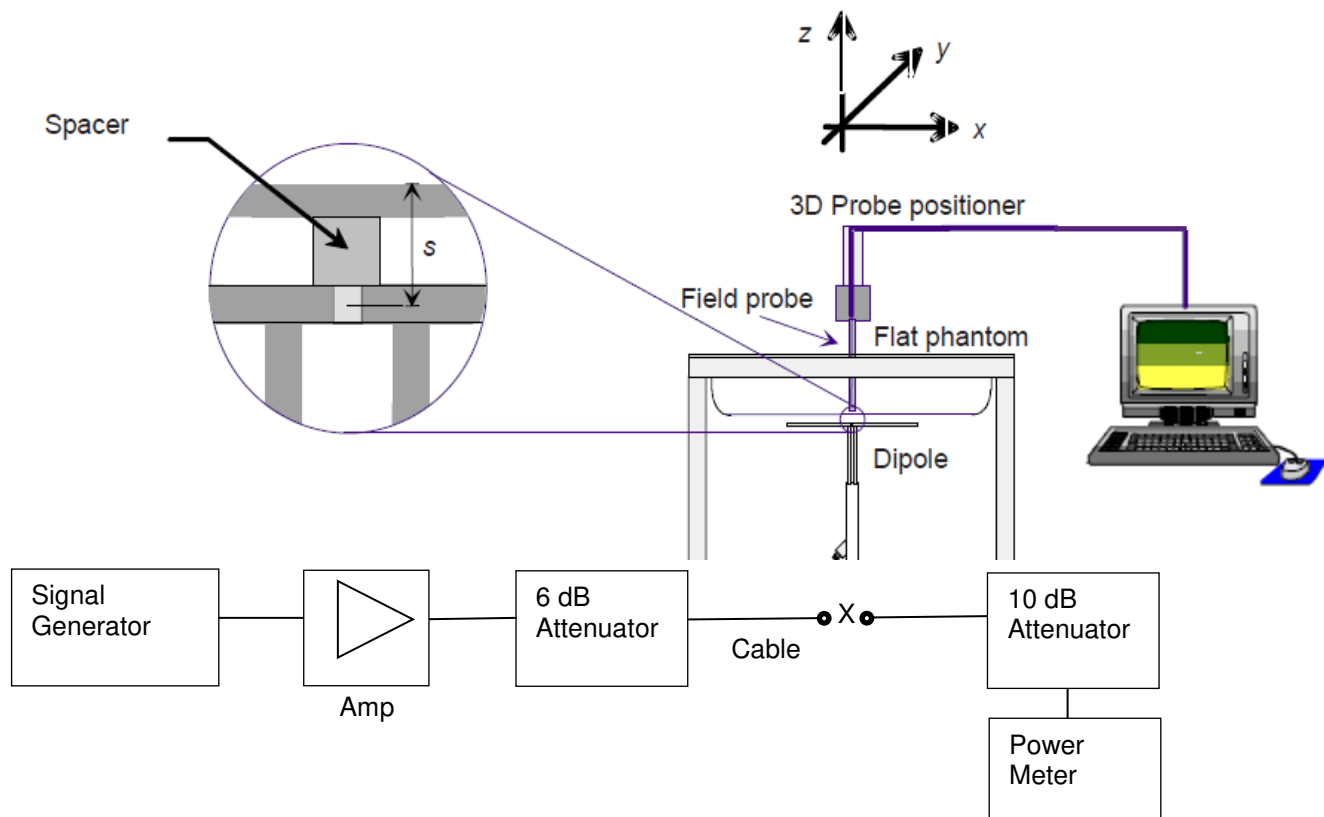

SAR SYSTEM VERIFICATION



TEST SPECIFICATIONS

Specification:	Method:
FCC 2.1093:2018	FCC KDB 865664 D01 v01r04 FCC KDB 865664 D02 v01r02 IEEE Std 1528:2013

RESULTS

Date	Liquid part number and frequency	Conducted Power into the Dipole (dBm)	Correction Factor	Measured		Normalized to 1W		Target (Normalized to 1W) Get from Dipole Calibration Certificate		% Difference	
				1g	10g	1g	10g	1g	10g	1g	10g
7/20/2018	MSL 2450 (2450 MHz)	20.03	9.93	5.40	2.56	53.62	25.42	50.90	24.00	5.34	5.92

SAR SYSTEM VERIFICATION



Tested By:	Ethan Schoonover	Room Temperature (°C):	23.9°C
Date:	7/20/2018	Liquid Temperature (°C):	22.8°C
Configuration:	N/A	Humidity (%RH):	40.7%
		Bar. Pressure (mb):	1023 mb

MSL2450 System Check 7-20-18

DUT: Dipole 2450 MHz D2450V2; Type: D2450V2; Serial: D2450V2

Communication System: UID 10000, CW; Communication System Band: D2450 (2450.0 MHz); Frequency: 2450 MHz; Communication System PAR: 0 dB; PMF: 1

Medium parameters used: $f = 2450$ MHz; $\sigma = 2.028$ S/m; $\epsilon_r = 50.971$; $\rho = 1000$ kg/m³, Medium parameters used: $\sigma = 0$ S/m, $\epsilon_r = 1$; $\rho = 1000$ kg/m³

Phantom section: Flat Section

Measurement Standard: DASYS5 (IEEE/IEC/ANSI C63.19-2007)

DASY Configuration:

- Probe: EX3DV4 - SN3746; ConvF(7.02, 7.02, 7.02); Calibrated: 11/15/2017;
 - Modulation Compensation:
- Sensor-Surface: 5mm (Mechanical Surface Detection), Sensor-Surface: 0mm (Fix Surface), $z = 1.0, 101.0, 31.0$
- Electronics: DAE4 Sn1237; Calibrated: 11/7/2017
- Phantom: ELI v5.0; Type: QDOVA002AA
- DASYS2 52.8.8(1258); SEMCAD X 14.6.10(7373)

System Check/System Check/Area Scan (51x61x1): Interpolated grid: $dx=1.000$ mm, $dy=1.000$ mm

Maximum value of SAR (interpolated) = 5.82 W/kg

System Check/System Check/Z Scan (1x1x21): Measurement grid: $dx=20$ mm, $dy=20$ mm, $dz=5$ mm

Maximum value of Total (measured) = 63.01 V/m

System Check/System Check/Zoom Scan (7x7x7) (7x7x7)/Cube 0: Measurement grid: $dx=5$ mm, $dy=5$ mm, $dz=5$ mm



Reference Value = 52.24 V/m; Power Drift = -0.01 dB

Peak SAR (extrapolated) = 10.5 W/kg

SAR(1 g) = 5.4 W/kg; SAR(10 g) = 2.56 W/kg

Maximum value of SAR (measured) = 5.48 W/kg

Maximum value of SAR (measured) = 8.05 W/kg



 Approved By

SAR SYSTEM VERIFICATION

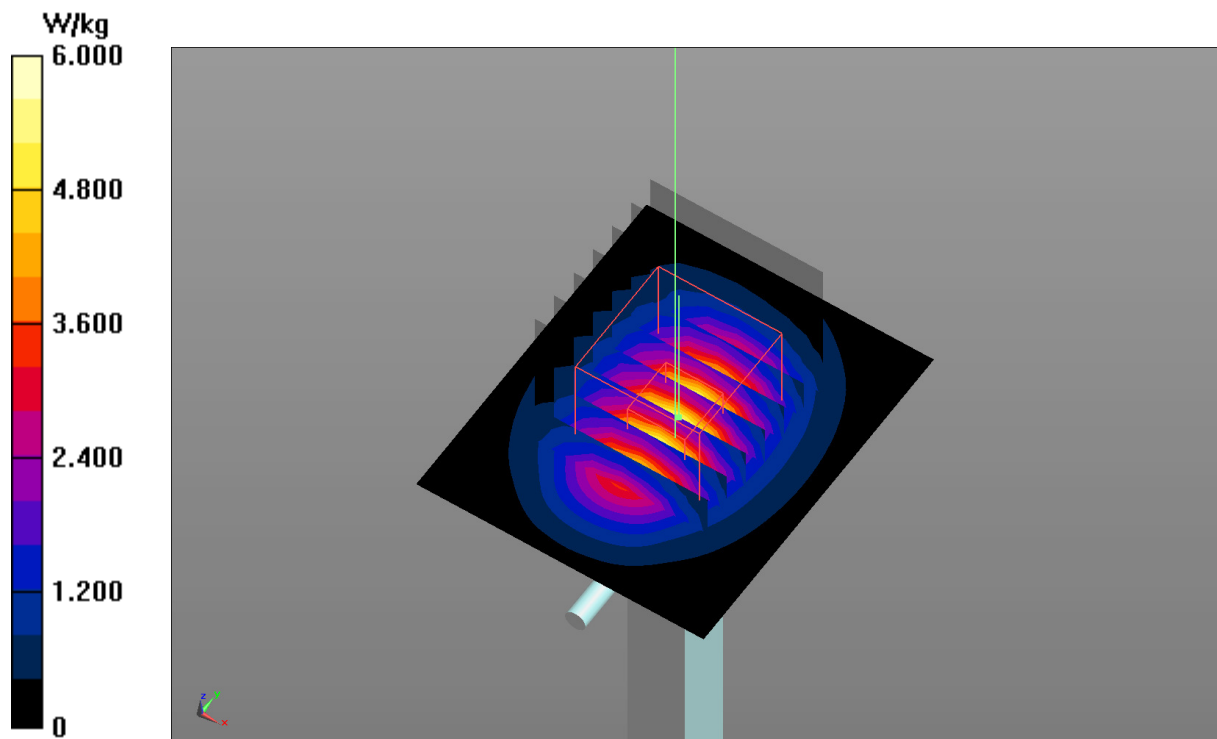

MSL2450 System Check 7-20-18



OUTPUT POWER DESCRIPTION



2.4 GHz Bluetooth Band

Per FCC KDB 248227, the conducted output power was measured at the lowest, a middle, and highest channel in each band. Measurements were made while the EUT transmitted at the lowest, middle and the highest data rates for each channel.

Per FCC KDB 248227, among the channels required for normal testing, SAR was measured on the highest output channel. When the SAR measured on the highest output channel was >0.8 W/kg, SAR evaluation for the other required test channels was necessary.

Output power measurements are on the following pages.

OUTPUT POWER



TbTx 2017.12.14 XMt 2017.12.13

EUT: Multi-Function Accessory		Work Order: STAK0117		
Serial Number: 182010051A		Date: 26-Jun-18		
Customer: Starkey Laboratories, Inc.		Temperature: 22 °C		
Attendees: Charlie Esch		Humidity: 57.8% RH		
Project: None		Barometric Pres.: 1012 mbar		
Tested by: Dustin Sparks		Power: Battery		
		Job Site: MN08		
TEST SPECIFICATIONS				
FCC 2.1093:2018		Test Method		
		FCC KDB 865664 D01 v01r04		
		FCC KDB 865664 D02 v01r02		
		IEEE Std 1528:2013		
COMMENTS				
None				
DEVIATIONS FROM TEST STANDARD				
None				
Configuration #	7	Signature <i>Dustin Sparks</i>		
		Signature		
		Value		
		Limit (<)		
		Result		
DM5, GFSK	Low Channel	334.57 uW	125 mW	Pass
	Mid Channel	1.169 mW	125 mW	Pass
	High Channel	572.75 uW	125 mW	Pass
2DH5, pi/4-DQPSK	Low Channel	266.32 uW	125 mW	Pass
	Mid Channel	980.53 uW	125 mW	Pass
	High Channel	507.33 uW	125 mW	Pass
3DH5, 8-DPSK	Low Channel	321.02 uW	125 mW	Pass
	Mid Channel	1.079 mW	125 mW	Pass
	High Channel	548.78 uW	125 mW	Pass

OUTPUT POWER



TMTx 2017.12.14 XMI 2017.12.13

DM5, GFSK, Low Channel						
				Value	Limit (<)	Result
				334.57 μ W	125 mW	Pass

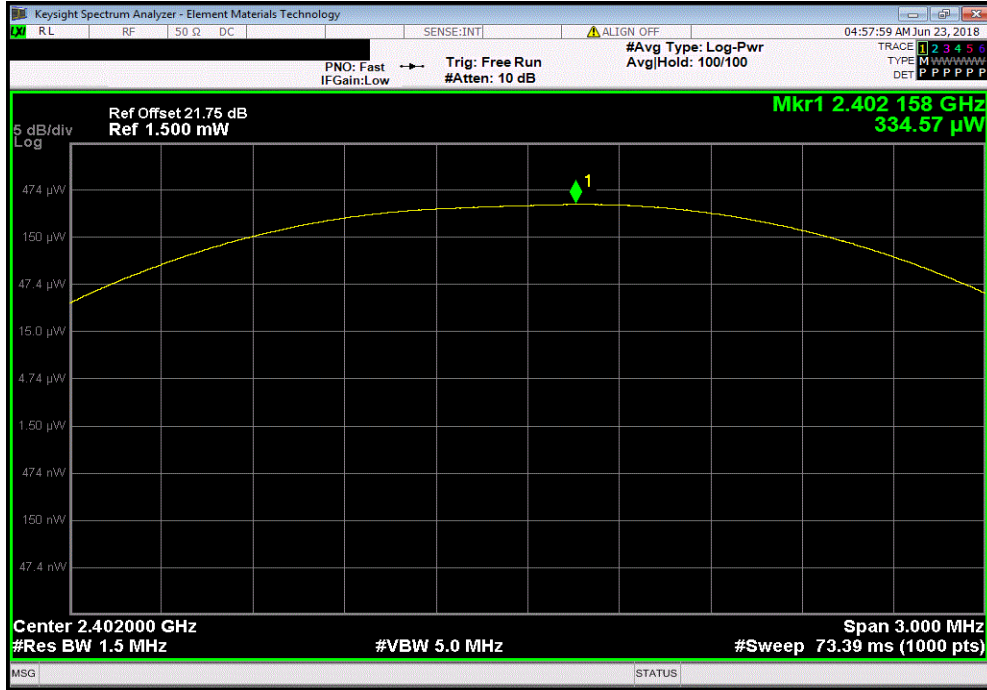

DM5, GFSK, Mid Channel						
				Value	Limit (<)	Result
				1.169 mW	125 mW	Pass

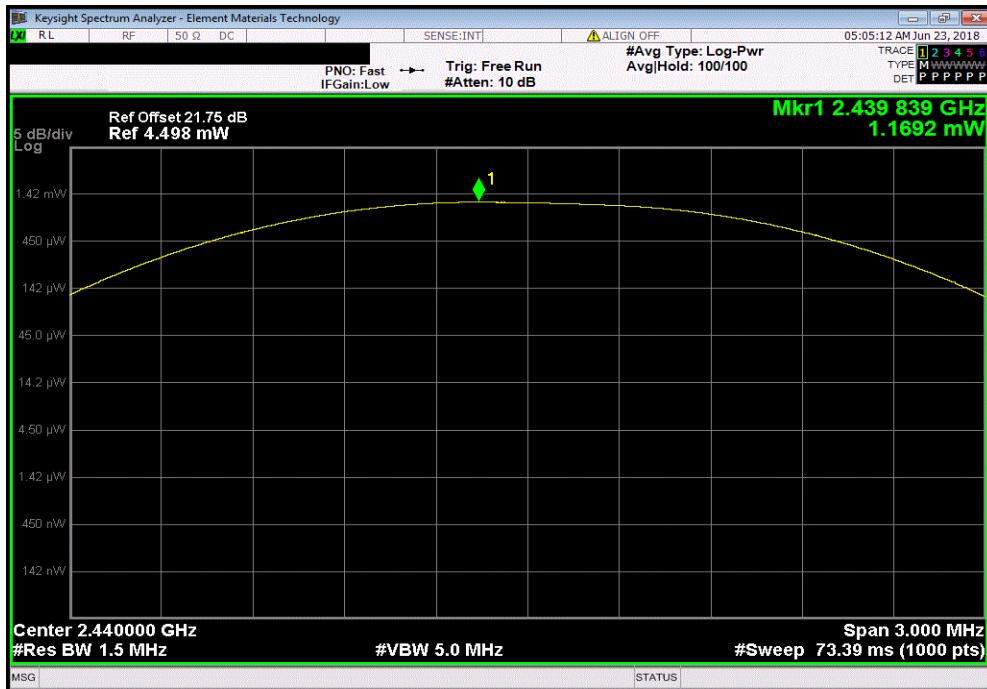

OUTPUT POWER



TMTx 2017.12.14 XMI 2017.12.13

DM5, GFSK, High Channel				Value	Limit (<)	Result
				572.75 μ W	125 mW	Pass

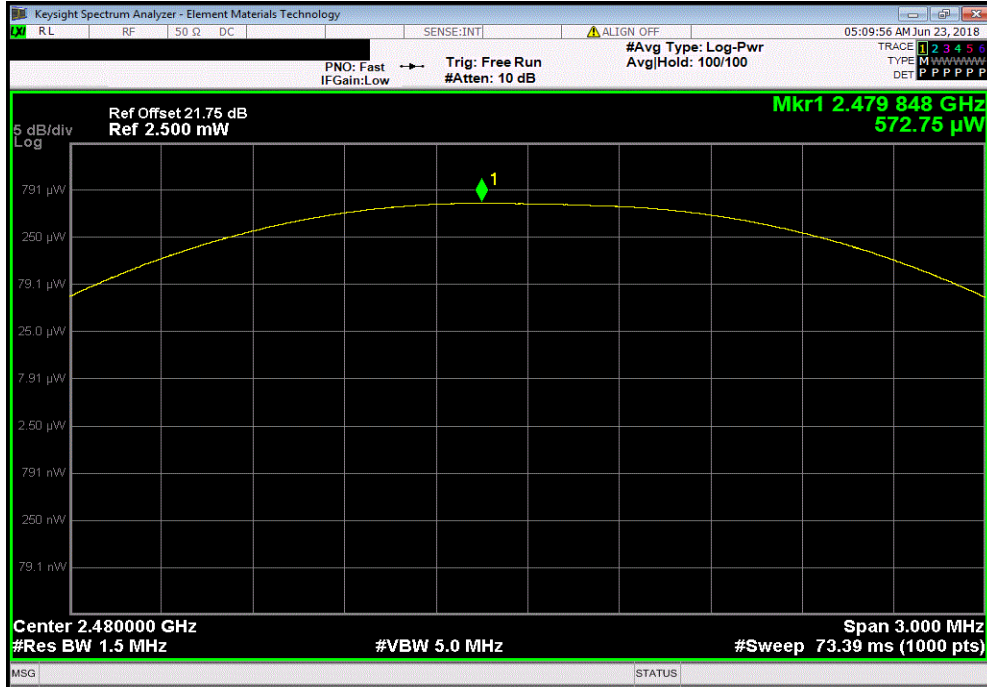

2DH5, pi/4-DQPSK, Low Channel				Value	Limit (<)	Result
				266.32 μ W	125 mW	Pass

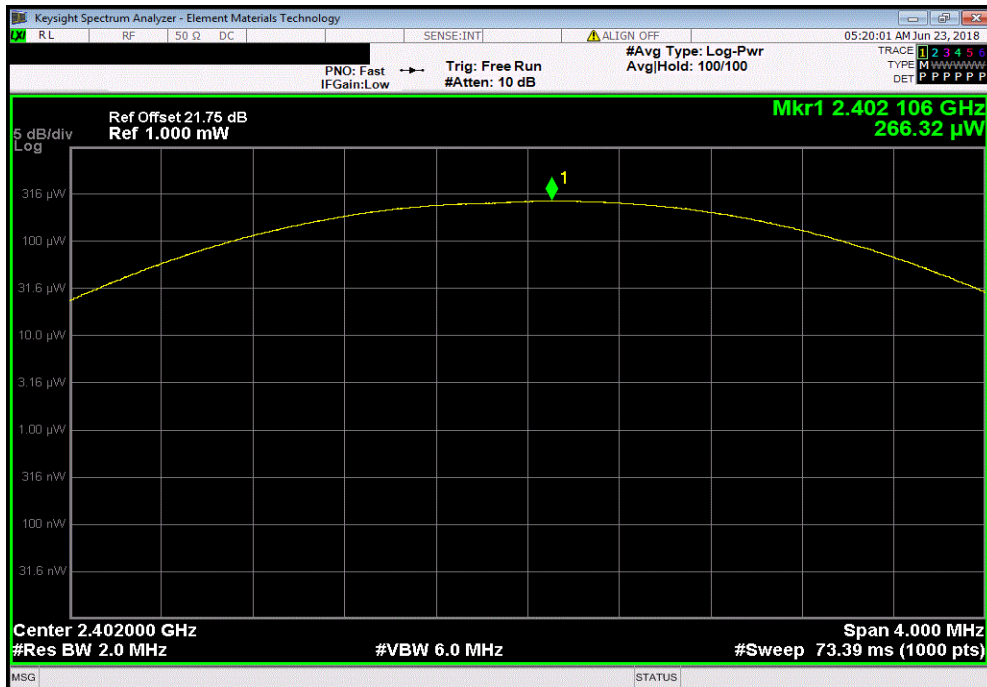

OUTPUT POWER



TMTx 2017.12.14 XMI 2017.12.13

2DH5, pi/4-DQPSK, Mid Channel				Value	Limit	Result
				980.53 uW	(<) 125 mW	Pass

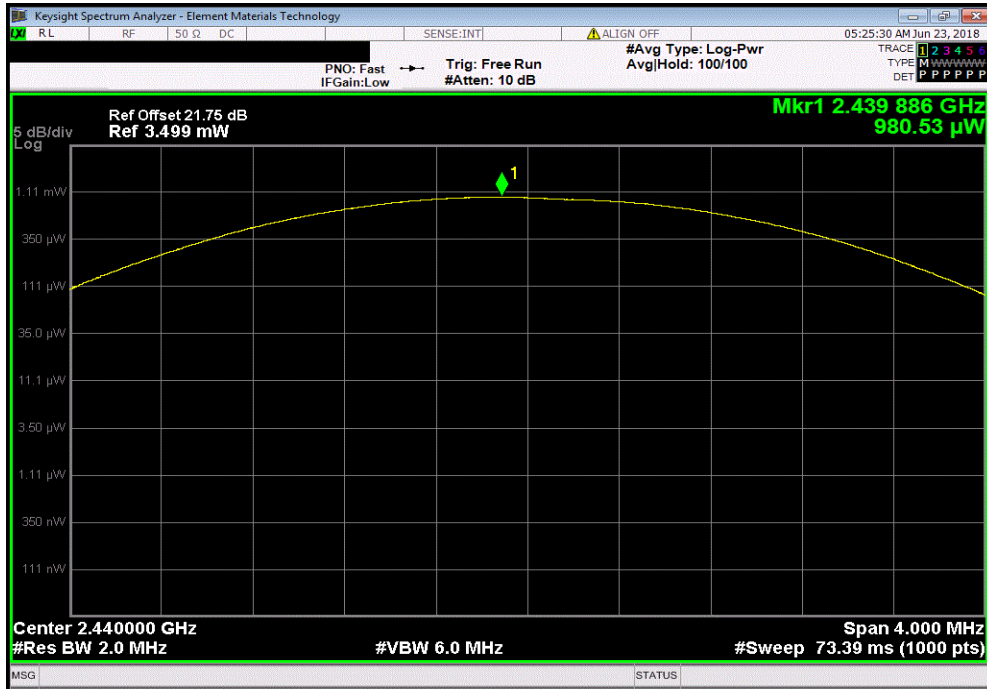

2DH5, pi/4-DQPSK, High Channel				Value	Limit	Result
				507.33 uW	(<) 125 mW	Pass

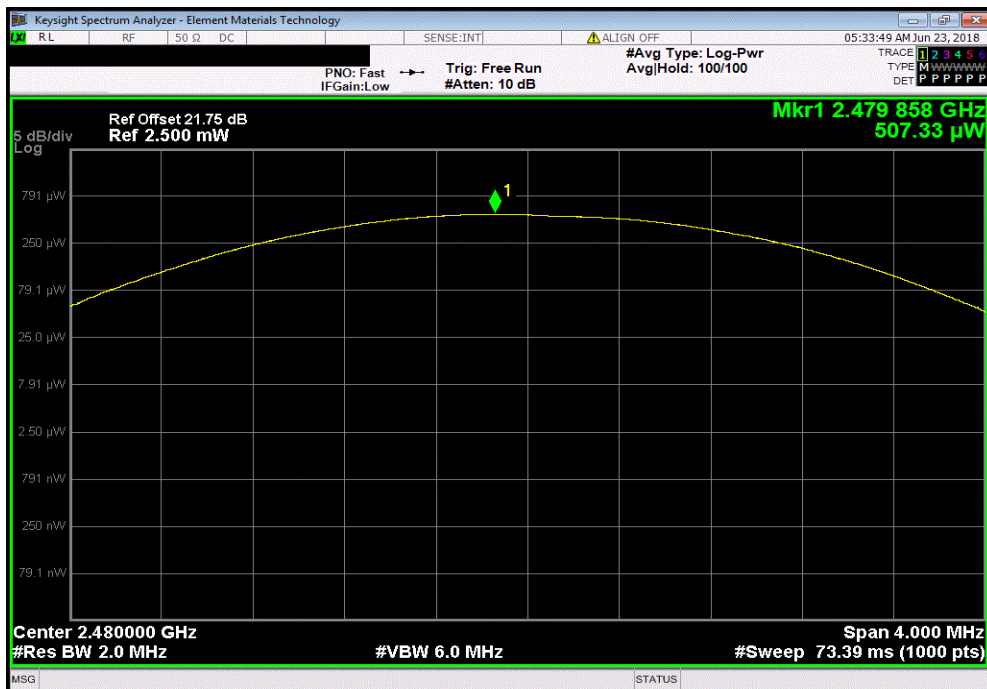

OUTPUT POWER



TMTx 2017.12.14 XMI 2017.12.13

3DH5, 8-DPSK, Low Channel						
				Value	Limit (<)	Result
				321.02 μ W	125 mW	Pass

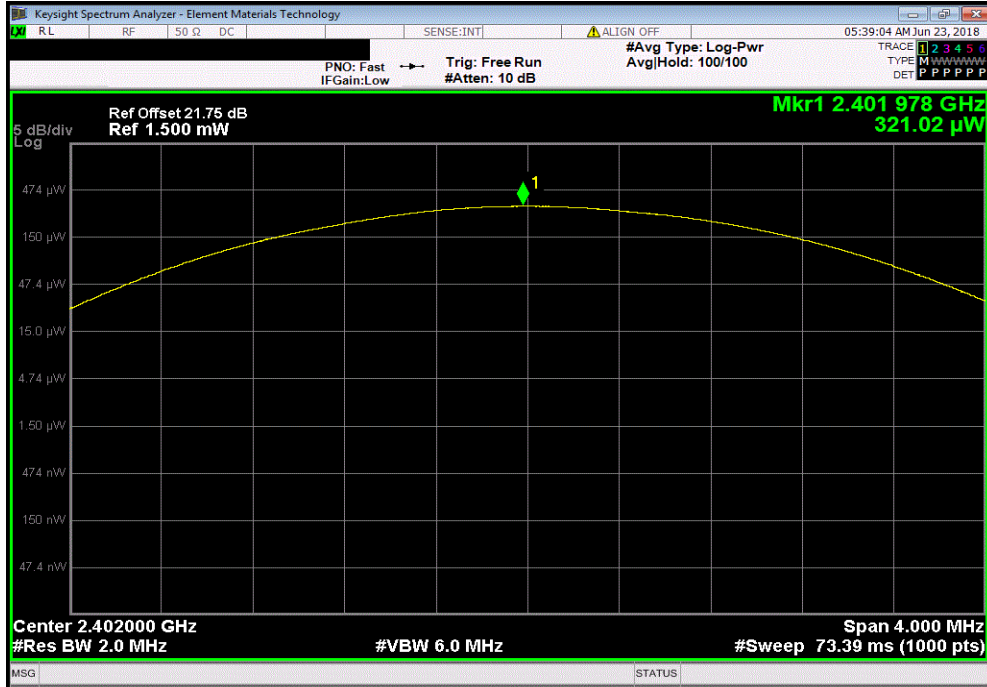

3DH5, 8-DPSK, Mid Channel						
				Value	Limit (<)	Result
				1.079 mW	125 mW	Pass

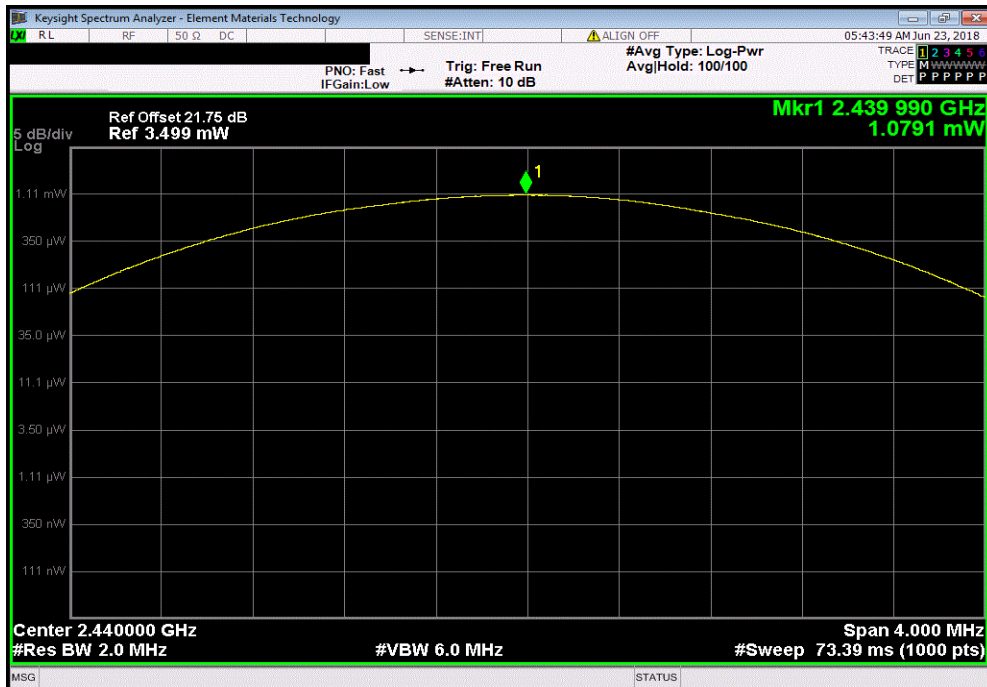

OUTPUT POWER



TMTx 2017.12.14 XMI 2017.12.13

3DH5, 8-DPSK, High Channel						
	Value	Limit	Result			
	548.78 μ W	125 mW	Pass			

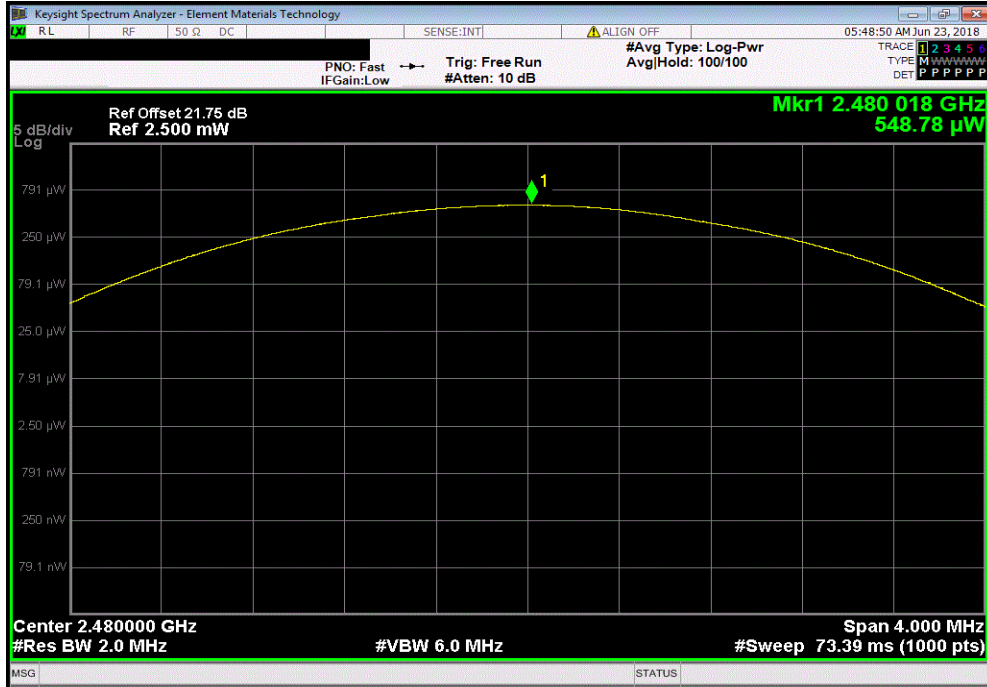

TEST RESULTS



Test Configurations

Test Locations

All available sides were tested. The EUT will be used with a clip. All six sides were measured with a clip. Testing was done with a 0 cm spacing to the phantom.

Summary

The following table summarizes the measured SAR values. The EUT was transmitting at nearly 100% duty cycle.

Per FCC KDB 447498, the measured SAR values were scaled to the maximum tune-up tolerance limit. The results are referred to as the "Reported SAR" values. The measured SAR data was scaled by a factor of 0.86 to calculate the reported SAR values. The following formula was used to calculate the linear SAR scaling factor:

$$\begin{aligned} \text{SAR scaling factor} &= 10^{((\text{Maximum Rated Power}^1 \text{ (dBm)} - \text{Measured Power (dBm)}) / 10)} \\ &= 10^{((0 \text{ dBm}) - (0.8554 \text{ dBm})) / 10} \\ &= 0.86 \end{aligned}$$

Per FCC KDB 447498, SAR must be measured on the channel with the highest conducted output power. When the SAR measured on the highest output channel is >0.8 W/kg, SAR evaluation for the other required test channels is necessary.

SAR TEST DATA



EUT:	Multi-Function Accessory	Work Order:	STAK0117
Customer:	Starkey Laboratories, Inc.	Job Site:	EV08
Attendees:	None	Customer Project:	None

TEST SPECIFICATIONS

Specification:	Method:
FCC 2.1093:2018	FCC KDB 865664 D01 v01r04 FCC KDB 865664 D02 v01r02 FCC KDB 447498 D01 v06 IEEE Std 1528:2013

COMMENTS

None

DEVIATIONS FROM TEST STANDARD

None

RESULTS

Test Configuration	Frequency Band	Transmit Frequency (MHz)	Transmit Channel	Modulation	EUT Position	Power Drift During Test (dB)	Measured 1g SAR Level (mW/g)	Measured 10g SAR Level (mW/g)	Scaling Factor	Scaled 1g SAR Level (mW/g)	Scaled 10g SAR Level (mW/g)	Test #
Body	2.4	2440	Mid	DM5, GFSK	Right	-2.91	0.000	0.000	0.86	0.000	0.000	1
Body	2.4	2440	Mid	DM5, GFSK	Left	*	0.003	0.001	0.86	0.003	0.001	2
Body	2.4	2440	Mid	DM5, GFSK	Front	*	0.003	0.001	0.86	0.003	0.001	3
Body	2.4	2440	Mid	DM5, GFSK	Back	*	0.004	0.001	0.86	0.003	0.001	4
Body	2.4	2440	Mid	DM5, GFSK	Bottom	*	0.004	0.002	0.86	0.003	0.001	5
Body	2.4	2440	Mid	DM5, GFSK	Top	*	0.003	0.002	0.86	0.002	0.001	6

SAR TEST DATA



WSTD.2016.12.19

Tested By:	Ethan Schoonover	Room Temperature (°C):	24.2
Date:	7/20/2018 11:09:04 AM	Liquid Temperature (°C):	21.6
Serial Number:	182010051A	Humidity (%RH):	42.7
Configuration:	STAK0117-1	Bar. Pressure (mb):	1023
Comments:	None		

Test 1

DUT: Remote microphone device; Type: Clip; Serial: 182010051A

Communication System: UID 0, CW; Communication System Band: D2450 (2450.0 MHz); Frequency: 2440 MHz; Communication System PAR: 0 dB; PMF: 1

Medium parameters used (interpolated): $f = 2440$ MHz; $\sigma = 2.014$ S/m; $\epsilon_r = 51.004$; $\rho = 1000$ kg/m³, Medium parameters used: $\sigma = 0$ S/m, $\epsilon_r = 1$; $\rho = 1000$ kg/m³

Phantom section: Flat Section

Measurement Standard: DASYS5 (IEEE/IEC/ANSI C63.19-2007)

DASY Configuration:

- Probe: EX3DV4 - SN3746; ConvF(7.02, 7.02, 7.02); Calibrated: 11/15/2017;
 - Modulation Compensation:
- Sensor-Surface: 3mm (Mechanical Surface Detection), Sensor-Surface: 0mm (Fix Surface), $z = 31.0, 101.0$
- Electronics: DAE4 Sn1237; Calibrated: 11/7/2017
- Phantom: ELI v5.0; Type: QDOVA002AA
- DASYS52 52.8.8(1258); SEMCAD X 14.6.10(7373)

Body/Body/Zoom Scan (10x10x7)/Cube 0: Measurement grid: $dx=5$ mm, $dy=5$ mm, $dz=5$ mm

Reference Value = 0.7520 V/m; Power Drift = -2.91 dB

Peak SAR (extrapolated) = 0.00502 W/kg

SAR(1 g) = 7.5e-005 W/kg; SAR(10 g) = 8.63e-006 W/kg

[Info: Interpolated medium parameters used for SAR evaluation.](#)

Maximum value of SAR (measured) = 0.00502 W/kg

Body/Body/Area scan (51x51x1): Interpolated grid: $dx=1.200$ mm, $dy=1.200$ mm

[Info: Interpolated medium parameters used for SAR evaluation.](#)

Maximum value of SAR (interpolated) = 0.00747 W/kg

Body/Body/Z Scan (1x1x21): Measurement grid: $dx=20$ mm, $dy=20$ mm, $dz=5$ mm

[Info: Interpolated medium parameters used for SAR evaluation.](#)



Maximum value of Total (measured) = 0.7062 V/m

Body/Body/Reference scan (31x31x1): Interpolated grid: $dx=3.000$ mm, $dy=3.000$ mm

[Info: Interpolated medium parameters used for SAR evaluation.](#)

Maximum value of SAR (interpolated) = 0.00135 W/kg

Maximum value of SAR (measured) = 0.00100 W/kg



 Approved By

SAR TEST DATA

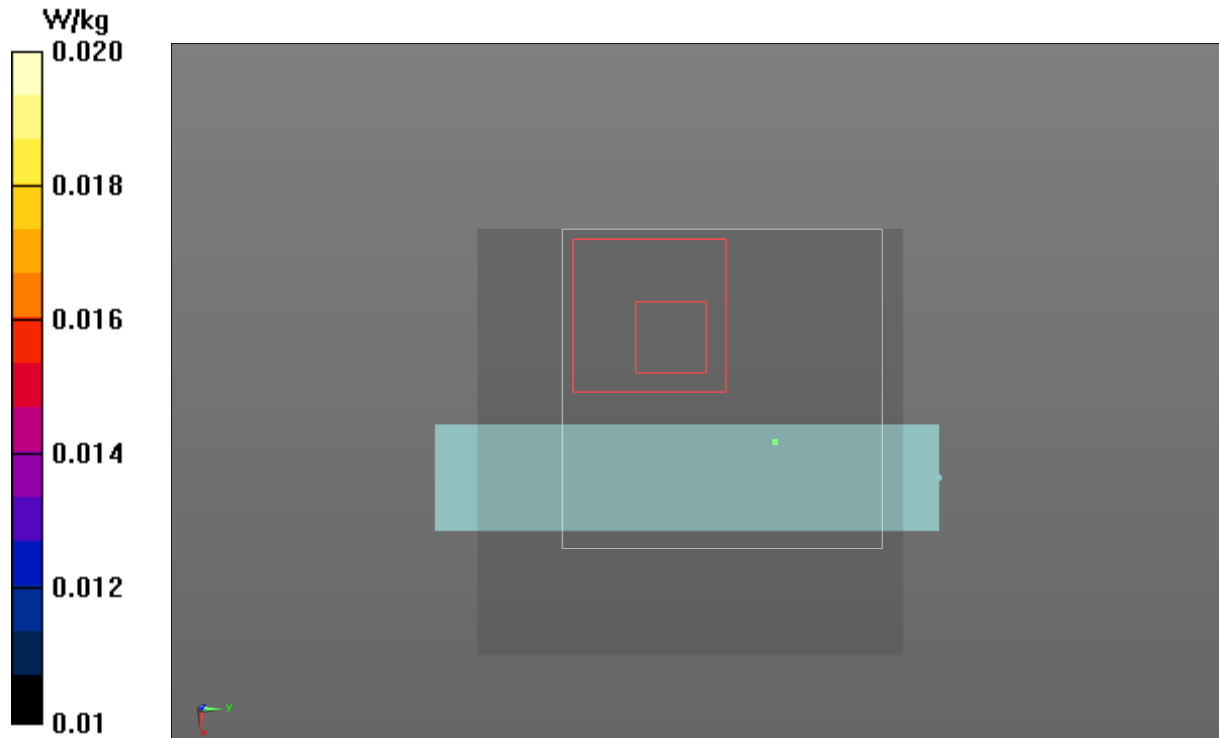

Test 1



SAR TEST DATA

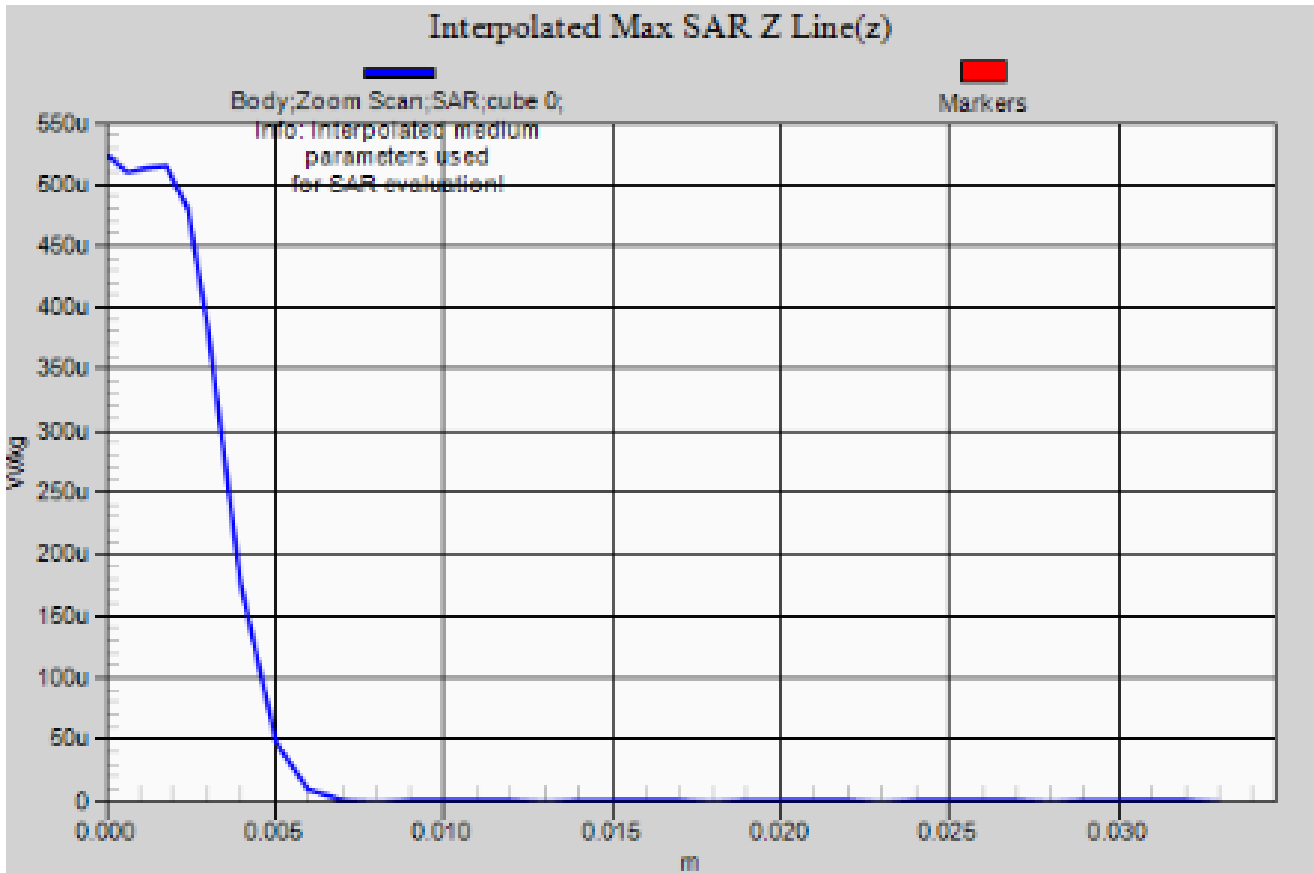

SYSTEM AND TEST SITE DESCRIPTION



SAR MEASUREMENT SYSTEM

Schmid & Partner Engineering AG, DASY52

Element selected the leader in SAR evaluation systems to provide the measurement tools for this evaluation. SPEAG's DASY52 is the fastest and most accurate scanner on the market. It is fully compatible with all world-wide standards for transmitters operating at the ear or within 20cm of the body. It provides full compatibility with IEC 62209-1, IEC 62209-2, IEEE 1528 as well as national adaptations such as FCC OET-65c and Korean Std. MIC #2000-93

The DASY52 system for performing compliance tests consists of the following items:

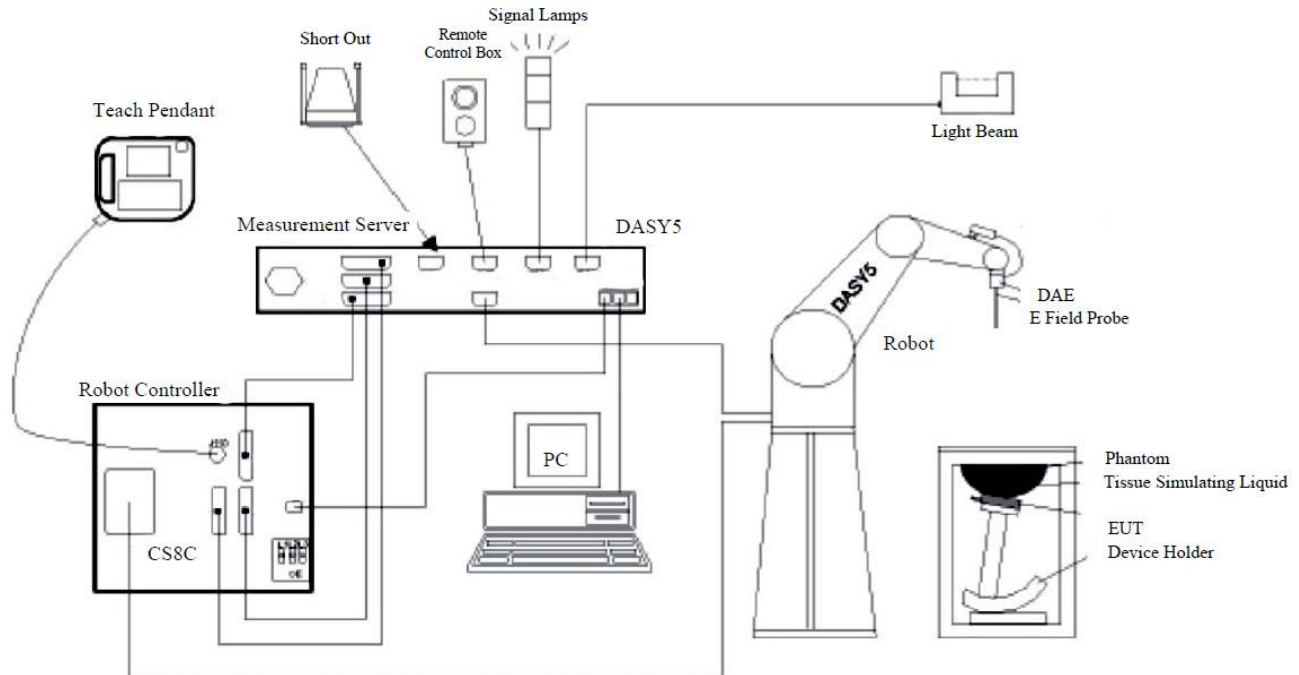

- A standard high precision 6-axis robot (Staubli TX=RX family) with controller, teach pendant and software. An arm extension for accommodating the data acquisition electronics (DAE).
- An isotropic field probe optimized and calibrated for the targeted measurement.
- A data acquisition electronics (DAE) which performs the signal amplification, signal multiplexing, AD-conversion, offset measurements, mechanical surface detection, collision detection, etc. The unit is battery powered with standard or rechargeable batteries. The signal is optically transmitted to the EOC.
- The Electro-optical converter (EOC) performs the conversion from optical to electrical signals for the digital communication to the DAE. To use optical surface detection, a special version of the EOC is required. The EOC signal is transmitted to the measurement server.
- The function of the measurement server is to perform the time critical tasks such as signal filtering, control of the robot operation and fast movement interrupts.
- The Light Beam used is for probe alignment. This improves the (absolute) accuracy of the probe positioning.
- A computer running WinXP and the DASY5 software.
- Remote control and teach pendant as well as additional circuitry for robot safety such as warning lamps, etc.
- The SAM twin phantom, oval flat phantom, device holder, tissue simulating liquids, and validation dipole kits.

SYSTEM AND TEST SITE DESCRIPTION



TEST SITE

Element, Lab EV08

The SAR measurement system is located in a semi-anechoic chamber. This provides an ambient free environment that also eliminates reflections.

The chamber is 12 ft wide by 16 ft long x 8 ft high. A dedicated HVAC unit provides +/- 1 degree C temperature control.

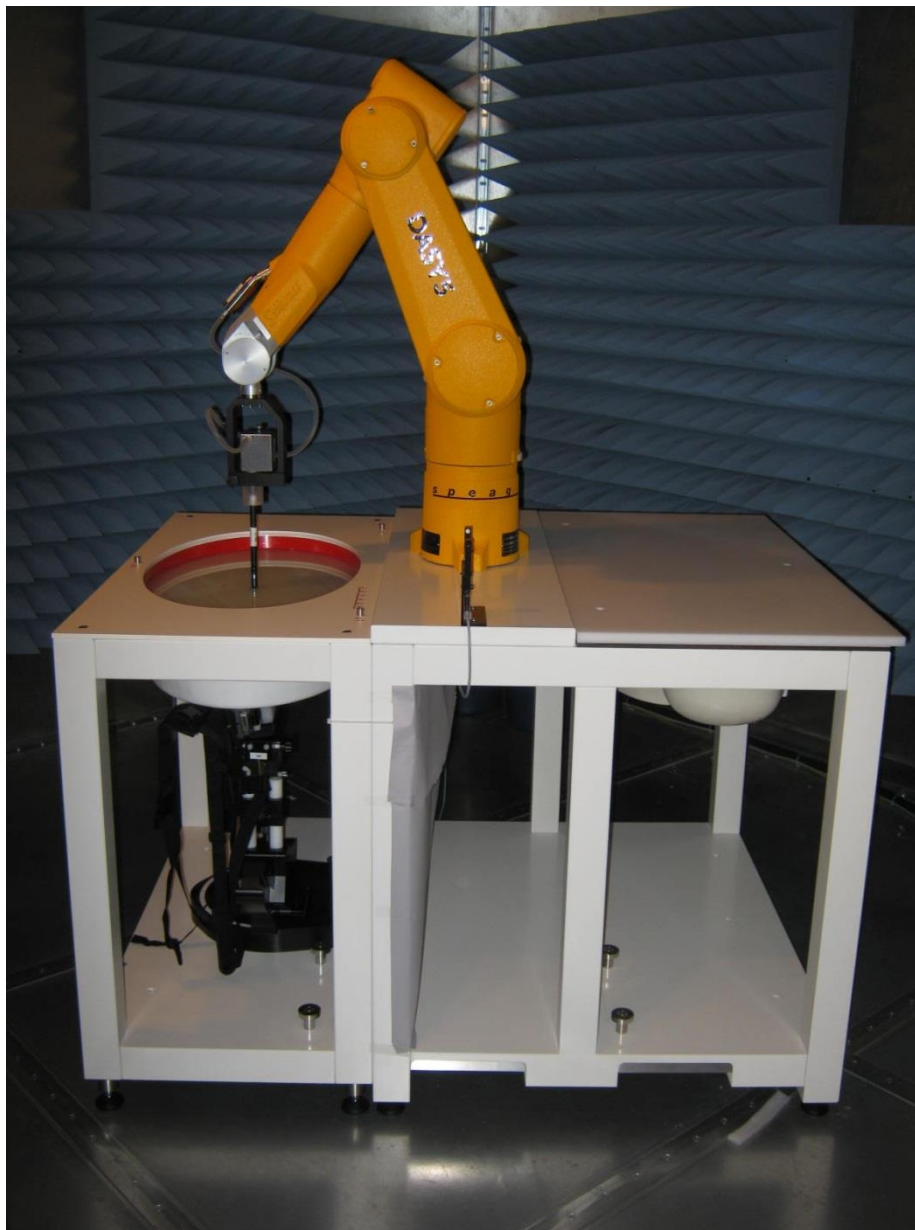



WSEQ.2016.12.19

TEST EQUIPMENT

TEST EQUIPMENT

Description	Manufacturer	Model	ID	Last Cal.	Interval
Amplifier	Mini Circuits	ZVE-3W-83+	TTA	NCR ¹	0 mo
Antenna - Dipole	SPEAG	D2450V2	ADL	11/7/2017	12 mo
DAE	SPEAG	SD 000 D04 EJ	SAH	11/7/2017	12 mo
Device Holder	SPEAG	N/A	SAW	NCR	0 mo
Dielectric Assessment Kit	SPEAG	DAKS:200	IPR	3/17/2016	36 mo
Generator - Signal	Agilent	V2920A	TIH	NCR	0 mo
Meter - Power	Agilent	N1913A	SQR	10/12/2017	12 mo
Power Sensor	Agilent	E9300H	SQO	10/12/2017	12 mo
Probe - Dielectric	SPEAG	DAKS-3.5	IPRA	11/1/2016	36 mo
Probe - SAR	SPEAG	EX3DV4	SAG	11/15/2017	12 mo
SAR - Tissue Test Solution	SPEAG	MSL 2450	SAM	At start of testing	
SAR Test System	Staeubli	DAYS5	SAK	11/1/2016	36 mo
SAR Test System	SPEAG	QD OVA 001 BB	SAC	NCR	0 mo
Thermometer	Omegaette	HH311	DTX	3/29/2018	36 mo

Note 1: The output of the signal generator / amplifier is verified with the calibrated power meter listed above.

MEASUREMENT UNCERTAINTY



MEASUREMENT UNCERTAINTY BUDGETS PER IEEE 1528:2013

300-3000 MHz Range

Uncertainty Component	Tolerance (+/- %)	Probability Distribution	Divisor	c_i (1g)	c_i (10g)	u_i (1g) (+/-%)	u_i (10g) (+/-%)	v_i
Measurement System								
Probe calibration (k=1)	5.5	normal	1	1	1	5.5	5.5	∞
Axial isotropy	4.7	rectangular	1.732	0.707	0.707	1.9	1.9	∞
Hemispherical isotropy	9.6	rectangular	1.732	0.707	0.707	3.9	3.9	∞
Boundary effect	1.0	rectangular	1.732	1	1	0.6	0.6	∞
Linearity	4.7	rectangular	1.732	1	1	2.7	2.7	∞
System detection limits	1.0	rectangular	1.732	1	1	0.6	0.6	∞
Readout electronics	0.3	normal	1	1	1	0.3	0.3	∞
Response time	0.8	rectangular	1.732	1	1	0.5	0.5	∞
Integration time	2.6	rectangular	1.732	1	1	1.5	1.5	∞
RF ambient conditions - noise	1.7	rectangular	1.732	1	1	1.0	1.0	∞
RF Ambient Reflections	0.0	rectangular	1.732	1	1	0.0	0.0	∞
Probe positioner mechanical tolerance	0.4	rectangular	1.732	1	1	0.2	0.2	∞
Probe positioner with respect to phantom shell	2.9	rectangular	1.732	1	1	1.7	1.7	∞
Extrapolation, interpolation, and integration algorithms for max. SAR evaluation	1.0	rectangular	1.732	1	1	0.6	0.6	∞
Test Sample Related								
Device Positioning	2.9	normal	1	1	1	2.9	2.9	145
Device Holder	3.6	normal	1	1	1	3.6	3.6	5
Power Drift	5.0	rectangular	1.732	1	1	2.9	2.9	∞
Phantom and tissue parameters								
Phantom Uncertainty - shell thickness tolerances	4.0	rectangular	1.732	1	1	2.3	2.3	∞
Liquid conductivity - deviation from target values	5.0	rectangular	1.732	0.64	0.43	1.8	1.2	∞
Liquid conductivity - measurement uncertainty	6.5	normal	1	0.64	0.43	4.2	2.8	∞
Liquid permittivity - deviation from target values	5.0	rectangular	1.732	0.6	0.49	1.7	1.4	∞
Liquid permittivity - measurement uncertainty	3.2	normal	1	0.6	0.49	1.9	1.6	∞
Combined Standard Uncertainty	RSS					11.2	10.6	387
Expanded Measurement Uncertainty (95% Confidence/	normal (k=2)					22.5	21.2	

**Calibration Laboratory of
Schmid & Partner
Engineering AG**
Zeughausstrasse 43, 8004 Zurich, Switzerland



S Schweizerischer Kalibrierdienst
C Service suisse d'étalonnage
S Servizio svizzero di taratura
S Swiss Calibration Service

Accredited by the Swiss Accreditation Service (SAS)
The Swiss Accreditation Service is one of the signatories to the EA
Multilateral Agreement for the recognition of calibration certificates

Accreditation No.: **SCS 0108**

Client **Element**

Certificate No: **D2450V2-855_Nov17**

CALIBRATION CERTIFICATE

Object **D2450V2 - SN:855**

Calibration procedure(s) **QA CAL-05.v9
Calibration procedure for dipole validation kits above 700 MHz**

Calibration date: **November 07, 2017**

This calibration certificate documents the traceability to national standards, which realize the physical units of measurements (SI).
The measurements and the uncertainties with confidence probability are given on the following pages and are part of the certificate.

All calibrations have been conducted in the closed laboratory facility: environment temperature (22 ± 3)°C and humidity < 70%.

Calibration Equipment used (M&TE critical for calibration)

Primary Standards	ID #	Cal Date (Certificate No.)	Scheduled Calibration
Power meter NRP	SN: 104778	04-Apr-17 (No. 217-02521/02522)	Apr-18
Power sensor NRP-Z91	SN: 103244	04-Apr-17 (No. 217-02521)	Apr-18
Power sensor NRP-Z91	SN: 103245	04-Apr-17 (No. 217-02522)	Apr-18
Reference 20 dB Attenuator	SN: 5058 (20k)	07-Apr-17 (No. 217-02528)	Apr-18
Type-N mismatch combination	SN: 5047.2 / 06327	07-Apr-17 (No. 217-02529)	Apr-18
Reference Probe EX3DV4	SN: 7349	31-May-17 (No. EX3-7349_May17)	May-18
DAE4	SN: 601	26-Oct-17 (No. DAE4-601_Oct17)	Oct-18

Secondary Standards	ID #	Check Date (in house)	Scheduled Check
Power meter EPM-442A	SN: GB37480704	07-Oct-15 (in house check Oct-16)	In house check: Oct-18
Power sensor HP 8481A	SN: US37292783	07-Oct-15 (in house check Oct-16)	In house check: Oct-18
Power sensor HP 8481A	SN: MY41092317	07-Oct-15 (in house check Oct-16)	In house check: Oct-18
RF generator R&S SMT-06	SN: 100972	15-Jun-15 (in house check Oct-16)	In house check: Oct-18
Network Analyzer HP 8753E	SN: US37390585	18-Oct-01 (in house check Oct-17)	In house check: Oct-18

Calibrated by:	Name Leif Klysner	Function Laboratory Technician	Signature
Approved by:	Name Katja Pokovic	Function Technical Manager	

Issued: November 8, 2017

This calibration certificate shall not be reproduced except in full without written approval of the laboratory.



Accredited by the Swiss Accreditation Service (SAS)

Accreditation No.: **SCS 0108**

The Swiss Accreditation Service is one of the signatories to the EA
Multilateral Agreement for the recognition of calibration certificates

Glossary:

TSL	tissue simulating liquid
ConvF	sensitivity in TSL / NORM x,y,z
N/A	not applicable or not measured

Calibration is Performed According to the Following Standards:

- IEEE Std 1528-2013, "IEEE Recommended Practice for Determining the Peak Spatial-Averaged Specific Absorption Rate (SAR) in the Human Head from Wireless Communications Devices: Measurement Techniques", June 2013
- IEC 62209-1, "Measurement procedure for the assessment of Specific Absorption Rate (SAR) from hand-held and body-mounted devices used next to the ear (frequency range of 300 MHz to 6 GHz)", July 2016
- IEC 62209-2, "Procedure to determine the Specific Absorption Rate (SAR) for wireless communication devices used in close proximity to the human body (frequency range of 30 MHz to 6 GHz)", March 2010
- KDB 865664, "SAR Measurement Requirements for 100 MHz to 6 GHz"

Additional Documentation:

- DASY4/5 System Handbook

Methods Applied and Interpretation of Parameters:

- Measurement Conditions:** Further details are available from the Validation Report at the end of the certificate. All figures stated in the certificate are valid at the frequency indicated.
- Antenna Parameters with TSL:** The dipole is mounted with the spacer to position its feed point exactly below the center marking of the flat phantom section, with the arms oriented parallel to the body axis.
- Feed Point Impedance and Return Loss:** These parameters are measured with the dipole positioned under the liquid filled phantom. The impedance stated is transformed from the measurement at the SMA connector to the feed point. The Return Loss ensures low reflected power. No uncertainty required.
- Electrical Delay:** One-way delay between the SMA connector and the antenna feed point. No uncertainty required.
- SAR measured:** SAR measured at the stated antenna input power.
- SAR normalized:** SAR as measured, normalized to an input power of 1 W at the antenna connector.
- SAR for nominal TSL parameters:** The measured TSL parameters are used to calculate the nominal SAR result.

The reported uncertainty of measurement is stated as the standard uncertainty of measurement multiplied by the coverage factor $k=2$, which for a normal distribution corresponds to a coverage probability of approximately 95%.

Measurement Conditions

DASY system configuration, as far as not given on page 1.

DASY Version	DASY5	V52.10.0
Extrapolation	Advanced Extrapolation	
Phantom	Modular Flat Phantom	
Distance Dipole Center - TSL	10 mm	with Spacer
Zoom Scan Resolution	dx, dy, dz = 5 mm	
Frequency	2450 MHz \pm 1 MHz	

Head TSL parameters

The following parameters and calculations were applied.

	Temperature	Permittivity	Conductivity
Nominal Head TSL parameters	22.0 °C	39.2	1.80 mho/m
Measured Head TSL parameters	(22.0 \pm 0.2) °C	37.8 \pm 6 %	1.86 mho/m \pm 6 %
Head TSL temperature change during test	< 0.5 °C	----	----

SAR result with Head TSL

SAR averaged over 1 cm³ (1 g) of Head TSL	Condition	
SAR measured	250 mW input power	13.5 W/kg
SAR for nominal Head TSL parameters	normalized to 1W	52.7 W/kg \pm 17.0 % (k=2)

SAR averaged over 10 cm³ (10 g) of Head TSL	condition	
SAR measured	250 mW input power	6.26 W/kg
SAR for nominal Head TSL parameters	normalized to 1W	24.7 W/kg \pm 16.5 % (k=2)

Body TSL parameters

The following parameters and calculations were applied.

	Temperature	Permittivity	Conductivity
Nominal Body TSL parameters	22.0 °C	52.7	1.95 mho/m
Measured Body TSL parameters	(22.0 \pm 0.2) °C	51.5 \pm 6 %	2.02 mho/m \pm 6 %
Body TSL temperature change during test	< 0.5 °C	----	----

SAR result with Body TSL

SAR averaged over 1 cm³ (1 g) of Body TSL	Condition	
SAR measured	250 mW input power	13.0 W/kg
SAR for nominal Body TSL parameters	normalized to 1W	50.9 W/kg \pm 17.0 % (k=2)

SAR averaged over 10 cm³ (10 g) of Body TSL	condition	
SAR measured	250 mW input power	6.07 W/kg
SAR for nominal Body TSL parameters	normalized to 1W	24.0 W/kg \pm 16.5 % (k=2)

Appendix (Additional assessments outside the scope of SCS 0108)

Antenna Parameters with Head TSL

Impedance, transformed to feed point	53.3 Ω + 3.9 j Ω
Return Loss	- 26.1 dB

Antenna Parameters with Body TSL

Impedance, transformed to feed point	50.3 Ω + 5.1 j Ω
Return Loss	- 25.8 dB

General Antenna Parameters and Design

Electrical Delay (one direction)	1.157 ns
----------------------------------	----------

After long term use with 100W radiated power, only a slight warming of the dipole near the feedpoint can be measured.

The dipole is made of standard semirigid coaxial cable. The center conductor of the feeding line is directly connected to the second arm of the dipole. The antenna is therefore short-circuited for DC-signals. On some of the dipoles, small end caps are added to the dipole arms in order to improve matching when loaded according to the position as explained in the "Measurement Conditions" paragraph. The SAR data are not affected by this change. The overall dipole length is still according to the Standard.

No excessive force must be applied to the dipole arms, because they might bend or the soldered connections near the feedpoint may be damaged.

Additional EUT Data

Manufactured by	SPEAG
Manufactured on	November 10, 2009

DASY5 Validation Report for Head TSL

Date: 07.11.2017

Test Laboratory: SPEAG, Zurich, Switzerland

DUT: Dipole 2450 MHz; Type: D2450V2; Serial: D2450V2 - SN:855

Communication System: UID 0 - CW; Frequency: 2450 MHz

Medium parameters used: $f = 2450$ MHz; $\sigma = 1.86$ S/m; $\epsilon_r = 37.8$; $\rho = 1000$ kg/m³

Phantom section: Flat Section

Measurement Standard: DASY5 (IEEE/IEC/ANSI C63.19-2011)

DASY52 Configuration:

- Probe: EX3DV4 - SN7349; ConvF(8.12, 8.12, 8.12); Calibrated: 31.05.2017;
- Sensor-Surface: 1.4mm (Mechanical Surface Detection)
- Electronics: DAE4 Sn601; Calibrated: 26.10.2017
- Phantom: Flat Phantom 5.0 (front); Type: QD 000 P50 AA; Serial: 1001
- DASY52 52.10.0(1446); SEMCAD X 14.6.10(7417)

Dipole Calibration for Head Tissue/Pin=250 mW, d=10mm/Zoom Scan (7x7x7)/Cube 0:

Measurement grid: dx=5mm, dy=5mm, dz=5mm

Reference Value = 116.1 V/m; Power Drift = -0.04 dB

Peak SAR (extrapolated) = 27.6 W/kg

SAR(1 g) = 13.5 W/kg; SAR(10 g) = 6.26 W/kg

Maximum value of SAR (measured) = 22.5 W/kg

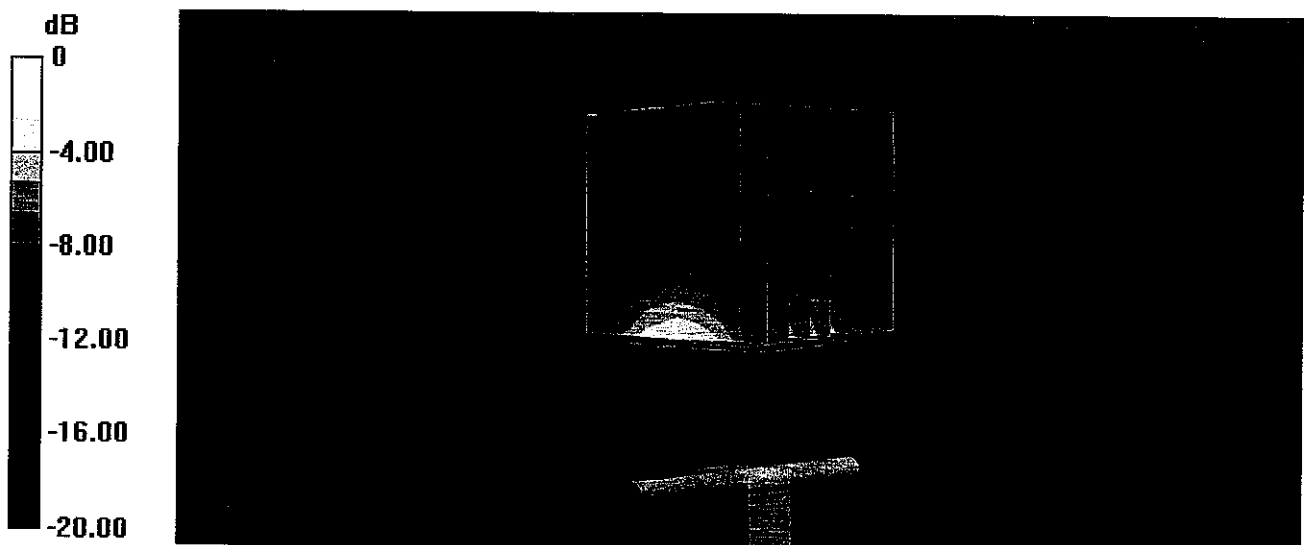

0 dB = 22.5 W/kg = 13.52 dBW/kg

Impedance Measurement Plot for Head TSL

7 Nov 2017 13:56:11
 [CH1] S11 1 U FS 1: 53.326 Ω 3.9180 Ω 254.52 pF 2 450.000 000 MHz

*
 De1
 CA
 Avg
 16
 H1d

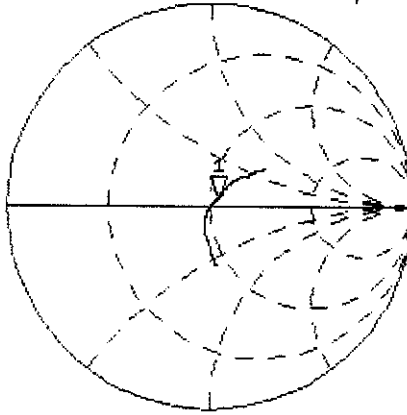

CH2 S11 LOG 5 dB/REF -20 dB 1:-26.058 dB 2 450.000 000 MHz

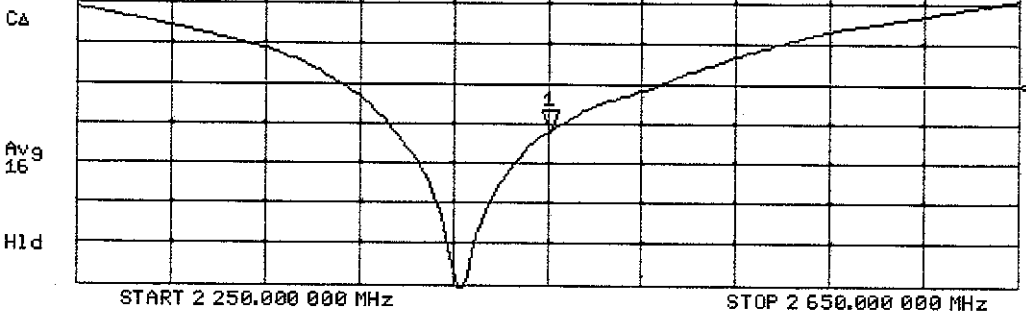

DASY5 Validation Report for Body TSL

Date: 07.11.2017

Test Laboratory: SPEAG, Zurich, Switzerland

DUT: Dipole 2450 MHz; Type: D2450V2; Serial: D2450V2 - SN:855

Communication System: UID 0 - CW; Frequency: 2450 MHz

Medium parameters used: $f = 2450$ MHz; $\sigma = 2.02$ S/m; $\epsilon_r = 51.5$; $\rho = 1000$ kg/m³

Phantom section: Flat Section

Measurement Standard: DASY5 (IEEE/IEC/ANSI C63.19-2011)

DASY52 Configuration:

- Probe: EX3DV4 - SN7349; ConvF(8.1, 8.1, 8.1); Calibrated: 31.05.2017;
- Sensor-Surface: 1.4mm (Mechanical Surface Detection)
- Electronics: DAE4 Sn601; Calibrated: 26.10.2017
- Phantom: Flat Phantom 5.0 (back); Type: QD 000 P50 AA; Serial: 1002
- DASY52 52.10.0(1446); SEMCAD X 14.6.10(7417)

Dipole Calibration for Body Tissue/Pin=250 mW, d=10mm/Zoom Scan (7x7x7)/Cube 0:

Measurement grid: dx=5mm, dy=5mm, dz=5mm

Reference Value = 106.7 V/m; Power Drift = -0.06 dB

Peak SAR (extrapolated) = 25.9 W/kg

SAR(1 g) = 13 W/kg; SAR(10 g) = 6.07 W/kg

Maximum value of SAR (measured) = 20.6 W/kg

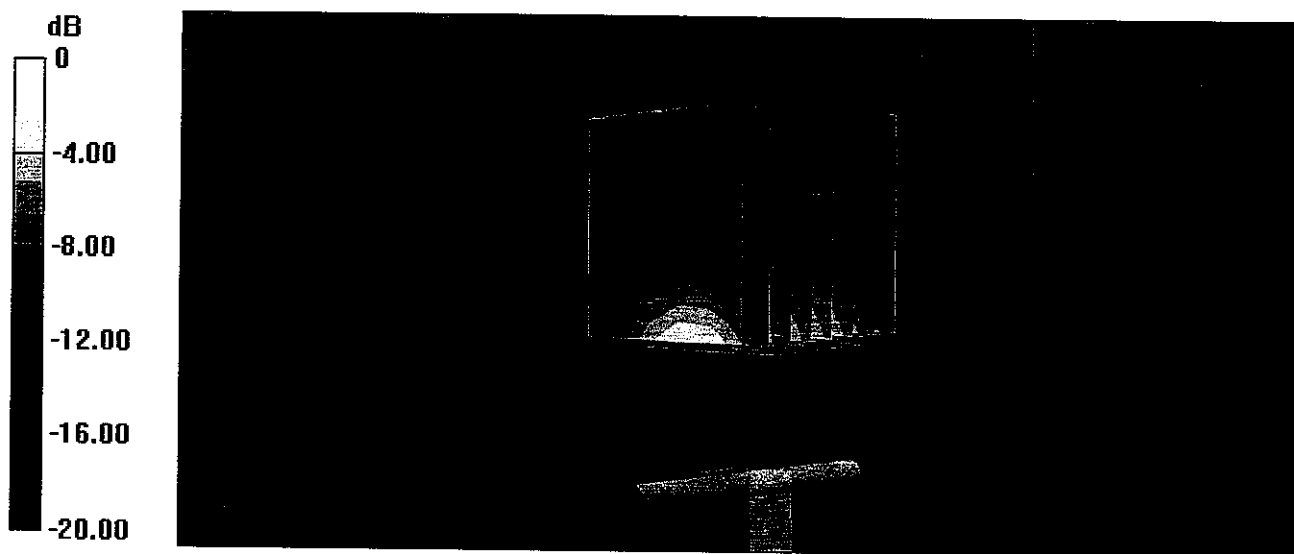

0 dB = 20.6 W/kg = 13.14 dBW/kg

Impedance Measurement Plot for Body TSL

7 Nov 2017 13:55:30

CH1 S11 1 U FS 1: 50.262 Ω 5.1445 Ω 334.19 μ H 2 450.000 000 MHz

*
De1
CA
Avg
16
H1d

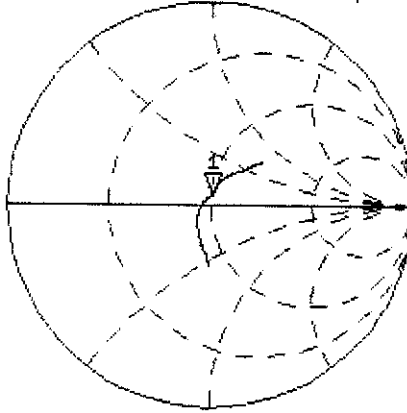

CH2 S11 LOG 5 dB/ REF -20 dB 1: -25.788 dB 2 450.000 000 MHz

CA
Avg
16
H1d

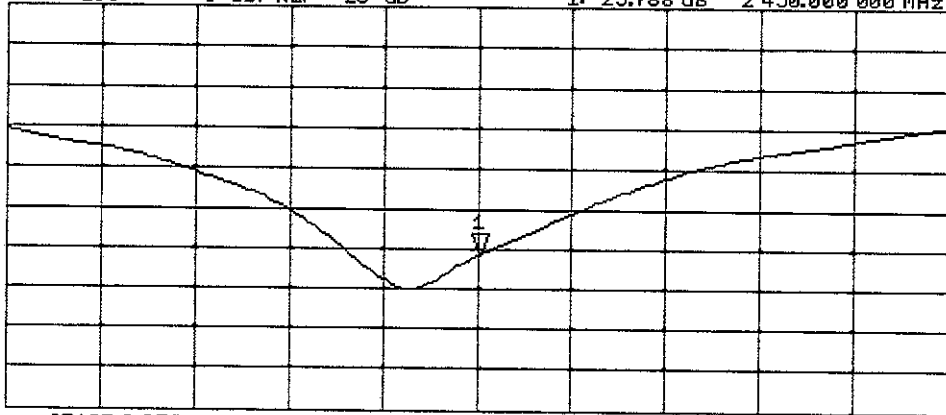

START 2 250.000 000 MHz

STOP 2 650.000 000 MHz

**Calibration Laboratory of
Schmid & Partner
Engineering AG**
Zeughausstrasse 43, 8004 Zurich, Switzerland



S Schweizerischer Kalibrierdienst
C Service suisse d'étalonnage
S Servizio svizzero di taratura
S Swiss Calibration Service

Accredited by the Swiss Accreditation Service (SAS)
The Swiss Accreditation Service is one of the signatories to the EA
Multilateral Agreement for the recognition of calibration certificates

Accreditation No.: **SCS 0108**

Client **Element**

Certificate No: **EX3-3746_Nov17**

CALIBRATION CERTIFICATE

Object **EX3DV4 - SN:3746**

Calibration procedure(s) **QA CAL-01.v9, QA CAL-14.v4, QA CAL-23.v5, QA CAL-25.v6
Calibration procedure for dosimetric E-field probes**

Calibration date: **November 15, 2017**

This calibration certificate documents the traceability to national standards, which realize the physical units of measurements (SI).
The measurements and the uncertainties with confidence probability are given on the following pages and are part of the certificate.

All calibrations have been conducted in the closed laboratory facility: environment temperature (22 ± 3)°C and humidity < 70%.

Calibration Equipment used (M&TE critical for calibration)

Primary Standards	ID	Cal Date (Certificate No.)	Scheduled Calibration
Power meter NRP	SN: 104778	04-Apr-17 (No. 217-02521/02522)	Apr-18
Power sensor NRP-Z91	SN: 103244	04-Apr-17 (No. 217-02521)	Apr-18
Power sensor NRP-Z91	SN: 103245	04-Apr-17 (No. 217-02525)	Apr-18
Reference 20 dB Attenuator	SN: S5277 (20x)	07-Apr-17 (No. 217-02528)	Apr-18
Reference Probe ES3DV2	SN: 3013	31-Dec-16 (No. ES3-3013_Dec16)	Dec-17
DAE4	SN: 660	7-Dec-16 (No. DAE4-660_Dec16)	Dec-17
Secondary Standards	ID	Check Date (in house)	Scheduled Check
Power meter E4419B	SN: GB41293874	06-Apr-16 (in house check Jun-16)	In house check: Jun-18
Power sensor E4412A	SN: MY41498087	06-Apr-16 (in house check Jun-16)	In house check: Jun-18
Power sensor E4412A	SN: 000110210	06-Apr-16 (in house check Jun-16)	In house check: Jun-18
RF generator HP 8648C	SN: US3642U01700	04-Aug-99 (in house check Jun-16)	In house check: Jun-18
Network Analyzer HP 8753E	SN: US37390585	18-Oct-01 (in house check Oct-17)	In house check: Oct-18

	Name	Function	Signature
Calibrated by:	Jeton Kastrati	Laboratory Technician	
Approved by:	Katja Pokovic	Technical Manager	

Issued: November 15, 2017

This calibration certificate shall not be reproduced except in full without written approval of the laboratory.



Accredited by the Swiss Accreditation Service (SAS)
The Swiss Accreditation Service is one of the signatories to the EA
Multilateral Agreement for the recognition of calibration certificates

Accreditation No.: **SCS 0108**

Glossary:

TSL	tissue simulating liquid
NORM _{x,y,z}	sensitivity in free space
ConvF	sensitivity in TSL / NORM _{x,y,z}
DCP	diode compression point
CF	crest factor (1/duty_cycle) of the RF signal
A, B, C, D	modulation dependent linearization parameters
Polarization ϕ	ϕ rotation around probe axis
Polarization ϑ	ϑ rotation around an axis that is in the plane normal to probe axis (at measurement center), i.e., $\vartheta = 0$ is normal to probe axis
Connector Angle	information used in DASY system to align probe sensor X to the robot coordinate system

Calibration is Performed According to the Following Standards:

- a) IEEE Std 1528-2013, "IEEE Recommended Practice for Determining the Peak Spatial-Averaged Specific Absorption Rate (SAR) in the Human Head from Wireless Communications Devices: Measurement Techniques", June 2013
- b) IEC 62209-1, "Measurement procedure for the assessment of Specific Absorption Rate (SAR) from hand-held and body-mounted devices used next to the ear (frequency range of 300 MHz to 6 GHz)", July 2016
- c) IEC 62209-2, "Procedure to determine the Specific Absorption Rate (SAR) for wireless communication devices used in close proximity to the human body (frequency range of 30 MHz to 6 GHz)", March 2010
- d) KDB 865664, "SAR Measurement Requirements for 100 MHz to 6 GHz"

Methods Applied and Interpretation of Parameters:

- **NORM_{x,y,z}**: Assessed for E-field polarization $\vartheta = 0$ ($f \leq 900$ MHz in TEM-cell; $f > 1800$ MHz: R22 waveguide). NORM_{x,y,z} are only intermediate values, i.e., the uncertainties of NORM_{x,y,z} does not affect the E²-field uncertainty inside TSL (see below ConvF).
- **NORM(f)_{x,y,z} = NORM_{x,y,z} * frequency_response** (see Frequency Response Chart). This linearization is implemented in DASY4 software versions later than 4.2. The uncertainty of the frequency response is included in the stated uncertainty of ConvF.
- **DCP_{x,y,z}**: DCP are numerical linearization parameters assessed based on the data of power sweep with CW signal (no uncertainty required). DCP does not depend on frequency nor media.
- **PAR**: PAR is the Peak to Average Ratio that is not calibrated but determined based on the signal characteristics
- **A_{x,y,z}; B_{x,y,z}; C_{x,y,z}; D_{x,y,z}; VR_{x,y,z}; A, B, C, D** are numerical linearization parameters assessed based on the data of power sweep for specific modulation signal. The parameters do not depend on frequency nor media. VR is the maximum calibration range expressed in RMS voltage across the diode.
- **ConvF and Boundary Effect Parameters**: Assessed in flat phantom using E-field (or Temperature Transfer Standard for $f \leq 800$ MHz) and inside waveguide using analytical field distributions based on power measurements for $f > 800$ MHz. The same setups are used for assessment of the parameters applied for boundary compensation (alpha, depth) of which typical uncertainty values are given. These parameters are used in DASY4 software to improve probe accuracy close to the boundary. The sensitivity in TSL corresponds to NORM_{x,y,z} * ConvF whereby the uncertainty corresponds to that given for ConvF. A frequency dependent ConvF is used in DASY version 4.4 and higher which allows extending the validity from ± 50 MHz to ± 100 MHz.
- **Spherical isotropy (3D deviation from isotropy)**: in a field of low gradients realized using a flat phantom exposed by a patch antenna.
- **Sensor Offset**: The sensor offset corresponds to the offset of virtual measurement center from the probe tip (on probe axis). No tolerance required.
- **Connector Angle**: The angle is assessed using the information gained by determining the NORM_x (no uncertainty required).

Probe EX3DV4

SN:3746

Manufactured: March 26, 2010
Calibrated: November 15, 2017

Calibrated for DASY/EASY Systems
(Note: non-compatible with DASY2 system!)

DASY/EASY - Parameters of Probe: EX3DV4 - SN:3746

Basic Calibration Parameters

	Sensor X	Sensor Y	Sensor Z	Unc (k=2)
Norm ($\mu\text{V}/(\text{V}/\text{m})^2$) ^A	0.48	0.45	0.48	$\pm 10.1 \%$
DCP (mV) ^B	96.8	101.0	93.1	

Modulation Calibration Parameters

UID	Communication System Name		A dB	B dB $\sqrt{\mu\text{V}}$	C	D dB	VR mV	Unc ^E (k=2)
0	CW	X	0.0	0.0	1.0	0.00	143.2	$\pm 3.5 \%$
		Y	0.0	0.0	1.0		144.2	
		Z	0.0	0.0	1.0		148.1	

The reported uncertainty of measurement is stated as the standard uncertainty of measurement multiplied by the coverage factor k=2, which for a normal distribution corresponds to a coverage probability of approximately 95%.

^A The uncertainties of Norm X,Y,Z do not affect the E²-field uncertainty inside TSL (see Pages 5 and 6).

^B Numerical linearization parameter: uncertainty not required.

^E Uncertainty is determined using the max. deviation from linear response applying rectangular distribution and is expressed for the square of the field value.

DASY/EASY - Parameters of Probe: EX3DV4 - SN:3746

Calibration Parameter Determined in Head Tissue Simulating Media

f (MHz) ^C	Relative Permittivity ^F	Conductivity (S/m) ^F	ConvF X	ConvF Y	ConvF Z	Alpha ^G	Depth ^G (mm)	Unc (k=2)
2300	39.5	1.67	7.32	7.32	7.32	0.34	0.85	± 12.0 %
2450	39.2	1.80	6.88	6.88	6.88	0.41	0.86	± 12.0 %
2550	39.1	1.91	6.86	6.86	6.86	0.40	0.82	± 12.0 %
5200	36.0	4.66	5.25	5.25	5.25	0.35	1.80	± 13.1 %
5300	35.9	4.76	5.05	5.05	5.05	0.35	1.80	± 13.1 %
5500	35.6	4.96	4.66	4.66	4.66	0.40	1.80	± 13.1 %
5600	35.5	5.07	4.61	4.61	4.61	0.40	1.80	± 13.1 %
5800	35.3	5.27	4.58	4.58	4.58	0.40	1.80	± 13.1 %

^C Frequency validity above 300 MHz of ± 100 MHz only applies for DASY v4.4 and higher (see Page 2), else it is restricted to ± 50 MHz. The uncertainty is the RSS of the ConvF uncertainty at calibration frequency and the uncertainty for the indicated frequency band. Frequency validity below 300 MHz is ± 10, 25, 40, 50 and 70 MHz for ConvF assessments at 30, 64, 128, 150 and 220 MHz respectively. Above 5 GHz frequency validity can be extended to ± 110 MHz.

^F At frequencies below 3 GHz, the validity of tissue parameters (ϵ and σ) can be relaxed to ± 10% if liquid compensation formula is applied to measured SAR values. At frequencies above 3 GHz, the validity of tissue parameters (ϵ and σ) is restricted to ± 5%. The uncertainty is the RSS of the ConvF uncertainty for indicated target tissue parameters.

^G Alpha/Depth are determined during calibration. SPEAG warrants that the remaining deviation due to the boundary effect after compensation is always less than ± 1% for frequencies below 3 GHz and below ± 2% for frequencies between 3-6 GHz at any distance larger than half the probe tip diameter from the boundary.

DASY/EASY - Parameters of Probe: EX3DV4 - SN:3746

Calibration Parameter Determined in Body Tissue Simulating Media

f (MHz) ^C	Relative Permittivity ^F	Conductivity (S/m) ^F	ConvF X	ConvF Y	ConvF Z	Alpha ^G	Depth (mm) ^G	Unc (k=2)
2300	52.9	1.81	7.22	7.22	7.22	0.41	0.88	± 12.0 %
2450	52.7	1.95	7.02	7.02	7.02	0.37	0.90	± 12.0 %
2550	52.6	2.09	6.88	6.88	6.88	0.34	0.92	± 12.0 %
5200	49.0	5.30	4.55	4.55	4.55	0.40	1.90	± 13.1 %
5300	48.9	5.42	4.39	4.39	4.39	0.40	1.90	± 13.1 %
5500	48.6	5.65	4.11	4.11	4.11	0.45	1.90	± 13.1 %
5600	48.5	5.77	3.95	3.95	3.95	0.45	1.90	± 13.1 %
5800	48.2	6.00	4.18	4.18	4.18	0.45	1.90	± 13.1 %

^C Frequency validity above 300 MHz of ± 100 MHz only applies for DASY v4.4 and higher (see Page 2), else it is restricted to ± 50 MHz. The uncertainty is the RSS of the ConvF uncertainty at calibration frequency and the uncertainty for the indicated frequency band. Frequency validity below 300 MHz is ± 10, 25, 40, 50 and 70 MHz for ConvF assessments at 30, 64, 128, 150 and 220 MHz respectively. Above 5 GHz frequency validity can be extended to ± 110 MHz.

^F At frequencies below 3 GHz, the validity of tissue parameters (ϵ and σ) can be relaxed to ± 10% if liquid compensation formula is applied to measured SAR values. At frequencies above 3 GHz, the validity of tissue parameters (ϵ and σ) is restricted to ± 5%. The uncertainty is the RSS of the ConvF uncertainty for indicated target tissue parameters.

^G Alpha/Depth are determined during calibration. SPEAG warrants that the remaining deviation due to the boundary effect after compensation is always less than ± 1% for frequencies below 3 GHz and below ± 2% for frequencies between 3-6 GHz at any distance larger than half the probe tip diameter from the boundary.

Frequency Response of E-Field

(TEM-Cell:ifi110 EXX, Waveguide: R22)

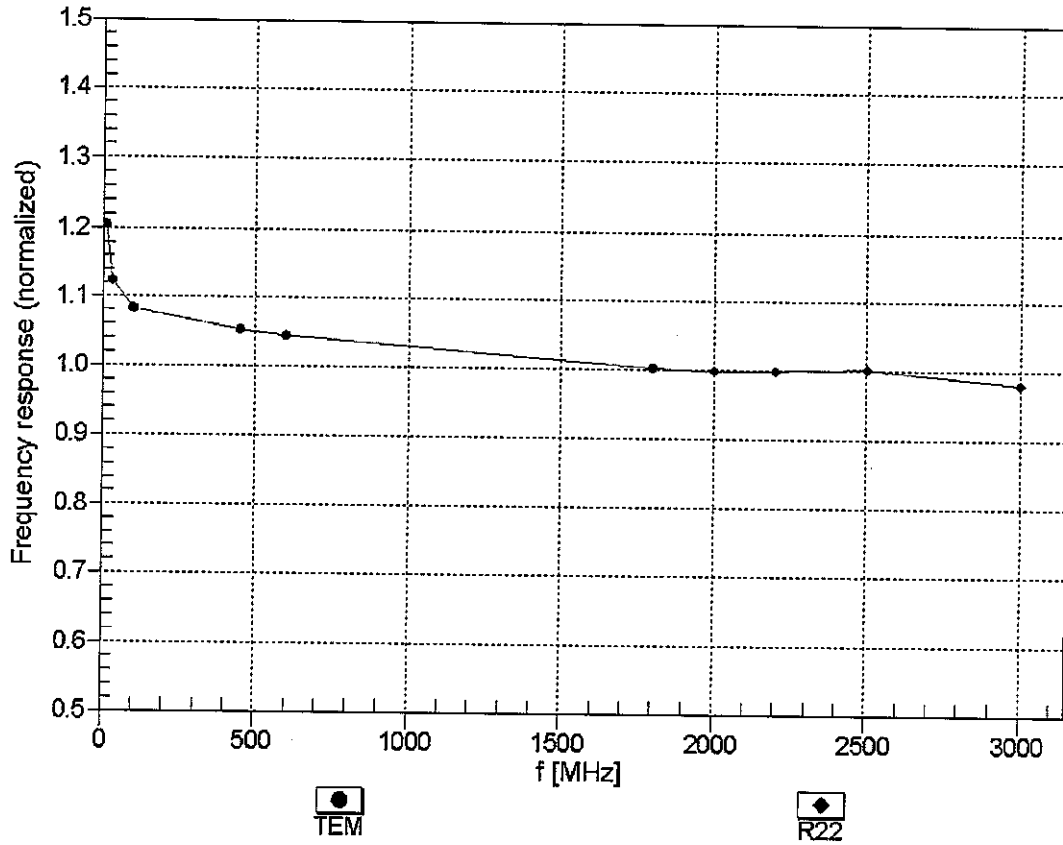

Uncertainty of Frequency Response of E-field: $\pm 6.3\%$ (k=2)

Receiving Pattern (ϕ), $\vartheta = 0^\circ$

f=600 MHz,TEM

f=1800 MHz,R22

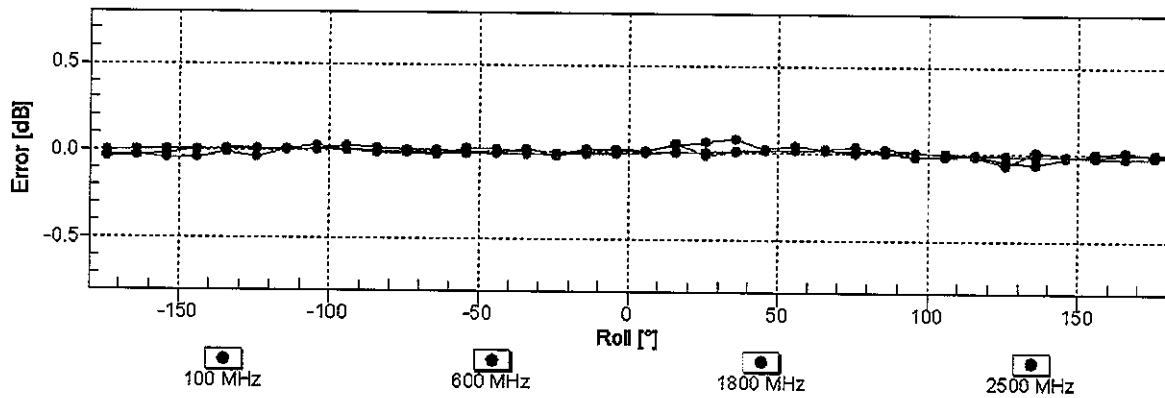
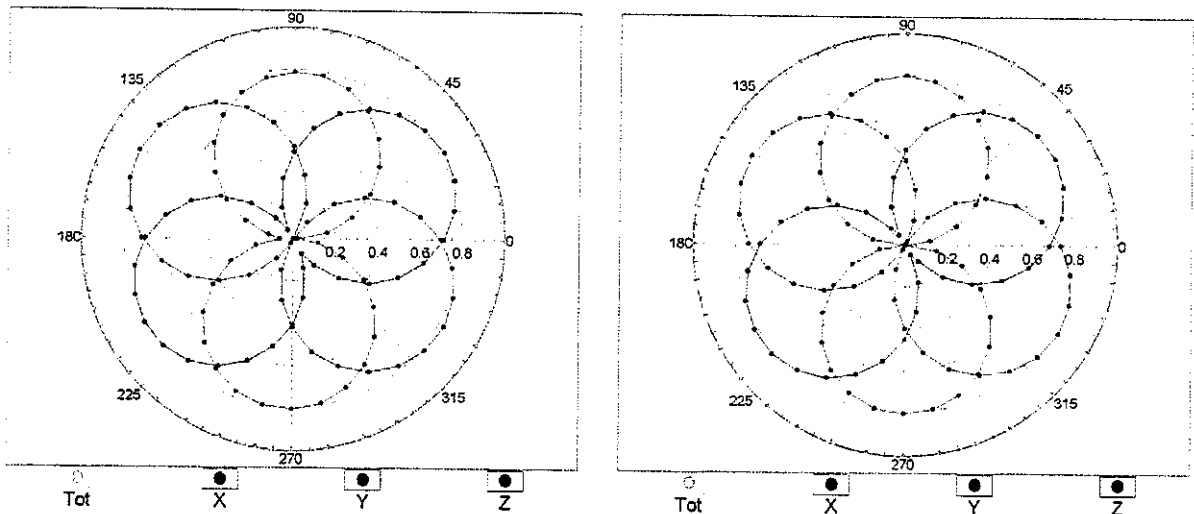

Uncertainty of Axial Isotropy Assessment: $\pm 0.5\%$ ($k=2$)

Dynamic Range f(SAR_{head}) (TEM cell , f_{eval}= 1900 MHz)

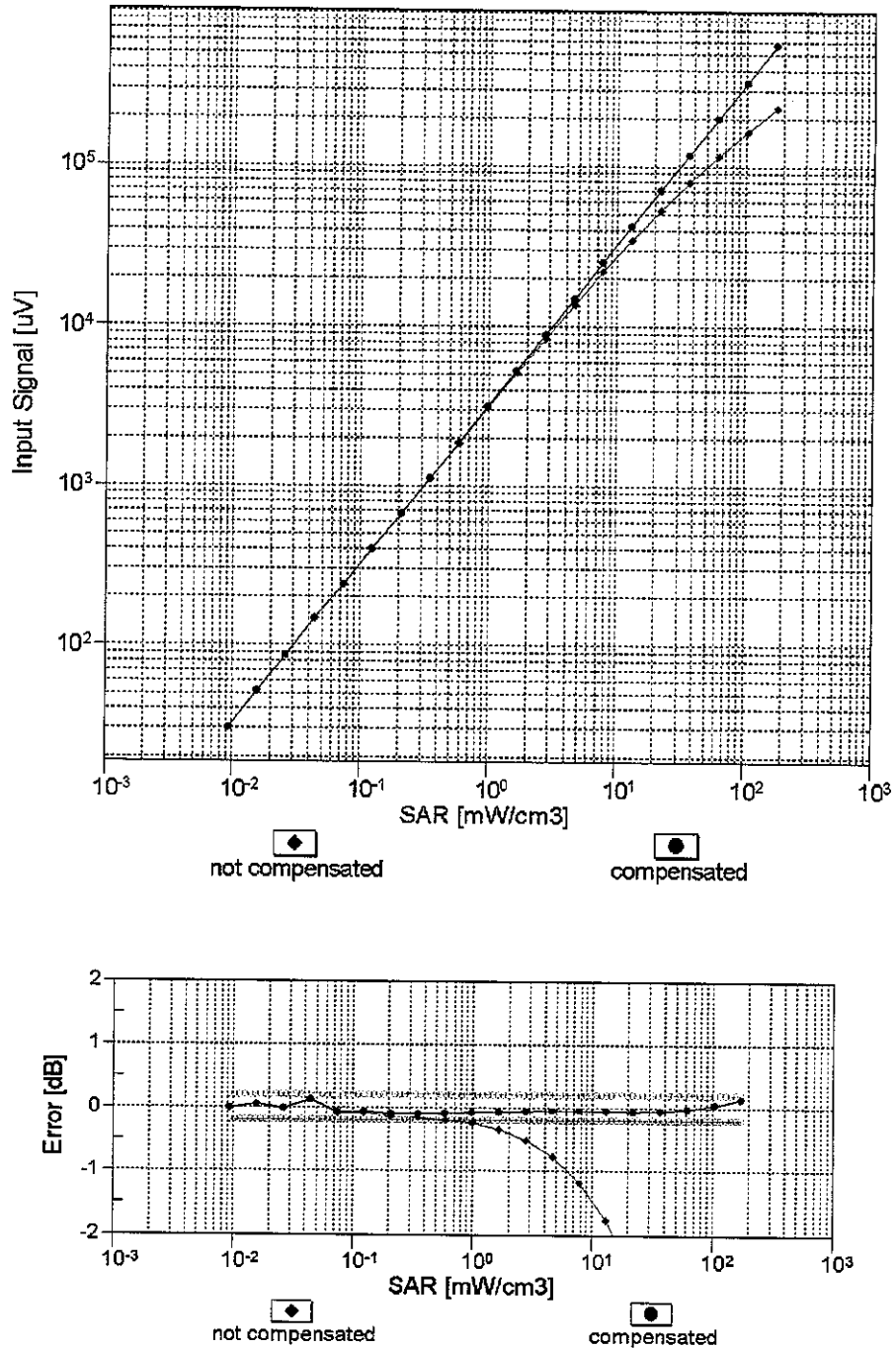

Uncertainty of Linearity Assessment: ± 0.6% (k=2)

Conversion Factor Assessment

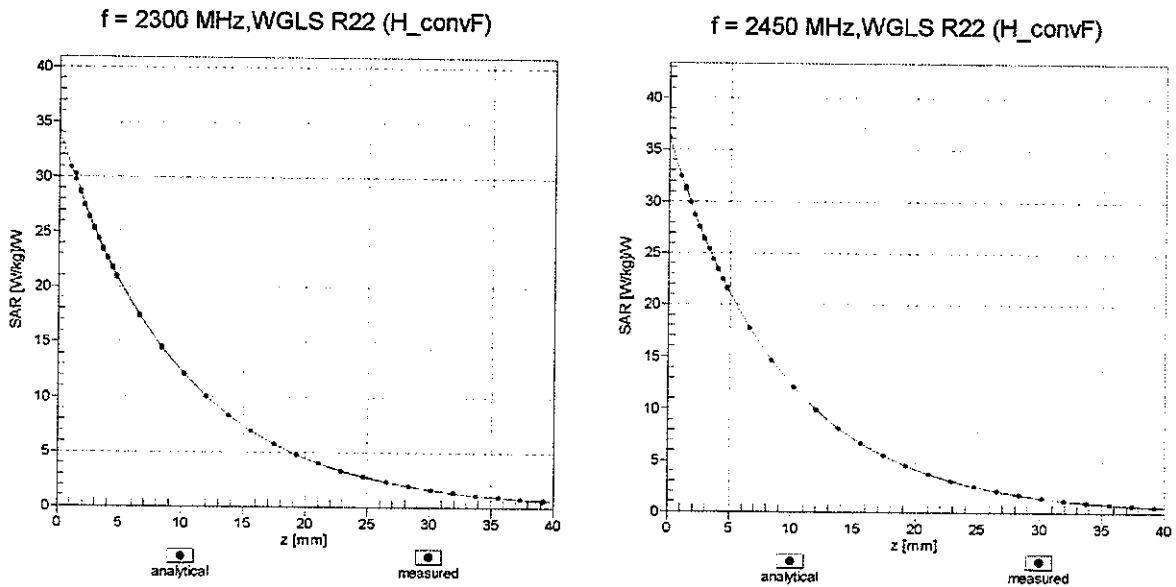

Deviation from Isotropy in Liquid

Error (ϕ , θ), f = 900 MHz

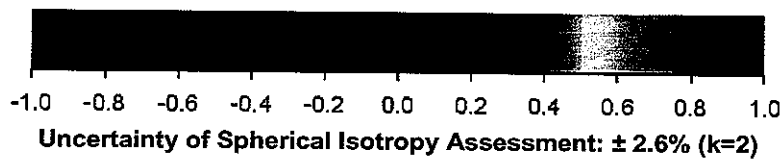
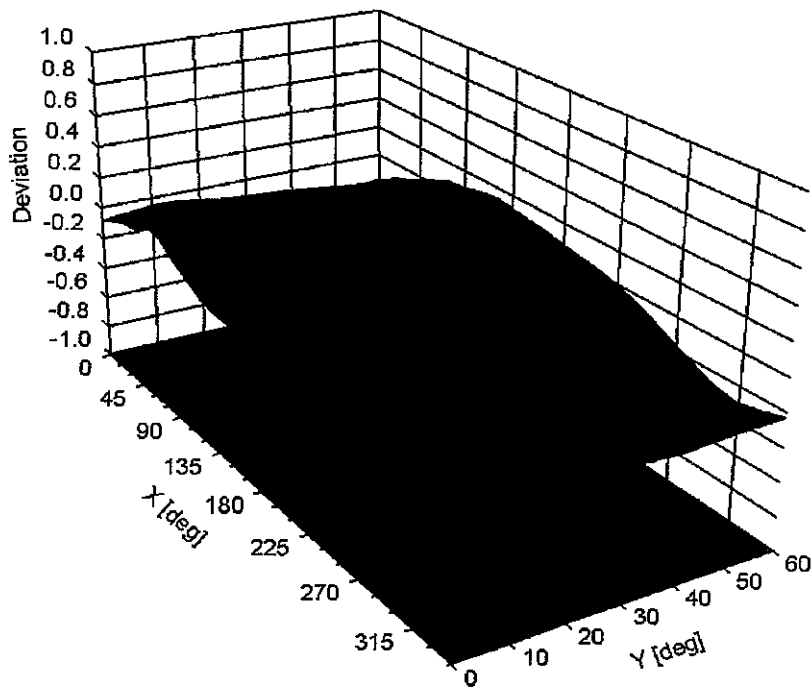

DASY/EASY - Parameters of Probe: EX3DV4 - SN:3746

Other Probe Parameters

Sensor Arrangement	Triangular
Connector Angle (°)	45.7
Mechanical Surface Detection Mode	enabled
Optical Surface Detection Mode	disabled
Probe Overall Length	337 mm
Probe Body Diameter	10 mm
Tip Length	9 mm
Tip Diameter	2.5 mm
Probe Tip to Sensor X Calibration Point	1 mm
Probe Tip to Sensor Y Calibration Point	1 mm
Probe Tip to Sensor Z Calibration Point	1 mm
Recommended Measurement Distance from Surface	1.4 mm