



ChoiceConnect[®] Fixed Network

CCU 100 and Repeater 100 Installation Guide

Identification

CCU 100 and Repeater 100 Installation Guide
07 July 2016 TDC-0971-011

Copyright

© 2010-2016 Itron, Inc. All rights reserved.

Confidentiality Notice

The information contained herein is proprietary and confidential and is being provided subject to the condition that (i) it be held in confidence except to the extent required otherwise by law and (ii) it will be used only for the purposes described herein. Any third party that is given access to this information shall be similarly bound in writing.

Trademark Notice

Itron is a registered trademark of Itron, Inc.

All other product names and logos in this documentation are used for identification purposes only and may be trademarks or registered trademarks of their respective companies.

Suggestions

If you have comments or suggestions on how we may improve this documentation, send them to TechnicalCommunicationsManager@itron.com

If you have questions or comments about the software or hardware product, contact Itron Technical Support:

Contact

- Internet: www.itron.com
- E-mail: support@itron.com
- Phone: 1 877 487 6602

Compliance

This device complies with Part 15 of the FCC Rules. Operation is subject to the following two conditions:

- This device may not cause harmful interference.
- This device must accept any interference that may cause undesirable operation.

This device must be permanently mounted such that it retains a distance of 36 centimeters (14.2 inches) from all persons in order to comply with FCC RF exposure levels.

USA, FCC Class B - Part 15

This equipment has been tested and found to comply with the limits for a Class B digital device, pursuant to Part 15 of the FCC Rules. These limits are designed to provide reasonable protection against harmful interference in a residential installation. This equipment generates, uses, and can radiate radio frequency energy and, if not installed and used in accordance with the instructions, may cause harmful interference to radio communications. However, there is no guarantee that interference will not occur in a particular installation.

If this equipment does cause harmful interference to radio or television reception, which can be determined by turning the equipment off and on, the user is encouraged to try to correct the interference by one or more of the following measures:

- Reorient or relocate the receiving antenna.
- Increase the separation between the equipment and receiver.
- Connect the equipment into an outlet on a circuit different from that to which the receiver is connected.
- Consult the dealer or an experienced radio or TV technician for help.

Compliance Statement Canada

Under Innovation, Science and Economic Development Canada (ISED) regulations, this radio transmitter may only operate using an antenna of a type and maximum (or lesser) gain approved for the transmitter by Industry Canada. To reduce potential radio interference to other users, the antenna type and its gain should be so chosen that the equivalent isotropically radiated power (e.i.r.p.) is not more than that necessary for successful communication.

This device complies with Innovation, Science and Economic Development Canada (ISED) license-exempt RSS standard(s). Operation is subject to the following two conditions:

- (1) this device may not cause interference
- (2) this device must accept any interference, including interference that may cause undesired operation of the device.

Déclaration de Conformité

Conformément à la réglementation d'Industrie Canada, le présent émetteur radio peut fonctionner avec une antenne d'un type et d'un gain maximal (ou inférieur) approuvé pour l'émetteur par Industrie Canada. Dans le but de réduire les risques de brouillage radioélectrique à l'intention des autres utilisateurs, il faut choisir le type d'antenne et son gain de sorte que la puissance isotrope rayonnée équivalente (p.i.r.e.) ne dépasse pas l'intensité nécessaire à l'établissement d'une communication satisfaisante.

Le présent appareil est conforme aux CNR d'Industrie Canada applicables aux appareils radio exempts de licence. L'exploitation est autorisée aux deux conditions suivantes:

- (1) l'appareil ne doit pas produire de brouillage,
- (2) l'utilisateur de l'appareil doit accepter tout brouillage radioélectrique subi, même si le brouillage est susceptible d'en compromettre le fonctionnement.



Caution ELECTROMAGNETIC COMPATIBILITY

Use only approved accessories with this equipment. In general all cables must be high quality, shielded, and correctly terminated. Unapproved modifications or operation beyond or in conflict with these instructions for use, may void authorization by the authorities to operate the equipment.

Contents

Before You Begin	vii
Documentation Conventions	vii
Related Documents	viii
CCU/Repeater Basics	1
CCU Configuration	1
CCU/Repeater Components	1
CCU/Repeater Module	2
Local GPS (WAN-3G Only)/WAN Antenna System	3
900 MHz Antenna	4
Planning a CCU/Repeater Installation.....	7
Installation Profiles	7
Siting Collectors or Repeaters.....	7
Propagation Study and Collector or Repeater Site Selection	8
GPS and WAN Coverage	8
AC Service Requirements.....	9
External Ethernet Connections	9
Remote 900 MHz Antenna Placement	10
Grounding the Antenna System.....	10
900 MHz Antenna	11
Lightning Arrestor	12
AC Mains Power.....	13
DC Mains Power	14
Materials Not Provided by Itron	14
Coaxial Cable.....	14
Remote Mount Standard (5.15) dBi 900 MHz Antenna on a Standard CCU/Repeater.....	14
Remote Mount High Gain (8.15dBi) 900MHz Antenna on a Standard Collector or Repeater	15
Remote Mount High Gain (8.15 dBi) 900 MHz Antenna on a Tower CCU	15
Local GPS and WAN Antennas	16
Antenna Sweep Test	16
Antenna Connectors	16
Mounting Hardware.....	17
Installing the Collector or Repeater	19
Installation Overview	19
Attaching the External GPS/WAN Antennas.....	20
Attaching the Direct Mount Standard (5.15 dBi) 900 MHz Antenna.....	20
Attaching the Collector or Repeater	22
Mounting Hardware.....	22
Pipe Mount	23
Pole Mount	25

Wall Mount	27
Davit Arm Mount	28
Connecting Cables	29
Installing a Local 4G WAN Antenna	33
Installing the Battery	34
Providing Power	36
CCU Installation Wiring Diagram	38
Tower Installation	38
Tower Installation Overview	39
TCU Components	41
Tower CCU Wiring Installation Diagram	44
Solar Powered Installation	45
Sunwize Solar Panel Wiring Legend	46
To assemble the Solar CCU 100	47
Solar Installation Wiring Diagram	50
Relocating a CCU or Repeater	51
Battery Care and Maintenance	53
Shipping Requirements	53
Battery Storage and Charging	53
Long-Term Storage	54
State of Charge	55
Charging the Battery	55
Battery Service Life	56
Calendar Life	56
Preventative Maintenance	56
Replacing the Integrated Battery	57
Detailed Collector or Repeater Specifications	59
CCU or Repeater Dimensions and Weight	59
Antenna Specifications	62
Environmental Specifications	63
Transmitter	64
Diagnostic Radio	64
Collector or Repeater Power Operating Range	64
Battery Pack	64
Port and Protocol Requirements	67
Logical Architecture of Fixed Network (Multiple Network Zones)	67
Ports and Protocols	68
Status and Diagnostics	73
Status Indicator	73
Performing an Antenna Sweep Test	74

Changing the Repeater Password	77
Antenna Line Sweeps Procedure.....	83
Anritsu Site Master Calibration.....	83
Testing on a Network Device with a Remotely-Mounted 900 MHz Antenna	84
General Testing Conditions	84
Specific Testing Conditions.....	85
Understanding Party Responsibilities	86
Itron's Responsibilities	86
Supplier's Responsibilities	86
Itron ChoiceConnect Antenna and Line Sweep Test Form.....	88
Itron ChoiceConnect 900 MHz Antenna Specifications	89
Technical Data	89
Typical Coaxial Cable Specification Summary Table	90
Sample Sweeps Output.....	91
Grounding Specifications	93
Understanding Grounding and Bonding	94
Understanding the Ohms Level	94
Reducing the Ohms level.....	94
Using a Megger	95
Adjusting the Routing of the Grounding Conductor.....	96
Supplier General Requirements and Equipment Competencies.....	97
Exterior Grounding System Design for Concentrators.....	97
Existing Building or Rooftop Sites	99
Co-Located Sites & Other Existing Structures	100
New Wood Pole Sites	100
Equipment Buried Ground Ring	100
Chemical Ground Rod Installation	101
Itron Concentrator Equipment.....	103
TCU / CCU on a Concrete Pad	103
TCU / CCU on a Steel Frame or I-Beam or Platform	103
TCU / CCU on a Raised Metal Platforms	103
TCU / CCU / Repeater Remote Antennas & Coax on Towers	104
Installing Coax Ground Kits	105
Collector Sites with Indoor Itron TCU / CCU Equipment	107
RF Components Protection (Coax)	107
Grounding Rooftop Network Devices.....	109
Down Conductor Installation	111
Cold Water Pipe Option	111
Building Steel Option	111
Antenna and Coax Grounding - Rooftops	112
Cable Tray Grounding	112
Water Tower Grounding	113
New Wooden and Concrete Antenna Poles	113
Equipment Shelter Grounding	114
Repeaters on Communication Tower Sites	114
Repeaters on Rooftops.....	115
Multiple Story Site Ground System.....	115
Down Conductors Installation - Building / Shelter Penetrations.....	115
Down Conductors Installation - Limits of Bend Radius	116

Down Conductors Installation Connection Methods.....	116
Cable Entrance Facilities	116
Clamp-On Ground Resistance Testing	117
Principle of Operation	117
Determining the Correct Measuring Point	118
Testing Procedures.....	119
Measuring Rod/Grid Resistance.....	119
Understanding Party Responsibilities	120
Itron Responsibilities.....	120
Supplier Responsibilities.....	120

Index	123
--------------------	------------

Before You Begin

The CCU 100 (also known as a cell control unit or collector) is the main collection point for the ChoiceConnect Fixed Network. The CCU reads data from Itron electricity meters, gas endpoints, and water endpoints and gathers consumption, daily, or hourly meter reads, and other information from endpoints and communicates it back to the utility over a public or private network. When used with the Fixed Network Repeater 100, the coverage territory per CCU 100 is extended. It also manages the collection, processing, and storage of endpoint data and can support two-way functionality to the endpoint. Equipped with a backup battery, the CCU 100's adaptable design allows for a wide range of installation options, utilizing either AC or solar power.

Repeater 100s are used to extend the range of the CCU and add communication reliability and redundancy between endpoints and collectors. Installed on towers, buildings, poles or other structures, the Repeater 100 collects meter data from Itron electricity meters, gas endpoints, and water endpoints and relays the meter data to collectors within the network. This makes the ChoiceConnect 100 Fixed Network cost-effective by reducing the number of required collectors.

-  **Important** Proper installation of the CCU/repeater ensures trouble-free operation of the Itron Fixed Network system. The installation of both the collector and repeater must be done by professional installers.

Documentation Conventions

This document uses the following conventions.

Convention	Example
Key presses are in bold .	Click OK to finish.
Menu paths are in bold.	Select Start > File > Save As .
Computer commands to be typed by the user are in a monospace font.	At the C: prompt, type <code>cd itron/bin</code>
File names are in a monospace font.	The data is uploaded to the <code>upload.dat</code> file
Hypertext links are blue.	For contact information, see the Copyright page (on page ii).

-  **Note** A note indicates neutral or positive information that stresses or supplements important points of the main text. A note supplies information that may apply only in special cases.

-  **Caution** A caution advises users that failure to take or avoid a specified action could result in a loss of data.

-  **Warning** A warning advises users that failure to take or avoid a specified action could result in physical harm to the user or the hardware.



Tip A tip helps users apply the techniques and procedures described in the text to their specific needs. A tip is not essential to the basic understanding of the text.

Related Documents

For more information about CCUs/repeaters and the Fixed Network, see the following guides:

- *Network Collection Engine User Guide*
- *Motorola R56 Manual- Standards and Guidelines for Communication Sites*
Available from Motorola, this manual illustrates industry best practices for mounting and grounding antenna systems, and routing antenna cables into buildings. Use this guide as a reference when remotely mounting the 900 MHz antenna.

See also the following appendixes in this guide:

- [Antenna Line Sweeps Procedure](#) on page 83
- [Grounding Specifications](#) on page 93

CHAPTER 1

CCU/Repeater Basics

The CCU 100 and the Repeater 100 are configurable for the following installation locations:

- Water tower or communications tower
- Wood, concrete, or metal utility pole
- Wall (indoor or outdoor)
- Pipe or mast (between 2 and 3.5 inches in diameter)
- Roof
- Other vertical structures

Integrated mounting and coupling brackets secure the device in high winds and under heavy ice loads. If you have any concerns about your CCU/repeater mounting location, consult a professional engineer.

The CCU 100 also supports an optional solar power kit. Kits are sized by peak sun hour calculations which vary regionally across the country. The kit includes solar panels and a large battery backup unit. Size and weights vary by package type (based on peak sun hours).

A collector or repeater consists of a number of components in a single weatherproof device. Electrical components are encased in a plastic enclosure that provides double insulation and a high level of safety for the installer.



Caution Only authorized Itron personnel may open this device. Unauthorized access or modifications to this device voids the warranty.

Per FCC rules, unapproved modifications or operation beyond or in conflict with these instructions for use could void the user's authority to operate the equipment.

CCU Configuration

A Fixed Network system administrator must configure each CCU 100 before it can be installed in the field. Verify with your supervisor or the system administrator that all CCUs are configured before you attempt to install them.

For more information about CCU configuration, see the *ChoiceConnect® Fixed Network CCU 100 Initial Configuration Guide*.

CCU/Repeater Components

The CCU 100 and Repeater 100 come in two basic configurations; basic configurations; they have either an internal GPS antenna and local WAN antenna (recommended) or remote GPS/WAN antennas. The 900 MHz standard 5.15 dBi antenna may be mounted directly on the CCU/repeater (recommended) or it may be mounted remotely.

Only an external GPS connection is provided in the Repeater 100. A WAN modem is not present in a repeater.

Since the collector or repeater may be installed in an outdoor environment, each component of the collector or repeater is weather-tight and can withstand wind requirements in excess of 100 MPH.

- Note** When determining the configuration of the collector or repeater, be sure to review the *Fixed Network 100 Ordering Guide* for specific part numbers, cable lengths, and various options for the components.

CCU/Repeater Module

The collector or repeater case houses the backup battery, GPS receiver, optional WAN radio, processing board, and 900 MHz radio. The antennas for the radios can be either internally connected, which is recommended, or externally connected, depending on the CCU/repeater configuration.

- Caution** Only authorized Itron personnel may open this device. Unauthorized access or modifications to this device voids the warranty.

Per FCC rules, unapproved modifications or operation beyond or in conflict with these instructions for use could void the user's authority to operate the equipment.

The following illustration shows a CCU without the connectors for external GPS/WAN antennas.

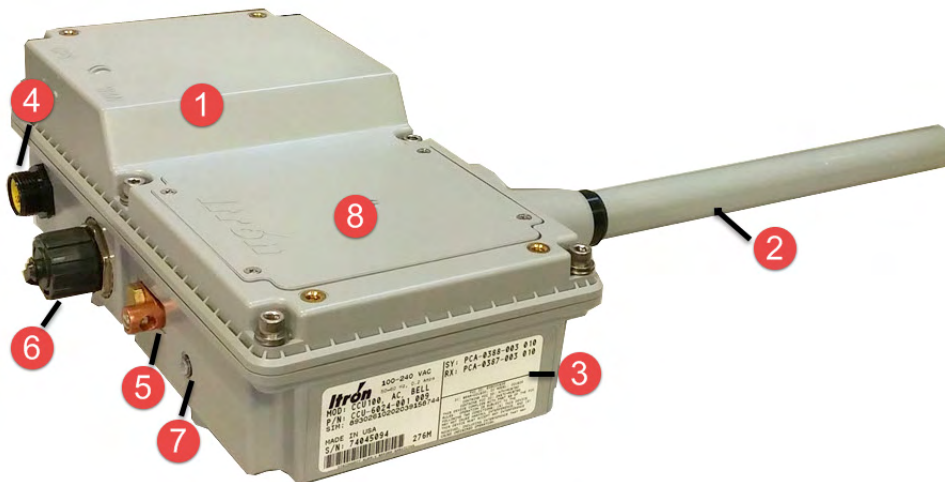

Item	Description
1	Collector or repeater module Processes data from the antennas and relays it on to the Fixed Network Application Software. Only authorized Itron personnel may open this module.
2	900 MHz antenna This 900MHz antenna receives messages from and sends messages to endpoints and repeaters in the network. The connection for this antenna is a Type N female.

Item	Description
3	Collector or repeater label Displays the collector identification number, model number, and other associated information.
4	Power connector Supplies power to the collector or repeater module. AC mains, DC, or solar power options are available. A three pin cable connects the collector or repeater to the mains supply. A two pin cable connects the collector or repeater to a DC supply. A five pin cable connects the collector or repeater to the solar system.
5	Ground lug The ground lug is provided on both the CCU and the repeater. Attach the ground lug to earth ground if there is no ground wire available with the three-conductor power cable, or when you are using a photocell adapter. This ground helps protect the internal circuitry from high voltage transient events. The ground lug accepts AWG minimum wire size 14, and maximum wire size 4. The recommended wire is #10 BTCW.
6	Ethernet Connects the collector or repeater to the Ethernet backhaul. Also used to connect the collector or repeater to a router for initial collector setup. Mating weatherproof cables are available from Itron. These cables are sealed industrial Ethernet circular IP67 connectors (CONEC). Note A waterproof cap seals the Ethernet port from the elements in the field. Be sure to securely attach the cap once the collector is installed.
7	Status indicator This indicator displays the current operational status of the collector or repeater. For more information, see Status Indicator for more information.
8	Battery Door Removal of this door allows access to the replaceable battery pack.
*	(Not shown) Local GPS antenna connector. This female SMA connector is only on the local antenna CCU/repeater. Use this connector when mounting the GPS antenna externally. Local WAN antenna connector. This female N connector is only on the local antenna CCU. Use this connector when mounting the WAN antenna locally.

Local GPS (WAN-3G Only)/WAN Antenna System

The external antenna collector or repeater configuration uses a GPS/WAN antenna kit connected to the collector or repeater by one or two separate pieces of coaxial cable. Cables are not included in the kit.

- The WAN antenna is only connected in CCU installations that use a wide area network backhaul system.
- The GPS antenna is used in all deployments of this system.

You must install the antennas in a location that allows reception of GPS and WAN signals.

Itron recommends using a handheld GPS unit to verify your GPS antenna mounting location can receive a signal from at least three satellites.

For more information, see [GPS and WAN Coverage](#) on page 8.

⚠ Caution You must install the external GPS antenna in a vertical orientation, and the antenna must have an unobstructed view of the southern sky (North America and Europe) to properly receive a GPS signal.

The local GPS/WAN antenna system is shown below.

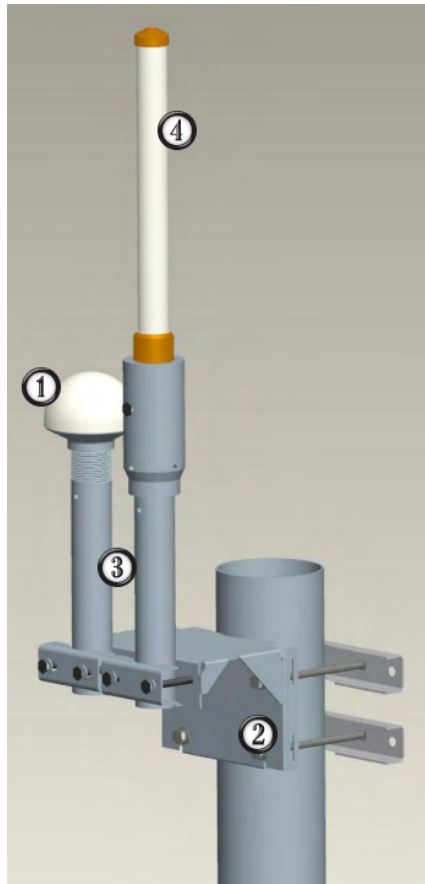

Item	Description
1	Local GPS antenna Receives GPS data from orbiting satellites. The cable connection on the bottom of this antenna is TNC female.
2	Mounting bracket Attaches the antenna to your desired mounting location.
3	Antenna masts Provide support for the GPS and WAN antennas. Cables for each antenna are routed through the masts. Clamps on the front of the mounting bracket secure the masts.
4	Local WAN antenna (CCU only) Provides the wide-area network (WAN) signal for the CCU. The repeater does not use this antenna. The cable connection on the bottom of this antenna is N female.

900 MHz Antenna

The 900 MHz antenna transmits and receives data messages from endpoints and repeaters in the network.



There are three antennas that can be used for the 900 MHz radio link.

- A standard vertically polarized antenna (5 dBi) directly attached to the collector or repeater.
- A standard vertically polarized antenna (5 dBi) connected remotely.
- A high-gain vertically polarized remote antenna (8.15 dBi) mounted remotely in place of the direct attached solution.

Warning Do not install an 8.15 dBi antenna directly on the CCU/repeater. Antenna installation directly on the CCU will compromise mechanical integrity and will not meet the compliance requirement for a loss of 2.2 dB between the CCU/repeaters and the 8.15 dBi antenna.

You must properly ground remote antennas during installation. When a remote antenna is used, a lightning arrestor is recommended.

Coaxial cable that is used to connect the remote 900 MHz antenna to the collector or repeater must be properly grounded. For more information, see [Lightning Arrestor](#) on page 12. All coaxial cable connections must be weather-proofed per industry standards, unless otherwise specified. When the collector or repeater is ordered with a remote 900 MHz antenna kit, some associated mounting hardware is included. Coaxial cables for the remote 900 MHz antennas are not included in the kit. The installer must provide these cables. For coaxial cable specifications, see [Coaxial Cable](#) on page 14.

For more information, refer to the following sections:

- [Antenna Specifications](#) on page 62
- [Remote 900 MHz Antenna Placement](#) on page 10
- [Grounding the Remote/External Antenna Systems](#) on page 10
- [Performing an Antenna Sweep Test](#) on page 74
- [Antenna Line Sweeps Procedure](#) on page 83
- [Grounding Specifications](#) on page 93

Planning a CCU/Repeater Installation

This chapter describes how to prepare for a collector or repeater installation.

Installation Profiles

You can install the collector or repeater in a variety of configurations and locations.

Depending on the installation location, you can:

- Install the CCU or repeater components in the same location (as an integrated solution). This is the recommended configuration.
- Install the GPS/WAN antennas externally from the collector or repeater.
- Install the 900 MHz antenna remotely (as a distributed solution).

For example, you can install the collector or repeater at the base of a water tower, mount the external GPS/WAN antenna system further away for optimum reception, and place the 900 MHz antenna at the top of the water tower.

The following profiles were identified for CCU installation.

Location	Description
Utility pole	The collector or repeater is installed on a utility pole. Mount the collector or repeater as high as possible on the pole for optimum reception.
Light pole	The collector or repeater is installed on either a light pole or the davit arm that extends from the light pole. Mount the collector or repeater as high as possible on the pole for optimum reception.
Outdoor wall or pipe with remote 900 MHz antenna	The collector or repeater is installed on an outside wall or pipe with the 900 MHz antenna remotely mounted to achieve the maximum elevation and reception.
Indoor wall or pipe with remote 900 MHz antenna and external GPS/WAN antennas	The collector or repeater is installed inside an equipment room with the 900 MHz antenna remotely mounted to achieve maximum elevation and reception. The WAN (or other digital cellular) and GPS antenna are externally mounted to provide acceptable coverage.
Pipe or mast	The collector or repeater is secured to a pipe or fence railing (from 2 to 3.5 inches in diameter). This type of installation typically occurs on the tops of water towers.

For more information about these profiles, as well as the Itron-recommended profile, see [Installing the CCU/Repeater](#) on page 19.

Siting Collectors or Repeaters

Collectors or repeaters are installed in the field on a variety of surfaces, such as wooden or metal walls, metal pipes, fence railing, and utility poles.

When you are determining the placement of the collector or repeater, the following are primary considerations:

- Site for optimum RF reception.
- Site for optimum GPS and/or WAN reception.
- Ethernet connection availability (if required).
- Power connection availability.
- Structure or location present that can physically support the collector or repeater and its mounting hardware.



Caution Always ensure you have permission to install a collector or repeater at the selected site prior to beginning installation. If you have questions or need assistance, contact Itron's Joint Use Team.

Propagation Study and Collector or Repeater Site Selection

Before you install a collector or repeater in the field, contact Itron to perform a propagation study. A propagation study is performed for the following reasons:

- Evaluates the quantity and types of endpoints in the network.
- Assesses environmental and geographical considerations related to a collector or repeater installation.
- Optimizes collector or repeater placement in the network for the best possible reception.
- Helps influence the physical and structural implications of mounting a collector or repeater to a given surface.

Once the propagation study is complete, you can determine the exact collector or repeater installation location and the collector or repeater mounting surface. This is an iterative process that may need to be repeated, depending on the final installation types and heights.

GPS and WAN Coverage

You must install collectors or repeaters in locations where a GPS signal is strong and consistent. If WAN is being used as the communications backhaul for the network, a strong and consistent WAN signal is required (for collectors only). If the signal is too weak, or its availability fluctuates, the collector cannot gather accurate date/time information or communicate with the Fixed Network software.

Itron recommends using a handheld GPS unit to verify your collector, repeater, or external GPS antenna mounting location can receive a signal from at least three satellites.

To ensure the best possible signal, avoid installing the collector, repeater, or external antennas in the following locations:

- Adjacent to or between tall buildings, signs, towers, or bridges.
- Near swaying limbs, branches, or cables that could strike and damage the antenna.
- Between, beneath, or near highway overpasses, elevated train platforms, or tunnels.

- Near objects or devices attached to the same pole.
- Within 500 feet of high power radio frequency (RF) transmitters (such as paging transmitters, cellular transmitters, and municipal communications transmitters).

Note Typically, maintaining a 10-foot vertical separation from other transmitters allows for a co-location type of installation.

- Near potential broadband sources of radiated RF energy (such as power line transformers, RADAR transmitters, cellular antennas, and neon or fluorescent signs).
- Inside metal enclosures (an antenna will not communicate if it is surrounded by metal) or inside a building. The collector or repeater can be installed in a building or other metal enclosure, but the antennas must be installed externally.

 **Warning** Before installing a collector or repeater near or on the same pole as a transformer, consult the National Electrical Safety Code (NESC), local utilities, municipalities, and cable and telephone companies for recommended distances from transformers and power lines.

AC Service Requirements

The collector or repeater must be powered by a 90-265 VAC source defined as a maximum 15 amp branch circuit (a minimum 15 amp branch circuit for TCU 100s), and the collector or repeater must be protected by a certified branch circuit breaker. Do not connect the collector or repeater to a circuit protected by a GFCI breaker. Size the wiring in accordance with the National Electrical Code, ANSI/NFPA 70 and, where applicable, the Canadian Electrical Code, Part I, CSA C22.1 or the prevailing local code. For more information on these options, see [AC Mains Power](#) on page 13, [DC Mains Power](#) on page 14, or [Solar Powered Installation](#) on page 45.

External Ethernet Connections

If the Ethernet is used as the communications backhaul, the collector installation site must have Ethernet access. Also, be sure to use weatherproof cables in this type of installation.

If the collector is not on the same subnet as the database server, additional network configurations are necessary. See [Port and Protocol Requirements](#) on page 67. Network functionality, specifically on-demand reads, adaptive channel planning, list management, and endpoint type exclusion, are affected if the database server cannot initiate communication to the collector.

 **Caution** If you use Ethernet as the communications backhaul, the collector must be identified as Ethernet-based when performing the initial collector configuration. Failure to identify the collector as Ethernet-based prohibits the collector from communicating with the Network Collection Engine.

Remote 900 MHz Antenna Placement

Antenna placement is one of the most important factors in determining your overall system performance. Careful consideration must be given to proper antenna placement. Follow the general guidelines below when determining the ideal location for a remote-mounted 900 MHz antenna.

- Mount the antenna vertically.
- Mount the antenna in a location where there is a clear, unobstructed, 360-degree view of the horizon. The antenna receives and transmits in all directions. Objects like building walls, nearby metal surfaces, or other obstructions will interfere with the proper operation of the antenna.
- Do not mount the antenna on a rooftop where nearby buildings are higher than the installation location.
- Do not mount the antenna near existing RF radiating antennas. If existing RF radiators are nearby, the horizontal separation distance to the radiator must be a minimum of 100 feet and/or 10 feet of vertical separation. In instances where nearby RF radiators are present, conduct an intermodulation interference study to evaluate the potential for interference and any effects it may have on system performance. Consult your Itron systems engineer for more information.
- Height is preferred for optimal performance. Itron recommends you install the antenna no higher than 100 feet. If the antenna is going to be more than 100 feet above the collector, Itron recommends using a Tower CCU 100.

A side arm antenna installation must be done if the 900 MHz antenna is mounted where it does not have an unobstructed 360-degree view. Refer to the following guidelines for a side arm antenna installation.

- For the 900 MHz antenna the minimum standoff distance is 24 inches, where the interfering structural members are four inches or less in diameter and spaced more than eight feet apart.
- For structural members between 4 and 10 inches in diameter, use a sliding scale of 2 to 5 feet. (For example, a 24-inch standoff at 4-inch diameter to a 60-inch standoff at 10-inch member diameter.)
- Inform Itron about any conditions that may impact the collector or repeater performance.

Grounding the Antenna System

To minimize the potential for a lightning event, it is essential that remote/external antenna systems be properly grounded. Proper grounding prevents the accumulation of static charges on the antenna system, and also provides a direct discharge to ground for any acquired charges.

All grounding materials and procedures must meet or exceed local codes. Use coaxial grounding kits recommended by the coaxial cable manufacturer.

 **Warning** Under no circumstances should the antenna grounding wires be run inside a building. Always install ground bars and grounding material on the building's exterior.

To ground an antenna system

1. Mount a copper ground bar near the antenna. This is the top ground bar.
2. Mount a second copper ground bar near the collector or repeater. This is the bottom ground bar.
3. Connect the two ground bars with a #6 gauge green jacketed stranded wire or a #2 solid copper wire.
4. Ground the antenna mount and the top coaxial ground kit to the top ground bar.
5. Ground the bottom coaxial ground kit and the lightning arrestor to the bottom ground bar.
6. Connect the bottom ground bar to one or more earth ground rods.
7. All ground wires should be connected straight to ground, with no right angle turns or sharp bends in the wires.
8. Install ground leads on coaxial grounding kits without loops or bends.
9. Install grounding kits in the proper orientation per the manufacturer's specifications.

For more information about grounding and bonding, see [Grounding Specifications](#) on page 93.

900 MHz Antenna

The 900 MHz antenna transmits and receives data messages from endpoints and repeaters in the network.



There are three antennas that can be used for the 900 MHz radio link.

- A standard vertically polarized antenna (5 dBi) directly attached to the collector or repeater.

- A standard vertically polarized antenna (5 dBi) connected remotely.
- A high-gain vertically polarized remote antenna (8.15 dBi) mounted remotely in place of the direct attached solution.

Warning Do not install an 8.15 dBi antenna directly on the CCU/repeater. Antenna installation directly on the CCU will compromise mechanical integrity and will not meet the compliance requirement for a loss of 2.2 dB between the CCU/repeaters and the 8.15 dBi antenna.

You must properly ground remote antennas during installation. When a remote antenna is used, a lightning arrestor is recommended.

Coaxial cable that is used to connect the remote 900 MHz antenna to the collector or repeater must be properly grounded. For more information, see [Lightning Arrestor](#) on page 12. All coaxial cable connections must be weather-proofed per industry standards, unless otherwise specified. When the collector or repeater is ordered with a remote 900 MHz antenna kit, some associated mounting hardware is included. Coaxial cables for the remote 900 MHz antennas are not included in the kit. The installer must provide these cables. For coaxial cable specifications, see [Coaxial Cable](#) on page 14.

For more information, refer to the following sections:

- [Antenna Specifications](#) on page 62
- [Remote 900 MHz Antenna Placement](#) on page 10
- [Grounding the Remote/External Antenna Systems](#) on page 10
- [Performing an Antenna Sweep Test](#) on page 74
- [Antenna Line Sweeps Procedure](#) on page 83
- [Grounding Specifications](#) on page 93

Lightning Arrestor

Install a lightning arrestor (or surge protector) capable of withstanding multiple lightning strikes when you are using a remote/external antenna. This helps protect the collector or repeater in the event of a lightning strike.

The lightning arrestor is fitted between the coaxial antenna cable and the RF jumper cable that connects to the collector or repeater module. It includes a bulkhead connector interface that mounts to a ground plate with a washer and nut. The arrestor is also furnished with a ground lug, if your installation does not have provisions for a ground plate. The ground lug on the arrestor is designed for #2 AWG solid or stranded wire.

 **Caution** The lightning arrestor must be connected to an earth-ground.



The ground lug is manufactured by AMP/Tyco Electronics (part number 320754) and is designed for #2 AWG solid or stranded wire (0.257-inch to 0.335-inch diameter). The lug must be properly crimped (never soldered) to the wire using SOLISTRAND tooling designed for the lug. The following figure details a proper crimp.

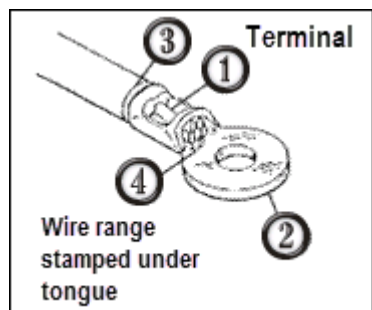

- 1 Center the crimps.
Crimps may be off-center, but not off the end of the wire barrel.
- 2 Ensure the AWG wire size you are using matches the wire range or size stamped on the terminal or the splice and dies.
- 3 Ensure the insulation does not enter the wire barrel.
- 4 Ensure the wire is visible through the inspection hole of the butt splices. The wire must be flush with or extend slightly beyond the end of the terminal wire barrel.

The top and bottom ends of the coaxial cable attached to the tower should be electrically grounded with kits for lightning protection. The antenna input connection cannot serve as the top ground point. For cable lengths in excess of 200 feet, ground the vertical cable run every 100 feet.

- Note** When a remote/external antenna is used, the installer must supply any mounting brackets and cable-management clips to secure the coaxial cable to the tower or structure. Consult your cable manufacturer for specifications on proper clips and grounding kits. Conduit clamps and tie wraps are not satisfactory methods for securing coaxial cables.

For a remote 900 MHz installation with a high gain antenna, a lightning arrestor is supplied by Itron in the CCU 100 or Repeater 100 kit materials.

AC Mains Power

The AC mains wiring to the collector or repeater utilizes a three conductor cable. Terminate this cable with either a NEMA L5-15 (125V, 15A) or a NEMA L6-15 (250V, 15A) locking plug to meet local electrical codes. The collector or repeater must be powered by a 90-265 VAC source defined as a maximum 15 amp branch circuit and must be protected by a certified branch circuit breaker. TCU 100s require a minimum 15 amp branch circuit breaker. Do not connect the collector or repeater to a circuit protected by a GFCI breaker. Size the wiring in accordance with the National Electrical Code, ANSI/NFPA 70, and, where applicable, the Canadian Electrical Code, Part I, CSA C22.1 or the prevailing local code. Power wiring on the Itron-supplied power cable follows conventional color coding for AC wiring: green (ground), white (neutral), black (hot).



Warning

Securely mount the collector or repeater before connecting the dedicated AC mains power source.

You must ground the collector or repeater by using either the ground wire in the three conductor cable, or the grounding lug on the bottom of the collector or repeater. For installations that use the photocell adapter, the grounding lug must be used to ground the CCU.

DC Mains Power

DC wiring to the collector or repeater utilizes a two conductor cable. Connect the CCU to a 10A DC circuit breaker or fuse. Wire the Itron-supplied two conductor cable by attaching the red wire to a +12V source. Attach the black wire to ground.

Materials Not Provided by Itron

The following materials are not provided by Itron in the collector or repeater kit, but are required for installation.

Please acquire these items prior to beginning an installation.

- [Coaxial cable](#) on page 14 (for remote/external antennas)
- [Connectors](#) on page 16
- [Mounting hardware](#) on page 16

Coaxial Cable

When you are mounting the remote/external antennas, you must supply coaxial cable to connect the antenna to the collector or repeater. The required cable size is dependent on the total cable length and frequency. Coaxial cable also requires proper hoisting grips, ground kits, connectors, jumpers, hangers, and weather proofing material. Coaxial cable and accessories are not provided by Itron. You must install and test coaxial cable systems according to the manufacturer's specifications. Itron recommends using qualified radio installation contractors to install and test the remote/external antenna system.

All coaxial cable connections must be properly weather-proofed per industry standards unless otherwise specified. This includes any connections for the antennas and the collector or repeater.

Refer to [Antenna and Line Sweeps Procedure](#) on page 83 to verify that the coax and antenna are correctly installed.

Remote Mount Standard (5.15) dBi 900 MHz Antenna on a Standard CCU/Repeater

When selecting cable for the remote mount 900 MHz antenna on the standard (non-tower) collector or repeater, total cable loss cannot exceed 1.5 dB to maintain system performance. Allow 0.1 dB loss for each connector.

Remote Mount High Gain (8.15dBi) 900MHz Antenna on a Standard Collector or Repeater



Warning Do not install an 8.15 dBi antenna directly on the CCU/repeater. Antenna installation directly on the CCU will compromise mechanical integrity and will not meet the compliance requirement for a loss of 2.2 dB between the CCU/repeaters and the 8.15 dBi antenna.

The following Coaxial Specifications table lists several options for coaxial cable that can be used with the remote mount high gain 900 MHz antenna. When a high gain antenna is installed on a standard collector or repeater, follow the FCC set limits for the maximum transmit power of the collector or repeater. To meet FCC limits, standard collectors or repeaters must have a minimum of 2.2 dB worth of loss (but not more than 3.5 dB) between the collector or repeater and the antenna.

Allow 0.1 dB loss for each connector. If required, you may use a 1 dB attenuator (similar to the Pasternack PE7002-1) to attain the desired power at the antenna for short coaxial cable runs.

Remote Mount High Gain (8.15 dBi) 900 MHz Antenna on a Tower CCU

The following Coax Specification table lists several options for coaxial cable that can be used with the remote mount high gain 900 MHz antenna. When a high gain antenna is installed on a tower collector, follow the FCC set limits for the maximum transmit power of the collector. To meet these limits, tower collectors with FCC ID number EO9CCU100T must have a minimum of 2.2 dB worth of loss (but not more than 3.5 dB) between the tower cabinet and the antenna. Install all other tower collectors with minimum cable loss.

Allow 0.1 dB loss for each connector. If required, you may use a 1 dB attenuator (similar to the Pasternack PE7002-1) to attain the desired power at the antenna.

Coax Specification	Total Coaxial length		
	0-120 ft.	121-200 ft. (high-gain antenna only)	201-250 ft. (high-gain antenna only)
Standard black jacket cable	AVA5-50	AVA6-50	AVA7-50
Optional fire retardant cable	AVA5RK-50	AVA6RK-50	AVA7RK-50
Cable diameter (nominal)	7/8 in.	1-1/4 in.	1-5/8 in.
Cable weight (lb./ft.)	0.33	0.46	0.70
Minimum bend radius	10 in.	8 in.	15 in.
Cable attenuation @ 915 MHz	~ 1.2 dB/100 ft.	~ 0.84 dB/100 ft.	~0.70 dB/100 ft.

Local GPS and WAN Antennas

The primary requirement for any coaxial cable used with the local GPS or WAN antenna is to have less than 5 dB of attenuation at 1.5 to 1.8 GHz for the entire length of cable, including connector losses.

You may use any type of 50 ohm coaxial cable as long as the total loss, including connectors, is less than 5 dB at 1.5 to 1.8 GHz.

Itron recommends using regular 1/2" coax or Times Microwave LMR-400.

If the antennas are mounted in an exposed outdoor environment, you must provide lightning protection and proper grounding. For more information on lightning protection and grounding, see [Lightning Arrestor](#) on page 12, [Grounding the Remote/External Antenna Systems](#) on page 10, and the Motorola R-56 guidelines.

Antenna Sweep Test

After remote antenna installation, perform an antenna system sweep test and verify the VSWR (voltage standing wave ratio) does not exceed 1.5:1. For more information, see [Performing an Antenna Sweep Test](#) on page 74 and the [Antenna Line Sweeps Procedure](#) on page 83.



Caution All coaxial cable used to connect an antenna to the collector or repeater must be properly grounded at the top and bottom of the coaxial line. Additionally, any cable lengths of 200 feet or greater must be grounded each 100 feet. For more information, see [Lightning Arrestor](#) on page 12.

Antenna Connectors

Connectors for the 900 MHz and WAN antenna cables must be male type N connectors, and must be sized according to the type of coaxial cable used. The GPS cable requires TNC male and SMA male connectors. These connectors are available from a variety of manufacturers.



Important All coaxial cable connections must be properly weather-proofed per industry standards unless otherwise specified.

Mounting Hardware

Depending on your installation location and configuration, the installer must supply the following mounting hardware to properly attach the collector or repeater to the mounting surface.



Caution Since each installation is unique, you must ensure the mounting hardware securely supports the collector or repeater. The collector or repeater (minus attachment hardware) weighs 7 pounds. Itron recommends consulting with a qualified engineer to verify load requirements and safety issues. Also, be sure to check and comply with local codes when installing the collector or repeater.

Profile	Mounting surface	Suggested hardware/sizing
Utility pole	Wood or steel pole	High-strength stainless steel straps.
Light pole	Steel light pole	High-strength stainless steel straps
Outdoor wall or pole with remote 900 MHz antenna	Concrete, wood, or steel wall	1/4 inch-20 lag screws or 1/4 inch-20 molly bolts
	Wood or steel pole	High-strength stainless steel straps
Indoor wall or pole with remote 900 MHz antenna and local GPS/WAN antennas	Concrete, wood, sheetrock, or steel wall	1/4 inch-20 lag screws or 1/4 inch-20 molly bolts
	Wood or steel pole	High-strength stainless steel straps
Pipe	2.5 inch to 3.5 inch galvanized steel pipe	Two pipe mount brackets for pipes up to 3.5 inches in diameter, supplied by Itron (part number FAB-0192-001, two brackets are required for each collector or repeater).

Installing the Collector or Repeater

This chapter provides the instructions to install a collector or repeater in the field, using the Itron-recommended installation method.

The collector or repeater can be installed in a variety of ways. This chapter provides several different collector or repeater installation profiles for both mains powered and solar powered collectors or repeaters.

 **Warning** Before installing a collector or repeater, ensure that the selected location can support the weight of the collector or repeater and mounting hardware. A thorough structural analysis should be performed by a registered professional engineer at your desired location prior to installation. Itron is not responsible for improper installations or for installations at a site that cannot adequately support the collector or repeater.

Warning Do not install an 8.15 dBi antenna directly on the CCU/repeater. Antenna installation directly on the CCU will compromise mechanical integrity and will not meet the compliance requirement for a loss of 2.2 dB between the CCU/repeaters and the 8.15 dBi antenna.

Installation Overview

The following Itron-recommended collector or repeater installation profile describes the procedure for mounting the collector or repeater to a 2-inch diameter vertical pipe. A 110V source supplies mains power to the collector or repeater.

There are several tasks in this installation profile. Each task is described in more detail in the following sections.

 **Caution** Prior to installing a collector in the field, be sure to configure it as described in the *the CCU 100 Collector Configuration Guide*. A collector cannot be configured after it has been installed in the field. Repeaters do not require pre-installation configuration.

1. Attach the local GPS/WAN antennas (if necessary).
2. [Attach the direct mount 900 MHz antenna](#) on page 20 (if necessary).
3. Attach the CCU/repeater to the mounting surface.
4. [Connect the cables](#) on page 29.
5. [Install the battery](#) on page 34.

Caution Do not move or transport the collector without first disconnecting power. Moving or tilting a collector with the power connected may cause the collector to reset to the factory image.

6. [Provide power](#) on page 36.
7. [Performing an antenna sweep test](#) (on page 74).

Attaching the Local GPS/WAN Antennas

You can attach the local GPS and WAN antennas to pipes, poles, walls, and davit arms. The 3G and 4G pole mount assemblies are shown in the following graphics.



3G GPS/WAN Antenna



4G GPS/WAN Antenna

To attach the local GPS/WAN antennas

1. Assemble the antenna unit as described in the *GPS/WAN Remote Antenna Mounting Kit Assembly Guide* included with the GPS/WAN local Antenna Mounting Kit.
2. Attach the GPS/WAN antenna unit coaxial cable, as described in [To connect cables](#) on page 30.

Attaching the Direct Mount Standard (5.15 dBi) 900 MHz Antenna

Attach the direct mount 900 MHz antenna before mounting the collector or repeater in its permanent location.

To attach the direct mount standard 5.15 dBi 900 MHz antenna

Warning Do not install an 8.15 dBi antenna directly on the CCU/repeater. Antenna installation directly on the CCU will compromise mechanical integrity and will not meet the compliance requirement for a loss of 2.2 dB between the CCU/repeaters and the 8.15 dBi antenna.

1. Slide the black rubber boot onto the base of the antenna as shown in the following illustration.



2. Screw the antenna onto the top of the collector or repeater. Be careful not to cross-thread the connectors. Do not over-tighten.



3. Push the rubber boot as close as possible to the top of the collector or repeater as shown in the following illustration.



4. Slide the antenna sleeve over the antenna, ensuring the front of the antenna sleeve is toward the front of the collector or repeater.



5. Using the included screws and washers, screw the antenna sleeve to the top of the collector or repeater. Tighten the screws to 5 to 6 in/lbs.

Antenna sleeve > flat washer > lock washer > screw



Attaching the Collector or Repeater

You may attach the collector or repeater to a variety of surfaces. See the following sections for diagrams showing some of the possible configurations.

- [Pipe mount](#) on page 23
- [Pole mount](#) on page 25
- [Wall mount](#) on page 27
- [Davit arm mount](#) on page 28

Mounting Hardware

You can adapt the hardware set to mount the collector or repeater in many different locations.

For pole or pipe mounts, the mounting hardware consists of a mounting plate, two brackets, four bolts, and a set screw.

For a wall mount, use two metal brackets (not shown below), four mounting bolts, nuts, and lock washers to prepare the collector for mounting. Itron does not supply the hardware necessary to mount the wall mounting brackets to the wall.

An integrated mounting support on the back of the collector or repeater enclosure slides into the slot in the center of the mounting bracket. A set screw locks the collector or repeater to the mounting bracket. Orientation of the enclosure may be adjusted +/- 16 degrees horizontal to compensate for different angles.

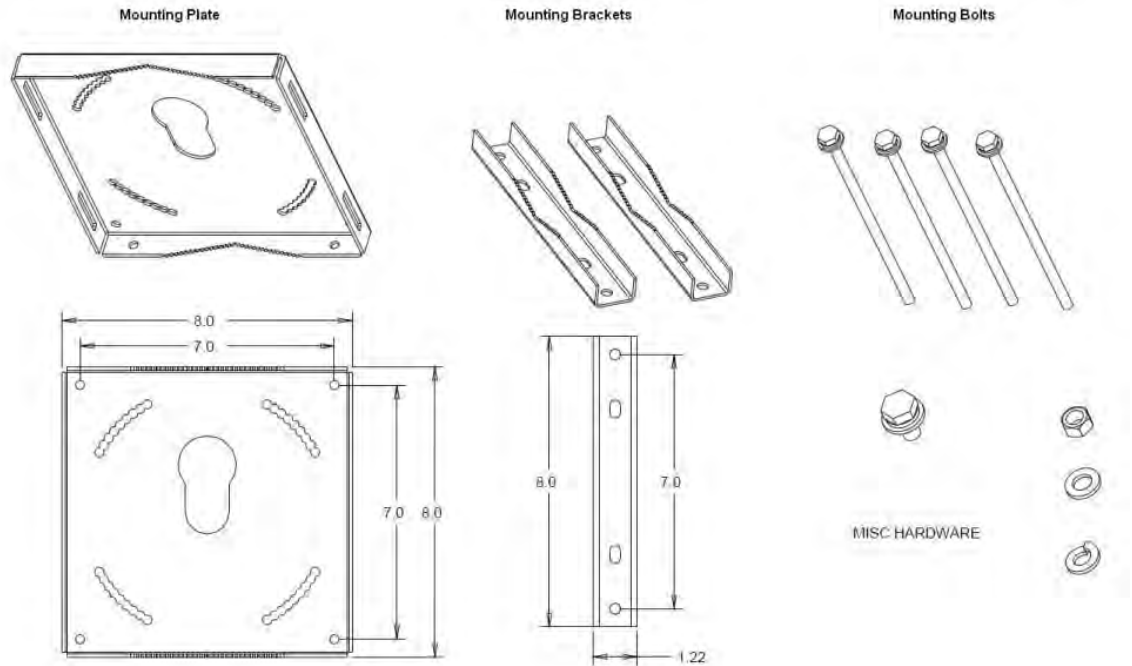

Pipe Mount

The following image illustrates a typical vertical pipe installation. The collector or repeater may also be attached to a horizontal pipe.



To mount the collector or repeater on a pipe

In the following illustration, the mounting plate is attached to the vertical pipe with the mounting brackets. The collector or repeater enclosure is secured to the mounting plate.

1. Using the two mounting brackets and four bolts, attach the mounting plate to the pipe.

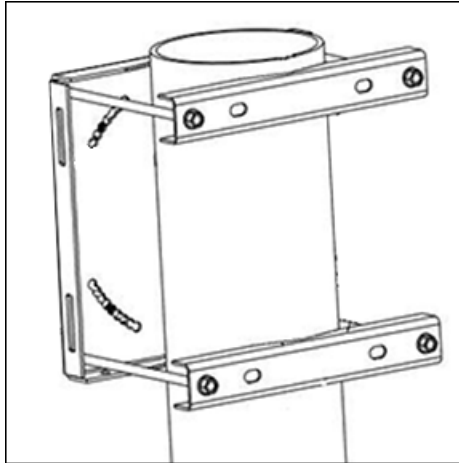

2. Insert the mounting disc into the mounting plate keyhole.

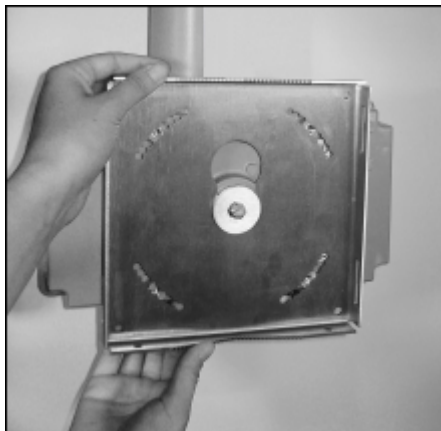

3. Using the provided set screws, secure the collector to the mounting plate with the antenna in the upright position.

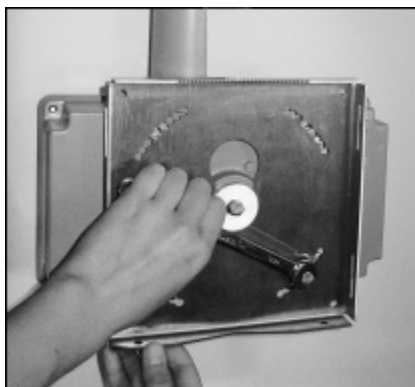

Pole Mount

If the vertical pipe or pole exceeds 6.75 inches in diameter, you may use metal bands instead of the mounting brackets to secure the mounting plate to the pipe or pole. Two sets of slots (1.5 in. long) on the mounting plate are provided for the metal bands. It may be necessary to use the remote 900 MHz antenna kit to achieve optimum RF performance and GPS coverage if the pole obstructs the desired RF path.



To mount the collector or repeater on a pole

1. Attach the mounting disc to the back of the collector or repeater with the included parts in the following order.
collector > mounting disk > flat washer > lock washer > bolt

2. Insert the mounting disc (on the back of the collector) into the mounting plate keyhole.

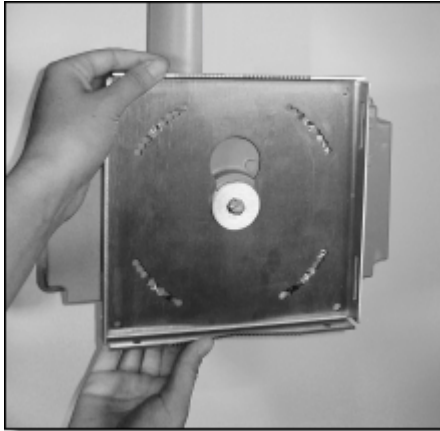

3. Using the provided set screws, secure the collector to the mounting plate with the antenna in the upright position.

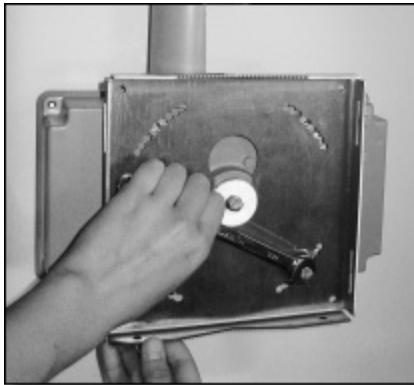

4. Using two steel straps, attach the mounting plate to the pole.

Wall Mount

The following image illustrates a wall mount installation. In this scenario, two brackets are secured to the collector or repeater and the entire assembly is attached to the wall. It may be necessary to use the remote 900 MHz antenna kit to achieve optimum RF performance and GPS coverage if the collector or repeater is mounted indoors, or if the wall obstructs the desired RF path.

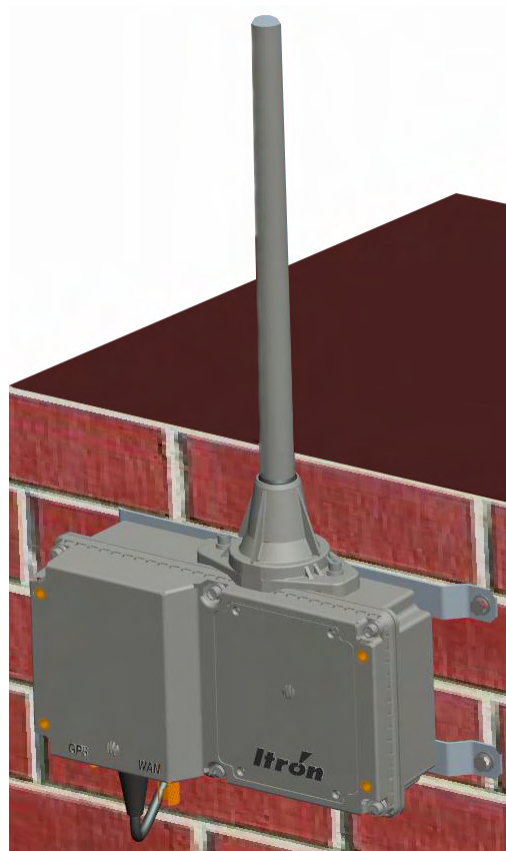

To mount the collector or repeater on a wall

1. Remove the integrated mounting support (bolt, washer, lock washer, and mounting disk) from the back of the device. These parts are not used for this mounting configuration.
2. Using four bolts, secure the collector or repeater to the two wall mounting brackets with the antenna in the upright position.
3. Using four appropriate screws or bolts (not provided by Itron), attach the mounting brackets to the wall.

Davit Arm Mount

The following figure illustrates a typical utility pole or street light pole installation. The collector or repeater is mounted on a davit arm or the street light arm. Two types of power connections are typical. You may use a photocell adapter cable when the collector or repeater is mounted on a street light arm. This cable plugs into the photocell sensor of the street light. Use of the photocell adapter requires the collector or repeater be grounded using the grounding lug on the bottom of the collector or repeater. If the collector or repeater is mounted on a davit arm with no street light, the power cable must be connected according to local electrical codes.

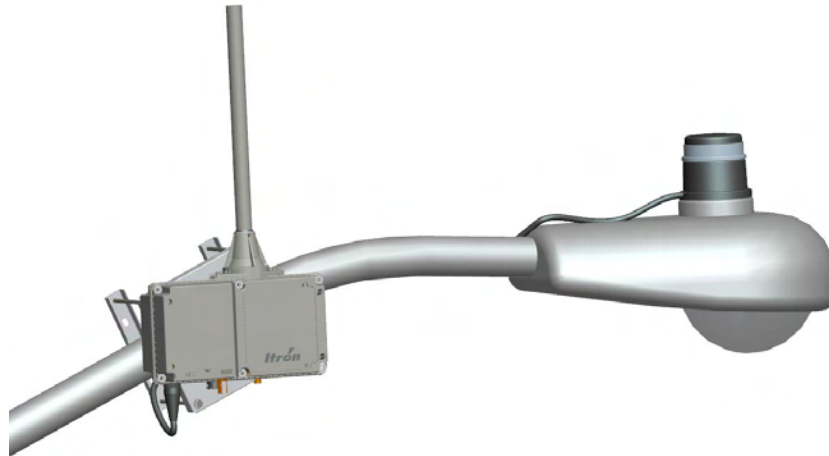

To mount the collector or repeater on a davit arm

1. Using the two mounting brackets and four bolts, attach the mounting plate to the davit arm.

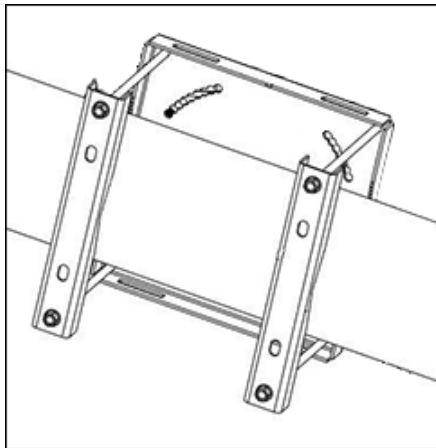

2. Insert the mounting disc into the mounting plate keyhole. The following photos are shown off the davit arm for clarity.

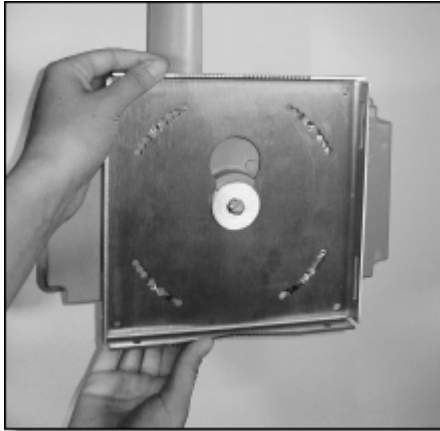

3. Using the provided set screws, secure the collector to the mounting plate with the antenna in the upright position.

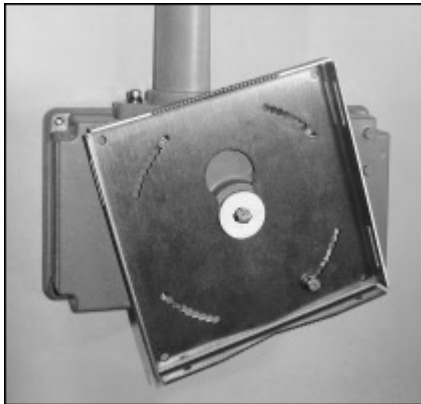

Connecting Cables

Connect the remote/external antenna cables (if needed), Ethernet cable (if needed), and grounding wire.

Due to the variable requirements for cable length, cables are not provided by Itron.

- !** **Important** All coaxial cable connections must be properly weather-proofed per industry standards unless otherwise specified. (For example, see Step 3 of the following procedure [To connect cables](#) on page 30. If the collector or repeater is installed indoors, only the connections located outside need to be weather-proofed.

To connect cables

1. The GPS cable has an SMA connector on one end and a TNC connector on the other end. Connect the SMA connector end of the GPS antenna cable to the collector or repeater. Connect the TNC end of the GPS cable to the external GPS antenna.

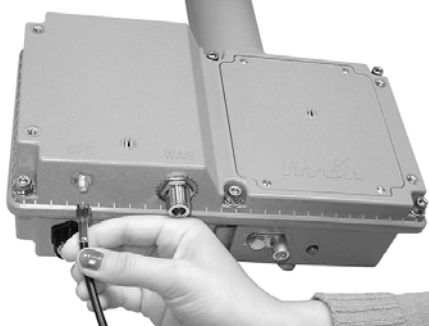

2. The WAN cable has an N connector on each end. Connect one end of the WAN antenna cable to the collector. Connect the other end of the cable to the external WAN antenna.

Note Repeaters do not use WAN antennas.

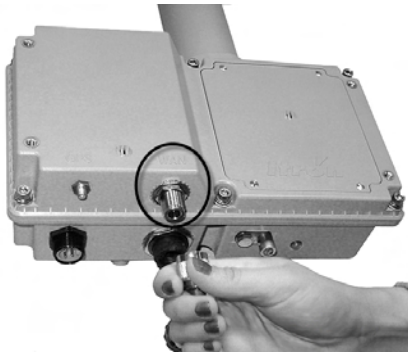

3. If you are using a remote 900 MHz antenna, attach the 900 MHz antenna cable to the connector on the top of the collector or repeater. This connection must be weatherproofed as described in the following steps.
 - a. Attach the coaxial cable to the top of the collector.

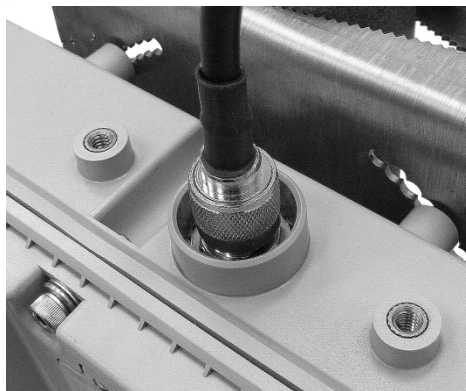

- b. Wrap vinyl electrical tape around the connection starting at the collector and moving up the cable as shown in the following illustration.

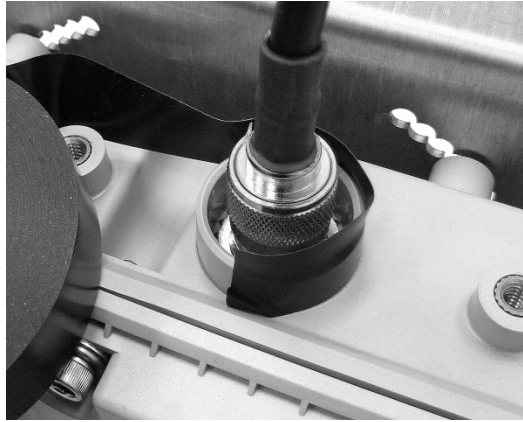

The vinyl electric tape provides a foundation for the butyl rubber sealant, making it easier to disconnect the cable.

- c. Wrap the vinyl electric tape up the coaxial cable overlapping each wrap as shown in the following illustrations.

Ensure the tape fully covers the cable strain relief.



- d. Wrap a layer of butyl rubber sealant over the vinyl electric tape. Ensure the butyl rubber extends past the vinyl tape and onto the cable jacket.



- e. Overlap the butyl rubber so there is no gap. The butyl rubber will self-vulcanize over time and the seam will disappear.



- f. Wrap vinyl electric tape around the butyl rubber starting at the CCU and moving up as you did in Step a.

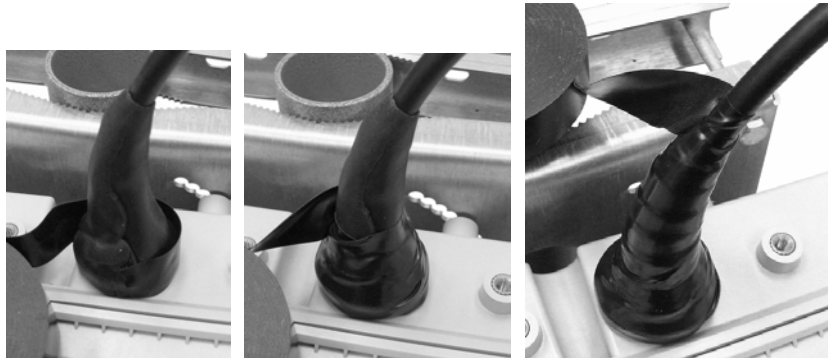

- g. Continue wrapping the vinyl tape in a spiral back down to the collector. You now have two layers of vinyl tape covering the butyl rubber.



- 4. If you are using an Ethernet backhaul, attach the Ethernet cable ensuring the weather-tight connector is properly secured. If the Ethernet connection is not used, secure the weatherproof cap.
- 5. Attach the grounding lug to earth ground according to local codes.

Installing a Local 4G WAN Antenna

Warning Do not install an 8.15 dBi antenna directly on the CCU/repeater. Antenna installation directly on the CCU will compromise mechanical integrity and will not meet the compliance requirement for a loss of 2.2 dB between the CCU/repeaters and the 8.15 dBi antenna.

To attach the local 4G WAN antenna

1. Remove the 4G WAN antenna from the main CCU shipping box.



2. Attach the 4G WAN antenna on the N-Connector on the bottom of the CCU labeled WAN.



Installing the Battery

If you are installing a battery with a ferrite bead on the wires, as shown in the following illustration, follow the directions in [To install a battery \(ferrite bead\)](#) on page 35.

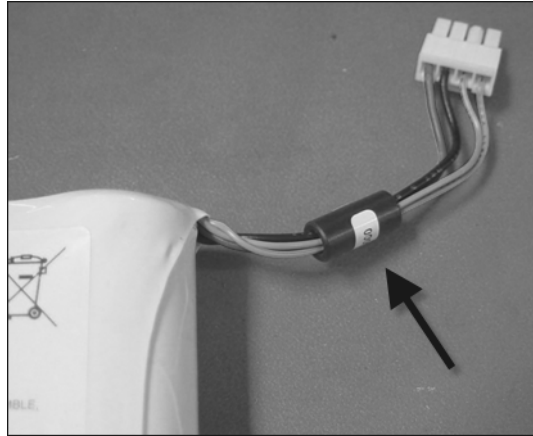

If the battery does not have a ferrite bead on the wires, see [To install a battery](#) on page 34.

To install the battery

1. Remove the battery cover by loosening the four screws securing it. These are captive screws. It is not necessary to fully remove the screws from the battery cover.
2. Plug in the four pin battery wiring harness. The harness should snap into place, providing a secure connection.



- Slide the battery into the battery compartment.



- Replace the battery compartment cover, and torque the screws to 6 inch-pounds.

To install a battery (ferrite bead)

- Insert the battery connector into the connector on the CCU 100.

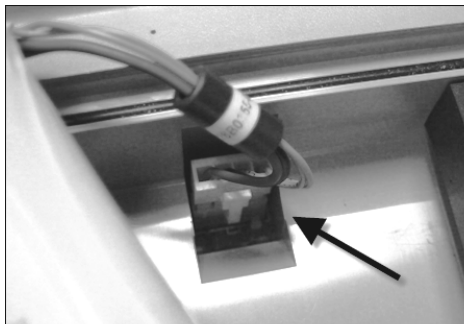

- Align the edges of the ferrite bead with the edges of the recess in the battery well.

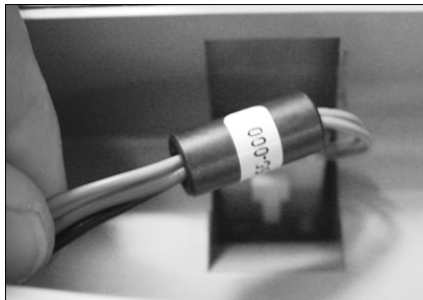

3. Press the ferrite bead into the recess in the battery well.

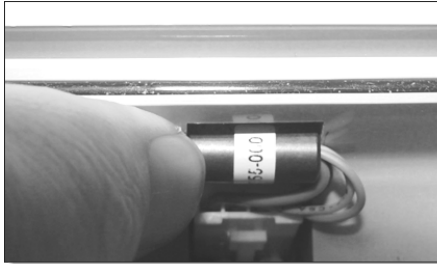

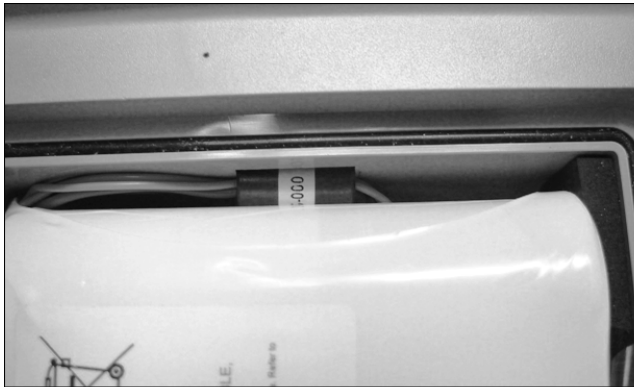

4. Place the battery in the battery well as shown in the following graphic.



Providing Power

The final step of the collector or repeater installation is to provide power to the equipment. Depending on the collector or repeater model, either a two pin cable (DC), three pin cable (AC), or a five pin cable (solar) is required.

 **Caution** Do not move or tilt the collector for one minute after connecting power. Moving or tilting a collector too soon after connecting power causes the factory software and configuration to be loaded.

 **Warning**
Securely mount the collector or repeater before connecting the dedicated AC mains power source.
The collector or repeater must be grounded by either the ground wire in the three conductor cable, or the grounding lug on the bottom of the equipment. For installations that use the photocell adapter, the grounding lug must be used to ground the collector.

To provide power

1. Plug the appropriate cable in to the collector or repeater.

Note The connector is keyed so the cable can connect in only one orientation.

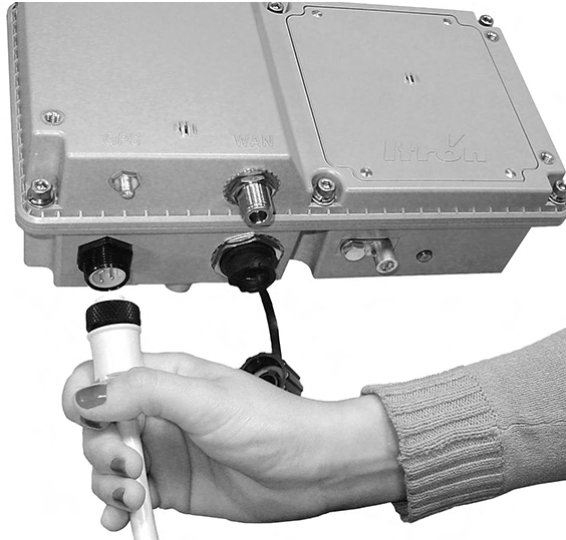

2. Securely fasten the power cable to the collector or repeater by tightening the retaining nut on the cable.

CCU Installation Wiring Diagram

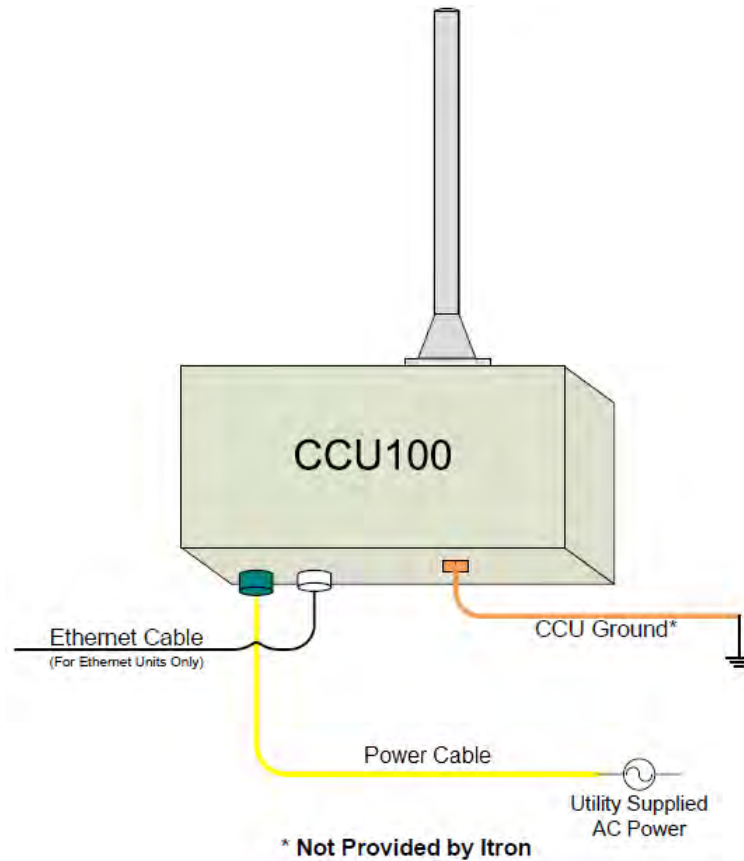

Tower Installation

Warning Before installing a Tower CCU, ensure that the selected location can support the weight of the Tower CCU and mounting hardware. A thorough structural analysis should be performed by a registered professional engineer at location prior to installation. Itron is not responsible for improper installations or for installations at a site that cannot adequately support the Tower CCU.

You must use 3/8–16 bolts to secure the enclosure to the pierced and slotted metal brackets.

All coaxial cable connections must be properly weather-proofed per industry standards unless otherwise specified. This includes any connections for the antennas and the Tower CCU. If the Tower CCU is installed indoors, only the connections located outside must be weather-proofed.

Important To prevent exceeding the maximum EIRP set by the FCC, there must be at least 2 dB of loss between the antenna connector at the base of the tower cabinet and the high gain 900 MHz antenna. Do not exceed 3.5 dB of loss to maintain system performance. Only use the Itron-approved high gain antenna.

Because of the size and weight of the Tower CCU, Itron recommends more than one person be present for the installation.

For more information, see the *Tower Enclosure CCU 100 Basic Installation Quick Reference* (TDC-0964-000).

Tower Installation Overview

The Tower CCU 100 (TCU) installation differs significantly from other CCU 100 installation profiles in that the CCU 100 is installed within a cabinet enclosure at the base of a radio tower, and all of the antennas are mounted externally and remotely. The standard cabinet protects the hardware from adverse environmental conditions and provides easy access for servicing the TCU and its related components.

The TCU may be installed in one of three configurations:

- **Pole mount.** In this configuration, the TCU enclosure is attached to a large diameter pole (3" to 12" diameter) with metal straps and pierced and slotted brackets (kit available from Itron).
- **Pedestal mount.** In this configuration, the TCU enclosure is mounted on a pedestal that is bolted to a stable and secure surface (kit available from Itron).



- **Wall/H-Frame mount.** In this configuration, the TCU is bolted to a stable and secure vertical surface, such as a wall or h-frame, with 3/8–16 (min) bolts and pierced and slotted brackets (no kit).



The TCU box comes preassembled except for the CCU.

- **Caution**  Prior to installing a CCU in the field, be sure to configure it as described in the *CCU 100 Collector Configuration Guide*. A CCU cannot be configured after it has been installed in the field. Repeaters do not require pre-installation configuration.

TCU Components

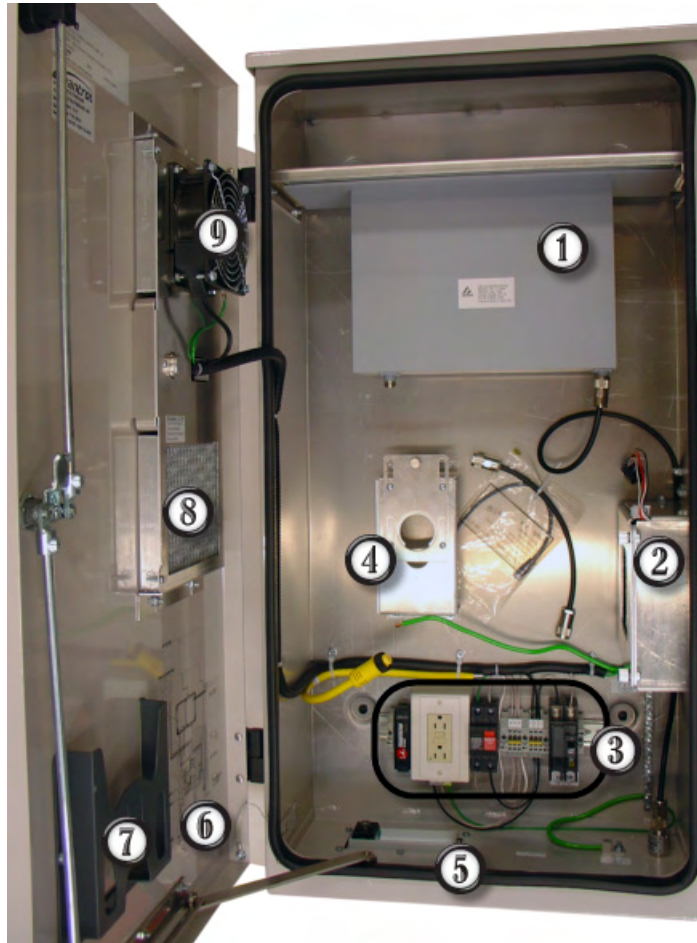

- 1 RF Filter
- 2 Battery
- 3 Surge protection devices (SPDs), receptacle, terminal blocks
- 4 Collector mounting plate
- 5 Roxtec™ block
- 6 Wiring diagram
- 7 Document holder
- 8 Air filters There are two air filters, one shown at (8) and another behind the fan (9).
- 9 Fan

To assemble the Tower CCU 100

- ! **Important** This unit must be installed in accordance with the National Electrical Code and with all local codes. Provide power to the cabinet using electrical conduit. Itron recommends using a knockout punch and die (such as a Greenlee® Slug-Buster®) to punch the appropriate sized hole in the bottom of the cabinet.

1. Attach the TCU to the TCU mounting plate.
 - a. Insert the TCU mounting disc into the mounting plate keyhole.
 - b. Slide the TCU down until you feel it click into place.
2. Connect the cable from the TCU to the RF filter.

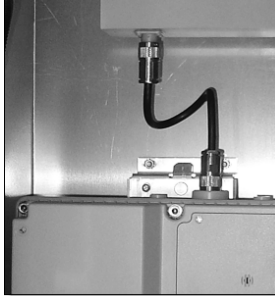

3. Connect the ground wire to the TCU.

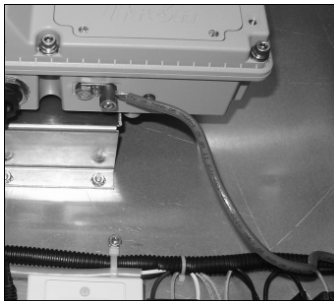

4. *(Optional)* Connect the Ethernet cable to the TCU and the top of the 10/100 BT SPD. Feed the external Ethernet cable through the Roxtec block and connect it to the bottom of the 10/100 BT SPD.

Instructions for using a Roxtec Block are supplied in the TCU cabinet.



5. Connect the battery to the connector on the battery door of the TCU.
The battery door connection is only present on collectors designed for TCU installations.

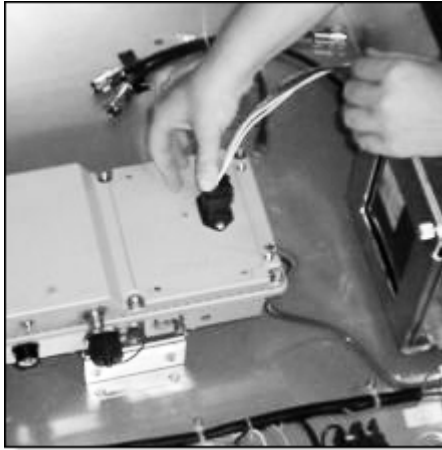

6. Feed the GPS and WAN (if required) antenna cables through the Rextec block and connect them to the TCU.



7. Connect the power cable to the TCU.

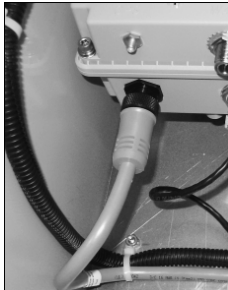

8. For instructions on installing the antennas, see [Attaching the Local GPS/WAN Antennas](#) on page 20.
9. Connect power to the cabinet. See the wiring diagram on the inside of the cabinet door. Provide power to the cabinet using electrical conduit. Itron recommends using a knockout punch and die (such as a Greenlee® Slug-Buster®) to punch the appropriate sized hole in the bottom of the cabinet.

Tower CCU Wiring Installation Diagram

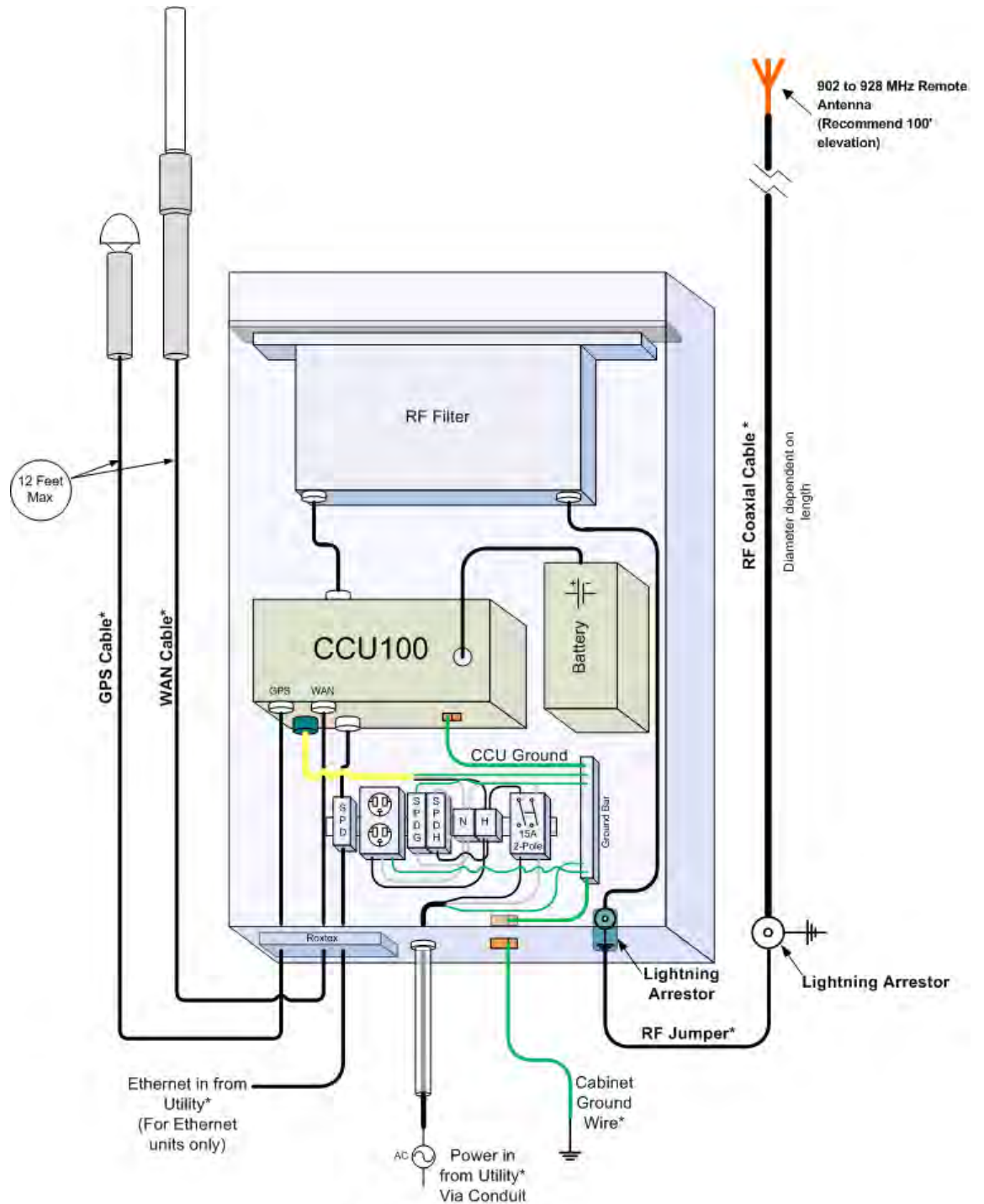

Solar Powered Installation

The solar collector or repeater is mounted like other collectors and repeaters, but the power comes from the solar cabinet which houses the solar controller and batteries. The following picture shows a typical solar installation with a TCU 100.



 **Warning** Before installing a collector or repeater, ensure that the selected location can support the weight of the collector or repeater, mounting hardware, solar panels, and batteries. A thorough structural analysis should be performed by a registered professional engineer at your desired location prior to installation. Itron is not responsible for improper installations or for installations, at a site that cannot adequately support the collector or repeater.

Because of the size and weight of the solar system, Itron recommends more than one person is present for the installation.

Sunwize Solar Panel Wiring Legend

The following diagram illustrates how an Itron Sunwize solar panel system must be wired to connect to the collector or repeater.

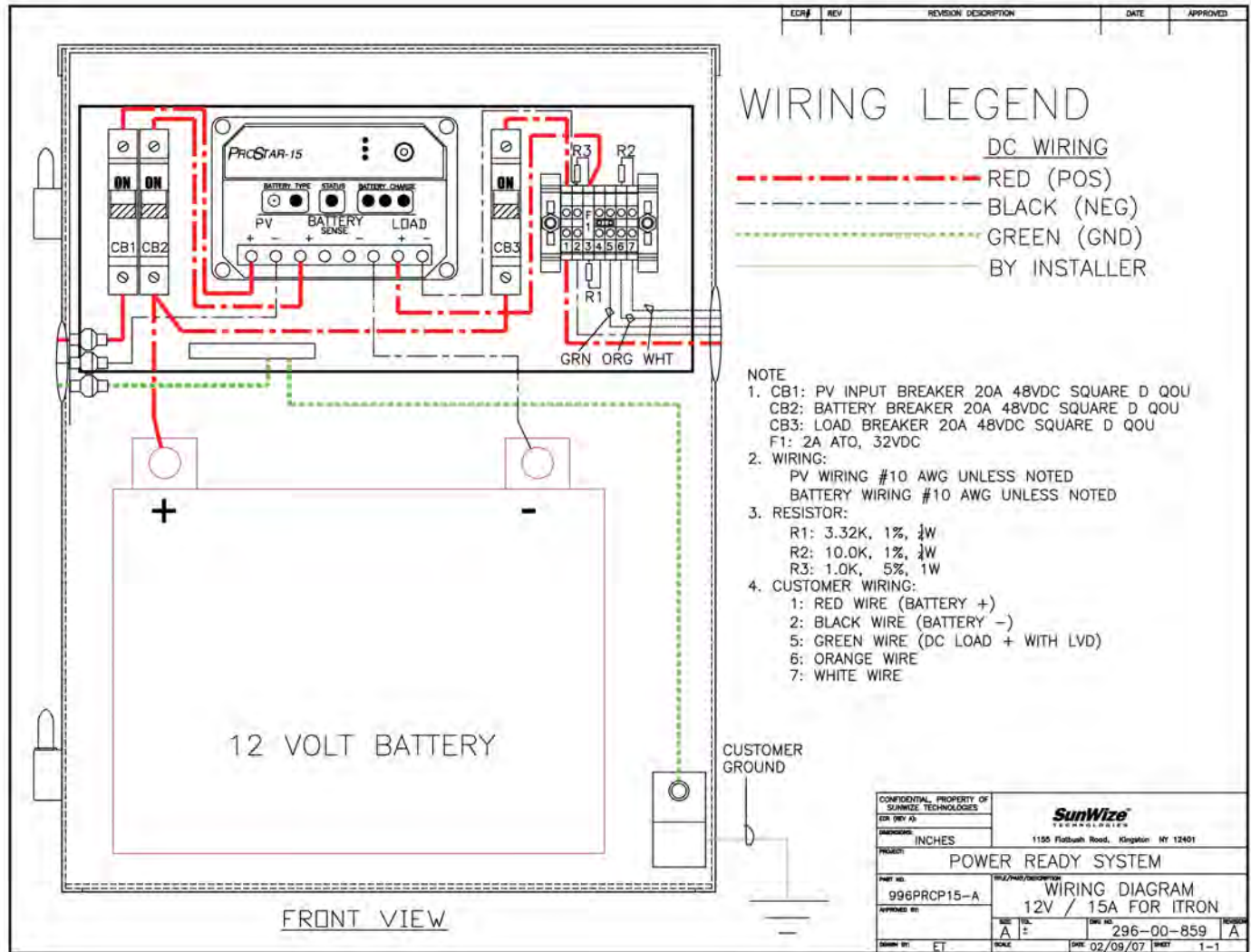

To assemble the Solar CCU 100

1. Mount the solar panels and battery box as described in the *Installation, Operation, and Maintenance Manual* supplied with the solar system.
2. Set the photovoltaic (PV) array's tilt and azimuth to the angles recorded in the design specifications provided by Itron.

The **Array Tilt** value is the angle of the array from horizontal.

The **Array Azimuth** value is the angle of the array clockwise from true north.

The following diagram illustrates tilt and azimuth angles.

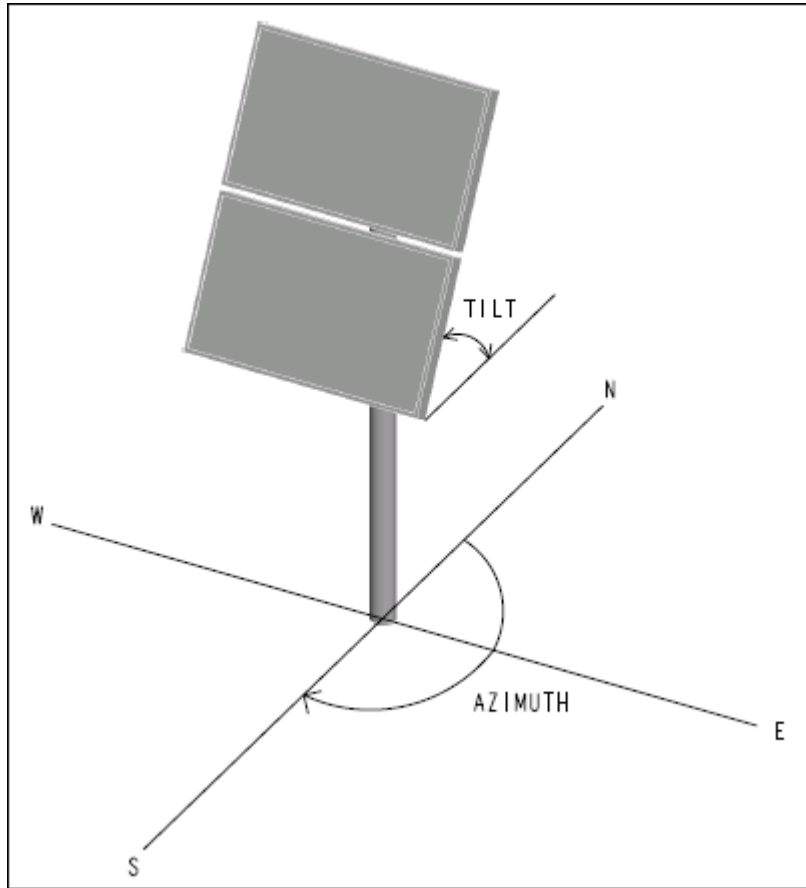

If you do not have the design specifications at the installation site, see [To set array tilt and array azimuth using the PVWatts website](#) on page 48.

3. Wire the five-conductor power cable to the solar cabinet, as shown in the [Solar Wiring Diagram](#) on page 46. Use the watertight grommet supplied with the solar cabinet.



- **Red.** Collector or repeater power +
 - **Black.** Collector or repeater power -
 - **Green.** Low battery indicator
 - **Orange.** Solar ID_1
 - **White.** Solar ID_2
4. Mount the collector or repeater in the desired location.

Note The supplied power cable from the solar battery box to the CCU/repeater is only 12 feet long.

5. Place the 12V battery in the battery box.
6. Connect a ground wire to the collector grounding lug.
7. If required, connect the antenna and Ethernet cables to the CCU/repeater.
For instructions on installing the antennas, see [Attaching the External GPS/WAN Antennas](#) on page 20.
8. Connect the power cable to the CCU.

To set array tilt and array azimuth angles using the PVWatts website

1. Go to http://gisatnrel.nrel.gov/PVWatts_Viewer/index.html.
2. Type the **Zipcode**, the **Address**, or the **Coordinates** for the solar installation and click **Go**.
3. Click **Send to PVWatts**.

4. Ensure the **Array Type** is set to **Fixed Tilt**.
5. Set the photovoltaic (PV) array's tilt and azimuth to the angles shown on the PVWatts website.

The **Array Tilt** value is the angle of the array from horizontal. The default value normally maximizes annual energy production. For information about the tilt angle, click **Array Tilt**.

The **Array Azimuth** value is the angle of the array clockwise from true north. The default value normally maximizes energy production. For more information about the azimuth angle, click **Array Azimuth**.

The following diagram illustrates tilt and azimuth angles.

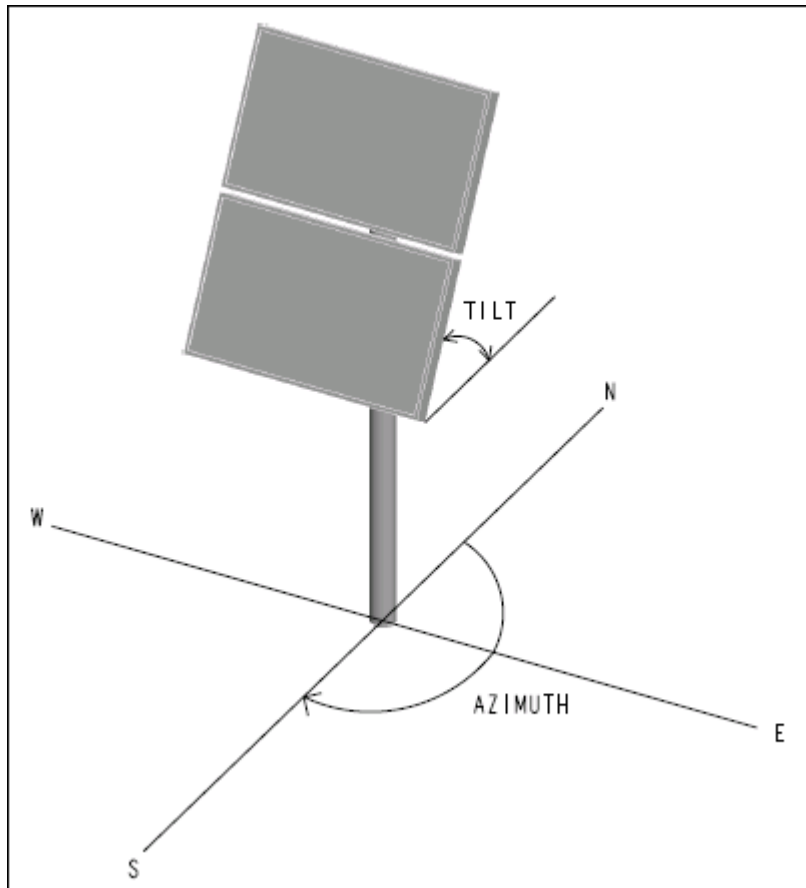

Solar Installation Wiring Diagram

The following diagram shows a typical solar powered installation.

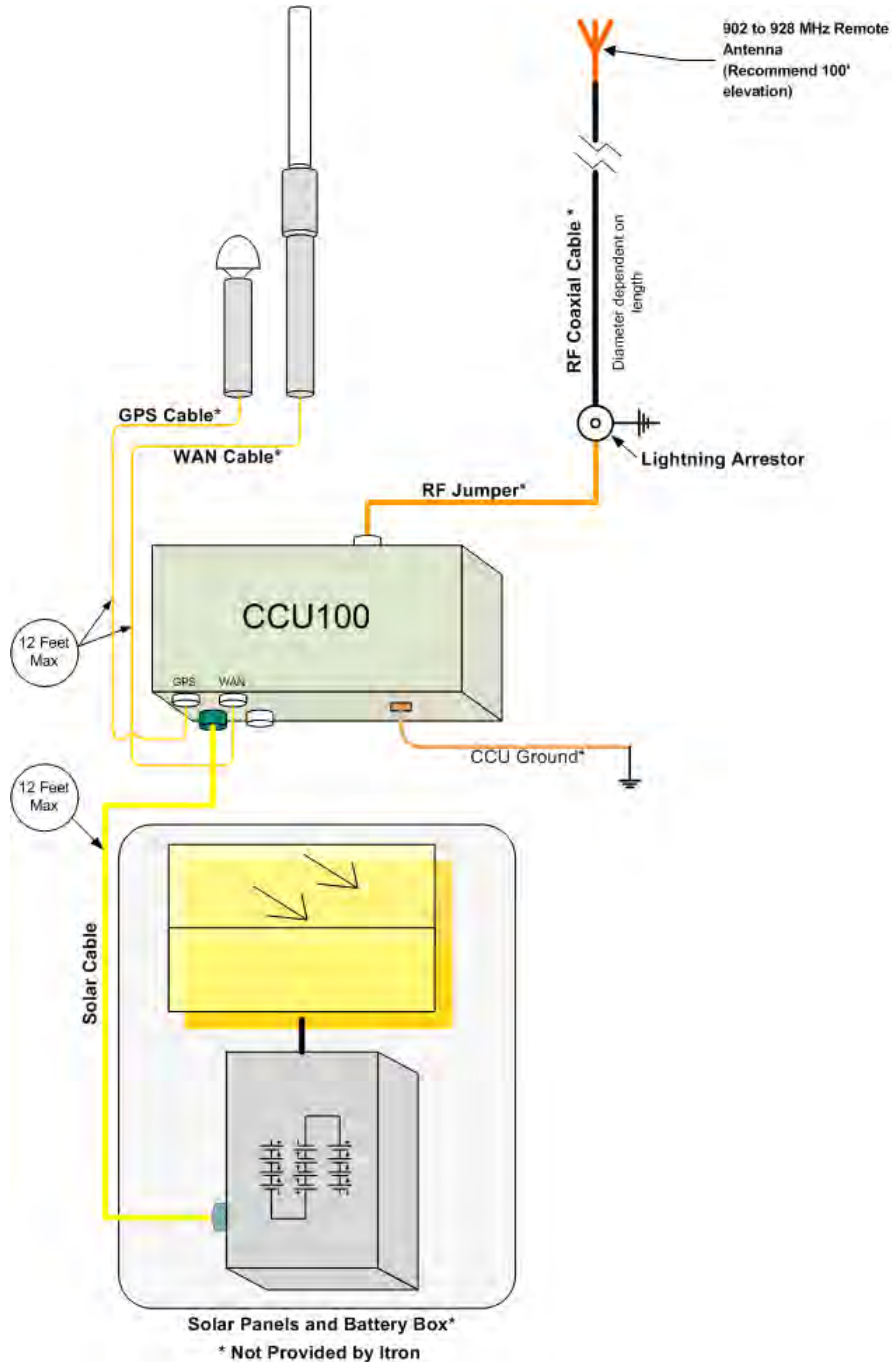

Relocating a CCU or Repeater

1. Disconnect the AC power.

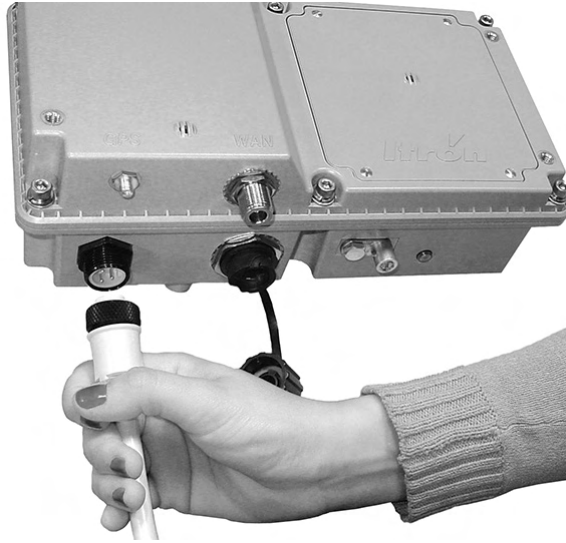

Caution Do not disconnect the battery.

2. Relocate the CCU or the repeater.
3. Reconnect the AC power.

Battery Care and Maintenance

This chapter provides instructions for performing field maintenance on the collector or repeater battery. The following sections describe storing and charging spare collector and repeater batteries, and replacing a collector or repeater battery in the field.

Shipping Requirements



Warning! Electrical fire hazard—protect against shorting.

Terminals can short circuit and cause a fire if they are not insulated during shipping.

Requirements for shipping batteries:

- Batteries must be labeled "NONSPILLABLE" during shipping. Follow all federal shipping regulations. See CFR 49 Parts 171 through 180, available online at www.gpoaccess.gov.
- Batteries must have short circuit protection during shipping. Exposed terminals, connectors, or lead wires must be insulated with a durable inert material to prevent exposure during shipping.

Failure to comply with these requirements can cause a fire during shipping and handling.

Battery Storage and Charging

To ensure maximum lifespan and efficiency from your collector or repeater batteries, Itron recommends the following storage and maintenance procedures.

Long-Term Storage

Batteries may be stored for up to two years at room temperature (25°C or 77°F), and then may be recharged with no loss in cell reliability or performance capabilities. The following storage time versus temperature chart is a plot of maximum storage time as a function of storage temperature. This curve shows the maximum number of days at any given temperature, from 10°C (50°F) to 65°C (149°F), for the battery to discharge from a fully charged state of about 6.42 volts (2.14 volts per cell) down to a zero charge state of 5.79 volts or (1.93 volts per cell). Do not allow the battery to discharge below 5.79 volts. A battery discharge below 5.79 volts may permanently damage the performance characteristics of the battery.

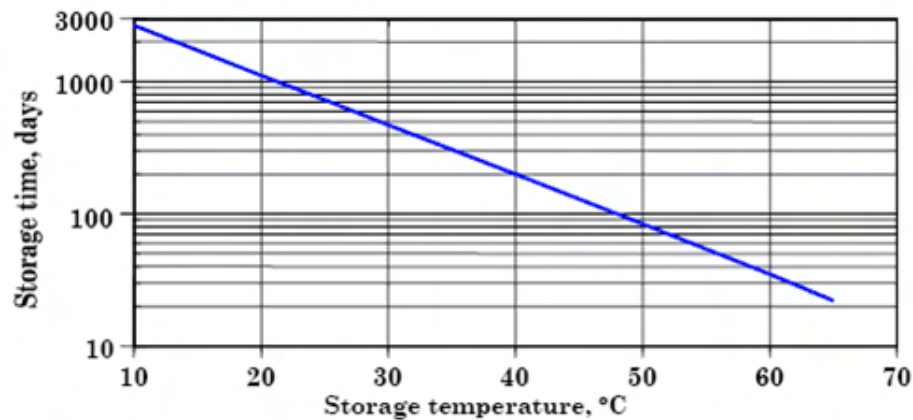

Itron recommends you conduct open circuit voltage audits every six months on batteries stored at or near 25°C (77°F). Recharge batteries when OCV readings approach 6 volts (2.00 volts per cell). Increase OCV audits if storage temperatures are significantly higher than 25°C (77°F)—even for short durations.

It is important to recognize the self-discharge rate of the battery is non-linear. The rate of self-discharge changes as the battery's state of charge (SOC) changes. The time taken for a battery to discharge from a 100% SOC to 90% SOC is different from the time it takes to self-discharge from a 20% SOC to a 10% SOC.

State of Charge

The state of charge (SOC) of the battery can be approximated by using the curve shown in the following chart. This curve is accurate to within 20% of the true SOC of the cell under consideration, if it has not been charged or discharged within the past 24 hours. The curve is accurate to within 5% if the cell has not seen any activity, charge or discharge, for the past five days.

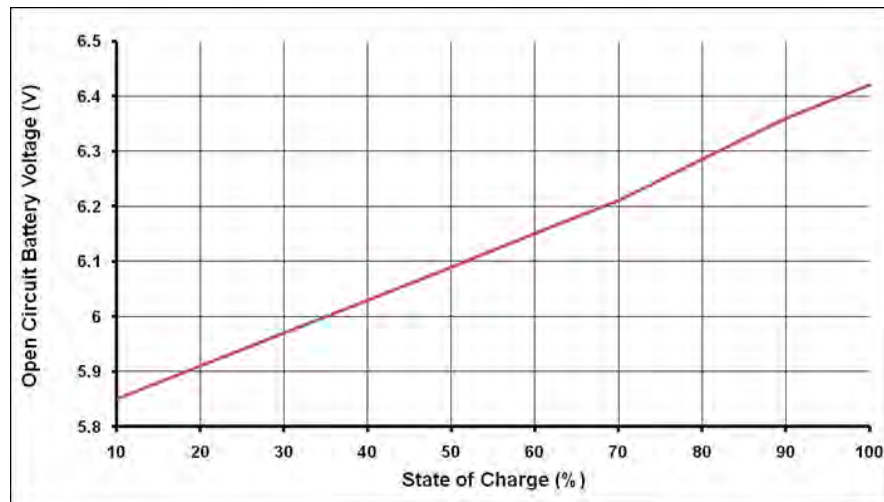

Charging the Battery

You can charge spare collector and repeater batteries individually, or in groups, to save time.

The charging of collector and repeater batteries requires the following items:

- Power Sonic PSC-61000A-C charger
- Molex 39-01-4046 connector
- Collector or repeater batteries

The recommended method for charging batteries is to utilize the Power Sonic PSC-61000A-C charger. The Power Sonic charger requires modification so it can be plugged directly into the battery. This is done by retrofitting the output of the charger to a Molex 39-01-4046 connector with the red wire going to pin one and the black wire going to pin two of the connector. Follow the instructions that come with the charger for correct operation.

After charging, the battery should be removed from the charger for at least 24 hours. After this time the open circuit voltage should be measured to verify it is at or above 6.4 volts.

- **Note** Batteries in storage must be charged routinely for maximum shelf life. For more information, see [Long Term Storage](#) on page 54.

Battery Service Life

All batteries have a variable service life, depending upon the type of cycle, environment, and charge to which the cell or battery is subjected during its life. There are two basic types of service life: cycle life and calendar life. The battery in the collector or repeater is called in to service only during power outages, so in this case only calendar (or float) life is applicable.

Calendar Life

The design calendar (or float) life of the battery extends from eight to ten years at room temperature (25°C/77°F) under proper charging conditions.

This design life was confirmed by the use of accelerated testing methods that are widely accepted by both manufacturers and users of sealed-lead batteries. High temperatures are used to accelerate the aging process of the battery under test.

The float life of a cell is cut in half for roughly every 8°C (14.4°F) rise in ambient temperature. The example below shows the relationship between ambient temperature and float life for batteries that have a float life of ten years at 25°C (77°F).

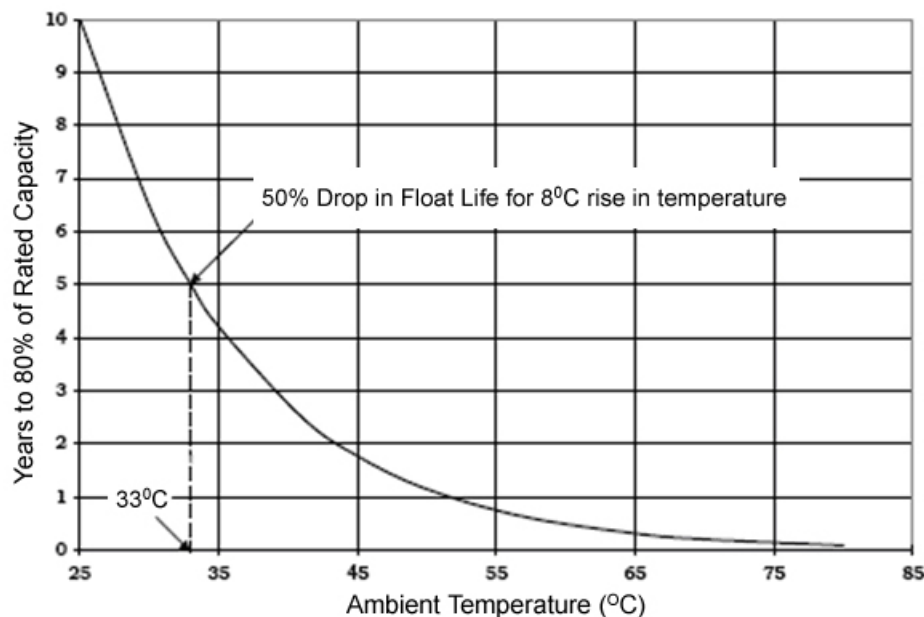

A ten year battery lasts for five years at 33°C (91.4°F) and only 2½ years at 41°C (105.8°F).

Preventative Maintenance

Itron recommends a preventative maintenance cycle of a two-year replacement in extreme environments (average temperatures greater than 110°F/44°C), or five years in non-extreme environments (average temperatures less than 90°F/31°C).

Replacing the Integrated Battery

The following procedure describes the integrated battery replacement after the equipment is installed in the field.

 **Warning** There is a risk of explosion if the battery is replaced by an incorrect type. Always replace with Itron part number BAT-0045-001.

For information on battery disposal or recycling, contact EnerSys at 1.800.363.7797 or recycling@enersys.com.

To replace the battery

1. Remove the battery compartment cover by loosening the four screws securing it.
2. Slide the battery out of the battery compartment.
3. Carefully, disconnect the four pin connector.
4. Connect the new battery's four pin connector.
5. Slide the new battery into the battery compartment.
6. Replace the battery compartment cover, and torque the screws to 6 inch-pounds.

APPENDIX A

Detailed Collector or Repeater Specifications

CCU or Repeater Dimensions and Weight

Weight is shown in pounds and dimensions are shown in inches.

Component	Weight
CCU 100 or Repeater 100	7 lbs
TCU 100 AC tower unit	76 lbs
External GPS/WAN antenna system	6 lbs
Remote 900 MHz antenna system	3.5 lbs
900 MHz antenna (standard, unity gain)	1 lb
Pole mounting kit	3 lbs
Wall mounting kit	2 lbs



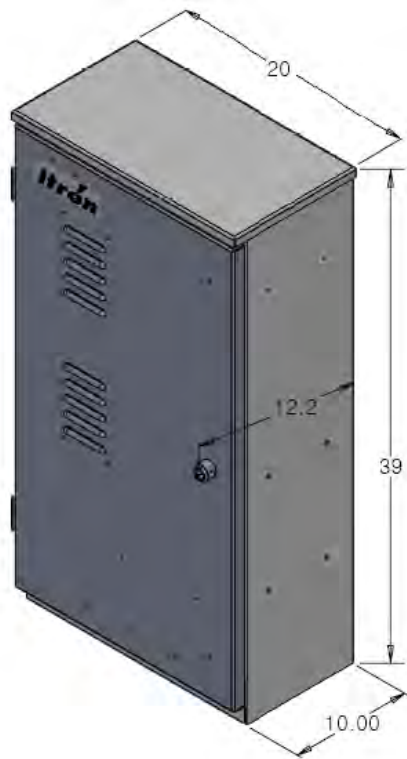

TCU 100 mounting hole dimensions

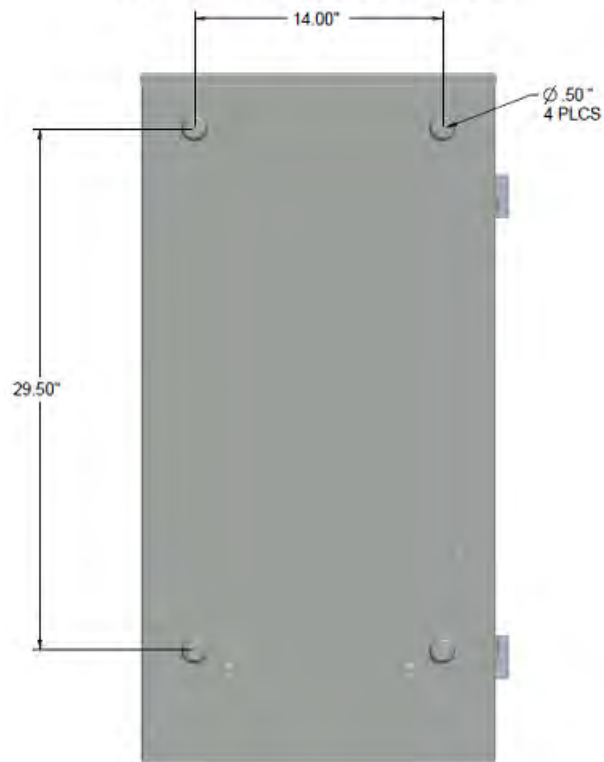

The following illustration shows the dimensions for the optional pedestal unit. This unit ships with a gasket and fasteners to attach the cabinet to the pedestal.

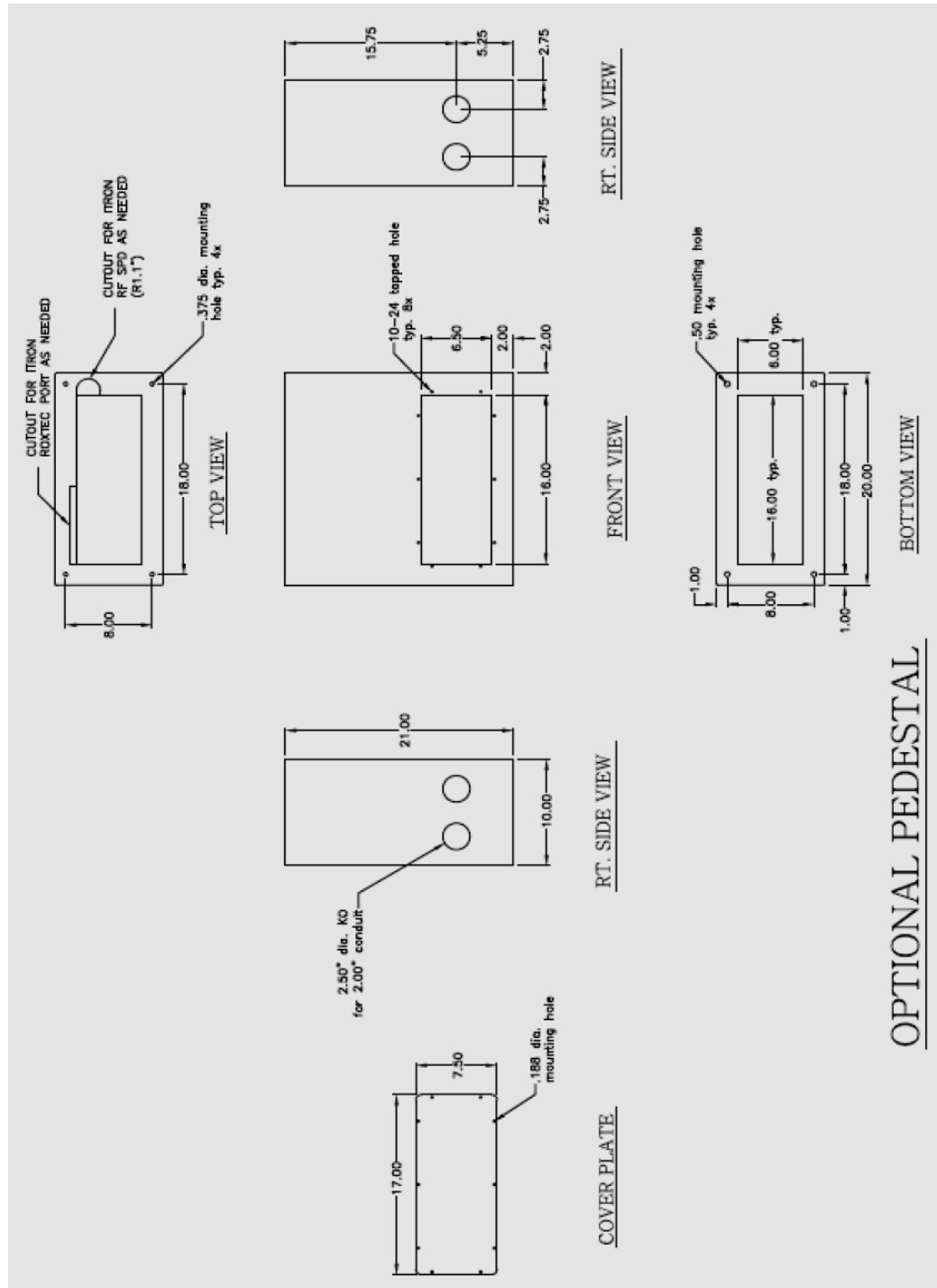

Antenna Specifications

Specifications for the 900 MHz, GPS, and WAN antennas are listed in the following tables.

- Important** All coaxial cable connections must be properly weather-proofed per industry standards unless otherwise specified. This includes any connections for the antennas and the collector or repeater components. If the collector or repeater is installed indoors, only the connections located outside need to be weather-proofed.

This device has been designed to operate with the antennas listed below. Antennas not included in this list are strictly prohibited for use with this device. The required antenna impedance is 50 ohms.

900 MHz Antennas		
Specification	Standard 5.15 dBi	High gain (8.15 dBi)
Gain	3 dBd (5.15 dBi)	6.0 dBd (8.15 dBi)
Horizontal beam width	Omni directional	Omni directional
Vertical beam width	-3dB minimum, +/- 16 degrees from horizontal	17 degrees
Electrical down tilt available	0 degrees	0 degrees
Power rating	50W	100W
Impedance	50 ohms	50 ohms
Termination	Type N male	Type N female
Lightning protection	Direct ground	Direct ground
Overall length	18 in.	65 in.
Radome diameter	1.00 in. OD	1.310 in. OD
Mounting area length	n/a	~8 in.
Weight (without clamps)	1 lb.	3 lbs.
Maximum wind speed	160 mph	125 mph
Wind load @ rated wind speed	n/a	57 lbs.

GPS/WAN Antennas				
Specification	GPS	WAN-3G	WAN-4G Local	WAN-4G Remote
Gain	30 dB	0 dBd (806-896) 3dBd (1850-1990)	2 dBi	4.5 dBi
Horizontal beam width	Omni directional	Omni directional	Omni directional	Omni directional
Power rating	N/A	100W	25W	150W
Impedance	50 ohms	50 ohms	50 ohms	50 ohms

GPS/WAN Antennas				
Specification	GPS	WAN-3G	WAN-4G Local	WAN-4G Remote
Termination	Type TNC female	Type N female	Type N male	Type N male
Frequency	1575.42 MHz	806-896 MHz 1850-1990 MHz	690-894 MHz 1710-2170 MHz	698-960 MHz 1710-2170
Polarization	RHCP	Vertical	Vertical	Vertical
Prime power	3.3 V DC	N/A	N/A	N/A
Overall length	2.61 in.	13.75 in.	5.07 in.	12.60 in.
Radome diameter	3.05 in.	1.310 in.	0.90 in.	0.95 in.
Weight	6 oz.	< 1.0 lb.	< 1.0 lb.	< 1.0 lb.

For the latest antenna part numbers, see the *Fixed Network 100 Ordering Guide* or contact your Itron representative.

To reduce potential radio interference to other users, select an antenna type with gain such that the equivalent isotropically radiated power (e.i.r.p.) is not more than that permitted for successful communication.

Industry Canada Conformity

This radio transmitter (IC: 864A-CCU100, IC:864A-CCU100A, IC:864A-CCU100B and IC:864A-CCU100T, IC:864A-CCU100TA, IC:864A-CCU100TB) has been approved by Industry Canada to operate with the antenna types listed previously with the maximum permissible gain and required antenna impedance for each antenna type indicated. Antenna types not included in this list, having a gain greater than the maximum gain indicated for that type, are strictly prohibited for use with this device.

Le présent émetteur radio (IC: 864A-CCU100, IC:864A-CCU100A, IC:864A-CCU100B et IC:864A-CCU100T, IC:864A-CCU100TA, IC:864A-CCU100TB) a été approuvé par Industrie Canada pour fonctionner avec les types d'antenne énumérés ci-dessus et ayant un gain admissible maximal et l'impédance requise pour chaque type d'antenne. Les types d'antenne non inclus dans cette liste, ou dont le gain est supérieur au gain maximal indiqué, sont strictement interdits pour l'exploitation de l'émetteur.

Environmental Specifications

The following environmental specifications are associated with a collector or repeater.

Specification	Value
Operating temperature	Components GPS/WAN antenna system: -33° C to 60° C CCU/repeater: -33° C to 60° C
Storage temperature	-40° C to 85° C Note Batteries may be stored for up to two years at 25° C without periodic recharging. When batteries are stored at this temperature, conduct an open circuit voltage audit every six months. If the storage temperature is significantly higher than 25° C, increase the frequency of the audits.
Humidity	0 to 90% non-condensing

Transmitter

Collector or repeater transmitter specifications are described in the following table.

Specification	Value
Maximum transmit power at antenna	29.5 dBm (The transmitter is disabled in CCU part number CCU-6626-002.)
Frequency	903.0 MHz to 926.8 MHz (USA)

Diagnostic Radio

Collector or repeater diagnostic radio specifications are described in the following table.

Specification	Value
Type	IEEE 802.11b/g
Frequency	2.4 GHz
Bandwidth	20 MHz

Collector or Repeater Power Operating Range

Specification	Value
Voltage (AC)	90 VAC to 265 VAC
Voltage (DC)	+12 VDC typical +11.7 VDC minimum +17.0 VDC maximum
Frequency	47 Hz to 63 Hz
Average power	10 Watts (battery trickle charge)
Peak power	50 Watts

Battery Pack

The battery pack is contained in its own compartment. The battery pack is a three-cell, sealed, lead acid battery pack (6V, 4.5 amp-hours) that is field replaceable and designed to last five years under normal circumstances. To ensure minimal impact upon battery life, a preventative maintenance schedule of two-year replacement is required in an extreme environment, such as a desert installation. Normal preventative maintenance is every five years for non-desert environment installations.

 **Warning** There is a risk of explosion if the battery is replaced by an incorrect type. Always replace with Itron part number BAT-0045-001.

The batteries can power the system for a duration of 90 minutes in the case of a power outage.

If	Then
AC power fails	The collector or repeater battery pack maintains system functions for approximately 90 minutes. A message indicating the AC failure is sent to the Network Collection Engine.
AC power is restored	A message is sent to the Network Collection Engine indicating AC power has been restored.

The battery pack specifications are listed in the following table.

Specification	Value
Type	Sealed-lead acid, rechargeable
Power	6V, 4.5 amp-hours
Life	Five years at 33° C. Battery life decreases by 50% for each 8° C rise in temperature above 25°C.
Charge time	10 hours at 25° C

The battery in the collector or repeater uses three EnerSys Cyclon lead-acid cells, connected in series, to provide a nominal voltage of 6 volts. The battery is terminated with a four position Molex connector (Molex P/N #39-01-4041) with the following pinout:

Pin #	Wire Color	Signal
1	Red	+V BATT
2	Black	Ground
3	White	Thermistor
4	White	Thermistor

For information on battery disposal/recycling, contact EnerSys at 1.800.363.7797 or recycling@enersys.com.

APPENDIX B

Port and Protocol Requirements

Network Collection Engine (NCE) installations are typically deployed when CCUs are on the Internet, the Fixed Network web server is in a DMZ, and the Fixed Network database server is in the corporate intranet. The following illustration is a simple diagram of the network topology.

Note The Network Administrative Application (NAA) server may be hosted on the same server as the database server.

Logical Architecture of Fixed Network (Multiple Network Zones)

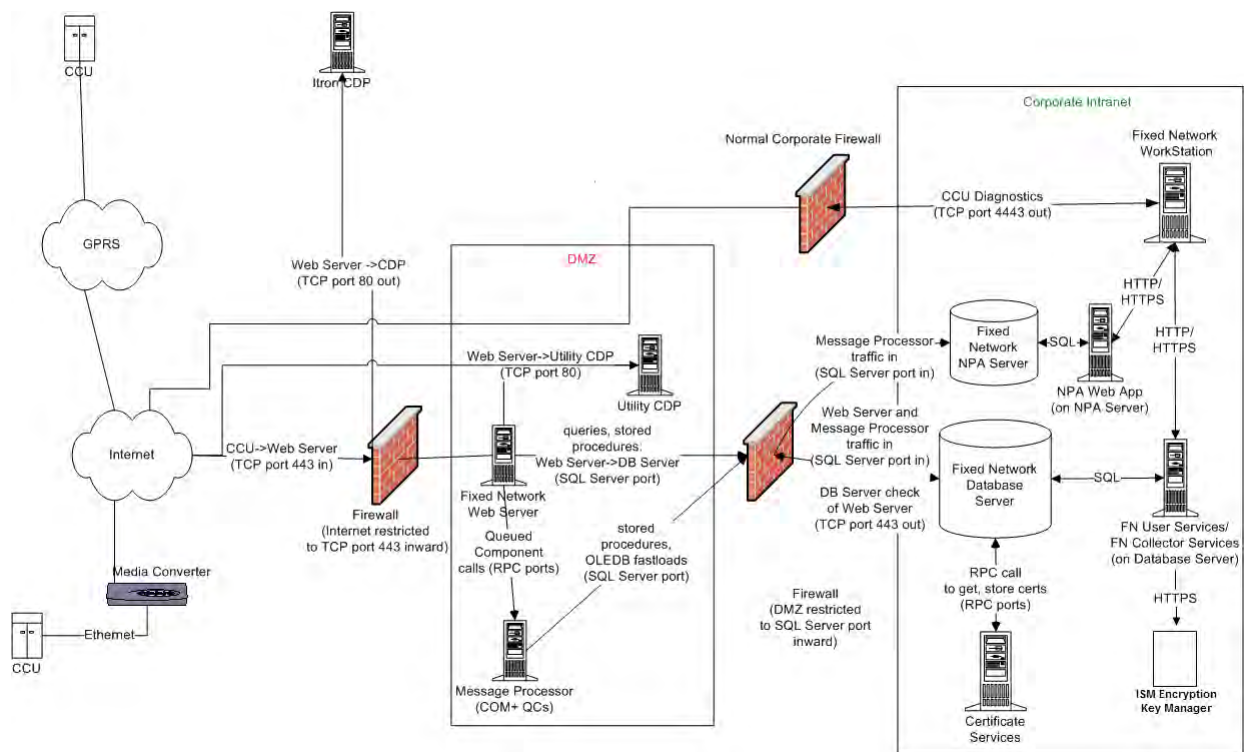

This diagram, while accurate, simplifies the situation considerably and is not a useful format for formulating firewall rules. The following information describes the ports and protocols required for Fixed Network operations in greater detail.

Ports and Protocols

Fixed Network inbound traffic						
Source address	Source port	Destination address	Destination port	Protocol	Required for operation	Purpose
Collectors (any*)	Any	Fixed Network web server	443	HTTPS	Yes	CCU communications to web server's external address.
Collectors (any*)	Any	NTP server	123	UDP	Yes	CCU time sync to internal or internet time server. (External NTP servers can also be used).

Fixed Network web server outbound traffic						
Source address	Source port	Destination address	Destination port	Protocol	Required for operation	Purpose
Fixed Network web server	Any	cdp1.itron.com	80	HTTP	Yes	Itron Product Root Certificate Revocation List: http://cdp1.itron.com/CertEnroll/ItronProductRoot.crl .
Fixed Network web server	Any	Utility CDP	80	HTTP	Yes	Certificate Revocation List. Usually published from Fixed Network database server; however, varies per install.
Fixed Network web server	Any	CCUs (any)	4443**	HTTPS	Optional	Collector commands and diagnostic portal.
Fixed Network web server	Any	CCUs (any)	22	SSH	Optional	Itron collector diagnostics (CCU100 only).
Fixed Network web server	Any	ftp2.itron.com	21	FTP	Recommended	Itron Support Services.

Fixed Network database/NPA server outbound traffic						
Source address	Source port	Destination address	Destination port	Protocol	Required for operation	Purpose
Fixed Network database server	Any	Collectors (any)	4443**	HTTPS	Yes	Collector commands and diagnostic portal.
Fixed Network database server	Any	Collectors (any)	22	SSH	Optional	Itron collector diagnostics (CCU100 only).
Fixed Network NPA server	Any	198.182.8.60	21	FTPS	Optional	Itron engineering external NPA server.
Fixed Network database server	Any	ftp2.itron.com	21	FTP	Recommended	Itron Support Services.

Fixed Network database/NPA server outbound traffic						
Source address	Source port	Destination address	Destination port	Protocol	Required for operation	Purpose
Fixed Network database server	Any	Collectors (any)	4443**	HTTPS	Yes	Collector commands and diagnostic portal.
Fixed Network database server	Any	initial configuration router DHCP IP addresses	4443**	HTTPS	Yes	Collector shutdown, reboot, etc. Collector commands and diagnostic portal router required for v4.2 collectors only.
Fixed Network database server	Any	spatial.virtualearth.net	443	HTTPS	Yes	Geocoding web service for device maintenance.
Fixed Network database server	Any	www.mlogonline.com	80	HTTP	Yes	Leak sensor data export to mlogonline.
Fixed Network workstation	Any	dev.virtualearth.net	80	HTTP	Yes	Virtual Earth access for Network Administrative Application (NAA) mapping. (Microsoft may use other URLs such as those noted in the second group).
		ecn.dev.virtualearth.net	80	HTTP		
		common.virtualearth.net	443	HTTPS		
		staging.common.virtualearth.net	80	HTTP		
		mappoint-cds.live.com	443	HTTPS		
		renderv3.staging.mappoint.net	80	HTTP		
		(t0, t1, t2, t3).tiles.virtualearth.net	80	HTTP		
		vemapcontrol.vomsecnd.net	80	HTTP		
		dctfe.maps.globals.microsoft.com	80	HTTP		
		platform.maps.globals.microsoft.com	80	HTTP		

Fixed Network server to server traffic (DMZ → intranet)						
Source address	Source port	Destination address	Destination port	Protocol	Required for operation	Purpose
Fixed Network web server	Any	Fixed Network database server	1433**	MSSQL	Yes	Database access.
Fixed Network web server	Any	Fixed Network NPA server	1433**	MSSQL	Yes	Database access. Only needed if NPA database is on a different server than NCE.

Fixed Network server to server traffic (intranet → DMZ)						
Source address	Source port	Destination address	Destination port	Protocol	Required for operation	Purpose
Fixed Network database server (or CA server)	Any	Fixed Network web server or utility CDP	21	FTP	Optional	Sometimes used to publish CRL on certain installations.
Fixed Network database server	Any	Fixed Network web server	135-139 (Microsoft file sharing SMB) or 445 (Direct-hosted SMB without netbios)	TCP, UDP	Optional	Used to allow transfer of CRL (certificate revocation list) file where the CDP server is not utilized.

Fixed Network server to server traffic (intranet)						
Source address	Source port	Destination address	Destination port	Protocol	Required for operation	Purpose
Fixed Network database server	Any	Fixed Network NPA server	135-139 or 445	TCP,UDP or TCP,UDP	Yes	Data file export if NPA database is on a different server than NCE (UNC shares). Refer to Microsoft documentation for details. Microsoft file sharing SMB uses ports 135-139. Direct-hosted SMB without NetBIOS uses port 445.
Fixed Network database server	Any	Fixed Network web server	443	HTTPS	Yes	URL validation.
Fixed Network database server	Any	ISM server	443**	HTTPS	Optional	Encryption

Workstation to server traffic						
Source address	Source port	Destination address	Destination port	Protocol	Required for operation	Purpose
Fixed Network workstation	Any	Fixed Network database server	1433**	MSSQL	Yes	Database access for Collector Configuration Application (CCA) (Fixed Network 4.0 only).
Fixed Network workstation	Any	Fixed Network database server	80 443	HTTP HTTPS	Yes	Network Administration Application (NAA), Network Web Application (NWA), User Services, and Collector Services.
Fixed Network workstation	Any	Fixed Network NPA server	80 443	HTTP HTTPS	Yes	Network Performance Application (NPA).
Fixed Network workstation	Any	dev.virtualearth.net	80	HTTP	Yes	Virtual Earth access for Network Administrative Application (NAA) mapping. (Microsoft may use other URLs such as those noted in the second group).
		ecn.dev.virtualearth.net	80	HTTP		
		common.virtualearth.net	443	HTTPS		
		staging.common.virtualearth.net	80	HTTP		
		mappoint-cds.live.com	443	HTTPS		
		renderv3.staging.mappoint.net	80	HTTP		
		(t0, t1, t2, t3).tiles.virtualearth.net	80	HTTP		
		vemapcontrol.vo.msecnd.net	80	HTTP		
		dctfe.maps.globals.microsoft.com	80	HTTP		
		platform.maps.globals.microsoft.com	80	HTTP		
Fixed Network workstation	Any	ISM server	8001**	TCP, UDP	Optional	ISM server client

*Collector (Any): If the collectors' IP addresses are predictable (DHCP range, DHCP reservations, statically assigned), they can be allowed. Otherwise, any IP should be allowed.

** Port configurable.

Status and Diagnostics

Status Indicator

The LED Status Indicator is primarily intended to support installation personnel for immediate feedback. The following sequences define the Fixed Network solution's operational characteristics:

Sequence details: The *dot* time: 100 mSec

The *dash* time is 300 mSec

Off Time between *B* and *N*: 700 mSec

Off time between *dot* and *dash*: 100 mSec

Collector State	Description	LED Pattern
Off	The collector is not running.	Off
Powered (Host booting)	When power has been applied to the collector and the collector reset has been released allowing the boot operation to begin.	Solid continuous illumination
Time Acquisition	The collector is attempting to synchronize its system time with an external time reference through NTP and/or GPS. Note Repeaters do not support NTP. Instead, repeaters acquire time from either the collector or from GPS. If time is received from the collector, the repeater status indicator will not display the Morse T.	Morse code for the letter 'T' (_). A single 660 ms flash repeated every 10 seconds.
Starting	The Linux kernel has been loaded and initialized and the collector application begins execution.	Morse code for the letter 'P' (. _ _ .) with the dits at 220 ms the dahs at 660 ms and 220 ms spacing between the dits and dah. Repeated every 10 seconds.
ERT Heard	The radio processor has booted and is reporting end-point messages to the host processor.	Morse code for the letter 'N' (_ .)
Headend Connected	The collector has established an authenticated connection with the head-end over the configured WAN interface.	Morse code for the letter 'B' (_ . . .)

Collector State	Description	LED Pattern
No Battery	The collector has determined it should have a backup battery, but that battery does not appear to be present or is not functioning. The display of this state is a higher priority than all states other than Low-visibility, and will be displayed exclusively if the battery cannot be detected.	Morse code for the letter 'S' (. . .)
Ok	The radio processor has booted and is reporting end-point messages to the host processor, and the collector has established an authenticated connection to the head-end. This condition will be signaled for about 15 minutes before moving the "low-visibility" state.	Morse code for the letter sequence 'BN' (_ . . . _ .) The dit and dah timing described above with the space between the 'B' and the 'N' characters being 660 ms.
Token Received	If the radio reports decoding a "magic" token, which would enable the WiFi diagnostic interface, this pattern is presented for one 10 second interval. This condition is higher priority than Lo-visibility and the missing battery indications.	Morse code for the number '5' (.)
Low-visibility	After 15 minutes in the "Ready" state the LED pattern changes to the "Low-visibility" mode, which indicates the collector is running (does not imply that end-points are still being read or head-end communications are still possible.	10 ms illumination every 30 seconds.

Performing an Antenna Sweep Test

If the 900 MHz antenna is remotely mounted for your installation, an antenna sweep test must be performed to verify the antenna functions within acceptable tolerances at your installation site. Refer to the [Antenna Line Sweeps Procedure](#) on page 83 for testing details.

This test should be performed using the following conditions as a guide:

- **Beginning Frequency:** 902
- **Ending Frequency:** 928
- **VSWR Expected Results:** 1.5:1 or less for the specified frequency band.
- **Return Loss:** Must be -14dB or better for the specified frequency band.
- **Test Point:** Feed line connected to the antenna at the top; test from the lightning (or surge) arrester to the antenna port.
- **Results:** Test results must be saved in PDF format.

- **Test Gear:** Current and proper calibration; be sure that calibration is turned on during the test. A qualified operator of the test equipment must perform the test.
-  **Note** If the system does not perform to the previous test specifications, the reasons for system failure and possible remedies must be identified before leaving the installation site.

APPENDIX D

Changing the Repeater Password

To change the repeater password, you must log into the user interface as an administrator. The following procedures illustrate each step with Repeater 100 user interface screens.

To access the repeater user interface

1. Ensure the collector or repeater has power.
2. Activate the collector or repeater's Wi-Fi using the CAR (Collector Activation Radio). For more information about the CAR, see the *Collector Activation Radio Quick Reference Guide*.
3. Open the Wi-Fi connection utility on your PC.

Note It may take 1 to 2 minutes for the device to appear in the Wi-Fi connection utility.

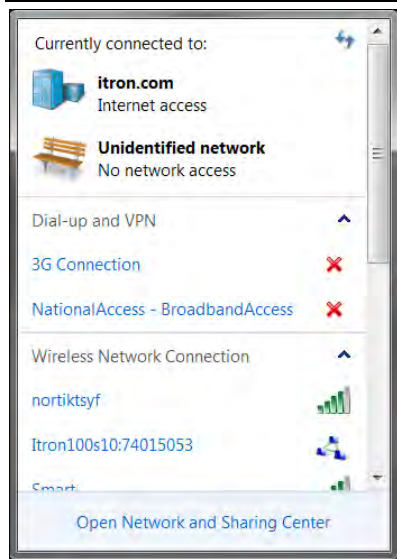

4. Highlight the collector or repeater you wish to access and click **Connect**.

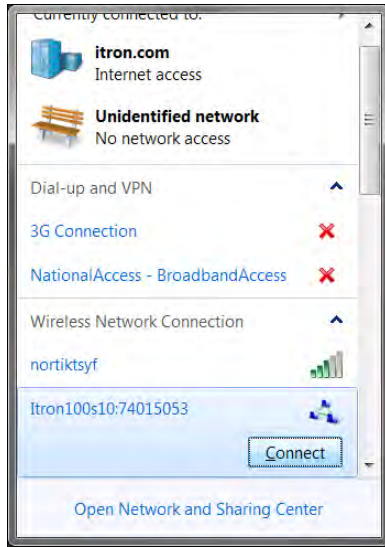

5. Type the **Security key**.



6. Open a browser window and type `https://192.168.1.9:4443`

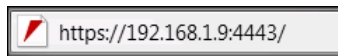

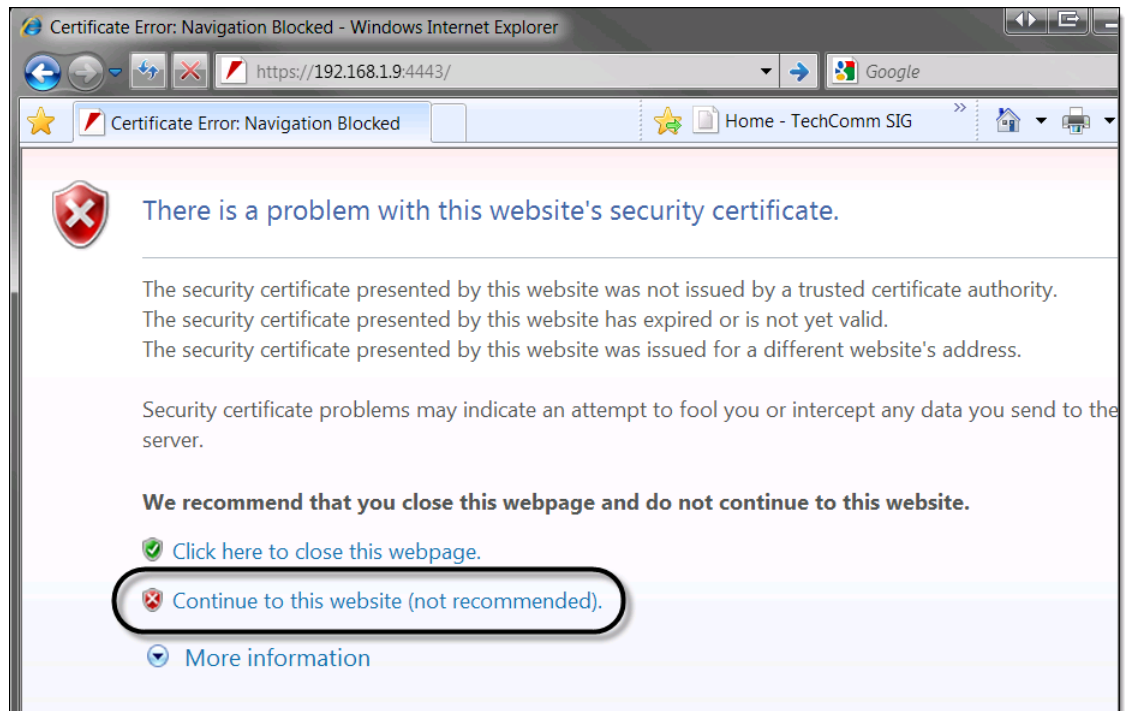
7. Click **Continue to this website (not recommended)**.8. Type the **Username** and **Password**.

Note The user name and password are case sensitive.

- **Username.** admin
- **Password.** Itr0n1

RPTR100: 10 LOGIN

Sat Jan 01 00:37:45 GMT 2000
RPTR: 74015053
System Uptime: 12 minutes 3 seconds

Login

Username:

Password:

Copyright © 2010 Itron, Inc.

The Main Menu window appears.

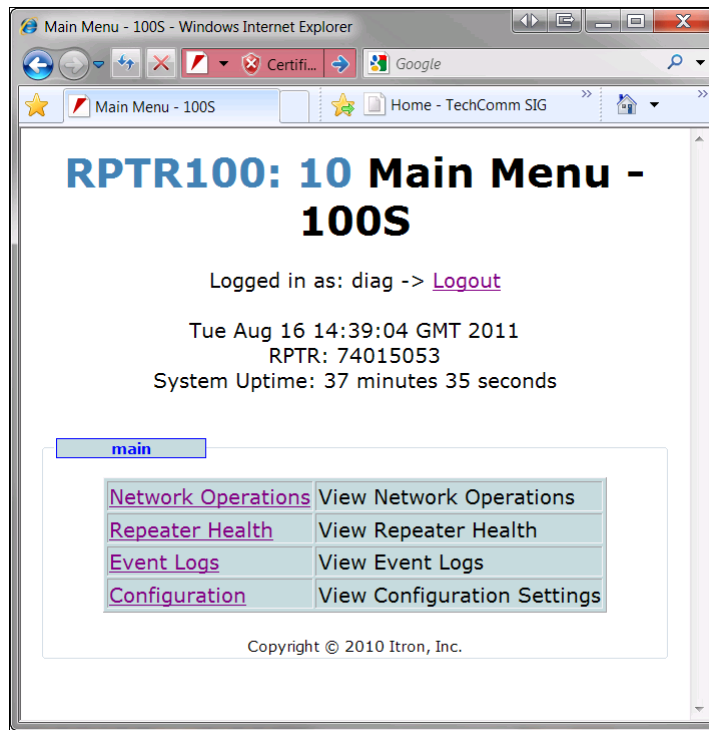

To change the repeater password

1. From the user interface Main Menu, click **Configuration**.

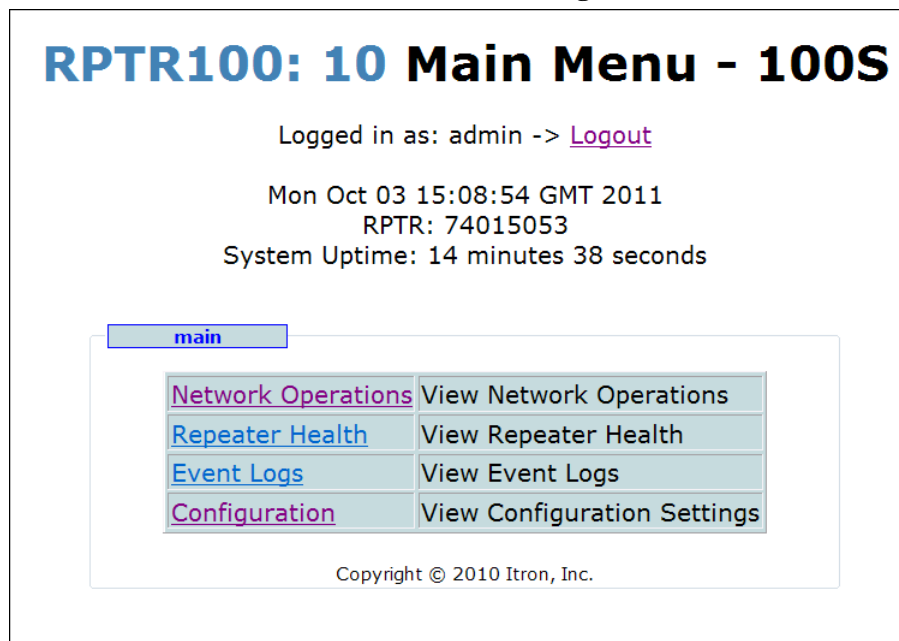

- From the Configuration menu, click **Wireless Diag**.

config	
ISM Power Setting	View ISM Power Setting
Utility ID	View Utility ID
Network Discovery Bits	View Network Discovery Bits
SCM Consumption Filtering	View SCM Consumption Filtering
SCM+ Consumption Filter	View SCM+ Consumption Filtering
IDM Sequence Counter Filter	View IDM Sequence Counter Filter
Endpoint Filtering	View Endpoint Filtering Settings
PON BUP Mode Configuration	View PON BUP Mode Configuration
Firmware Update	View Firmware Update Interface
Firmware Status	View Status of Firmware Update
Installed Packages	View installed packages
Force Reboot	View Force Reboot Interface
Replace ssh key	View Replace ssh key Interface
Wireless Diag	View Wireless Diag Settings
Discovery Settings	View Discovery Settings
Operation Mode	View Operation Mode Settings

- Enter the new information and click **Submit**.

Web Settings

64-bit WEP Key

WiFi is ENABLED

Change admin password:

Current password

New password

Change diag password:

Current password

New password

Copyright © 2010 Itron, Inc.

APPENDIX E

Antenna Line Sweeps Procedure

By combining Itron's proven 900MHz ERT® platform with fixed network technology and software applications, Itron provides a suite of data collection technologies for electric, gas, and water utilities. This fixed network solution, which is built upon our ChoiceConnect® system architecture, enhances customer engagement, increases operational efficiencies, and ensures system integrity.

The endpoints transmit to an Itron installed collection engine (data server) that is installed at the customer site, via one of three Itron manufactured network devices: a ChoiceConnect Tower Mounted Collector Unit (TCU 100), a ChoiceConnect Collector Unit (CCU 100) or a ChoiceConnect Repeater Unit (Repeater 100).

A remote 900 MHz antenna can be configured instead of the standard vertically polarized antenna that is directly attached to the CCU/Repeater. The remote configuration uses a standard vertically polarized antenna (MSE-0330-001 – Standard 5dBi antenna – Antenna Products 1009-0066-403) that is connected remotely or a high-gain vertically polarized remote antenna (MSE -0372-001 – Hi Gain 8.15 dBi antenna – Laird FG9026) that is mounted remotely.

Remote antennas must be properly grounded using a lightning arrestor. Refer to [Appendix Grounding Specifications](#) on page 93 for additional grounding information.

Anritsu Site Master Calibration

For the Antenna Line Sweeps procedure, Itron recommends using the Anritsu Site Master S331E, but similar models can be used.

To set up and calibrate the Anritsu Site Master S331E

1. Set resolution to the maximum value (typical sweeps should be set to sweep values of 902-928 MHz, with a propagation velocity of 0.8 and resolution of 517 points for the Anritsu Site Master).
2. Ensure all cables and jumpers are in their permanent locations and positions. Hangers, cable blocks, ground kits, and other hardware must be in place and connected using industry-standard torque wrenches to meet specifications for connectors.
3. Allow the test equipment to stabilize for approximately 15 minutes before taking any measurements.
4. Calibrate according to the manufactures instruction using a phase stable cable, precision 50 ohm load, open, and short circuit terminations.

Note Equipment must be calibrated per manufacturer suggested calibration period. Record the test equipment manufacturer, model number, and calibration expiration date on the [Itron ChoiceConnect Antenna and Line Sweep Test Form](#) on page 88.

The following illustration shows the Anritsu Site Master.

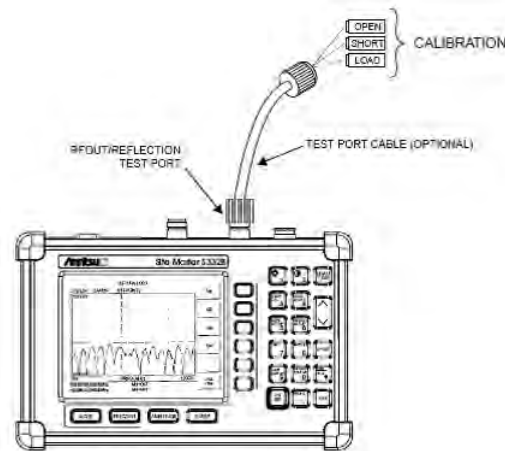

Testing on a Network Device with a Remotely-Mounted 900 MHz Antenna

When the 900 MHz antenna is remotely mounted, perform antenna and line sweeping tests to verify that the transmission system functions within acceptable tolerances. While monitoring sweep results, move all connectors on jumpers and coax to ensure all connectors are properly installed and reliable.

- ! **Note** There should be no variance in sweep tests while stressing connections.

General Testing Conditions

Perform sweep testing under the following *general* testing conditions:

- **Overall System Return Loss:** Must be -14 dB or better for the specified frequency band. Any deviations from this return loss warrant further investigation.
- **VSWR Expected Results:** 1.5 : 1 or less for the specified frequency band.
- **Test Point:** Feed line connected to the antenna at the top; test from the lightning (or surge) arrestor to the antenna port.
- **Results:** Test results must be saved in PDF format.
- **Test Equipment Requirements:** Current and proper calibration; be sure that calibration is turned on during the test. A qualified operator of the test equipment must perform the test.

Note If the system does not perform to the above test specifications, the reasons for system failure and possible remedies must be identified before leaving the site.

Specific Testing Conditions

Perform sweep testing under the following *specific* testing conditions:



Note Attach a copy of each trace to the antenna sweep checklist so that the Itron Field Engineer can inspect and sign off on acceptable results.

Antenna Return Loss Test: Complete a return loss test of the remote antenna on the ground prior to installation. Determine the quality of the impedance match to 50-ohms at the antenna connector. This test is performed with the test equipment calibrated for a one-port return loss measurement to the end of the test cable. Ensure that the antenna is positioned vertically, at least 24" above the ground, and at least 24" away from any metallic structure or equipment.

1. Configure the test equipment in return loss mode and calibrate.
2. Identify if the antenna passes or fails based on antenna manufactures specification. For more information about the antenna specifications, see [Itron ChoiceConnect 900MHz Antenna Specifications](#) on page 89.
3. Save the trace for printing. This shall include site and sector numbers for identification.

System Test Parameters:

Sweep Range: 902 - 928 MHz

Markers: M1 - 902 MHz, M2 – 928 MHz

Overall System Return Loss Test: Sweep test of entire transmission system including: antenna, coax, jumpers, and protection devices. Parameters of tests to be provided. While monitoring the sweep results, move connectors on jumpers and coax to ensure all connections are reliable. There should be no variance in sweep tests while stressing connections. The purpose of this test is to ensure total system return loss is within acceptable limits.

1. Configure the test equipment in return loss mode and calibrate.
2. Identify if the system return loss passes or fails. The antenna specifications are attached to this document as Attachment B.
3. Save the trace for printing. This shall include site and sector numbers for identification.

System Test Parameters:

Sweep Range: 902 - 928 MHz

Markers: M1 - 902 MHz, M2 – 928 MHz

Insertion Loss Tests: Perform with test equipment connected to bottom jumper, and calibrated short at the top jumper. The purpose of this test is to verify that insertion loss is within acceptable limits.

Insertion Loss Test Parameters:

Sweep Range: 902 - 928 MHz

Markers: M1 - Peak R/L, M2 – Valley R/L

Passing is determined by comparing measured insertion loss to the calculated insertion loss. Results should be no more than 1 dB over the calculated loss.

Load Test: Performed with test equipment connected to bottom of coax, and precision 50 Ohm load terminated at top of the jumper. The purpose of this test to verify the coax meets the manufacturer's specifications.

Load Test Parameters

Sweep Range: 902 - 928 MHz

Markers: M1 -Peak R/L

Passing is determined by the manufacturer's specifications for the type of coax being tested. Results should be as good as or better than the manufacturer's specification.

DTF Test: Performed with test equipment connected to bottom of coax, and top of the coax with a 50 ohm Load Test device attached. The purpose of this test is to confirm the line length of the coax as well as verify each connection point location / distance.

DTF Test Parameters

Sweep Range: 902 - 928 MHz

Markers : M1 – Peak

Understanding Party Responsibilities

This section outlines how Itron's role differs from the supplier's role in conducting the Antenna Line Sweeps procedure.

Itron's Responsibilities

Itron is responsible for the following aspects of the test:

- Physical verification of all network device installations, to confirm the supplier's quality of the installation work. The supplier should expect that representatives from both Itron and the customer will be on site at several installations of each type of network device (if not more), to ensure the installations meet the Itron and customer quality and design requirements.
- Physical attendance at all remote antenna coax sweeps testing and final punch-walk inspections. Itron will communicate any supplier workmanship concerns, to the supplier, as soon as physically possible.
- Validation of the functionality of each Itron TCU 100, CCU 100, and Repeater 100 device, once the supplier has completed an installation and the devices are turned on.

Supplier's Responsibilities

The supplier is responsible for the following aspects of the test:

- Performing the physical work required to install the Itron network devices, in accordance with the Itron provided documentation and training, including site grounding.
- Installing, where required, proper weatherproofing and grounding to ensure safe operation of equipment.

- Performing all antenna / coax sweep testing, documenting each network device installation with at least 10 digital pictures and reporting as-built GPS coordinates and antenna centerline heights, by the "tape drop" method.
- Providing all required tools, equipment and capable field crews that are required to properly install Itron network devices, including RF testing equipment.

Note Supplier is responsible for ensuring that all supplier managed field crews meet any local labor and / or pay requirements, such as union requirements, local business, mandatory minimum "Living Wages", as may be required.

- Include the expected equipment and costs associated with performing any coax, jumper, and antenna sweep testing, per the current version of the Itron Remote Antenna Sweep Test. For more information, see [Testing on a Network Device with a Remotely-Mounted 900 MHz Antenna](#) on page 84.
- Compiling a package of as-built and closeout documentation in a compact electronic format (Adobe .pdf files preferred) and e-mailing each site package to the Itron PM development within three business days following each completion.

Itron ChoiceConnect Antenna and Line Sweep Test Form

This attachment contains an example of the Itron ChoiceConnect® Antenna and Coax Sweep Test Form. Itron provides this form to the supplier, so that the supplier can determine their fixed fee, lump sum, and all inclusive pricing needed to complete the expected number of network device installations.

The following illustration shows the test form.

Itron ChoiceConnect™ Antenna and Line Sweeps Test Form														10/29/2012		
Itron Customer Name		SITE NUMBER			SITE NAME			DATE			Testing Technician			Testing Company		
		Jumper 1, TCU / Collector / Repeater to COAX				COAXIAL CABLE				Jumper 2, COAX to Remote Antenna						
Test	line #	Type	Length (ft)	Insertion Loss PER ft (dB)	Total Cable Loss (dB)	Type	Length (ft)	Insertion Loss PER ft (dB)	Total Cable Loss (dB)	Type	Length (ft)	Insertion Loss PER ft (dB)	Total Cable Loss (dB)			
Remote Antenna #1	I1															
Remote Antenna #2	I2															
Analyzer Mfg.		Analyzer Model Number			Analyzer Calibration Period				Calibration Expiration							
comments:																

Itron ChoiceConnect 900 MHz Antenna Specifications

The BOA 900MHz omnidirectional base station antennas consist of a linear array, encapsulated in a heavy duty fiberglass radome with a thick walled 6061-T6 aluminum mounting base for reliable long term use. This rugged design allows the antennas to withstand harsh environments and is ideal for Industrial, Wireless, and SCADA applications. The BOA series is DC grounded and is UPS shippable.



The following are features of the 900 MHz antennas:

- UV Stable Light Gray Fiberglass Radome
- Hard-Coat Anodized Mounting Base
- Galvanized Mounting Hardware
- Removable Drain Plug for Upright or Inverted Mounting

Technical Data

Maximum Power: 250 watts

Nominal Impedance: 50 ohms

Radome Material: Pultruded fiberglass (2" outside diameter)

ESD Protection: DC grounded

Rated Wind: 125 mph

Termination: N female bulkhead

Mounting Hardware: BAM1005 or MMK5 (Included)

The following illustration shows the antenna's electrical specifications:

RF/Electrical Specifications

Model	Frequency Range	Nominal Gain	Return Loss	SWR	E-Plane Beamwidth
BOA9025	902-928MHz	5.1 dBi/3 dBd	> 14 dB	< 1.5	25°
BOA9028	902-928MHz	8.1 dBi/6 dBd	> 14 dB	< 1.5	13°
BOA90211	902-928MHz	11.1 dBi/9 dBd	> 14 dB	< 1.5	6°

The following illustration shows the antenna's mechanical specifications:

Mechanical Specifications

Model	Weight	Height	Bending Moment at Rated Wind	Lateral Thrust at Rated Wind	Equivalent Flat Plate Area
BOA9025	5.0 lbs	55"	106 ft-lbs	29 lbs	0.77 ft ²
BOA9028	6.0 lbs	68"	178 ft-lbs	38 lbs	0.95 ft ²
BOA90211	10.0 lbs	122"	685 ft-lbs	74 lbs	1.7 ft ²

Typical Coaxial Cable Specification Summary Table

Coaxial Cable Return Loss/VSWR

Make	Cable	Model	Return Loss (dB)	VSWR (max.)
Andrew	7/8" Helix	LDF5-50A	-24.5	1.13:1
Andrew	1-1/4" Helix	LDF6-50A	-24.5	1.13:1
Andrew	1-5/8" Helix	LDF7-50A	-24.5	1.13:1
Andrew	2-1/4" Helix	LDF12-50	-24.5	1.13:1
Andrew	7/8" Virtual Air	AVA5-50	-24.5	1.13:1
Andrew	1-5/8" Virtual Air	AVA7-50	-24.5	1.13:1
All	Existing Coaxial Feeder	All	-22.0	1.17:1

Coaxial Cable Path Loss per 100ft

Make	Cable	Model	Velocity	Loss/100' @ 2 GHz
Andrew	1/2" Helix	LDF4-50A	0.88	3.25 dB
Andrew	1/2" SuperFlex	FSJ4-50B	0.81	5.37 dB
Andrew	7/8" Helix	LDF5-50A	0.89	1.86 dB
Andrew	1-1/4" Helix	LDF6-50A	0.89	1.35 dB
Andrew	1-5/8" Helix	LDF7-50A	0.88	1.13 dB
Andrew	2-1/4" Helix	LDF12-50	0.88	0.99 dB
Andrew	7/8" Virtual Air	AVA5-50	0.91	1.68 dB
Andrew	1-5/8" Virtual Air	AVA7-50	0.92	1.02 dB

Sample Sweeps Output

Return Loss:

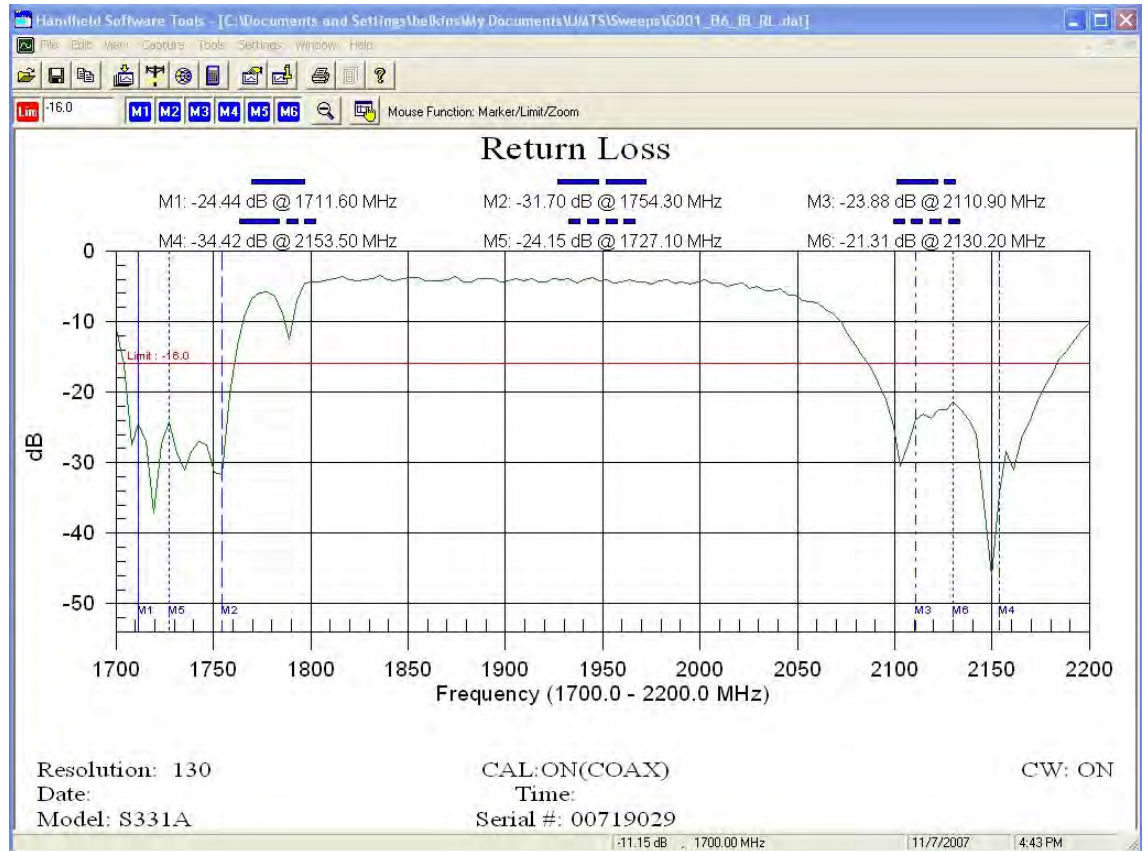

Cable Path Loss:

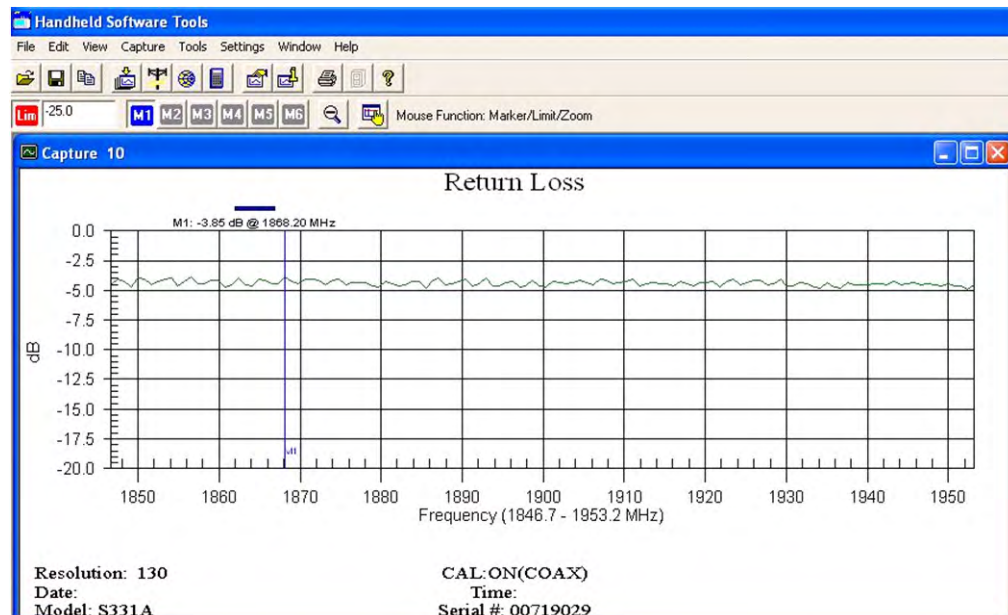

Cable Length:

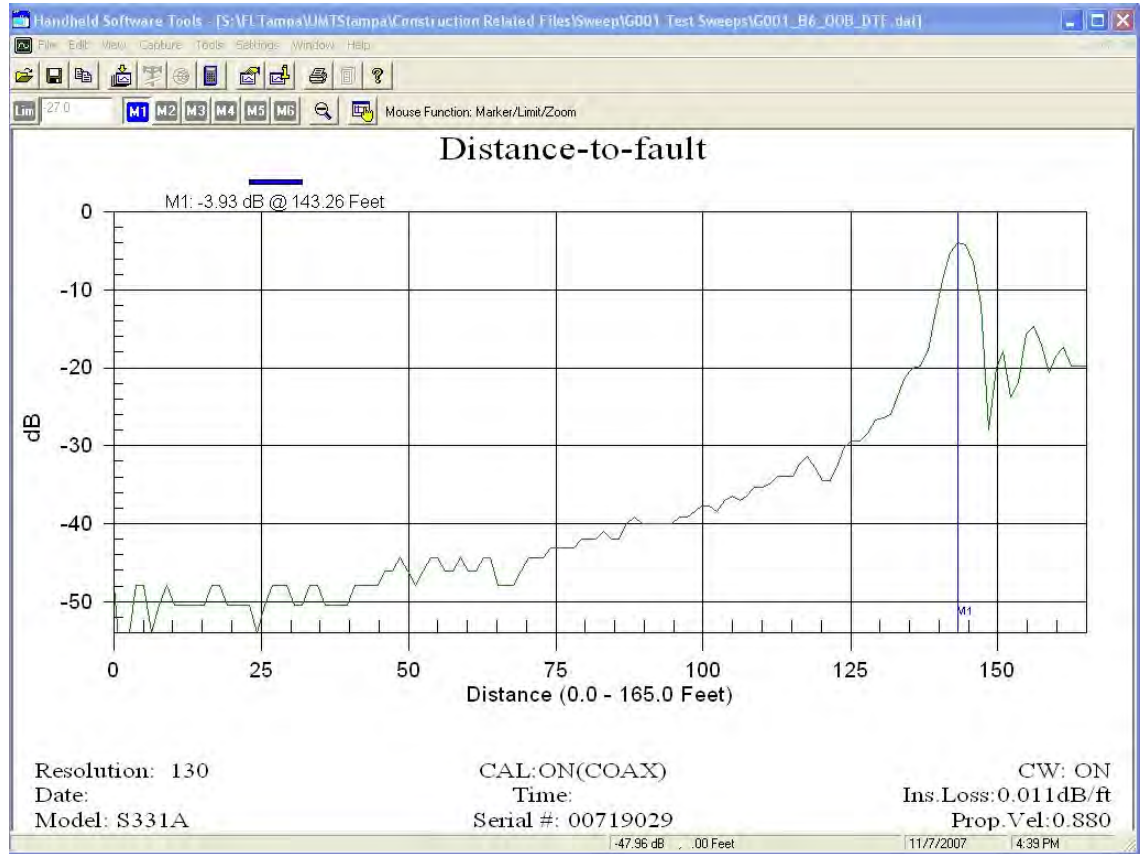

APPENDIX F

Grounding Specifications

This appendix provides specific procedures, details, and quality specifications for Itron's installation suppliers during the installation of Itron's ChoiceConnect® Automated Meter Infrastructure (AMI).

To achieve optimum performance of Itron's ChoiceConnect network devices, all critical components of the network must be thoroughly grounded and protected from electrical surges. The antennas, cables, and connectors are constantly exposed to the elements and because they are typically mounted at a high elevation, lightning strikes. Lack of proper system grounding and the resultant damage caused by electrical surges, can directly impact the network, resulting in endpoint read failures, repeater connection failures, or collector management failures.

The ChoiceConnect® Grounding Specification procedure is designed to ensure that remote and tower mounted antennas perform to the required specification prior to integration of collector or repeater into the Itron Fixed Network. For devices already on-air, this testing procedure can be used for troubleshooting problems.

This document is primarily designed for Itron RF engineers, senior project managers, field engineers as well as network device installers. It is assumed that users of this document are familiar with the operation of equipment such as the Megger DET14C/24C Clamp-on Ground Resistance Tester.

The following illustration shows a Megger DET14C/24C Clamp-on Ground Resistance Tester.



The service life of any piece of electronically controlled equipment is often determined by the quality of the electrical service that it receives power from. The number one cause of downtime (other than user error, neglect, or abuse) is poor power quality.

A low impedance ground is imperative to both surge protection designs and power quality. Regularly inspecting and upgrading the system can positively affect the system in the following ways:

- reduce interference and line noise
- reduce the risk of accidental electrocution
- decrease potentially damaging harmonics
- improve power factors
- improve the efficiency and durability of the surge protection equipment

Understanding Grounding and Bonding

You must have a complete grounding and bonding system between the electrical service entrance and remotely grounded buildings or equipment. If the remote ground home runs back to the service entrance, create a *single point ground* that references the initial utility company electrical ground back at the service entrance electrical meter.

In this document, the definition of grounding and bonding is as follows:

- **Ground/Grounding.** Any direct conducting connection between an electrical circuit or equipment and earth.
- **Bond/Bonding.** The permanent connection of metallic parts to form an electrically conductive path. For example, an electrical service panel that is grounded while the telecommunications rack is bonded to the grounding system.

Understanding the Ohms Level

According to articles 100 and 250 of the NATIONAL ELECTRIC CODE (NEC) an acceptable ground is rated at 25 Ohms of resistance or less, but optimum performance of surge protectors is achieved at 5 Ohms or less. Several manufacturers of electronic equipment also require 5 to 10 Ohms as a maximum resistance for their gear to work correctly.

Reducing the Ohms level

In many areas of the country you may be starting with 350 Ohms or more. Itron's networks are built all over the United States and the geological features can vary greatly in different parts of the country; therefore, allow the installing contractor to determine how best to lower resistance to ground (to 5 Ohms or less) in a specific region. The recommended grounding conductor at the service entrance is specified by NEC based on the ampacity of the service.

You can perform the following tasks to reduce the Ohms level:

- **Measure the resistance to ground** at the service entrance meter's electrical ground, or of the soil itself. Soil resistance can be affected by the following:
 - moisture content
 - quality and type of electrolytes
 - conductive objects

- temperature
- depth and spacing of the ground rods.

For more information about using a Megger to measure the resistance to ground, see [Using a Megger](#) on page 95.

- **Drive a new service entrance ground rod.** You cannot know the exact length or current condition of the original ground rod, so it is best to install a new rod of suitable length and composition at the service entrance. Solid copper is the preferred material; however, galvanized or copper clad may also be suitable if acceptable resistance levels are met.
- **Bond a new rod and the existing rod together.** If the target ground resistance is not achieved by a new rod, drive a second rod and bond the two rods together by exothermic welding a piece of the grounding conductor between the two. The new rod should be approximately one rod length or more from the first rod. Multiple rods can be connected this way.

Note One additional rod lowers ground resistance by 40%. Two rods result in a 60% reduction. Three rods improve resistance by 66%.

- **Drive the rod deeper.** Couple a new rod of equal length on top of the existing rod to effectively double the depth of the rod. Be sure to use rods of like type and a coupler matched to that type of rod. This will result in an approximate 40% reduction in ground resistance.
- **Create a Trench Ground or Ground Ring.** If your region provides a solid substrate such as bedrock immediately below a shallow layer of soil, it is possible to create a circular trench around the building (minimum 20 feet long) at least 30 inches deep utilizing a minimum of #2AWG bare copper conductor, lay in the grounding conductor, bond the two ends together to the ground rod, and then backfill the trench with soil. This allows maximum contact with the ground, without being excessively deep to do the job.
- **Create a Ground Grid.** This procedure involves creating a grid of grounding electrodes, or rods, in close proximity (10 to 20 feet, or at least one rod length apart,) and welding or bonding the grounding conductor between the rods together. The entire grid is then backfilled with soil and compacted to complete the grid. Also, review NEC section 250-32(b) for more information.

Using a Megger

Measure the resistance to ground one of two ways: A special "clamp-on" ground resistance measuring device is recommended for existing locations, and an earth resistance meter (Megger) is preferred in installations of new equipment that cannot be connected to an existing ground ring.

The earth resistance meter is less expensive, but it requires multiple ground probes and leads from the tester with specific distance requirements between rods. Then measurements are plotted on a monograph in order to calculate the actual resistance of the ground.

Meggers come in three and four terminal configurations. To test the actual resistivity of the soil itself, use a four terminal model. The advantage of this method is that you are not connected to the electrical system during testing. An electrical line fault during testing can send high current to the grounding system, resulting in high current and voltage at the test leads and meter.



Warning Be safe when working on live electrical systems. Always use proper protection equipment. If you are in contact with the grounding system (particularly if the ground rod is disconnected) you are the ground for the system.

Adjusting the Routing of the Grounding Conductor

If more than one ground can be referenced (such as in a campus environment), adjust the routing of the grounding conductor. This is very important in the system's ability to reference the original equipment ground back at the service entrance utility service meter.

The normal routing procedure is to bring the HOT, the NEUTRAL, and the GROUND wire into the remote electrical panel and terminate them to the appropriate busses. Then route the GROUND wire down to the house grounding electrode (ground rod).

In this procedure, route the GROUND wire to the grounding electrode *first*, and then route up to the ground bus within the panel. This simple adjustment still follows NEC code, but provides an unobstructed pathway to divert surges to these ground rods while continuing to reference the service entrance ground. The fundamental result of this routing procedure is the elimination of potential equipment damage from the ground loop created by multiple ground rods. This method of routing allows the electrical potential of the entire facility to rise and fall in a uniform manner, reducing the possibility of excessive current flow on the grounding system.

Finally, inspect and tighten all wiring terminations at the service entrance and at each of the remote panels, disconnects, or equipment.



Note To lower resistance to grounding, keep all connections tight and free of oxidation.

The following illustration shows a sample grounding layout.

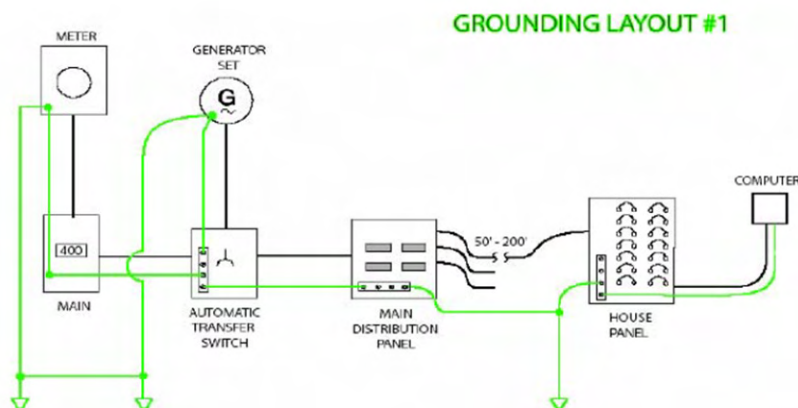

Supplier General Requirements and Equipment Competencies

Itron requires that all suppliers have previous telecom experience and have the following equipment and resources:

- Certified, Clamp-On Ground Resistance testing devices (or equivalent)
- Competent trained operators readily available
- Megger DET14C/24C Clamp-on Ground Resistance Tester, or equivalent
- Maintain the capability to document ground resistance testing data by digital photograph and be able to convert the photos to Adobe Acrobat files, to be transmitted within 24 hours of completing testing.

Exterior Grounding System Design for Concentrators

Materials making up the grounding and bonding system must meet the following minimum standards:

- **Wire underground.** Minimum No. 2 American Wire Gauge (AWG) bare, solid, annealed, tinned copper wire (BTCW) but sized in accordance with NEC Table 250.66. Under no circumstances is stranded wire acceptable. Install all buried wire to meet minimum bend radius. Sharp bends and kinks are never acceptable.

Note When any grounding or bonding wire runs through concrete, sleeve it in PVC.

- **Wire inside.** Any low halogen cable meeting the ratings of Telcordia GR-347 is acceptable.
- **Clips.** When securing any ground wires, solid or stranded, insulated or un-insulated, never use any clips or other devices that are conductive and form a closed loop. Closed conductive loops form a grounding choke point during high voltage spikes that have an adverse impact on grounding performance. Metallic clips are acceptable if they do not form a closed loop. A metal clip that is "U" shaped but is mounted on a conductive metal surface is considered a closed loop.
- **Ground Rod.** 5/8-inch x 8-feet (minimum length) steel with pure copper jacket not less than 0.0012 inches thick.
- **Ground Rod Coupling.** 5/8-inch ground rod coupling made of the same material as the ground rod to prevent dissimilar metal high oxidation points.
- **Chemical Ground Rod.** Comprised of a hollow copper ground rod, a ground test well, a 4'-0" exothermically welded pigtail, and conductive backfill material. The chemical ground electrode must be made of a minimum two inch I.D. Type K copper tube with a minimum wall thickness of 0.083 inch and must be a minimum of 10 feet in length. Fill the chemical ground rod copper tube with non-hazardous metallic salts. The chemical ground rod must be UL listed. In situations where drilling vertically is too difficult or costly, horizontal L-shape chemical ground rods are acceptable.

- **Ground bars.** Bars must be 1/4 inch thick solid electrical grade copper and must be electroplated with tin 0.0003 inches thick typical, 0.0002 inches thick minimum. Hole spacing between top row and center row holes must be 3/4 inch, between center row and bottom row holes must be 1 inch (Telco), and between top row and bottom row must be 1 3/4 inch (NEMA). Connect ground lugs as shown in Figure 2-1. Ground lugs on opposite sides of the ground bar may share holes in the ground bar if connected properly.

Warning Never mount lugs on top of each other on a ground bar.

- **Exothermic Welding.** Exothermic welds must be Cadweld, a registered trademark of Erico Products, Inc. of Cleveland, Ohio, or ThermOweld, a division of Continental Industries, Inc. of Tulsa Oklahoma or equivalent.

The following illustration shows the installation of ground wire to ground bar.

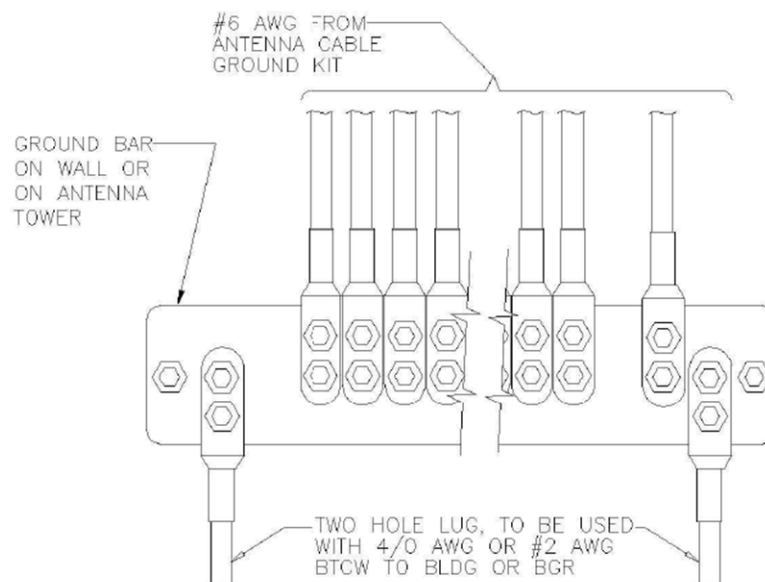

- **Ground Clamp.** Used for conduit or water pipe, for instance. Burndy GAR style UL clamp with two-hole provisions for long barrel multiple crimp two-hole lugs or equivalent.

Conduit. Conduit requirements vary due to state and local construction codes. The local engineering firm determines what is required depending on the site type and jurisdiction. Consider material and labor costs when selecting a conduit type as long as all applicable codes are followed.

- **Metal conduit.** (At a minimum) UL listed galvanized rigid steel conduit (minimum size: 1-1/2-inch trade size) with UL listed fittings. Steel compression fittings, watertight fittings, and bonding to grounding conductors at both ends are required. Do not use set screw settings.
- **PVC conduit and fittings.** Schedule 40 (minimum). Do not use EMT conduit for underground applications.

When conduit is visible and there is no method to determine the contents (for example, utility shafts in a building), label the conduit as power (with voltage), Telco service, or ground.

- **Coax Grounding Kit.** The coax ground kits must be from the same manufacturer as the coax. Ground kits must be solid strap type with No. 6 AWG wire and 2-hole compression crimped lugs (installed using the proper UL tool and circumferential hexagon die). Ground kits ordered through Itron North Supply do not require approval. Coax ground kits not ordered through Itron North Supply require approval from the Itron construction team.

Note Do not use a braid or hose clamp type nor a solid copper strap type with single hole lugs.

- **Lugs.** All lugs must be 2-hole, long barrel, tinned solid copper unless otherwise specified in this document, installed using the proper UL tool and circumferential hexagon die. Lugs must be Thomas and Betts series 548##BE, Burndy, ERICO or equivalent. Bolt hole diameter and spacing on all ground lugs must match the hole diameter and spacing of the ground bar. Angled lugs may be used if construction conditions dictate.

Note Tag all ground lugs that are attached to any easily accessible ground point (for example, exposed ground bars, water pipes, or building steel.). The tags must read, "DO NOT DISCONNECT" and must be placed at each end where the grounding conductor terminates. Metal tags are acceptable.

- **Anti-Oxidation Compound.** Anti-oxidation compound must be Thomas and Betts KOPR-SHIELD (TM of Jet Lube, Inc.) or Burndy Penetrox – E. This product is available in small containers with a brush attached to the lid for easy application. Apply anti-oxidation compound between the lug and ground bar only. Do not cover the lug.
- **Lightning Arrester for UHF Coax.** Polyphaser IS-MR50 series.

Existing Building or Rooftop Sites

The following topic outlines how to ground a CCU on an existing building or rooftop site. Electrically continuous paths to earth ground are available when grounding on or near existing buildings.

To ground existing building or rooftop sites

1. Inspect all proposed existing building/rooftop sites to determine which of the following electrically continuous paths to earth ground are available:
 - Attachment to the building water main entrance.
 - Attachment to the building structural steel that is physically continuous down to earth ground, as verified by a local Engineering firm.
 - Connection to an existing qualified grounding system.

2. Request a copy of any soil resistivity and/or site resistance to earth testing previously performed on the proposed site.

Note: A clamp-on ground resistance test may be performed at existing building sites where it isn't feasible to perform a site resistance to earth test. Refer to [Clamp-On Ground Resistance Testing](#) on page 117 for the proper testing procedure.

Co-Located Sites & Other Existing Structures

Review all co-located sites to determine if an existing qualified ground system is present based on a copy of any soil resistivity and/or site resistance to earth testing previously performed on the proposed site.

If no prior soil resistivity records are available and there is land space available, a soil resistivity test is suggested.

New Wood Pole Sites

Test all proposed site locations before completing external ground ring design. It is the contractor's responsibility to advise Itron of the resistivity of the site by submitting the required forms before any construction of the BGR can be started by the contractor.

Equipment Buried Ground Ring

The following is a list of required specifications for all Itron sites not installed on a lite pole structure. This includes TCU, CCU, and Repeater sites:

- All sites must have a BGR around the equipment pad or platform. The BGR is to consist of a ring of No. 2 AWG BTCW and exothermically welded ground rods.
The BGR design is site specific. The design should result in 5 ohms or less with soil resistivities of up to 50,000 ohm-cm. Soil resistivities higher than this require further augmentation that is beyond the scope of this practice and should be designed specifically for the site by a qualified engineer.
- All underground (below grade) grounding connections, including copper ground rods, chemical ground rod attachments, and ground leads from equipment, tower, and coax must be made by an exothermic weld.
- The ground ring between 18" and two feet from the BTS pad or platform perimeter at a minimum depth of two feet, six inches (or deeper depending on frost line), and with no bend having a radius of less than two feet.
- A 6-inch trench dug below the required wire depth.
- Ground rods installed, at a minimum, at each corner of the BGR.
- Minimum ground rod length must be either (1) 10'-0" or (2) site frost depth plus 10'-0" minus the depth of the ground ring, whichever is greater.

Example 1. Site frost depth = 4'-0" and the ground ring is installed at 2'-6" below final grade. Minimum ground rod length would be 11'-6" (4+10-2.5).

Example 2. Site frost depth = 1'-6" and local codes require the ground ring to be installed minimum 2'-6" below grade. Minimum ground rod length = 10'-0" since it is greater than 9'-0" (1.5+10-2.5).

Chemical Ground Rod Installation

If required, install chemical ground rods and bond the chemical ground rod to the BGR with No. 2 AWG BTCW. Refer to the illustration under [To install a chemical ground rod](#) on page 101.

To install a chemical ground rod

1. Auger a vertical hole in the earth with a minimum diameter of six inches. For 'L' shaped chemical ground rods, dig a trench 12 inches wide.
The depth of the hole must be six inches greater than the vertical length of the rod.
2. Remove the sealing tapes from the bottom of the unit only. Tapes must be saved and made available for inspection by the contracted engineer to verify removal and proper installation. For 'L' shaped models, remove only the tape on the horizontal section.
3. Position the chemical ground rod unit in the hole.
4. Mix the backfill material if required. Pour backfill around rod in augured hole. Fill up to red "Bury to Here" marker. Do not overfill.
5. Place inspection hand hole box with cover over the top of the rod so that the cover is at grade level. Use backfill or grout to stabilize box around the rod. Keep the breather holes free of obstruction and debris. The top of the box should not contact the top of the rod.

Note Protective cover box must be either concrete or PVC construction and must be 12 inches by 24 inches by 22 inches deep, or equivalent.

6. Remove the top sealing tape **ONLY** after backfill is complete. This prevents soil from blocking the breather holes. Tapes must be saved and made available to the Inspector to verify removal and proper installation.

When an Itron TCU / CCU / Repeater is co-located with another wireless service provider's site, bond Itron's grounding system to the tower BGR, to another provider's ground system, or to the common ground ring to ensure that all ground systems are at the same potential.

Perform bonding at the earth ground ring level using a minimum of No. 2 AWG BTCW. When bonding to another service provider's ground ring, connect the Itron ring at two locations to the existing grounding systems.

The size of the wire depends on the distance between the two systems. In most cases, if the two systems are located in the same compound, No. 2 AWG BTCW will suffice.

The following illustration shows exterior ground details.

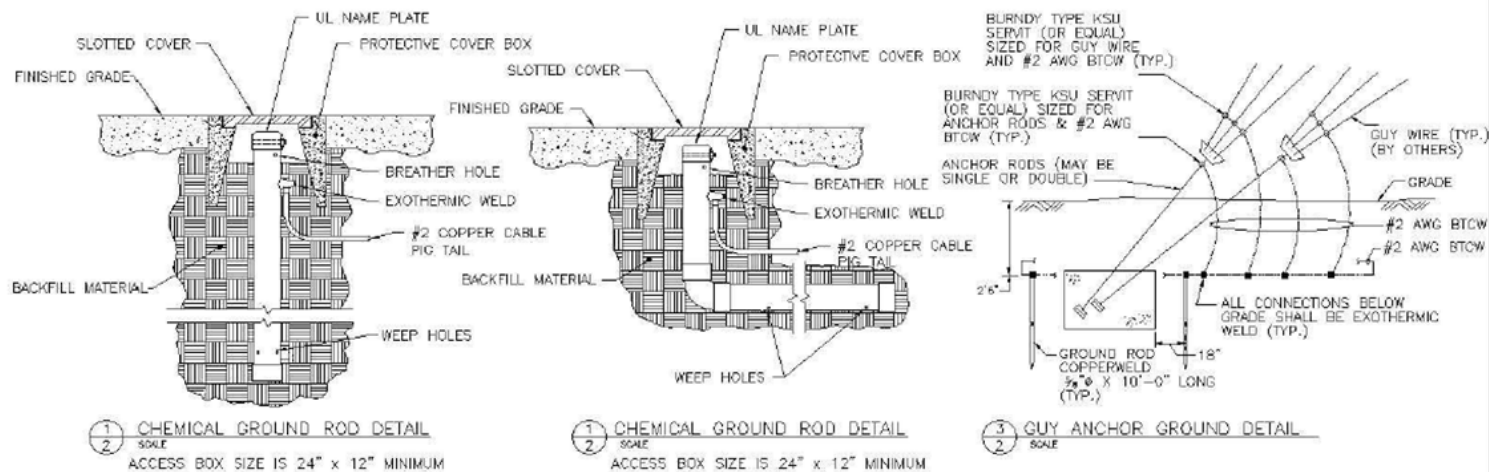

Itron Concentrator Equipment

Connect Itron concentrator equipment ground leads to the equipment cabinets as dictated by the cabinet manufacturer. Unless specified otherwise by manufacturer, ground leads are No. 2 AWG BTCW.

In most cases, connect the other end of the ground leads to the equipment ground bar (EGB) or MGB if each equipment cabinet has separate, external attachment points for ground lugs. If the Itron concentrator equipment cabinets collectively have only one or two ground attachments, the BTCW ground leads may be exothermically welded directly to the BGR.

TCU / CCU on a Concrete Pad

Use a concrete pad to hold the EGB flat. Several inches above the surface of the pad, securely bolt the TCU or CCU with stand-off (cherry) insulators to prevent movement. In this configuration, the ground bar is typically used only for Itron TCU / CCU equipment grounding.

TCU / CCU on a Steel Frame or I-Beam or Platform

If the Itron TCU / CCU equipment is mounted on a steel frame or I-beam, bond the steel to the BGR at opposite ends with two No. 2 AWG BTCW and exothermically welded at each end. Secure the BTCW ground leads to minimize the possibility of creating a trip hazard.

Ensure that all ground paths to the BGR are installed so that any potential discharge of electricity is downward or flat. The MGB needs to be properly located to ensure that this is possible.



Warning Do not allow ground paths to go upward. Make all connections to ground bars in accordance with this document.

TCU / CCU on a Raised Metal Platforms

The following procedure outlines how to ground a CCU that is installed on a raised metal platform.

To ground TCU and CCU on a raised metal platform

1. Bond raised metal platforms used to support the Itron TCU / CCU equipment at raw land or collocation sites to the BGR at two locations with No. 2 AWG BTCW exothermically welded to opposite sides of the platform.
For rooftop sites, the platform ground leads are connected to the MGB.
2. If the raised metal platform contains removal grating, install metal clips on removable sections to insure the metal platform is electrically continuous.
3. Securely mount the MGB below the platform using stand-off (cherry) insulators to electrically isolate the bar from the steel platform.

In this configuration, the MGB is typically used for Itron TCU / CCU equipment, coax cable, and platform grounding.

4. Mount the MGB so that all equipment, coax, and platform ground lugs attach to the top two rows of holes and the leads connecting to the BGR attach to the bottom two rows of holes.

Warning It is *critical* that only one neutral to ground bond be made at the service entrance equipment as defined by the National Electric Code.

TCU / CCU / Repeater Remote Antennas & Coax on Towers

Ground all antennas to their mounts or masts by the ground kits on the coaxial cable connected to the CGBs (Coax Ground Bars). This includes the GPS and WAN antennas, if applicable. Ground all CGBs properly to provide adequate protection in the event of a lightning strike on Itron's antennas or antenna masts.



Warning Do not install separate antenna ground connections unless specified by the antenna's manufacturer.

To ground remote antennas and coax on towers

1. Mount the CGB, without stand-off (cherry) insulators, to the grounded steel antenna support structure (for example, on a monopole, lattice tower, or water tank) using UL approved mounting devices.
 - You can use ground clamps to mount the CGB to available flanges or coax port rims, for instance.
 - You can use steel straps to attach the CGB to a monopole if no convenient clamping surfaces are present.
2. Make sure that all connecting surfaces are clean -- free of dirt, oil, and corrosion and polish galvanized surfaces with a steel brush.

Note Do not drill holes or use exothermic welds to connect ground leads to a steel tower except on steel tabs or flanges specifically designed for that purpose. Holes and/or exothermic welding can negatively impact the structural integrity of the tower and increase chances of corrosion.

3. If the steel antenna support structure is not properly grounded, or if the structure is made of a non-conductive material such as wood or concrete, then you can use a 4/0 AWG stranded green insulated "home run" to connect the upper CGBs to Itron's ground system.
4. Route the home run either inside or outside a monopole. Specific CGB connection procedures are described in the procedures under [Installing Coax Ground Kits](#) on page 104.

Installing Coax Ground Kits

This section outlines the procedures to follow when using ground kits for the following types of installations:

- [At the top of a tower](#) on page 105
- [At the bottom of a tower](#) on page 105
- [At the end of an ice bridge](#) on page 106
- [With GPS and WAN antennas](#) on page 106
- [Grounding a coax ground kits](#) on page 106.

To install coax ground kits at the top of a tower

Install one CGB at the top of the tower as close as possible to the tower top coax ground kits. Install the CGB without stand-off (cherry) insulators to ensure a good ground bond on grounded metal towers.

If antenna placement and coax ground kit lead lengths require the use of multiple sector ground bars (for example, the ground leads do not all reach the single CGB), mount the sector ground bars in the same manner. Install coax ground kits on the coax as close to the antenna jumpers as possible and connected to the CGB or sector ground bars using two-hole lugs as specified in [Exterior Grounding System Design for Collector Sites and Repeaters](#) on page 97.

1. If a home run is required, connect the tower top CGB to the middle or lower ground bars with a single run of 4/0 AWG stranded insulated wire.
2. Mount any other sector ground bars with stand-off (cherry) insulators and separately connect to the CGB with No. 2 AWG stranded insulated wire.
3. If the antennas are flush-mounted or otherwise located such that there is no space to install coax ground kits prior to the coax entering the antenna support structure (for example, with a flagpole tower), you can eliminate the upper coax ground kits and associated CGB. However, coax ground kits must still be installed at the base of the antenna support structure.

To install coax ground kits at the bottom of the tower

1. Install one CGB at the base of the tower with stand-off (cherry) insulators, directly below the point at which the coax cable transitions from vertical to horizontal.
2. Install coax ground kits on the vertical portion on the coax and connected to the CGB using two-hole lugs as specified under [Exterior Grounding System Design for Collector Sites and Repeaters](#) on page 97.

Attention Allow as straight a path to ground as possible. Connect the CGB to the tower BGR with two vertical runs No. 2 AWG BTCW.

In general, the antenna and coax grounding and bonding on a water tower is identical to a monopole configuration with the leg of the tower supporting the antenna cables being the "monopole". Except, do not drill or exothermic weld on any part of the water tower. Use a "home run" as needed.

To install a coax ground kit to end of ice bridge

Install coax ground kits prior to the jumpers at or near the end of the coax ice bridge.

- At a pad site, connect the ground leads to a CGB that will be connected to the equipment BGR with two No. 2 AWG BTCW.
- At a platform, connect the coax ground kits directly to the MGB if the site configuration permits.

To attach a coax ground kit at GPS and WAN antenna

If the GPS and WAN antennas are mounted on the monopole or antenna support structure, attach a coax ground kit to the coax as close as possible to the antenna and connected to a small CGB.

1. Ground the stand-off pipe mount with one No. 2 AWG BTCW exothermically welded to the mast and connected to the CGB with a two-hole lug.
2. Connect the CGB to the tower BGR with one run of No. 2 AWG BTCW properly strapped or otherwise secured to the tower to prevent movement in high winds.
3. Ground the GPS and WAN coax at the bottom of the tower (described in [this procedure](#)) and end of the ice bridge (described in [this procedure](#)).
4. If the GPS and WAN antennas are mast mounted near the equipment or ice bridge, the coax ground kits must be installed and connected to the CGB at the end of the ice bridge, the EGB, or the MGB, whichever is more practical and provides the shortest and easiest path to ground.
5. Ground the GPS and WAN masts by one No. 2 AWG BTCW directly to the BGR, ground bar, or to another piece of properly grounded steel.

To ground a coax ice bridge

1. At each end of the cable bridge, bond the steel supporting structure for the waveguide bridge to the BGR with a No. 2 AWG BTCW conductor.
2. Bond the waveguide bridge/cable tray to the grounded support structure or BGR using No. 2 AWG BTCW and exothermic welds at each end.
3. Bond each section of the waveguide bridge/cable tray together with plates of similar metal or with No. 2 AWG BTCW or #2 AWG stranded insulated wire, bonding each section together at each joint.
4. If buried coax runs from the antenna support structure are used rather than a coax bridge, still install coax ground kits at the base of the antenna support structure and just prior to the equipment jumpers.
5. Place the two runs of No. 2 AWG BTCW used to bond the tower and equipment ground rings in the same trench as the coax.

Warning Be careful when installing the coax ground kits prior to equipment entry to ensure that all ground leads use smooth, large bend radii as it will be very difficult to ensure that the leads always travel downward.

Collector Sites with Indoor Itron TCU / CCU Equipment

When grounding equipment for collector sites where the Itron TCU / CCU equipment is located indoors include the installation on an interior ground ring (halo) installed approximately 6 inches below the ceiling or 8 feet above the finished floor, whichever is lower. The interior ground halo cable must be a minimum of No. 2 AWG, stranded copper with moisture resistant green insulation. The purpose of the interior halo ground ring is to provide a convenient grounding and bonding point for all miscellaneous metallic objects to reduce step and touch potential. All miscellaneous metallic objects, such as metal door frames, air conditioners, cable racks, metallic conduits, and battery stands must be bonded to the interior ground halo with No. 6 AWG cable. Bond both ends of the ground halo conductor to the MGB.



Note Follow this bonding specification in existing shelters, if an interior halo is present. Most indoor Itron TCU / CCU equipment has grounding attachment points at the bottom of the cabinets. In these cases, it is not possible to have all ground paths flat or downward. Install all ground leads in accordance with manufacturer's specification.

RF Components Protection (Coax)

RF transmission lines from the antenna structure to the shelter or building must be grounded (earthed). Upon entering the shelter or building, all RF transmission lines must route through coaxial RF- type Surge Protection Devices (SPDs). This includes sample port (test) and unused spares.

To ground RF transmission lines

1. Bond the coaxial RF devices to the single point ground.
2. Locate the SPD within the shelter, room or equipment area.
It must be a maximum distance of 2 feet from the transmission line entrance point into the shelter, room or equipment area, as per the figure, below.
3. Install coaxial cable SPDs at or within the entry port if the entry port is located in the wall of the shelter, equipment room or area.
4. If the equipment room or area is located within a larger building (such as a high rise structure), install and ground the SPDs at the coaxial entry point into the structure. In this application, the transmission lines must also have SPD installed and grounded at the point where they enter the equipment room or area.

Note SPDs are required to be installed at the building entry point to reduce the radiated RF energy generated by a lightning strike. Terminate unused coaxial cables connected to the outside by grounding the shield to the ground entry port and installing a SPD with a shorting stub or 50 ohm load. Do not allow excess cable to come in contact with equipment or personnel.

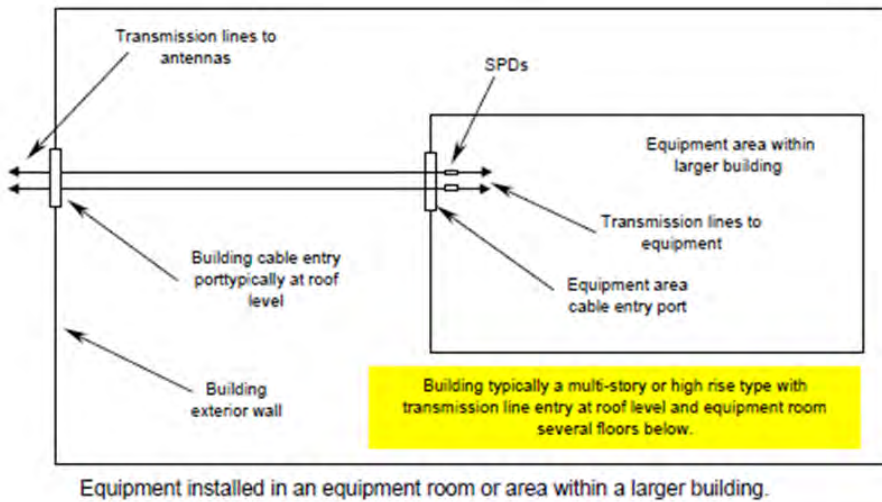
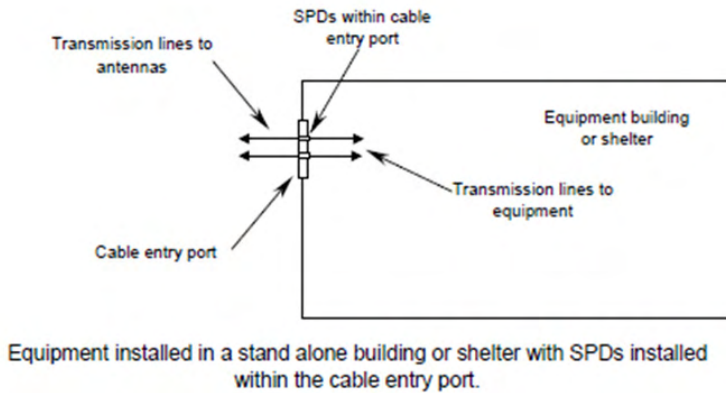
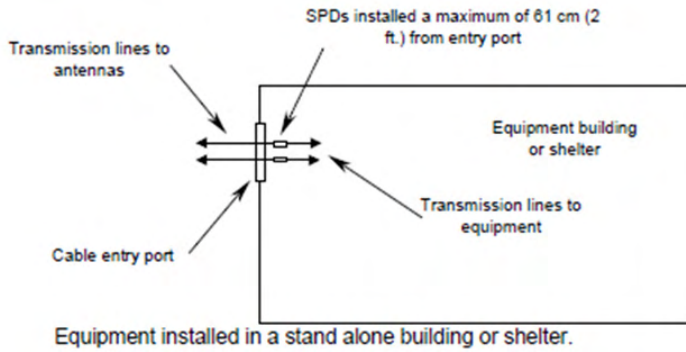

To work with interior connections

1. Connect all grounding and bonding conductors that are connected above grade or interior to a building using two-hole multiple crimp type (with UL tool and circumferential die compression) connections or by exothermic weld connections where allowed.
2. Size AC service electrical ground per the NEC with No. 2 AWG BTCW minimum.
3. Run service ground wire continuously and in an unbroken manner.
4. Coat all touching surfaces before connecting.
5. Install anti-oxidant compound per manufacturer's instructions.
6. Make all grounding connections, interior and exterior, with two-hole lugs using an anti-oxidation compound prior to crimping.

Grounding Rooftop Network Devices

A rooftop network device refers to a site where Itron's site is built on an existing building, regardless of whether Itron's TCU / CCU equipment is located on the rooftop or inside the building. Human occupancy of buildings requires that safety is a primary consideration. Network device grounding must be designed to ensure that any potential electric discharge is safely carried to earth and not dissipated through the structure.

To ground rooftop network devices

1. Install the MGB at a rooftop site at the Itron TCU / CCU equipment location. This acts as the primary point where all Itron grounding connects to the main grounding system.
2. Install the MGB flat, if necessary, to ensure that no paths to ground turn upward to allow connection to the top of the MGB.
3. Properly ground the MGB at a roof top site by two separate electrically continuous paths to ground where practical as determined by the responsible Itron Project Engineer. The paths can be in order of preference:

To ground building steel and existing building lightning protection or grounding systems

1. The first path to ground includes bonding the MGB to building steel with a 4/0 AWG conductor. Consider only building steel that has been verified by the AE to be continuous to earth and appropriate for grounding.
2. Install the second path to ground by bonding the MGB to the existing building lightning or grounding system with 4/0 AWG conductor.

To ground building steel and one 4/0 AWG down conductors

1. The first path includes bonding the MGB to building steel with a 4/0 AWG conductor.

2. Provide the second path by installing a 4/0 AWG down conductor from the MGB to the ground rod or chemical ground rod. Use the water pipe main entrance if the ground rod or chemical ground rod are not available. Do not use AC service panel grounds.
3. If the Itron TCU / CCU equipment is located on the ground floor or in the basement, the MGB may be connected directly to both building steel and the water main or ground rod.

To ground one 4/0 AWG insulated down conductor and one existing building lightning protection down conductor or building ground system

1. The first path is the installation of one 4/0 AWG insulated down conductor from the roof top MGB bar to the ground rod or chemical ground rod. Use the water pipe main entrance if the ground rod or chemical ground rod are not available. Do not use AC service panel grounds.
2. Install the second path by bonding the roof top MGB bar with a 4/0 AWG insulated conductor to the existing building lightning protection system or building ground system down conductor.
3. If the Itron TCU / CCU equipment is located on the ground floor or in the basement, the MGB can be connected directly to both the existing lightning protection or building ground system and the water main or ground rod.

To ground one 4/0 AWG down conductor

Note Use this option when neither building steel nor a building lightning protection or ground system is available at the Itron TCU / CCU equipment location.

1. Install one 4/0 AWG down conductor from the MGB bar on the roof to a MGB bar in the basement.
2. Bond the basement MGB ground bar to ground by two separate paths.
3. Install two 4/0 AWG conductors from the MGB bar in the basement and terminate each conductor to one of the following grounding options which are listed in the order of preference.

Two different options must be selected for bonding the MGB bar to ground:

- Ground rod or chemical ground rod,
- Building grounding electrode system,
- Building steel (if available)
- Building cold water pipe main entrance.

If the Itron TCU / CCU equipment is located on the ground floor or in the basement, the MGB may be connected directly to the two selected ground points without using a second ground bar.

Down Conductor Installation

Each down conductor must consist of 4/0 AWG stranded copper with green insulation. Preferably, install the down conductor without conduit. If a conduit is required by local standards or by the landlord, then a non-metallic PVC conduit is preferred. If a metallic conduit is required, use the threaded type and install grounding bushings on both ends to bond the conduit with a minimum of No. 2 AWG stranded copper conductor to the ground bar at each end. The metallic conduit must be bonded at both ends to a ground bar to prevent a choke effect in the event of a surge.

A low halogen cable that meets the ratings of Telcordia GR-347 is acceptable. Place the MGB bar as close as possible to the equipment cabinets and the path to ground options (for example, ground rod, cold water pipe, or building steel). Install the ground bar to ensure that the wire bending radii for the 4/0 AWG and No. 2 AWG are a minimum of 12 inches and that all paths to ground travel flat or down.



Warning Never allow a path to ground to travel upward.

Cold Water Pipe Option

The location of the cold water main is usually in the basement or in the mechanical room of the building. When attaching to the pipe, the clamp must come into contact with a minimum of 4 linear inches of pipe or utilize a Burndy GAR clamp.

To ground a cold water pipe

1. Drill the clamp to accept a two-hole ½ inch hardware lug. You can also connect the water pipe by attaching the ground conductor using an approved water pipe clamp.
2. Scrape clean the area of contact to the cold water pipe with the clamp. The area must be free of paint, rust and/or corrosion and coated with an approved anti-oxidation compound before the clamp is attached to the pipe.
3. Locate the clamp on the interior of the building, within five feet of the cold water pipe entry point into the building, without any flanges, or pipe connections between the ground clamp and the pipe building entry point.

Note This is required to ensure good continuity to ground at the point of pipe contact and building entry.

4. If the connection is made on the output side of the water meter, you can install an electrical jumper (minimum 4/0 AWG) around the meter to another clamp to provide a continuous path to ground, in the event the water meter is removed for service.

Building Steel Option

When attaching to building steel for a grounding path, use exothermic weld connections installed per manufacturer's recommendation.

Antenna and Coax Grounding - Rooftops

The rooftop antennas (including the GPS and WAN antennas) are grounded by their mounts and by the ground kits on the coaxial cable connected to the CGBs (Coax Ground Bars).



Warning Do not install separate antenna ground connections unless specified by the antenna's manufacturer.

Grounding antennas on rooftops

1. Bond each antenna mount/mast to the CGB with No. 2 AWG BTCW exothermically welded to the mast and connected to the ground bar with an approved two-hole ground lug.
2. Install coax ground kits as close to the antennas as possible, just before the antenna jumpers, and then bonded to the CGB.

Note If the site configuration is such that the coax runs horizontally along the rooftop and then vertically down the side of the building to the close mount antennas, *Do Not Install* antenna masts or coax ground connections at the antenna.

Instead, install a CGB at the roof edge where the coax transitions from horizontal to vertical. Install coax ground kits as close to the edge as possible where the coax is still horizontal and bond the ground leads to the CGB. Connect the CGB to the MGB in the usual manner.

3. Connect each antenna CGB to the MGB at the equipment location.
4. If the MGB is located on the rooftop, use one run of No. 2 AWG BTCW to bond the CGB to the MGB. Run this along the coax cable tray on the rooftop and secure to the cable tray to prevent wind damage.

Note Due to the fact that the cable tray runs along the roof and the MGB is typically installed at a slightly higher elevation, it may be necessary for ground leads to run slightly upward to bond to the MGB. If this cannot be avoided, ensure that all ground wire bends are smooth and have as large a radius as possible.

5. If the equipment MGB is located inside the building, a separate external ground bar is located where the coax enters the building. All No. 2 AWG BTCW sector grounds bond to this ground bar. In addition, install a coax ground kit on each coax cable and bond it to the ground bar. This external ground bar connects to the interior MGB using a single 4/0 AWG stranded, insulated wire installed along the coax path.

Cable Tray Grounding

All metallic cable tray on a rooftop, mounted on the side of a building, or running inside a building, must be properly grounded.

To ground a cable tray

1. A metallic cable tray must be grounded to the sector CGB at one end and grounded to the MGB at the other end using No. 2 AWG BTCW.

2. Connect the ground wire to the cable tray with two-hole multiple crimp type (with UL tool and circumferential die compression) connections attached with bolts or self-tapping screws.
3. Each section of the cable tray must be electrically connected by either a metal plate or ground jumpers made of No. 2 AWG BTCW and two-hole lugs.
4. If the equipment MGB is located inside the building, the cable tray ground connects to the external ground bar where the coax enters the building.

Water Tower Grounding

Itron does not construct water towers. Therefore, network devices utilizing water towers as antenna structures do not require the installation of a structure ground ring around the leg of a water tower. The equipment BGR serves as the primary ground point for all Itron equipment, antennas, coax, and cable tray.

Install coax ground kits as previously described.

To ground water towers

1. Install all sector ground bars at the top of the tank with stand-off (cherry) insulators and connect separately with No. 2 AWG stranded insulated wire to a CGB at the top of the vertical coax run.
2. Connect the upper and lower CGBs by one 4/0 AWG green insulated wire.
3. Install a lower CGB with stand-off (cherry) insulators at the bottom of the tank leg in a similar manner as on a monopole or self-support antenna tower.
4. In the case of a skirted tank, install the lower CGB in a similar manner with stand-off insulators mounted to the skirt.
5. Coordinate location with the tank owner and the Field Engineering team.
6. With the permission of the water tank owner, drive two ground rods as close to the tank leg as possible. Connect the lower CGB to the ground rods using two No. 2 AWG BTCW.
7. Connect these ground rods to the equipment BGR using two buried No. 2 AWG BTCW along the same path as the coax bridge.
8. If ground rods are not feasible, connect the lower CGB directly to the two runs of No. 2 AWG BTCW that run along the coax bridge and connect to the equipment BGR. Ground the coax bridge as previously described.

Note The local Engineering firm is responsible for the proper design of the ground system at water tanks requiring special considerations.

New Wooden and Concrete Antenna Poles

To ground new wooden and concrete antenna poles

1. Install a BGR that encircles the pole foundation. Construct the BGR in the same manner as the Itron TCU / CCU equipment BGR except that four ground rods will be installed 90 degrees apart.

2. Connect the pole and equipment BGRs using two buried runs of No. 2 AWG BTCW. These connections should follow the same path as the coax bridge if possible.

Note Wooden and concrete poles do not connect directly to the BGR. The BGR will be used to ground the coax and antennas ground bar at the base of the tower as discussed later in this document.

Equipment Shelter Grounding

Ground Itron equipment that is installed in shelters the same way you ground a non-shelter site in terms of equipment ground leads, coax ground kits prior to the Itron TCU / CCU equipment jumpers, and MGB placement.

To ground equipment sored in shelters

1. Connect the internal MGB to the equipment BGR using two No. 2 AWG BTCW ground leads.
The BTCW can penetrate the wall or foundation of the shelter in two separate holes. Refer to the shelter manufacturer specifications for placement and quantity.

Note Whenever ground leads penetrate concrete, they must be protected by PVC conduit.

2. At a location just outside where the coax penetrates the shelter wall, install coax ground kits and connect to a CGB.
3. Bond the CGB directly to the BGR.

Repeaters on Communication Tower Sites

Repeaters at collocation sites must have antenna mounts, coaxial cable, and coax bridges (if required) grounded in the same manner as a full network device.

To ground repeaters on communication tower sites

1. Locate the MGB at the repeater equipment location and bond to the existing ground system at the site with two No. 2 AWG BTCW leads.
2. If no existing BGR exists or it is not practical to connect to the existing BGR, drive a single ground rod adjacent to the repeater equipment to serve as the ground electrode system.
3. Bond the ground leads from the repeater equipment and the coax ground kits, immediately adjacent to the repeater, to the MGB.

CCUs and Repeaters on Utility Poles

CCUs and Repeaters mounted on utility poles will be grounded using a single ground rod located immediately adjacent, if possible, to the utility pole.

To ground CCUs and repeaters on utility poles

1. Connect the ground lead from the repeater, coax, and antenna mounts (if applicable) to a common MGB located below the repeater.
2. Bond the MGB to the ground rod using one run of No. 2 AWG BTCW.
3. If any antennas are located on different structures than the repeater equipment, the antenna mount (if metallic) and coax ground kit will be bonded to a CGB located to permit optimum ground lead connections.
4. Bond the CGB to a single ground rod located immediately adjacent to the support structure using No. 2 AWG BTCW.

Note In all cases, ensure that the grounding design complies with the utility pole owner's requirements.

Repeaters on Rooftops

Repeaters located at rooftop sites must have antenna mounts, coax, and coax cable tray (if required) grounded in the same manner as a full network device.

To ground repeaters on rooftops

1. Locate the MGB at the repeater equipment location.
2. Bond , in order of preference, to one of the following:
 - existing building lightning or ground protection system
 - building steel
 - one 4/0 AWG down conductor to ground rod or cold water main.

Multiple Story Site Ground System

If the site is in a high rise building or in a metropolitan area with very limited access to any earth, then a water pipe electrode with a single chemical ground rod for augmentation is specified. This should yield as low a noise ground system as possible even if it is not exactly a five ohm ground.

Down Conductors Installation - Building / Shelter Penetrations

Use Schedule 40 or 80 polyvinyl chloride (PVC) conduit to carry the required down conductors, penetrating the outer wall and foundation of each building at ground level. Using steel conduit is unacceptable since it significantly increases the conductor's inductance.

Down Conductors Installation - Limits of Bend Radius

Connect the inside halo ground and the BGR with conductors that follow a path as straight and vertical as possible with no bend having a radius of less than eight inches. Deviations can cause increased inductive reactance leading to excessively high voltage and/or flash over during a lightning strike.

Down Conductors Installation Connection Methods

Use an approved exothermic welding system to connect all down conductors to the BGR.

AC Power Grounding Connections

In accordance with the National Electric Code, Article 250 or appropriate local codes, bond the AC power neutral to the Master Ground Bar (MGB-1) Producer (P) section. Refer to Section 3.2.1 of NP-312-202, Interior Grounding System Design, for more information.

Utility Provided AC Power Transformer Neutral Grounding

The neutral of the distribution transformer is grounded by the power company. It is important that the transformer ground not be connected to any part of the building or tower ground ring. It should be grounded using its own ground rod. This reduces any neutral currents that might flow in the site ground system.



Warning If the transformer is located near the building, connect the transformer ground directly to the BGR.

Cable Entrance Facilities

The MGB must be used for the single reference ground for all interior grounds.

To ground cable entrance facilities

1. Install a copper entrance TVSS at the entrance of the copper cable into the building space.
2. Bond all shielded cabling entering the building envelope to the MGB as soon as it enters the building. Ideally, these cables need to enter near (within three feet) of the MGB.

Note For all dielectric fiber cables, there is no requirement for bonding to the MGB, and therefore, no requirements for these cables to enter within 3 feet of the MGB.

3. Bond the sheaths of the copper phone cables, fiber cables, and coax cables to the MGB.
4. If the cable entrance is a distance away, then install and bond a separate terminal Fiber/Copper Ground Bar (FCGB).

5. The shields of all low voltage shielded control cable, where the cable is connected to a device outside the building and to a controller inside the building, must be grounded at the device outside the building.
6. Install a TVSS for all cables (including copper and low voltage shielded control cables) entering the building.
7. Ground the TVSS to the MGB if it is within a short distance.
8. If the TVSS is a distance from the MGB, bond it to earth (for example, building steel or dedicated ground rod).

Note Any conductor in a continuous grounded metal conduit does not require a TVSS be installed.

Clamp-On Ground Resistance Testing

A clamp-on ground resistance tester measures ground rod and small ground grid resistance without the use of auxiliary ground rods. Clamp-on ground resistance testers are used in multi-grounded systems without disconnecting the ground under test and with electrical service connected.

To use a clamp-on ground resistance tester

1. Clamp the tester around the ground conductor and read the resistance-to-ground directly from a digital display.
This type of measurement permits the quality of the grounding connections and bonding to be verified.
2. Use certified Ground Resistance Testers for all clamp-on ground resistance measurements.

Principle of Operation

In a typical grounded system, the neutral is bonded to ground at the service panel. There are numerous neutral-to-ground bonds prior to this point, all in parallel. These bonds create an effective earth resistance from the utility of virtually zero. A clamp-on ground resistance tester uses this fact along with the connection between the utility service and the grounding system under test. The clamp-on tester injects a known voltage into the system and measures the current felt on the return path. Realizing the near "zero" resistance on the service side, the meter reading indicates the resistance of the grounding system under test.

The following illustration shows a Principle of Operation.

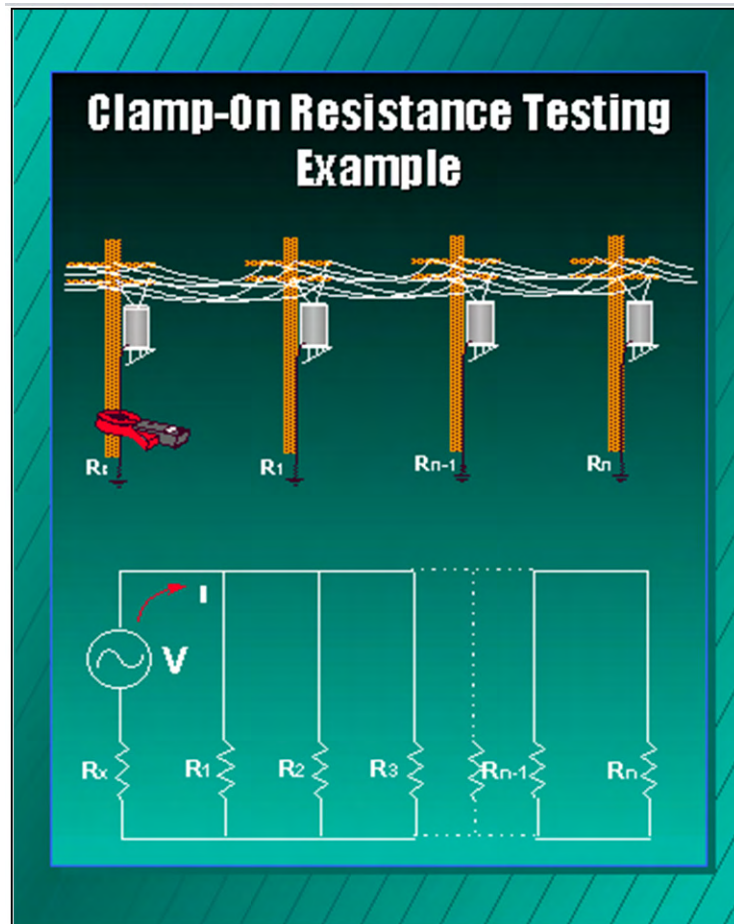

Determining the Correct Measuring Point

The preferred point of measurement (if internal bonding allows) is on the conductor between the ground bus and the service neutral. If internal bonding does not allow access to this point, an alternate point is on the service side of the neutral line prior to the neutral to ground bond. In either case, it is necessary to ensure there are no neutral-to-ground bonds downstream of the measurement point.

The following illustration shows an overview of the testing location.

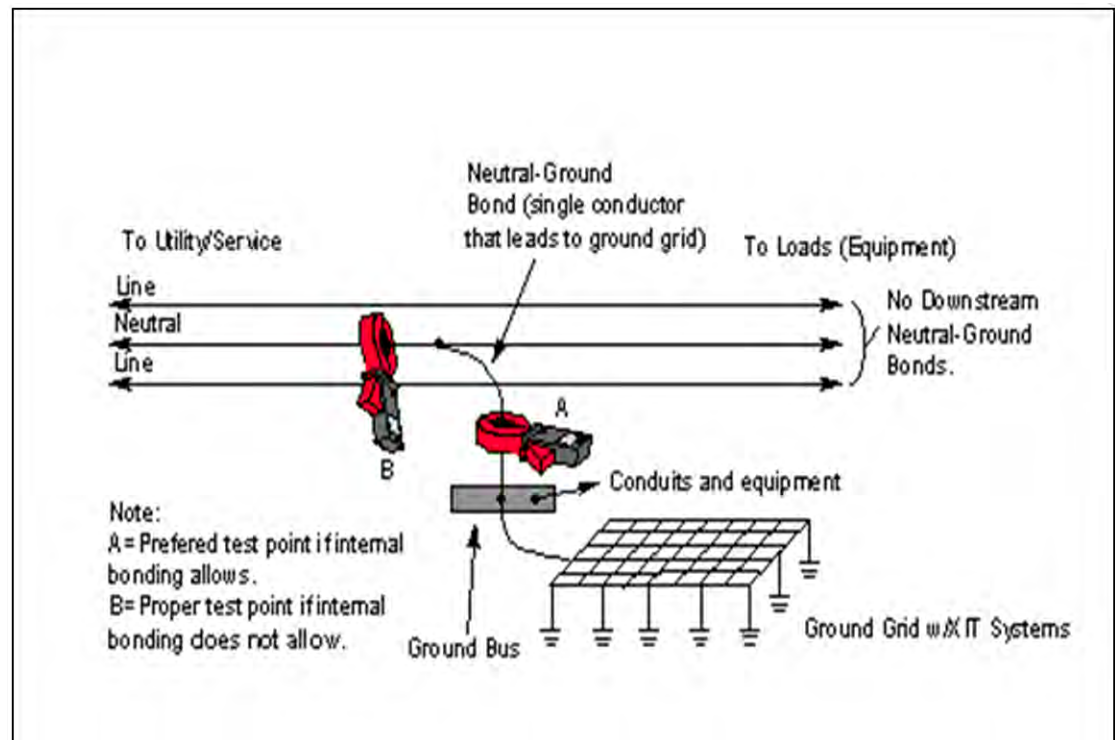

Testing Procedures

To prepare the meter

1. Ensure mating surfaces of the jaws are clean and free of corrosion.
2. Press and hold the ON/OFF button for approximately 3 seconds.
3. Verify the clamp-on ground resistance tester enters the self-test mode and displays the remaining battery life. If the battery does not have enough life remaining to complete the job, replace the battery as described in the user's manual.
4. Verify the calibration of the meter with the calibration loop. Refer to the Manufacturer's User's Manual for tolerances.

Measuring Rod/Grid Resistance



Warning High voltages may be present in and around the point of measurement. Take caution to avoid serious injury or death.

To test the current measurement

1. Remove any molding that covers the conductor, providing room for the jaws of the clamp-on ground resistance tester to close completely around the conductor.
2. Press the ON/OFF button.

3. Ensure the display indicates OLD Ω .
4. Press the A button.
5. Clamp the jaws around the conductor and measure the ground current.

Warning If the ground current exceeds 5 amps or noise exceeds 50 Volts, then ground resistance measurements are not possible. **Do not proceed further with the measurement.**

6. Press the " Ω " button and measure the rod/grid resistance to ground.

Note A 0.7 OHM reading is an error indication. This reading signifies the measurement of a loop circuit, and is usually caused by the improper placement of the clamp-on ground resistance tester.

7. If the face of the meter is not visible while the jaws are clamped around the conductor, press the **Hold** button, remove the meter, and read/ record the indication.
8. Press the **Hold** button again to clear the reading.
9. Replace any molding that was removed in earlier steps.

Understanding Party Responsibilities

This section outlines each party's responsibilities when grounding Itron equipment.

Itron Responsibilities

Itron's responsibilities include the following:

- Physical verification of all network device installations, to confirm the Supplier's quality of the installation work. The Supplier should expect that representatives from both Itron and the Customer will be on site at several installations of each type of network device (if not more), to ensure the installations meet the Itron and Customer quality and design requirements.
- Physical attendance at all Grounding testing and final punch-walk inspections. Itron will communicate any Supplier workmanship concerns, to the Supplier, as soon as physically possible.
- Validation of the functionality of each Itron TCU 100, CCU 100 and Repeater 100 device, once the Supplier has completed an installation and the devices are powered up.

Supplier Responsibilities

Supplier's responsibilities include the following:

- Performing the physical work required to install the Itron network devices, in accordance with the Itron provided documentation and training, including site grounding.
- Install where required proper weatherproofing and grounding to ensure safe operation of equipment.
- Performing all Grounding testing, documenting each network device installation with at least 2 digital pictures and reporting the measured results.

- Providing all required tools, equipment and capable field crews that are required to properly install Itron network devices, including modern Clamp-on ground testing equipment.

Note Supplier is responsible for ensuring all Supplier managed field crews meet any local labor and / or pay requirements, such as union requirements, Local Business, mandatory minimum "Living Wages", as may be required.

- Include the expected equipment and costs associated with performing grounding testing, per the current version of the Itron Grounding Specifications.
- Compiling a package of as-built and closeout documentation in a compact electronic format (Adobe .pdf files preferred) and e-mailing each site package to the Itron PM development within 3 business days following each completion.

Index

Symbols & Numbers

A

AC

- installation diagram • 38
- mains power • 13
- service requirements • 9
- tower installation diagram • 44

angles

- azimuth • 47
- tilt • 47

Antenna Line Sweeps Procedure • 83

antennas • 3, 4, 10, 12, 20, 21, 74

- 900 MHz • 4, 10, 14, 20, 62, 74
- GPS • 3, 8, **Error! Bookmark not defined.**, 20, 62
- grounding • 10
- high gain • 15
- placement • 10
- specifications • 62
- WAN • 3, 8, **Error! Bookmark not defined.**, 20, 62

arrays • 45

azimuth • 47

B

battery

- battery pack • 64
- calendar life • 56
- charging • 55
- installing • 34
- maintenance • 56
- replacing • 57
- shipping requirements • 53
- storage • 53

brackets • 17, 22

C

CCUs

- configuration • 1
- davit arm mount • 28
- installation profiles • 7
- installing • 19

mounting hardware • 17, 22

pipe mount • 23

pole mount • 25

power operating range • 64

siting • 7

specifications • 59

wall mount • 27

charging • 53

coaxial cable • 14

components • 1

connecting cables • 9, 12, 14, 16, 29

connectors • 16

D

davit arm mount • 28

diagrams

AC installation • 38

AC tower installation • 44

solar installation example • 50

solar wiring example • 46

dimensions • 59

E

endpoint antenna • 4, 10, 21, 62

environmental specifications • 63

Ethernet connections • 9

F

ferrite bead • 35

G

GPS

antenna • 3, 10, 20

coverage • 8

grounding • 10, 12, 93

Grounding Specifications Procedure • 93

H

hardware • 14, 17, 22

I

ICS • 9, 19, 39

initial collector setup • 9, 19, 39

installation profiles • 7

L

lightning arrestor • 12

line sweeps procedure • 83

long-term storage • 54

M

mains power

AC • 13

DC • 14

maintenance • 53

materials not provided by Itron • 14

module • 2

mounting hardware • 17, 22

O

operating range • 64

P

passwords • 77

pedestal dimensions • 59

performing an antenna sweep test • 74, 83

pipe mount • 23

pole mount • 25

port requirements • 9, 67

power operating range • 64

preventative maintenance • 56

profiles • 7

propagation study • 8

protocol requirements • 9, 67

providing power • 36

PZWatts • 48

R

remote antennas • 3, 4, 10, 20

repeaters

davit arm mount • 28

installation profiles • 7

installing • 19

mounting hardware • 17, 22

pipe mount • 23

pole mount • 25

Repeater power operating range • 64

siting • 7

specifications • 59

wall mount • 27

replacing the battery • 57

S

service life • 56

shipping requirements • 53

site selection • 7, 8

solar installation diagram • 50

solar wiring diagram example • 46

specifications

antenna • 62

battery pack • 64

CCU • 59

environmental • 63

repeater • 59

transmitter • 64

state of charge • 55

status indicator • 73

storage • 53

T

tilt • 47

transmitter specifications • 64

W

wall mount • 27

WAN

antenna • 3, 20, 62

coverage • 8

weatherization • 30