

# **ESTEEM USERS MANUAL**

for

## **MODEL 192E**

**May 2001**

*Electronic Systems Technology (EST) copyrights this manual and the firmware described in it, with all rights reserved. Under the copyright laws, this manual or the firmware internal to the ESTeem unit may not be copied, in whole or part, without the written consent of EST. Under the law, copying includes translating into another language.*

*EST cannot guarantee that you will receive notice of a revision to the firmware described in the manual, even if you have returned a registration/warranty card received with the product. You should periodically check with your authorized EST dealer or call factory direct.*

*EST and the EST logo are registered trademarks of Electronic Systems Technology, Inc. Simultaneously published in the United States and Canada. All rights reserved.*

# PRODUCT WARRANTY

Electronic Systems Technology, Inc., (hereinafter EST) expressly warrants its products as free of manufacturing defects for a period of one year from the date of sale to first user/customer.

***THERE ARE NO OTHER WARRANTIES, EXPRESS OR IMPLIED AND THERE IS EXPRESSLY EXCLUDED ALL WARRANTIES OF MERCHANTABILITY OR FITNESS FOR A PARTICULAR PURPOSE. NO OTHER WARRANTY GIVEN BY ANY EMPLOYEE, AGENT, DISTRIBUTOR OR OTHER PERSON WITH RESPECT TO THE PRODUCT SHALL BE BINDING ON EST.***

## **LIMITATION OF LIABILITY:**

EST's liability shall be limited to refunding of purchase price, repair or replacement of product.

***IN NO EVENT SHALL EST HAVE LIABILITY FOR CONSEQUENTIAL, INCIDENTAL, SPECIAL OR EXEMPLARY DAMAGES CAUSED DIRECTLY OR INDIRECTLY BY THE PRODUCT, INCLUDING BUT NOT LIMITED TO ANY INTERRUPTION OF SERVICES, LOSS OF BUSINESS OR ANTICIPATORY PROFITS. IN NO EVENT SHALL EST BE LIABLE FOR ANY DAMAGES WHATSOEVER IN EXCESS OF THE PURCHASE PRICE OF THE PRODUCT.***

In the event that a unit or part requires replacement or factory servicing, the following conditions apply:

- a) Customer must obtain from EST an authorized RMA (Return Materials Authorization) number (call 509-735-9092 Customer Support) before shipment of product or parts to EST for any reason;
- b) If the whole unit is shipped, it must be in its original carton and shipping components, or a carton and shipping components supplied by EST, or if parts only are shipped, they must be packaged and cushioned so as to prevent damage in transit and shipped freight prepaid;

## **PRODUCT WILL BE CONSIDERED OUT OF WARRANTY IF:**

- a) If the product is damaged due to improper or abnormal use, abuse, mishandling, accident or improper maintenance or failure to follow operating instruction;
- b) If the product is defective as a result of sand, dirt, or water damage;
- c) If any factory-sealed enclosure has been opened or shows evidence of an attempt to be opened;
- d) If defects or damage are caused by the use of unauthorized parts or unauthorized service;
- e) If the product has had its serial numbers altered or removed.

Warranty repair form must be accompanied by proof of user's purchase of unit. Product must be shipped to the manufacturer at the following address:

Electronic Systems Technology  
415 North Quay Street  
Kennewick, Washington USA 99336

## **ADDITIONAL SERVICE:**

If EST releases an improvement update to firmware internal to the ESTeem unit during the 90 day period after the unit was purchased by the first user/customer, EST will update the applicable unit with the revised version at no charge other than for UPS handling and shipping to and from your location to the EST factory. Return of any such item must be accompanied with proof of purchase.

# TABLE OF CONTENTS

## CHAPTER 1 - STARTING OUT

Overview .....	1-2
Hardware Layout .....	1-2
Installing ESTeem Utility Software – Windows 95/98/NT.....	1-2
Running The Program .....	1-2
Front Panel Description .....	1-3
Basic Configuration.....	1-3
Connect and Power Up the ESTeem.....	1-3
Opening the ESTeem Configuration Menu .....	1-4

## CHAPTER 2 – APPLICATION PROGRAMMING

Selecting Ethernet Configuration .....	2-2
Using the Configuration Menu.....	2-2
Accessing Through Telnet .....	2-2
Changing Configuration Information.....	2-2
Saving and Exiting Configuration Menu.....	2-2
Modem Setup.....	2-2
Step 1 – Radio Configuration.....	2-2
Step 2 – Modes of Operation.....	2-3
Access Point Configuration.....	2-3
Ethernet Bridging Configuration .....	2-4
Master Bridge.....	2-5
Client Bridge .....	2-5

Repeater Configuration .....	2-6
Combined Access Point and Bridging.....	2-6
Loading Factory Default Values .....	2-7

## CHAPTER 3 - INTERFACING

Serial Interface Configuration .....	3-2
RS-232 Port Pin-Out Table.....	3-2
Ethernet Interface.....	3-3

## CHAPTER 4 - ANTENNAS

Antenna and Cable Configurations.....	4-2
Weather Proofing Coaxial Connectors.....	4-2
Grounding.....	4-3
Lightning Arrestors.....	4-3
Model 192E Typical Outdoor Antenna Installation Diagram .....	4-3
Model 192E Typical Indoor Antenna Installation Diagram .....	4-4
ESTeem SWR Measurements Block Diagram .....	4-5

## APPENDICES

### Appendix A - FCC Licensing

(USA only).....	APX A-2
-----------------	---------

### Appendix B - Specifications

ESTeem Specifications.....	APX B-1
Model 192E Antenna Specifications.....	APX B-2

# CHAPTER 1

## STARTING OUT

---

### OVERVIEW

### HARDWARE LAYOUT

### INSTALLING SOFTWARE

**Installing ESTeem Utility Software**

**Running The Program**

### FRONT PANEL DESCRIPTION

### BASIC CONFIGURATION

**Connect and Power Up the ESTeem**

**Opening the Configuration Menu**

# CHAPTER 1 STARTING OUT

## OVERVIEW

The ESTeem Model 192E is a wireless LAN transceiver that can be configured as the center point of a stand-alone wireless network, connection point between wireless and wired network (Access Point) or a bridge between Ethernet segments. Each configuration is explained in detail in Chapter 2 of this manual. This section of the User's Manual will complete the basic configuration of the system and allow further programming through the ESTeem Configuration Menu.

The ESTeem Model 192E uses a menu-driven management system for configuration and diagnostics. This management system can be accessed through a Telnet network connection or through any terminal emulation program. To link through the network connection, some of the basic operating parameters such as assigning the ESTeem an IP address and Subnet mask must be completed by accessing the configuration menu through the serial port. Any terminal emulation program can be used for this configuration of the ESTeem and will be configured similarly, but this section of the manual will describe basic configuration of the ESTeem Model 192E using the Terminal Emulation program contained on the ESTeem Utility Program CD-ROM.

## HARDWARE LAYOUT

Locate the items contained in Figure 1 for initial configuration of the ESTeem Model 192E. Take a few minutes to inventory your equipment before you proceed. Report any missing or damaged items to Customer Support (509-735-9092) as soon as possible.

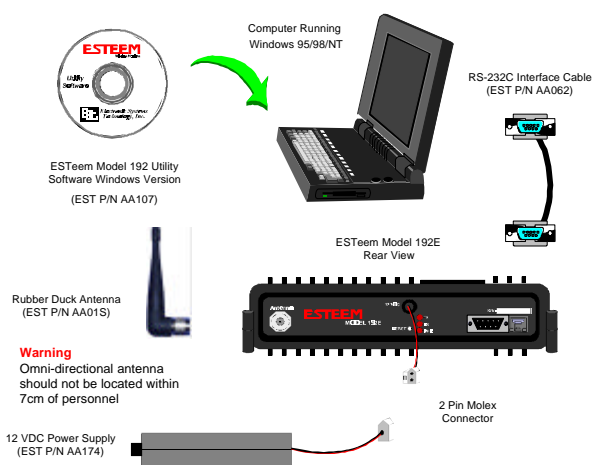

Figure 1: Hardware Layout Diagram

**Caution:** Your ESTeem hardware may have antennas other than the AA01S listed in Figure 1, but you must have an antenna connected to the antenna port before applying power to the unit.

## INSTALLING SOFTWARE

The ESTeem Utility Program is designed to provide the ESTeem user access to the configuration menu of the ESTeem Model 192E. The Utility contains a Terminal Emulation program that will allow direct access to the management menus of the modem. None of the other sections of this utility, such as Diagnostics will function with the Model 192E. The ESTeem Utility Program is designed to operate with Windows 95®, Windows 98® and Windows NT® 4.0 and greater.

### Installing ESTeem Utility Software Windows 95/98/NT4.0 (or greater)

1. Place the ESTeem Utility Software CD in your CD-ROM drive (Figure 1).
2. Select Run on the Start Menu.
3. Type (your CD-ROM drive letter, D in this example D:\ESTUtil\Setup.exe)
4. Click the OK button and the program will begin installation.

### Running The Program

1. Select the ESTeem Utility Icon on Start>Programs menu. Figure 2 shows an example of the Main Utility Menu.



Figure 2: ESTeem Utility Main Menu

# CHAPTER 1 STARTING OUT

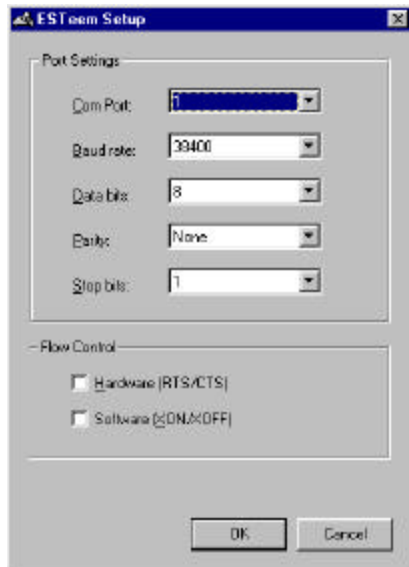

**Figure 3: Serial Port Configuration Menu**

2. Select Terminal Emulation from the Main Menu.
3. Once the Terminal Emulation is loaded, select the Terminal Setup from the menu and press Ports. You should see the serial port configuration menu (Figure 3).
4. Select the serial port you have connected to the ESTeem Model 192E (i.e. COM1 would be 1), set the Baud Rate to 38400, Data Bits to 8, Parity to None, Stop Bits to 1 and leave both the Hardware and Software flow control boxes unchecked. Press the OK button when complete.
5. Verify the settings in the upper left hand corner of the Terminal window are set to COM1:38400,N,8,1). If the communications port number is other than 1 it will be displayed as the number (i.e. COM2, etc.).

The software is now configured for accessing the ESTeem Model 192E for system configuration. Any other terminal emulation program will need to be configured similarly.

## FRONT PANEL DESCRIPTION

Figure 4 contains a description of the ESTeem Model 192E front panel.

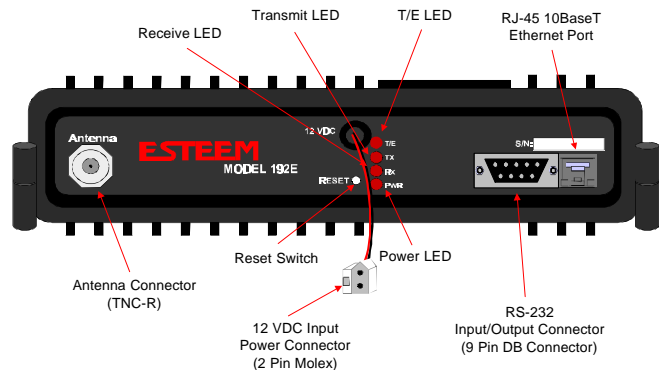

**Figure 4: Front Panel Description**

## BASIC CONFIGURATION

### Connect and Power Up the ESTeem

The following steps should be completed before any modifications are made to the network operating parameters for the ESTeem Model 192E.

*Note: Plan to configure the Model 192E prior to mounting. Some of the following steps, such as connecting the serial cable, are easier to perform if the ESTeem is accessible.*

1. Connect the antenna to the antenna port on the ESTeem Model 192E (Figure 4).
2. Connect the Ethernet cable from the wired 10BaseT Ethernet LAN to the Ethernet connector on the front of the ESTeem (Figure 4).
3. Connect the serial cable (EST P/N: AA062) between the RS-232 connector on the ESTeem to the serial port on the computer.
4. Plug the ESTeem Model AA174 power supply into a wall socket and connect the Molex power connector to the ESTeem. The power light (PWR) on the front of the ESTeem should be illuminated.
5. You should see the ESTeem Model 192E booting sequence on your Terminal Emulation program. Once the ESTeem boot sequence is complete (approximately 1 minute) you will receive the message "Please press Enter to activate this console."
6. Press the Enter key and you will be at the Configuration Menu login prompt (192E login:). See Figure 5 for an example of this prompt.

# CHAPTER 1 STARTING OUT

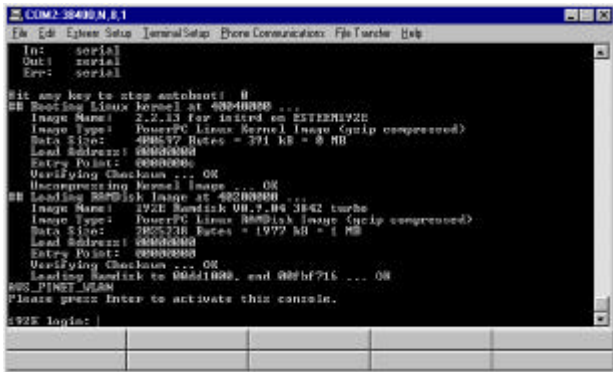

Figure 5: Boot Prompt Example

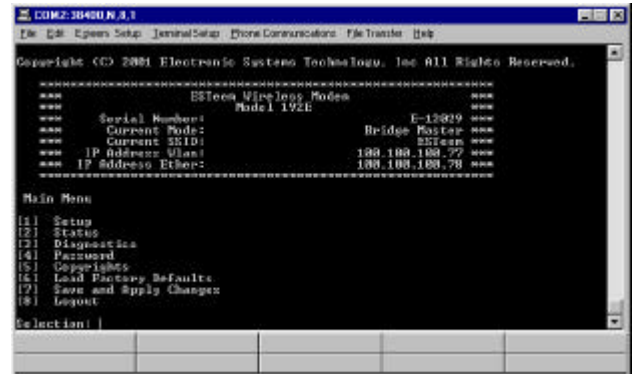

Figure 6: Configuration Menu

## Opening the ESTeem Configuration Menu

To enter the Model 192E Configuration Menu you will need to log into the system with a login name and password.

**Note:** These values can be changed from factory default through the Configuration Menu. If this not the first time configuration of the ESTeem, see you network systems administrator for these values.

If this is the first time the ESTeem has been programmed or the login was not changed from the factory default values, please use the following to access the Configuration Menu:

1. At the 192E login prompt type admin for the login name and press the Enter key (<Enter>). Please note that all characters are lower case.
2. At the Password prompt type admin for the password and press the Enter key (<Enter>). Please note that all characters are lower case.

The ESTeem Configuration Menu (Figure 6) will now be displayed. Please proceed to Chapter 2 in this manual for programming the ESTeem Model 192E for your specific application.

# CHAPTER 2

## APPLICATION PROGRAMMING

---

### SELECTING ETHERNET CONFIGURATION

#### USING THE CONFIGURATION MENU

Accessing Through Telnet

Changing Configuration Information

Saving and Exiting Configuration Menu

#### MODEM SETUP

Step 1 - Radio Configuration

Step 2 – Modes of Operation

Access Point Configuration

Ethernet Bridging Configuration

Repeater Configuration

Combined Access Point and Ethernet Bridging

#### LOADING FACTORY DEFAULT VALUES



# CHAPTER 2

## APPLICATION PROGRAMMING

### SELECTING ETHERNET CONFIGURATION

To begin setup of your wireless Ethernet network you must first select the type of Model 192E configuration required. The following are examples of networking requirements and the type of configuration required for each:

Networking Requirements	Model 192E Configuration
Link 802.11b wireless network cards (EST P/N: WLANC11 or others) in Infrastructure Mode	Access Point (Figure 3)
Provide relay point for wireless network cards (EST P/N: WLANC11 or others) to increase range of Wireless Area Network (WLAN)	Access Point
Provide access to a cabled Ethernet network from a wireless network (WLAN)	Access Point
Communicate between two or more Ethernet (10BaseT) ports using the Model 192E	Ethernet Bridge (Figure 6)
Link two or more Ethernet HUBs using the Model 192E	Ethernet Bridge
Provide building to building Ethernet access using Model 192E	Ethernet Bridge
Provide wireless Ethernet links to both remote 10BaseT Ethernet ports and access to wireless network cards	Combined Access Point and Bridge (Figure 10)

All possible Ethernet network configurations can not be listed. If your application does not match any of the above Networking Requirements, please consult with your network system administrator or contact EST Customer Support at 509-735-9092.

### USING THE CONFIGURATION MENU

The ESTeem Model 192E Configuration Menu (Figure 1) is used to set the operating parameters of the wireless Ethernet modem to operate in an Ethernet network. We learned in Chapter 1- Starting Out how to configure a terminal emulation program to access the Configuration Menu through the RS-232 port on the ESTeem. If you have not completed Chapter 1 or have questions on how

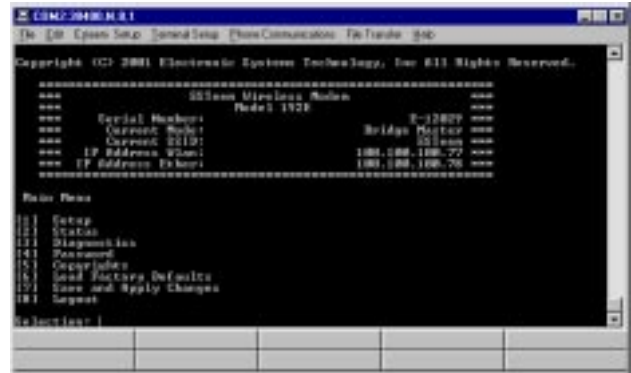

Figure 1: Configuration Menu

to access the Configuration Menu, please review that section before proceeding.

### Accessing Through Telnet

Looking at the Main Menu screen of the Configuration Menu, you will notice the header lists the connected ESTeem Model 192E's serial number, current mode of operation, current Service Set Identifier (SSID - if Access Point) or Bridge IP address (Bridge Mode Only), and IP address. Using the IP address, you can start a Telnet session to the ESTeem through the Ethernet network to access the Configuration Menu.

*Note: If the ESTeem Model 192E is configured in Ethernet Bridge mode, the Wireless IP and the Ethernet IP addresses must be on unique Subnets (See Ethernet Bridging Configuration for more information) to gain access to the configuration menu through Telnet. Each operating system has a different method of starting a Telnet session. Please review the documentation on your operating system or consult with your network system administrator.*

### Changing Configuration Information

To move between menu items in the ESTeem Model 192E Configuration Menu you must first enter the number next to the menu item and then press the Enter Key (<Enter>). All commands must be followed by the Enter key. For example, to review the Copyright information on the ESTeem Model 192E, press the number 5 key followed by the Enter key (5<Enter>).

The Configuration Menu will always prompt you if further input is required or the input received was invalid. To back out of most menu screens and return to

# CHAPTER 2

## APPLICATION PROGRAMMING

the previous menu without making changes, press the X followed by the Enter key (X<Enter>).

### Saving and Exiting Configuration Menu

Any changes made in the Configuration Menu will only take effect in the Model 192E when the **Save and Apply Changes** (7<Enter>) is selected. When **Save and Apply Changes** is selected, you will be asked if you wish to continue. Press the Y key followed by the Enter key (Y<Enter>) and the ESTeem will save the changes and reboot the modem. It will take approximately 1 minute for the ESTeem to reboot to obtain a new login prompt.

If you wish to exit the Configuration Menu without saving any of the changes made, select **Logout** (8<Enter>).

*Note: Any changes made during the time you were logged into the Configuration Menu will be lost.*

### MODEM SETUP

#### Step 1 – Radio Configuration

The first step in configuring a wireless Ethernet network is setting all ESTeem Model 192Es that communicate with each other to the same radio configuration parameters.

1. From the Configuration Main Menu, select **Setup** (1<Enter>).
2. Select **Radio Configuration** (2<Enter>) to load the Radio Configuration Menu (Figure 2).
3. Select **Power Settings** (1<Enter>) to configure the output power of the ESTeem.
4. Select **Data Rates** (2<Enter>) to set the RF baud rate of the ESTeem. If all baud rates (1, 2, 5.5 and 11

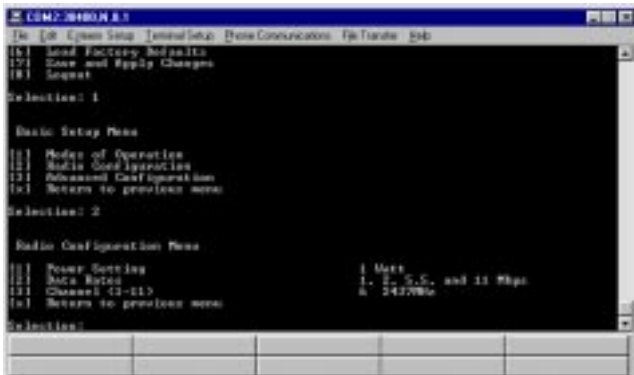

Figure 2: Radio Configuration Menu

Mbps) are listed, the ESTeem will scale through the baud rates as required by signal quality and strength (**recommended**).

5. Select **Channel** (3<Enter>) to set the operating frequency of the ESTeem.

*Note: All ESTeems that communicate with each other MUST be set to the same channel number.*

Channel Number	Center Frequency
1	2412 MHz
2	2417 MHz
3	2422 MHz
4	2427 MHz
5	2432 MHz
6	2437 MHz
7	2442 MHz
8	2447 MHz
9	2452 MHz
10	2457 MHz
11	2462 MHz

6. Review all your changes on the screen are correct and select **Return to previous menu** (X<Enter>) to return to the Setup Menu.
7. Select **Return to previous menu** (X<Enter>) a second time to return to the Main Menu.

#### Step 2 – Modes of Operation

The ESTeem Model 192E can be used in a variety of network system configurations. The ESTeem can stand-alone as the center of a wireless infrastructure, can provide access from your wireless network to your wired LAN, or bridge between Ethernet segments on your network.

The Model 192E can also be configured as a repeater in the network to increase the range of the wireless infrastructure. The maximum communications range is based upon how you configure your wireless network. This section of the manual will describe the possible configurations of the wireless network.

#### Access Point Configuration

In this network one of the ESTeem Model 192E modems is configured as the “Access Point”. This Access Point is then used to bridge wireless network to the cabled LAN network or act as the center point on a stand alone wireless network. When configured in this type of

# CHAPTER 2

## APPLICATION PROGRAMMING

network, all wireless cards (ESTeem Model WLANC11) communicate only with the Access Point that serves the Wireless Local Area Network (WLAN) as a HUB. Multiple Access Points can be configured in the network to extend the coverage area of the wireless cards. The wireless cards will automatically change between Access Points (Roam) as long as they are all configured with the same SSID and Wired Equivalent Privacy (WEP) information. This type of network can extend the range of the wireless cards greater than they can directly communication with each other.

The Access Point is responsible for maintaining a logical link between the clients and providing the wireless clients with access to information on the wired LAN network. Figure 3 shows an example of the Model 192E in an Access Point Configuration.

To configure the ESTeem Model 192E as an Access

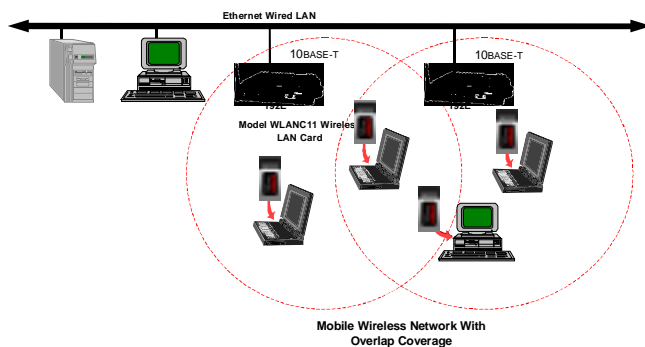

Figure 3: Access Point Diagram

Point, please use the following:

1. From the Configuration Main Menu, select Setup (1<Enter>).
2. Select Modes of Operation (1<Enter>) to enter the system configuration menu (Figure 4).
3. Select Access Point (1<Enter>) to open the Access Point configuration screen.
4. Select Current SSID (1<Enter>) and type in the SSID information for your WLAN.

**Note:** The SSID is the unique identification for your wireless network. All 802.11b devices that share a wireless network MUST have the same SSID code. This identification code is case sensitive and must NOT contain spaces.

5. Select Current IP Address (2<Enter>) to assign the ESTeem an IP address.
6. Select Current IP Net Mask (3<Enter>) to change the ESTeem Net Mask.

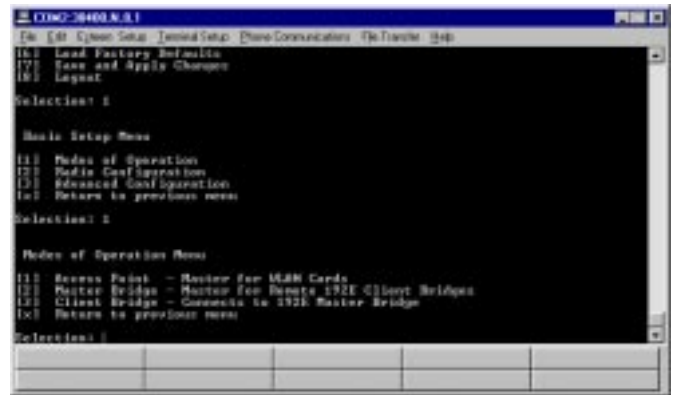

Figure 4: Access Point Configuration Menu

7. If the wireless network is going to be using WEP security codes, press Encryption Settings (4<Enter>) to enter the Privacy Menu (Figure 5) otherwise leave the setting at “False” and skip to Step 12.

**Note:** Setting the WEP security codes are highly recommended for network privacy. They do require extensive network administration, but if used correctly they can provide the same level of security as a wired network.

8. If WEP security is going to be used in the WLAN, select Encryption Enabled (1<Enter>) and value will

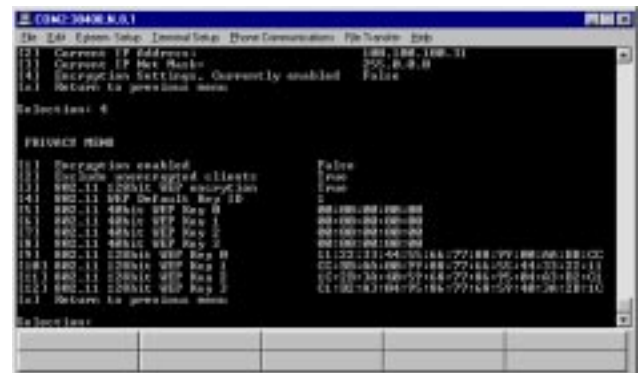

Figure 5: Privacy Menu

change to “True”.

9. If you wish to keep clients without the correct WEP code from entering your WLAN, set Exclude unencrypted clients (2<Enter>) to “True” otherwise set to “False”. If this value is set to “False”, the Access Point will allow clients without the correct WEP code and those with the correct WEP code to join the network as long as all SSID codes match.
10. Select 802.11 128bit WEP encryption (3<Enter>) and set to “True” if the wireless cards will be using

# CHAPTER 2

## APPLICATION PROGRAMMING

128bit WEP encryption. If using 40bit WEP encryption, leave at “False”.

11. Load the WEP Key values in sections 4-12. Review all your changes on the screen are correct and select Return to previous menu (X<Enter>) to return to the Access Point Configuration Menu.
12. If all configurations appear correct, press Load Values and Return to Main Menu (M<Enter>).
13. Once at the Main Menu, press Save and Apply Changes (7<Enter>) and Yes (Y<Enter>) to reboot the ESTeem.

### Ethernet Bridging Configuration

The Ethernet Bridging network allows the Model 192E modems to provide links between two or more Ethernet segments on a network. Ethernet segments can be either single network clients such as computers or PLCs or ties into building LAN networks such as HUBS or switches.

This type of network can provide tremendous flexibility in your wireless network configurations and also provide a much greater range than available through the wireless card network as described in the Access Point section. Figure 6 shows an example of an Ethernet Bridging network.

The Bridging Mode has two possible configurations, Master Bridge and Client Bridge (Figure 6). A bridging networks can only have one ESTeem Model 192E configured as a Master Bridge. A 192E configured as a Client Bridge can communicate with another 192E configured as a Client Bridge, but the Ethernet data MUST be routed through a Master Bridge first. The two Client Bridge modems do not communicate directly, therefore all bridge networks must have at least one 192E

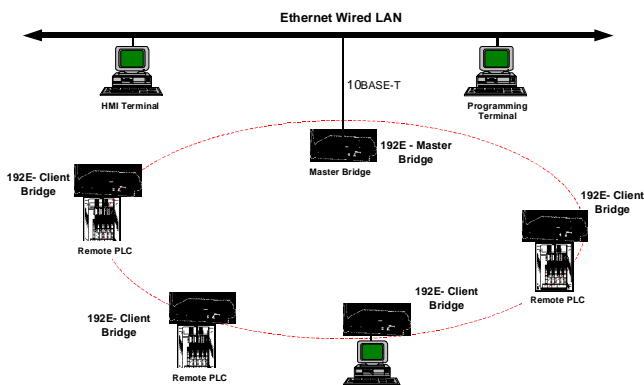

Figure 6: Bridging Mode Diagram

configured as the Master Bridge. For example, in a simple point to point wireless Ethernet network, one Model 192E will be configured as a Master Bridge and one will be configured as a Client Bridge.

### Master Bridge

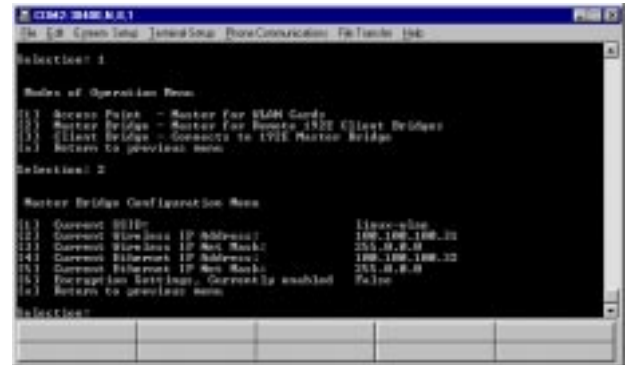

Figure 7: Master Bridge Configuration

To configure the ESTeem Model 192E as a Master Bridge, please use the following:

1. From the Configuration Main Menu, select Setup (1<Enter>).
2. Select Modes of Operation (1<Enter>) to enter the system configuration menu (Figure 4).
3. Select Master Bridge (2<Enter>) to open the Master Bridge configuration menu (Figure 7).
4. Select Current SSID (1<Enter>) and type in the SSID information for your bridge network.

**Note:** The SSID is the unique identification for your wireless network. All ESTeem Model 192Es in the bridge network MUST have the same SSID code. This identification code is case sensitive and must NOT contain spaces.

5. Two unique IP addresses are required for the ESTeem Model 192E in bridging mode. Both the WLAN port and the 10BaseT port need a unique IP number (Figure 8). Select Current Wireless IP Address (2<Enter>) to assign the ESTeem an IP address.

**Note:** To gain access to the Model 192E through Telnet while configured in Bridge Mode, the Wireless IP and the Ethernet IP address must be on unique Subnets. Contact your system network administrator for further information on what IP address should be used in the subnet.

6. Select Current Wireless IP Net Mask (3<Enter>) to change the ESTeem Net Mask.

# CHAPTER 2

## APPLICATION PROGRAMMING

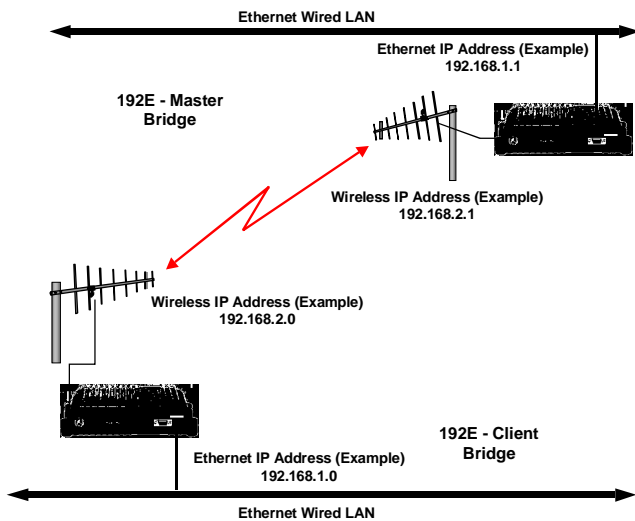

**Figure 8: IP Addressing Diagram**

7. Select Current Ethernet IP Address (4<Enter>) to assign the ESTeem an IP address.  
*Note: The Ethernet IP and the Wireless IP addresses must NOT be the same.*
8. Select Current Ethernet IP Net Mask (5<Enter>) to change the ESTeem Net Mask.
9. If the bridge network is going to be using WEP security codes, press Encryption Settings (6<Enter>) to enter the Privacy Menu (Figure 5) otherwise leave the setting at “False” and skip to Step 14.  
*Note: Setting the WEP security codes are highly recommended for network privacy. They do require extensive network administration, but if used correctly they can provide the same level of security as a wired network.*
10. If WEP security is going to be used in the bridge network, select Encryption Enabled (1<Enter>) and value will change to “True”.
11. If you wish to keep clients without the correct WEP code from entering your bridge network, set Exclude unencrypted clients (2<Enter>) to “True” otherwise set to “False”. If this value is set to “False”, the Access Point will allow clients without the correct WEP code and those with the correct WEP code to join the network as long as all SSID codes match.
12. Select 802.11 128bit WEP encryption (3<Enter>) and set to “True” if the wireless cards will be using 128bit WEP encryption. If using 40bit WEP encryption, leave at “False”.
13. Load the WEP Key values in sections 4-12. Review all your changes on the screen are correct and select Return to previous menu (X<Enter>) to return to the Access Point Configuration Menu.

14. If all configurations appear correct, press Load Values and Return to Main Menu (M<Enter>).
15. Once at the Main Menu, press Save and Apply Changes (7<Enter>) and Yes to reboot the ESTeem.

### Client Bridge

To configure the ESTeem Model 192E as a Client Bridge, please use the following:

1. From the Configuration Main Menu, select Setup (1<Enter>).
2. Select Modes of Operation (1<Enter>) to enter the system configuration menu (Figure 4).
3. Select Client Bridge (3<Enter>) to open the Client Bridge configuration menu (Figure 9).
4. Select Current SSID (1<Enter>) and type in the SSID information that matches the Master Bridge.  
*Note: The SSID is the unique identification for your wireless network. All ESTeem Model 192Es in the bridge network MUST have the same SSID code. This identification code is case sensitive and must NOT contain spaces.*
5. Two unique IP addresses are required for the ESTeem Model 192E in bridging mode. Both the WLAN port and the 10BaseT port need a unique IP number. Select Current Wireless IP Address (2<Enter>) to assign the ESTeem an IP address.
6. Select Current Wireless IP Net Mask (3<Enter>) to change the ESTeem Net Mask.
7. Select Current Ethernet IP Address (4<Enter>) to assign the ESTeem an IP address.  
*Note: The Ethernet IP and the Wireless IP addresses must NOT be the same.*
8. Select Current Ethernet IP Net Mask (5<Enter>) to change the ESTeem Net Mask.

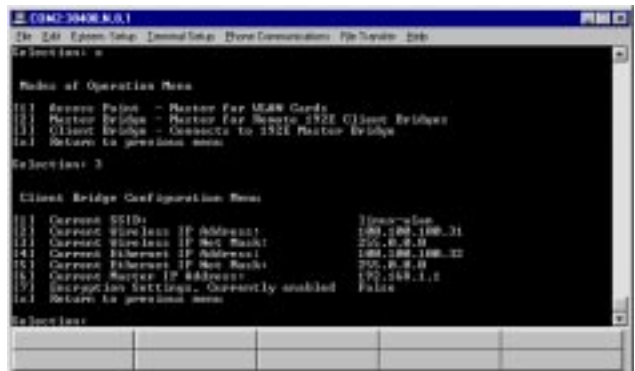

**Figure 9: Client Bridge Configuration**

# CHAPTER 2

## APPLICATION PROGRAMMING

9. Select Current Master IP Address (6<Enter>) to input the Wireless IP address of the Master Bridge.  
*Note: The Master IP address must match the **Wireless IP address** of the Master Bridge for the bridging mode to function correctly.*
10. If the bridge network is going to be using WEP security codes, press Encryption Settings (7<Enter>) to enter the Privacy Menu (Figure 5) otherwise leave the setting at “False” and skip to Step 15.  
*Note: Setting the WEP security codes are highly recommended for network privacy. They do require extensive network administration, but if used correctly they can provide the same level of security as a wired network.*
11. If WEP security is going to be used in the bridge network, select Encryption Enabled (1<Enter>) and value will change to “True”.
12. If you wish to keep clients without the correct WEP code from entering your bridge network, set Exclude unencrypted clients (2<Enter>) to “True” otherwise set to “False”. If this value is set to “False”, the Access Point will allow clients without the correct WEP code and those with the correct WEP code to join the network as long as all SSID codes match.
13. Select 802.11 128bit WEP encryption (3<Enter>) and set to “True” if the wireless cards will be using 128bit WEP encryption. If using 40bit WEP encryption, leave at “False”.
14. Load the WEP Key values in sections 4-12. Review all your changes on the screen are correct and select Return to previous menu (X<Enter>) to return to the Access Point Configuration Menu.
15. If all configurations appear correct, press Load Values and Return to Main Menu (M<Enter>).
16. Once at the Main Menu, press Save and Apply Changes (7<Enter>) and Yes to reboot the ESTeem.

### Repeater Configuration in Bridging Mode

To add a repeater site to a bridging mode system can be accomplished simply configuring the repeater location as a Master Bridge and all other locations as Client Bridges (Figure 10). Follow the steps for configuring the Master and Client Bridges above to complete the ESTeem Model 192E programming.

### Combined Access Point and Ethernet Bridging Configuration

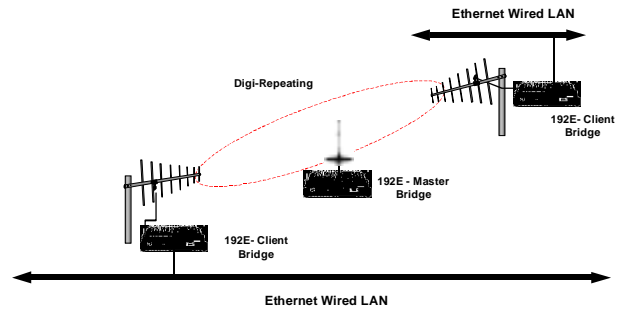

Figure 10: Repeater Configuration

As the name would imply, this type of network is a combination of an Access Point network and an Ethernet Bridging network. This type of network would provide both communication to a Building LAN network from a remote Model 192E and also provide wireless access to the network for the wireless cards. This type of network requires two ESTeem Model 192E modems and at least a three port Ethernet HUB. Figure 11 shows a combined network. Follow the steps for configuring the Access Point, Master and Client Bridges in this chapter to complete the ESTeem Model 192E programming.

### LOADING FACTORY DEFAULT VALUES

To return the ESTeem Model 192E to the factory default

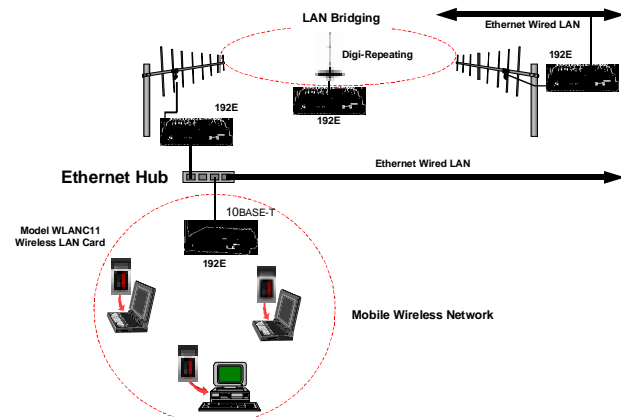

Figure 11: Combined System Diagram

values, login to the Configuration Menu (Figure 1) and select Load Factory Defaults (6<Enter>). A message that the factory default settings were restored will appear and the Configuration Menu will reload. To keep these factory default values, select Save and Apply Changes (7<Enter>) and then Yes to reboot the ESTeem.

# CHAPTER 3

## INTERFACING

---

**SERIAL INTERFACE CONFIGURATION**

**RS-232 PORT PINOUT TABLE**

**ETHERNET INTERFACE**

# CHAPTER 3

## INTERFACING

### SERIAL INTERFACE CONFIGURATION

The ESTeem Model 192E has a standard RS-232C, 9-pin Female connector for interfacing directly with the serial port on the computer. Use ESTeem part number AA062 to interface the Model 192E with a 9-pin serial port on a computer.

The serial port on the ESTeem Model 192E can be used to access the configuration menu in the ESTeem for system and network configuration. The ESTeem communications port operates at 19,200 bps, No Parity, 8 Data Bits and 1 Stop Bit (19,200,N,8,1). Configure your terminal program to match these settings.

### RS-232 PORT PIN-OUT TABLE

**ESTeem Model 192E**  
**RS-232C Port Pin-Out Table**

Pin No.	Function
1	Data Carrier Detect (DCD)
2	Receive Data (RxD)
3	Transmit Data (TxD)
4	Data Terminal Ready (DTR)
5	Signal Ground
6	Data Set Ready (DSR)
7	Request To Send (RTS Input)
8	Clear To Send (CTS)
9	Ring Line (RI)

### ETHERNET INTERFACE

The ESTeem Model 192E's Ethernet Port is configured to directly interface with an Ethernet HUB using a straight through 10BaseT cable. If the ESTeem is connected to a network interface card (NIC), you will need to use 10BaseT reversing cable.



# **CHAPTER 4**

## **ANTENNAS**

---

**ANTENNA AND CABLE CONFIGURATIONS**

**WEATHER PROOFING COAXIAL CONNECTORS**

**GROUNDING**

**LIGHTNING ARRESTORS**

**MODEL 192E TYPICAL OUTDOOR ANTENNA  
INSTALLATION DIAGRAM**

**MODEL 192E TYPICAL INDOOR ANTENNA INSTALLATION  
DIAGRAMS**

**ESTEEM SWR MEASUREMENT BLOCK DIAGRAM**

# CHAPTER 4

## ANTENNAS

### ANTENNA AND CABLE CONFIGURATIONS

**Warning:** Only the tested cable lengths and antennas provided by EST meet the FCC maximum peak output power requirements. Any other combination of antennas or coax cables is not authorized.

EST offers three (3) different types of antennas for both indoor and outdoor configurations.

#### Part Number: AA01S

Omni Directional Rubber Duck Antenna.  
Unity Gain  
Directly mounts to antenna port

#### Part Number: AA20S

Omni Directional Building Mount Antenna  
5 dBd gain  
Uses either 25' RG-8 Cable (Indoor) or  
50' Heliac Cable (Outdoor)

#### Part Number: AA202S

Directional Building Mount Antenna  
13.9 dBd gain  
50' Heliac Cable (Outdoor) with Lightning Arrestor  
(EST P/N: AA164) and RG-8 Patch Cable

#### Outdoor Fixed Base Configuration

AA20S or AA202S Antenna  
Lightning Protection  
50' Heliac Cable

#### Indoor Configuration

AA20S or AA202S Antenna  
25' RG-8 Cable

**Warning:** Only pre-made coax cables from the factory used in conjunction with either the AA20S omni-directional or AA202S directional antenna meet all FCC Section 15.247(b) EIRP maximum power requirements.

### COAXIAL CABLES

The 25' length of RG-8 coax cable and the 50' length of Heliac cable are the minimum cable lengths allowed for use the above antennas. Listed below are representative cable losses in db/100 ft at the 2.4 GHz frequency range:

Frequency (MHz)	RG-8	½" Heliac
2400-2462	- 10.0	- 3.74

In a severe noise environment it may be necessary to use a double shield type of coax cable such as RG-214/U in place of the RG-8. This cable must be purchased from the factory to meet FCC requirements.

**Note:** A -3 dB loss means you have lost 1/2 of your signal. A +3 dB gain means you have doubled (x2) your signal.

### WEATHER PROOFING COAX CONNECTIONS

1. Coat the threads of the connectors with silicone lubricant prior to assembly (See Note 1) and hand tighten. Care should be taken not to get any lubricant on the center conductor.
2. Wrap the connector assembly with a vapor barrier patch for weather proofing (See Note 2), ensuring to overlap onto the coax cable approximately 1 1/2 inches.
3. Apply an electrical coating (sealing agent) over the vapor barrier patch for added protection (See Note 3).

#### Notes:

1. Dow Corning RTV-3140 or equivalent.

2. Suggested vendors:

VAPOR-WRAP  
Decibel Products  
3184 Quebec St.  
Dallas, TX 75356  
214-631-0310

VYNIL-MASTIC, P/N 2200  
3-M Company  
Customer Service  
512-984-1800

3. SCOTCHKOTE, 3-M Company, or equivalent.

# CHAPTER 4

## ANTENNAS

---

### GROUNDING

All building mount antennas require attachment to a good earth ground for optimum efficiency. Contact a reputable local communications shop for procedures for your area.

### LIGHTNING ARRESTORS

Lightning arrestors should be used on all external building mount antennas for personal protection and to minimize damage to the transceiver during lightning storms. The units should be installed as per manufacturers instructions provided with the device.

# CHAPTER 4 ANTENNAS

## Model 192E Outdoor Fixed Base Site Diagram

### ANTENNA CONFIGURATIONS

#### Omni-Directional Antenna

EST P/N AA20S.

#### Caution

To comply with the FCC exposure compliance requirements, a separation distance of at least 7 cm must be maintained between the antenna and all persons.

#### Directional Antenna

EST P/N AA202S.



#### Caution

To comply with the FCC exposure compliance requirements, a separation distance of at least 19 cm must be maintained between the antenna and all persons..



TNC-R  
Male Connector

#### Heliax Feedline

50 ft.

#### RG-8 Coax

2 ft.

TNC-R  
Male  
Connector

#### LIGHTNING ARRESTOR

TNC-R  
Male  
Connector

TNC-R  
Male Connector

### NOTES

1. Vapor wrap all external antenna coax connections with vinyl wrap (EST Part No. AA241) and apply Scotchkote Electrical Coating (EST Part No. AA242).
2. Contact EST for recommendations regarding antenna mounting hardware and installation tips.
3. Ground antenna structure, base and lightning arrester.

#### RS-232 Interface Connector

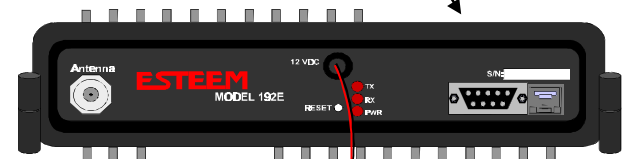

2 Pin Molex Connector

RJ-45 Ethernet Connector

### 12 VDC POWER SUPPLY RECOMMENDATIONS

EST P/N AA174  
Battery Packs  
Solar Power

# CHAPTER 4 ANTENNAS

## Model 192E Indoor Equipment Diagram

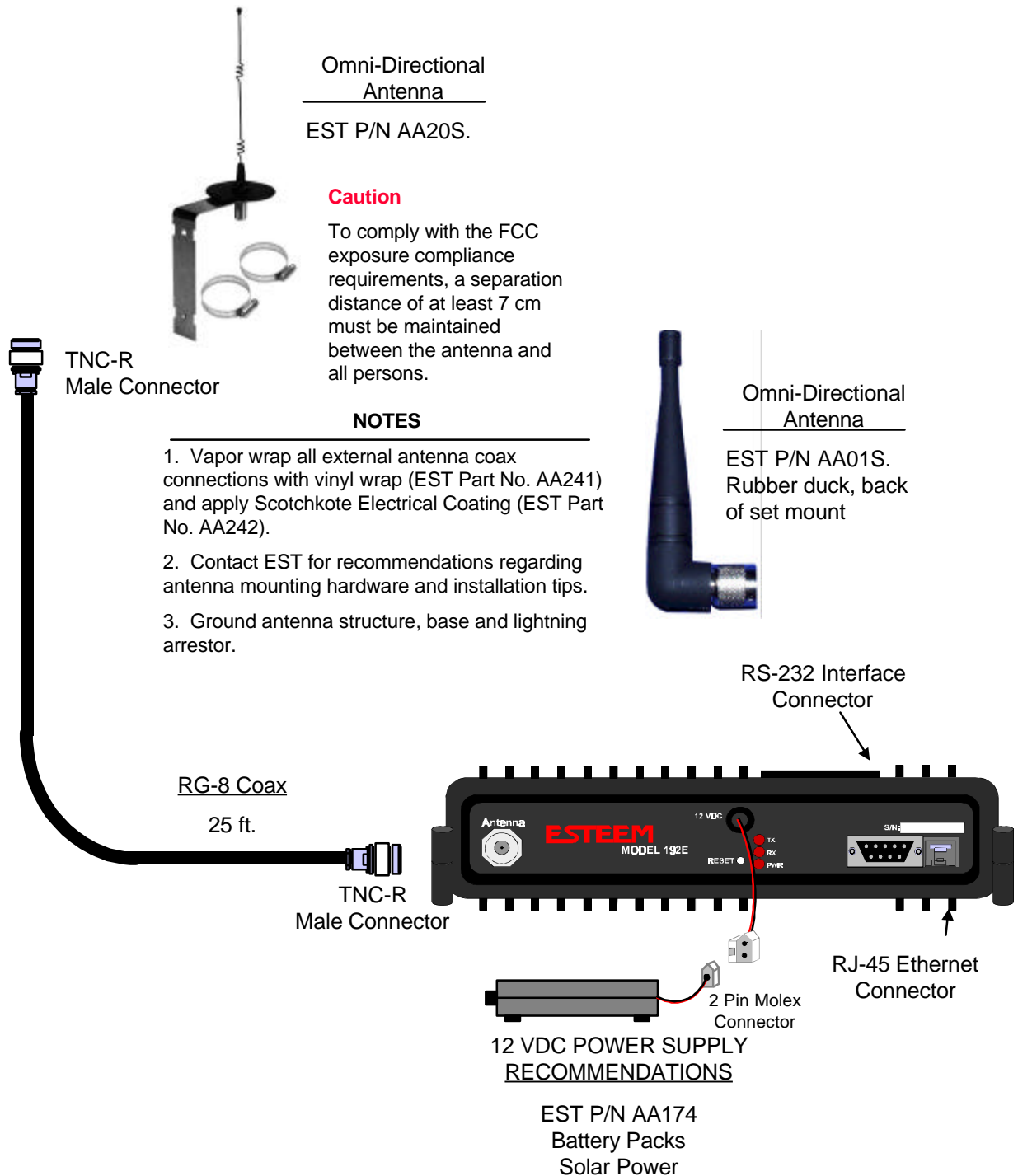

# CHAPTER 4 ANTENNAS

## ESTeem SWR Measurement Block Diagram

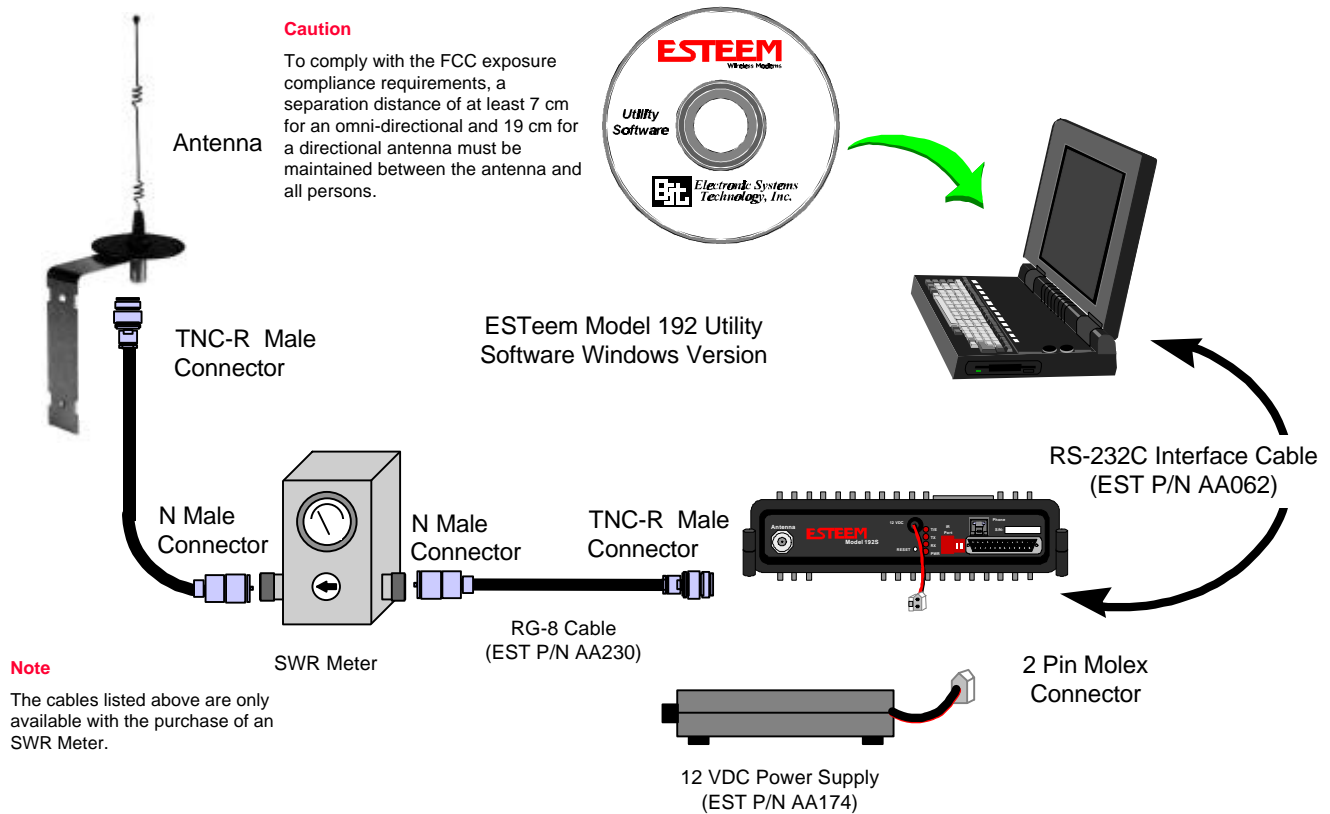

### Programming the ESTeem Model 192E For SWR Measurements

1. Configure the hardware as per the above diagram.
2. Install the ESTeem Utility on the PC hard drive as per instructions with the software.
3. From Utility Main Menu (Figure 1) select the Terminal Emulation Mode.
4. In the Terminal Emulation Mode press the Enter key to display the Model 192E configuration menu.
5. Select the Turn Transmitter ON option.
6. When the testing is completed, select Turn Transmitter OFF option on the configuration menu.



Figure 1: ESTeem Utility Main Menu

# APPENDICES

---

**APPENDIX “A” FCC INFORMATION (USA Only)**

**APPENDIX “B” SPECIFICATIONS**

**ESTeem Specifications**

**Antenna Specifications**

# APPENDIX A

## FCC LICENSING

---

### INFORMATION TO USERS

The ESTeem Model 192E complies with Part 15 of the FCC Rules. Operation is subject to the following two conditions: (1) This device may not cause harmful interference, and (2) this device must accept any interference received, including interference that may cause undesired operation.

**Note to User:**

*Changes or modifications to this equipment not expressly approved by Electronic Systems Technology for compliance could void the user's authority to operate the equipment.*

### Other Information

**Model 192E**

Direct Sequence  
FCC Type Acceptance No: ENPESTEEM192E



# APPENDIX A

## FCC LICENSING

---

### FEDERAL COMMUNICATIONS COMMISSION FIELD OFFICES

#### ALASKA

1011 E. Tudor Rd.  
Rm 240 Box 2955  
Anchorage, AK 99510

#### CALIFORNIA

7840 El Cajon Blvd  
Suite 405  
La Mesa, CA 92041

3711 Long Beach Blvd  
Suite 501  
Long Beach, CA 90807

323A Battery St  
San Francisco, CA 94111

#### COLORADO

Executive Tower  
1405 Curtis St  
Suite 2925  
Denver, CO 80202

#### FLORIDA

919 Federal Bldg  
51 SE First Ave.  
Miami, FL 33130

1211 N. Westshore  
Suite 601  
A.D. P. Building  
Tampa, FL 33607

#### GEORGIA

Massell Bldg. 440  
1365 Peachtree NE  
Atlanta, GA 30309

#### HAWAII

7304 Prince Kuhi  
Federal Building  
Honolulu, HI

#### HAWAII

300 Almoana Blvd.  
P.O. Box 50023  
Honolulu, HI

#### ILLINOIS

3935 Federal Bldg  
230 S. Dearborn  
Chicago, IL 60604

#### LOUISIANA

1009 Edw Hebert Bldg.  
600 South Street  
New Orleans, LA 70130

#### MARYLAND

1017 Geo. Fallon  
Building 31  
Hopkins Plaza  
Baltimore, MD

#### MASSACHUSETTS

1600 Customhouse  
165 State Street  
Boston, MA 02109

#### MICHIGAN

1054 Federal Building  
231 W LaFayette  
Detroit, MI 48225

#### MINNESOTA

691 Federal Building  
316 N Robert St.  
St. Paul, MN

#### MISSOURI

Brywood Office Tower  
6800 E. 63rd Street  
Kansas City, MO

#### NEW YORK

1307 Federal Building  
111 W. Huron  
Buffalo, NY 14202

201 Varick Street  
New York, NY 10014

#### OREGON

1782 Federal Building  
1220 SW 3rd Avenue  
Portland, OR 97204

#### PENNSYLVANIA

Room 404  
2300 E. Lincoln H  
Langhorne, PA

#### PUERTO RICO

747 Federal Building  
Carlo Chardon Ave.  
Hato Rey, PR 00918

#### TEXAS

Cabeli Building  
1100 Commerce  
Dallas, TX 75242

5636 Federal Building  
515 Rusk Avenue  
Houston, TX 77002

#### VIRGINIA

Military Circle  
870 N. Military Hwy.  
Norfolk, VA 23502

#### WASHINGTON

3256 Federal Building  
915 Second Avenue  
Seattle, WA 98174

# APPENDIX B SPECIFICATIONS

## Model 192E Specifications

### LED INDICATORS

- Power On
- Receiver Carrier Detect
- Transmitter Enable

### I/O – CONNECTORS

- RS-232C - 9 Pin Sub D Female
- RJ-45 10BaseT Connection
- Antenna Output – TNC-R
- Input Power - 2 Pin Molex Female

### DATA INPUT

- RS-232 Asynchronous
- 38,400 bps Fixed Data Rate
- 8 data bits
- No parity
- One Stop Bit

### FREQUENCY OF OPERATION

- 2412 to 2462 MHz.
- Frequency selectable in 11 frequency zones

### RF DATA RATE

- 1-11 Mbps RF data rate

### TRANSMITTER

- 1 Watt RF output
- 100% duty cycle
- 50 ohms output impedance
- Protocol activated keying
- 10 µsec typical latency
- Direct sequence spread spectrum

### RECEIVER

- Double conversion superheterodyne
- -93 dBm 8E-2 Frame Error Rate
- 80 dB Image Rejection
- > 35 dBm Adjacent Channel Rejection

### POWER REQUIREMENTS

- 11-16 VDC @ 700 ma Transmit  
300 ma Receive

### SIZE

- 2.45 in. Height
- 8.16 in. Width
- 9.37 in. Length

### WEIGHT:

- 4.6 lbs.
- Rugged die cast aluminum case

### ENVIRONMENT

- -30° to 50° C
- 95% Non-condensing

### WARRANTY

- 1 Year

# APPENDIX B SPECIFICATIONS

## Model 192E Antennas

<b>Model No:</b>	AA01S
<b>Antenna Type:</b>	Omni-Directional, right angle rubber duck, ½ wave
<b>Applications:</b>	Back of ESTeem Model 192S mount.
<b>Frequency:</b>	2400 to 2485 MHz
<b>Polarization:</b>	Vertical
<b>Impedance:</b>	50 ohms
<b>Gain:</b>	2 dBd
<b>VSWR:</b>	< 1.5
<b>Front To Back Ratio:</b>	n/a
<b>Horizontal Beamwidth:</b>	n/a
<b>Vertical Beamwidth:</b>	n/a
<b>Antenna Material:</b>	Rubber duct whip.
<b>Mounting Hardware:</b>	n/a
<b>Antenna Connector:</b>	TNC-R Male
<b>Antenna Envelope:</b>	4 in. length by 1.5 in width
<b>Weight:</b>	.08 lbs.

### Caution

To comply with the FCC exposure compliance requirements, a separation distance of at least 7 cm must be maintained between the antenna and all persons.



Model AA01S

<b>Model No:</b>	AA20S
<b>Antenna Type:</b>	Omni Directional, 5/8 Wave over 5/8 Wave over ¼ Wave.
<b>Applications:</b>	Fixed base or mobile mount.
<b>Frequency:</b>	2400 to 2485 MHz
<b>Polarization:</b>	Vertical
<b>Impedance:</b>	50 ohms
<b>Gain:</b>	5 dBd
<b>VSWR:</b>	< 1.5
<b>Front To Back Ratio:</b>	n/a
<b>Horizontal Beamwidth:</b>	n/a
<b>Vertical Beamwidth:</b>	n/a
<b>Antenna Material:</b>	Stainless steel whip. All other hardware anodized metal.
<b>Mounting Hardware:</b>	Stainless steel clamps for mounting to ¾ in. to 1½ in. pipe with right angle mount of direct panel mount..
<b>Antenna Connector:</b>	TCN-R Female.
<b>Antenna Envelope:</b>	9 in. length by 3.5 in. width
<b>Weight:</b>	.4 lbs.

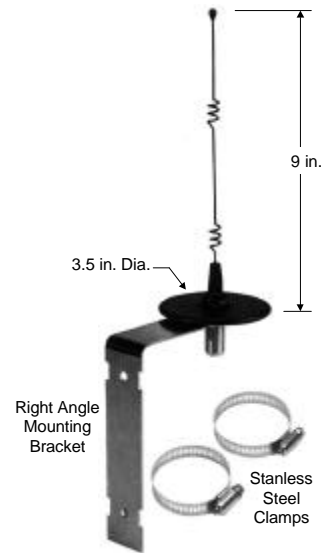

Model AA20S

# APPENDIX B

# SPECIFICATIONS

## Model 192E Antennas

<b>Model No:</b>	AA202S
<b>Antenna Type:</b>	Directional, 15 element yagi in sealed UV stable radome
<b>Applications:</b>	Fixed base.
<b>Frequency:</b>	2400 to 2500 MHz
<b>Polarization:</b>	Linear
<b>Impedance:</b>	50 ohms
<b>Gain:</b>	13.9 dBd
<b>VSWR:</b>	< 1.5
<b>Front To Back Ratio:</b>	18 dB
<b>Horizontal Beamwidth:</b>	34 degrees
<b>Vertical Beamwidth:</b>	30 degrees
<b>Antenna Material:</b>	Stainless hardware with one piece copper radiating element. Advanced microwave substrate. All other hardware anodized metal.
<b>Mounting Hardware:</b>	Stainless steel U bolts for mounting to 1.5 in. to 2.2 in. diameter pipe.
<b>Antenna Connector:</b>	TNC-R Female on Pigtail
<b>Maximum Power Input:</b>	50 Watts
<b>Antenna Envelope:</b>	26 in. length by 4.0 in. height by 1.5 in. width
<b>Windload (RWV):</b>	125 mph
<b>Wind Load ½ in. Ice:</b>	100 mph
<b>Wind Surface Area:</b>	0.4 ft <sup>2</sup>
<b>Weight:</b>	1.25 lbs.



### Caution

To comply with the FCC exposure compliance requirements, a separation distance of at least 19 cm must be maintained between the antenna and all persons.

**Model AA202S**