

ESTEEM USERS MANUAL

for

MODELS 192C/F/M

Firmware Versions 1.46 and above.

March 2001

Electronic Systems Technology (EST) copyrights this manual and the firmware described in it, with all rights reserved. Under the copyright laws, this manual or the firmware internal to the ESTeem unit may not be copied, in whole or part, without the written consent of EST. Under the law, copying includes translating into another language.

EST cannot guarantee that you will receive notice of a revision to the firmware described in the manual, even if you have returned a registration/warranty card received with the product. You should periodically check with your authorized EST dealer or call factory direct.

EST and the EST logo are registered trademarks of Electronic Systems Technology, Inc. Simultaneously published in the United States and Canada. All rights reserved.

PRODUCT WARRANTY

Electronic Systems Technology, Inc., (hereinafter EST) expressly warrants its products as free of manufacturing defects for a period of one year from the date of sale to first user/customer.

THERE ARE NO OTHER WARRANTIES, EXPRESS OR IMPLIED AND THERE IS EXPRESSLY EXCLUDED ALL WARRANTIES OF MERCHANTABILITY OR FITNESS FOR A PARTICULAR PURPOSE. NO OTHER WARRANTY GIVEN BY ANY EMPLOYEE, AGENT, DISTRIBUTOR OR OTHER PERSON WITH RESPECT TO THE PRODUCT SHALL BE BINDING ON EST.

LIMITATION OF LIABILITY:

EST's liability shall be limited to refunding of purchase price, repair or replacement of product.

IN NO EVENT SHALL EST HAVE LIABILITY FOR CONSEQUENTIAL, INCIDENTAL, SPECIAL OR EXEMPLARY DAMAGES CAUSED DIRECTLY OR INDIRECTLY BY THE PRODUCT, INCLUDING BUT NOT LIMITED TO ANY INTERRUPTION OF SERVICES, LOSS OF BUSINESS OR ANTICIPATORY PROFITS. IN NO EVENT SHALL EST BE LIABLE FOR ANY DAMAGES WHATSOEVER IN EXCESS OF THE PURCHASE PRICE OF THE PRODUCT.

In the event that a unit or part requires replacement or factory servicing, the following conditions apply:

- a) Customer must obtain from EST an authorized RMA (Return Materials Authorization) number (call 509-735-9092 Customer Support) before shipment of product or parts to EST for any reason;
- b) If the whole unit is shipped, it must be in its original carton and shipping components, or a carton and shipping components supplied by EST, or if parts only are shipped, they must be packaged and cushioned so as to prevent damage in transit and shipped freight prepaid;

PRODUCT WILL BE CONSIDERED OUT OF WARRANTY IF:

- a) If the product is damaged due to improper or abnormal use, abuse, mishandling, accident or improper maintenance or failure to follow operating instruction;
- b) If the product is defective as a result of sand, dirt, or water damage;
- c) If any factory-sealed enclosure has been opened or shows evidence of an attempt to be opened;
- d) If defects or damage are caused by the use of unauthorized parts or unauthorized service;
- e) If the product has had its serial numbers altered or removed.

Warranty repair form must be accompanied by proof of user's purchase of unit. Product must be shipped to the manufacturer at the following address:

Electronic Systems Technology
415 North Quay Street
Kennewick, Washington USA 99336

ADDITIONAL SERVICE:

If EST releases an improvement update to firmware internal to the ESTeem unit during the 90 day period after the unit was purchased by the first user/customer, EST will update the applicable unit with the revised version at no charge other than for UPS handling and shipping to and from your location to the EST factory. Return of any such item must be accompanied with proof of purchase.

TABLE OF CONTENTS

CHAPTER 1 - STARTING OUT

Before You Start.....	1-2
ESTeem Utility.....	1-2
Installing ESTeem Utility Software.....	1-2
Running The Program	1-2
Starting Out.....	1-3
Basic ESTeem Programming	1-5
Help Functions	1-5
Saving a Program	1-6
Restoring Factory Defaults.....	1-6

CHAPTER 2 - MODES OF OPERATION

Command Mode.....	2-2
Converse Mode.....	2-2
Transparent Mode	2-3
Semi-Transparent Mode	2-3
Hardware Mode Control	2-3

CHAPTER 3 - PROGRAMMING ESTEEM FEATURES

Digi-Repeating Feature.....	3-2
Global Broadcast Feature.....	3-2
Auto Transmit Feature.....	3-3
Auto Connect Feature.....	3-3
Multi-Connect Feature.....	3-3
Remote Programming Feature	3-4
Security Feature.....	3-4

Hardware Ring Line.....	3-5
Packet Monitor Feature	3-5
Using The Infrared Communications Port	3-5
Updating Flash Memory.....	3-6

CHAPTER 4 - ESTEEM APPLICATION PROGRAMS

Transparent Auto-Connect.....	4-2
Transparent Auto-Connect Global.....	4-2
Interactive Terminal Applications.....	4-3
Programmable Logic Controllers.....	4-3

CHAPTER 5 - RS-232C/422/485 INTERFACING

DTE vs DCE.....	5-2
Flow Control.....	5-2
Memory Buffers	5-3
Data Terminal Ready	5-3
RS-422/485 Configuration	5-3
RS-232/422/485 Configuration Tables	5-4
RS-232/422/485 Port Pin-out Table.....	5-4
RS-232/422/485 COMRATE Table.....	5-4

CHAPTER 6 - ANTENNAS

Coaxial Cables	6-2
Weather Proofing Coaxial Connectors.....	6-2
Grounding	6-2
Lightning Arrestors.....	6-3

TABLE OF CONTENTS

CHAPTER 6 - ANTENNAS

Reference Material	6-3
Model 192 Typical Outdoor Antenna Installation Diagram.....	6-4
Model 192 Typical Indoor & Mobile Antenna Installation Diagram.....	6-6
ESTeem SWR Measurements Block Diagram.....	6-8

CHAPTER 7 - THEORY OF OPERATION

Introduction.....	7-2
ESTeem How It Works	7-2
Spectrum Utilization.....	7-3
Packet Protocols	7-3
Flow Control	7-3
Data Privacy.....	7-3
Effective Baud Rate	7-3

APPENDICES

Appendix A - Licensing

(USA only).....	APX A-2
-----------------	---------

Appendix B - Specifications

ESTeem Specifications.....	APX B-1
Model 192 Antenna Specifications	APX B-4

Appendix C - Tables/Diagrams

ESTeem Command Error Message Table ...	APX C-1
ESTeem System Status Message Table.....	APX C-2
ESTeem System Error Message Table.....	APX C-3

Appendix D - ESTeem Software Commands

Factory Default Settings	APX D-1
Definitions.....	APX D-2

CHAPTER 1

STARTING OUT

BEFORE YOU START

ESTEEM UTILITY

Installing ESTeem Utility Software – Windows 95/98/NT

Running The Program

STARTING OUT

BASIC ESTEEM PROGRAMMING

HELP Functions

Saving A Program

Restoring Factory Defaults

CHAPTER 1 STARTING OUT

BEFORE YOU START

Congratulations on your purchase of the ESTeem Wireless Modem! This section of the manual will describe the basic functioning and programming of the ESTeem to get your wireless network up as soon as possible. It is recommended that any first time user of the ESTeem and those that are unfamiliar with its operation complete all steps in this section before proceeding.

Take a few minutes to inventory your equipment before you proceed. Report any missing or damaged items to Customer Support as soon as possible. We at Electronic Systems Technology, Inc. (EST) are constantly trying to improve our products and support system so if you have any comments or suggestions on improvement of this manual, please contact us at (509) 735-9092.

The completion of this section requires loading the ESTeem Utility program on your computer. The following section will describe the installation and use of this valuable utility program.

ESTEEM UTILITY

The ESTeem Utility is designed to assist the ESTeem user in programming and troubleshooting. The Utility covers basic operation, programming, PLC applications, and diagnostics of the ESTeem. The ESTeem Utility Program is designed to operate with Windows 95®, Windows 98® and Windows NT® 4.0 and greater.

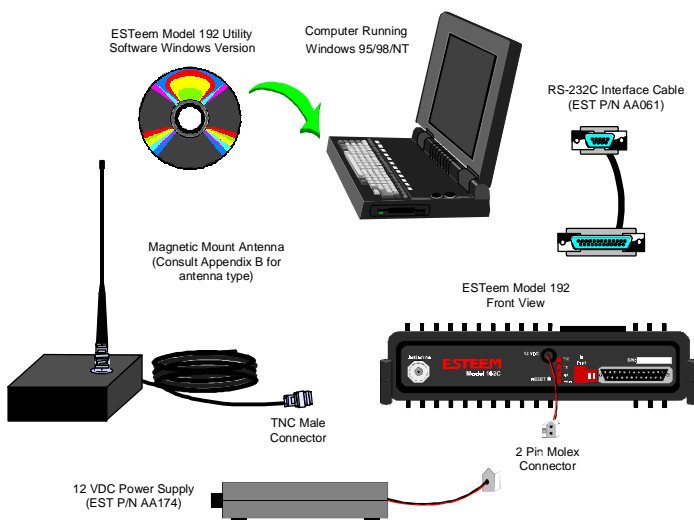

Figure 1: Installation Diagram

Installing ESTeem Utility Software

The ESTeem Utility Software is used for the setup and programming of the ESTeem.

1. Place the ESTeem Utility CD in your CD-ROM drive. The CD will auto load the ESTeem Utility Setup window (Figure 2). If the window is not displayed, proceed to step 2, otherwise proceed to step 3.
2. If you have Autorun disabled for you CD-ROM drive, Press the Start button on your Window desktop and select Run. Press the Browse button and select your CD-ROM drive from the list. Double-click on the "CDLoader.exe" icon and press the OK button. Your computer will now display the ESTeem Utility Setup window (Figure 2).
3. The ESTeem Utility Setup window will allow you to install the ESTeem Utility Program, view the on-line documentation and install the Adobe Acrobat® Reader. The Acrobat Reader is required to view the documentation. To install the ESTeem Utility program press the Install ESTeem Utility button on the menu and follow the on-screen instructions to install the program.



Figure 2: ESTeem Utility Setup Menu

Running The Program

1. Select the ESTeem Utility Icon on Start>Programs menu. Figure 3 shows an example of the Main Utility Menu.

CHAPTER 1 STARTING OUT



Figure 3: ESTEem Utility Main Menu

STARTING OUT

This section covers the basics setup and testing for the ESTEem wireless modem. If this is your first experience with the ESTEem wireless modems or you are unclear on how to set the frequency, squelch, or test communication, the [ESTEem Starting Out](#) section will guide you through the basics of wireless communication.

1. Select [ESTEem Starting Out](#) from the main menu. A window like the one in Figure 4 will be displayed. If this is your first time using the ESTEem wireless modems, select [ESTEem Setup Guide](#) for a complete description of all ESTEem functions. Proceed to step 2.

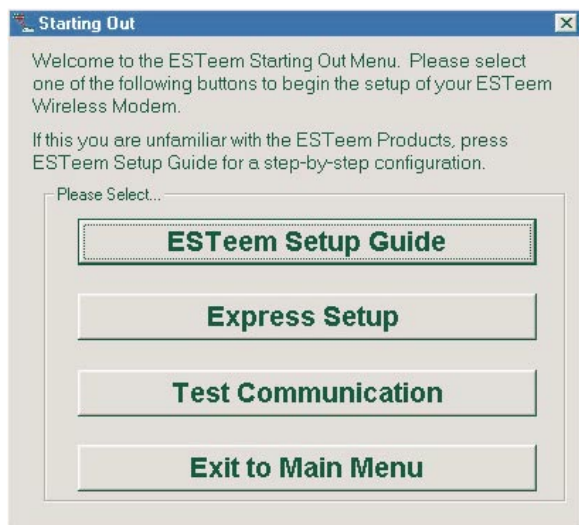

Figure 4: Starting Out Main Menu

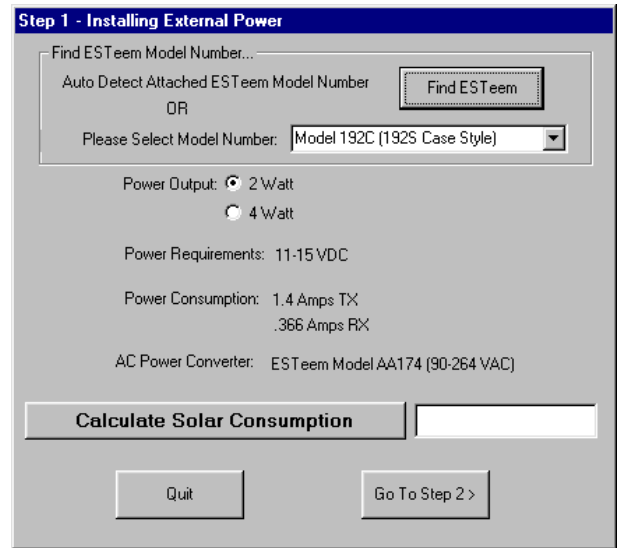

Figure 5: Step 1 - Installing External Power

2. [Step 1 – Installing External Power](#) window will be displayed (Figure 5). Select either [Find ESTEem](#) or the model number of ESTEem you are programming. The power requirements for that product will be displayed. The ESTEem model AA174 power supply can be used with all ESTEem products. If you are using the ESTEem in a solar power application, press [Calculate Solar Consumption](#) button for the Amp/Hours required. Press [Go to Step 2](#) to continue.
3. [Step 2 – ESTEem Familiarization](#) window will be displayed (Figure 6). This step will explain the connections to ESTEem Model 192 front panel. See Figure 1 for a setup diagram.

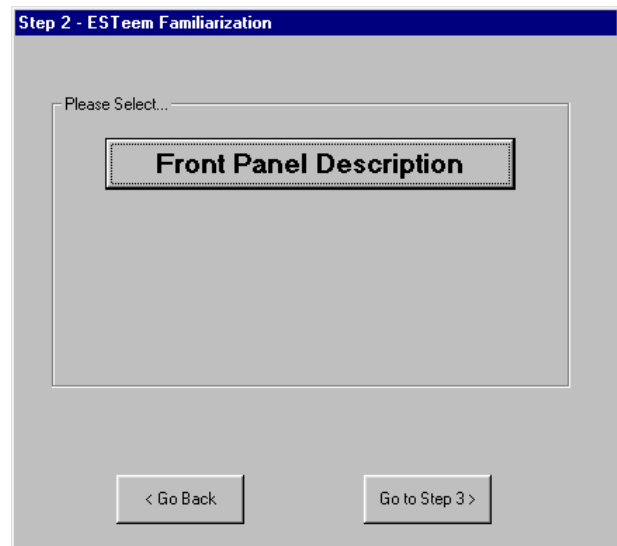

Figure 6: Step 2 – ESTEem Familiarization

CHAPTER 1 STARTING OUT

- Press the Front Panel Description button and a window containing the ESTeem Model 192 front panel will appear (Figure 7). Press any one of the buttons for a complete description of the item's function. For example, press the Power LED button and the description of the power LED and its use will be displayed. Press Go To Step 3 button to proceed.

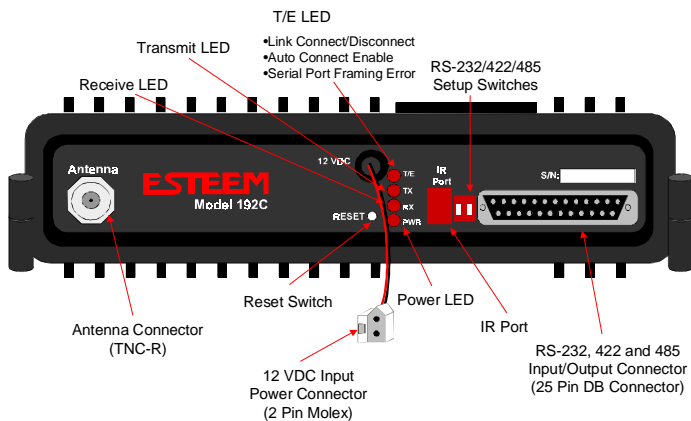

Figure 7: ESTeem Front Panel

- Step 3 – Serial Connection window will be displayed (Figure 8). This step will help configure the computer and the ESTeem to communicate with each other.
- Press Display Cable Diagrams button and all serial pins to the ESTeem Model 192 will be displayed. Press OK to continue.

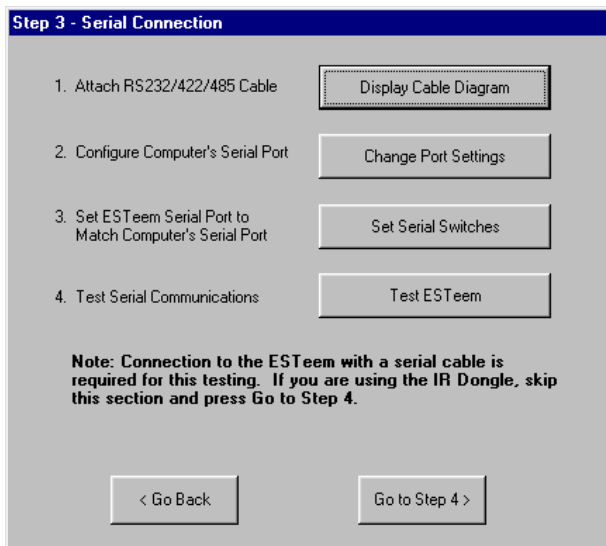

Figure 8: Step 3 – Serial Connection

Note: A standard 9-Pin serial port on a computer to ESTeem interface cable is the ESTeem AA061 (Figure 1).

- Press Change Port Settings. This window will configure the communications port on your computer to operate with the ESTeem modem. Select the operating parameters you wish or set to the default of 19,200,N,8,1. Click OK to continue.
- Press Set Serial Switches button. This window will configure the ESTeem's RS-232/422/485 to operate at the setting selected in step 7 to match the computer port setting. Follow the on-line guide to configure the data rate.
- Press Test ESTeem button. If the ESTeem serial interface cable and communication port are operating correctly the ESTeem Welcome Message will be displayed. This will confirm communication between the computer and the ESTeem. If you do not receive a welcome message, follow the on-screen troubleshooting guide that will be displayed. Press Go to Step 4 button to proceed.
- Step 4 – ESTeem Setup Parameters window will be displayed (Figure 9). This step will complete the setup for your ESTeem Model 192.
- Press Set Address button. You must give each ESTeem a unique address in the system. Type in the address number and press OK to continue.
- Press Set Squelch/Antenna button. This section will give you instructions on antenna placement and installation. Press the Set Squelch button and follow

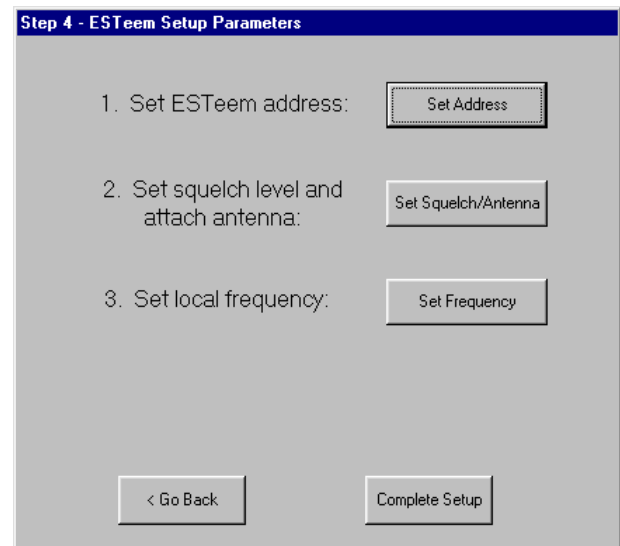

Figure 9: Step 4 – ESTeem Setup Parameters

CHAPTER 1

STARTING OUT

the on-line guide to configure the ESTeem squelch. Press OK to continue.

13. Press Set Frequency button. Select the operating frequency for your ESTeem Model 192 and press Set Frequency to continue. Set all ESTeems to the same frequency for operation within this section.
14. Press Complete Setup. You have just configured all operating parameters within the ESTeem. If this is your first ESTeem you have programmed for testing, press the Express Setup button on the Starting Out Menu (Figure 4) to program subsequent ESTeem Modems. The Express Setup will allow you to quickly configure the remaining ESTeem modems without additional instruction. If you have at least two ESTeems programmed and wish to test communication, proceed to step 17.
15. Press Test Communication button. This section will allow you to test the radio frequency (RF) communications between two or more ESTeems. Two types of tests are listed in this window (Figure 10). If you have a computer attached to both ESTeems proceed to step 18 and if you only have one computer to test both ESTeems proceed to step 19.

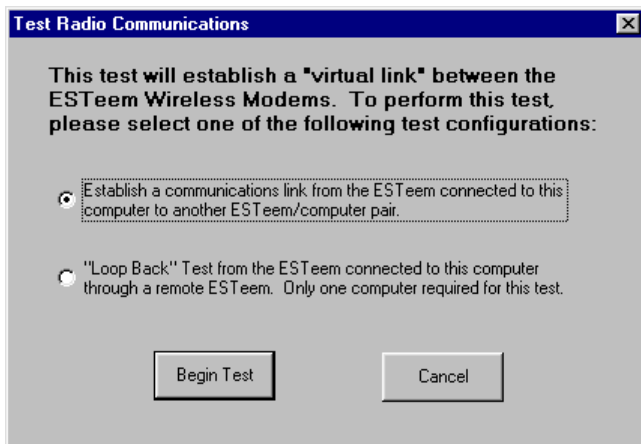

Figure 10: Test Radio Communication

16. The first test will be used if you have a computer attached to both ESTeems. Select the first of two items and press ENTER. Follow the instructions on the screen to establish a communication link between modems.
17. This second test will allow you to use the remote ESTeem as a digi-repeater for your local modem. This procedure is explained in the window and can test communication with only one computer.

18. You now have completed the basic programming and setup of your ESTeem modems. You have tested their operation with each other and are now ready to proceed in programming them for your application. Press Exit to Main Menu and continue with the programming of the ESTeem for your application.

BASIC ESTEEM PROGRAMMING

Most of the ESTeem commands outlined in this section have been automatically input to the modem by the ESTeem Utility program. A few of the commands used most often in troubleshooting and programming are covered here. These commands can be programmed to the modem directly by the Terminal Emulation section of the utility or by any other terminal software package.

HELP Functions

The ESTeem has over eighty software commands to aid the user in their application. The HELP command allow the user to list the various software commands and their respective values.

From the COMMAND mode, type HELP<cr>. Your display should list the following:

Help switches are:

ALL (Lists all settings).
CHANGE (List settings changed from factory default).
CONTROL (List settings dealing with control).
PLC (List settings for PLCs).
RADIO (List settings for ESTeem radio).
RS232 (List settings for RS-232/422/485).
SETUP (List settings for control).
SYSTEM (List settings for system).

These are the different software categories.

Example: HELP SETUP<cr>, will list all the programmable variables and their settings for the SETUP category.

You can interrogate a discrete software command by just typing the command followed by a <cr>.

Example: ADD<cr>, will list the current address saved in the connected ESTeem.

CHAPTER 1

STARTING OUT

Note *Appendix E of this manual will have the complete listing of software commands and categories for the factory default of the ESTeem.*

Saving A Program

A program is saved by typing in the SAVE command at the CMD: prompt. The programming variables that have been changed will be written to the non-volatile memory. The programming parameters will be loaded each time the modem is powered up or reset.

Restoring Factory Defaults

The ESTeem has a very simple procedure to restore the program variables in the unit to the factory default setting. When the FA<cr> command is entered from the command mode the ESTeem will be configured from a variable table located in its EPROM. It is a good practice to restore the ESTeem to a factory defaults before any programming of the unit.

To ensure the modem is in the COMMAND MODE set it back to the factory default by performing the following:

1. Set both switches (#1&2) on the RS-232 setup switches to the OFF position.
2. Reset the ESTeem.
3. Verify the computer's Comm port is configured for 19,200,N,8,1.
4. Type FA<cr> and the ESTeem welcome message should be displayed. The characters may not be echoed on the screen.
5. Type SA<cr> to save the factory default table.

CHAPTER 2

MODES OF OPERATION

COMMAND MODE

CONVERSE MODE

TRANSPARENT MODE

SEMI-TRANSPARENT MODE

HARDWARE MODE CONTROL

CHAPTER 2

MODES OF OPERATION

The ESTeem has three major modes of operation, Command, Converse, and Transparent. This chapter of the manual describes each one of these modes.

COMMAND MODE

The COMMAND Mode (CMD: prompt) is the default mode that the ESTeem initially enters on power-up or after a hardware or software reset. From this mode the user can command or program the ESTeem. In this mode the user may access the various program commands to configure the ESTeem for the specific application. These values can be stored in nonvolatile memory within the ESTeem by the use of the SAVE command. The ESTeem reads these setup parameters stored in memory on power-up or RESET.

When programming in the COMMAND Mode, the user need only enter enough characters to uniquely identify the respective command.

Example: CMD:ADD 15 <Enter>

This enters the source address of the ESTeem to the decimal value of 15. The first three letters ADD were enough for the ESTeem to uniquely identify the command for ADDRESS. The number of characters that need to be typed varies depending upon the command being entered. In some cases, four or even more letters may have to be entered in order for the identification to be uniquely determined. Up to ten multiple commands can be written on the same line if separated by a colon.

Example: CMD:ADD 15:SETC 2:SAVE <Enter>

CONVERSE MODE

This mode allows bi-directional communication from the input/output device attached to the ESTeem to a destination ESTeem and its respective input/output device. The ESTeem will automatically switch to the CONVERSE Mode after the initial CONNECT has been made.

When the ESTeem is in the CONVERSE Mode the * prompt will be displayed. The ESTeem will remain in the CONVERSE Mode until the radio link has been broken or by typing a control character defined by the user with the COMMAND variable.

The factory default for the COMMAND variable is CTRL C. You can return to the CONVERSE Mode from the COMMAND Mode by typing CONV <Enter>.

When you are in the CONVERSE Mode the echoing of the character comes from the ESTeem if ECHO = ON (factory default) has been programmed in the ESTeem.

Transmitting Data

The ESTeem will transmit data from the CONVERSE Mode if one or more of the following conditions have been met.

1. The ESTeem transmit buffer has been filled. The size of the transmit buffer is defined in the ESTeem by the PACKLEN variable. This variable is programmable from 1 to 2000 bytes. Factory default is 2000.
2. The ESTeem receives a SENDPAC (send packet) character from the RS-232C input data stream. The SENDPAC variable can be defined from 0 to 255 by the user. Factory default is 13 (carriage return). The SENDPAC character is also transmitted by the ESTeem. In file dump applications the SENDPAC character can be programmed to be the EOF (end of file) character transmitted from the sending device (i.e.; CTRL Z, CTRL G, etc.).
3. Termination control timer. The termination control timer is enabled by the TERMC (on/off) command. When enabled, the termination timer starts from the time the last transmit buffer has been updated in the RS-232C port. If the termination timer expires before another character is received or transmitted, the contents of the ESTeem transmit buffer will be transmitted. The waiting time of the timer is defined by the TERMT variable (termination time). The programming range of the TERMT variable is 10-65,535ms. Factory default values are TERMC = OFF and TERMT = 50. It is noted that when the termination timer is used, the SENDPAC variable is usually programmed to be a character that is non occurring in your data stream (i.e.; SENDPAC = 255) so that premature transmission does not occur.

CHAPTER 2

MODES OF OPERATION

TRANSPARENT MODE

The TRANSPARENT Mode allows the ESTeem to pass all data characters (0-255 or 0-FF hex) using 8 data bits.

To program the ESTeem in the TRANSPARENT mode the TRANSPARENT command must be enabled and switch Bit 2 to ON (RS-232C Setup Switch). The TRANSPARENT command will defeat the SENDPAC and COMMAND variables and put the ESTeem in the transparent mode when Bit 2 is ON.

The transmission of the data packets can only be accomplished by enabling the termination control commands (TERMC and TERMT) or the PACKLEN buffer being filled. The value of TERMT should be slightly longer than the maximum delay encountered during RS-232C transmission. If this time is set to short, the ESTeem will truncate your data stream improperly.

When using the TRANSPARENT Mode, data flow control is by hardware handshaking only. Hardware handshaking is initiated by enabling hardware flow control (XHF = ON).

The SETCON (Set Connect command) must be used to define the node that you want to communicate with while in the TRANSPARENT Mode. When the TRANSPARENT Mode is enabled you can not communicate to the ESTeem in the COMMAND Mode unless you use the Hardware Mode Control line (see explanation this chapter).

To remove the ESTeem from the TRANSPARENT Mode the user must perform the following:

1. Switch Bit 2, Off on the RS-232C Setup Switch.
2. Reset the ESTeem from the front panel switch.
3. Type TRANS OFF <Enter>.

SEMI-TRANSPARENT MODE

This mode should be utilized when sending a non-ASCII file and there is a possibility that the SENDPAC character could be contained in the transmitted data set. Perform the following prior to programming the ESTeem to initialize the unit to factory default settings:

1. Turn Bit 2, OFF on the RS-232C Setup Switch.
2. Reset the ESTeem.
3. TYPE FA <Enter>. Please note the characters may or may not be echoed by the CRT.

```
ESTeem
-----
ADD      xxx      xxx = your address
SETC     yyy      yyy = destination address
TERMC    ON
TERMT    10
SENDP    255
EDIT     OFF
XSF      ON
SAVE
```

If EDIT is off, and SENDPAC = 255, the SENDPAC character is disabled. This character when received will not cause packet transmission and will be passed as normal data. The TERMC and TERMT commands are used to transmit the contents of the ESTeem transmit buffer.

Software flow control in this example is enabled (factory default XSF = OFF) therefore the ESTeem will pass all characters except the data flow control characters for Xon/Xoff.

HARDWARE MODE CONTROL

The MODECON (Mode Control) command is provided in the ESTeem to change the mode of the ESTeem modem from COMMAND Mode to CONVERSE (or TRANSPARENT Mode) via a hardware control line. The hardware line is located on pin 19 of the RS-232C connector. If MODEC = HARDWARE, a "low or 0" on pin 19 (-3 to -15 vdc) will put the ESTeem in the COMMAND Mode and a "high or one" on pin 19 (+3 to +15 vdc) will put the ESTeem in the CONVERSE or TRANSPARENT Mode. The factory default is SOFTWARE.

CHAPTER 3

PROGRAMMING ESTEEM FEATURES

DIGI-REPEATING FEATURE

GLOBAL BROADCAST FEATURE

AUTO TRANSMIT FEATURE

AUTO CONNECT FEATURE

MULTI-CONNECT FEATURE

REMOTE PROGRAMMING FEATURE

SECURITY FEATURE

HARDWARE RING LINE FEATURE

PACKET MONITOR FEATURE

USING THE INFRARED COMMUNICATIONS PORT

UPDATING FLASH MEMORY

CHAPTER 3

PROGRAMMING ESTEEM FEATURES

Listed in this chapter are the major ESTEem features and programming examples on how to use them. These features are individual building blocks to solve your application needs. Remember your particular application may require one or more of these features enabled.

DIGI-REPEATING

The Repeater feature allows an ESTEem to relay it's respective transmission or packet through a maximum of three ESTEems to increase the operating range of the unit. Any ESTEem in your radio network can function as a repeater for any other ESTEem. This is independent of the fact that the ESTEem being used as a repeater is linked or connected to another node, therefore an ESTEem can function as a repeater, operational node, or both at the same time. The data that is digi-repeated through an ESTEem will not be output through the repeating ESTEem's RS-232C port.

To specify one or more ESTEems as repeaters, the CONNECT command has been expanded to except up to three added addresses as follows:

```
CONN r1,r2,r3,da
```

r1 = Address (1 to 254) of first ESTEem repeater.
r2 = Address (1 to 254) of second ESTEem repeater.
r3 = Address (1 to 254) of third ESTEem repeater.
Da = Address (1 to 255) of destination ESTEem.

Note: *Address 255 is used for Global.*

When transmitting packets through other ESTEems, the source ESTEem will automatically adjust it's FRACK time to allow additional time for the packet to reach its destination and for the returned acknowledgment. Frack time takes into account the packet size and the number of repeaters specified. The ACK still comes from the destination ESTEem, not the first or any repeater.

For testing purposes, you can loop back a connection to yourself by placing your source address in the destination address of the repeater string. Any data transmitted will repeat through the repeater address and display back on the screen.

Example:

```
CONN r1,Sa
```

r1 = Address (1 to 254) of first ESTEem repeater.
Sa = Address of local ESTEem.

Any ESTEem command in this manual that uses an address string can be configured to use the Digi-repeating feature.

Example:

```
SETC r1,r2,r3,da
```

GLOBAL BROADCAST

Global broadcast is the ability of one ESTEem to transmit it's message to more than one ESTEem at one time. All ESTEems within radio range will receive the message whether or not they are connected to another ESTEem or in command or converse mode.

You can put your ESTEem in Global by connecting or programming the SETC to address 255. Address 255 is a non assignable unit address and is used by the ESTEem CPU to access this special mode. When an ESTEem is in Global, the standard ACK protocol from the receiving ESTEem is disabled, but the 32 bit CRC error checking on the received ESTEem is still operational. When you perform CONN 255 <Enter> from the COMMAND MODE the ESTEem will immediately go to the CONVERSE MODE (* is displayed). All messages sent will be transmitted globally to all ESTEems in radio range.

In the ESTEem you have a GLOBAL (on/off) command. When GLOBAL = On, you can receive Global transmissions. If GLOBAL = Off you will not display Global transmissions from other ESTEems.

Note: *Factory default is ON.*

By using the repeater function you can transmit Global messages from another ESTEem using the Digi-repeating feature.

CHAPTER 3

PROGRAMMING ESTEEM FEATURES

Example:

CONN 10,20,30,255<Enter>

SETC 10,20,30,255<Enter>

By adjusting these commands you can route from unit 10 to 20, 20 to 30, and go Global at unit 30.

You can enable global transmissions in more than one ESTeem in your network. This will allow global communications between all ESTeems within radio range.

AUTO TRANSMIT

The Auto Transmit feature of the ESTeem allows the user to transmit a data packet without filling up the PACKLEN (packet length) buffer or defining a special control character using the SENDPAC (send packet) variable. The Auto Transmit feature is a timer that is enabled in the ESTeem that monitors traffic in and out of the RS-232C port. If there are characters in the RS-232C buffer, the termination control timer starts from the time the last receive or transmitted character is updated in the buffer. If the termination time expires before another character is received or transmitted, the received characters are transmitted.

To enable this feature perform the following from the COMMAND MODE:

TERMC (on/off) = On. Enable termination control.

TERMT (10-65535) = One unit number equals 1ms.

TERMC is the termination control command. TERMT is the termination time command. Factory default for TERMC = Off and TERMT = 50.

AUTO CONNECT

The Auto Connect feature allows the user to program the ESTeem to perform a CONNECT to another ESTeem when data is sent to the RS-232C communications port.

To enable this feature perform the following from the COMMAND MODE:

SETCON (1-255) = Address of destination ESTeem.

Remember, you can use the Repeater routing (r1,r2,r3,da) or put the ESTeem in Global (address 255). SETCON is the set connect command.

SA SAVE command. This will save the SETC variable to the non volatile memory so that it will not be lost when the ESTeem is RESET.

Bit 2 (on/off) = On. Bit 2 is located on the RS-232C SETUP SWITCH on the front of the ESTeem. The ESTeem must be RESET after the Bit has been changed to be read by the ESTeem CPU.

RESET ESTeem RESET is located on the front panel OFF/ON switch. The T/E light on the front panel of the ESTeem should now flash at a two times per second rate.

MULTI-CONNECT

The actual polling of the ESTeem must originate from the host device connected to the ESTeem using the CONNECT command to originate the initial connect and the COMMAND character to return from the CONVERSE mode to the COMMAND mode. The first time around the pole a CONNECT data packet (rf transmission) will be initiated. When a link is established, it is held internally in the ESTeem connect table. The next time around the pole to the same address, the link status will be checked in the ESTeem table. If the address indicates a link has already been established, then only data and its corresponding ACK will be transmitted to that node. This greatly increases polling time by eliminating the usual CONNECT/DISCONNECT sequence each time except when communication is first established.

The MULTID command allows the user to send data to a specific ESTeem address from the CONVERSE Mode by specifying the ESTeem address routing before the data packet. This feature will also display the address of the sending ESTeem on any received data.

CHAPTER 3

PROGRAMMING ESTEEM FEATURES

Example Of Transmitted Data:

[001]DATA Routes data to an ESTeem addressed 1.

[100,200,250,1]DATA Routes data to an ESTeem addressed 1 via ESTeems addressed 100, 200, and 250.

The above example replaces the CONNECT command from the COMMAND Mode.

Received data packets will have the address of the ESTeem that sent the data at the beginning of the data packet.

Example Of Received Data:

[004]RECEIVED DATA Data received from an ESTeem addressed 4.

[030,100,244,004] Data received from an ESTeem addressed 4 via ESTeems addressed 30, 100, and 244.

MULTID (on/off) = On Enables this feature. Factory default = OFF.

REMOTE PROGRAMMING

The Remote Programming feature allows the user to remotely program ESTeems in his network. When a connection has been made with the remote ESTeem the RPG: prompt will be displayed showing that you are now in the COMMAND mode of that remote ESTeem.

To enable this feature perform the following from the COMMAND MODE:

PROG (1-254) Address of destination ESTeem.

Note: You can also use the Repeater routing (*r1,r2,r3,da*) to reach the destination ESTeem. (*r1 = address of first repeater, r2 = address of second repeater, etc. da = destination address*).

To end a remote programming session, hold Control and type C (^C) and you will return to the COMMAND prompt of your ESTeem. There is a Watch Dog Timer

that will automatically disconnect you from remote programming if there is no activity for thirty seconds.

The REMPROG (on/off) feature is used to defeat the ability of your ESTeem from being remotely programmed. If REMPROG = OFF another ESTeem cannot remotely program your unit. Factory default = ON.

SECURITY

The Security feature allows the user to lock out programming of the ESTeem. REMEMBER TO STORE YOUR CODE NUMBER IN A SAFE PLACE.

To enable this feature perform the following from the COMMAND MODE:

SECURITY (1 to 100,000) Entering a security number enables the security feature.

SAVE To enter the security code permanently into the ESTeem memory.

Note: When enabled, the ESTeem will output a "Security On" message.

To disable the security feature perform the following from the COMMAND mode.

SECURITY (1 to 100,000) Entering your security number disables the security feature.

SAVE To remove the security code permanently from the ESTeem memory.

Note: When disabled, the ESTeem will output a "Security Off" message.

CHAPTER 3

PROGRAMMING ESTEEM FEATURES

HARDWARE RING LINE (Factory Option)

When the ESTeem establishes a CONNECT or link with another ESTeem (T/E Light on solid), pin 22 at the ESTeem RS-232C will change from a -15 vdc voltage state to a +15 vdc voltage state. The RING software command allows the user to change the output from a latched state to a pulsed state. To change the state of this line program the following from the COMMAND mode. Factory default = LATCH.

RING =Latch. Pin 22 is high when the ESTeem T/E light is on solid.

RING =Pulse. Pin 22 is pulsed (positive 250 ms.) when the ESTeem T/E light is on solid.

PACKET MONITOR

The PACKM [ON/OFF] command places the ESTeem in a special packet monitor mode. When this feature is enabled the ESTeem is placed in a receive only mode and will not function as a normal ESTeem. The ESTeem will monitor and report the status of all message traffic within the network in the following format, the actual packet message will not be outputted.

SA-xxx, DA-xxx, Type Code, R1-Repeater Status, R2-Repeater Status, R3-Repeater Status, Data Bytes Sent

xxx = ESTeem Address
DA = Destination ESTeem
SA = Source ESTeem
R1 = Address of first ESTeem repeater.
R2 = Address of second ESTeem repeater.
R3 = Address of third ESTeem repeater.

Type Codes

I = Information
DISC = Disconnected
RR = Receive Ready
UA = Unnumbered Acknowledge
RNR = Receive Not Ready
FRMR = Frame Reject
REJ = Reject
DM = Disconnected Mode
UI = Unnumbered Information

SABM = Set Async. Balance Mode

Repeater Status

P = Pending
D = Done

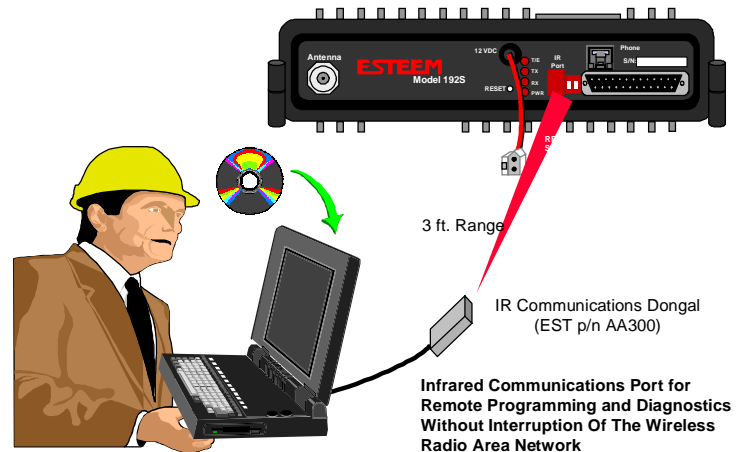

Figure 1: Using The IR Port

USING THE INFRARED COMMUNICATIONS PORT

The infrared (IR) communications port will allow you to program and interrogate the ESTeem without disconnecting the serial cable from the back of the modem. The IR port is located on the front panel of the ESTeem, above the T/E light.

To communicate from a computer to the ESTeem through the IR port you will need a copy of the ESTeem Utilities (Version 4.0 or higher) and an ESTeem IR Communication Dongle (ESTEem P/N AA300).

Connect the dongle directly to the serial port of the computer. The dongle requires initialization from the ESTeem Utilities. From the Terminal Emulation screen press the F3 function key to initialize the dongle. If the modem is not in the COMMAND mode, press CTRL-C to display the CMD: prompt.

Note: With Switch 2 (RS-232 Setup) in the On position the ESTeem defaults the IR port to the command mode.

CHAPTER 3

PROGRAMMING ESTEEM FEATURES

The IR dongle has a range of approximately three feet, directly in front of the port. The dongle is powered by the serial port and requires no additional power sources.

Note: *Only one of the three communications ports (RS-232/422/485 connector, IR port or Remote Programming) can be in the Command mode at a time. When either the IR or the Phone port switch to converse mode, the RS-232/422/485 port is blocked from receiving any data.*

UPDATING FLASH MEMORY

The ESTeem Model 192 stores its operating system in flash memory that can be updated without returning the modem to the factory. To upload the latest operating file, please contact Customer Support at 509-735-9092 or e-mail support@esteem.com to request the latest flash memory update file for your product.

Once you receive the flash file from Customer Support, conduct the following steps to update the memory:

1. Open the ESTeem Utilities and select Terminal Emulation.
2. Verify that both switches (Bits 1 and 2) are in the down (OFF) position and reset the modem.
3. Select *Terminal Setup>Port* from the menu items and configure the computer serial port for 19,200,N,8,1.

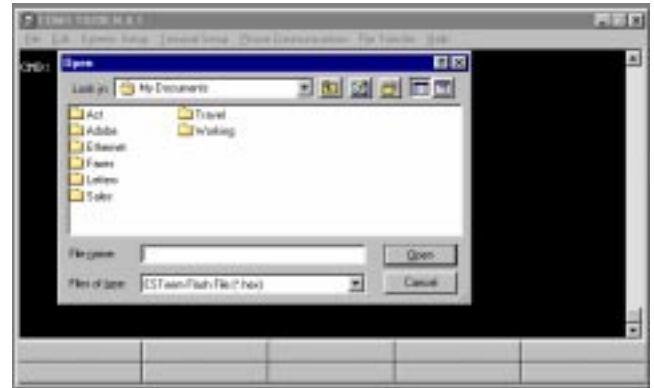

Figure 2: Updating Flash Memory

Note: *The flash update can not be loaded through the Infrared Dongle or remote programming. You must connect directly the ESTeem serial port.*

4. Set the modem to factory defaults by entering FA <Enter> at the command prompt (CMD:).
5. Select *ESTeem Setup>Update Flash Memory* from the menu and the Utility will read information about the connected modem and ask for the location of the flash file (Figure 2). Browse to the location of the flash update file on the computer and select Open.
6. Once the upload has been completed, re-program the modem for operation.

CHAPTER 4

ESTEEM APPLICATION PROGRAMS

TRANSPARENT AUTO CONNECT

TRANSPARENT AUTO CONNECT GLOBAL

INTERACTIVE TERMINAL APPLICATIONS

PROGRAMMABLE LOGIC CONTROLLERS

CHAPTER 4

ESTEEM APPLICATION PROGRAMS

Listed below are different application programs to aid the user in programming the ESTeem.

TRANSPARENT AUTO-CONNECT

This mode is used for a dedicated point to point application. The ESTeem will initiate the radio link when data is received by the RS-232/422/485 port.

Perform the following prior to programming the ESTeem(s) to initialize the unit to factory default settings:

1. Turn Bit 2 OFF on the RS-232C Setup Switch.
2. Reset the ESTeem.
3. TYPE FA <Enter>. Please note the characters may not be echoed by the CRT.

ESTeem A	ESTeem B
ADD xxx	ADD yyy
SETC yy	SETC xxx
TERMC ON	TERMC ON
TERMT 10	TERMT 10
XHF ON *	XHF ON *
DISACK ON *	DISACK ON *
TRANS ON	TRANS ON
SAVE	SAVE
Bit 2 ON	Bit 2 ON (RS-232 Switch)
Reset ESTeem	Reset ESTeem

Notes:

- Turn DISACK ON only if you want to defeat the acknowledge packet.
- xxx and yyy represent an ESTeem address which is user definable from 1 to 254.

TRANSPARENT AUTO-CONNECT GLOBAL

This mode is usually used for a point to multi-point applications when a customers devices include their own addressing protocol to communicate between devices. The ESTeem packet addressing and acknowledge protocol is defeated. All ESTeems will receive the data transmission. The 32 bit CRC error checking on received data is still enabled. This program is used in all ESTeems, the only difference is the unit addresses.

Perform the following prior to programming the ESTeem(s) to initialize the unit to factory default settings:

1. Turn Bit 2 OFF on the RS-232C Setup Switch
2. Reset the ESTeem.
3. TYPE FA <Enter>. Please note the characters may not be echoed by the crt.

ESTeem A

ADD	xxx (xxx = ESTeem address)
SETCON	255
TERMC	ON
TERMT	10
XHF	ON *
TRANS	ON
SAVE	
Bit 2	ON (RS-232 Switch)
Reset ESTeem	

Note: Only hardware flow control can be used in this mode.

CHAPTER 4

ESTEEM APPLICATION PROGRAMS

INTERACTIVE TERMINAL APPLICATION

This program is used to connect a mainframe to a remote terminal. This setup is a typical point to point configuration with the AUTO-CONNECT feature enabled.

Perform the following prior to programming the ESTeem(s) to initialize the unit to factory default settings:

1. Turn Bit 2 OFF on the RS-232C Setup Switch.
2. Reset the ESTeem.
3. TYPE FA <Enter>. Please note the characters may not be echoed by the crt.

ESTeem At Mainframe		ESTeem At Terminal	
ADD	xxx	ADD	yyy
SETC	yyy	SETC	xxx
TERMC	ON	TERMC	ON
TERMT	10	TERMT	10
XSF	OFF	XSF	OFF
XHF	ON *	XHF	ON *
DISACK	ON *	DISACK	ON *
TRANS ON		TRANS ON	
SAVE		SAVE	
Bit 2 ON		Bit 2 ON (RS-232 Switch)	
RESET ESTeem		RESET ESTeem	

Notes:

- Turn DISACK ON only if you want to defeat the acknowledge packet.
- Only hardware flow control can be used in this mode.
- xxx and yyy represent an ESTeem address which is user definable from 1 to 254.

PROGRAMMABLE LOGIC CONTROLLERS

EST has available complete Engineering Reports for each PLC manufacturer make which will be provided at no charge by calling EST Customer Support on 509-735-9092. All Engineering Reports are also available on the ESTeem Utility Software CD (EST P/N AA106) in Adobe™ PDF format.

CHAPTER 5

RS-232C/422/485 INTERFACING

DTE VS DCE

FLOW CONTROL

MEMORY BUFFERS

DATA TERMINAL READY

RS-422/485 CONFIGURATION

RS-232/422/485 CONFIGURATION TABLES

RS-232/422/485 PORT PINOUT TABLE

RS-232/422/485 COMRATE TABLE

CHAPTER 5

RS-232C/422/485 INTERFACING

DTE vs. DCE

The ESTeem is configured as a Data Communication Equipment (DCE) device. The following signals are available at the RS-232C connector located at the rear of the unit.

	Pin		Description
DCE	1	FG	Shield Ground
	2	TXD	Transmit Data (Input)
	3	RXD	Receive Data (Output)
	4	RTS	Request To Send (Input)
	5	CTS	Clear to Send (Output)
	7	SG	Signal Ground
	8	DCD	Data Carrier Detect (Output)
	12	RTS	Request To Send (Output)
	20	DTR	Data Terminal Ready (Input)
	22	Ring	Ring Indicator (Output)

The important thing to remember is that for the ESTeem to communicate with an external device, the data output from pin 3 of the ESTeem RS-232C connector must be connected to the data input of the device you are connected to; otherwise, the ESTeem won't work. Likewise, the data input to pin 2 of the ESTeem must be connected to the data output of the device you are connected to. Normally, if the equipment you are connecting to looks like a terminal or computer (DTE), its input, Receive Data (RXD), will be on pin 3 its output, Transmit Data (TXD), will be on pin 2. Therefore, the ESTeem can be connected directly.

If the device you are connecting to is configured as a modem (DCE), its output will be on pin 3. If this configuration is connected to the ESTeem, damage may result to the ESTeem or the connecting device. In this case, you can purchase a null connector that internally reverses pins 2 and 3.

Whatever your situation may be, it is always best to check the manual on your particular device and connect accordingly.

Purchase or fabricate a RS-232C shielded cable for your ESTeem. The ESTeem requires a standard male 25 pin D connector on one end of the cable for proper connection.

Remember to install the small retaining screws on either side of the cable connector. Tightening these screws

keeps you from accidentally losing connection with your ESTeem.

Notes:

- *The ESTeem requires a shielded RS-232 cable. This is to prevent unwanted electrical noise from entering the ESTeem and also to prevent any electrical noise from getting out of the ESTeem.*
- *Remember -- always use a shielded RS-232C cable.*
- *Pins 9, 10, 14, & 16 are used for RS-422/485 interfacing and should be left open if not used.*

FLOW CONTROL

The ESTeem can be enabled to support SOFTWARE or HARDWARE flow control.

Software Flow Control

Software flow control is enabled by the XSFLOW (on/off) command in the ESTeem. When XSFLOW is ON the ESTeem will respond to <XOFF>, (stop) and <XON>, (off) commands from the RS-232 port. The factory default setting is OFF. The default value for START is 17 (CTRL Q) and for STOP is 19 (CTRL S).

Hardware Flow Control

Hardware flow control is enabled by the XHFLOW (on/off) command in the ESTeem. The factory default value is OFF.

When XHFLOW is enabled (on) the control signal lines, Request To Send (RTS, pin 4), Data Carrier Detect (DCD, pin 8), and Clear To Send (CTS, pin 5) are available to the user at the RS-232C connector. The CTS and RTS signals are used to control the flow of data into and out of the ESTeem.

The CTS signal on pin 5 is used to control the data into the ESTeem. When CTS is set (high on pin 5) the modem is ready to receive data. When CTS is reset (low on pin 5) the ESTeem is not ready to receive data.

The RTS signal is used to control data out of the ESTeem. RTS is set (high on pin 4), by the user to indicate to the ESTeem that the user is ready to receive data. When reset, the user is not ready to receive data. (NOTE: Low = On, High = Off).

CHAPTER 5

RS-232C/422/485 INTERFACING

MEMORY BUFFERS

The ESTeem has a 4000 byte buffer on the TRANSMIT SIDE (outgoing data) and a 4000 byte buffer on the RECEIVE SIDE (incoming data).

Transmit Buffer

The outgoing data buffer will hold two data blocks before the ESTeem will enable its RS-232C hardware/software flow control on data coming into the modem if the network is busy. A data block in this example is a block of data that is defined by the PACKLENGTH or SENDPAC character which ever occurs first.

Therefore, if PACKLENGTH = 10 the modem will input a maximum of 20 bytes before it enables its hardware/software handshake line (two 10 byte packets). In another example, if PACKLENGTH = 2000 but the data block is terminated by the SENDPAC character before the input buffer reaches the full 2000 bytes, the buffer will still hold only two data blocks if the network is busy.

In order to utilize the 2000 bytes storage for small data packets (bar code readers, etc.), program the modem using the following guidelines:

```
PACKLENGTH = 2000    SENDPAC = 255
TERMC       = ON     TERMT   = 10
```

Note: Set the TERMT time greater than the pause between data bursts.

By programming the above parameters the ESTeem will buffer the incoming data packets and automatically transmit the data when the 2000 byte buffer is filled or the TERMT time limit is met. This will allow the customer to use two blocks of 2000 or 4000 bytes before the modem enables the respect hardware/software control.

Receive Buffer

If the device that the receiving ESTeem is outputting data to, enables its respective hardware or software control, the modem will store 4000 bytes of data before flow controlling off the transmitting ESTeem.

DATA TERMINAL READY (DTR)

A software switch, DTR_ENAB (ON/OFF) is provided in the ESTeem for monitoring the status of a device connected to pin 20 of the RS-232C connector. The factory default setting is OFF. When this command is enabled the ESTeem will monitor the DTR signal on pin 20. If the DTR line being supplied to the ESTeem, from the user, is at a SPACE (high) condition then the ESTeem is enabled. If the DTR line is at a MARK (low) condition then the ESTeem is disabled.

This signal is normally used by the ESTeem modem as an indication that connection is made to a device that is on line and ready to transmit/receive data.

RS-422/485 CONFIGURATION

The ESTeem will support the requirements of the EIA Standard RS-422/485. This is a four (4) wire interface consisting of the TRANSMIT DATA (-), TRANSMIT DATA (+), RECEIVE DATA (-), AND RECEIVE DATA (+) or a two (2) wire interface using B (+) and A (-). These signals are available at the 25 pin RS-232C connector on the modem.

	Pin	Description
	9 BTR (-)	TRANSMIT DATA (-)
	10 BTR (+)	TRANSMIT DATA (+)
DCE	14 BRX (+)	RECEIVE DATA (+)
(4-Wire)	16 BRX (-)	RECEIVE DATA (-)

	Pin	Description
DCE	14 (+)	HALF-DUPLEX B (+)
(2-Wire)	16 (-)	HALF-DUPLEX A (-)

This interface is designed to provide unipolar differential drive to twisted pair or parallel wire transmission lines.

Note: The ESTeem is configured at the factory for RS-422 interfacing. RS-485 (either 4 or 2 wire mode) requires internal jumper configuration. Please contact EST Customer Support at 509-735-9092 for instruction.

The ESTeem can be factory configured RS-485 interfacing prior to shipment. Call EST Customer Support on 509-735-9092 for further details.

CHAPTER 5

RS-232C/422/485 INTERFACING

RS-232C/422/485 Configuration Tables

On the front plate of the ESTeem is a two position RS-232 Setup switch labeled SW. The switch positions are defined as follows:

**RS-232C/422/485
SETUP SWITCH TABLE**

BIT 1	OFF	Default baud rate 19.2K, N, 8, 1
BIT 1	ON	Use software to select baud rate
BIT 2	OFF	Enter Command Mode upon initialization
BIT 2	ON	Enter Conversation Mode upon initialization

**ESTeem RS-232C/422/485
Port Pin-Out Table**

Pin No.	Function
1	Shield Ground
2	Transmit Data (TxD)
3	Receive Data (RxD)
4	Request To Send (RTS Input)
5	Clear To Send (CTS)
6	Data Set Ready (DSR)
7	Signal Ground
8	Data Carrier Detect (DCD)
19	Mode Control
20	Data Terminal Ready (DTR)
22	Ring Indicator (RI)
12	Request To Send (RTS Output)
9*	RS-422/485 Transmit Data (-)
10*	RS-422/485 Transmit Data (+)
14*	RS-422/485 Receive Data (+)
16*	RS-422/485 Receive Data (-)

Note: *The ESTeem is configured at the factory for RS-422 interfacing. RS-485 (2 or 4 wire) requires internal jumper configuration. Please contact EST Customer Support at 509-735-9092 for instruction

RS-232C/422/485 COMRATE Tables

The ESTeem Model 192 uses the COMRATE software command to set the communication port speed when Bit 1 on the RS-232 Setup Switches is in the ON position. The ESTeem Utility Program will calculate the required COMRATE value and download to the ESTeem in [Step 3](#) of the [Starting Out](#) Menu or by selecting *ESTeem Setup > Configure ESTeem Serial Port* from the [Terminal Emulation](#) menu. If you would like to manually enter the command to set the serial port speed on the modem please use the following table as a guideline:

19,200	9,600	4,800	2,400	1,200	600	
0	1	2	3	4	5	N,7,1
8	9	10	11	12	13	N,7,2
16	17	18	19	20	21	E,7,1
24	25	26	27	28	29	E,7,2
32	33	34	35	36	37	N,8,1
40	41	42	43	44	45	N,8,2
48	49	50	51	52	53	E,8,1
56	57	58	59	60	61	E,8,2
80	81	82	83	84	85	O,7,1
88	89	90	91	92	93	O,7,2
112	113	114	115	116	117	O,8,1
120	121	122	123	124	125	O,8,2

CHAPTER 6

ANTENNAS

COAXIAL CABLES

WEATHER PROOFING COAXIAL CONNECTORS

GROUNDING

LIGHTNING ARRESTORS

REFERENCE MATERIAL

**MODEL 192 TYPICAL OUTDOOR ANTENNA INSTALLATION
BLOCK DIAGRAMS**

**MODEL 192 TYPICAL INDOOR & MOBILE ANTENNA
INSTALLATION BLOCK DIAGRAMS**

ESTEEM SWR MEASUREMENT BLOCK DIAGRAM

CHAPTER 6

ANTENNAS

EST offers different types of antennas ranging from 1/4 wave to 5/8 wave in physical size. The user choice is dependent on the application.

Communications in the VHF and UHF bands are normally over "**Line of Sight (LOS)**". Looking from the antenna of one wireless modem you must be able to see the antenna of the wireless modem you wish to communicate with. If a large object obstructs the line of sight view it is unlikely that satisfactory communications will result. This means you must relocate the antennas or use the REPEATER FEATURE and a second modem to go over or around the object.

The Model 192C/F/M products are allowed by the FCC to use high gain directional antennas.

It is noted that a 1/4 wave antenna that does not have ground plane radials requires a ground plane to operate at maximum efficiency. This can simply be a conducting surface under the antenna that is a 1/4 wave length in diameter. For the Model 192C this is approximately 6.5 inches. A conducting surface can be anything from the roof top of an automobile to a file cabinet.

COAXIAL CABLES

To minimize signal loss, the overall length of the coaxial cable should be as short as possible. To avoid corrosion select coaxial cable manufacturers with tinned copper braid, where possible. Listed below are representative cable losses in db/100ft at the VHF and UHF frequencies:

Frequency (MHz)	RG-58u	RG-8	1/2" Heliax
150-174	- 5.2	- 2.3	- 0.845
402-420	-10.0	- 4.2	- 1.5
450-470	-10.8	- 4.4	- 1.5

In a severe noise environment it may be desirable to use a double shield type of coax cable such as RG-214/U.

Note: *Pre-made coax cables can be purchased from the factory. A -3 dB loss means you have lost 1/2 of your signal. A +3 dB gain means you have doubled (x2) your signal.*

Keep the antenna feedline as short as possible to minimize losses.

Extreme care must be taken when attaching coax connectors to the antenna feedlines. If there is any error in making this connection the output of the transmitter will be greatly reduced.

WEATHER PROOFING COAX CONNECTIONS

1. Coat the threads of the connectors with silicone lubricant prior to assembly (See Note 1) and hand tighten. Care should be taken not to get any lubricant on the center conductor.
2. Wrap the connector assembly with a vapor barrier patch for weather proofing (See Note 2), ensuring to overlap onto the coax cable approximately 1 1/2 inches.
3. Apply a electrical coating (sealing agent) over the vapor barrier patch for added protection (See Note 3).

Notes:

1. *Dow Corning RTV-3140 or equivalent.*
2. *Suggested vendors:*

*VAPOR-WRAP
Decibel Products
3184 Quebec St.
Dallas, TX 75356
214-631-0310*

*VYNIL-MASTIC, P/N 2200
3-M Company
Customer Service
512-984-1800*

3. *SCOTCHKOTE, 3-M Company, or equivalent.*

GROUNDING

All building mount antennas require attachment to a good earth ground for optimum efficiency. Contact a reputable local communications shop for procedures for your area.

CHAPTER 6

ANTENNAS

LIGHTNING ARRESTORS

Lightning arrestors should be used on all external building mount antennas for personal protection and to minimize damage to the transceiver during lightning storms. The units should be installed as per manufacturers instructions provided with the device.

REFERENCE MATERIAL

The ideal reference book for antennas and transmission lines is the “**The Radio Amateur's Handbook**”, by the Headquarters Staff of the American Radio Relay League.

CHAPTER 6 ANTENNAS

Model 192M Outdoor Fixed Base Site Diagram

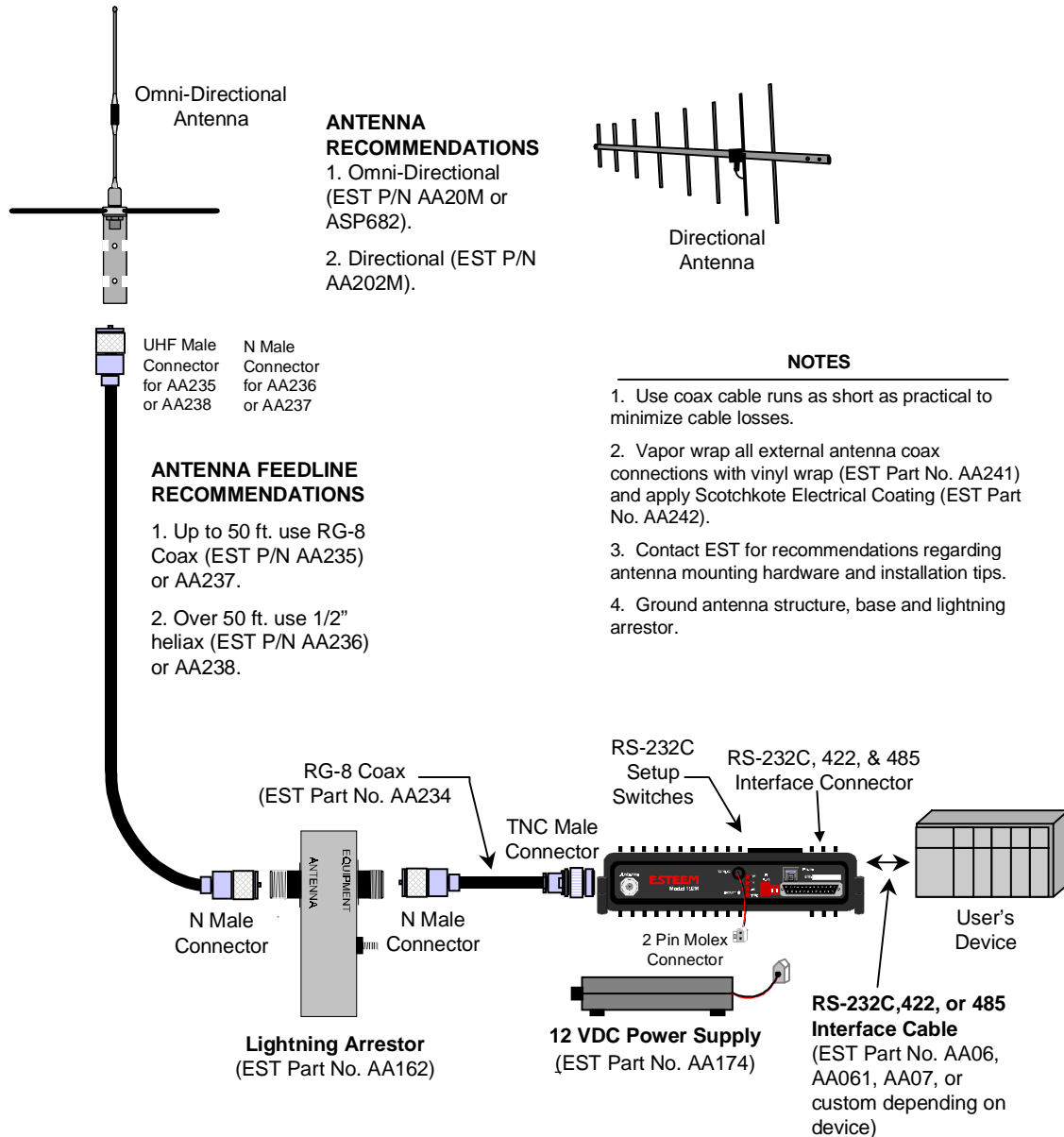

CHAPTER 6 ANTENNAS

Models 192C and 192F Typical Outdoor Antenna Installation Diagram

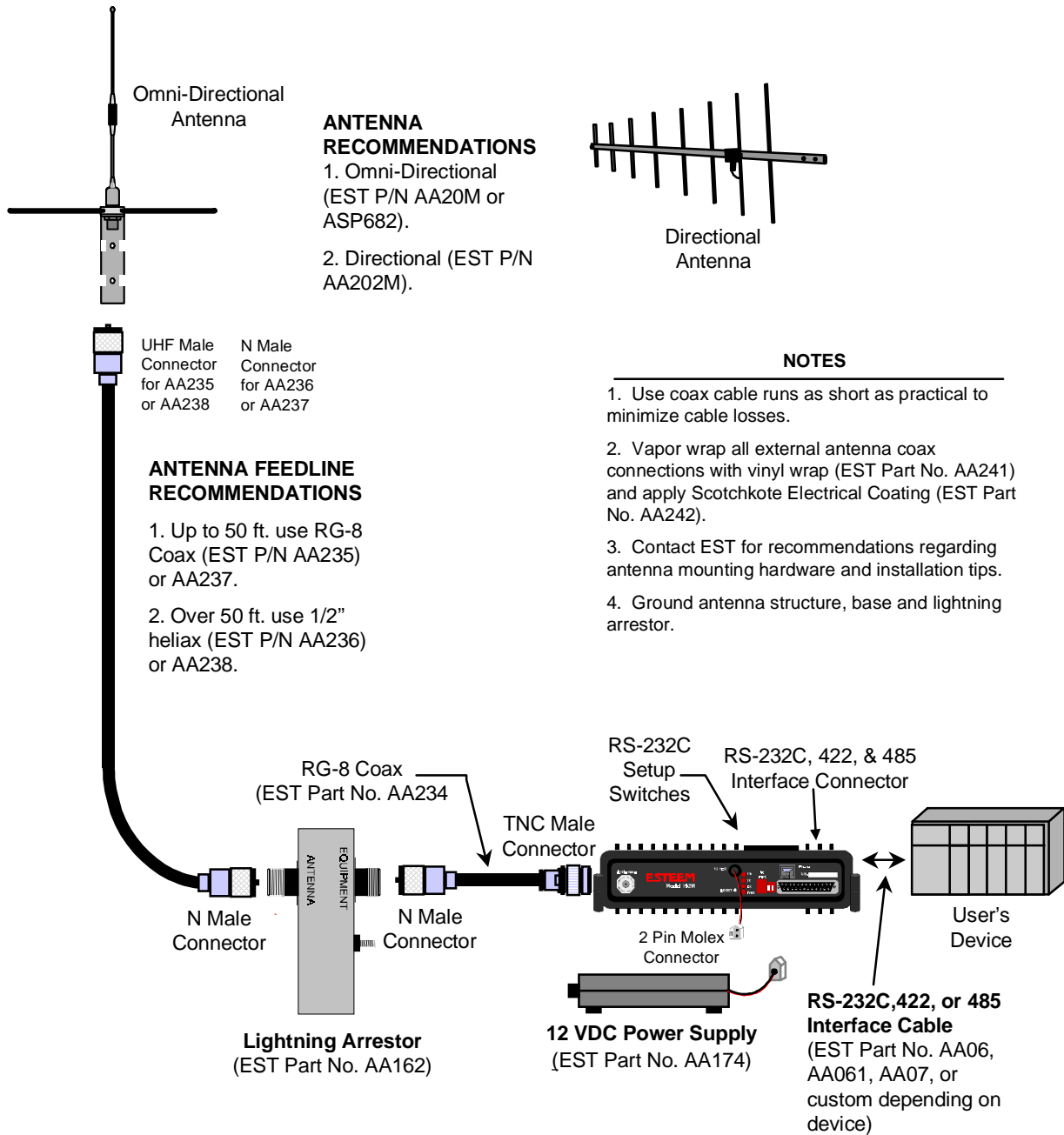

CHAPTER 6 ANTENNAS

Model 192M Typical Indoor & Mobile Equipment Diagram

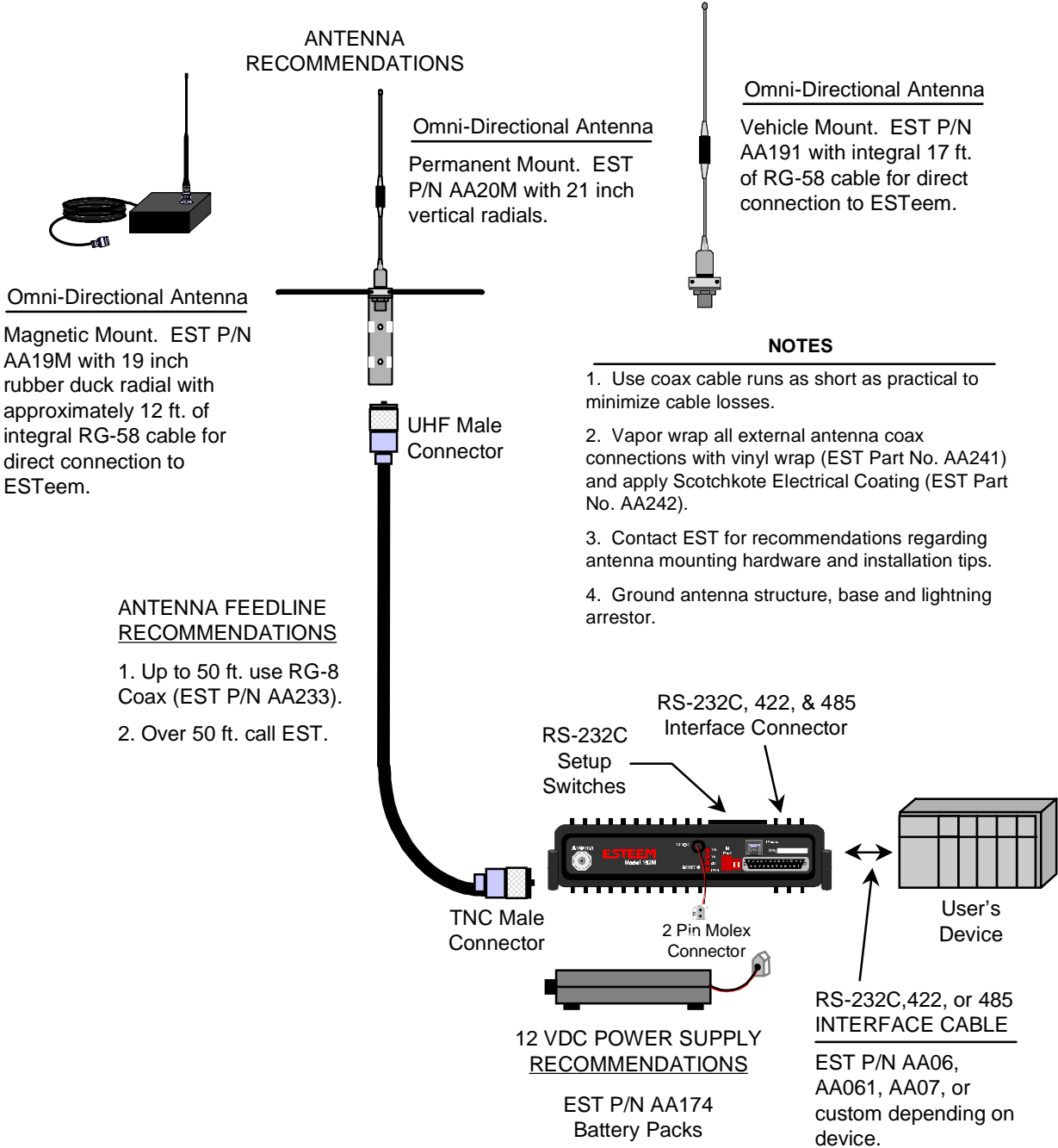

CHAPTER 6 ANTENNAS

Model 192C and 192F Typical Indoor & Mobile Antenna Installation Diagram

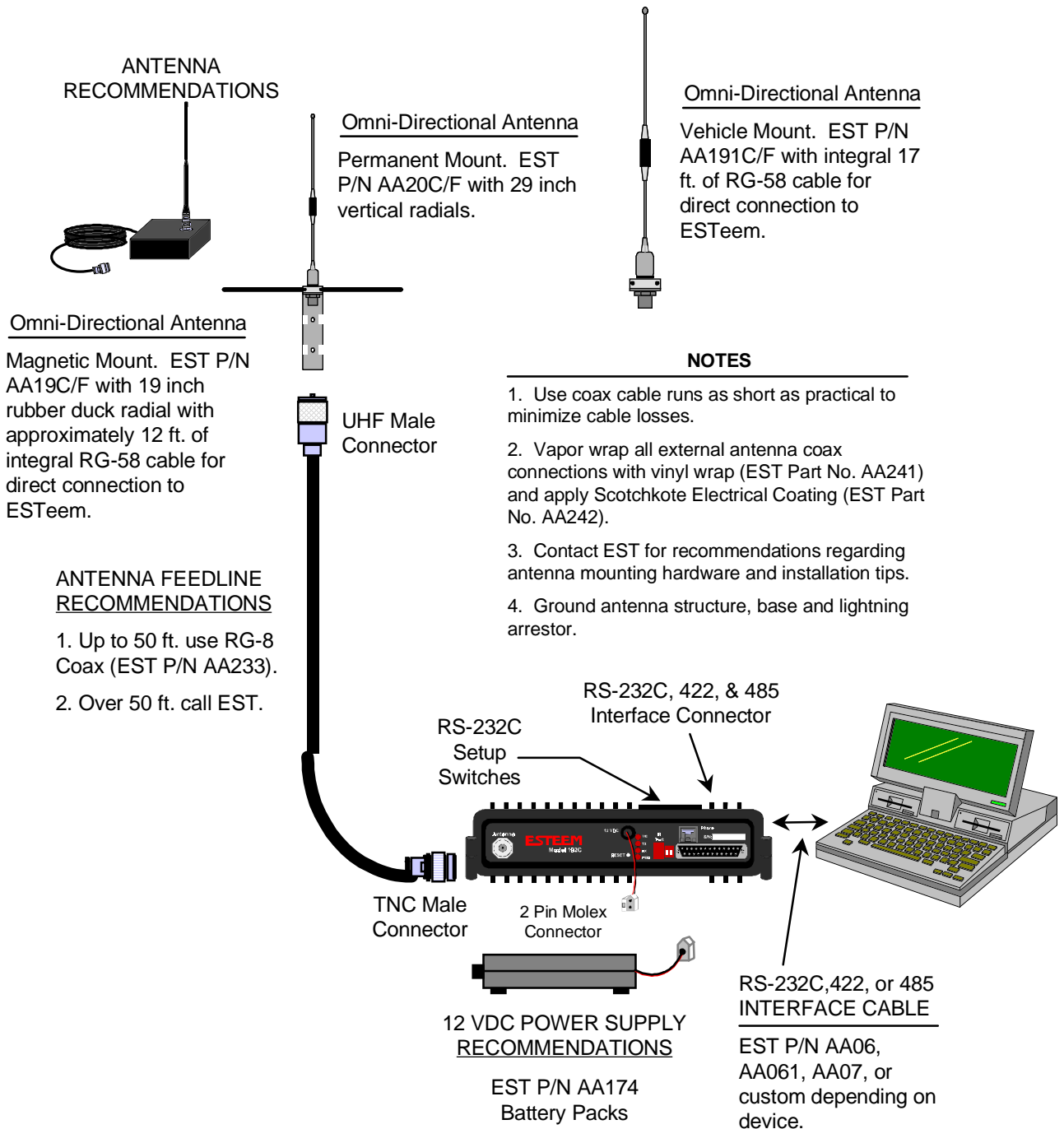

CHAPTER 6 ANTENNAS

ESTeem SWR Measurement Block Diagram

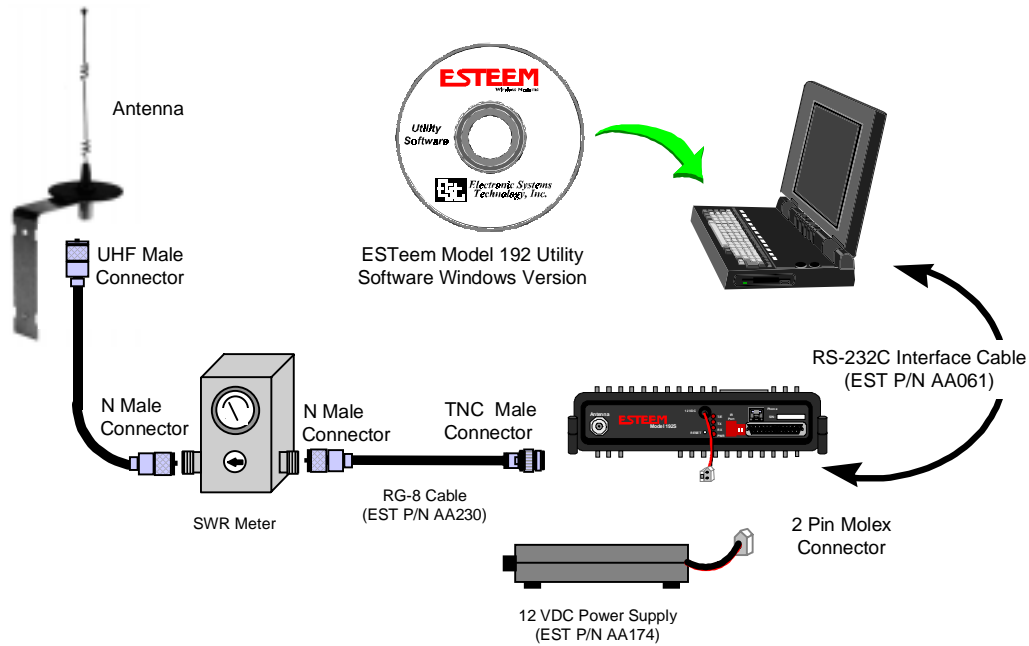

Programming The ESTeem Model 192 For SWR Measurements

1. Configure the hardware as per the above diagram.
2. Turn Switch 2 on the RS-232 Setup Switch (located on the rear of the ESTeem) to the OFF position.
3. Reset the ESTeem (front panel push button).
4. Install the ESTeem Utility on the PC hard drive as per instructions with the software.
5. From Utility Main Menu (Figure 1) select the Terminal Emulation Mode.
6. In the Terminal Emulation Mode type the following commands followed by a RETURN.

FA Return	This returns the unit to factory default parameters.
RAD ON Return	Enable the RADIO ON command. The transmitter will alternate ON for 10 seconds and OFF for 3 seconds.



Figure 1: ESTeem Utility Main Menu

7. When the testing is completed, type the following:

RAD OFF Return	This disables the RADIO ON command.
----------------	-------------------------------------

CHAPTER 7

THEORY OF OPERATION

INTRODUCTION

ESTEEM HOW IT WORKS

SPECTRUM UTILIZATION

PACKET PROTOCOLS

FLOW CONTROL

DATA PRIVACY

EFFECTIVE BAUD RATE

CHAPTER 7

THEORY OF OPERATION

INTRODUCTION

ESTeem wireless modem products provide a "Wireless Solution" by eliminating conventional hardwiring of leased phone lines.

All of the ESTeem models come with the industry standard RS-232C, RS-422, and RS-485 asynchronous communications ports to give the user a new dimension to "Local Area Networking".

Our packet burst, frequency agile communications products allow the user to create a "Radio Area Network" of up to 255 users on a single frequency. The packet burst communications technique was chosen to give the system very high data integrity in high noise industrial environments. The ESTeem incorporates a method of error checking that provides received data accuracy of greater than one part in 100 million.

Internal Digi-Repeater features allow the user to increase operating range by relaying transmission through a maximum of three ESTeems to reach the destination ESTeem. An ESTeem can operate as an operating node, a repeater node, or both simultaneously for added flexibility.

"Private Data Communications" is provided by the use of an interleaving technique of the modulated data, user definable commands for unit addressing, network addressing, and security lock-out of software programming. If higher security is required, the ESTeem is compatible with asynchronous Data Encryption Standard (DES) encryption devices.

The ESTeem has programmable software commands to allow the user to easily configure the unit for any application or mission. The ESTeem setup parameters are saved in non-volatile memory.

When you buy ESTeem products you are getting equipment designed by the company that holds the United States and Canadian patent for the wireless modem. We are proud to say that we design, develop and manufacture our products in the United States. Each ESTeem is subjected to a rigorous quality control bench test before shipping to insure our customers have out-of-the-package reliability. We also have a dedicated Customer Support Staff, Field Engineering Services and Factory Training classes to make sure that your application problems are solved.

HOW IT WORKS

Now, as you can probably guess, the ESTeem is a sophisticated piece of technology, however the concept is easy to comprehend if you understand packet radio.

All packet systems, whether hardwired or radio, share the same principle of operation; data is taken from your standard RS-232C, RS-422, or RS-485 asynchronous port and is transmitted in "Blocks". Think of this block as an "Electronic Envelope" that we call a packet. The size of the packet can be defined by the user from 1 to 2000 bytes of information. Reducing the size of the packet allows the ESTeem to operate better in high EMF noise environments, because by reducing the packet size you reduce transmission exposure time on the radio waves thereby increasing your probability of a successful transmission.

Once this packet of data is formed, it's transmitted in a "burst," one ESTeem to another, hence the term "packet burst communications". Now, if more than one packet is required to send the data then the ESTeem goes into full automatic mode and transmits additional packets.

Before an ESTeem transmits its packet it listens to ensure that the air waves are clear before transmitting. This listen before transmit scheme is called "carrier sensed multiple access," or CSMA.

When a "packet" has been transmitted, every modem in radio range on the same frequency hears it. To design a modem to communicate with a network of modems it has to be "address specific" so only the modem you want to talk to accepts your information. It's like yelling into a crowd of 255 people but you want only the person's name you called to acknowledge (ACK). Well, very simply, that's how the ESTeem works. Once the address you're calling receives your packet, it's checked for accuracy.

Accuracy is probably the single most important part of any communication device. The ESTeem uses Forward Error Correction (FEC) and a 32 bit Cyclic Redundancy Check (CRC) which is a very sophisticated method of checking the data integrity of the packet once its been received. The CRC insures data integrity greater than one part in one hundred million. Once the CRC is completed on the received packet, the data is outputted to the user and a positive acknowledgment (ACK) is transmitted back to the sender.

CHAPTER 7

THEORY OF OPERATION

It's safe to assume that the data you receive is good data or you get nothing at all using the CRC technique. If no ACK is returned after a given delay, the sender assumes the packet was not received and "retries" the transmission. The number of retries are user definable from 1 to 255, allowing the unit to automatically retry sending the packet.

SPECTRUM UTILIZATION

The ESTeem uses a "listen before transmit" or Carrier Sensed Multiple Access (CSMA) scheme. This means only one unit in a network is allowed to transmit at a time. By fixing each user's communication window and allowing the computer in the ESTeem to be the Air Traffic Controller, many individual users can share one frequency. The ESTeem firmware can support up to 255 ESTeems on a single channel or frequency. For example in the United States there are 1600 frequencies (12.5 kHz channel spacing) in UHF, giving a network density of greater than 408,000 users in a given cell or geographical area. Once you are out of radio range, you can construct another cell of users.

The CSMA technique is a very efficient way to manage your network of ESTeems and prevent communication bottlenecks. In addition, an anti-collision software scheme is used to recover data if two or more units transmit at exactly the same time. When this feature is added the technical term for this technique is now called CSMA-CD (collision detection).

By using this communications technique only one frequency channel is needed with a very narrow bandwidth (this is called narrow band FM modulation) thereby saving valuable radio spectrum space.

PACKET PROTOCOLS

By using CSMA no polling station or token is required in the ESTeem network. When an ESTeem has information to send it will check to see if the channel is clear before transmitting its packet and await an (ACK). The ESTeem is a Master/Master system, meaning any ESTeem can communicate with any other ESTeem.

FLOW CONTROL

The ESTeem supports hardware and software flow control, which allow different devices on the network to

communicate at different baud rates. In addition to flow control the ESTeem also has a 4000 byte data buffer on both the receive and transmit buffers in the unit.

DATA PRIVACY

Data privacy in the ESTeem is provided by three levels of data encoding in the firmware and by the user being able to define over four security and communications parameters (Unit Address, Network ID, and Operating Frequency) that allow communications access to the modem giving over 100 million combinations. If higher security is required, the units are compatible with asynchronous Data Encryption Standard (DES) encryption peripherals.

EFFECTIVE BAUD RATE

The maximum input baud rate to the modem is 19,200 baud, asynchronous, full duplex, but this is misleading since the ESTeems actually communicate to each simplex over the RF link, at 19,200 bps (25 kHz channel spacing - Model 192C/F) or 9,600 bps (12.5 kHz channel spacing - Model 192C/F). The effective baud rate is a function of the above plus the packet length variable in the ESTeem (definable from 1 to 2000 bytes). If the packlength variable is set to 2000 bytes the effective baud rate is approximately 18,000 baud (25 kHz channel spacing) or 9,000 baud (12.5 kHz channel spacing) the effective baud rate will degrade as the packlength variable is reduced.

Another item that must be understood is transmission turn around time. Remember that the ESTeem sends a data packet and waits for an (ACK) from the destination modem before another packet is transmitted. All radio transmitters have a fixed delay time, this is the amount of time it takes the transmitter to stabilize once it is energized before it can send data. In the ESTeem the delay is approximately 15 milliseconds *one way* which includes transmitter turn-on time and packet frame overhead or a total turn around time accounting for the (ACK) of 30 milliseconds. Therefore total time to send a data packet is 30 milliseconds plus the time required to send the data (i.e. number of bits sent/19,200 b/s).

APPENDIX “A” FCC INFORMATION (USA Only)

APPENDIX “B” SPECIFICATIONS

ESTeem Specifications
Antenna Specifications

APPENDIX “C” TABLES/DIAGRAMS

ESTeem Command Error Message Table
ESTeem System Status Message Table
ESTeem System Error Message Table

APPENDIX “D” ESTEEM SOFTWARE COMMANDS

Factory Default Settings
Definitions

APPENDIX A

FCC LICENSING

INFORMATION TO USERS

WARNING: This equipment has been tested and found to comply with the limits for a Class A digital device, pursuant to Part 15 of the FCC Rules. These limits are designed to provide reasonable protection against harmful interference when the equipment is operated in a commercial environment. This equipment generated, uses, and can radiate radio frequency energy and, if not installed and used in accordance with the instruction manual, may cause harmful interference to radio communications. Operation of this equipment in a residential area is likely to cause harmful interference in which case the user will be required to correct the interference at his own expense.

To insure compliance to FCC non-interference regulations, peripherals attached to this modem require shielded I/O cables.

If this equipment does cause interference to radio or television, which can be determined by turning the equipment off and on, the user is encouraged to try to correct the interference by one or more of the following measures:

1. Re-orient the radio/TV receiving antenna.
2. Re-orient the modem antenna.
3. Relocate the modem with respect to the radio/TV receiving antenna.
4. Plug the power supply for the modem into a different outlet so that the modem and radio/TV receiver are on different branch circuits.
5. Verify that the modem chassis is connected to an earth ground.
6. Attach a split bead (FAIR-RITE PN 2643164251) to the RS-232 cable.

If necessary, the user should consult the dealer or an experienced radio/TV technician for additional suggestions. The user may find the following booklet prepared by the FCC helpful.

"How to Identify and Resolve Radio-TV Interference Problems"

This booklet is available from the U.S. Government Printing Office, Washington, D.C. 20402 - Stock No. 004-000-00245-4. Application forms for the license are available from the nearest office of the FCC.

Electronic Systems Technology maintains a list of consultants that provide professional services at a reasonable cost to assist the users in licensing.

Other Information

Model 192C

25 KHz Channel Spacing, 19,200 bps
FCC Type Acceptance No: ENPESTEEM192
Emissions Designator: 17K6F1D

12.5 KHz Channel Spacing, 9,600 bps
FCC Type Acceptance No: ENPESTEEM192A
Emissions Designator: 10K8F1D

12.5 KHz Channel Spacing, 19,200 bps
Industry Canada Type Acceptance No: 2163 195 214A
Emissions Designator: 10K0F1D

Model 192F

25 KHz Channel Spacing, 19,200 bps
Industry Canada Type Acceptance No: 2163 195 214A
Emissions Designator: 17K6F1D

12.5 KHz Channel Spacing, 9,600 bps
Industry Canada Type Acceptance No: 2163 195 214A
Emissions Designator: 10K8F1D

25 KHz Channel Spacing, 19,200 bps
Malaysia Telecom No: RADL 60A 1097 S
Emissions Designator: 17K6F1D

Model 192M

25 kHz Channel Spacing, 19,200 bps
U.S.A. Type Acceptance: ENPESTEEM192M
Emission Designator: 17K6F1D

12.5 kHz Channel Spacing, 9,600 bps
U.S.A. Type Acceptance: ENPESTEEM192M
Emission Designator: 10K8F1D

25 kHz Channel Spacing, 19,200 bps
Canada: 2163195385A
Emission Designator: 17K6F1D

12.5 kHz Channel Spacing, 9,600 bps
Canada: 2163195385A
Emission Designator: 10K8F1D

APPENDIX A

FCC LICENSING

FEDERAL COMMUNICATIONS COMMISSION FIELD OFFICES

ALASKA

1011 E. Tudor Rd.
Rm 240 Box 2955
Anchorage, AK 99510

CALIFORNIA

7840 El Cajon Blvd
Suite 405
La Mesa, CA 92041

3711 Long Beach Blvd
Suite 501
Long Beach, CA 90807

323A Battery St
San Francisco, CA 94111

COLORADO

Executive Tower
1405 Curtis St
Suite 2925
Denver, CO 80202

FLORIDA

919 Federal Bldg
51 SE First Ave.
Miami, FL 33130

1211 N. Westshore
Suite 601
A.D. P. Building
Tampa, FL 33607

GEORGIA

Massell Bldg. 440
1365 Peachtree NE
Atlanta, GA 30309

HAWAII

7304 Prince Kuhi
Federal Building
Honolulu, HI

HAWAII

300 Almoana Blvd.
P.O. Box 50023
Honolulu, HI

ILLINOIS

3935 Federal Bldg
230 S. Dearborn
Chicago, IL 60604

LOUISIANA

1009 Edw Hebert Bldg.
600 South Street
New Orleans, LA 70130

MARYLAND

1017 Geo. Fallon
Building 31
Hopkins Plaza
Baltimore, MD

MASSACHUSETTS

1600 Customhouse
165 State Street
Boston, MA 02109

MICHIGAN

1054 Federal Building
231 W LaFayette
Detroit, MI 48225

MINNESOTA

691 Federal Building
316 N Robert St.
St. Paul, MN

MISSOURI

Brywood Office Tower
6800 E. 63rd Street
Kansas City, MO

NEW YORK

1307 Federal Building
111 W. Huron
Buffalo, NY 14202

201 Varick Street
New York, NY 10014

OREGON

1782 Federal Building
1220 SW 3rd Avenue
Portland, OR 97204

PENNSYLVANIA

Room 404
2300 E. Lincoln H
Langhorne, PA

PUERTO RICO

747 Federal Building
Carlo Chardon Ave.
Hato Rey, PR 00918

TEXAS

Cabeli Building
1100 Commerce
Dallas, TX 75242

5636 Federal Building
515 Rusk Avenue
Houston, TX 77002

VIRGINIA

Military Circle
870 N. Military Hwy.
Norfolk, VA 23502

WASHINGTON

3256 Federal Building
915 Second Avenue
Seattle, WA 98174

APPENDIX A

FCC LICENSING

FEDERAL COMMUNICATIONS COMMISSION FIELD OFFICES

ALASKA

1011 E. Tudor Rd.
Rm 240 Box 2955
Anchorage, AK 99510

CALIFORNIA

7840 El Cajon Blvd
Suite 405
La Mesa, CA 92041

3711 Long Beach Blvd
Suite 501
Long Beach, CA 90807

323A Battery St
San Francisco, CA 94111

COLORADO

Executive Tower
1405 Curtis St
Suite 2925
Denver, CO 80202

FLORIDA

919 Federal Bldg
51 SE First Ave.
Miami, FL 33130

1211 N. Westshore
Suite 601
A.D. P. Building
Tampa, FL 33607

GEORGIA

Massell Bldg. 440
1365 Peachtree NE
Atlanta, GA 30309

HAWAII

7304 Prince Kuhi
Federal Building
Honolulu, HI

HAWAII

300 Almoana Blvd.
P.O. Box 50023
Honolulu, HI

ILLINOIS

3935 Federal Bldg
230 S. Dearborn
Chicago, IL 60604

LOUISIANA

1009 Edw Hebert Bldg.
600 South Street
New Orleans, LA 70130

MARYLAND

1017 Geo. Fallon
Building 31
Hopkins Plaza
Baltimore, MD

MASSACHUSETTS

1600 Customhouse
165 State Street
Boston, MA 02109

MICHIGAN

1054 Federal Building
231 W LaFayette
Detroit, MI 48225

MINNESOTA

691 Federal Building
316 N Robert St.
St. Paul, MN

MISSOURI

Brywood Office Tower
6800 E. 63rd Street
Kansas City, MO

NEW YORK

1307 Federal Building
111 W. Huron
Buffalo, NY 14202

201 Varick Street
New York, NY 10014

OREGON

1782 Federal Building
1220 SW 3rd Avenue
Portland, OR 97204

PENNSYLVANIA

Room 404
2300 E. Lincoln H
Langhorne, PA

PUERTO RICO

747 Federal Building
Carlo Chardon Ave.
Hato Rey, PR 00918

TEXAS

Cabeli Building
1100 Commerce
Dallas, TX 75242

5636 Federal Building
515 Rusk Avenue
Houston, TX 77002

VIRGINIA

Military Circle
870 N. Military Hwy.
Norfolk, VA 23502

WASHINGTON

3256 Federal Building
915 Second Avenue
Seattle, WA 98174

APPENDIX B SPECIFICATIONS

ESTeem General Specifications

SWITCHES:

- CPU Reset
- RS-232C/422/485 Setup

LED INDICATORS:

- Power On
- Receiver Carrier Detect
- Transmitter Enable
- Link Connect/Disconnect
- Auto Connect Enabled
- RS-232C/422/485 Framing Error

I/O - CONNECTORS:

- Asynchronous Full Duplex, RS-232C, RS-422 and RS 485 with 25 Pin Sub D Connector.
- Antenna Output - TNC connector
- Input Power - 2 pin molex

ADDRESSING RANGE:

- 1 to 255

DATA INPUTS:

- Selectable 600 to 19,200 baud
- 7 to 8 data bits
- Even, odd, or no parity
- One or two stop bits

DATA BUFFERS:

- Transmit 4000 bytes
- Receive 4000 bytes

FLOW CONTROL:

- Hardware or Software

DATA TRANSMISSION PROTOCOL:

- Carrier Sensed Multiple Access with Collision Detection (CSMA-CD)

ERROR CHECKING:

Forward error correction and 32 Bit Cyclic Redundancy Check (CRC) with packet acknowledge and retry

MINIMUM RADIO TURN AROUND TIME:

- < 15 ms + Data (W/O ACK)
- < 30 ms + Data (W/ACK)

POWER REQUIREMENTS:

Models 192C & 192F

- 11 to 15 VDC @ 400 ma Rx
2 W RF 1.5 A Tx
4 W RF 2.0 A Tx

Model 192M

- 11 to 15 VDC @ 400 ma Rx
2 W RF 1.5 A Tx
4 W RF 2.0 A Tx

SIZE:

- 2.45 in. Height
- 9.37 in. Width
- 8.16 in. Length

WEIGHT:

- 5 lbs.

ENVIRONMENT:

- -30 TO 50 ° C.
- 95% non-condensing

WARRANTY:

- 1 Year

APPENDIX B SPECIFICATIONS

ESTeem Transceiver Specifications

ESTeem Model 192C

Frequency Range	450 to 470 MHz
Frequency Selection	Digitally Synthesized - Software Selectable
Frequency Stability	+/- 1 ppm
Frequency Selectability	6.25KHz
RF Data Rate	19,200 bps @ 25 KHz Channel Spacing U.S.A. Type Acceptance: ENPESTEEM192 Emission Designator: 17K6F1D 9,600 bps @ 12.5 KHz Channel Spacing U.S.A. Type Acceptance: ENPESTEEM192A Emission Designator: 10K8F1D 19,200 bps @ 12.5 KHz Channel Spacing Canada: 2163 195 214A Emission Designator: 10K0F2D
Transmitter Modulation	DC to 4800 Hz @ 19,200 bps DC to 2400 Hz @ 9,600 bps
Transmitter Deviation	4 KHz @ 19,200 bps 3 KHz @ 9,600 bps
Transmitter RF Power Output	2 Watts (4 Watts optional)
Transmitter Duty Cycle	100%
Transmitter Spurious & Harmonics	> 55 dB down from carrier
Transmitter Rise Time	1 msec
Transmitter FM Hum & Noise	> 50 dB down from carrier
Receiver Sensitivity:	-101 dBm
Receiver Spurious & Image Rejection	> 50 dB
Receiver Squelch Sensitivity	Adjustable - Four Levels
Receiver Adjacent Channel Rejection	> 70 dB
Receiver Modulation Acceptance:	25 KHz
Receiver Base Bandwidth:	4.8 KHz
Transmit/Receive Switch	Integral to Unit
RF Output Impedance	50 Ohms
RF Input/Output Connector	TNC Female
Power Supply Voltage	12 to 15 VDC
Power Supply Current @ 12 VDC	400 ma Receive 1.5 A Transmit (2 W RF Output) 2.0 A Transmit (4 W RF Output)
Input Power Connector	2 Pin Molex (male)
Temperature Range	-30 to + 50 ° C.
Size	2.45 in. H x 9.37 in. W x 8.16 in. L.
Weight	5 lbs.

ESTeem Model 192F

Frequency Range	400 to 420 MHz
Frequency Selection	Digitally Synthesized - Software Selectable
Frequency Stability	+/- 1 ppm
Frequency Selectability	6.25KHz
RF Data Rate	19,200 bps @ 25 KHz Channel Spacing Canada: 2163 195 214A Emission Designator: 17K6F1D 9,600 bps @ 12.5 KHz Channel Spacing Canada: 2163 195 214A Emission Designator: 10K8F2D
Transmitter Modulation	DC to 4800 Hz @ 19,200 bps DC to 2400 Hz @ 9,600 bps
Transmitter Deviation	4 KHz @ 19,200 bps 3 KHz @ 9,600 bps
Transmitter RF Power Output	4 Watts (2 Watts optional)
Transmitter Duty Cycle	100%
Transmitter Spurious & Harmonics	> 55 dB down from carrier
Transmitter Rise Time	1 msec
Transmitter FM Hum & Noise	> 50 dB down from carrier
Receiver Sensitivity:	-101 dBm
Receiver Spurious & Image Rejection	> 50 dB
Receiver Squelch Sensitivity	Adjustable - Four Levels
Receiver Adjacent Channel Rejection	> 70 dB
Receiver Modulation Acceptance:	25 KHz
Receiver Base Bandwidth:	4.8 KHz
Transmit/Receive Switch	Integral to Unit
RF Output Impedance	50 Ohms
RF Input/Output Connector	TNC Female
Power Supply Voltage	12 to 15 VDC
Power Supply Current @ 12 VDC	400 ma Receive 1.5 A Transmit (2 W RF Output) 2.0 A Transmit (4 W RF Output)
Input Power Connector	2 Pin Molex (male)
Temperature Range	-30 to + 50 ° C.
Size	2.45 in. H x 9.37 in. W x 8.16 in. L.
Weight	5 lbs.

APPENDIX B SPECIFICATIONS

ESTeem Transceiver Specifications

ESTeem Model 192M

Frequency Range	150 to 174 MHz
Frequency Selection	Digitally Synthesized - Software Selectable
Frequency Stability	+/- 2.5 ppm
Frequency Selectability	12.5 kHz
RF Data Rate	19,200 bps @ 25 kHz Channel Spacing U.S.A. Type Acceptance: ENPESTEEM192M Emission Designator: 17K6F2D 9,600 bps @ 12.5 kHz Channel Spacing U.S.A. Type Acceptance: ENPESTEEM192M Emission Designator: 10K8F2D 19,200 bps @ 25 kHz Channel Spacing Canada: 2163195385A Emission Designator: 17K6F2D 9,600 bps @ 12.5 kHz Channel Spacing Canada: 2163195385A Emission Designator: 10K8F2D
Transmitter Modulation	DC to 4800 Hz @ 19,200 bps DC to 2400 Hz @ 9,600 bps
Transmitter Deviation	4 kHz @ 19,200 bps 3 kHz @ 9,600 bps
Transmitter RF Power Output	2 Watts (4 Watts optional)
Transmitter Duty Cycle	100%
Transmitter Spurious & Harmonics	> 55 dB down from carrier
Transmitter Rise Time	1 msec
Transmitter FM Hum & Noise	> 50 dB down from carrier
Receiver Sensitivity:	-101 dBm
Receiver Spurious & Image Rejection	> 50 dB
Receiver Squelch Sensitivity	Adjustable - Four Levels
Receiver Adjacent Channel Rejection	> 70 dB
Receiver Modulation Acceptance:	25 kHz
Receiver Base Bandwidth:	4.8 kHz
Transmit/Receive Switch	Integral to Unit
RF Output Impedance	50 Ohms
RF Input/Output Connector	TNC Female
Power Supply Voltage	12 to 15 VDC
Power Supply Current @ 12 VDC	400 ma Receive 1.5 A Transmit (2 W RF Output) 2.0 A Transmit (4 W RF Output)
Input Power Connector	2 Pin Molex (male)
Temperature Range	-30 to + 50 ° C.
Size	2.45 in. H x 9.37 in. W x 8.16 in. L.
Weight	5 lbs.

APPENDIX B SPECIFICATIONS

Model 192C & F Antennas

Model No:	AA19C & AA19F
Antenna Type:	Omni-Directional, ½ Wave
Applications:	Mobile Mount.
Frequency:	450 to 470 MHz - AA19C 400 to 420 MHz - AA19F
Polarization:	Vertical
Impedance:	50 ohms
Gain:	2 db.
VSWR:	< 2 to 1
Front To Back Ratio:	n/a
Horizontal Beamwidth:	n/a
Vertical Beamwidth:	60 degrees
Antenna Material:	Rubber duck whip.
Mounting Hardware:	Magnetic base.
Antenna Connector:	TNC with 12 feet integral RG-58 cable.
Antenna Envelope:	16 in. length. Magnetic base 3.5 in. by 3 in by 1 in.
Weight:	1 lb. 5 oz.

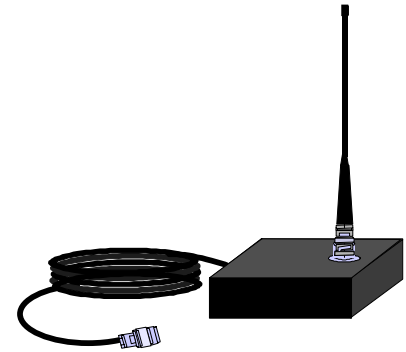

Model AA19

Model No:	AA20C & AA20F
Antenna Type:	Omni-Directional, DC grounded, Collinear 5/8 wave over 1/2 wave.
Applications:	Fixed base or mobile mounting. L shaped mounting bracket may be removed for panel mounting. Ground plane radials may be removed depending on application.
Frequency:	450 to 470 MHz - AA20C 400 to 420 MHz - AA20F
Polarization:	Vertical
Impedance:	50 ohms
Gain:	4.5 dB.
VSWR:	< 1.5
Front To Back Ratio:	n/a
Horizontal Beamwidth:	n/a
Vertical Beamwidth:	30 degrees
Antenna Material:	Stainless steel whip and ground plane radials. All other hardware anodized metal.
Mounting Hardware:	Stainless steel clamps for mounting to ¾ in. to 1 /2 in. pipe with right angle mount or direct mount.
Antenna Connector:	UHF Female (S-239)
Antenna Envelope:	37 ½ in. length by 16 in width with ground plane radials.
Weight:	2 lbs.

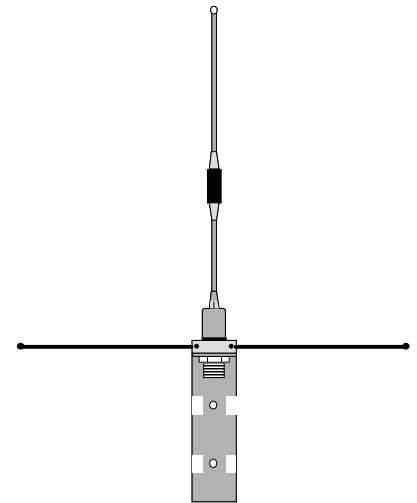

Model AA20

APPENDIX B SPECIFICATIONS

Model 192C & F Antennas

Model No:	AA201C & AA201F
Antenna Type:	Directional, DC grounded, 8 element yagi.
Applications:	Fixed base.
Frequency:	450 to 470 MHz - AA201C 400 to 420 MHz - AA201F
Polarization:	Vertical
Impedance:	50 ohms
Gain:	11 dB
VSWR:	< 1.5
Front To Back Ratio:	23 dB
Horizontal Beamwidth:	42 degrees
Vertical Beamwidth:	50 degrees
Antenna Material:	High strength aluminum painted black.
Mounting Hardware:	Heavy duty U bolts for mounting to ¾ in. to 1 ½ in. pipe with right angle mount or direct panel mount.
Antenna Connector:	UHF Female (SO-239)
Maximum Power Input:	300 Watts
Antenna Envelope:	60 in. length by 15 in. width
Windload (RWV):	100 mph
Wind Load, Flat Plate (Ft₂):	.52
Lateral Thrust @RWV:	14 mph
Bending Moment @RWV:	23 ft. lbs.
Weight:	2 lbs.

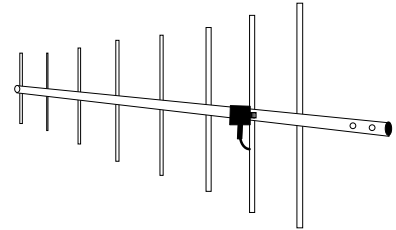

Model 201

Model No:	AA202C & AA202F
Antenna Type:	Directional, DC grounded, 5 element yagi.
Applications:	Fixed base.
Frequency:	450 to 470 MHz - AA202C 400 to 420 MHz - AA202F
Polarization:	Vertical or Horizontal
Impedance:	50 ohms
Gain:	10 dB
VSWR:	< 1.5
Front To Back Ratio:	20 dB
Horizontal Beamwidth:	59 degrees
Vertical Beamwidth:	53 degrees
Antenna Material:	High strength aluminum with gold chromate finish.
Mounting Hardware:	Heavy duty U bolts for mounting up to 2 1/8 in. pipe with right angle mount or direct panel mount.
Antenna Connector:	UHF Female (SO-239)
Maximum Power Input:	300 Watts
Antenna Envelope:	34.5 in. length by 13.25 in. width
Windload (RWV):	100 mph
Weight:	1.68 lbs.

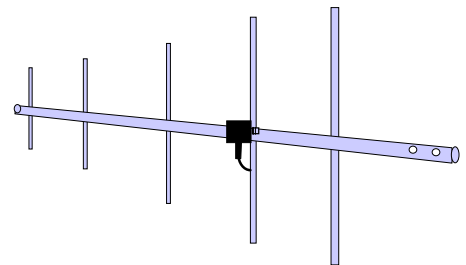

Model 202

APPENDIX B SPECIFICATIONS

Model 192M Antennas

Model No:	AA19M
Antenna Type:	Omni-Directional, 1/2 Wave over 1/4 Wave.
Applications:	Mobile Mount.
Frequency:	150 to 174 MHz
Polarization:	Vertical
Impedance:	50 ohms
Gain:	Unity
VSWR:	< 1.5 to 1
Front To Back Ratio:	n/a
Horizontal Beamwidth:	n/a
Vertical Beamwidth:	60 degrees
Antenna Material:	Rubber duck whip.
Mounting Hardware:	Magnetic base.
Antenna Connector:	TNC with 12 feet integral RG-58 cable.
Antenna Envelope:	11 in. length. Magnetic base 3.5 in. by 3 in. by 1 in.
Weight:	1 lb. 5 oz.

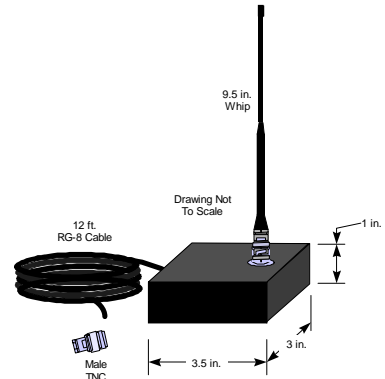

Model 19

Model No:	AA20M
Antenna Type:	Omni-Directional, DC Grounded, 5/8 Wave.
Applications:	Fixed base or mobile mounting. L shaped mounting bracket may be removed for panel mounting. Ground plane radials may be removed depending on application.
Frequency:	150 to 175 MHz
Polarization:	Vertical
Impedance:	50 ohms
Gain:	3.0 dB with ground plane radials
VSWR:	< 1.5
Front To Back Ratio:	n/a
Horizontal Beamwidth:	n/a
Vertical Beamwidth:	60 degrees
Antenna Material:	Stainless steel whip and ground plane radials. All other hardware anodized metal.
Mounting Hardware:	Stainless steel clamps for mounting to .75 in. to 1.5 in. pipe with right angle mount or direct panel mount.
Antenna Connector:	UHF Female (SO-239)
Antenna Envelope:	61 in. length by 43.5 in. width with ground plane radials
Power:	200 watts
Weight:	2 lbs.

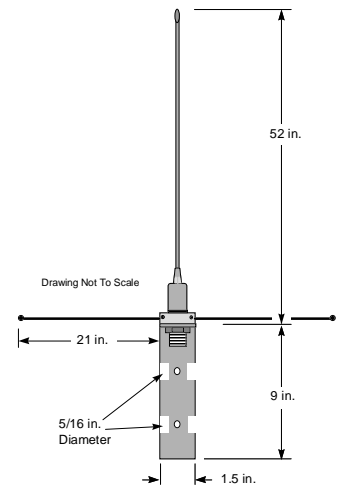

Model 20

APPENDIX B

SPECIFICATIONS

Model 192M Antennas

Applications:	Fixed base mounting.
Antenna Type:	Directional, 3 Element Yagi, DC Ground
Frequency:	150 to 174 MHz
Polarization:	Vertical or Horizontal
Impedance:	50 ohms
Gain:	7.1 dB
VSWR:	< 1.5
Front To Back Ratio:	17 dB
Horizontal Beamwidth:	72 degrees
Vertical Beamwidth:	57 degrees
Antenna Material:	6061-T6 Aluminum
Boom Diameter:	7/8 in. 6061-T6 Aluminum, double wall construction
Mounting Hardware:	Stainless steel U bolts for mounting to 1 5/8 in. diameter pipe.
Antenna Connector:	UHF Female (SO-239)
Maximum Power Input:	500 Watts
Antenna Envelope:	42 in. length by 39 in. width
Windload (RWV):	100 mph
Wind Load, Flat Plate (Ft²):	.36 sq. ft.
Lateral Thrust @ RWV:	14.6 lbs.
Bending Moment @ RWV:	25.3 ft. lbs.
Weight:	3 lbs.



Model 202

APPENDIX C

SPECIFICATIONS

ESTeem Command Error Message Table

Listed below are the ESTeem Command Error Messages and their definitions. To receive these messages, TYPESYSTEM must be ON (See Appendix D, Definitions). All System Status Messages have a bell (O7H or CTRL G) preceding the message except when Messform is ON. If MESSFORM = OFF Line A will be displayed. If MESSFORM = ON Line B will be displayed.

1. A "TOO MANY CHARACTERS FOR
COMMAND"
B EMO1

This message will be displayed if more than the allocated number of characters are typed for a command. This is because some commands are truncated at a length of 8 characters.

2. A "AMBIGUOUS COMMAND"
B EMO2

This is the case of not enough characters being entered to uniquely identify a command.

3. A "INVALID ARGUMENT"
B EM03

This is displayed when a non valid value is given to a Command. Example; a value of O cannot be given to FRACK because the only valid values are 1-255.

APPENDIX C

SPECIFICATIONS

ESTeem System Status Message Table

Listed below are the ESTeem System Status Messages and their definitions. To receive these messages, TYPESYSTEM must be ON (See APPENDIX D, DEFINITIONS). All System Status Messages have a bell (O7H or CTRL G) preceding the message except when Messform is ON. If Messform = OFF Line A will be displayed. If Messform = ON Line B will be displayed.

1. A "CONNECTED TO XX"
B SSO1-xx

This message is caused by either receiving a reply from a Log On Packet, receiving a Log On Packet, or by typing LINK when connected and in the COMMAND MODE. XX is the address of the modem connected to.

2. A "DISCONNECTED FROM XX"
B SSO2-xx

Tells that you have been disconnected from the device you were originally connected to (xx is unit address).

3. A "LINK DOWN"
B SSO3

This message occurs after sending the last retry data packet and receiving no response from the destination node. This message usually indicates a hard failure -i.e. destination node not energized, wrong baud rate, (not compatible between units) improper transmit/receive frequency between nodes, etc.

4. A "CURRENTLY NOT CONNECTED!"
B SSO4

The Disconnect was issued while the modem was not connected to another modem or when LINK is typed in the COMMAND MODE when you are not connected.

This message is displayed when the modem is configured in the monitor mode.

5. A "FAILED TO CONNECT!"
B SSO5

This message occurs if the modem fails to connect.

6. A "FAILED TO DISCONNECT!"
B SS06

This message occurs if the modems are connected and are unable to disconnect.

7. A "USING FACTORY DEFAULTS"
B SS07

This command states when factory defaults have been enabled.

8. A "REMOTE PROGRAMMING"
B SS08

This message is displayed when the ESTeem has been placed in the remote programming mode.

9. A "PHONE MODEM CONNECTED.
INFRARED PORT DISABLED"
B SS09

This message is displayed when the ESTeem phone port has received an in-coming call.

10. A "PHONE MODEM DISCONNECTED.
INFRARED PORT ENABLED"
B SS10

This message is displayed when the ESTeem port has been disconnected.

APPENDIX C

SPECIFICATIONS

ESTeem System Error Message Table

Listed below are the ESTeem System Error Messages and their definitions. To receive these messages, TYPYSYSTEM must be ON (See APPENDIX D, DEFINITIONS). All System Status Messages have a bell (O7H or CTRL G) preceding the message except when Messform is ON. If Messform = OFF Line A will be displayed. If Messform = ON Line B will be displayed.

1. A "NOVRAM FAILED"
B SEO1

If this response is received after a save, there is a hardware problem with the ESTeem's NOVRAM Circuitry.

2. A "ROM FAILED"
B SEO2

If this response is received after a save, there is a hardware problem with the ESTeem's ROM Circuitry.

APPENDIX D

SOFTWARE COMMANDS

Factory Default Setting

Listed below is a listing of the ESTeem software commands and their Factory Default settings.

HELP CONTROL

APPENDRU = 255
CONNECT
CONVERS
DISCONN
FACTORY
FLASH
HELP
MULTID = OFF
PACKMON = OFF
PHONE = OFF
RADIO = OFF
RESET
ROUTE = 0
RESTORE = 0
SAVE
TRANSPAR = OFF

HELP RS-232

AUTOLF = ON
BLOCK = OFF
COMRATE
DTR_ENAB = OFF
ECHO = ON
MODECONT = OFF
XHFLOW = OFF
XSFLOW = ON

HELP SETUP

ADDRESS = 1
COMMAND = 3
EDIT = ON
MESSFORM = OFF
NETWORK = 37
PACKLENG = 2000
PROMPT = ON
RETRY = 6
SENDPAC = 13
SETCON = 2
TERMCONT = OFF
TERMTIME = 50
TYPERROR = OFF
TYPYSYSTE = ON

HELP SYSTEM

COPRIGHT
DISACK = OFF
MODEL = 19C
POLLED = OFF
PROGRAM = 0
REMPROG = ON
SECURITY = OFF
S/N = 0
TXSTAT
VERSION = 1.46

HELP PLC

A_BCTRL = OFF
GE_CTRL = OFF
MODCTRL = OFF
OPTO = OFF
PLC_MAST = OFF
SQDADD = 0
SQDCTRL = OFF

HELP RADIO

CARBSY = 1
DQ = OFF
FRACK = 50
LAT
MODULATE = ON
RANDOM = OFF
RFPOWER
RFCYCLES = 10
RXDATA = 1
RXEND = 1
RXSIGNAL = OFF
SEL/A1 = 12
SEL/N1 = 42112
SEL/N2 = 0
SQUELCH = 0

APPENDIX D

SOFTWARE COMMANDS

Definitions

Listed below in alphabetical order are the definitions of the ESTeem software commands.

A_BCTRL

This function enables the Allen Bradley controller protocol. For further details reference the EST Engineering Report on Allen Bradley controller interfacing.

ON: Enabled.
OFF: Disabled.

Factory default = OFF.

ADDRESS (1-255)

The command defines the ESTeem source address. The default value is whatever address has been stored in nonvolatile memory. Addresses 1 to 254 are usable for unit addressing. Address 255 is used for GLOBAL.

APPENDru (l#,r#,a1,a2,g)

The APPENDru command appends routes to a connect address that are defined by the ROUTE command.

l # = Location of route number in memory. Address locations 1 to 16.
r # = Appended route number. Route numbers 1 to 16.
a1 = Address of first destination node. Address numbers from 1 to 254.
a2 = Address of last destination node. . Address numbers from 1 to 254.
g = Group feature is enabled by inserting a 1 in this field.

Factory default = 0. APPENDru 0 disables this feature.

Note: *This command is used in conjunction with the ROUTE Command.*

AUtof (on/off)

This command enables the auto line feed sent to the terminal after each carriage return.

ON: Enabled.
OFF: Disabled.

Factory default = ON.

BLOCK (on/off)

The BLOCK command, when enabled, disables the RS-232C/422/485 communications port from receiving or outputting data.

ON: Enabled.
OFF: Disabled.

Factory default = OFF.

CARbsy (0-255)

This command defines the carrier busy delay in milliseconds. A value of 0 will disable the carrier busy delay. Factory default = 1.

COMMAND (0-255)

This command specifies the value (in decimal) of an ASCII character used to return the ESTeem to COMMAND MODE. If the COMMAND character is read by the ESTeem when in the CONVERSE MODE, the modem will exit to the COMMAND MODE. A value of 0 in this command will disable the function. Factory default = \$03 (Hex) or CTRL-C.

COMRate (0-255)

This command defines the RS-232/422/485 configuration when Switch 1 on the RS-232 Setup Switches is engaged. See Chapter 5 for table.

CONNECT (r1,r2,r3,da)

This command performs the CONNECT to a destination ESTeem. This function supports a direct connect or a connect through a maximum of three repeater nodes. The default value is whatever address has been stored by the SETCon COMMAND.

r1 = ESTeem address (1 to 254) of repeater 1.
r2 = ESTeem address (1 to 254) of repeater 2.
r3 = ESTeem address (1 to 254) of repeater 3.
da = Destination address (1 to 254).

CONVers

The execution of this command causes an immediate exit from COMMAND MODE into CONVERSE MODE.

APPENDIX D

SOFTWARE COMMANDS

Definitions

Listed below in alphabetical order are the definitions of the ESTeem software commands.

COPright

The execution of this command causes the copyright information to be printed.

DISACK (on/off)

This command when enabled instructs the modem to disable the acknowledgment request on the information packet. This is used when the designation device will respond with its own acknowledgment.

Factory default = OFF.

DISCONnect (1-254)

The disconnect command. The execution of this command immediately initiates a disconnect request with the currently connected node or in a multi-connect environment only a specific node may be addressed.

DTR_enab (on/off)

The DTR enable command. This command, when enabled, allows the ESTeem modem to monitor pin 20 of the RS-232C connector in regards to the status of an external device connected to it.

ON: Enables monitoring the DTR signal on pin 20 of the RS-232C connector. If DTR is at a space condition, then the modem is enabled. If DTR is at a mark condition, then the ESTeem modem will be disabled. The normal operation of this line is for the ESTeem modem to have status on the external device, out-putting to pin 20. This line can act as a status to the ESTeem when the external device is ready to transmit or receive data.

OFF: Disabled

Factory default = OFF.

Note: *If the DTR command is enabled and the line is disabled then the ESTeem will perform a "Disconnect" if connected. The DTR Command will also activate the Data Carrier Detect (DCD) Line (Pin 8) to toggle High when connected and Low when disconnected.*

ECHO (on/off)

This command enables the ESTeem to echo characters received from the input device back to the input device.

ON: Enabled.
OFF: Disabled.

Factory default = ON.

EDit (on/off)

This command enables the EDIT functions from the CONVERSE Mode.

Factory default = ON.

Factory

The factory default command. The execution of this command causes the ESTeem to restore the command table values from factory values that are stored permanently in memory. This will allow the user the ability to restore the ESTeem to factory conditions during testing or set-up.

FLASH

This command places the ESTeem in Flash mode for reprogramming of the operation system.

FRAck (1-255)

This command programs the frame acknowledge delay in milliseconds. This value is used as a minimum time before decrementing the retry count and retransmitting a packet if the retry count is not zero.

Factory default = 50.

GE_CTRL

This command enables the General Electric controller protocol. For further information please reference the EST Engineering Report on General Electric controller interfacing.

ON: Enabled.
OFF: Disabled.

Factory default = OFF.

APPENDIX D

SOFTWARE COMMANDS

Definitions

Listed below in alphabetical order are the definitions of the ESTeem software commands.

HElp

HELP switches are:

HELP	Displays this Help menu.
HELP ALL	Displays All commands switches and arguments.
HELP CHANGE	Displays only the commands that are changed from factory default.
HELP CONTROL	Displays Control commands switches and arguments.
HELP PLC	Displays PLC commands switches and arguments.
HELP RADIO	Displays Radio commands switches and arguments.
HELP RS-232	Displays RS232 commands switches and arguments.
HELP SETUP	Displays Setup commands switches and arguments.
HELP SYSTEM	Displays System commands switches and arguments.

JOHNctrl (on/off)

This function enables the Johnson controller protocol. For further detail Reference the EST Engineering Report on Johnson controller interfacing.

ON: Enabled.
OFF: Disabled.

Factory default = OFF.

LAT

Latches the selection of the desired serial frequency synthesizer on the Tx/Rx card

MESSform (on/off)

When enabled all of the system status and error messages will be in a formatted form.

"**xx**" indicates what error or message (See Error Messages and System Status Messages).

EMxx <CR>	[ESTeem Error Messages]
SExx <CR>	[System Error Messages]
SSxx <CR>	[System Status Messages]
SSxx-xxxx <CR>	[System Status Message W/Returned Value]

ON: Enabled.
OFF: Disabled.

Factory default = OFF.

MOdecontr (on/off)

ON: The mode of the ESTeem modem is controlled by pin 19 of the RS-232C connector. A low (0) directs the ESTeem into the COMMAND mode. A high (1) directs the ESTeem into CONVERSE/TRANSPARENT mode.

OFF: The mode of the ESTeem modem is controlled by ASCII character.

Factory default = OFF

MODEL (xx)

Displays the product model of default firmware that is installed. Model should be the same as product being used. Listed below are the model codes

19C = ESTeem Model 192C
19F = ESTeem Model 192F
19V = ESTeem Model 192V

MODCTRL

This command enables the Modicon controller protocol. For further detail Reference the EST Engineering Report on Modicon controller interfacing.

OFF: Disabled.

Factory default = OFF.

APPENDIX D

SOFTWARE COMMANDS

Definitions

Listed below in alphabetical order are the definitions of the ESTeem software commands.

MODUlate (on/off)

The radio modulate command. When enabled will transmit a modulated test signal when the RADIO ON command is enabled.

ON: Enabled.
OFF: Disabled.

Factory default = OFF.

MOORE (on/off)

This function enables the Moore products using Hart protocol. For further details reference the EST Engineering Report on Moore Products interfacing.

ON: Enabled.
OFF: Disabled.

Factory default = OFF.

MULTID (on/off)

This command when enabled allows the ESTeem User to send data to another ESTeem from the CONVERSE MODE by specifying the routing address before the data.

ON: Enabled.
OFF: Disabled.

Factory default = OFF.

Example Of Transmitted Data:

[001]DATA Routes data to an ESTeem addressed 1.

[100,200,250,1]DATA Routes data to an ESTeem addressed 1 via ESTeems addressed 100, 200, and 250.

This replaces using the CONNECT command from the COMMAND Mode. Received data packets will have the address of the ESTeem that sent the data at the beginning of the data packet.

Example Of Received Data:

[004]RECEIVED DATA Data received from an ESTeem addressed 4.

[030,100,244,004] Data received from an ESTeem addressed 4 via ESTeems addressed 30, 100, and 244.

NETwork (0-255)

Network identification code. This is used to program a common code for all modems in the customers network so that another facility on your frequency using the same addresses will not interfere with your equipment. Factory default = 37.

OPTO (on/off)

This function enables the Opto 22 protocol. For further details reference the EST Engineering Report on Opto 22 interfacing.

ON: Enabled.
OFF: Disabled.

Factory default = OFF.

PACKleng (1-2000)

This command defines the length of the data packet in bytes. Factory default = 2000.

PACKMon (on/off)

Places the ESTeem in the packet monitor mode. Factory default = OFF.

PHone (on/off)

Phone port enable command. The ESTeem will answer an incoming call when enabled.

ON: Enabled.
OFF: Disabled.

Factory default = OFF.

APPENDIX D

SOFTWARE COMMANDS

Definitions

Listed below in alphabetical order are the definitions of the ESTeem software commands.

PLC_MAST (on/off)

The programmable logic controller (PLC) command.

- ON: When enabled, the ESTeem modem will identify the desired route from the master PLC message. The ESTeem modem will only identify the PLC master route if the master command is enabled in the PLC.
- OFF: The ESTeem modem will be configured as to interface to a slave PLC.

Factory default = OFF.

POLLed (on/off)

When enabled the ESTeem will only transmit the contents of its internal transmit buffer when it receives an ENQ (hex 5) from a polling ESTeem. During non polled times the ESTeem transmit buffer will be continuously updated from data being received by the

RS-232C/422 port. This software feature was developed for interfacing the ESTeem to output devices without flow control that are to be polled from a master device.

- ON: Enabled will transmit the contents of its transmit buffer when a ENQ (hex 5) is received.
- OFF: Disabled.

Factory default = OFF.

PROGram (1-254,1-254,1-254,1-254)

This command is used to remote program another ESTeem unit. Example PROG 10 (Unit 10 is the address of the remote unit). When a connection has been made with the remote ESTeem the RPG: prompt will appear. The RPG: prompt is the command prompt of the remote modem.

Note: See *REMPROG Command*.

PROMpt (on/off)

The prompt enable command.

- ON: The prompt responses are enabled. These are the prompts for Converse or Trans Mode that are normally output from the RS-232C serial port by the ESTeem.
- OFF: Disabled.
- Factory default = ON.

RADio (on/off)

The radio transmitter enable command. The ESTeem radio transmitter will cycle on and off when enabled for tuning and antenna testing procedures.

- ON: Enabled.
- OFF: Disabled.

Factory default = OFF.

RANdom (on/off)

The RANDOM command when enabled will generate a simulated random data output when the RADIO ON command is enabled

- ON: Enabled.
- OFF: Disabled.

Factory default = OFF.

REMprog (on/off)

This command will disable the ESTeem from being remotely programmed by any another ESTeem.

- ON: Enabled.
- OFF: Disabled.

Factory default = ON.

RESet

The software reset command for the ESTeem. The execution of this command resets the internal electronics in the ESTeem.

RESTore

The restore command. The execution of this command restores the ESTeem command variables and switches configurations stored in nonvolatile memory.

RETry (1-255)

The retry command number. This is the number specifying the number of retries, retransmission of frames, that are not acknowledged. Frames are retransmitted RETRY times before operation is aborted. Factory default = 6.

APPENDIX D

SOFTWARE COMMANDS

Definitions

Listed below in alphabetical order are the definitions of the ESTeem software commands.

RFcycles

This command defines the number of cycles the ESTeem will transmit when programmed with the RADIO COMMAND.

Factory default = 10.

RFPower (0-255)

This command sets the output RF power of the ESTeem. These values are calculated and tested at the factory and should not be adjusted without consulting calling Customer Support at 509-735-9092.

Caution: *Improper adjustment of this value can cause damage to the ESTeem transmitter.*

ROUTE (I#,r1,r2,r3,)

The ROUTE sets up the route table in the ESTeem.

- I # = User defined route number. Route numbers 1 to 16 may be used.
- r1 = Address of first repeater. Address numbers from 1 to 254 may be used.
- r2 = Address of second repeater. Address numbers from 1 to 254 may be used.
- r3 = Address of third repeater. Address numbers from 1 to 254 may be used.

Note: See APPENDRU Command.

Factory default = 0.

RXData (1-255)

This command defines the time (milliseconds) the receiver waits after a carrier detect before starting the receive sequence. This value is optimized at the factory and should not be changed.

Factory default = 1.

RXEnd (1-255)

This command defines the time (milliseconds) to wait after the last character is received before reinitializing the receiver.

Factory default = 1.

RXSIGNAL (on/off)

This command enables the signal to noise ratio meter output. Output level varies from 0 to 248 (248 being the highest reading).

- ON: Enabled.
- OFF: Disabled.

Factory default = OFF.

SAve

The save command. The execution of this command stores the current command values and switches.

Note: *Please wait approximately two seconds after executing the SAVE command before turning off power to the ESTeem.*

SECURITY (off or 1- 100000)

The security command disables programming the ESTeem.

1 to 100000 This feature is enabled when you enter a number from 1 to 100000. When enabled the ESTeem will return a Security ON message. To disable security enter SECURITY xxxxxx. xxxxxx = your predefined security number. When disabled the ESTeem will return a Security Off message.

OFF Security disabled.

Factory default = OFF.

SENDPACK (0-255)

Send packet (SENDPACK) command. The value specifies an ASCII character used to signal when to send the packet. If set to a value of 255 the command is disabled. The factory default value is 13 (Return).

SEL/A1 (1-255)

The SEL/A1 command sets the transceiver for a specific frequency.

SEL/N1 (1-56635)

The SEL/A1 command sets the transceiver for a specific frequency.

APPENDIX D

SOFTWARE COMMANDS

Definitions

Listed below in alphabetical order are the definitions of the ESTeem software commands.

SEL/N2 (1-999)

The SEL/N2 command sets the transceiver for a specific frequency.

SETCon (r1,r2,r3,da)

This command defines the destination address for the ESTeem to perform a connect using the Auto Connect feature. This function supports a direct connect or a connect through a maximum of three repeaters.
r1 = ESTeem address (1 to 254) of repeater 1.
r2 = ESTeem address (1 to 254) of repeater 2.
r3 = ESTeem address (1 to 254) of repeater 3.
da = Destination address (1 to 254).

S/N

Serial Number command. When executed from the Command Model will output the ESTeem serial number of the unit that is defined at the time of manufacturer.

SQDCTRL (on/off)

This function enables the Square D controller protocol. For further detail Reference the EST Engineering Report on Square D controller interfacing.

Factory default = OFF.

SQDADD (1-254)

This function is used with the SQDCTRL command to control the address fence when using SQ-D Network Interface Modules. For further details reference the EST Engineering Report on the SQ-D controller.

Factory default = 0.

SQUELCH (0-3)

This command defines the squelch threshold of the receiver. Listed below are the settings:

0	=	-101 dBm	2 μ V
1	=	- 93 dBm	5 μ V
2	=	- 87 dBm	10 μ V
3	=	- 70 dBm	70 μ V

Factory default = 0.

TERMCont (on/off)

The RS-232C/422/485 receive termination timer.

ON: If there are characters in the RS-232 buffer and the modem is in Converse Mode, the termination timer starts from the time the last receive character is updated in the buffer. If the termination time expires before another character is received, the characters are transmitted.

OFF: Disabled

Factory default = OFF.

TERMTime (10-65535)

The RS-232C/422/485 receive termination timer value. This value can be 10 to 65535 milliseconds. This value is enabled by TERMCONT. Factory default = 50.

TRANSPAR (on/off)

The transparent mode command. This mode allows the ESTeem link to be completely transparent to the communicating RS-232/422/485 devices. Reference Chapter 2.

ON: Enabled.

OFF: Disabled.

Factory default = OFF.

TXSTAT

This command outputs the total number of rf transmissions vs. the total number of retries. After output is completed, the counter is zeroed.

TYPerr (on/off)

This command enables the Communication Error Messages.

ON: Enabled.

OFF: Disabled.

Factory default = OFF.

APPENDIX D

SOFTWARECOMMANDS

Definitions

Listed below in alphabetical order are the definitions of the ESTeem software commands.

TYPSystem (on/off)

This command enables the System and Error Message Commands.

ON: Enabled.

OFF: Disabled.

Factory default = ON.

VERSION

This command will display the current software version being used by the ESTeem.

XHflow (on/off)

This command enables hardware flow control.

ON: Enabled.

OFF: Disabled.

Factory default = OFF.

XSflow (on/off)

This command enables software flow control.

ON: Enabled.

OFF: Disabled.

Factory default = ON.