



中认信通

CHINA CERTIFICATION ICT CO., LTD (DONGGUAN)



TEST REPORT

Applicant: SDI Technologies Inc.

Address: 1299 Main Street Rahway New Jersey 07065 United States

FCC ID: EMOIW23B

Product Name: Compact Clock with Wireless Charging and Auto-Dimming Acrylic Display

**Standard(s): 47 CFR Part 15, Subpart C
ANSI C63.10-2013**

The above device has been tested and found compliant with the requirement of the relative standards by China Certification ICT Co., Ltd (Dongguan)

Report Number: CR231274927-00B

Date Of Issue: 2024/1/10

Reviewed By: Calvin Chen

Calvin Chen

Title: RF Engineer

Approved By: Sun Zhong

Sun Zhong

Title: Manager

Test Laboratory: China Certification ICT Co., Ltd (Dongguan)

No. 113, Pingkang Road, Dalang Town, Dongguan,

Guangdong, China

Tel: +86-769-82016888

Test Facility

The Test site used by China Certification ICT Co., Ltd (Dongguan) to collect test data is located on the No. 113, Pingkang Road, Dalang Town, Dongguan, Guangdong, China.

The lab has been recognized as the FCC accredited lab under the KDB 974614 D01 and is listed in the FCC Public Access Link (PAL) database, FCC Registration No. : 442868, the FCC Designation No. : CN1314.

The lab has been recognized by Innovation, Science and Economic Development Canada to test to Canadian radio equipment requirements, the CAB identifier: CN0123.

Declarations

China Certification ICT Co., Ltd (Dongguan) is not responsible for the authenticity of any test data provided by the applicant. Data included from the applicant that may affect test results are marked with a triangle symbol “▲”. Customer model name, addresses, names, trademarks etc. are not considered data.

Unless otherwise stated the results shown in this test report refer only to the sample(s) tested.

This report cannot be reproduced except in full, without prior written approval of the Company.

This report is valid only with a valid digital signature. The digital signature may be available only under the Adobe software above version 7.0.

This report may contain data that are not covered by the accreditation scope and shall be marked with an asterisk “★”.

CONTENTS

DOCUMENT REVISION HISTORY	4
1. GENERAL INFORMATION.....	5
1.1 PRODUCT DESCRIPTION FOR EQUIPMENT UNDER TEST (EUT)	5
1.2 DESCRIPTION OF TEST CONFIGURATION	6
1.2.1 EUT Operation Condition:.....	6
1.2.2 Support Equipment List and Details	6
1.2.3 Support Cable List and Details	6
1.2.4 Block Diagram of Test Setup.....	7
1.3 MEASUREMENT UNCERTAINTY	8
2. SUMMARY OF TEST RESULTS	9
3. REQUIREMENTS AND TEST PROCEDURES	10
3.1 AC LINE CONDUCTED EMISSIONS	10
3.1.1 Applicable Standard.....	10
3.1.2 EUT Setup.....	11
3.1.3 EMI Test Receiver Setup	11
3.1.4 Test Procedure	12
3.1.5 Corrected Amplitude & Margin Calculation.....	12
3.2 RADIATION SPURIOUS EMISSIONS	13
3.2.1 Applicable Standard.....	13
3.2.2 EUT Setup.....	13
3.2.3 EMI Test Receiver & Spectrum Analyzer Setup	14
3.2.4 Corrected Amplitude & Margin Calculation.....	14
3.3 20 DB EMISSION BANDWIDTH:	15
3.3.1 Applicable Standard.....	15
3.3.2 EUT Setup.....	15
3.3.3 Test Procedure	15
3.4 ANTENNA REQUIREMENT.....	16
3.4.1 Applicable Standard.....	16
3.4.2 Judgment.....	16
4. TEST DATA AND RESULTS.....	17
4.1 AC LINE CONDUCTED EMISSIONS	17
4.2 RADIATION SPURIOUS EMISSIONS	20
4.3 20 DB EMISSION BANDWIDTH	29
5 MAXIMUM PERMISSIBLE EXPOSURE (MPE)	31
5.1 APPLICABLE STANDARD.....	31
5.2 BLOCK DIAGRAM OF TEST SETUP	31
5.3 TEST PROCEDURES	32
5.3 TEST DATA:	33
6. EUT PHOTOGRAPHS	34
7. TEST SETUP PHOTOGRAPHS	35

DOCUMENT REVISION HISTORY

Revision Number	Report Number	Description of Revision	Date of Revision
1.0	CR231274927-00B	Original Report	2024/1/10

1. GENERAL INFORMATION

1.1 Product Description for Equipment under Test (EUT)

EUT Name:	Compact Clock with Wireless Charging and Auto-Dimming Acrylic Display
EUT Model:	iW23BG.EXv24
Multiple Model(s):	iW23, iW23X
Operation Frequency:	131.451 kHz
Rated Input Voltage:	DC 12V From Adapter
Wireless Output:	5/7.5/9/15 Watts
Serial Number:	2F4F-4
EUT Received Date:	2023/12/29
EUT Received Status:	Good

Note: The Multiple models are electrically identical with the test model. Please refer to the declaration letter for more detail, which was provided by manufacturer.

Antenna Information Detail ▲:

Antenna Type	input impedance (Ohm)	Frequency Range	Antenna Gain
Coil	Unknown	Unknown	Unknown

The Method of §15.203 Compliance:

- Antenna was permanently attached to the unit.
- Antenna use a unique type of connector to attach to the EUT.
- Unit professionally installed, and installer shall be responsible for verifying that the correct antenna is employed with the unit.

Accessory Information:

Accessory Description	Manufacturer	Model
Adapter	Shenzhen Guijin Technology Co.,Ltd.	GJ30WD-1200300U

1.2 Description of Test Configuration

1.2.1 EUT Operation Condition:

EUT Operation Mode:	The system was configured for testing in Engineering Mode, which was provided by the manufacturer. Per-scan no load, half load, full load, the worst case mode as below: Test Mode: Full load(Wireless output(15W)+Type C output(5W)+USB output(5W))
Equipment Modifications:	No
EUT Exercise Software:	No
Engineering Mode was provided by manufacturer▲. The maximum power was configured default setting.	

1.2.2 Support Equipment List and Details

Manufacturer	Description	Model	Serial Number
Unknown	Load 1	Unknown	Unknown
Unknown	Load 2	Unknown	Unknown
SiLiYuan	Wireless Charging Load	MX15W	211013003

1.2.3 Support Cable List and Details

Cable Description	Shielding Type	Ferrite Core	Length (m)	From Port	To
Power Cable	No	No	1.5	EUT	Adapter
USB Cable	No	No	0.5	EUT	Load 1
USB Cable	No	No	0.5	EUT	Load 2

1.2.4 Block Diagram of Test Setup

AC line conducted emissions:

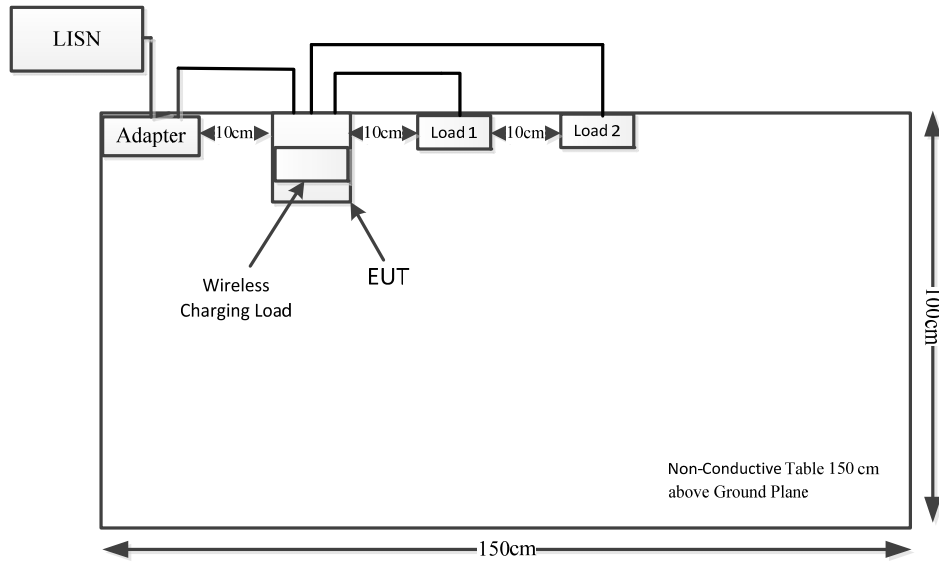

Radiated Emission:

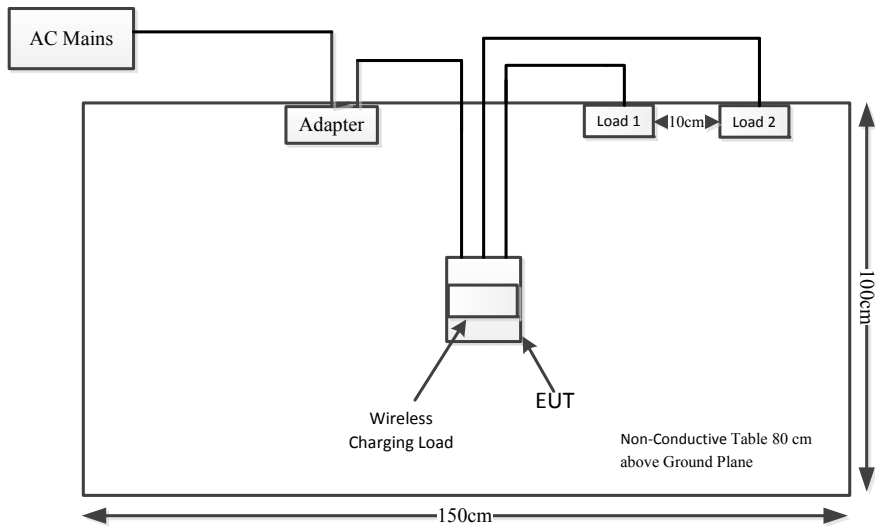

1.3 Measurement Uncertainty

Otherwise required by the applicant or Product Regulations, Decision Rule in this report did not consider the uncertainty. The extended uncertainty given in this report is obtained by combining the standard uncertainty times the coverage factor K with the 95% confidence interval.

Parameter	Measurement Uncertainty
radiated Emissions	9kHz~30MHz: 4.12dB 30M~200MHz: 4.15 dB,200M~1GHz: 5.61 dB,1G~6GHz: 5.14 dB, 6G~18GHz: 5.93 dB,18G~26.5G:5.47 dB,26.5G~40G:5.63 dB
Temperature	±1℃
Humidity	±5%
DC and low frequency voltages	±0.4%
Duty Cycle	1%
AC Power Lines Conducted Emission	2.8 dB (150 kHz to 30 MHz)

2. SUMMARY OF TEST RESULTS

Standard(s) Section	Description of Test	Result
FCC§15.207	AC Line Conducted Emission	Compliant
FCC§15.209 §15.205	Radiated Emission Test	Compliant
FCC§15.215	20 dB Emission Bandwidth	Compliant
FCC§15.203	Antenna Requirement	Compliant
FCC§1.1310 §2.1091	Maximum Permissible Exposure (MPE)	Compliant

3. REQUIREMENTS AND TEST PROCEDURES

3.1 AC Line Conducted Emissions

3.1.1 Applicable Standard

FCC§15.207(a).

(a) Except as shown in paragraphs (b) and (c) of this section, for an intentional radiator that is designed to be connected to the public utility (AC) power line, the radio frequency voltage that is conducted back onto the AC power line on any frequency or frequencies, within the band 150 kHz to 30 MHz, shall not exceed the limits in the following table, as measured using a 50 μ H/50 ohms line impedance stabilization network (LISN). Compliance with the provisions of this paragraph shall be based on the measurement of the radio frequency voltage between each power line and ground at the power terminal. The lower limit applies at the boundary between the frequency ranges.

Frequency of emission (MHz)	Conducted limit (dB μ V)	
	Quasi-peak	Average
0.15-0.5	66 to 56*	56 to 46*
0.5-5	56	46
5-30	60	50

*Decreases with the logarithm of the frequency.

(b) The limit shown in paragraph (a) of this section shall not apply to carrier current systems operating as intentional radiators on frequencies below 30 MHz. In lieu thereof, these carrier current systems shall be subject to the following standards:

(1) For carrier current system containing their fundamental emission within the frequency band 535-1705 kHz and intended to be received using a standard AM broadcast receiver: no limit on conducted emissions.

(2) For all other carrier current systems: 1000 μ V within the frequency band 535-1705 kHz, as measured using a 50 μ H/50 ohms LISN.

(3) Carrier current systems operating below 30 MHz are also subject to the radiated emission limits in §15.205, §15.209, §15.221, §15.223, or §15.227, as appropriate.

(c) Measurements to demonstrate compliance with the conducted limits are not required for devices which only employ battery power for operation and which do not operate from the AC power lines or contain provisions for operation while connected to the AC power lines. Devices that include, or make provisions for, the use of battery chargers which permit operating while charging, AC adapters or battery eliminators or that connect to the AC power lines indirectly, obtaining their power through another device which is connected to the AC power lines, shall be tested to demonstrate compliance with the conducted limits.

3.1.2 EUT Setup

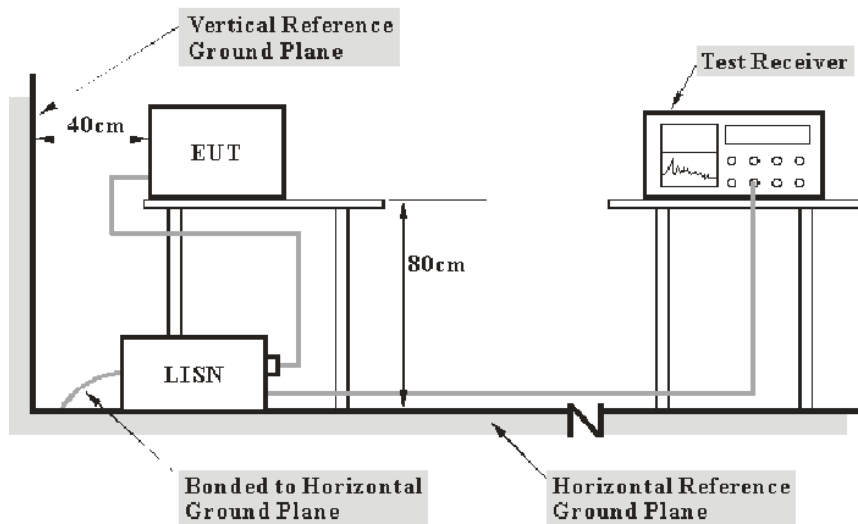

- Note: 1. Support units were connected to second LISN.
 2. Both of LISNs (AMN) 80 cm from EUT and at the least 80 cm from other units and other metal planes support units.

The setup of EUT is according with per ANSI C63.10-2013 measurement procedure. The specification used was with the FCC Part 15.207 limits.

The spacing between the peripherals was 10 cm.

3.1.3 EMI Test Receiver Setup

The EMI test receiver was set to investigate the spectrum from 150 kHz to 30 MHz.

During the conducted emission test, the EMI test receiver was set with the following configurations:

Frequency Range	IF B/W
150 kHz – 30 MHz	9 kHz

3.1.4 Test Procedure

The frequency and amplitude of the six highest ac power-line conducted emissions relative to the limit, measured over all the current-carrying conductors of the EUT power cords, and the operating frequency or frequency to which the EUT is tuned (if appropriate), should be reported, unless such emissions are more than 20 dB below the limit. AC power-line conducted emissions measurements are to be separately carried out only on each of the phase (“hot”) line(s) and (if used) on the neutral line(s), but not on the ground [protective earth] line(s). If less than six emission frequencies are within 20 dB of the limit, then the noise level of the measuring instrument at representative frequencies should be reported. The specific conductor of the power-line cord for each of the reported emissions should be identified. Measure the six highest emissions with respect to the limit on each current-carrying conductor of each power cord associated with the EUT (but not the power cords of associated or peripheral equipment that are part of the test configuration). Then, report the six highest emissions with respect to the limit from among all the measurements identifying the frequency and specific current-carrying conductor identified with the emission. The six highest emissions should be reported for each of the current-carrying conductors, or the six highest emissions may be reported over all the current-carrying conductors.

3.1.5 Corrected Amplitude & Margin Calculation

The basic equation is as follows:

$$\text{Result} = \text{Reading} + \text{Factor}$$

$$\text{Factor} = \text{attenuation caused by cable loss} + \text{voltage division factor of AMN}$$

The “**Margin**” column of the following data tables indicates the degree of compliance within the applicable limit. The equation for margin calculation is as follows:

$$\text{Margin} = \text{Limit} - \text{Result}$$

3.2 Radiation Spurious Emissions

3.2.1 Applicable Standard

FCC §15.209

(a) Except as provided elsewhere in this subpart, the emissions from an intentional radiator shall not exceed the field strength levels specified in the following table:

Frequency (MHz)	Field strength (microvolts/meter)	Measurement distance (meters)
0.009-0.490	2400/F(kHz)	300
0.490-1.705	24000/F(kHz)	30
1.705-30.0	30	30
30-88	100**	3
88-216	150**	3
216-960	200**	3
Above 960	500	3

**Except as provided in paragraph (g), fundamental emissions from intentional radiators operating under this section shall not be located in the frequency bands 54-72 MHz, 76-88 MHz, 174-216 MHz or 470-806 MHz. However, operation within these frequency bands is permitted under other sections of this part, e.g., §§15.231 and 15.241.

3.2.2 EUT Setup

9kHz-30MHz:

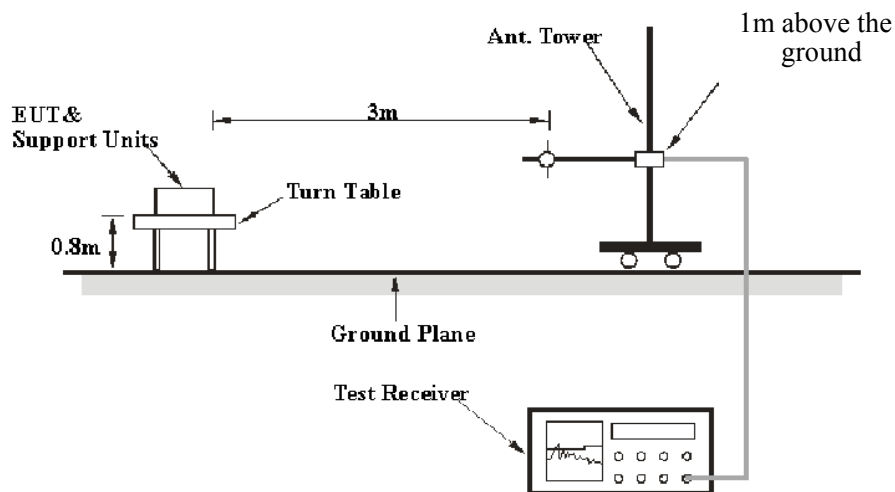

30MHz-1GHz:

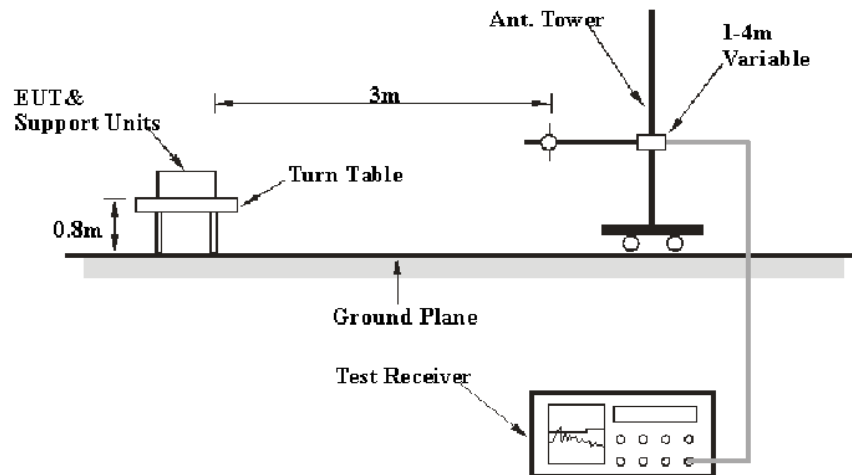

The radiated emission tests were performed in the 3-meter chamber test site, using the setup accordance with the ANSI C63.10-2013. The specification used was the FCC 15.209 limits.

The spacing between the peripherals was 10 cm.

For 9kHz-30MHz test, the lowest height of the magnetic antenna shall be 1 m above the ground and three antenna orientations (parallel, perpendicular, and ground-parallel) shall be measured.

3.2.3 EMI Test Receiver & Spectrum Analyzer Setup

The system was investigated from 9 kHz to 1 GHz.

During the radiated emission test, the EMI test Receiver was set with the following configurations:

Frequency Range	RBW	Video B/W	Measurement
9 kHz – 150 kHz	200 Hz	1 kHz	QP/Average
150 kHz – 30 MHz	9 kHz	30 kHz	QP/Average
30 MHz – 1000 MHz	120 kHz	300 kHz	QP

The emission limits shown in the above table are based on measurements employing a CISPR quasi-peak detector except for the frequency bands 9-90 kHz, 110-490 kHz and above 1000 MHz. Radiated emission limits in these three bands are based on measurements employing an average detector.

If the maximized peak measured value complies with the limit, then it is unnecessary to perform an QP/Average measurement

3.2.4 Corrected Amplitude & Margin Calculation

The basic equation is as follows:

Result = Reading + Factor

Factor = Antenna Factor + Cable Loss- Amplifier Gain

The “**Margin**” column of the following data tables indicates the degree of compliance within the applicable limit. The equation for margin calculation is as follows:

Margin = Limit – Result

3.3 20 dB Emission Bandwidth:

3.3.1 Applicable Standard

FCC §15.215

Intentional radiators operating under the alternative provisions to the general emission limits, as contained in §15.217 through § 15.257 and in Subpart E of this part, must be designed to ensure that the 20 dB bandwidth of the emission, or whatever bandwidth may otherwise be specified in the specific rule section under which the equipment operates, is contained within the frequency band designated in the rule section under which the equipment is operated. The requirement to contain the designated bandwidth of the emission within the specified frequency band includes the effects from frequency sweeping, frequency hopping and other modulation techniques that may be employed as well as the frequency stability of the transmitter over expected variations in temperature and supply voltage. If a frequency stability is not specified in the regulations, it is recommended that the fundamental emission be kept within at least the central 80% of the permitted band in order to minimize the possibility of out-of band operation.

3.3.2 EUT Setup

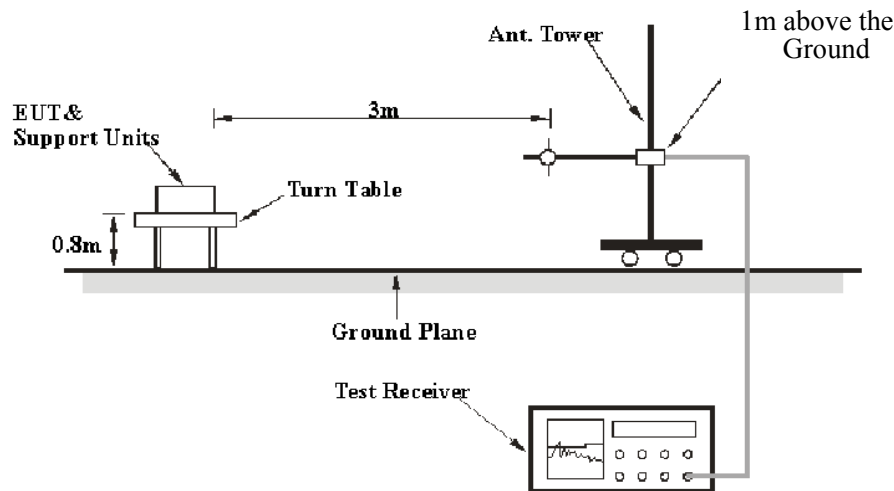

3.3.3 Test Procedure

1. Position the EUT on the test table without connection to measurement instrument. Turn on the EUT. Then set it to any one convenient frequency within its operating range. Set a reference level on the measuring instrument equal to the highest peak value.
2. Measure the frequency difference of two frequencies that were attenuated 20 dB from the reference level. Record the frequency difference as the emission bandwidth.
3. Measure the 99% Occupied bandwidth use the 99% Occupied bandwidth function of the test equipment.

3.4 Antenna Requirement

3.4.1 Applicable Standard

FCC §15.203

An intentional radiator shall be designed to ensure that no antenna other than that furnished by the responsible party shall be used with the device. The use of a permanently attached antenna or of an antenna that uses a unique coupling to the intentional radiator shall be considered sufficient to comply with the provisions of this section. The manufacturer may design the unit so that a broken antenna can be replaced by the user, but the use of a standard antenna jack or electrical connector is prohibited. This requirement does not apply to carrier current devices or to devices operated under the provisions of §§15.211, 15.213, 15.217, 15.219, 15.221, or §15.236. Further, this requirement does not apply to intentional radiators that must be professionally installed, such as perimeter protection systems and some field disturbance sensors, or to other intentional radiators which, in accordance with §15.31(d), must be measured at the installation site. However, the installer shall be responsible for ensuring that the proper antenna is employed so that the limits in this part are not exceeded.

3.4.2 Judgment

Compliant. Please refer to the Antenna Information detail in Section 1.

4. Test DATA AND RESULTS

4.1 AC Line Conducted Emissions

Serial Number:	2F4F-4	Test Date:	2024/1/4
Test Site:	CE	Test Mode:	Full load(Wireless output(15W)+ Type C output(5W)+USB output(5W))
Tester:	David Huang	Test Result:	Pass

Environmental Conditions:

Temperature: (°C)	24.2	Relative Humidity: (%)	32	ATM Pressure: (kPa)	101.5
----------------------	------	------------------------------	----	------------------------	-------

Test Equipment List and Details:

Manufacturer	Description	Model	Serial Number	Calibration Date	Calibration Due Date
R&S	LISN	ENV216	101134	2023/3/31	2024/3/30
R&S	EMI Test Receiver	ESR3	102726	2023/3/31	2024/3/30
MICRO-COAX	Coaxial Cable	UTIFLEX	C-0200-01	2023/8/6	2024/8/5
Audix	Test Software	E3	190306 (V9)	N/A	N/A

* Statement of Traceability: China Certification ICT Co., Ltd (Dongguan) attests that all calibrations have been performed, traceable to National Primary Standards and International System of Units (SI).

Project No.: CR231274927-RF
 Tester: David Huang
 Port: Line
 Note: Full load(Wireless output(15W)+Type C output(5W)+USB output(5W))

Date: 2024-01-04

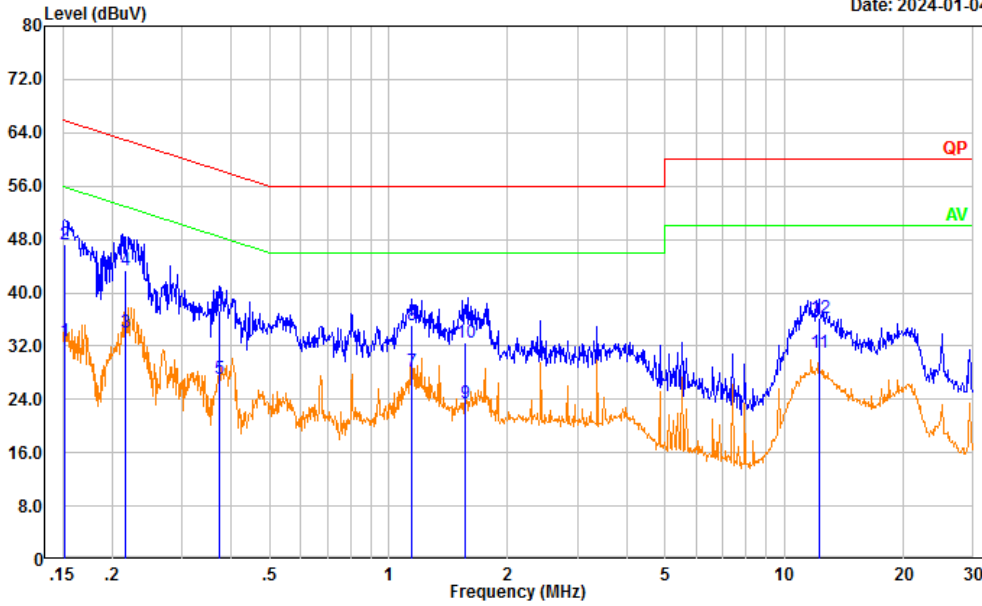

No.	Frequency (MHz)	Reading (dBμV)	Factor (dB)	Result (dBμV)	Limit (dBμV)	Margin (dB)	Detector
1	0.152	23.05	9.61	32.66	55.88	23.22	Average
2	0.152	37.75	9.61	47.36	65.88	18.52	QP
3	0.217	24.36	9.61	33.97	52.95	18.98	Average
4	0.217	33.69	9.61	43.30	62.95	19.65	QP
5	0.373	17.39	9.61	27.00	48.43	21.43	Average
6	0.373	27.75	9.61	37.36	58.43	21.07	QP
7	1.142	18.64	9.62	28.26	46.00	17.74	Average
8	1.142	25.50	9.62	35.12	56.00	20.88	QP
9	1.562	13.75	9.63	23.38	46.00	22.62	Average
10	1.562	22.95	9.63	32.58	56.00	23.42	QP
11	12.265	21.28	9.67	30.95	50.00	19.05	Average
12	12.265	26.54	9.67	36.21	60.00	23.79	QP

Project No.: CR231274927-RF
 Tester: David Huang
 Port: neutral
 Note: Full load(Wireless output(15W)+Type C output(5W)+USB output(5W))

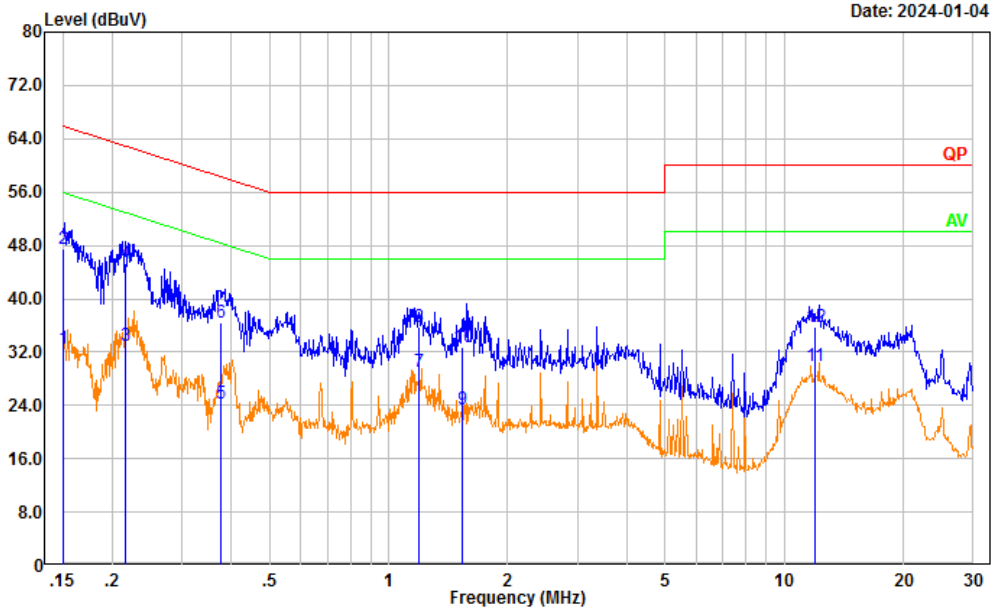

Date: 2024-01-04

No.	Frequency (MHz)	Reading (dBμV)	Factor (dB)	Result (dBμV)	Limit (dBμV)	Margin (dB)	Detector
1	0.150	22.90	9.61	32.51	55.97	23.46	Average
2	0.150	37.76	9.61	47.37	65.97	18.60	QP
3	0.217	23.43	9.61	33.04	52.94	19.90	Average
4	0.217	35.74	9.61	45.35	62.94	17.59	QP
5	0.375	14.68	9.61	24.29	48.38	24.09	Average
6	0.375	26.87	9.61	36.48	58.38	21.90	QP
7	1.190	19.32	9.62	28.94	46.00	17.06	Average
8	1.190	26.16	9.62	35.78	56.00	20.22	QP
9	1.537	13.86	9.63	23.49	46.00	22.51	Average
10	1.537	23.10	9.63	32.73	56.00	23.27	QP
11	11.932	20.26	9.67	29.93	50.00	20.07	Average
12	11.932	26.10	9.67	35.77	60.00	24.23	QP

4.2 Radiation Spurious Emissions

Serial Number:	2F4F-4	Test Date:	2024/1/5
Test Site:	966-2	Test Mode:	Full load(Wireless output(15W)+Type C output(5W)+USB output(5W))
Tester:	Jeff Luo	Test Result:	Pass

Environmental Conditions:

Temperature: (°C)	24.8	Relative Humidity: (%)	40	ATM Pressure: (kPa)	101.4
----------------------	------	---------------------------	----	---------------------------	-------

Test Equipment List and Details:

Manufacturer	Description	Model	Serial Number	Calibration Date	Calibration Due Date
BACL	Loop Antenna	1313-1P	3092721	2023/10/20	2026/10/19
Sunol Sciences	Antenna	JB6	A082520-5	2023/12/1	2026/11/30
R&S	EMI Test Receiver	ESR3	102724	2023/3/31	2024/3/30
TIMES MICROWAVE	Coaxial Cable	LMR-600- UltraFlex	C-0470-02	2023/7/16	2024/7/15
TIMES MICROWAVE	Coaxial Cable	LMR-600- UltraFlex	C-0780-01	2023/7/16	2024/7/15
Sonoma	Amplifier	310N	186165	2023/7/16	2024/7/15
Audix	Test Software	E3	201021 (V9)	N/A	N/A

* Statement of Traceability: China Certification ICT Co., Ltd (Dongguan) attests that all calibrations have been performed, traceable to National Primary Standards and International System of Units (SI).

1) 9kHz- 30MHz

Project No.: CR231274927-RF
 Tester: Jeff Luo
 Polarization: Parallel
 Note: Full load(Wireless output(15W)+Type C output(5W)+USB output(5W))

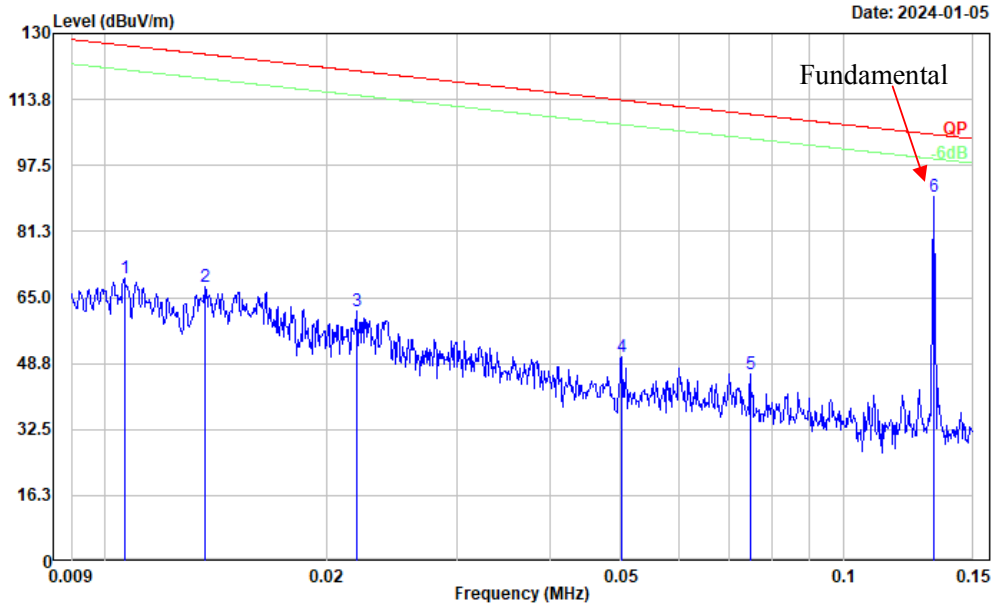

No.	Frequency (MHz)	Reading (dBμV)	Factor (dB/m)	Result (dBμV/m)	Limit (dBμV/m)	Margin (dB)	Detector
1	0.011	12.21	57.49	69.70	127.08	57.38	Peak
2	0.014	11.94	55.70	67.64	124.88	57.24	Peak
3	0.022	10.60	51.06	61.66	120.80	59.14	Peak
4	0.050	7.96	42.44	50.40	113.61	63.21	Peak
5	0.075	7.22	39.04	46.26	110.12	63.86	Peak
6	0.133	55.12	34.78	89.90	105.16	15.26	Peak

Project No.: CR231274927-RF
 Tester: Jeff Luo
 Polarization: Parallel
 Note: Full load(Wireless output(15W)+Type C output(5W)+USB output(5W))

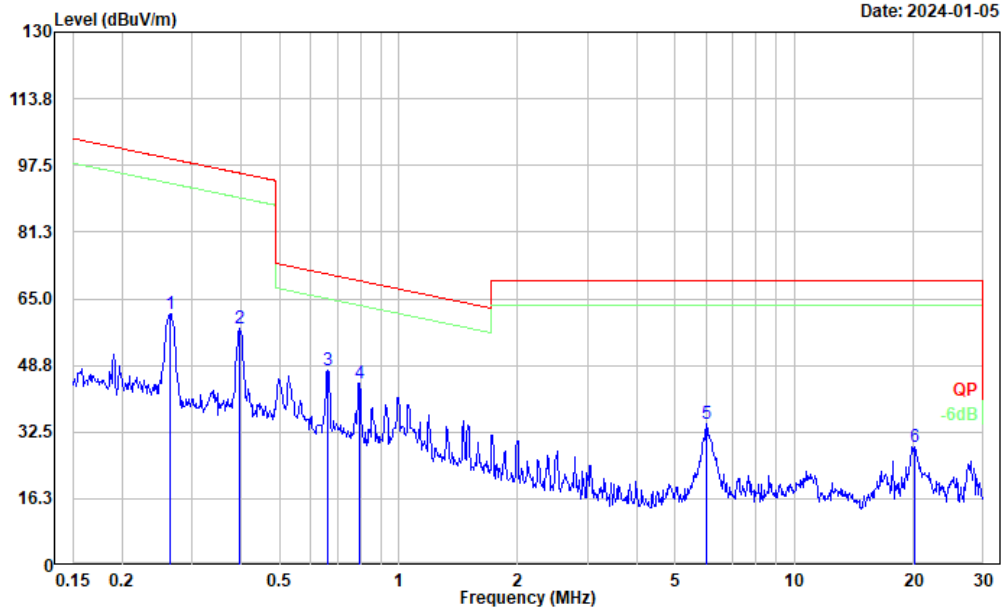

No.	Frequency (MHz)	Reading (dBμV)	Factor (dB/m)	Result (dBμV/m)	Limit (dBμV/m)	Margin (dB)	Detector
1	0.264	32.67	28.55	61.22	99.16	37.94	Peak
2	0.398	32.90	24.71	57.61	95.61	38.00	Peak
3	0.661	27.11	20.35	47.46	71.14	23.68	Peak
4	0.796	25.93	18.55	44.48	69.50	25.02	Peak
5	5.993	30.24	4.26	34.50	69.54	35.04	Peak
6	20.162	27.37	1.67	29.04	69.54	40.50	Peak

Project No.: CR231274927-RF
 Tester: Jeff Luo
 Polarization: Perpendicular
 Note: Full load(Wireless output(15W)+Type C output(5W)+USB output(5W))

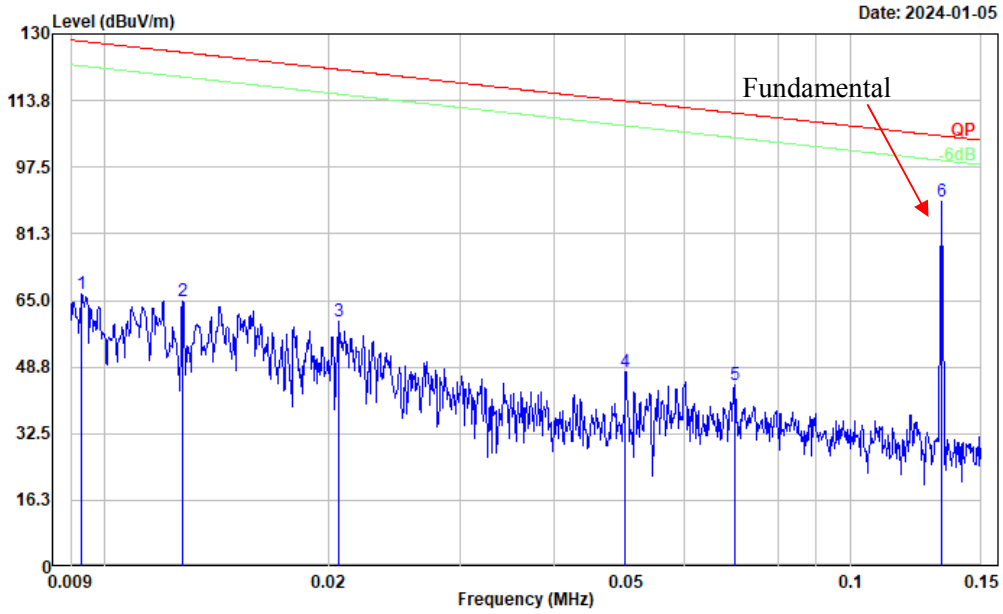

No.	Frequency (MHz)	Reading (dBμV)	Factor (dB/m)	Result (dBμV/m)	Limit (dBμV/m)	Margin (dB)	Detector
1	0.009	7.78	58.65	66.43	128.23	61.80	Peak
2	0.013	8.44	56.26	64.70	125.51	60.81	Peak
3	0.021	8.04	51.70	59.74	121.31	61.57	Peak
4	0.050	5.11	42.47	47.58	113.64	66.06	Peak
5	0.070	4.62	39.68	44.30	110.68	66.38	Peak
6	0.133	54.50	34.78	89.28	105.16	15.88	Peak

Project No.: CR231274927-RF
 Tester: Jeff Luo
 Polarization: Perpendicular
 Note: Full load(Wireless output(15W)+Type C output(5W)+USB output(5W))

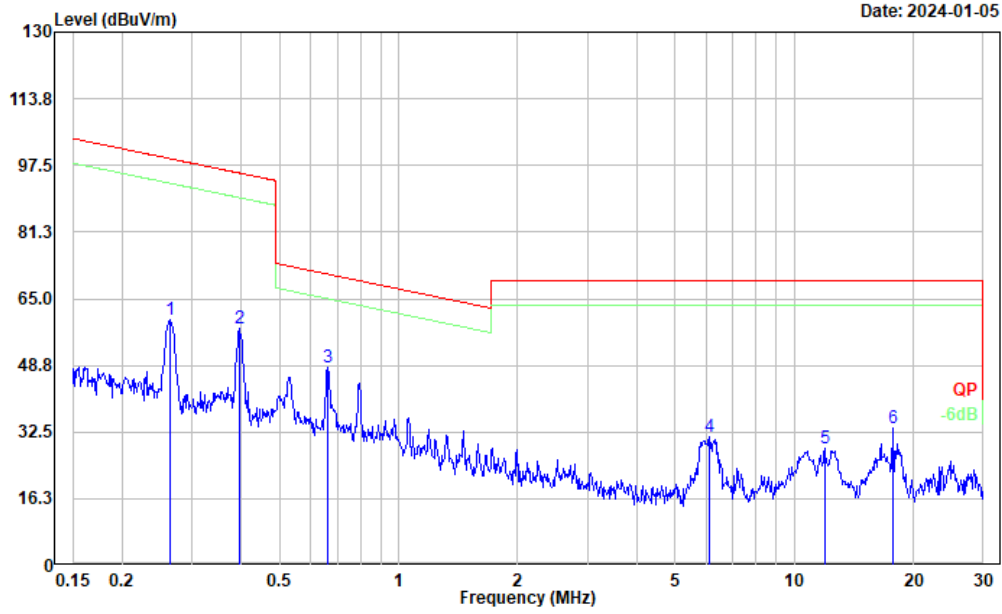

No.	Frequency (MHz)	Reading (dBμV)	Factor (dB/m)	Result (dBμV/m)	Limit (dBμV/m)	Margin (dB)	Detector
1	0.264	31.21	28.55	59.76	99.16	39.40	Peak
2	0.396	32.87	24.76	57.63	95.66	38.03	Peak
3	0.661	27.96	20.35	48.31	71.14	22.83	Peak
4	6.089	27.01	4.20	31.21	69.54	38.33	Peak
5	11.933	26.13	2.32	28.45	69.54	41.09	Peak
6	17.755	31.58	1.77	33.35	69.54	36.19	Peak

Project No.: CR231274927-RF
 Tester: Jeff Luo
 Polarization: Ground-parallel
 Note: Full load(Wireless output(15W)+Type C output(5W)+USB output(5W))

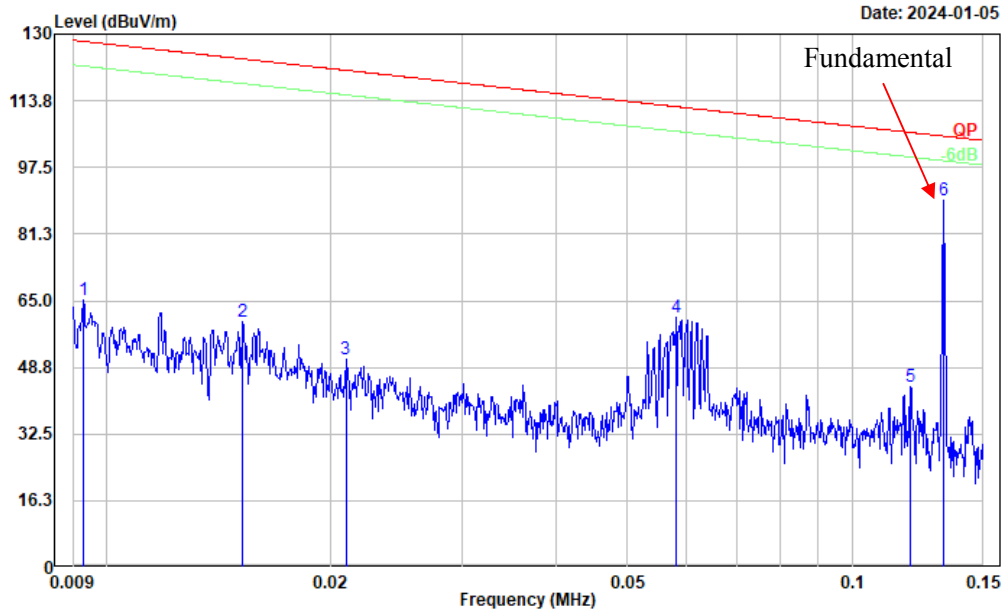

No.	Frequency (MHz)	Reading (dBμV)	Factor (dB/m)	Result (dBμV/m)	Limit (dBμV/m)	Margin (dB)	Detector
1	0.009	6.48	58.65	65.13	128.23	63.10	Peak
2	0.015	4.99	54.80	59.79	123.95	64.16	Peak
3	0.021	-0.92	51.55	50.63	121.19	70.56	Peak
4	0.058	19.63	41.36	60.99	112.32	51.33	Peak
5	0.120	8.53	35.39	43.92	106.04	62.12	Peak
6	0.133	54.65	34.78	89.43	105.16	15.73	Peak

Project No.: CR231274927-RF
 Tester: Jeff Luo
 Polarization: Ground-parallel
 Note: Full load(Wireless output(15W)+Type C output(5W)+USB output(5W))

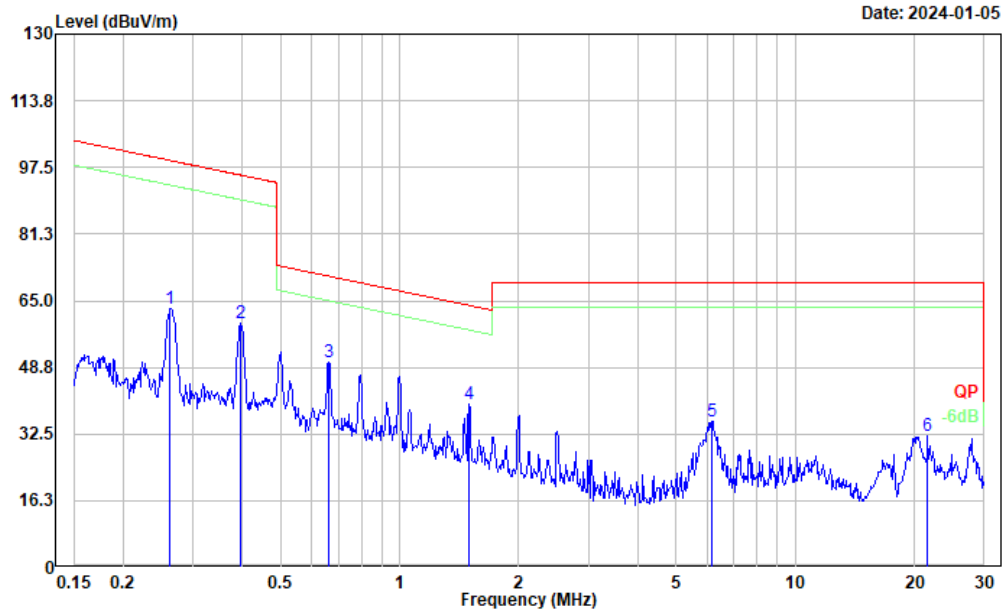

No.	Frequency (MHz)	Reading (dBμV)	Factor (dB/m)	Result (dBμV/m)	Limit (dBμV/m)	Margin (dB)	Detector
1	0.263	34.59	28.62	63.21	99.20	35.99	Peak
2	0.398	34.88	24.71	59.59	95.61	36.02	Peak
3	0.661	29.72	20.35	50.07	71.14	21.07	Peak
4	1.495	25.88	13.86	39.74	63.90	24.16	Peak
5	6.153	31.50	4.17	35.67	69.54	33.87	Peak
6	21.600	30.21	1.68	31.89	69.54	37.65	Peak

2) 30MHz-1GHz

Project No.: CR231274927-RF
 Tester: Jeff Luo
 Polarization: horizontal
 Note: Full load(Wireless output(15W)+Type C output(5W)+USB output(5W))

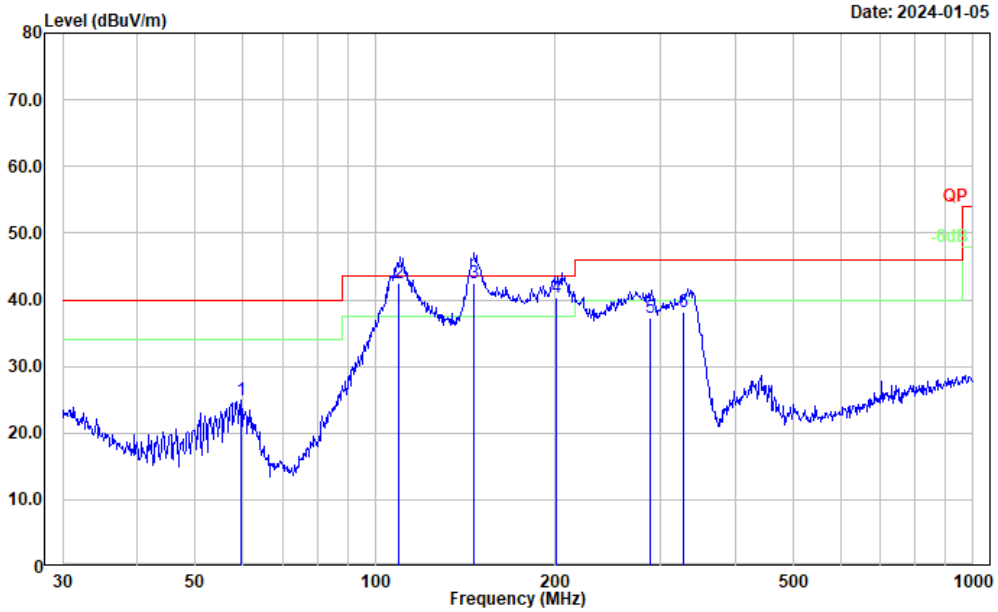

No.	Frequency (MHz)	Reading (dBμV)	Factor (dB/m)	Result (dBμV/m)	Limit (dBμV/m)	Margin (dB)	Detector
1	59.649	42.66	-17.70	24.96	40.00	15.04	Peak
2	109.195	54.90	-12.41	42.49	43.50	1.01	QP
3	146.298	54.52	-12.09	42.43	43.50	1.07	QP
4	201.171	52.96	-12.56	40.40	43.50	3.10	QP
5	287.978	47.79	-10.41	37.38	46.00	8.62	QP
6	328.020	47.95	-9.88	38.07	46.00	7.93	QP

Project No.: CR231274927-RF
 Tester: Jeff Luo
 Polarization: vertical
 Note: Full load(Wireless output(15W)+Type C output(5W)+USB output(5W))

Date: 2024-01-05

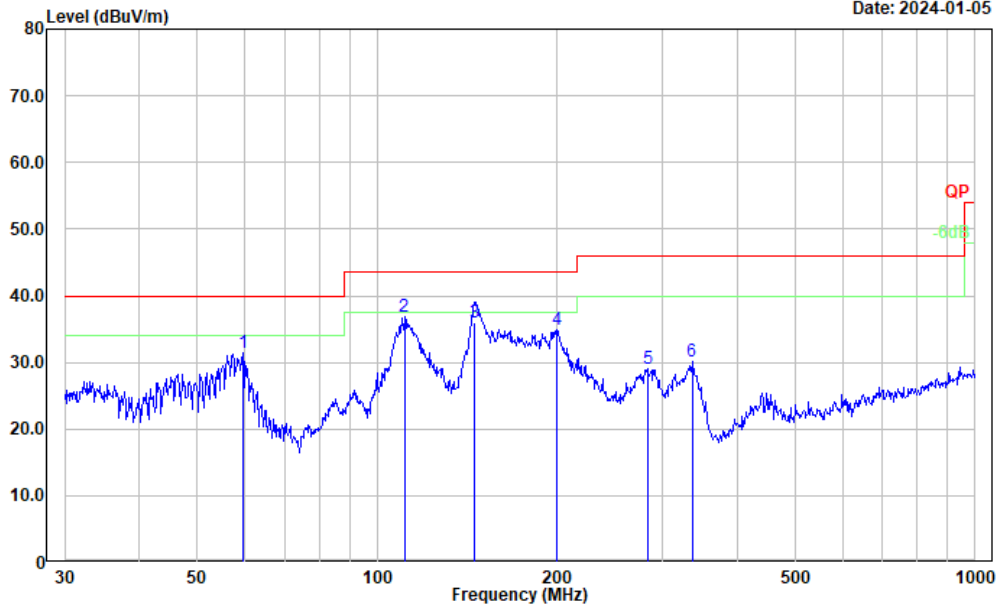

No.	Frequency (MHz)	Reading (dBμV)	Factor (dB/m)	Result (dBμV/m)	Limit (dBμV/m)	Margin (dB)	Detector
1	59.649	49.17	-17.70	31.47	40.00	8.53	Peak
2	110.957	49.00	-12.13	36.87	43.50	6.63	Peak
3	145.153	48.16	-12.09	36.07	43.50	7.43	QP
4	199.286	47.32	-12.47	34.85	43.50	8.65	Peak
5	282.985	39.78	-10.74	29.04	46.00	16.96	Peak
6	336.035	39.80	-9.72	30.08	46.00	15.92	Peak

4.3 20 dB Emission Bandwidth

Serial Number:	2F4F-4	Test Date:	2024/1/5
Test Site:	966-2	Test Mode:	Transmitting
Tester:	Jeff Luo	Test Result:	Pass

Environmental Conditions:

Temperature: (°C)	24.8	Relative Humidity: (%)	40	ATM Pressure: (kPa)	101.4
----------------------	------	---------------------------	----	---------------------------	-------

Test Equipment List and Details:

Manufacturer	Description	Model	Serial Number	Calibration Date	Calibration Due Date
BACL	Loop Antenna	1313-1P	3092721	2023/2/15	2026/2/14
R&S	EMI Test Receiver	ESR3	102724	2023/3/31	2024/3/30
TIMES MICROWAVE	Coaxial Cable	LMR-600-UltraFlex	C-0470-02	2023/7/16	2024/7/15
TIMES MICROWAVE	Coaxial Cable	LMR-600-UltraFlex	C-0780-01	2023/7/16	2024/7/15

** Statement of Traceability: China Certification ICT Co., Ltd (Dongguan) attests that all calibrations have been performed, traceable to National Primary Standards and International System of Units (SI).*

Test Data:

Test Frequency (kHz)	20 dB Emission Bandwidth (Hz)
131.451	779

20 dB Bandwidth

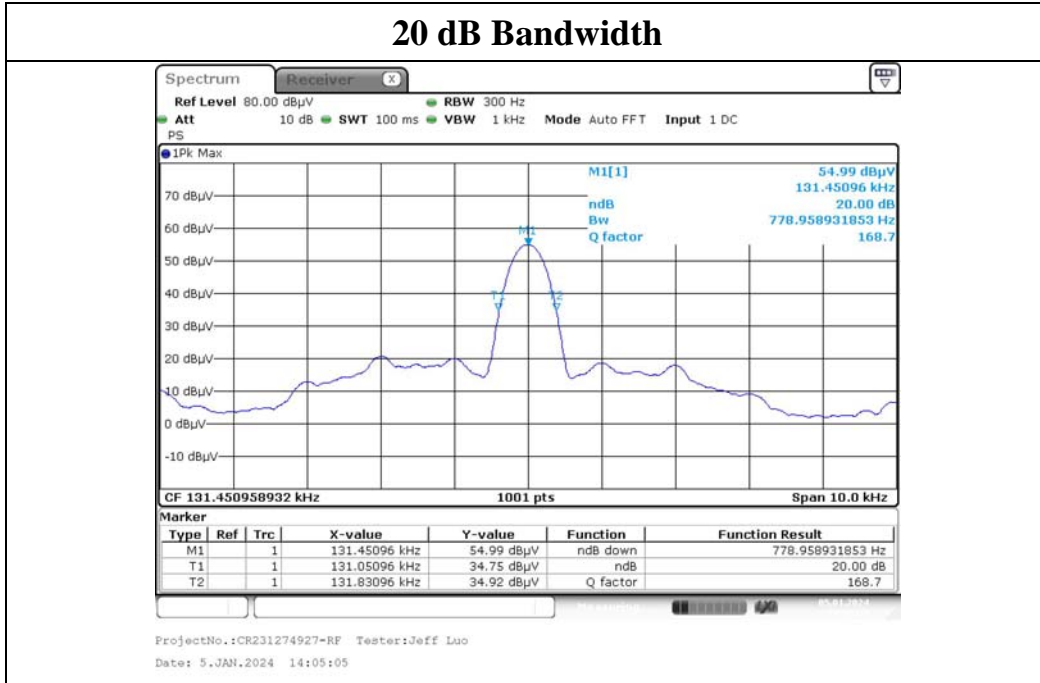

5 MAXIMUM PERMISSIBLE EXPOSURE (MPE)

5.1 Applicable Standard

According to subpart §1.1310, systems operating under the provisions of this section shall be operated in a manner that ensures that the public is not exposed to radio frequency energy level in excess of the Commission's guidelines.

Limits for Maximum Permissible Exposure (MPE) (§1.1310, §2.1091)

(B) Limits for General Population/Uncontrolled Exposure				
Frequency Range (MHz)	Electric Field Strength (V/m)	Magnetic Field Strength (A/m)	Power Density (mW/cm ²)	Averaging Time (minutes)
0.3–1.34	614	1.63	*(100)	30
1.34–30	824/f	2.19/f	*(180/f ²)	30
30–300	27.5	0.073	0.2	30
300–1500	/	/	f/1500	30
1500–100,000	/	/	1.0	30

f = frequency in MHz; * = Plane-wave equivalent power density;

According with 680106 D01 Wireless Power Transfer v04 clause 3.2

Accordingly, for § 2.1091-Mobile devices, the MPE limits between 100 kHz to 300 kHz are to be considered the same as those at 300 kHz in Table 1 of § 1.1310, that is, 614 V/m and 1.63 A/m, for the electric field and magnetic field, respectively. For § 2.1093-Portable devices below 4 MHz and down to 100 kHz, the MPE limits in § 1.1310 (with the 300 kHz limit applicable all the way down to 100 kHz) can be used for the purpose of equipment authorization in lieu of SAR evaluations.

5.2 Block Diagram of Test Setup

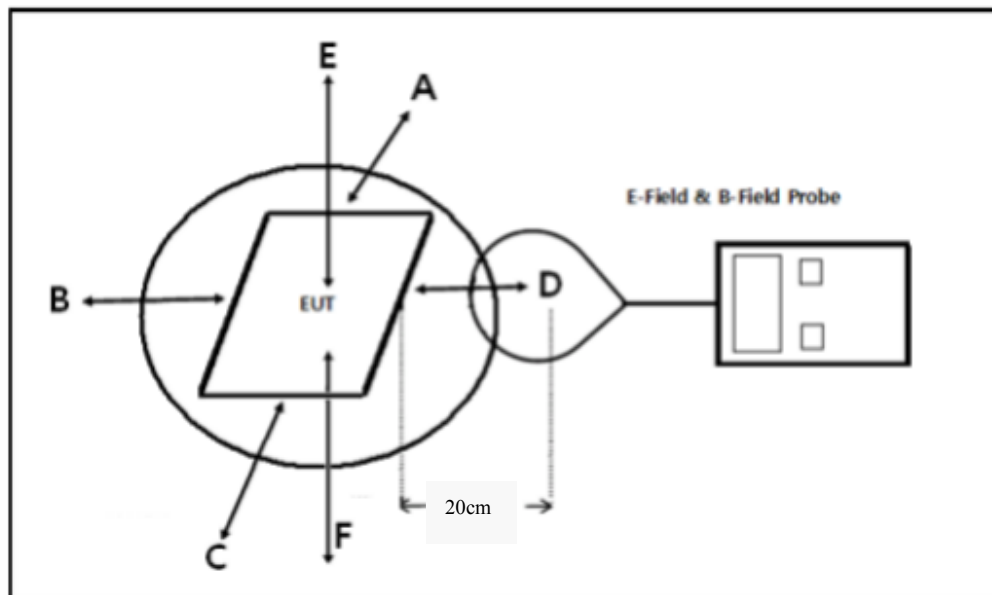

5.3 Test Procedures

- 1) Perform H-field and E-field measurements for each all sides of the EUT at 20cm, along all the principal axes defined with respect to the orientation of the transmitting element(e.g., coil or antenna).
- 2) The highest emission level was recorded and compared with limit.
- 3) The EUT was measured according to 680106 D01 Wireless Power Transfer v04

5.3 Test Data:

Serial Number:	2F4F-4	Test Date:	2024/1/4
Test Site:	RF	Test Mode:	Full load(Wireless output(15W)+Type C output(5W)+USB output(5W))
Tester:	David Huang	Test Result:	Pass

Environmental Conditions:

Temperature: (°C)	24.2	Relative Humidity: (%)	32	ATM Pressure: (kPa)	101.5
----------------------	------	---------------------------	----	------------------------	-------

Test Equipment List and Details:

Manufacturer	Description	Model	Serial Number	Calibration Date	Calibration Due Date
Narda	Electric and Magnetic Field Probe-Analyzer	EHP-200AC	180ZX10204	2021/06/07	2024/06/06

* **Statement of Traceability:** China Certification ICT Co., Ltd (Dongguan) attests that all calibrations have been performed, traceable to National Primary Standards and International System of Units (SI).

Test Data:**H-Field Strength:**

Frequency Range (kHz)	Position A (A/m)	Position B (A/m)	Position C (A/m)	Position D (A/m)	Position E (A/m)	Limit (A/m)
131	0.05	0.07	0.11	0.07	0.21	1.63

E-Field Strength:

Frequency Range (kHz)	Position A (V/m)	Position B (V/m)	Position C (V/m)	Position D (V/m)	Position E (V/m)	Limit (V/m)
131	0.71	1.12	1.14	1.07	2.02	614

Note: Test with 20cm distance from the center of the probe(s) to the edge of the device.

6. EUT PHOTOGRAPHS

Please refer to the attachment CR231274927-EXP EUT EXTERNAL PHOTOGRAPHS and CR231274927-INP EUT INTERNAL PHOTOGRAPHS

7. TEST SETUP PHOTOGRAPHS

Please refer to the attachment CR231274927-00B-TSP TEST SETUP PHOTOGRAPHS.

******* END OF REPORT *******