

WIRELESS CHARGING & SNOOZE | DIMMER POP LABEL

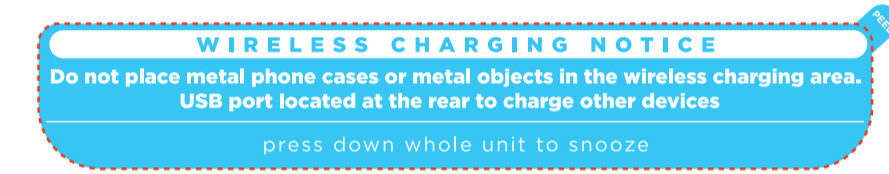

C - 63
M - 0
Y - 0
K - 0

apply adhesive in only these areas on under side of labels

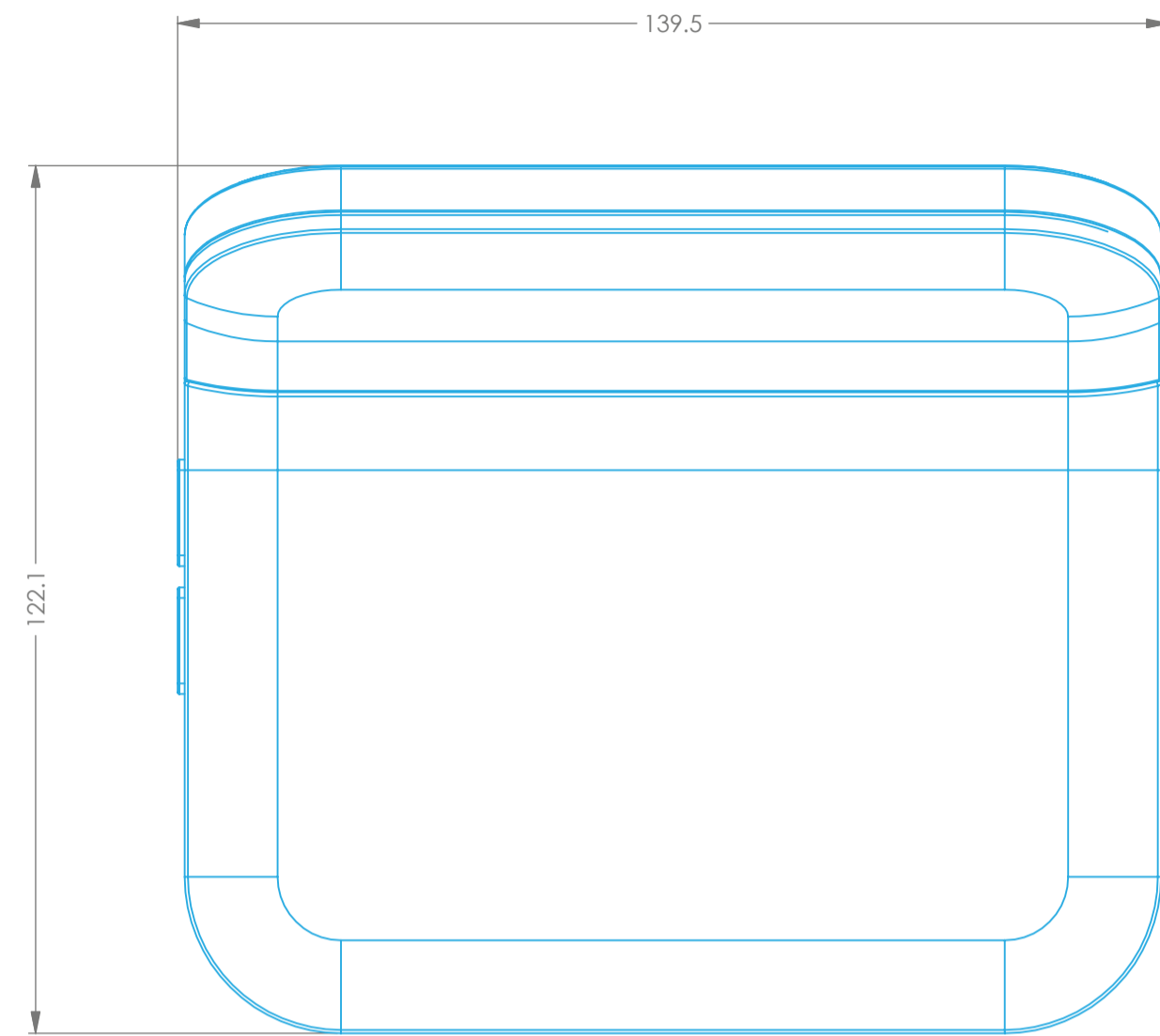
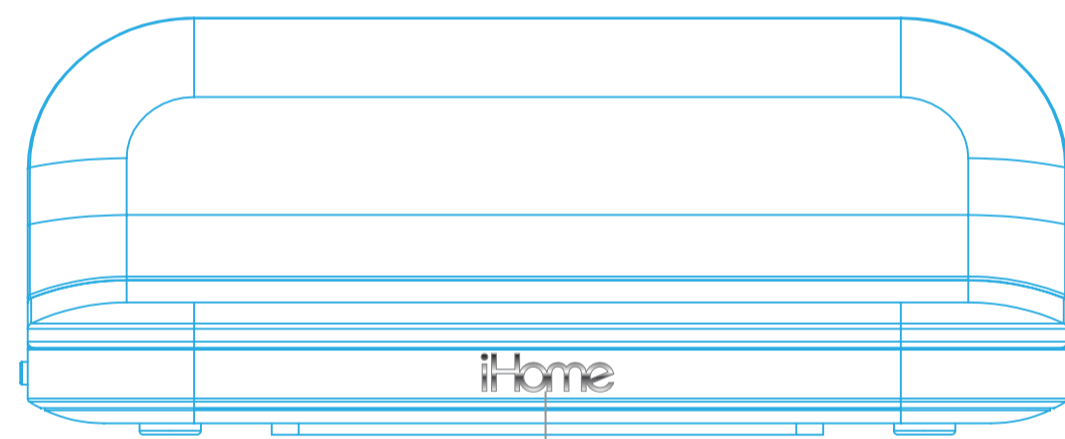
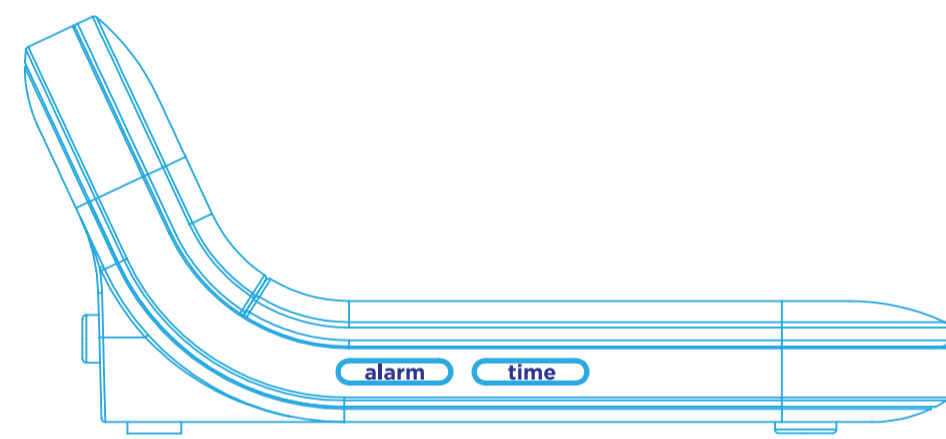

60mm
Metallic Hot Stamped iHome Logo
*Center iHome Hot Stamp with 60mm on either side

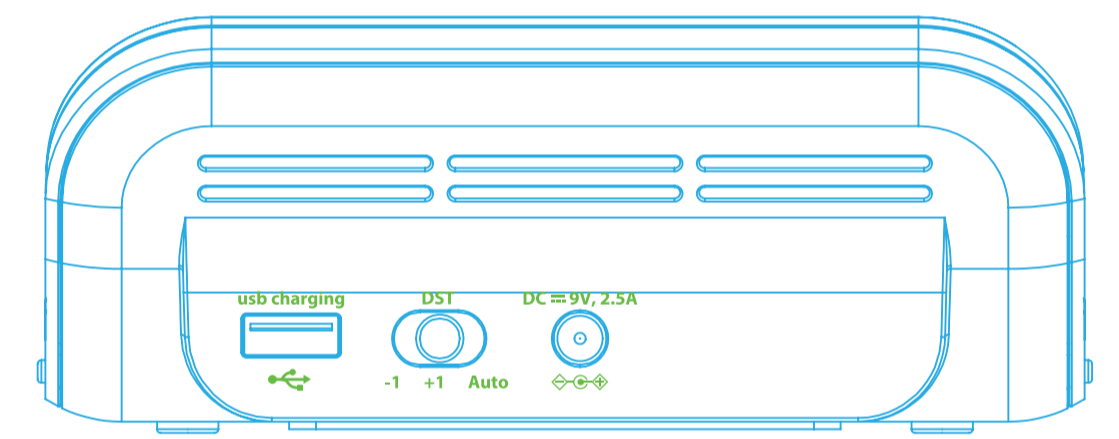
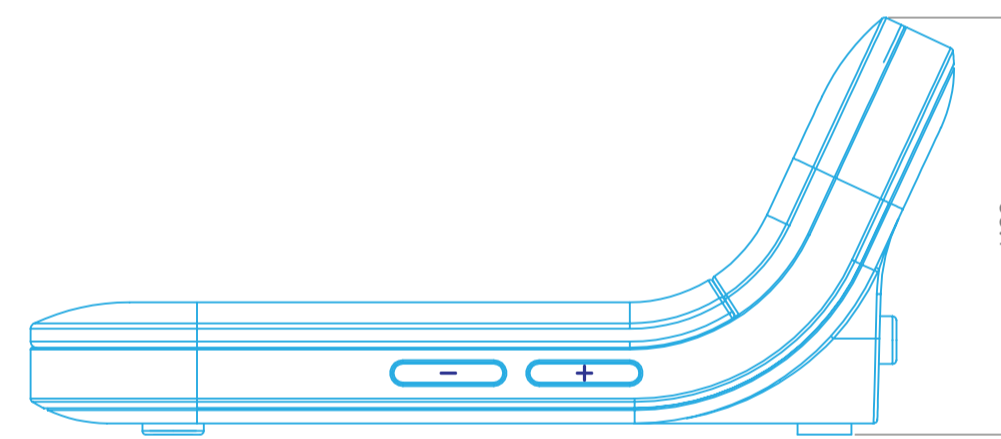

US version

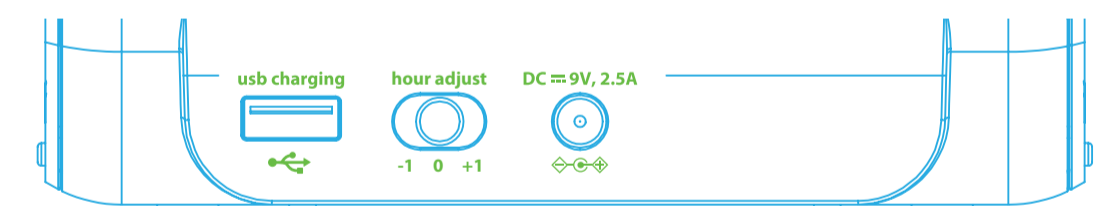

Int'l version

MODEL PLATE



New MCU UST2028
Updated Apr. 19, 21.



New MCU UST2028
Updated Apr. 19, 21.

BLUE - Emboss 0.3mm
PINK - Deboss 0.3mm
GREEN - Screen Print: Black

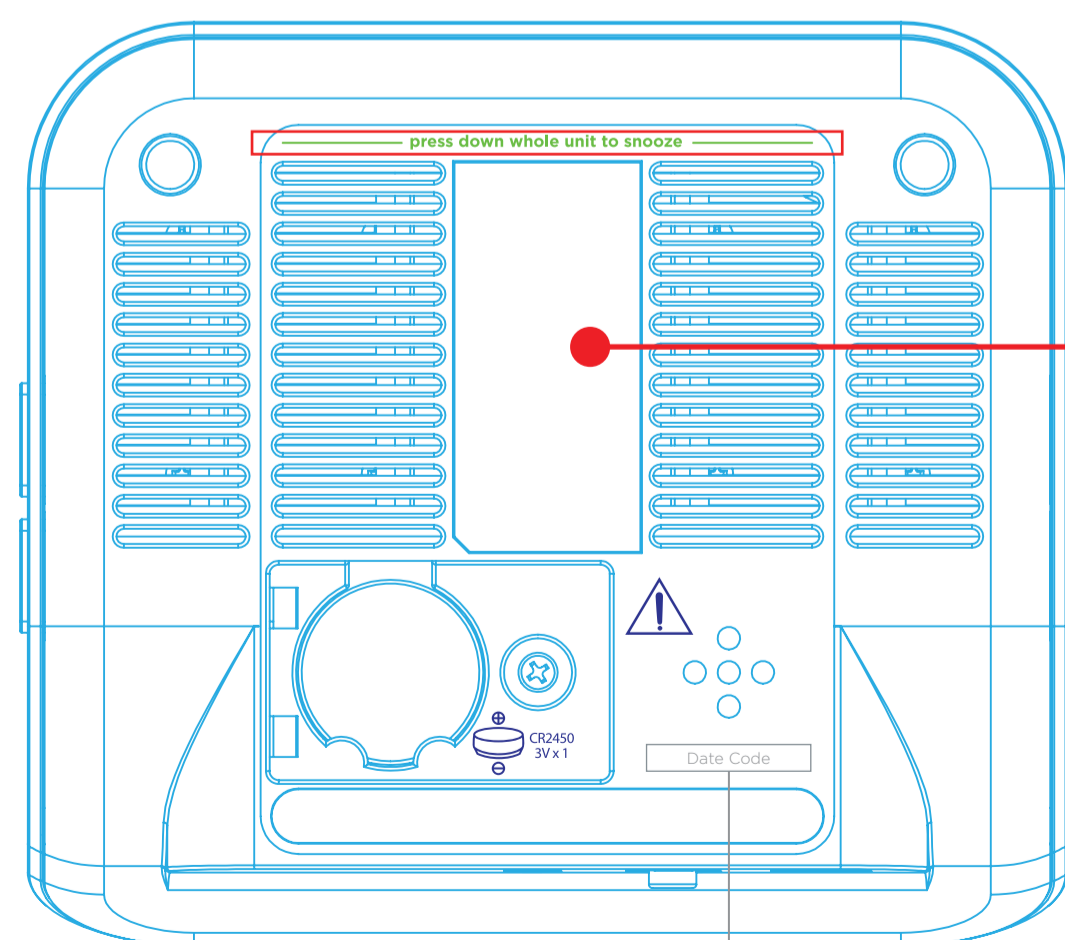

Laser Etched Date Code

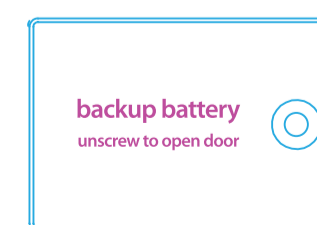

BATTERY DOOR

iHome GAW	
Title: Compact Clock with Wireless Charging	
Version: 17	Model: iW18
Designer: Jacob Brosius	
Date: 04.19.21.	
<p>CONFIDENTIAL and PROPRIETARY: The information contained herein including, but not limited to the products, renderings, concepts and designs comprise intellectual property of SDI Technologies Inc. and shall be kept confidential and shall not be used or disclosed by the recipient without the written authority of SDI Technologies Inc.</p>	