

TEST REPORT

Product Name : Bluetooth Alarm Clock with UV Sanitizing and USB charging
Model Number : iUVBT1, iUVBT1X
(X could 1 or 3 digits by any alphabets denote different cabinet color)
FCC ID : EMOIUVT1A

Prepared for : SDI Technologies Inc.
Address : 1299, Main Street, Rahway, NJ 07065, U.S.A.

Prepared by : EMTEK (SHENZHEN) CO., LTD.
Address : Building 69, Majialong Industry Zone, Nanshan District, Shenzhen, Guangdong, China

Tel: (0755) 26954280
Fax: (0755) 26954282

Report Number : ES200716001W
Date(s) of Tests : July 17, 2020 to August 04, 2020
Date of issue : August 05, 2020

VERIFICATION OF COMPLIANCE

Applicant:	SDI Technologies Inc. 1299, Main Street, Rahway, NJ 07065, U.S.A.
Manufacturer:	SDI Technologies Inc. 1299, Main Street, Rahway, NJ 07065, U.S.A.
Factory:	Shenzhen Inecan Electronic Co., Ltd. 1704, Fo Tan Industrial Centre, 26-28 Au Pui Wan St., Fo Tan, Hong Kong
Product Description:	Bluetooth Alarm Clock with UV Sanitizing and USB charging
Trade Mark:	iHome
Model Number:	iUVBT1, iUVBT1X (X could 1 or 3 digits by any alphabets denote different cabinet color)

We hereby certify that:

The above equipment was tested by EMTEK(SHENZHEN) CO., LTD. The test data, data evaluation, test procedures, and equipment configurations shown in this report were made in accordance with the procedures given in ANSI C63.10-2013 and the energy emitted by the sample EUT tested as described in this report is in compliance with conducted and radiated emission limits of FCC Rules Part 15.247(2018).

Date of Test : July 17, 2020 to August 04, 2020

Prepared by : 
Loren Luo /Editor

Reviewer : 
Tim Dong /Supervisor

Approved & Authorized Signer : 
Lisa Wang /Manager



Modified Information

Version	Summary	Revision Date	Report No.
Ver.1.0	Original Report	/	ES200716001W



Table of Contents

1. GENERAL INFORMATION.....	6
1.1 PRODUCT DESCRIPTION.....	6
1.2 TEST METHODOLOGY.....	7
1.3 TEST FACILITY.....	8
2. SYSTEM TEST CONFIGURATION.....	9
2.1 EUT CONFIGURATION.....	9
2.2 EUT EXERCISE.....	9
2.3 TEST PROCEDURE.....	9
2.4 CONFIGURATION OF TESTED SYSTEM.....	10
3. SUMMARY OF TEST RESULTS.....	11
4. DESCRIPTION OF TEST MODES.....	12
5. TEST SYSTEM UNCERTAINTY.....	13
6. CONDUCTED EMISSIONS TEST.....	14
6.1 MEASUREMENT PROCEDURE.....	14
6.2 TEST SET-UP (BLOCK DIAGRAM OF CONFIGURATION).....	14
6.3 MEASUREMENT EQUIPMENT USED:.....	14
6.4 MEASUREMENT RESULT:.....	15
6.5 CONDUCTED MEASUREMENT PHOTOS:.....	18
7. RADIATED EMISSION TEST.....	19
7.1 MEASUREMENT PROCEDURE.....	19
7.2 TEST SET-UP (BLOCK DIAGRAM OF CONFIGURATION).....	21
7.3 MEASUREMENT EQUIPMENT USED:.....	22
7.4 RADIATED EMISSION LIMIT.....	23
7.5 MEASUREMENT RESULT.....	24
7.5 RADIATED MEASUREMENT PHOTOS:.....	29
8. CHANNEL SEPARATION TEST.....	30
8.1 MEASUREMENT PROCEDURE.....	30
8.2 TEST SET-UP (BLOCK DIAGRAM OF CONFIGURATION).....	30
8.3 MEASUREMENT EQUIPMENT USED:.....	30
8.4 MEASUREMENT RESULTS:.....	30
9. 20DB BANDWIDTH TEST.....	37
9.1 MEASUREMENT PROCEDURE.....	37
9.2 TEST SET-UP (BLOCK DIAGRAM OF CONFIGURATION).....	37
9.3 MEASUREMENT EQUIPMENT USED:.....	37
9.4 MEASUREMENT RESULTS:.....	37

10. QUANTITY OF HOPPING CHANNEL TEST.....	44
10.1 MEASUREMENT PROCEDURE.....	44
10.2 TEST SET-UP (BLOCK DIAGRAM OF CONFIGURATION).....	44
10.3 MEASUREMENT EQUIPMENT USED:.....	44
10.4 MEASUREMENT RESULTS:.....	44
11. TIME OF OCCUPANCY (DWELL TIME) TEST.....	45
11.1 TEST DESCRIPTION.....	45
11.2 TEST SET-UP (BLOCK DIAGRAM OF CONFIGURATION).....	45
11.3 MEASUREMENT EQUIPMENT USED:.....	45
11.4 TEST REQUIREMENTS / LIMITS.....	45
11.5 TEST RESULT.....	46
12. MAXIMUM PEAK OUTPUT POWER TEST.....	48
12.1 MEASUREMENT PROCEDURE.....	48
12.2 TEST SET-UP (BLOCK DIAGRAM OF CONFIGURATION).....	48
12.3 MEASUREMENT EQUIPMENT USED:.....	48
12.4 MEASUREMENT RESULTS:.....	49
13. BAND EDGE TEST.....	55
13.1 MEASUREMENT PROCEDURE.....	55
13.2 TEST SET-UP (BLOCK DIAGRAM OF CONFIGURATION).....	56
13.3 MEASUREMENT EQUIPMENT USED:.....	56
13.4 MEASUREMENT RESULTS:.....	57
14. ANTENNA APPLICATION.....	73
14.1 ANTENNA REQUIREMENT.....	73
14.2 RESULT.....	73
15. PHOTOS OF EUT.....	73

1. GENERAL INFORMATION

1.1 Product Description

Characteristics	Description
Product Name	Bluetooth Alarm Clock with UV Sanitizing and USB charging
Model number	iUVBT1, iUVBT1X (X could 1 or 3 digits by any alphabets denote different cabinet color) (Note: The models are the same except the model number, here we prepare iUVBT1 for the all test)
Power Supply	AC 120V/60Hz for adapter
Adapter	Model:BQ30A-0903000-U Input:AC 100-240V 50/60Hz 0.8A Output:DC 9V 3A
Kind of Device	Bluetooth Ver.4.2
Modulation	GFSK, $\pi/4$ -DQPSK, 8DPSK
Operating Frequency Range	2402-2480MHz
Number of Channels	79
Transmit Power Max(PK)	0.07dBm(0.001016W)
Antenna Type	Internal PCB antenna
Antenna Gain	0.5dBi

1.2 Test Methodology

Both conducted and radiated testing was performed according to the procedures in ANSI C63.10-2013. Radiated testing was performed at an antenna to EUT distance 3 meters.



1.3 Test Facility

Site Description

EMC Lab. : Accredited by CNAS, 2018.11.30
The certificate is valid until 2022.10.28
The Laboratory has been assessed and proved to be in compliance with CNAS-CL01:2006 (identical to ISO/IEC 17025:2005)
The Certificate Registration Number is L2291.

Accredited by TUV Rheinland Shenzhen 2016.5.19
The Laboratory has been assessed according to the requirements ISO/IEC 17025.

Accredited by FCC, August 09, 2018
Designation Number: CN1204
Test Firm Registration Number: 882943

Accredited by Industry Canada, November 09, 2018
The Certificate Registration Number is 4480A.

Accredited by A2LA, August 08, 2018
The Certificate Number is 4321.01.

Name of Firm : EMTEK(SHENZHEN) CO., LTD.

Site Location : Building 69, Majialong Industry Zone, Nanshan District, Shenzhen, Guangdong, China.

2. System Test Configuration

2.1 EUT Configuration

The EUT configuration for testing is installed on RF field strength measurement to meet the Commissions requirement and operating in a manner which intends to maximize its emission characteristics in a continuous normal application.

2.2 EUT Exercise

The Transmitter was operated in the normal operating mode. The Tx frequency was fixed which was for the purpose of the measurements.

2.3 Test Procedure

2.3.1 Conducted Emissions

The EUT is a placed on as turn table which is 0.8 m above ground plane. According to the requirements in Section 13.1.4.1 of ANSI C63.10-2013. Conducted emissions from the EUT measured in the frequency range between 0.15 MHz and 30MHz using CISPR Quasi-Peak and average detector mode.

2.3.2 Radiated Emissions

Below 1000MHz, The EUT was placed on a turn table which is 0.8m above ground plane. And above 1000MHz, The EUT was placed on a styrofoam table which is 1.5m above ground plane. The turn table shall rotate 360 degrees to determine the position of maximum emission level. EUT is set 3m away from the receiving antenna which varied from 1m to 4m to find out the highest emission. And also, each emission was to be maximized by changing the polarization of receiving antenna both horizontal and vertical. In order to find out the max. emission, the relative positions of EUT was fixed in a particular direction according to the requirements in Section 13.1.4.1 of ANSI C63.10-2013.

2.4 Configuration of Tested System

Fig. 2-1 Configuration of Tested System

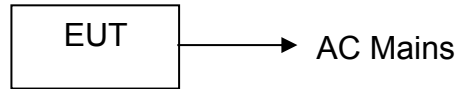

Table 2-1 Equipment Used in Tested System

Item	Equipment	Trademark	Model No.	FCC ID	Note
1.	Bluetooth Alarm Clock with UV Sanitizing and USB charging	iHome	iUVBT1	EMOIUVBT1 A	<i>EUT</i>

Note:

- (1) Unless otherwise denoted as EUT in 『Remark』 column , device(s) used in tested system is a support equipment.

3. Summary of Test Results

FCC Rules	Description Of Test	Result
§15.207	AC Power Conducted Emission	Compliant
§15.247(d),§15.209	Radiated Emission	Compliant
§15.247(a)(1)	Channel Separation test	Compliant
§15.247(a)(1)	20dB Bandwidth	Compliant
§15.247(a)(1)(iii)	Quantity of Hopping Channel	Compliant
§15.247(a)(1)(iii)	Time of Occupancy(Dwell Time)	Compliant
§15.247(b)	Max Peak output Power test	Compliant
§15.247(d)	Band edge test	Compliant
§15.203	Antenna Requirement	Compliant



4. Description of test modes

The EUT has been tested under its typical operating condition and fully-charged battery for EUT tested alone. Pre-defined engineering program for regulatory testing used to control the EUT for staying in continuous transmitting. Only the worst case data were reported.

The EUT has been associated with peripherals pursuant to ANSI C63.10-2013 and configuration operated in a manner tended to maximize its emission characteristics in a typical application. Frequency range investigated: radiation (9 KHz to the 10th harmonics of the highest fundamental frequency or to 40 GHz, whichever is lower).

The EUT has been tested under TX operating condition. This EUT is a FHSS system, were conducted to determine the final configuration from all possible combinations. We use software control the EUT, Let EUT hopping on and transmit with highest power, all the modes GFSK, $\pi/4$ -DQPSK, 8DPSK have been tested. 79 Channels are provided by EUT. The 3 channels of lower, medium and higher were chosen for test.

Channel List:

Channel	Frequency (MHz)	Channel	Frequency (MHz)	Channel	Frequency (MHz)
1	2402	39	2441
2	2403	40	2442	77	2478
3	2404	41	2443	78	2479
...	79	2480

Note: $f_c = 2402\text{MHz} + (k-1) \times 1\text{MHz}$ $k=1$ to 79

Test Frequency and channels:

Channel	Frequency(MHz)
1	2402
40	2441
79	2480

5. TEST SYSTEM UNCERTAINTY

The following measurement uncertainty levels have been estimated for tests performed on the apparatus:

Parameter	Uncertainty
Radio Frequency	$\pm 1 \times 10^{-5}$
Maximum Peak Output Power Test	$\pm 1.0\text{dB}$
Conducted Emissions Test	$\pm 2.0\text{dB}$
Radiated Emission Test	$\pm 2.0\text{dB}$
Power Density	$\pm 2.0\text{dB}$
Occupied Bandwidth Test	$\pm 1.0\text{dB}$
Band Edge Test	$\pm 3\text{dB}$
All emission, radiated	$\pm 3\text{dB}$
Antenna Port Emission	$\pm 3\text{dB}$
Temperature	$\pm 0.5^\circ\text{C}$
Humidity	$\pm 3\%$

Remark: The coverage Factor ($k=2$), and measurement Uncertainty for a level of Confidence of 95%

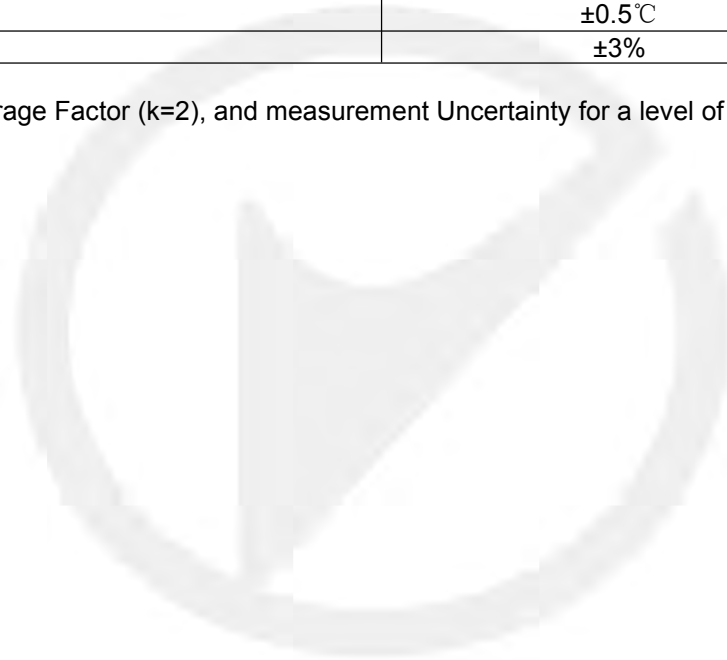

6. Conducted Emissions Test

6.1 Measurement Procedure:

1. The EUT was placed on a table, which is 0.8m above ground plane.
2. Maximum procedure was performed on the six highest emissions to ensure EUT compliance.
3. Repeat above procedures until all frequency measured was complete.

6.2 Test SET-UP (Block Diagram of Configuration)

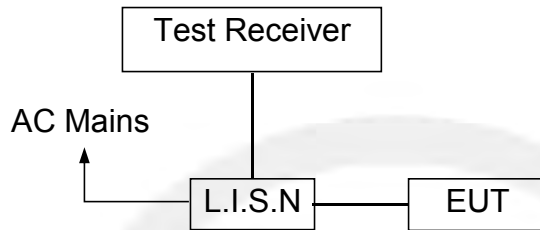

6.3 Measurement Equipment Used:

Conducted Emission Test Site						
EQUIPMENT TYPE	MFR	MODEL NUMBER	SERIAL NUMBER	Characteristics	Last Cal.	Due date
Test Receiver	Rohde & Schwarz	ESCS30	100018	9kHz~3GHz	05/16/2020	05/15/2021
L.I.S.N	Rohde & Schwarz	ENV216	100017	9KHz-300MHz	05/16/2020	05/15/2021
RF Switching Unit	CDS	RSU-M2	38401	9KHz-300MHz	05/16/2020	05/15/2021
Coaxial Cable	CDS	79254	46107086	9kHz~3GHz	05/16/2020	05/15/2021

6.4 Measurement Result:

Operation Mode:	TX	Test Date :	July 20, 2020
Frequency Range:	0.15MHz~30MHz	Temperature :	28℃
Test Result:	PASS	Humidity :	65 %
Test By:	Loren		

Pass.

All modulation modes have been tested, the worst mode is (GFSK TX 2402MHz), the data is recorded on the following page, other modulation modes do not exceed this limit. Please refer to the following data.



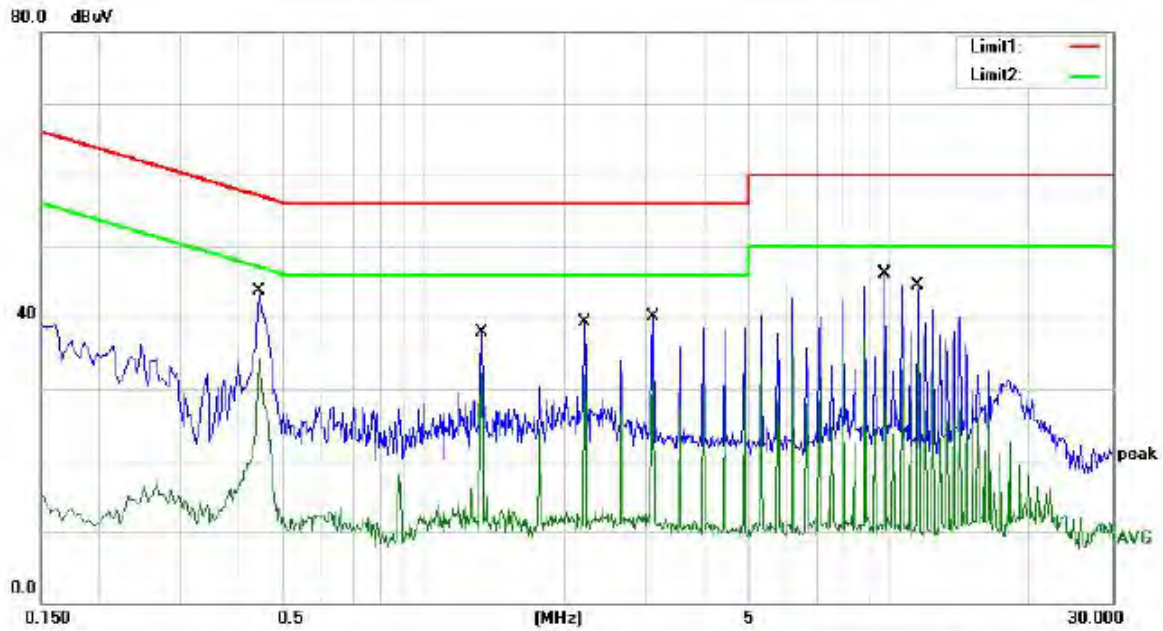

Site site #1

Phase: **N**

Temperature: 27

Limit: FCC PART 15 C_QP (CE)

Power: DC 9V form adapter

Humidity: 69 %

Mode: TX 2402

Note:

No.	Mk.	Freq. MHz	Reading Level dBuV	Correct Factor dB	Measure- ment dBuV	Limit dBuV	Over dB	Detector	Comment
1		0.4420	33.51	10.15	43.66	57.02	-13.36	QP	
2	*	0.4420	24.11	10.15	34.26	47.02	-12.76	AVG	
3		1.3260	27.66	10.18	37.84	56.00	-18.16	QP	
4		1.3260	22.07	10.18	32.25	46.00	-13.75	AVG	
5		2.2100	29.14	10.18	39.32	56.00	-16.68	QP	
6		2.2100	21.68	10.18	31.86	46.00	-14.14	AVG	
7		3.0940	29.88	10.18	40.06	56.00	-15.94	QP	
8		3.0940	21.34	10.18	31.52	46.00	-14.48	AVG	
9		9.7260	35.88	10.21	46.09	60.00	-13.91	QP	
10		9.7260	25.10	10.21	35.31	50.00	-14.69	AVG	
11		11.4980	34.21	10.22	44.43	60.00	-15.57	QP	
12		11.4980	24.06	10.22	34.28	50.00	-15.72	AVG	

*:Maximum data x:Over limit !:over margin Comment: Factor build in receiver. Operator: Lian

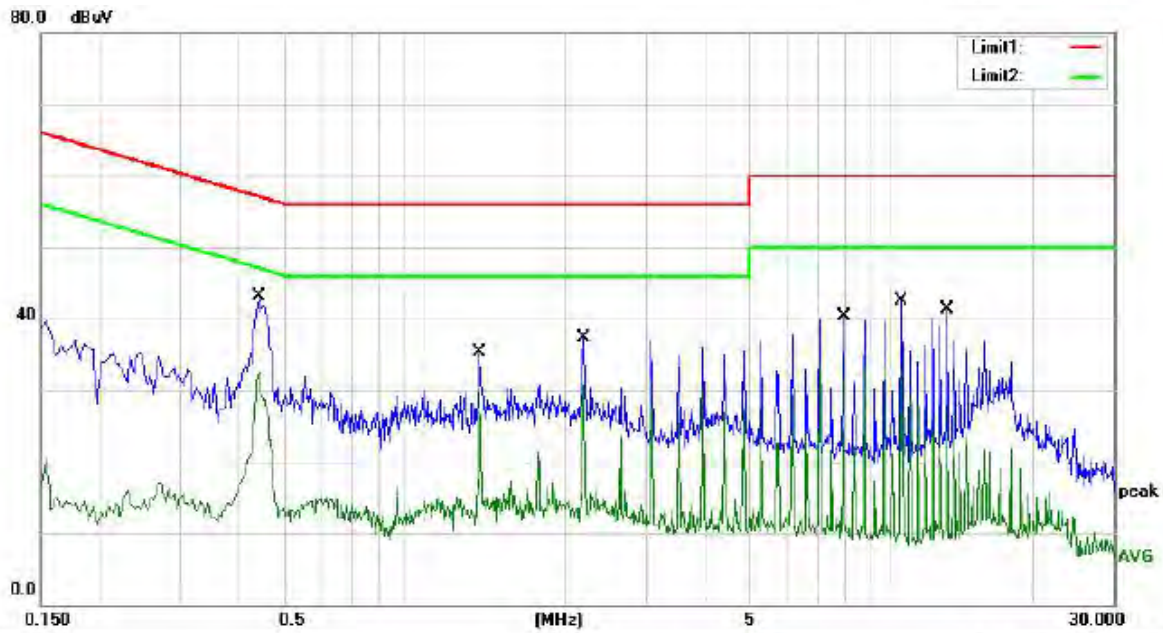

Site site #1 Phase: **L1** Temperature: 27
 Limit: FCC PART 15 C_QP (CE) Power: DC 9V form adapter Humidity: 69 %
 Mode: TX 2402
 Note:

No.	Mk.	Freq. MHz	Reading Level dBuV	Correct Factor dB	Measure- ment dBuV	Limit dBuV	Over dB	Detector	Comment
1	*	0.4420	33.04	10.15	43.19	57.02	-13.83	QP	
2		0.4420	18.57	10.15	28.72	47.02	-18.30	AVG	
3		1.3140	25.06	10.18	35.24	56.00	-20.76	QP	
4		1.3140	20.41	10.18	30.59	46.00	-15.41	AVG	
5		2.1860	24.10	10.18	34.28	56.00	-21.72	QP	
6		2.1860	20.43	10.18	30.61	46.00	-15.39	AVG	
7		7.9100	30.13	10.20	40.33	60.00	-19.67	QP	
8		7.9100	21.70	10.20	31.90	50.00	-18.10	AVG	
9		10.5540	32.33	10.22	42.55	60.00	-17.45	QP	
10		10.5540	22.69	10.22	32.91	50.00	-17.09	AVG	
11		13.2020	30.99	10.23	41.22	60.00	-18.78	QP	
12		13.2020	17.66	10.23	27.89	50.00	-22.11	AVG	

*:Maximum data x:Over limit !:over margin Comment: Factor build in receiver. Operator: Lian

6.5 Conducted Measurement Photos:



7. Radiated Emission Test

7.1 Measurement Procedure

1. The testing follows the guidelines in Spurious Radiated Emissions of ANSI C63.10-2013.
2. Below 1000MHz, The EUT was placed on a turn table which is 0.8m above ground plane. And above 1000MHz, The EUT was placed on a styrofoam table which is 1.5m above ground plane.
3. The EUT was set 3 meters from the interference receiving antenna, which was mounted on the top of a variable height antenna tower.
4. For each suspected emission, the EUT was arranged to its worst case and then tune the Antenna tower (From 1m to 4m) and turntable (from 0 degree to 360 degree) to find the maximum reading. A pre-amp and a high pass filter are used for the test in order to get better signal level to comply with the guidelines.
5. Set to the maximum power setting and enable the EUT transmit continuously.
6. Final measurement (Above 1GHz): The frequency range will be divided into different sub ranges depending of the frequency range of the used horn antenna. The EMI Receiver set to peak and average mode and a resolution bandwidth of 1MHz. The measurement will be performed in horizontal and vertical polarization of the measuring antenna and while rotating the EUT in its vertical axis in the range of 0 degree to 360 degree in order to have the antenna inside the cone of radiation.
7. Test Procedure of measurement (For Above 1GHz):
 - 1) Monitor the frequency range at horizontal polarization and move the antenna over all sides of the EUT(if necessary move the EUT to another orthogonal axis).
 - 2) Change the antenna polarization and repeat 1) with vertical polarization.
 - 3) Make a hardcopy of the spectrum.
 - 4) Measure the frequency of the detected emissions with a lower span and resolution bandwidth to increase the accuracy and note the frequency value.
 - 5) Change the analyser mode to Clear/ Write and found the cone of emission.
 - 6) Rotate and move the EUT, so that the measuring distance can be enlarged to 3m and the antenna will be still inside the cone of emission.
 - 7) Measure the level of the detected frequency with the correct resolution bandwidth, with the antenna polarization and azimuth and the peak and average detector, which causes the maximum emission.
 - 8) Repeat steps 1) to 7) for the next antenna spot if the EUT is larger than the antenna beamwidth.

Use the following spectrum analyzer settings:

When spectrum scanned from 30MHz to 1GHz setting resolution bandwidth 120KHz and video bandwidth 300KHz:

EMI Test Receiver	Setting
Attenuation	Auto
RB	120KHz
VB	300KHz
Detector	QP
Trace	Max hold

When spectrum scanned above 1GHz setting resolution bandwidth 1MHz, video bandwidth 3MHz:

EMI Test Receiver	Setting
Attenuation	Auto
RB	1MHz
VB	3MHz
Detector	Peak
Trace	Max hold

When spectrum scanned above 1GHz setting resolution bandwidth 1MHz, video bandwidth 10Hz:

EMI Test Receiver	Setting
Attenuation	Auto
RB	1MHz
VB	10Hz
Detector	Average
Trace	Max hold

7.2 Test SET-UP (Block Diagram of Configuration)

(A) Radiated Emission Test Set-Up, Frequency Below 30MHz

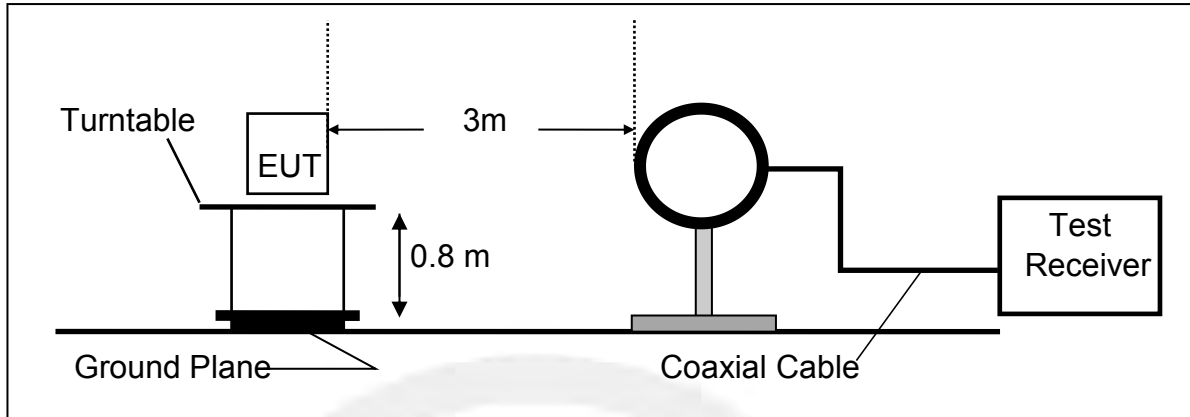

(B) Radiated Emission Test Set-Up, Frequency Below 1000MHz

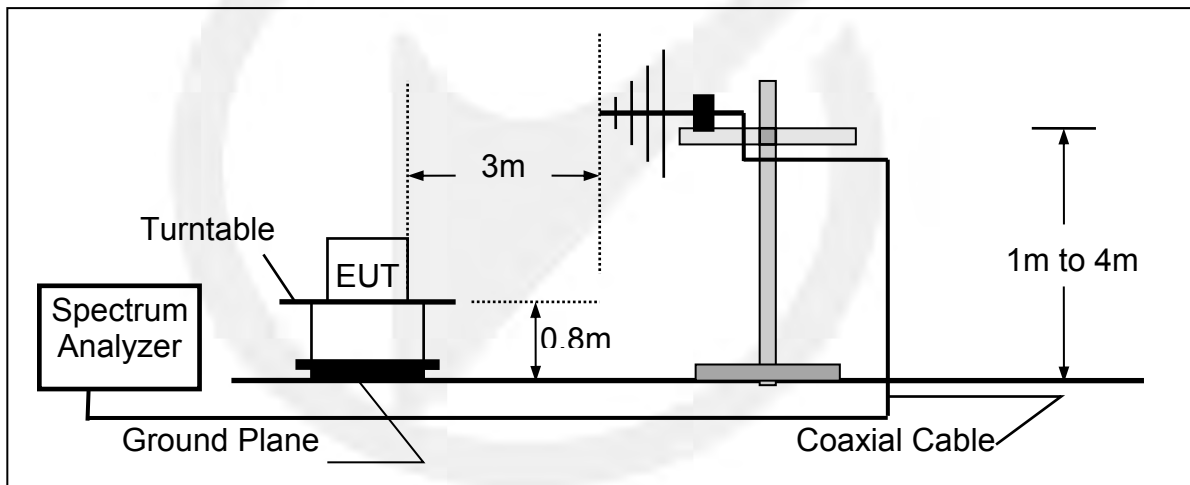

(C) Radiated Emission Test Set-Up, Frequency above 1000MHz

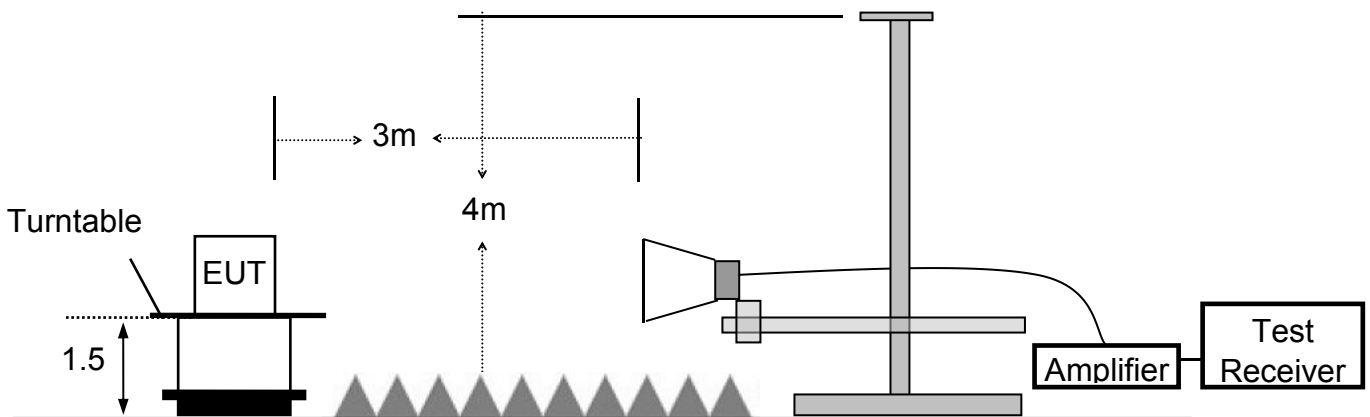

7.3 Measurement Equipment Used:

Item	Equipment	Manufacturer	Model No.	Serial No.	Characteristics	Last Cal.	Cal. Interval
1.	Test Receiver	Rohde & Schwarz	ESCI	1166.5950.0 3	9KHz-3GHz	05/16/2020	1 Year
2.	Loop Antenna	Schwarzbeck	FMZB 1519	012	9 KHz -30MHz	05/16/2020	1 Year
3.	Bilog Antenna	Schwarzbeck	VULB9163	000141	25MHz-2GHz	05/16/2020	1 Year
4.	Power Amplifier	CDS	RSU-M352	818	1MHz-1GHz	05/16/2020	1 Year
5.	Power Amplifier	HP	8447F	OPT H64	1GHz-26.5GHz	05/16/2020	1 Year
6.	Color Monitor	SUNSP0	SP-140A	N/A	--	05/16/2020	1 Year
7.	Single Line Filter	JIANLI	XL-3	N/A	--	05/16/2020	1 Year
8.	Single Phase Power Line Filter	JIANLI	DL-2X100B	N/A	--	05/16/2020	1 Year
9.	3 Phase Power Line Filter	JIANLI	DL-4X100B	N/A	--	05/16/2020	1 Year
10.	DC Power Filter	JIANLI	DL-2X50B	N/A	--	05/16/2020	1 Year
11.	Cable	Schwarzbeck	PLF-100	549489	9KHz-3GHz	05/16/2020	1 Year
12.	Cable	Rosenberger	CIL02	A0783566	9KHz-3GHz	05/16/2020	1 Year
13.	Cable	Rosenberger	RG 233/U	525178	9KHz-3GHz	05/16/2020	1 Year
14.	Signal Analyzer	Rohde & Schwarz	FSV30	103040	9KHz-40GHz	05/16/2020	1 Year
15.	Horn Antenna	Schwarzbeck	BBHA9120D	9120D-1272	1GHz-18GHz	05/16/2020	1 Year
16.	Horn Antenna	Schwarzbeck	BBHA 9170	BBHA91703 99	14GHz -26.5GHz	05/16/2020	1 Year
17.	Power Amplifier	LUNAR EM	LNA1G18-4 0	J101000000 81	1GHz-26.5GHz	05/16/2020	1 Year
18.	Cable	H+S	CBL-26	N/A	1GHz-26.5GHz	05/16/2020	1 Year
19.	Cable	H+S	CBL-26	N/A	1GHz-26.5GHz	05/16/2020	1 Year
20.	Cable	H+S	CBL-26	N/A	1GHz-26.5GHz	05/16/2020	1 Year

7.4 Radiated Emission Limit

The emissions from an intentional radiator shall not exceed the field strength levels specified in the following table 15.209(a):

Frequencies (MHz)	Field Strength (microvolt/meter)	Measurement Distance (meters)
0.009~0.490	2400/F(KHz)	300
0.490~1.705	24000/F(KHz)	30
1.705~30.0	30	30
30~88	100	3
88~216	150	3
216~960	200	3
Above 960	500	3

15.205 Restricted bands of operation

MHz	MHz	MHz	GHz
0.090 - 0.110	16.42 - 16.423	399.9 - 410	4.5 - 5.15
¹ 0.495 - 0.505	16.69475 - 16.69525	608 - 614	5.35 - 5.46
2.1735 - 2.1905	16.80425 - 16.80475	960 - 1240	7.25 - 7.75
4.125 - 4.128	25.5 - 25.67	1300 - 1427	8.025 - 8.5
4.17725 - 4.17775	37.5 - 38.25	1435 - 1626.5	9.0 - 9.2
4.20725 - 4.20775	73 - 74.6	1645.5 - 1646.5	9.3 - 9.5
6.215 - 6.218	74.8 - 75.2	1660 - 1710	10.6 - 12.7
6.26775 - 6.26825	108 - 121.94	1718.8 - 1722.2	13.25 - 13.4
6.31175 - 6.31225	123 - 138	2200 - 2300	14.47 - 14.5
8.291 - 8.294	149.9 - 150.05	2310 - 2390	15.35 - 16.2
8.362 - 8.366	156.52475 - 156.52525	2483.5 - 2500	17.7 - 21.4
8.37625 - 8.38675	156.7 - 156.9	2690 - 2900	22.01 - 23.12
8.41425 - 8.41475	162.0125 - 167.17	3260 - 3267	23.6 - 24.0
12.29 - 12.293	167.72 - 173.2	3332 - 3339	31.2 - 31.8
12.51975 - 12.52025	240 - 285	3345.8 - 3358	36.43 - 36.5
12.57675 - 12.57725	322 - 335.4	3600 - 4400	(²)

- Remark:
1. Emission level in dBuV/m=20 log (uV/m)
 2. Measurement was performed at an antenna to the closed point of EUT distance of meters.
 3. Only spurious frequency is permitted to locate within the Restricted Bands specified in provision of § 15.205, and the emissions located in restricted bands also comply with 15.209 limit.

7.5 Measurement Result

Operation Mode:	TX	Test Date :	July 20, 2020
Test By:	Loren	Temperature :	28°C
Test Result:	PASS	Humidity :	65 %
Measured Distance:	3m		

Below 30MHz:

Freq. (MHz)	Ant.Pol. H/V	Emission Level (dBuV/m)	Limit 3m (dBuV/m)	Over (dB)
--	--	--	--	--

Note: The low frequency, which started from 9KHz-30MHz, was pre-scanned and the result which was 20dB lower than the limit line per 15.31(o) was not reported.

Below 1000MHz:

Pass.

All modulation modes have been tested, the worst mode is (GFSK TX 2402MHz), the data is recorded on the following page, other modulation modes do not exceed this limit.

Please refer to the following data.



Site: Chamber #1 Polarization: *Horizontal* Temperature: 26.9
 Limit: (RE)FCC PART 15 C 3m Power: DC 9V form adapter Humidity: 70 %
 Mode: TX 2402
 Note:

No.	Mk.	Freq.	Reading Level	Correct Factor	Measurement	Limit	Over	Antenna Height	Table Degree	
		MHz	dBuV	dB	dBuV/m	dBuV/m	dB	cm	degree	Comment
1	*	99.1797	53.75	-18.69	35.06	43.50	-8.44	QP		
2		137.9028	56.20	-21.51	34.69	43.50	-8.81	QP		
3		225.3080	45.87	-16.58	29.29	46.00	-16.71	QP		
4		287.9904	43.52	-14.21	29.31	46.00	-16.69	QP		
5		426.5210	33.88	-10.38	23.50	46.00	-22.50	QP		
6		836.2443	40.08	-3.01	37.07	46.00	-8.93	QP		

*:Maximum data x:Over limit !:over margin

Operator: Lian



Site Chamber #1 Polarization: *Vertical* Temperature: 26.9
 Limit: (RE)FCC PART 15 C 3m Power: DC 9V form adapter Humidity: 70 %
 Mode: TX 2402
 Note:

No.	Mk.	Freq. MHz	Reading Level dBuV	Correct Factor dB	Measure- ment dBuV/m	Limit dBuV/m	Over dB	Antenna Height cm	Table Degree	Detector	Comment
1	*	35.6240	51.79	-18.33	33.46	40.00	-6.54			QP	
2		53.5052	43.59	-15.76	27.83	40.00	-12.17			QP	
3		93.1132	48.16	-19.30	28.86	43.50	-14.64			QP	
4		140.3421	57.20	-21.50	35.70	43.50	-7.80			QP	
5		213.0151	48.02	-17.30	30.72	43.50	-12.78			QP	
6		419.1081	38.16	-10.53	27.63	46.00	-18.37			QP	

*:Maximum data x:Over limit !:over margin

Operator: Lian

Above 1000MHz~10th Harmonics:

All modulation modes have been tested, the worst mode is (GFSK), the data is recorded on the following page, other modulation modes do not exceed this limit. Please refer to the following data.

Operation Mode: GFSK (CH1: 2402MHz)

Test Date : July 21, 2020

Freq. (MHz)	Ant. Pol. H/V	Reading Level(dBuV/m)		Correct Factor dB	Emission Level(dBuV/m)		Limit 3m		Margin(dB)	
		PK	AV		PK	AV	PK	AV	PK	AV
4804	V	97.01	73.79	-32.3	64.71	41.49	74	54	-9.29	-12.51
7206	V	97.04	70.91	-37.2	59.84	33.71	74	54	-14.16	-20.29
9608	V	91.23	73.95	-39.8	51.43	34.15	74	54	-22.57	-19.85
12010	V	96.15	74.06	-40.5	55.65	33.56	74	54	-18.35	-20.44
14412	V	95.15	73.91	-41.7	53.45	32.21	74	54	-20.55	-21.79
16814	V	97.42	72.38	-40.0	57.42	32.38	74	54	-16.58	-21.62
4804	H	91.18	76.35	-31.6	59.58	44.75	74	54	-14.42	-9.25
7206	H	94.81	71.30	-35.5	59.31	35.80	74	54	-14.69	-18.20
9608	H	97.79	74.39	-38.3	59.49	36.09	74	54	-14.51	-17.91
12010	H	93.74	74.28	-39.0	54.74	35.28	74	54	-19.26	-18.72
14412	H	92.04	70.36	-42.0	50.04	28.36	74	54	-23.96	-25.64
16814	H	96.48	71.30	-39.3	57.18	32.00	74	54	-16.82	-22.00

Operation Mode: GFSK (CH40: 2441MHz)

Test Date : July 21, 2020

Freq. (MHz)	Ant. Pol. H/V	Reading Level(dBuV/m)		Correct Factor dB	Emission Level(dBuV/m)		Limit 3m(dBuV/m)		Margin(dB)	
		PK	AV		PK	AV	PK	AV	PK	AV
4880	V	95.16	70.01	-32.3	62.86	37.71	74	54	-11.14	-16.29
7320	V	92.19	70.80	-37.2	54.99	33.6	74	54	-19.01	-20.40
9760	V	92.02	71.76	-39.8	52.22	31.96	74	54	-21.78	-22.04
12200	V	96.30	70.84	-40.5	55.8	30.34	74	54	-18.20	-23.66
14640	V	94.57	71.37	-41.0	53.57	30.37	74	54	-20.43	-23.63
17080	V	92.63	70.45	-41.1	51.53	29.35	74	54	-22.47	-24.65
4880	H	92.39	73.08	-31.6	60.79	41.48	74	54	-13.21	-12.52
7320	H	91.63	71.48	-35.5	56.13	35.98	74	54	-17.87	-18.02
9760	H	98.99	71.90	-38.3	60.69	33.6	74	54	-13.31	-20.40
12200	H	95.14	76.39	-39.0	56.14	37.39	74	54	-17.86	-16.61
14640	H	95.80	71.89	-42.0	53.8	29.89	74	54	-20.20	-24.11
17080	H	95.08	72.88	-41.5	53.58	31.38	74	54	-20.42	-22.62

Operation Mode: GFSK (CH79: 2480MHz)

Test Date : July 21, 2020

Freq. (MHz)	Ant. Pol.	Reading Level(dBuV/m)		Correct Factor dB	Emission Level(dBuV/m)		Limit 3m(dBuV/m)		Margin(dB)	
		PK	AV		PK	AV	PK	AV	PK	AV
4960	V	95.07	72.24	-32.3	62.77	39.94	74	54	-11.23	-14.06
7440	V	96.28	76.34	-37.2	59.08	39.14	74	54	-14.92	-14.86
9920	V	94.51	76.87	-39.8	54.71	37.07	74	54	-19.29	-16.93
12400	V	93.34	70.93	-40.5	52.84	30.43	74	54	-21.16	-23.57
14880	V	95.95	75.40	-41	54.95	34.4	74	54	-19.05	-19.6
17360	V	95.99	74.17	-41.1	54.89	33.07	74	54	-19.11	-20.93
4960	H	95.75	70.58	-31.6	64.15	38.98	74	54	-9.85	-15.02
7440	H	93.93	70.86	-35.5	58.43	35.36	74	54	-15.57	-18.64
9920	H	92.00	75.23	-38.3	53.7	36.93	74	54	-20.3	-17.07
12400	H	92.87	71.10	-39	53.87	32.1	74	54	-20.13	-21.9
14880	H	91.23	71.45	-42	49.23	29.45	74	54	-24.77	-24.55
17360	H	98.17	74.21	-41.5	56.67	32.71	74	54	-17.33	-21.29

Other harmonics emissions are lower than 20dB below the allowable limit.

- Note:**
- (1) All Readings are Peak Value and AV.
 - (2) Emission Level= Reading Level+ Probe Factor +Cable Loss.
 - (3) The average measurement was not performed when the peak measured data under the limit of average detection.
 - (4) Measuring frequencies from 1GHz to 25GHz.

7.5 Radiated Measurement Photos:

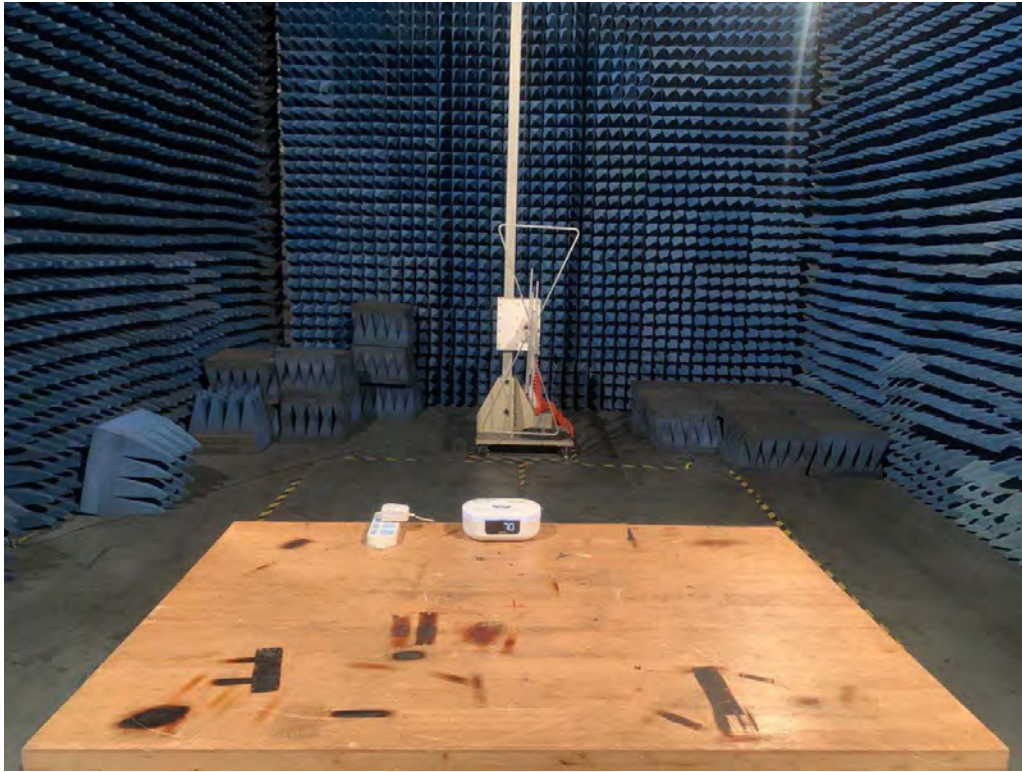

+

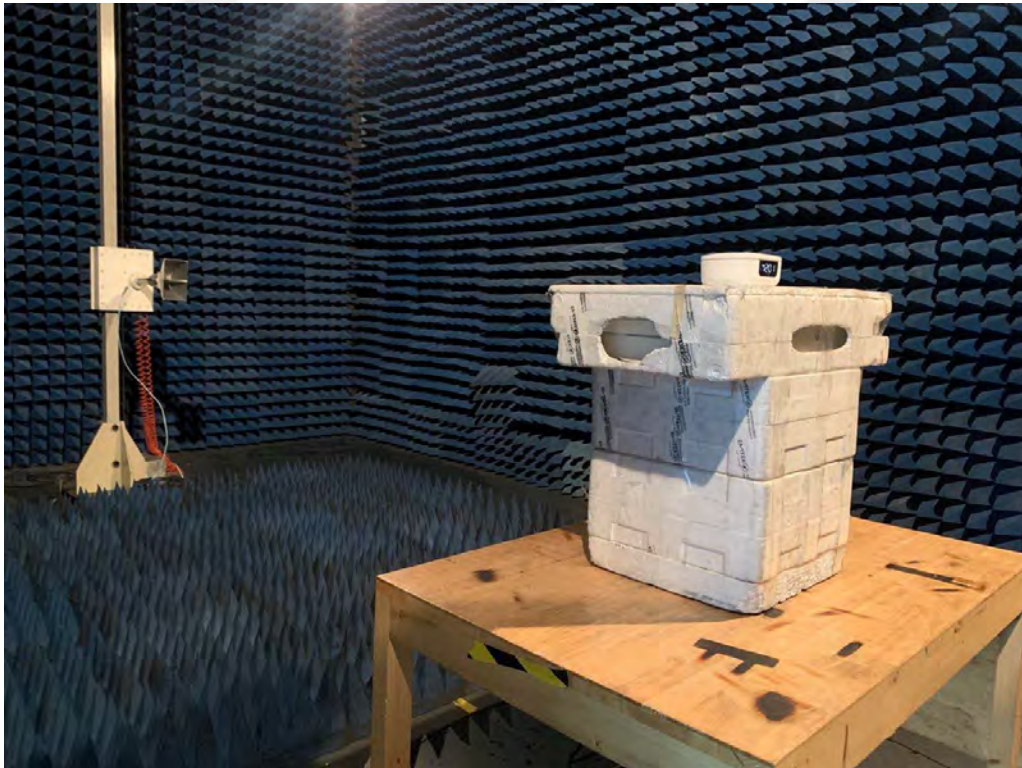

8. Channel Separation test

8.1 Measurement Procedure

The EUT was operating in hopping mode or could be controlled its channel. Printed out the test result from the spectrum by hard copy function.

8.2 Test SET-UP (Block Diagram of Configuration)

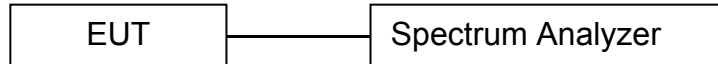

8.3 Measurement Equipment Used:

EQUIPMENT TYPE	MFR	MODEL NUMBER	SERIAL NUMBER	Characteristics	LAST CAL.	CAL DUE.
Spectrum Analyzer	Rohde & Schwarz	FSV30	1321.3008K	10Hz-30GHz	05/16/2020	05/15/2021
Coaxial Cable	CDS	79254	46107086	10Hz-30GHz	05/16/2020	05/15/2021
Antenna Connector	ARTHUR-YANG	2244-N1TG1	N/A	10Hz-30GHz	05/16/2020	05/15/2021

Remark: The temporary antenna connector is soldered on the PCB board in order to perform conducted tests and this temporary antenna connector is listed in the equipment list.

8.4 Measurement Results:

Refer to attached data chart.

Spectrum Detector:	PK	Test Date :	July 21, 2020
Test By:	Loren	Temperature :	24°C
Test Result:	PASS	Humidity :	53 %
Modulation:	GFSK		

Channel number	Channel frequency (MHz)	Separation Read Value (kHz)	Separation Limit 2/3 20dB Down BW(kHz)
1	2402	1003	>755
40	2441	1003	>746
79	2480	999	>755



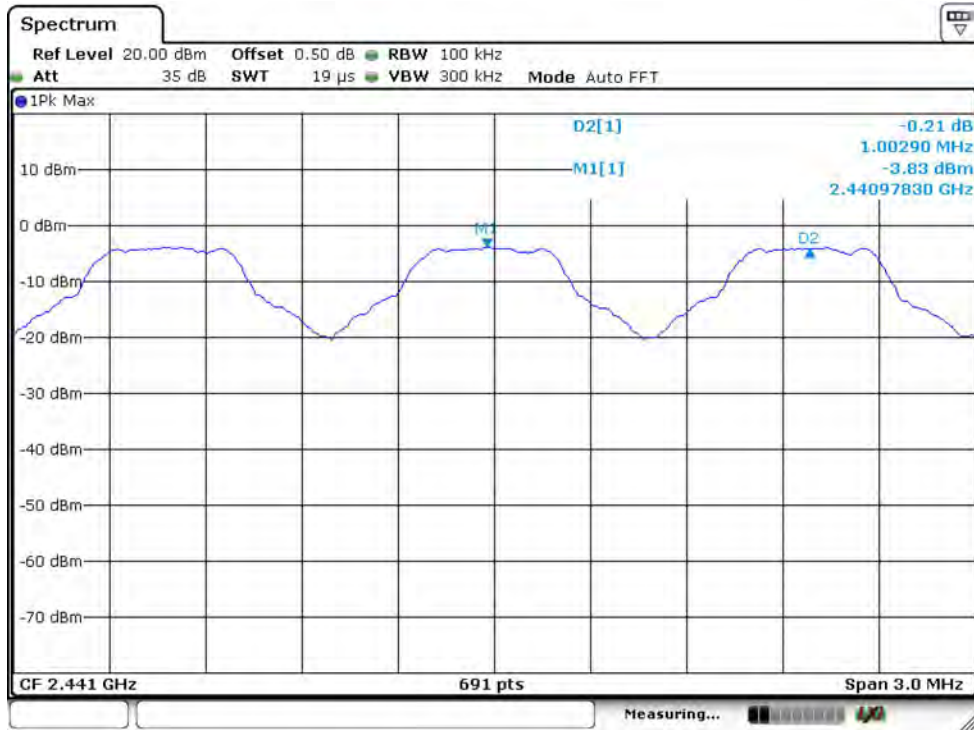

Spectrum Detector:	PK	Test Date :	July 21, 2020
Test By:	Loren	Temperature :	24°C
Test Result:	PASS	Humidity :	53 %
Modulation:	Π/4-DQPSK		

Channel number	Channel frequency (MHz)	Separation Read Value (kHz)	Separation Limit 2/3 20dB Down BW(kHz)
1	2402	1007	>949
40	2441	1003	>932
79	2480	1003	>938



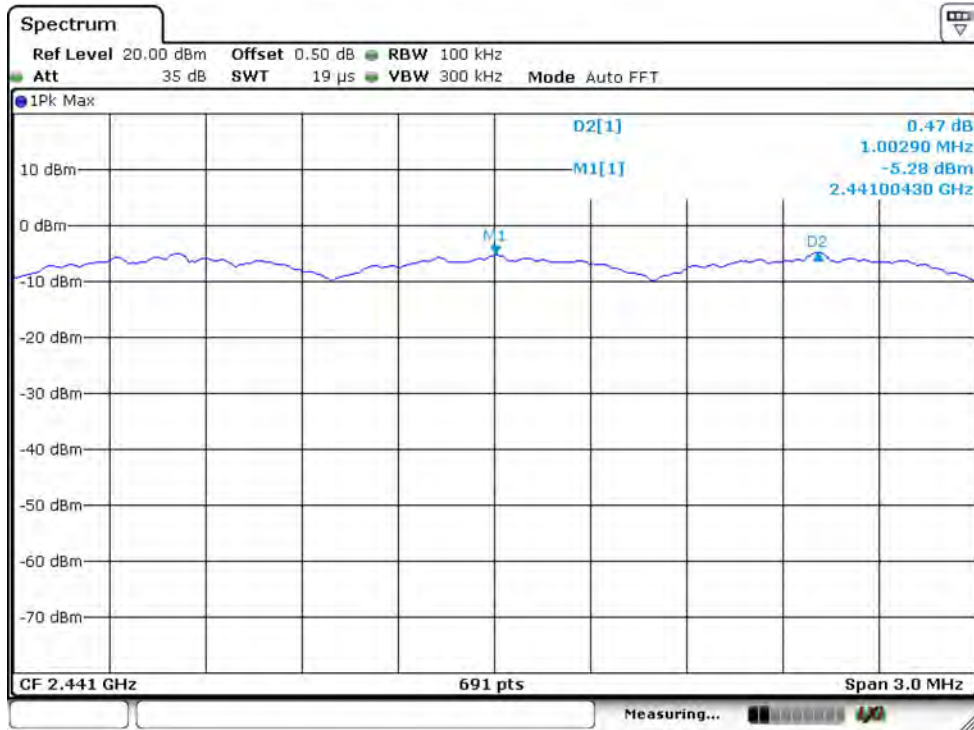

Spectrum Detector:	PK	Test Date :	July 21, 2020
Test By:	Loren	Temperature :	24°C
Test Result:	PASS	Humidity :	53 %
Modulation:	8DPSK		

Channel number	Channel frequency (MHz)	Separation Read Value (kHz)	Separation Limit 2/3 20dB Down BW(kHz)
1	2402	999	>940
40	2441	999	>938
79	2480	1003	>943



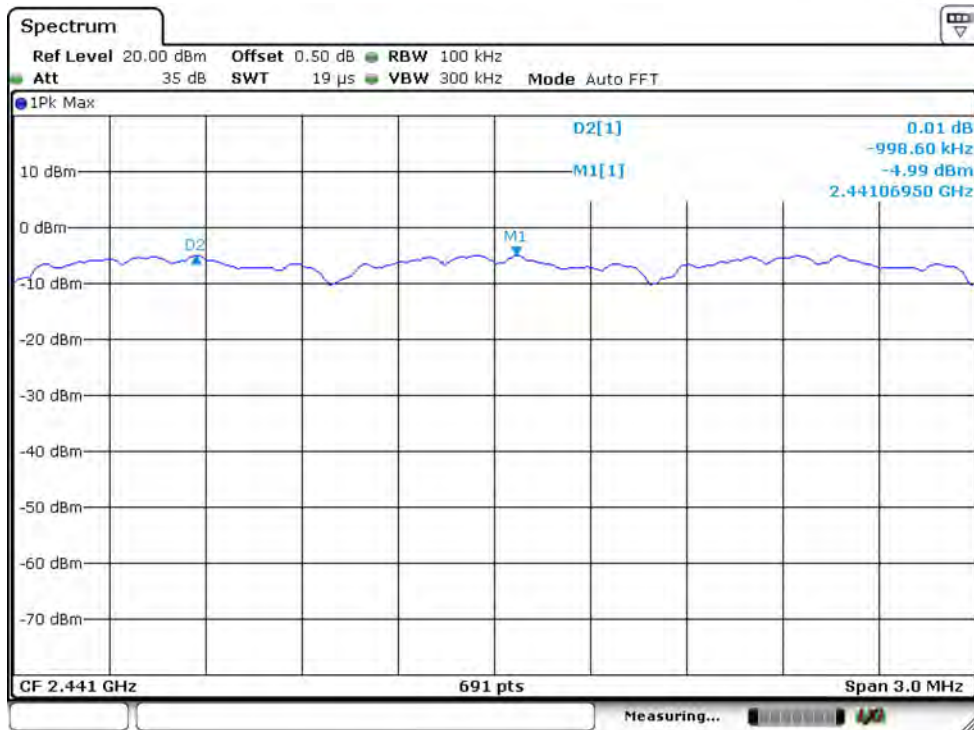

9. 20dB Bandwidth test

9.1 Measurement Procedure

The EUT was operating in hopping mode or could be controlled its channel. Printed out the test result from the spectrum by hard copy function.

9.2 Test SET-UP (Block Diagram of Configuration)

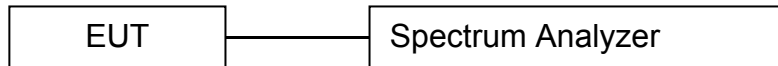

9.3 Measurement Equipment Used:

EQUIPMENT TYPE	MFR	MODEL NUMBER	SERIAL NUMBER	Characteristics	LAST CAL.	CAL DUE.
Spectrum Analyzer	Rohde & Schwarz	FSV30	1321.3008K	10Hz-30GHz	05/16/2020	05/15/2021
Coaxial Cable	CDS	79254	46107086	10Hz-30GHz	05/16/2020	05/15/2021
Antenna Connector	ARTHUR-YANG	2244-N1TG1	N/A	10Hz-30GHz	05/16/2020	05/15/2021

Remark: The temporary antenna connector is soldered on the PCB board in order to perform conducted tests and this temporary antenna connector is listed in the equipment list.

9.4 Measurement Results:

Refer to attached data chart.

Spectrum Detector:	PK	Test Date :	July 21, 2020
Test By:	Loren	Temperature :	24°C
Test Result:	PASS	Humidity :	53 %
Modulation:	GFSK		

Channel number	Channel frequency (MHz)	20dB Down BW(kHz)
1	2402	1133
40	2441	1120
79	2480	1133

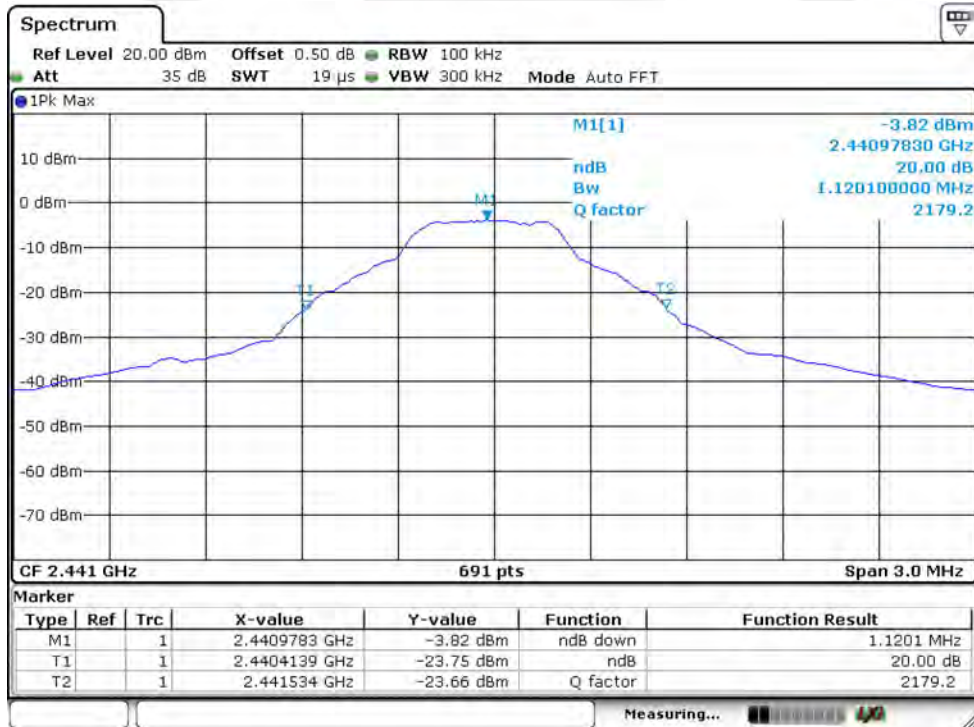
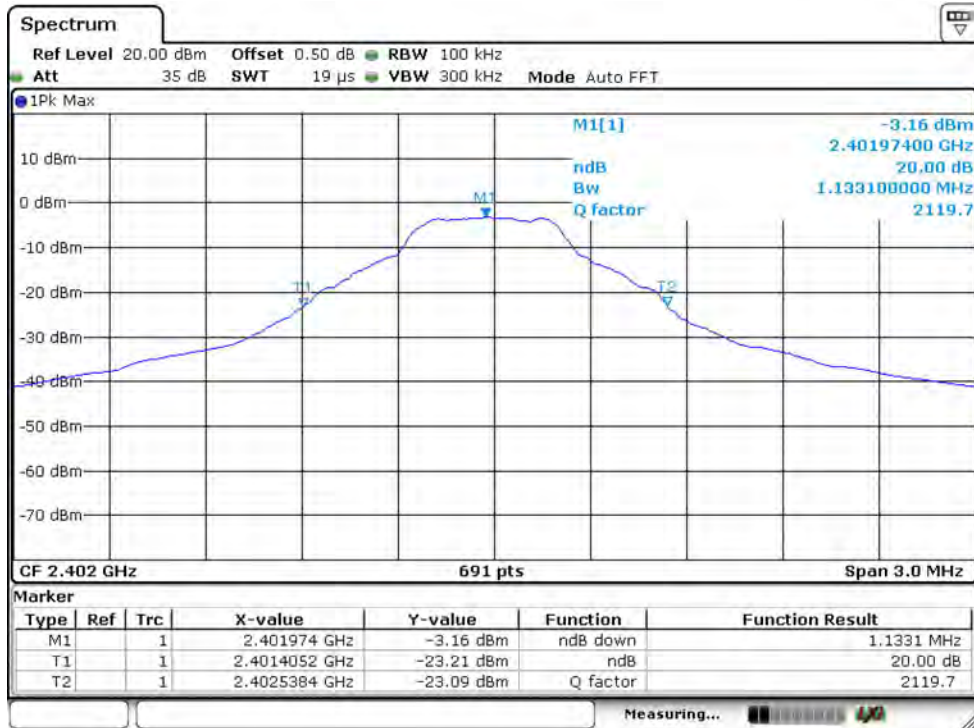

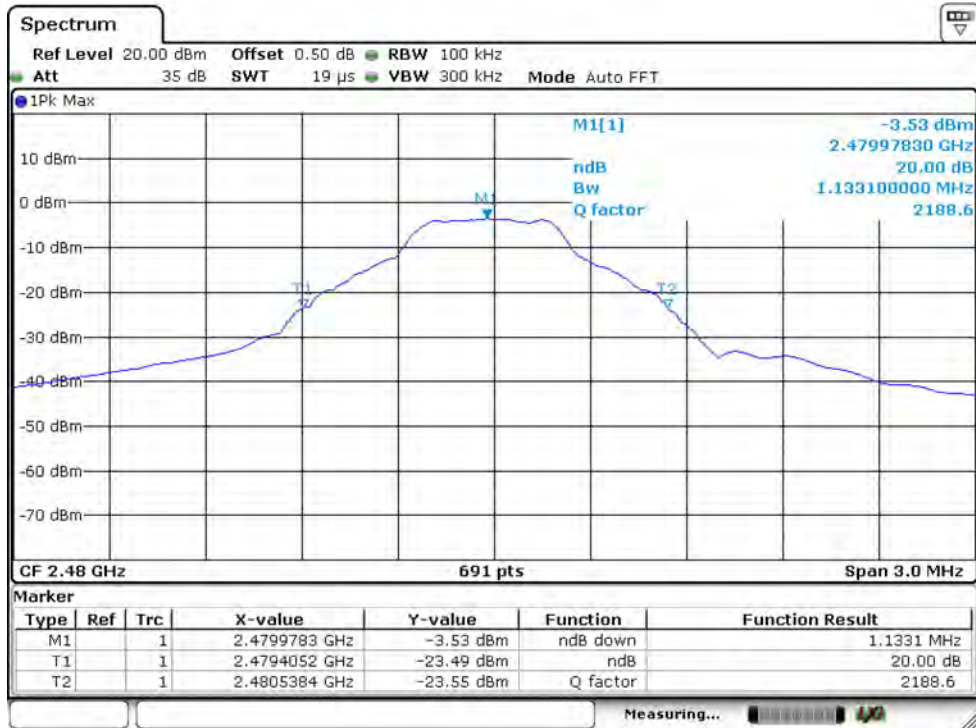

Spectrum Detector:	PK	Test Date :	July 21, 2020
Test By:	Loren	Temperature :	24°C
Test Result:	PASS	Humidity :	53 %
Modulation:	Π/4-DQPSK		

Channel number	Channel frequency (MHz)	20dB Down BW(kHz)
1	2402	1424
40	2441	1398
79	2480	1407



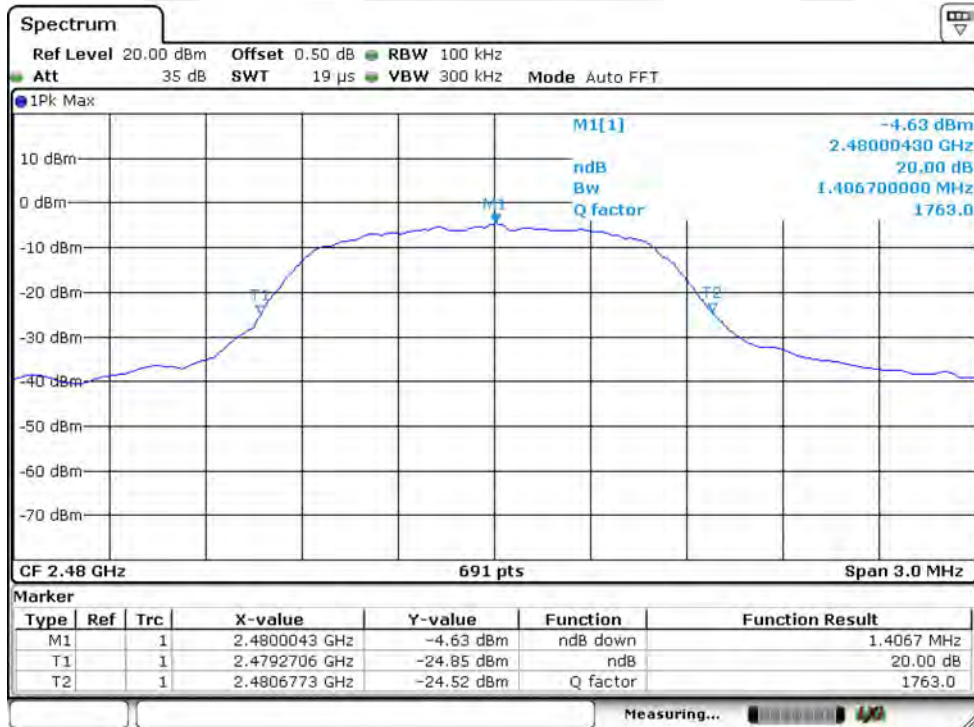
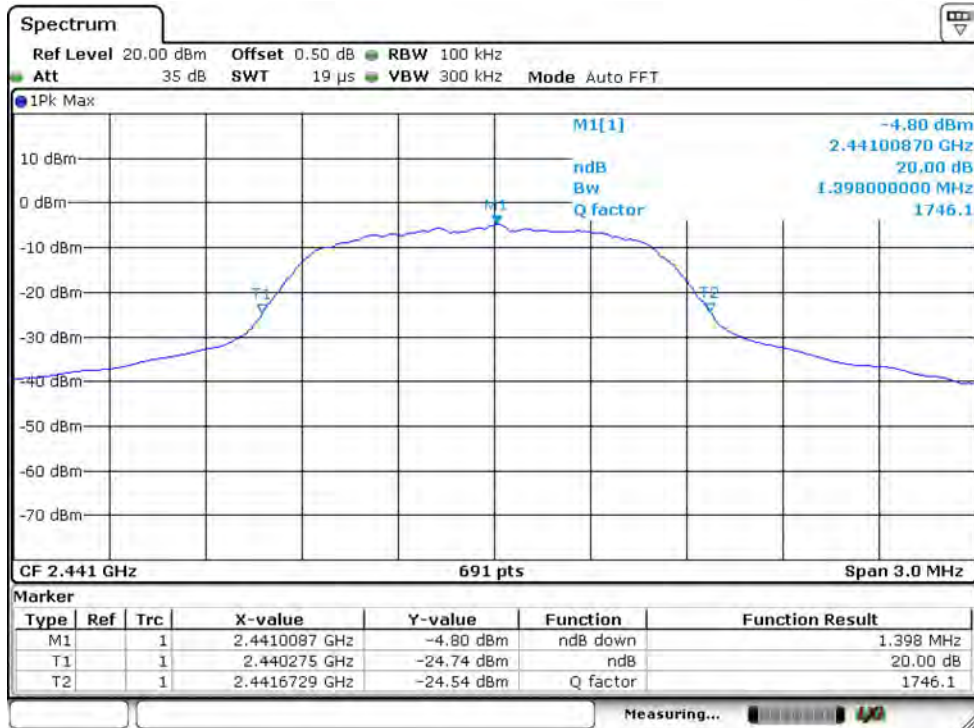

Spectrum Detector: PK
 Test By: Loren
 Test Result: PASS
 Modulation: 8DPSK

Test Date : July 21, 2020
 Temperature : 24°C
 Humidity : 53 %

Channel number	Channel frequency (MHz)	20dB Down BW(kHz)
1	2402	1411
40	2441	1407
79	2480	1415

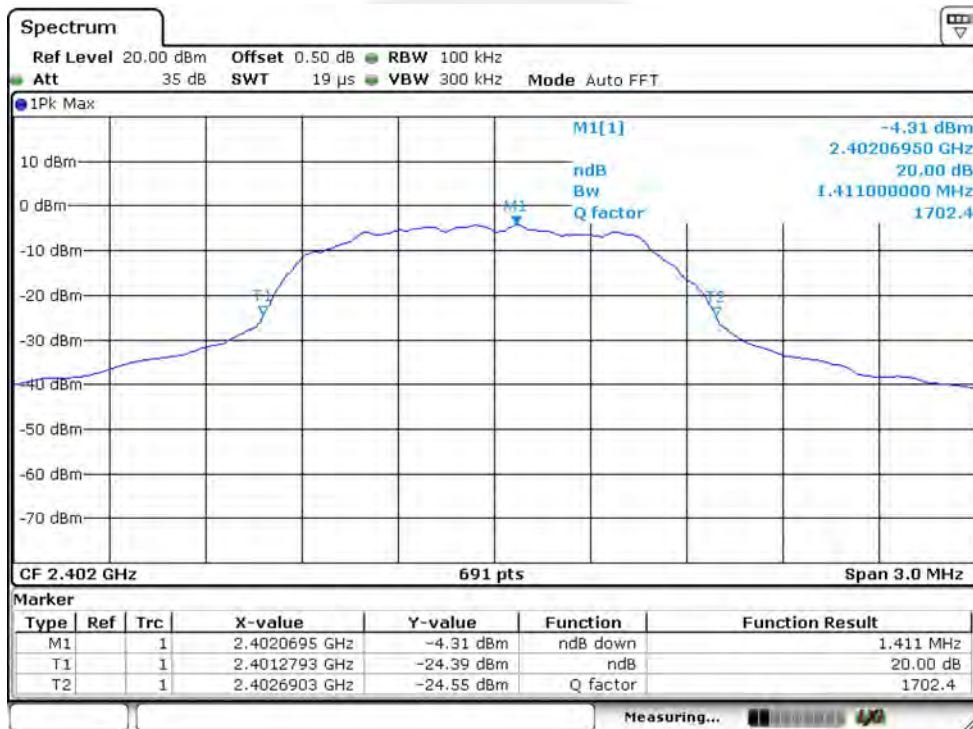

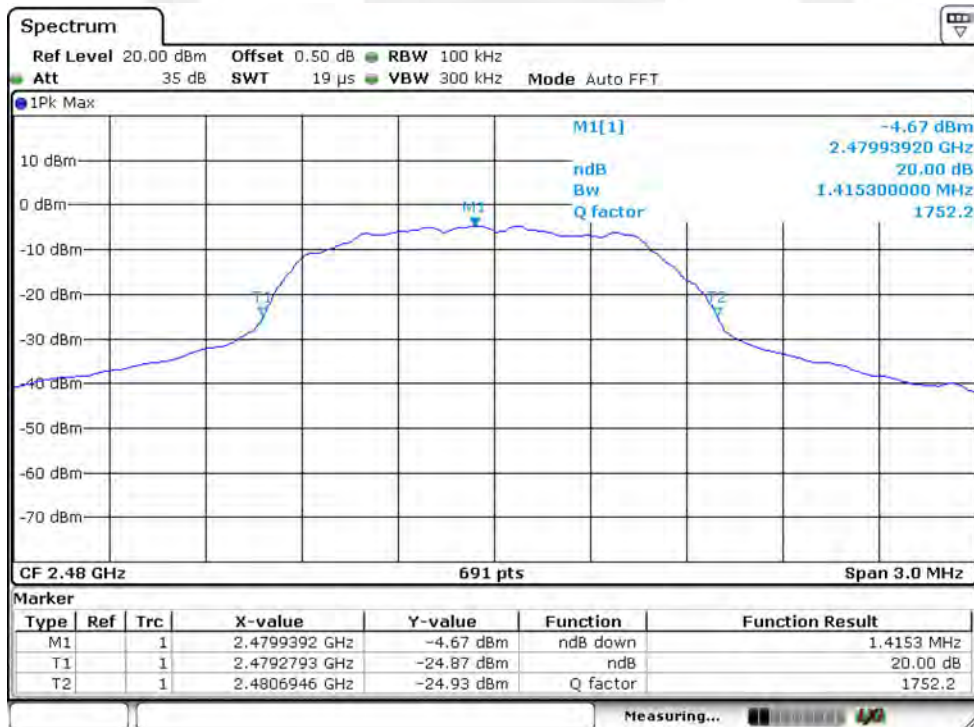
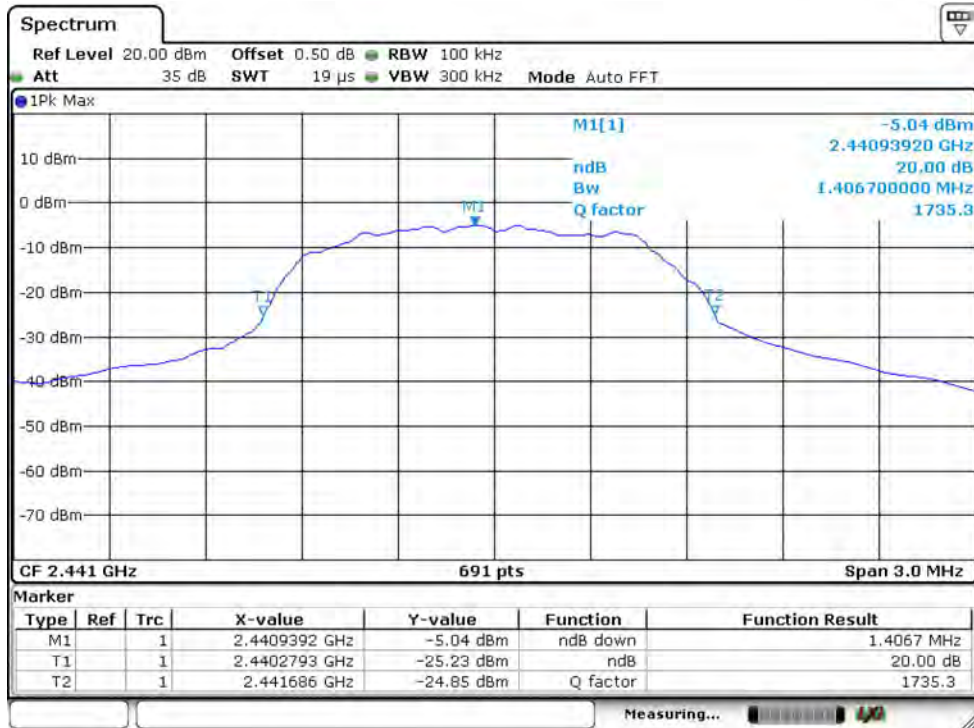

10. Quantity of Hopping Channel Test

10.1 Measurement Procedure

The EUT was operating in hopping mode or could be controlled its channel. Printed out the test result from the spectrum by hard copy function.

10.2 Test SET-UP (Block Diagram of Configuration)

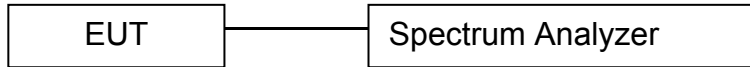

10.3 Measurement Equipment Used:

EQUIPMENT TYPE	MFR	MODEL NUMBER	SERIAL NUMBER	Characteristics	LAST CAL.	CAL DUE.
Spectrum Analyzer	Rohde & Schwarz	FSV30	1321.3008K	10Hz-30GHz	05/16/2020	05/15/2021
Coaxial Cable	CDS	79254	46107086	10Hz-30GHz	05/16/2020	05/15/2021
Antenna Connector	ARTHUR-YANG	2244-N1TG1	N/A	10Hz-30GHz	05/16/2020	05/15/2021

Remark: The temporary antenna connector is soldered on the PCB board in order to perform conducted tests and this temporary antenna connector is listed in the equipment list.

10.4 Measurement Results:

Refer to attached data chart.

Worst Test Mode	GFSK	Test Date :	July 21, 2020
Test By:	Loren	Temperature :	25 °C
Test Result:	PASS	Humidity :	50 %

Hopping Channel Frequency Range	Quantity of Hopping Channel	Quantity of Hopping Channel
2402-2480	79	> 15

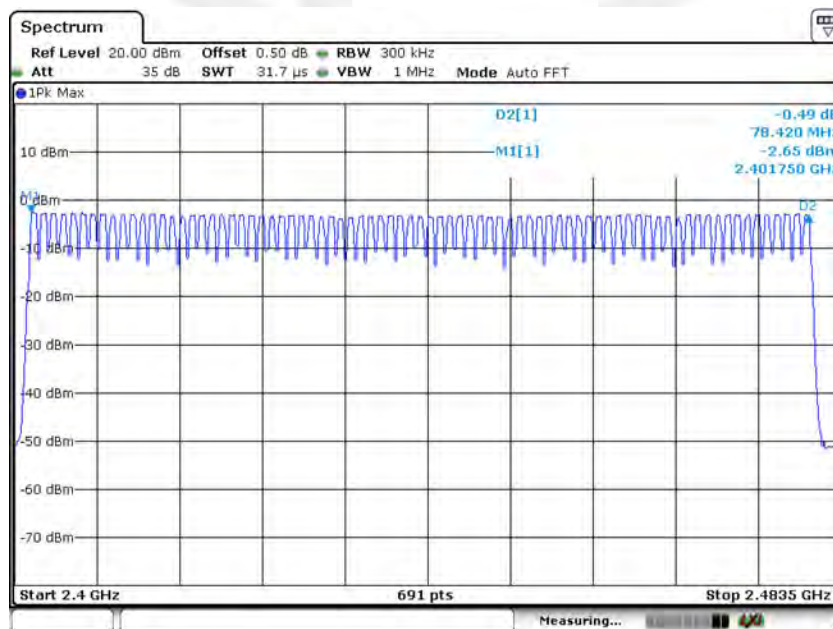

11. Time of Occupancy (Dwell Time) test

11.1 Test Description

The Equipment Under Test (EUT) was set up to perform the dwell time measurements. The EUT was connected to the spectrum analyzer via a short coax cable. The dwell time is calculated by:

$$\text{Dwell time} = \text{time slot length} * \text{hop rate} / \text{number of hopping channels} * 31.6\text{s}$$

with:

- hop rate = 1600 * 1/s for DH1 packets = 1600 s⁻¹
- hop rate = 1600/3 * 1/s for DH3 packets = 533.33 s⁻¹
- number of hopping channels = 79
- 31.6 s = 0.4 seconds multiplied by the number of hopping channels = 0.4 s * 79

The highest value of the dwell time is reported.

11.2 Test SET-UP (Block Diagram of Configuration)

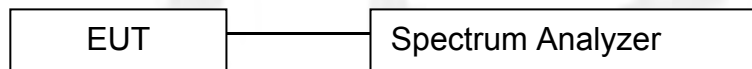

11.3 Measurement Equipment Used:

EQUIPMENT TYPE	MFR	MODEL NUMBER	SERIAL NUMBER	Characteristics	LAST CAL.	CAL DUE.
Spectrum Analyzer	Rohde & Schwarz	FSV30	1321.3008K	10Hz-30GHz	05/16/2020	05/15/2021
Coaxial Cable	CDS	79254	46107086	10Hz-30GHz	05/16/2020	05/15/2021
Antenna Connector	ARTHUR-YANG	2244-N1TG1	N/A	10Hz-30GHz	05/16/2020	05/15/2021

Remark: The temporary antenna connector is soldered on the PCB board in order to perform conducted tests and this temporary antenna connector is listed in the equipment list.

11.4 Test Requirements / Limits

FCC Part 15, Subpart C, §15.247 (a) (1) (iii)

Frequency hopping systems in the 2400-2483.5 MHz band shall use at least 15 channels. The average time of occupancy on any channel shall not be greater than 0.4 seconds within a period of 0.4 seconds multiplied by the number of hopping channels employed. Since the Bluetooth technology uses 79 channels this period is calculated to be 31.6seconds. Refer to attached data chart.

Modulation:	GFSK	Test Date :	July 21, 2020
Test By:	Loren	Temperature :	25 °C
Test Result:	PASS	Humidity :	50 %

11.5 Test result

Mode	Number of transmission in a 31.6(79 Hopping*0.4)	Length of transmissions time(msec)	Result (msec)	Limit (msec)
DH1	$1600/(2*79) \times 31.6 = 320$	0.378	120.96	400
DH3	$1600/(4*79) \times 31.6 = 160$	1.635	261.60	400
DH5	$1600/(6*79) \times 31.6 = 106.67$	2.914	310.84	400

Remark: The results of worst cased was recorded.

DH1:

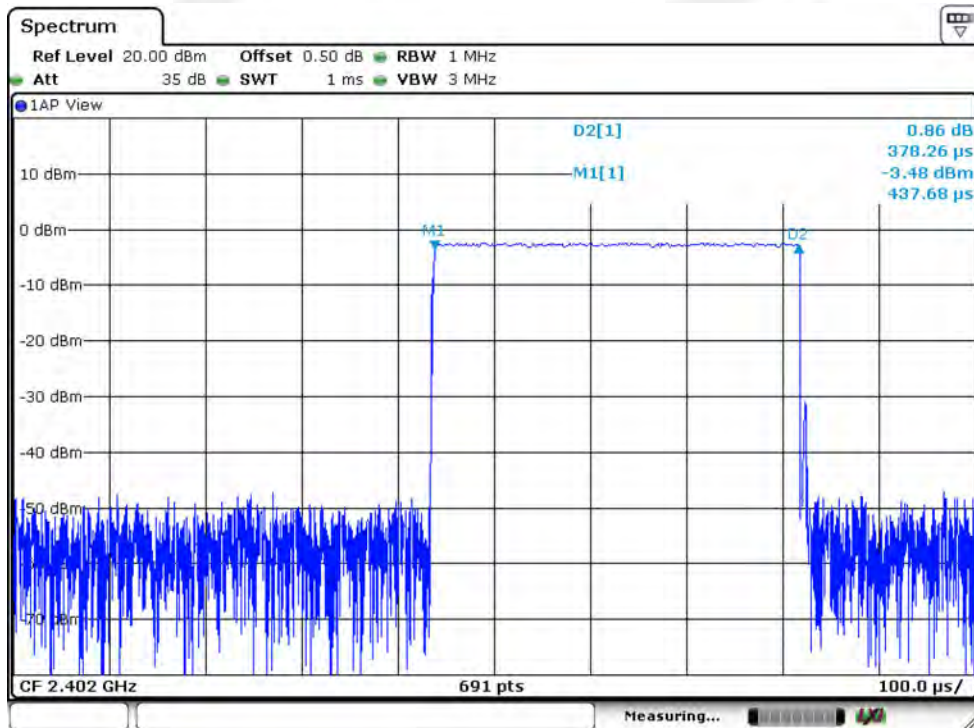

DH3:

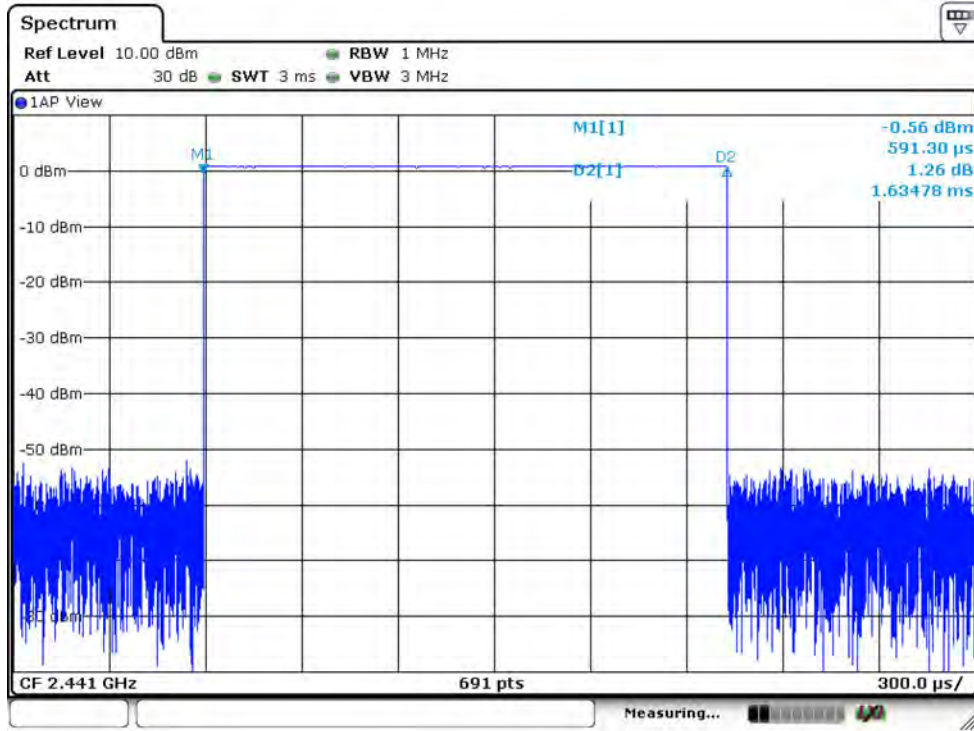

DH5:

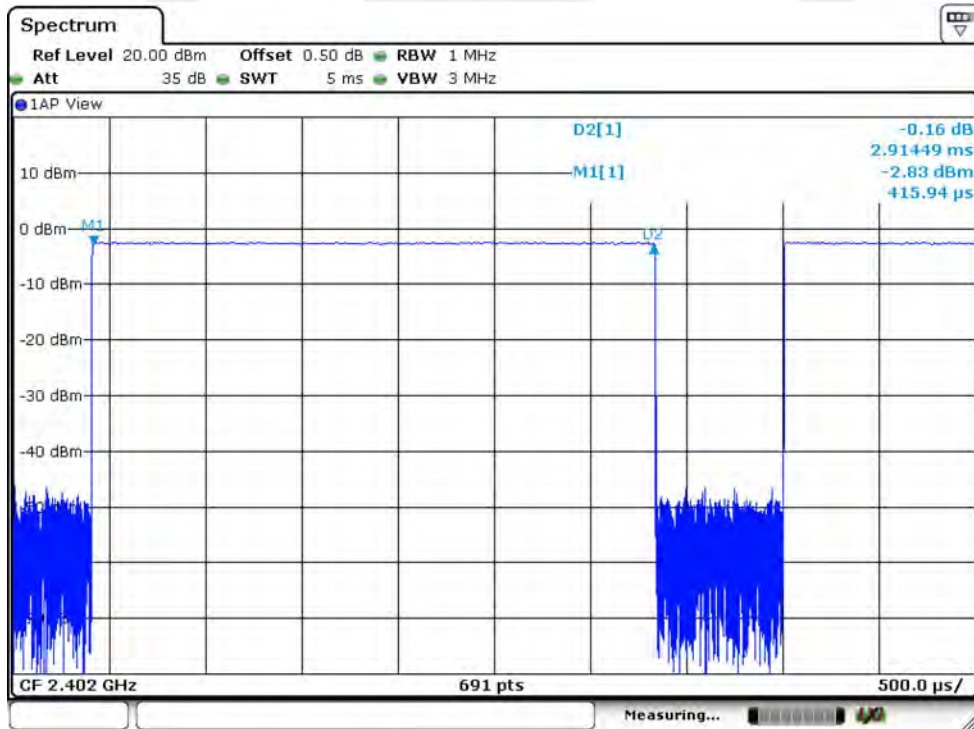

12. MAXIMUM PEAK OUTPUT POWER TEST

12.1 Measurement Procedure

- a. Check the calibration of the measuring instrument(SA) using either an internal calibrator or a known signal from an external generator.
- b. Turn on the EUT and connect it to measurement instrument. Then set it to any one convenient frequency within its operating range. Set a reference level on the measuring instrument equal to the highest peak value.
- c. The center frequency of the spectrum analyzer is set to the fundamental frequency and using proper RBW and VBW setting.
- d. Measure the captured power within the band and recording the plot.
- e. Repeat above procedures until all frequencies required were complete.

12.2 Test SET-UP (Block Diagram of Configuration)



12.3 Measurement Equipment Used:

EQUIPMENT TYPE	MFR	MODEL NUMBER	SERIAL NUMBER	Characteristics	LAST CAL.	CAL DUE.
Spectrum Analyzer	Rohde & Schwarz	FSV30	1321.3008K	10Hz-30GHz	05/16/2020	05/15/2021
Coaxial Cable	CDS	79254	46107086	10Hz-30GHz	05/16/2020	05/15/2021
Antenna Connector	ARTHUR-YANG	2244-N1TG1	N/A	10Hz-30GHz	05/16/2020	05/15/2021

Remark: The temporary antenna connector is soldered on the PCB board in order to perform conducted tests and this temporary antenna connector is listed in the equipment list.

12.4 Measurement Results:

Refer to attached data chart.

Spectrum Detector:	PK	Test Date :	July 21, 2020
Test By:	Loren	Temperature :	25 °C
Test Result:	PASS	Humidity :	50 %
Modulation:	GFSK		

Channel number	Channel Frequency (MHz)	Peak Power output(dBm)	Peak Power output(mW)	Peak Power Limit(mW)	Pass/Fail
01	2402	-2.44	0.570	1000	PASS
40	2441	-3.07	0.493	1000	PASS
79	2480	-2.74	0.532	1000	PASS



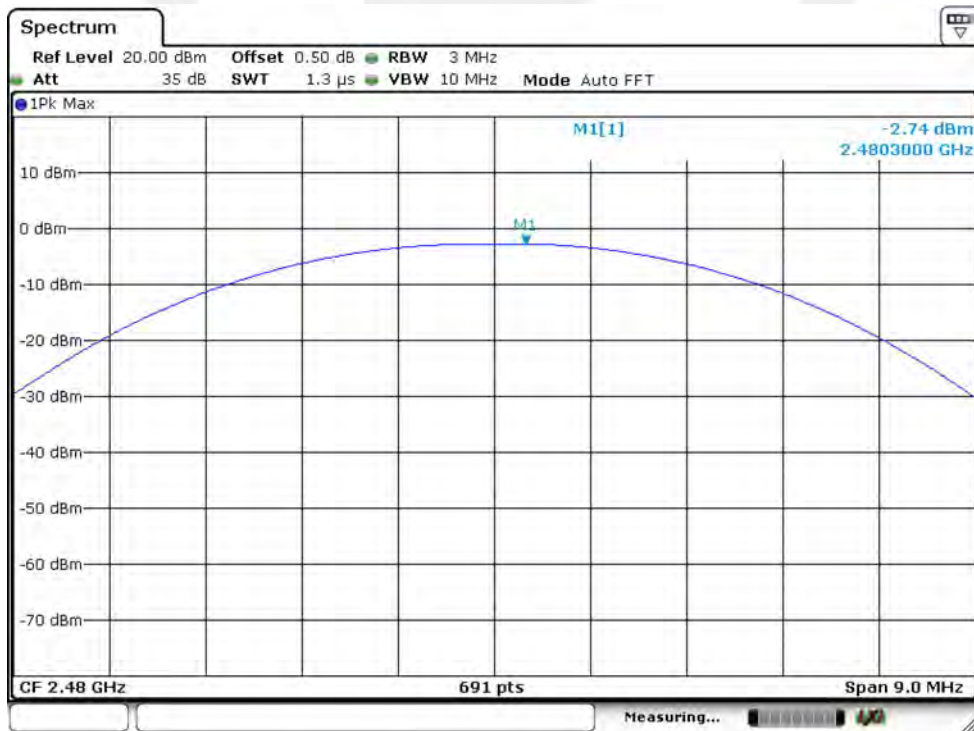
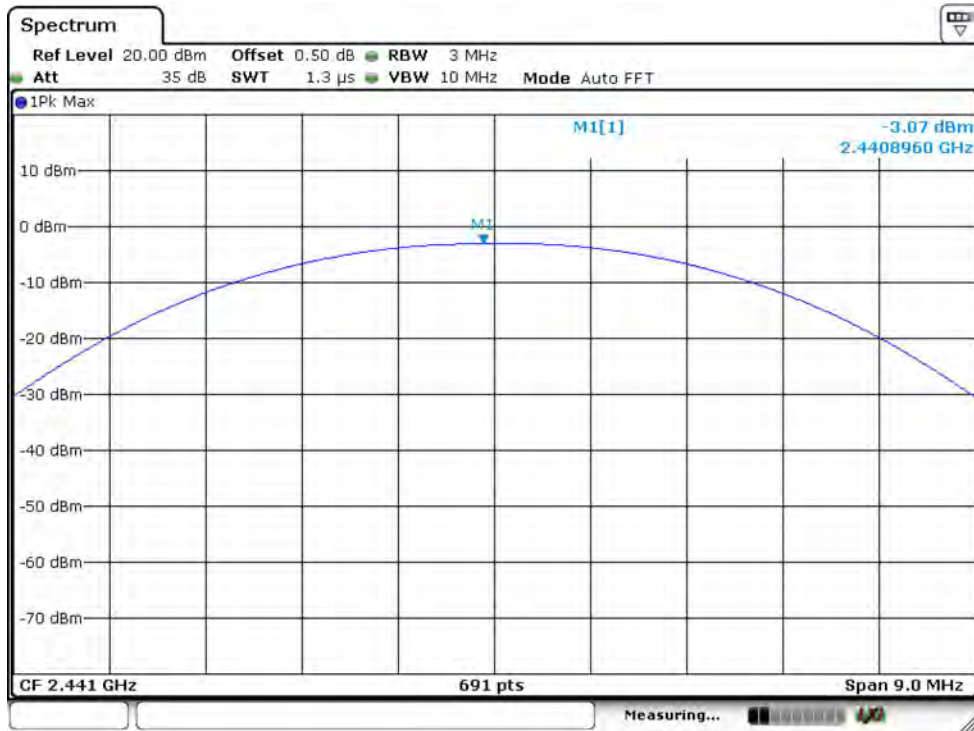

Spectrum Detector:	PK	Test Date :	July 21, 2020
Test By:	Loren	Temperature :	25 °C
Test Result:	PASS	Humidity :	50 %
Modulation:	Π/4-DQPSK		

Channel number	Channel Frequency (MHz)	Peak Power output(dBm)	Peak Power output(mW)	Peak Power Limit(mW)	Pass/Fail
01	2402	-0.51	0.889	125	PASS
40	2441	-1.09	0.778	125	PASS
79	2480	-0.85	0.822	125	PASS

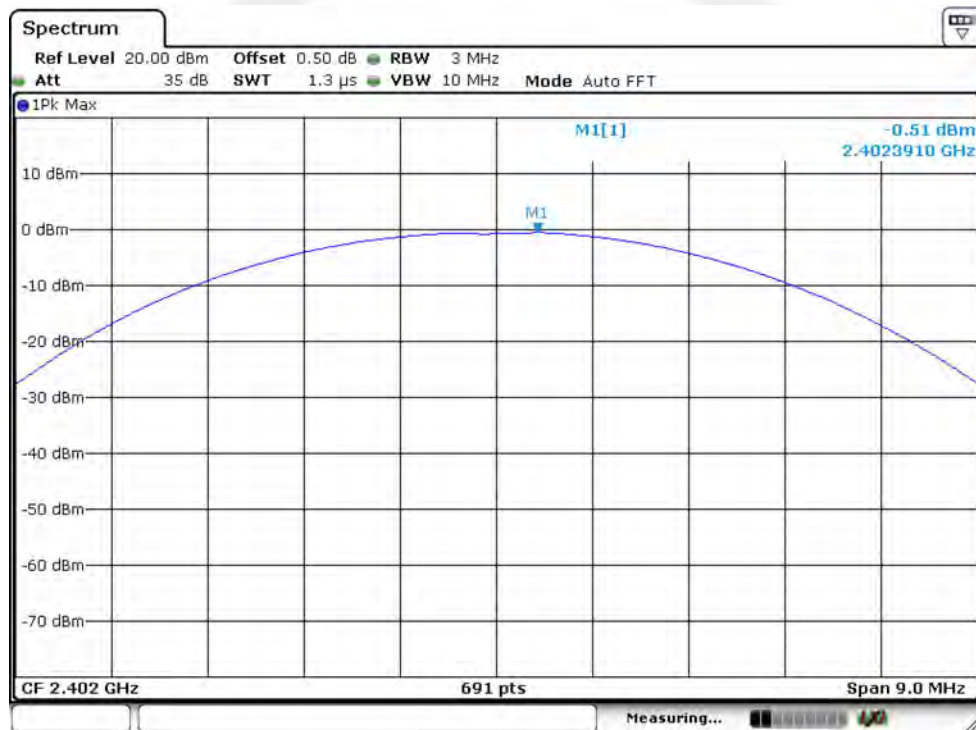

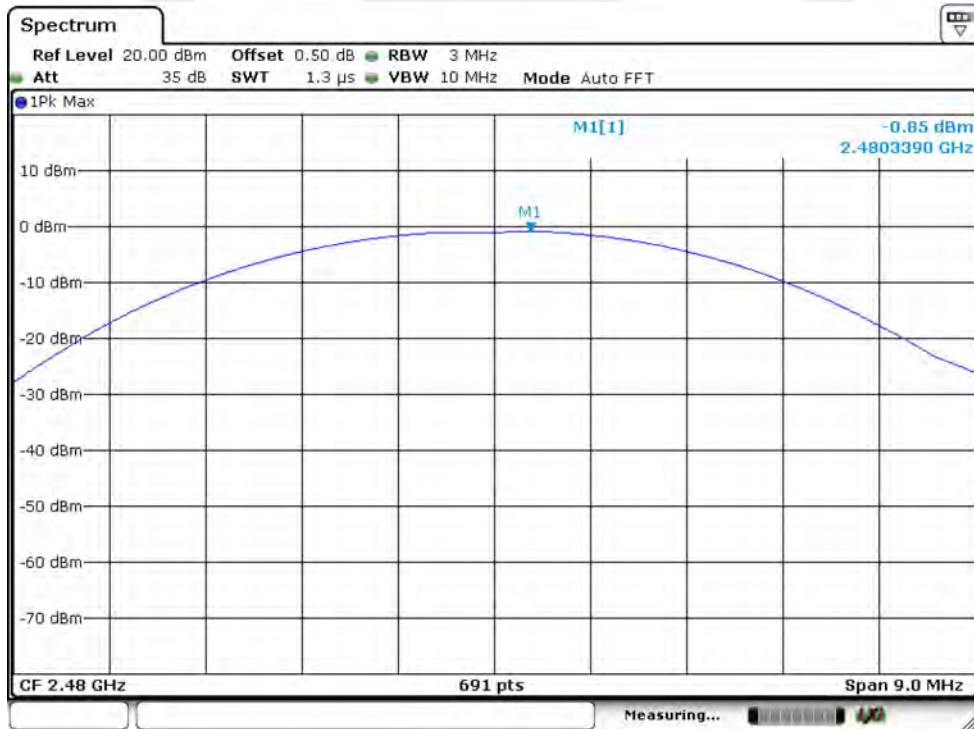

Spectrum Detector:	PK	Test Date :	July 21, 2020
Test By:	Loren	Temperature :	25 °C
Test Result:	PASS	Humidity :	50 %
Modulation:	8DPSK		

Channel number	Channel Frequency (MHz)	Peak Power output(dBm)	Peak Power output(mW)	Peak Power Limit(mW)	Pass/Fail
01	2402	0.07	1.016	125	PASS
40	2441	-0.61	0.869	125	PASS
79	2480	-0.24	0.946	125	PASS

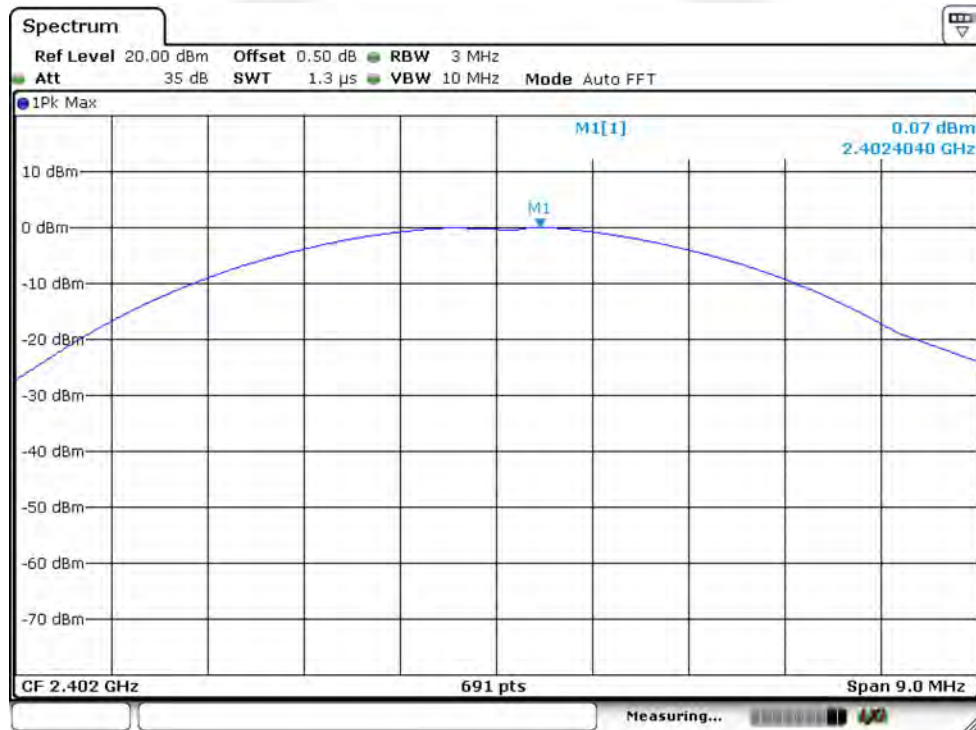

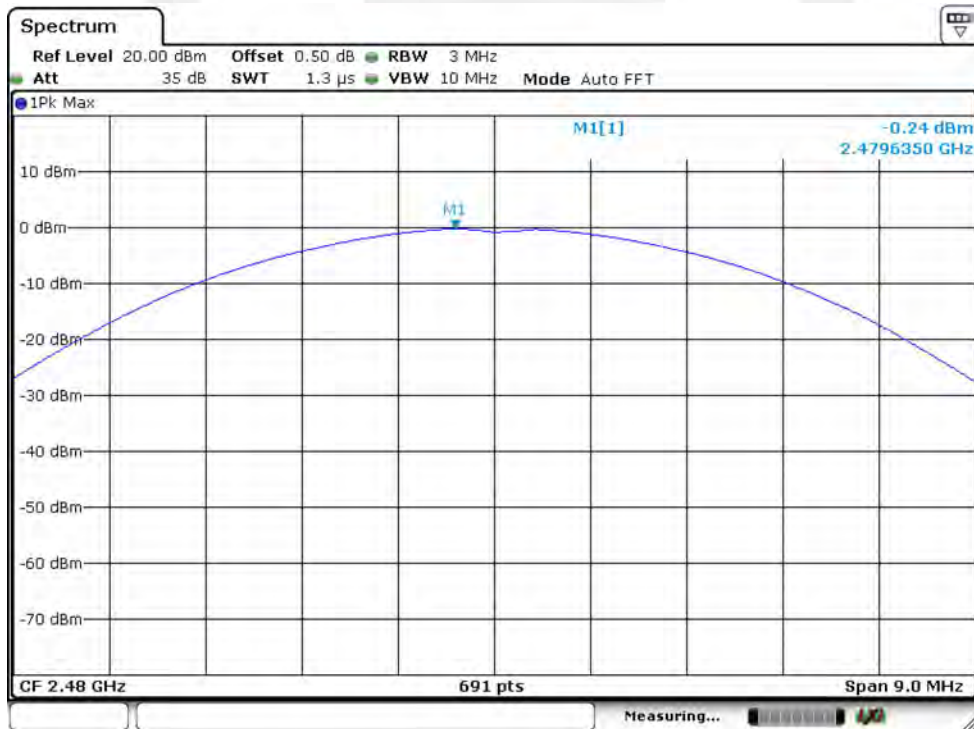
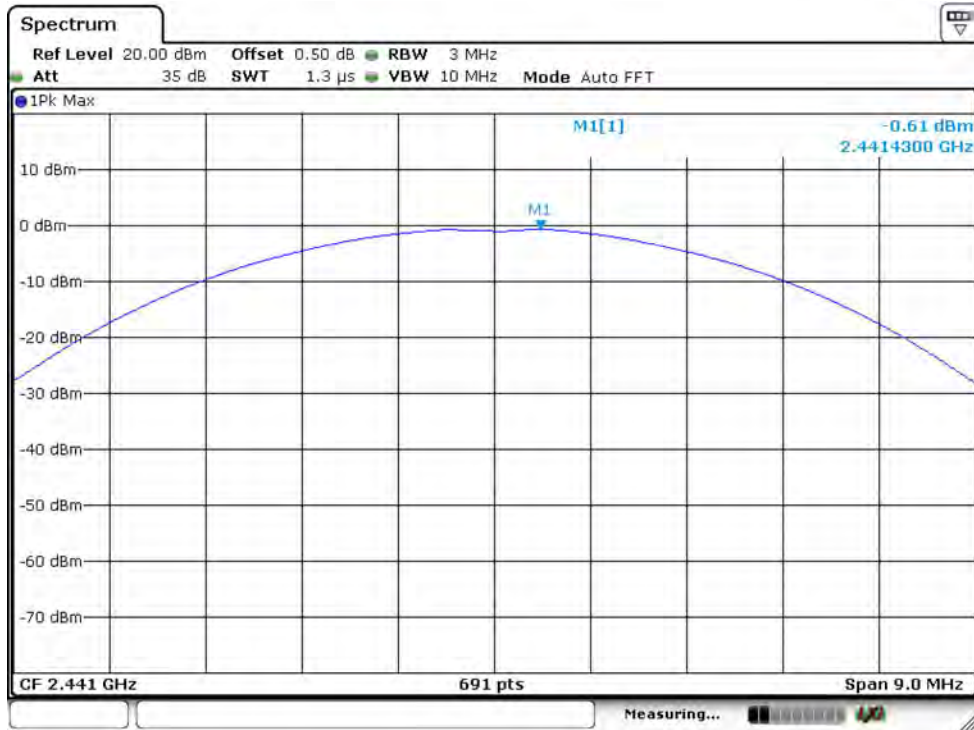

13. Band EDGE test

13.1 Measurement Procedure

For Conducted Test

1. The transmitter output is connected to a spectrum analyzer. The resolution bandwidth is set to 100KHz. The video bandwidth is set to 300KHz.
2. The spectrum from 30MHz to 26 GHz is investigated with the transmitter set to the lowest, middle, and highest channels.

EMI Test Receiver	Setting
Attenuation	Auto
RBW	100KHz
VBW	300KHz
Detector	Peak
Trace	Max hold

For Radiated emission Test

The EUT was placed on a styrofoam table which is 1.5m above ground plane.

The measurement procedure at the ban edges was simplified by performing the measurement in just one plot. Both, the in-band-emission and the unwanted emission were be encompassed by the span. After trace stabilization, the maximum peak was be determined by a peak detector and the value was marked by an appropriate limit line. The second limit line, which is 20dB below the first, marks the limit for the emissions in the unrestricted band. A maximum-peak-detector marks the highest emission in the unrestricted band next to the band edge.

The measurements were performed at the lower end of the 2.4GHz band.

Use the following spectrum analyzer settings:

For Restricted Band, When spectrum scanned above 1GHz setting resolution bandwidth 1MHz, video bandwidth 3MHz:

EMI Test Receiver	Setting
Attenuation	Auto
RBW	1MHz
VBW	3MHz
Detector	Peak
Trace	Max hold

For Non-Restricted Band, When spectrum scanned above 1GHz setting resolution bandwidth 100KHz, video bandwidth 300KHz:

EMI Test Receiver	Setting
Attenuation	Auto
RBW	100KHz
VBW	300KHz
Detector	Peak
Trace	Max hold

13.2 Test SET-UP (Block Diagram of Configuration)

For Conducted Test

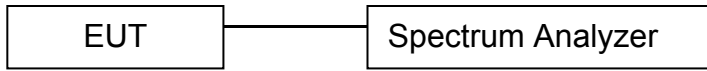

For Radiated emission Test

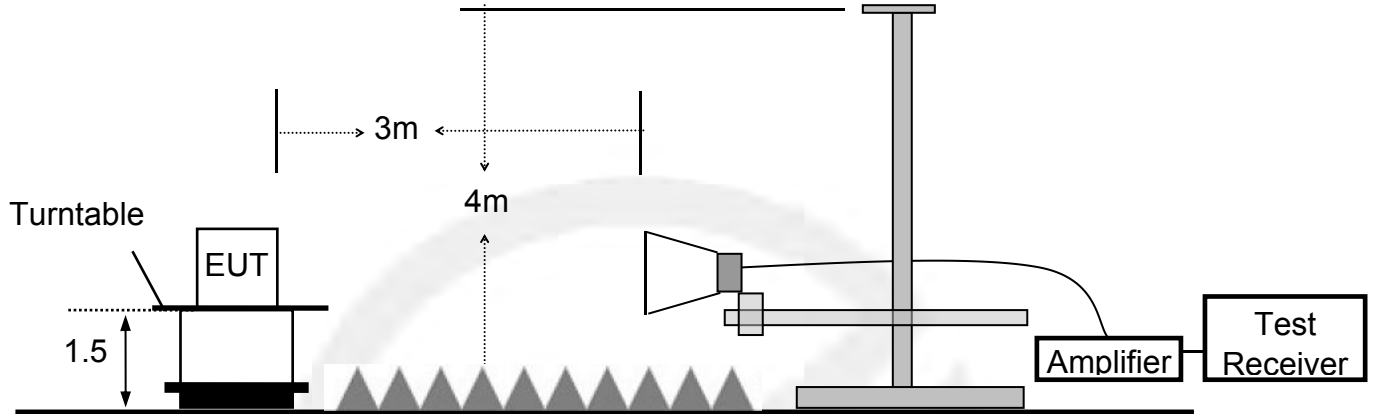

13.3 Measurement Equipment Used:

For Conducted Test

EQUIPMENT TYPE	MFR	MODEL NUMBER	SERIAL NUMBER	Characteristics	LAST CAL.	CAL DUE.
Spectrum Analyzer	Rohde & Schwarz	FSV30	1321.3008K	10Hz-30GHz	05/16/2020	05/15/2021
Coaxial Cable	CDS	79254	46107086	10Hz-30GHz	05/16/2020	05/15/2021
Antenna Connector	ARTHUR-YANG	2244-N1TG1	N/A	10Hz-30GHz	05/16/2020	05/15/2021

Remark: The temporary antenna connector is soldered on the PCB board in order to perform conducted tests and this temporary antenna connector is listed in the equipment list.

For Radiated emission Test

Item	Equipment	Manufacturer	Model No.	Serial No.	Characteristics	Last Cal.	Cal. Interval
1	Signal Analyzer	Rohde & Schwarz	FSV30	103040	9KHz-40GHz	05/16/2020	1 Year
2	Horn Antenna	Schwarzbeck	BBHA9120D	9120D-1272	1GHz-18GHz	05/16/2020	1 Year
3	Power Amplifier	LUNAR EM	LNA1G18-40	J10100000081	1GHz-26.5GHz	05/16/2020	1 Year
4	Cable	H+S	CBL-26	N/A	1GHz-26.5GHz	05/16/2020	1 Year
5	Cable	H+S	CBL-26	N/A	1GHz-26.5GHz	05/16/2020	1 Year
6	Cable	H+S	CBL-26	N/A	1GHz-26.5GHz	05/16/2020	1 Year

13.4 Measurement Results:

Refer to attached data chart.

Spectrum Detector:	PK	Test Date :	July 21, 2020
Test By:	Loren	Temperature :	25 °C
Test Result:	PASS	Humidity :	50 %

1. Conducted Test

For Non-Hopping Mode:

Frequency (MHz)	Modulation	Peak Power Output(dBm)	Result of Band edge(dBc)	Band edge Limit(dBc)
2401.98	GFSK	-3.17	42.38	>20dBc
2402.01	pi/4-DQPSK	-4.17	40.18	>20dBc
2402.07	8DPSK	-4.29	40.74	>20dBc
2479.94	GFSK	-3.67	47.62	>20dBc
2479.94	pi/4-DQPSK	-5.31	45.10	>20dBc
2479.94	8DPSK	-4.61	45.42	>20dBc

Test plots of GFSK

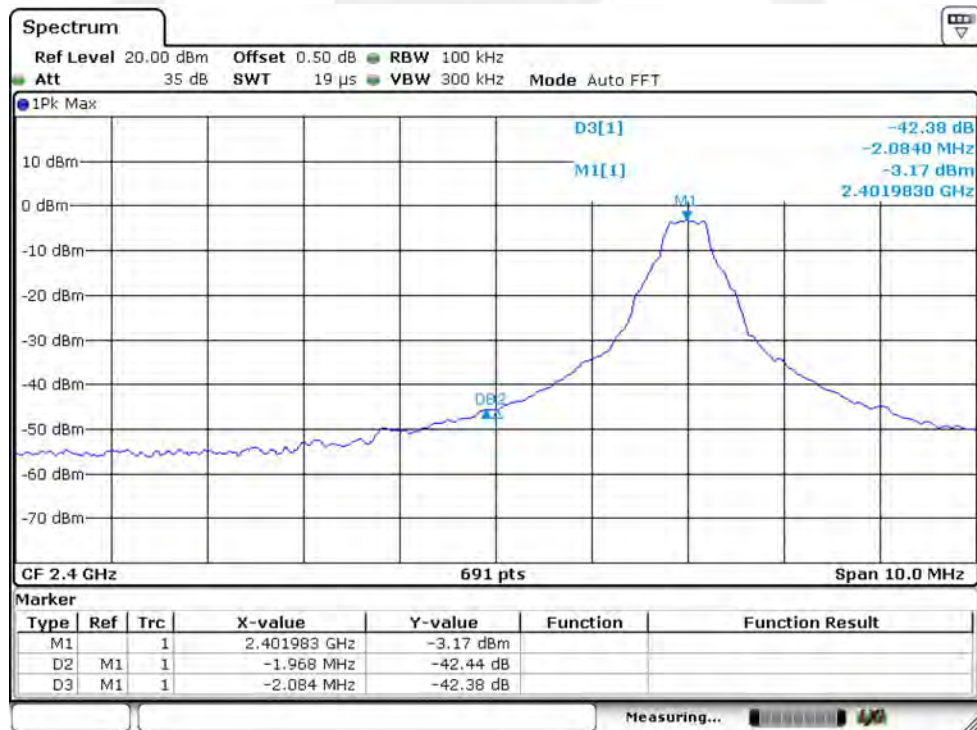

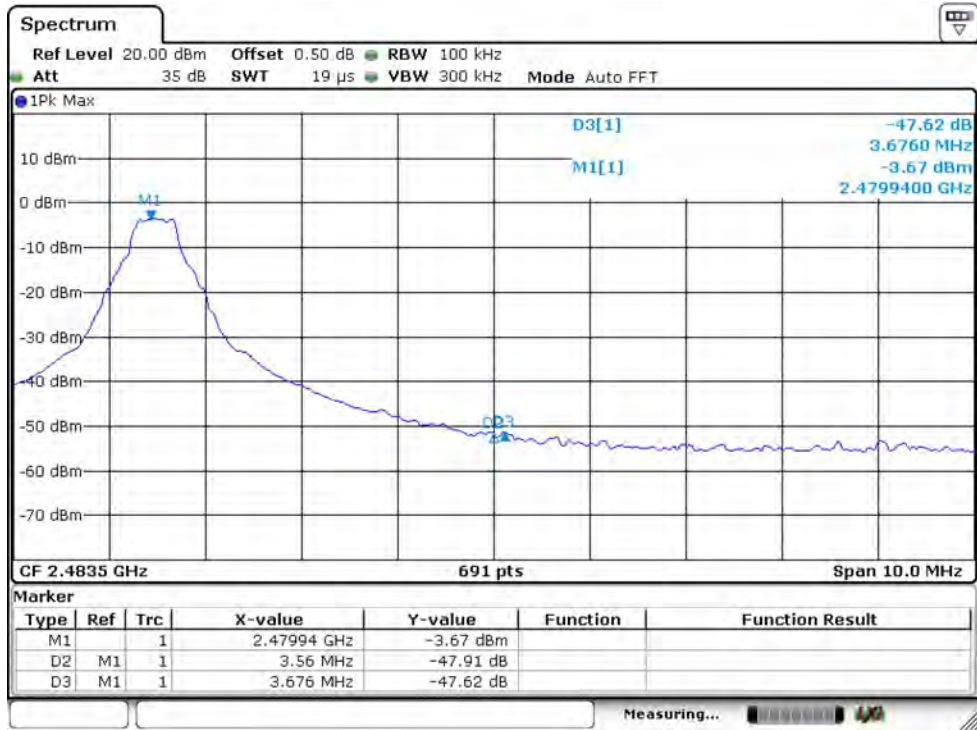

Test plots of pi/4-DQPSK

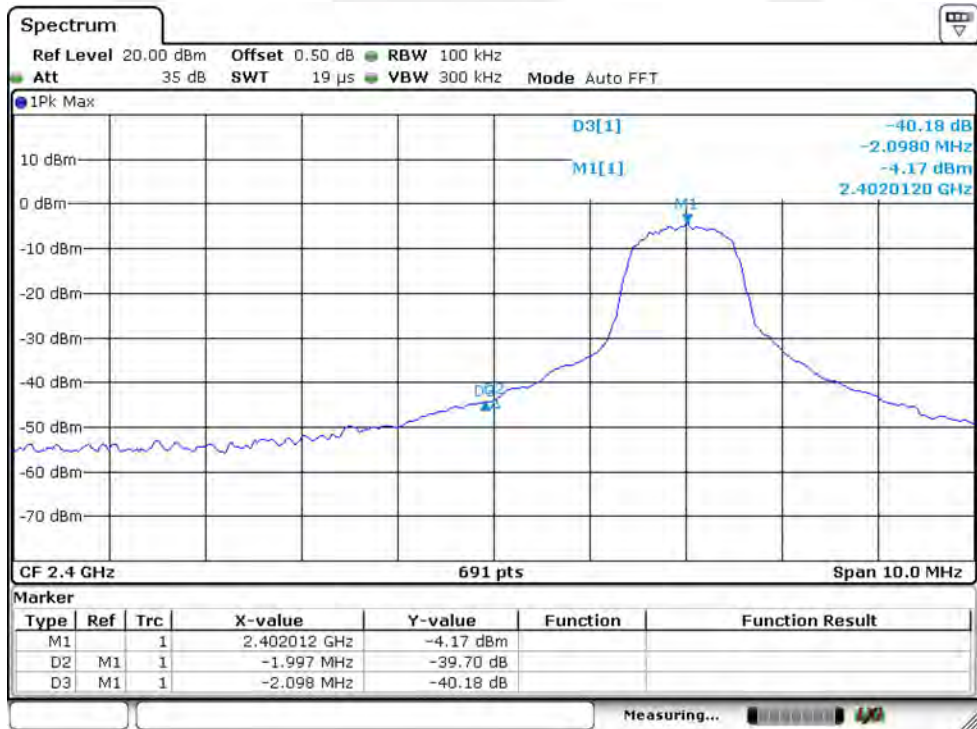

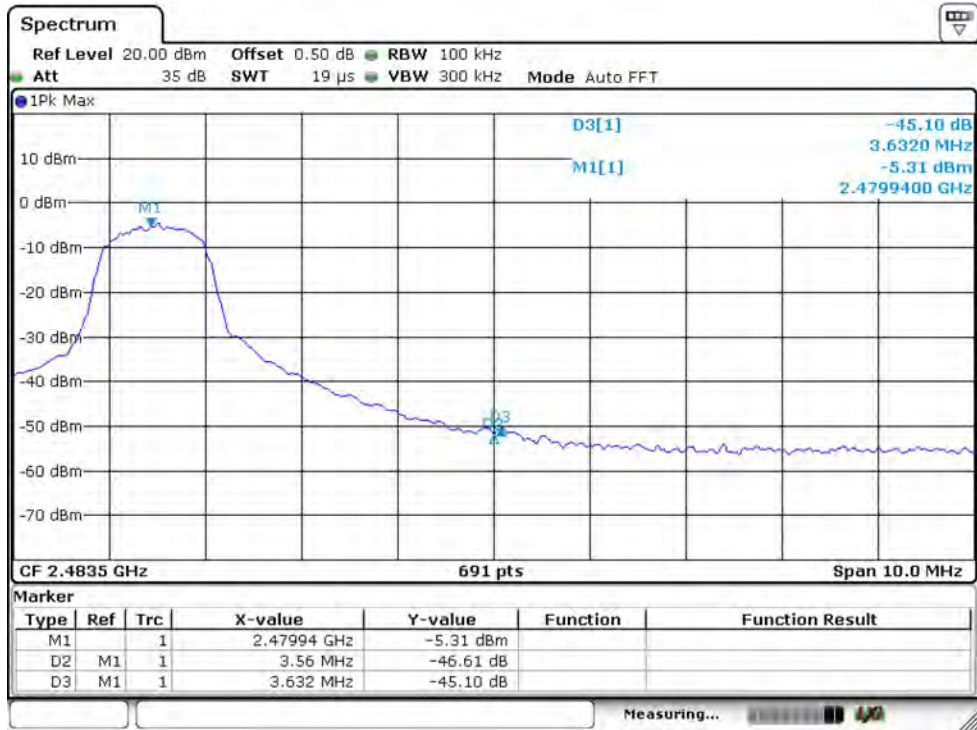

Test plots of 8DPSK

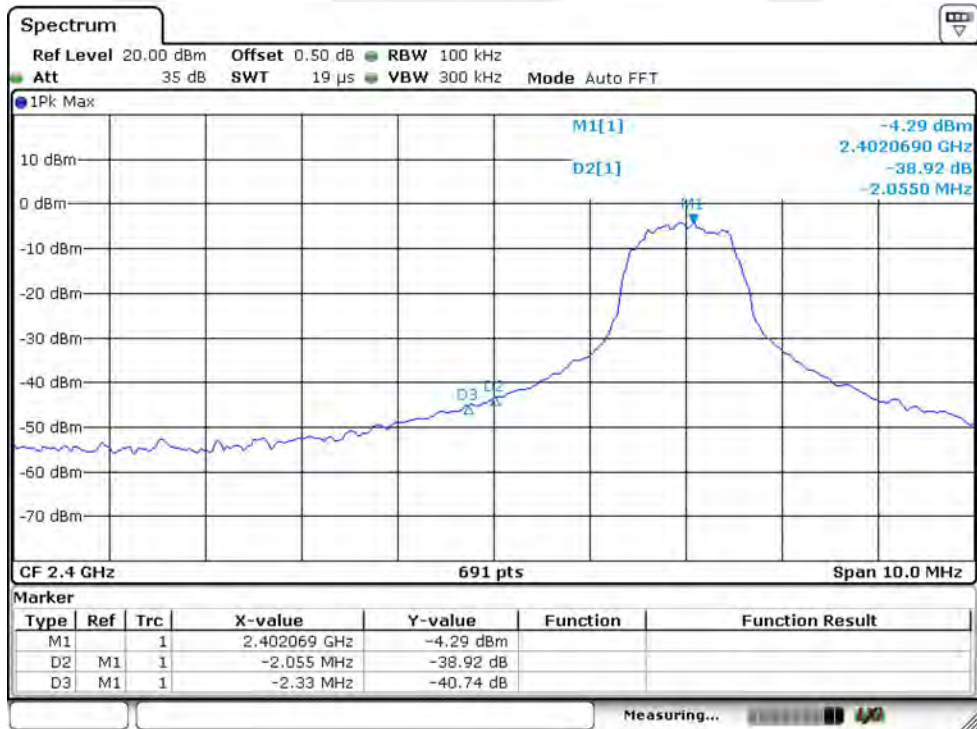

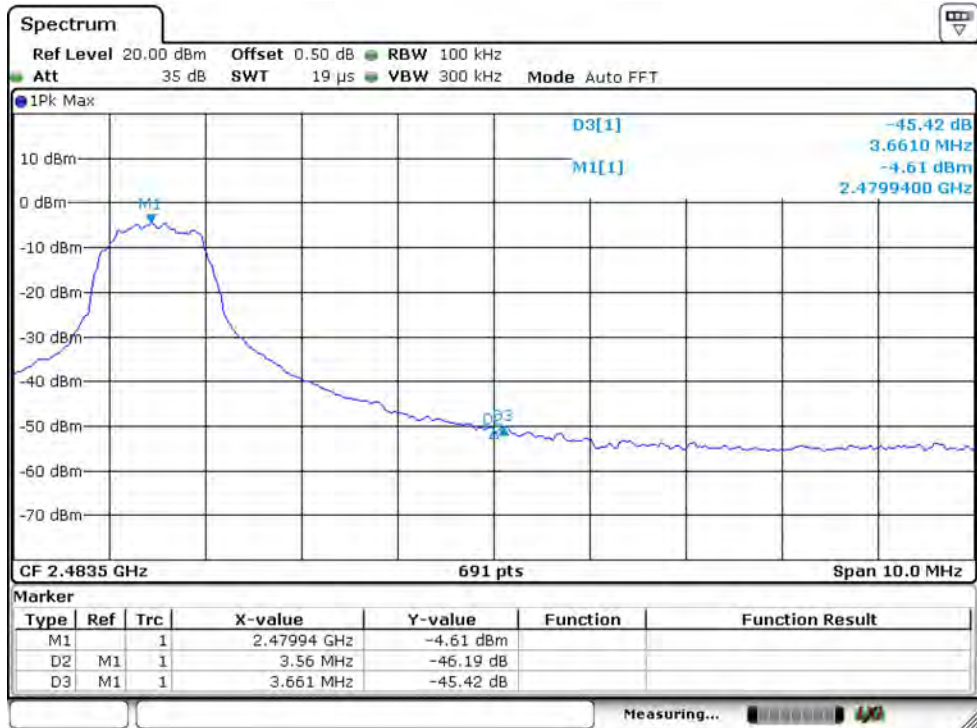

For Hopping Mode:

Frequency (MHz)	Modulation	Peak Power Output(dBm)	Result of Band edge(dBc)	Band edge Limit(dBc)
2402.04	GFSK	-3.42	45.82	>20dBc
2404.83	pi/4-DQPSK	-5.16	44.87	>20dBc
2403.07	8DPSK	-4.41	41.08	>20dBc
2479.97	GFSK	-3.48	48.91	>20dBc
2479.97	pi/4-DQPSK	-5.60	48.27	>20dBc
2479.07	8DPSK	-4.50	50.39	>20dBc

Test plots of GFSK



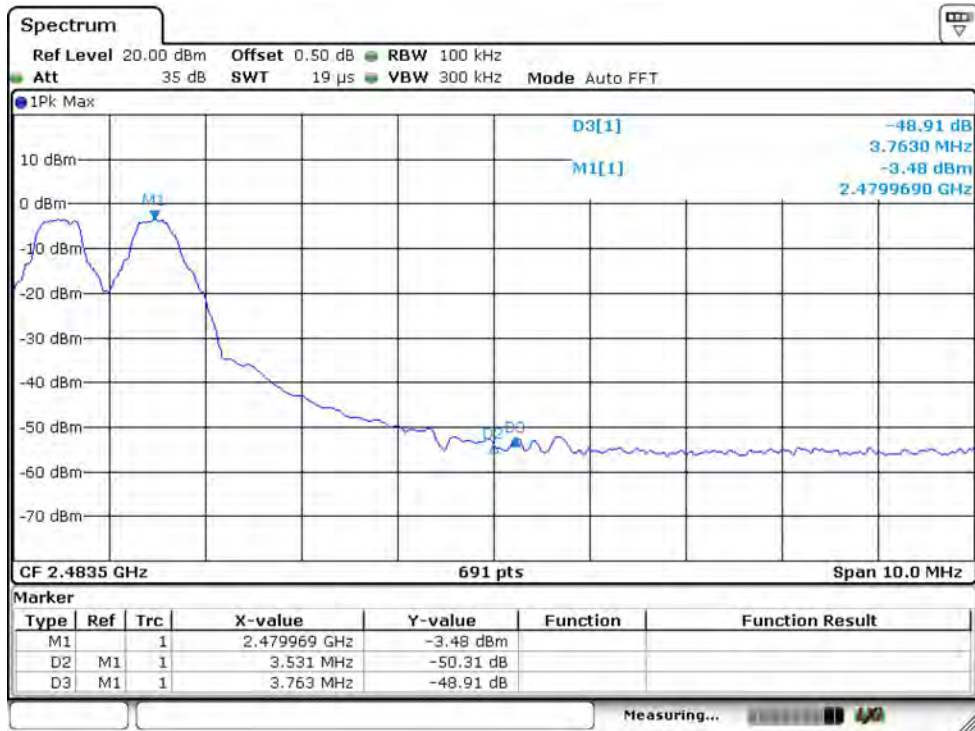

Test plots of pi/4-DQPSK

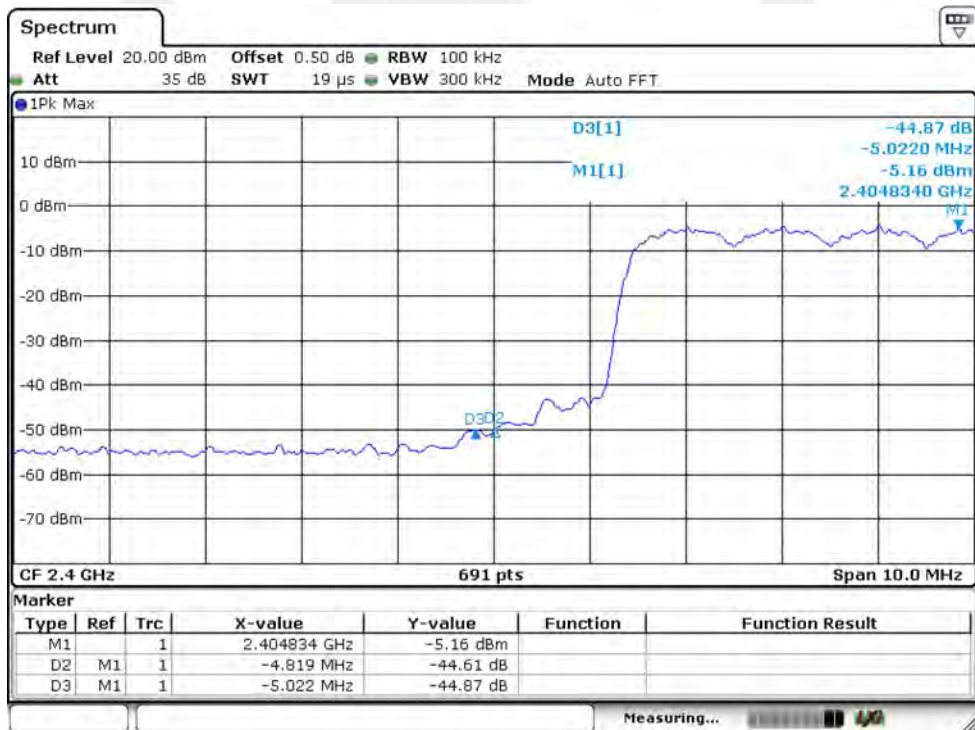

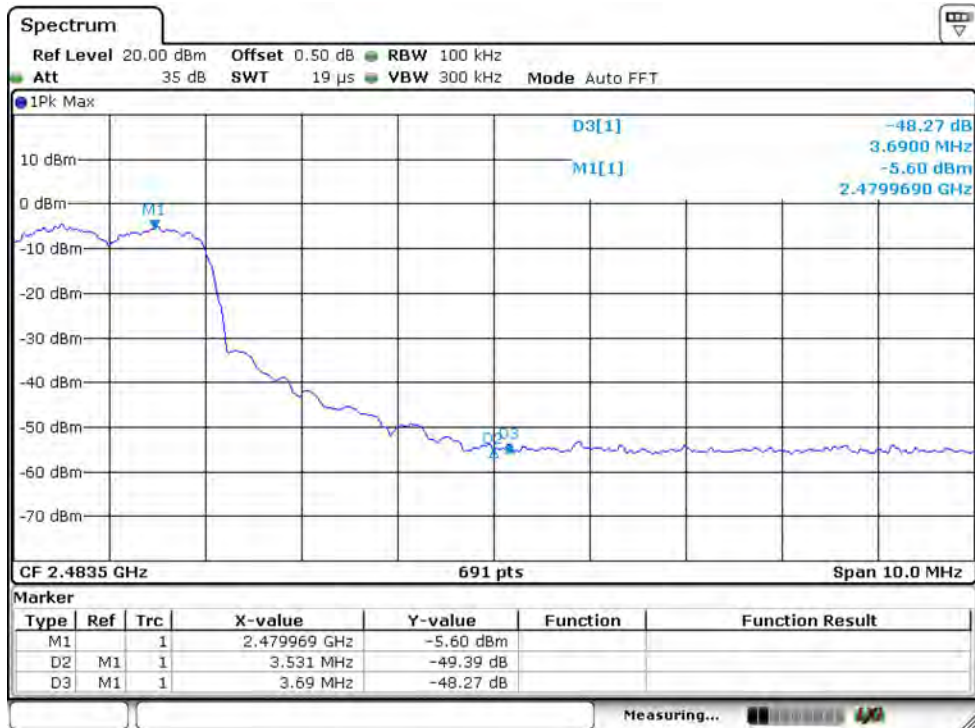

Test plots of 8DPSK

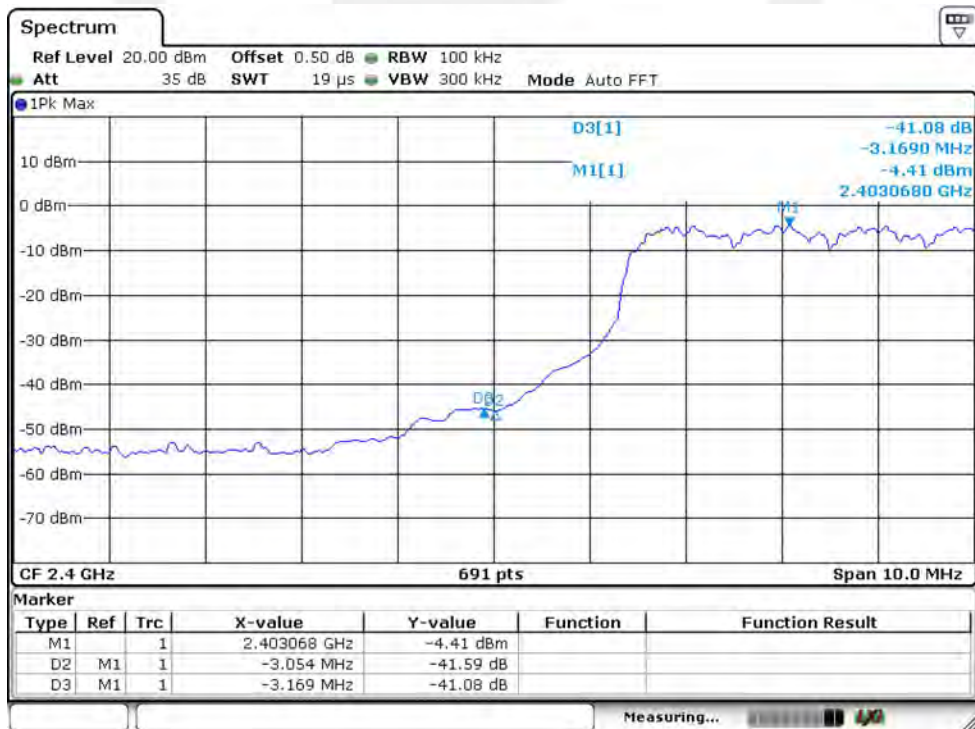

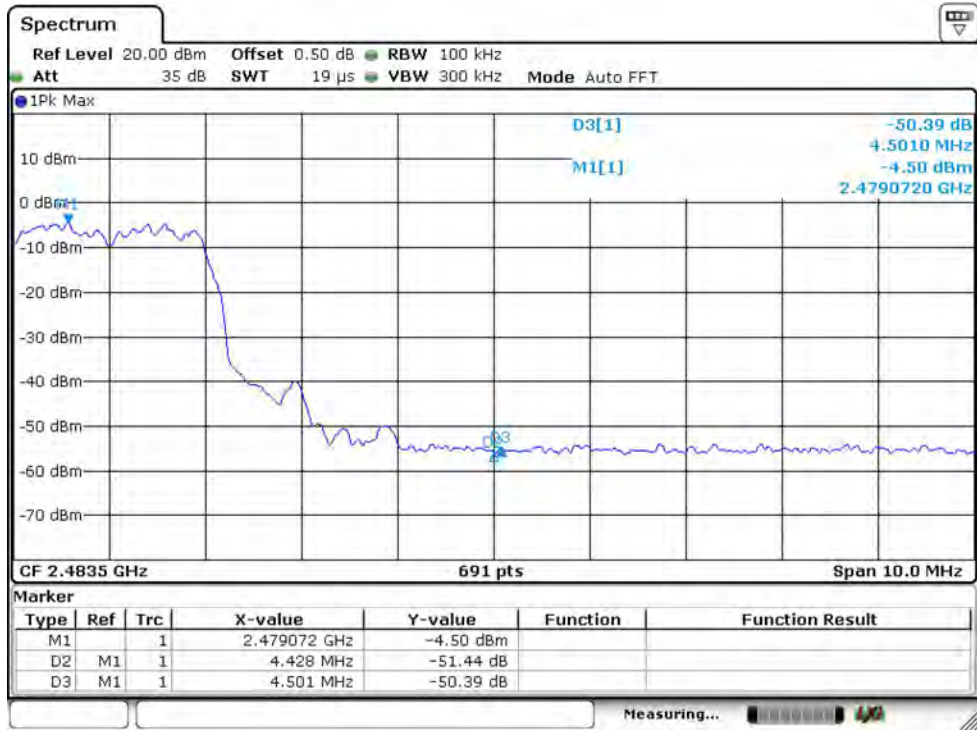

2. Radiated emission Test
Worst test modulation 8DPSK
 For Non-Hopping Mode:

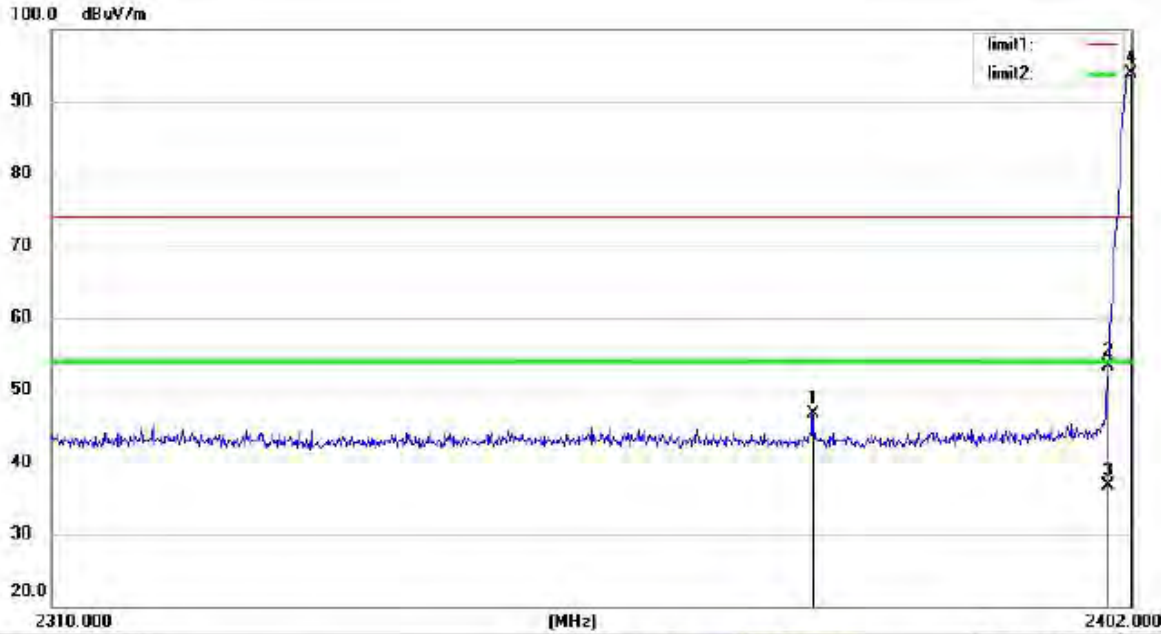

Site Chamber #1 Polarization: *Horizontal* Temperature: 25
 Limit: (RE)FCC PART 15.247 PK Power: DC 9V form adapter Humidity: 55 %
 Mode: TX2402
 Note:

No.	Mk.	Freq. MHz	Reading Level dBuV	Correct Factor dB	Measure- ment dBuV/m	Limit dBuV/m	Over dB	Antenna Height cm	Table Degree	Comment
1		2374.492	58.41	-11.69	46.72	74.00	-27.28	peak		
2		2400.000	64.89	-11.63	53.26	74.00	-20.74	peak		
3		2400.000	48.25	-11.63	36.62	54.00	-17.38	AVG		
4	*	2402.000	105.49	-11.63	93.86	74.00	19.86	peak		

*:Maximum data x:Over limit !:over margin

Operator: Lian

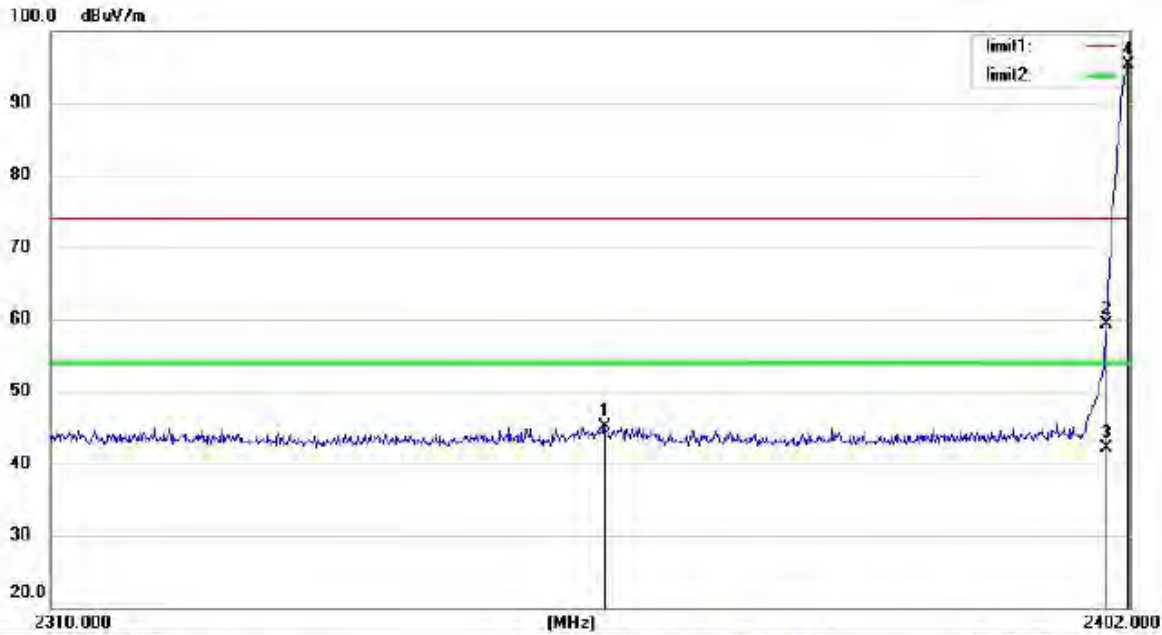

Site Chamber #1 Polarization: *Vertical* Temperature: 25
 Limit: (RE)FCC PART 15.247 PK Power: DC 9V form adapter Humidity: 55 %
 Mode: TX2402
 Note:

No.	Mk.	Freq.	Reading Level	Correct Factor	Measurement	Limit	Over	Antenna Height	Table Degree	Comment
		MHz	dBuV	dB	dBuV/m	dBuV/m	dB	cm	degree	
1		2356.828	56.83	-11.72	45.11	74.00	-28.89			peak
2		2400.000	70.98	-11.63	59.35	74.00	-14.65			peak
3		2400.000	53.65	-11.63	42.02	54.00	-11.98			AVG
4	*	2401.816	107.02	-11.63	95.39	74.00	21.39			peak

*:Maximum data x:Over limit !:over margin

Operator: Lian

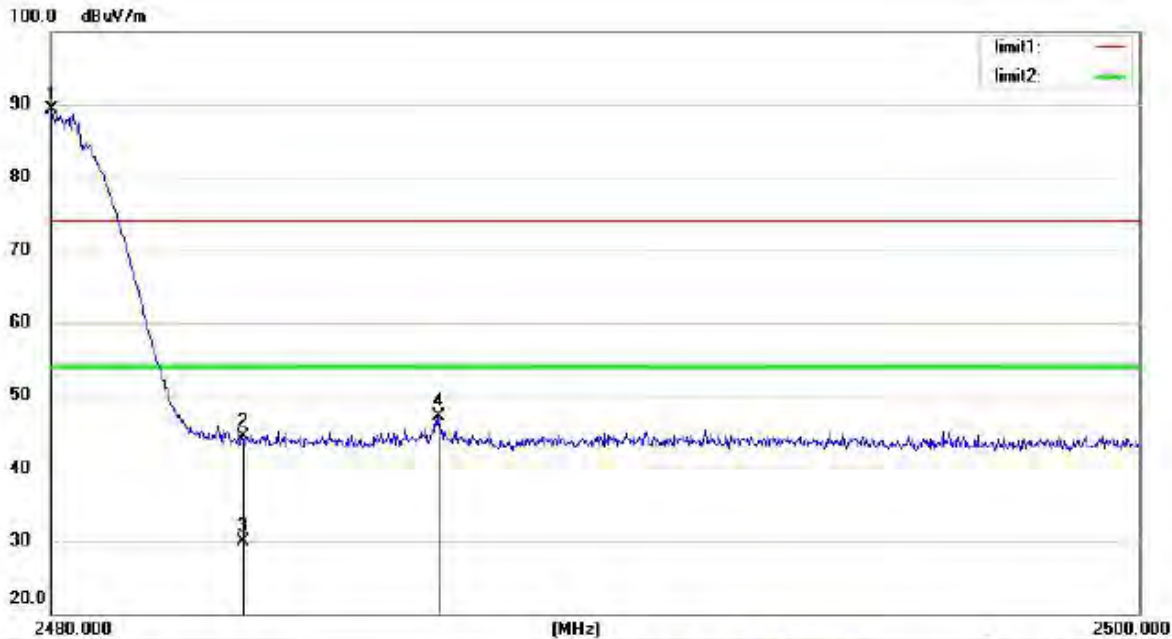

Site Chamber #1

Polarization: *Horizontal*

Temperature: 25

Limit: (RE)FCC PART 15.247 PK

Power: DC 9V form adapter

Humidity: 55 %

Mode: TX2480

Note:

No.	Mk.	Freq. MHz	Reading Level dBuV	Correct Factor dB	Measure- ment dBuV/m	Limit dBuV/m	Over dB	Detector	Antenna Height cm	Table Degree	Comment
1	*	2480.000	100.82	-11.45	89.37	74.00	15.37	peak			
2		2483.500	55.84	-11.46	44.38	74.00	-29.62	peak			
3		2483.500	41.30	-11.46	29.84	54.00	-24.16	AVG			
4		2487.100	58.58	-11.44	47.14	74.00	-26.86	peak			

*:Maximum data x:Over limit !:over margin

Operator: Lian

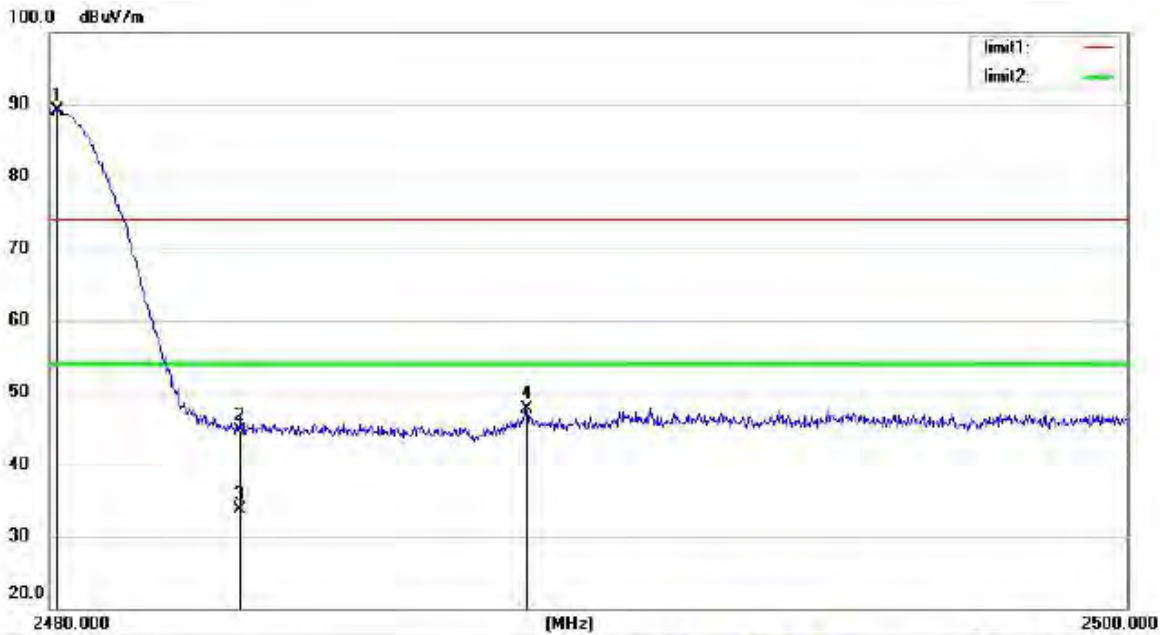

Site Chamber #1 Polarization: **Vertical** Temperature: 25
 Limit: (RE)FCC PART 15.247 PK Power: DC 9V form adapter Humidity: 55 %
 Mode: TX2480
 Note:

No.	Mk.	Freq.	Reading Level	Correct Factor	Measurement	Limit	Over	Antenna Height	Table Degree	
		MHz	dBuV	dB	dBuV/m	dBuV/m	dB	cm	degree	Comment
1	*	2480.120	99.13	-10.02	89.11	74.00	15.11			peak
2		2483.500	54.74	-10.01	44.73	74.00	-29.27			peak
3		2483.500	43.72	-10.01	33.71	54.00	-20.29			AVG
4		2488.840	57.75	-9.98	47.77	74.00	-26.23			peak

*:Maximum data x:Over limit !:over margin

Operator: Lian

For Hopping Mode:

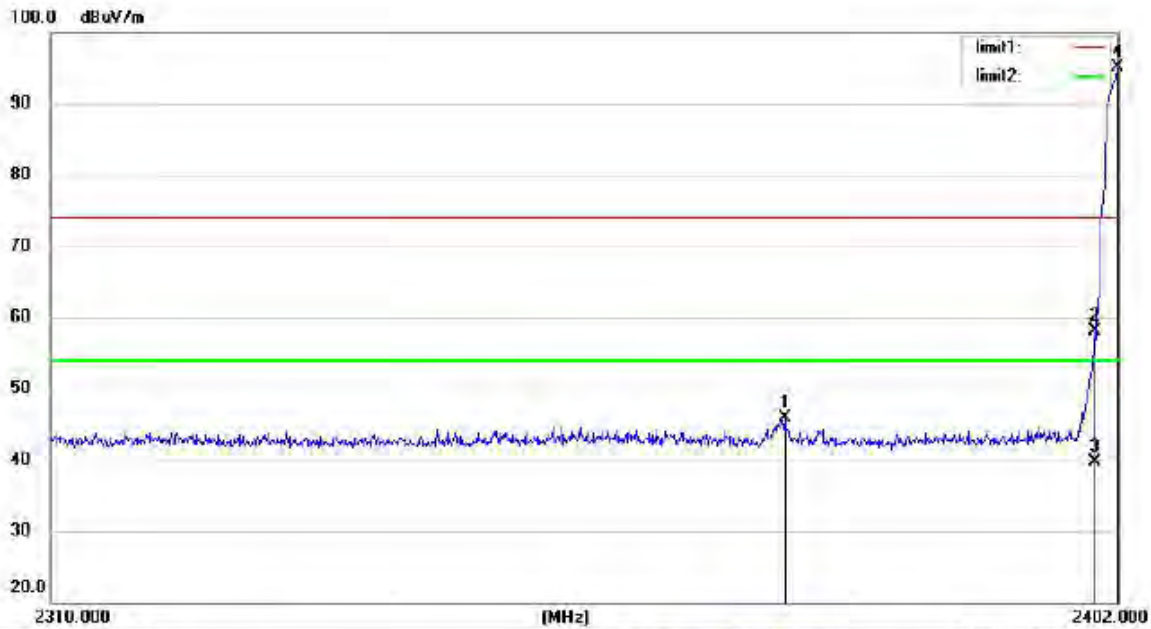

Site: Chamber #1 Polarization: *Horizontal* Temperature: 25
 Limit: (RE)FCC PART 15.247 PK Power: DC 9V form adapter Humidity: 55 %
 Mode: Hopping
 Note:

No.	Mk.	Freq. MHz	Reading Level dBuV	Correct Factor dB	Measure- ment dBuV/m	Limit dBuV/m	Over dB	Antenna Height cm	Table Degree	Comment
1		2372.928	57.61	-11.69	45.92	74.00	-28.08			peak
2		2400.000	69.69	-11.63	58.06	74.00	-15.94			peak
3		2400.000	51.36	-11.63	39.73	54.00	-14.27			AVG
4	*	2402.000	106.73	-11.63	95.10	74.00	21.10			peak

*:Maximum data x:Over limit !:over margin

Operator: Lian

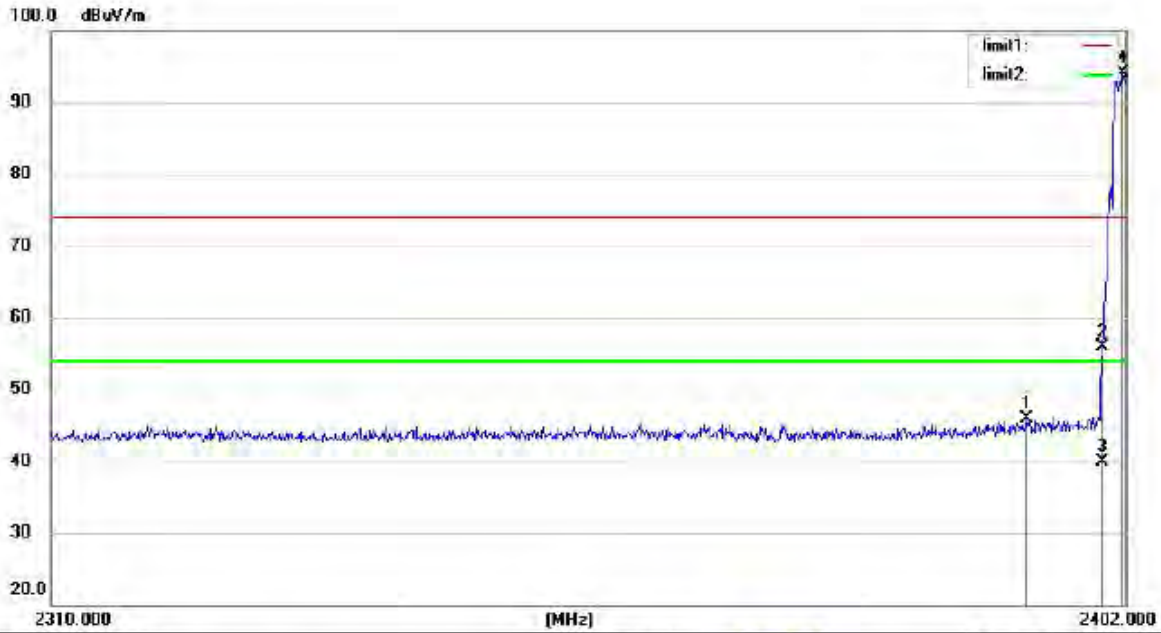

Site: Chamber #1 Polarization: *Vertical* Temperature: 25
 Limit: (RE)FCC PART 15.247 PK Power: DC 9V form adapter Humidity: 55 %
 Mode: Hopping
 Note:

No.	Mk.	Freq.	Reading Level	Correct Factor	Measurement	Limit	Over	Antenna Height	Table Degree	Comment
		MHz	dBuV	dB	dBuV/m	dBuV/m	dB	cm	degree	
1		2393.444	56.41	-10.51	45.90	74.00	-28.10			peak
2		2400.000	66.45	-10.47	55.98	74.00	-18.02			peak
3		2400.000	50.36	-10.47	39.89	54.00	-14.11			AVG
4	*	2401.724	104.54	-10.46	94.08	74.00	20.08			peak

*:Maximum data x:Over limit !:over margin

Operator: Lian

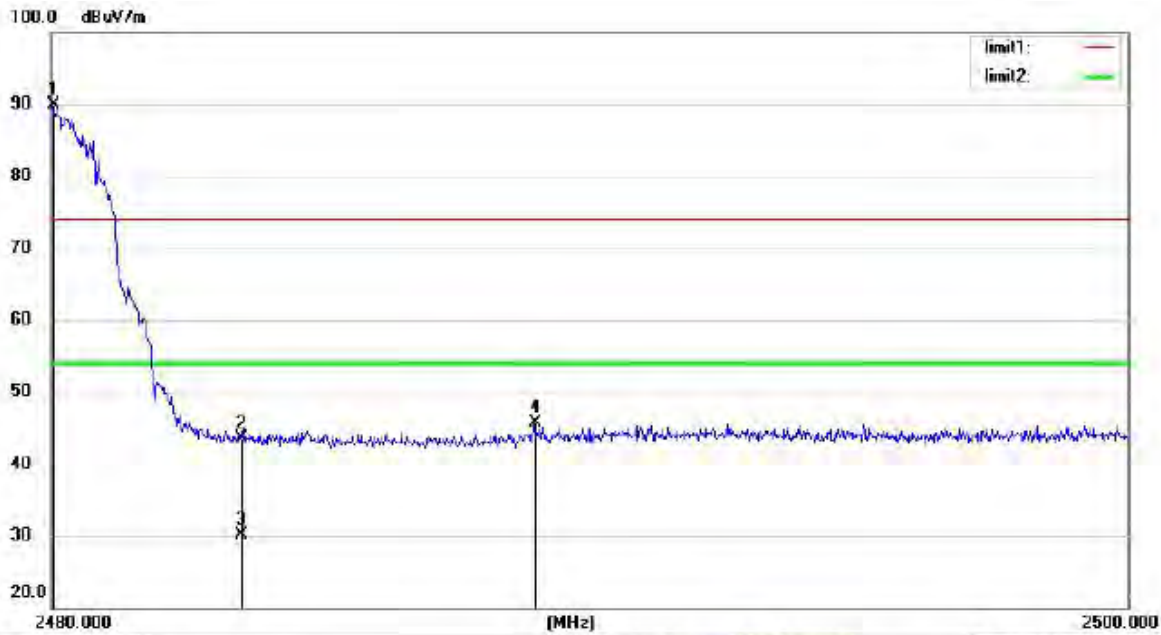

Site Chamber #1 Polarization: *Horizontal* Temperature: 25
 Limit: (RE)FCC PART 15.247 PK Power: DC 9V form adapter Humidity: 55 %
 Mode: Hopping
 Note:

No.	Mk.	Freq. MHz	Reading Level dBuV	Correct Factor dB	Measure- ment dBuV/m	Limit dBuV/m	Over dB	Detector	Antenna Height cm	Table Degree	Comment
1	*	2480.020	101.36	-11.45	89.91	74.00	15.91	peak			
2		2483.500	54.89	-11.46	43.43	74.00	-30.57	peak			
3		2483.500	41.57	-11.46	30.11	54.00	-23.89	AVG			
4		2488.980	57.11	-11.44	45.67	74.00	-28.33	peak			

*:Maximum data x:Over limit !:over margin

Operator: Lian

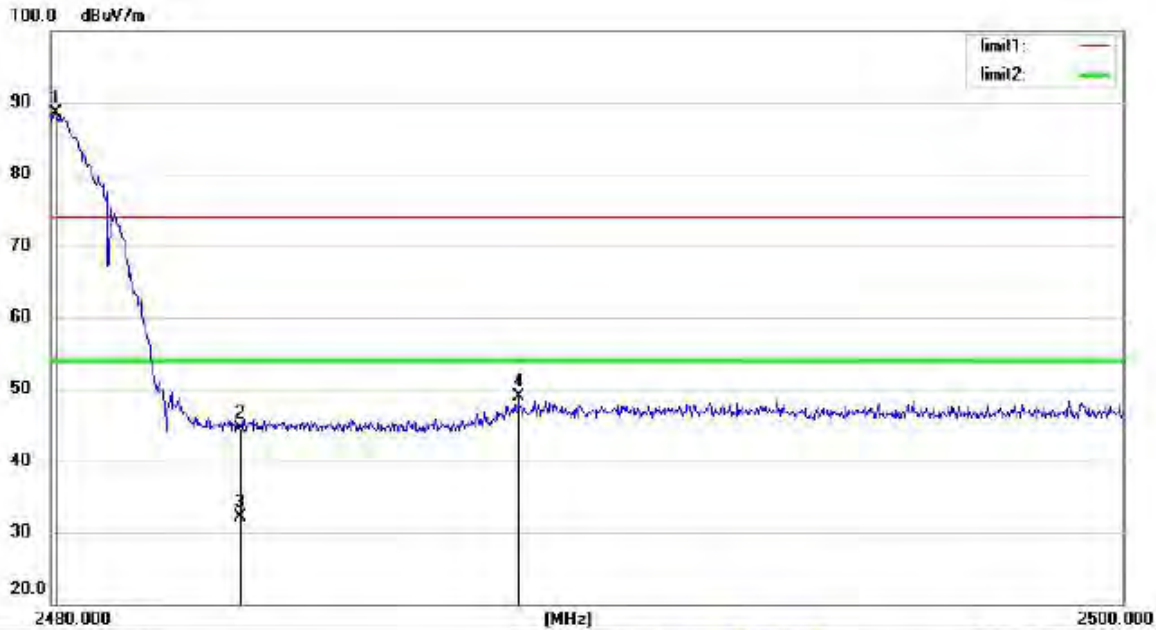

Site: Chamber #1
 Limit: (RE)FCC PART 15.247 PK
 Mode: Hopping
 Note:

Polarization: *Vertical*
 Power: DC 9V form adapter
 Temperature: 25
 Humidity: 55 %

No.	Mk.	Freq. MHz	Reading Level dBuV	Correct Factor dB	Measure- ment dBuV/m	Limit dBuV/m	Over dB	Detector	Antenna Height cm	Table Degree	Comment
1	*	2480.080	98.49	-10.02	88.47	74.00	14.47	peak			
2		2483.500	54.49	-10.01	44.48	74.00	-29.52	peak			
3		2483.500	42.17	-10.01	32.16	54.00	-21.84	AVG			
4		2488.720	58.83	-9.98	48.85	74.00	-25.15	peak			

*:Maximum data x:Over limit !:over margin

Operator: Lian

14. Antenna Application

14.1 Antenna requirement

The EUT'S antenna is met the requirement of FCC part 15C section 15.203 and 15.247.

FCC part 15C section 15.247 requirements:

Systems operating in the 2400-2500MHz band that are used exclusively for fixed, point-to-point operations may employ transmitting antennas with directional gain greater than 6dBi provided the maximum peak output power of the intentional radiator is reduced by 1dB for every 3dB that the directional gain of the antenna exceeds 6dBi.

14.2 Result

The EUT's antenna, permanent attached antenna, used a PCB antenna and integrated on PCB, The antenna's gain is 0.5dBi and meets the requirement.

15. Photos of EUT

Please refer to external photos and internal photos.

*** End of Report ***

声明

Statement

1. 本报告无授权批准人签字及“检验报告专用章”无效；

This report will be void without authorized signature or special seal for testing report.

2. 未经许可本报告不得部分复制；

This report shall not be copied partly without authorization.

3. 本报告的检测结果仅对送测样品有效，委托方对样品的代表性和资料的真实性负责；

The test results or observations are applicable only to tested sample. Client shall be responsible for representativeness of the sample and authenticity of the material.

4. 本检测报告中检测项目标注有特殊符号则该项目不在资质认定范围内，仅作为客户委托、科研、教学或内部质量控制等目的使用；

The observations or tests with special mark fall outside the scope of accreditation, and are only used for purpose of commission, research, training, internal quality control etc.

5. 本检测报告以实测值进行符合性判定，未考虑不确定度所带来的风险，本实验室不承担相关责任，特别约定、标准或规范中有明确规定的除外；

The test results or observations are provided in accordance with measured value, without taking risks caused by uncertainty into account. Without explicit stipulation in special agreements, standards or regulations, EMTEK shall not assume any responsibility.

6. 对本检测报告若有异议，请于收到报告之日起 20 日内提出；

Objections shall be raised within 20 days from the date receiving the report.