



FCC PART 15.247

RSS-GEN ISSUE 5, FEBRUARY 2021 AMENDMENT 2 RSS-247, ISSUE 2, FEBRUARY 2017

TEST REPORT

For

FCC: SDI Technologies Inc.

FCC: 1299 Main St. Rahway, NJ 07065, United States

ISED: SDI TECHNOLOGIES INC.

ISED: 1299 Main Street Rahway NJ 07065 United States of America (Excluding the States of Alaska)

FCC ID: EMOICVBT500A
IC: 986B-ICVBT500A

Report Type: Original Report	Product Type: Large Vanity Mirror with True Three Color Lighting and Bluetooth Speaker
Report Number: SZKA210706-27483E	
Report Date: 2021-08-02	
Reviewed By: RF Engineer	Jacob Kong
Prepared By: Bay Area Compliance Laboratories Corp. (Shenzhen) 5F(B-West), 6F, 7F, the 3rd Phase of Wan Li Industrial Building D, Shihua Rd, FuTian Free Trade Zone, Shenzhen, China Tel: +86-755-33320018 Fax: +86-755-33320008 www.baclcorp.com.cn	

Note: This report may contain data that are not covered by the A2LA accreditation and are marked with an asterisk "★".

BACL is not responsible for the authenticity of any test data provided by the applicant. Data included from the applicant that may affect test results are marked with an asterisk '*'. Customer model name, addresses, names, trademarks etc. are not considered data.

This report cannot be reproduced except in full, without prior written approval of the Company. Unless otherwise stated the results shown in this test report refer only to the sample(s) tested. This report is valid only with a valid digital signature. The digital signature may be available only under the Adobe software above version 7.0.

TABLE OF CONTENTS

GENERAL INFORMATION.....	4
PRODUCT DESCRIPTION FOR EQUIPMENT UNDER TEST (EUT).....	4
OBJECTIVE	4
TEST METHODOLOGY	4
MEASUREMENT UNCERTAINTY.....	5
TEST FACILITY	5
SYSTEM TEST CONFIGURATION.....	6
DESCRIPTION OF TEST CONFIGURATION	6
EUT EXERCISE SOFTWARE	6
SPECIAL ACCESSORIES.....	6
EQUIPMENT MODIFICATIONS	6
SUPPORT EQUIPMENT LIST AND DETAILS	6
EXTERNAL I/O CABLE.....	6
BLOCK DIAGRAM OF TEST SETUP	7
SUMMARY OF TEST RESULTS	8
TEST EQUIPMENT LIST	9
FCC §15.247 (i) & §2.1091- MAXIMUM PERMISSIBLE EXPOSURE (MPE).....	10
APPLICABLE STANDARD	10
RESULT	10
RSS-102 § 2.5.2 –EXEMPTION LIMITS FOR ROUTINE EVALUATION-RF EXPOSURE EVALUATION	11
APPLICABLE STANDARD	11
FCC §15.203 & RSS-GEN §6.8– ANTENNA REQUIREMENT	12
APPLICABLE STANDARD	12
ANTENNA CONNECTOR CONSTRUCTION	12
FCC §15.207 (a) & RSS-GEN §8.8– AC LINE CONDUCTED EMISSIONS.....	13
APPLICABLE STANDARD	13
EUT SETUP.....	14
EMI TEST RECEIVER SETUP.....	14
TEST PROCEDURE	14
CORRECTED FACTOR & MARGIN CALCULATION	15
TEST DATA	15
FCC §15.205, §15.209 & §15.247(d) & RSS-247§ 5.5 – RADIATED EMISSIONS.....	18
APPLICABLE STANDARD	18
EUT SETUP	18
EMI TEST RECEIVER & SPECTRUM ANALYZER SETUP	19
TEST PROCEDURE	19
CORRECTED AMPLITUDE & MARGIN CALCULATION	20
TEST DATA	20
FCC §15.247(a) (1) & RSS-247 § 5.1 (b)-CHANNEL SEPARATION TEST.....	27
APPLICABLE STANDARD	27
TEST PROCEDURE	27
TEST DATA	27

FCC §15.247(a) (1) & RSS-GEN § 6.7 & RSS-247 § 5.1 (a)–99% OCCUPIED BANDWIDTH & 20 dB EMISSION BANDWIDTH.....28

 APPLICABLE STANDARD28

 TEST PROCEDURE28

 TEST DATA29

FCC §15.247(a) (1) (iii) & RSS-247 § 5.1 (d)-QUANTITY OF HOPPING CHANNEL TEST30

 APPLICABLE STANDARD30

 TEST PROCEDURE30

 TEST DATA30

FCC §15.247(a) (1) (iii) & RSS-247 § 5.1 (d) - TIME OF OCCUPANCY (DWELL TIME)31

 APPLICABLE STANDARD31

 TEST PROCEDURE31

 TEST DATA31

FCC §15.247(b) (1) & RSS-247§ 5.1(b) &§ 5.4(b) - PEAK OUTPUT POWER MEASUREMENT32

 APPLICABLE STANDARD32

 TEST PROCEDURE32

 TEST DATA32

FCC §15.247(d) & RSS-247 § 5.5 - BAND EDGES TESTING.....33

 APPLICABLE STANDARD33

 TEST PROCEDURE33

 TEST DATA33

APPENDIX34

 APPENDIX A: 20DB EMISSION BANDWIDTH.....34

 APPENDIX B: OCCUPIED CHANNEL BANDWIDTH40

 APPENDIX C: MAXIMUM CONDUCTED PEAK OUTPUT POWER.....46

 APPENDIX D: CARRIER FREQUENCY SEPARATION52

 APPENDIX E: TIME OF OCCUPANCY.....55

 APPENDIX F: NUMBER OF HOPPING CHANNELS65

 APPENDIX G: BAND EDGE MEASUREMENTS68

GENERAL INFORMATION

Product Description for Equipment under Test (EUT)

Product	Large Vanity Mirror with True Three Color Lighting and Bluetooth Speaker
Tested Model	iCVBT500
Multiple Model (Only for FCC)	iCVBT500SN, iCVBT500X (where X is single or multiple alphabet(s) combination denoted different color of cabinet)
Model Differences	Refer to the DoS letter
HVIN	iCVBT500a
Frequency Range	Bluetooth: 2402~2480MHz
Maximum conducted Peak output power	Bluetooth: 0.17dBm
Modulation Technique	Bluetooth: GFSK, $\pi/4$ -DQPSK, 8DPSK
Antenna Specification*	0dBi(It is provided by the applicant)
Voltage Range	DC 18V from adapter
Date of Test	2021-07-16 to 2021-07-26
Sample number	SZKA210706-27483E-RF-S1(Assigned by BACL, Shenzhen)
Received date	2021-07-06
Sample/EUT Status	Good condition
Adapter information	Model: CW1804000US Input: AC 100-240V, 50/60Hz, 1.2A MAX Output: DC 18V, 4000mA

Objective

This test report is in accordance with Part 2-Subpart J, Part 15-Subparts A and C of the Federal Communication Commissions rules and RSS-GEN ISSUE 5, FEBRUARY 2021 AMENDMENT 2 and RSS-247, Issue 2, February 2017 of the Innovation, Science and Economic Development Canada rules.

The tests were performed in order to determine compliance with FCC Part 15, Subpart C, section 15.203, 15.205, 15.207, 15.209 and 15.247 rules.

Test Methodology

All measurements contained in this report were conducted with ANSI C63.10-2013, American National Standard of Procedures for Compliance Testing of Unlicensed Wireless Devices. RSS-GEN ISSUE 5, FEBRUARY 2021 AMENDMENT 2 and RSS-247, Issue 2, February 2017.

All emissions measurement was performed at Bay Area Compliance Laboratories Corp. (Shenzhen). The radiated testing was performed at an antenna-to-EUT distance of 3 meters. Each test item follows test standards and with no deviation.

Measurement Uncertainty

Parameter		Uncertainty
Occupied Channel Bandwidth		±5%
RF Output Power with Power meter		±0.73dB
RF conducted test with spectrum		±1.6dB
AC Power Lines Conducted Emissions		±1.95dB
Emissions, Radiated	Below 1GHz	±4.75dB
	Above 1GHz	±4.88dB
Temperature		±1°C
Humidity		±6%
Supply voltages		±0.4%

Note: The extended uncertainty given in this report is obtained by combining the standard uncertainty times the coverage factor K with the 95% confidence interval. Otherwise required by the applicant or Product Regulations, Decision Rule in this report did not consider the uncertainty.

Test Facility

The Test site used by Bay Area Compliance Laboratories Corp. (Shenzhen) to collect test data is located on the 5F(B-West) , 6F, 7F, the 3rd Phase of Wan Li Industrial Building D, Shihua Rd, FuTian Free Trade Zone, Shenzhen, China.

The test site has been approved by the FCC under the KDB 974614 D01 and is listed in the FCC Public Access Link (PAL) database, FCC Registration No.: 342867, the FCC Designation No.: CN1221.

The test site has been registered with ISED Canada under ISED Canada Registration Number 3062B.

The lab has been recognized by Innovation, Science and Economic Development Canada to test to Canadian radio equipment requirements, the CAB identifier: CN0023.

SYSTEM TEST CONFIGURATION

Description of Test Configuration

The system was configured for testing in an engineering mode.

EUT Exercise Software

EUT was tested in signaling mode, the power level is default. The power level was provided by the applicant.

Special Accessories

No special accessory.

Equipment Modifications

No modification was made to the EUT tested.

Support Equipment List and Details

Manufacturer	Description	Model	Serial Number
Unknown	Load 1	5Ω	#1
Unknown	Load 2	5Ω	#2
Rohde & Schwarz	Wideband Radio Communication Tester	CMW500	1201.0002K50-116218-U

External I/O Cable

Cable Description	Length (m)	From Port	To
Un-shielding Un-Detachable DC Cable	1.5	Adapter	EUT
Un-shielding Detachable DC Cable	0.5	EUT	Load 1
Un-shielding Detachable DC Cable	0.5	EUT	Load 2

Block Diagram of Test Setup

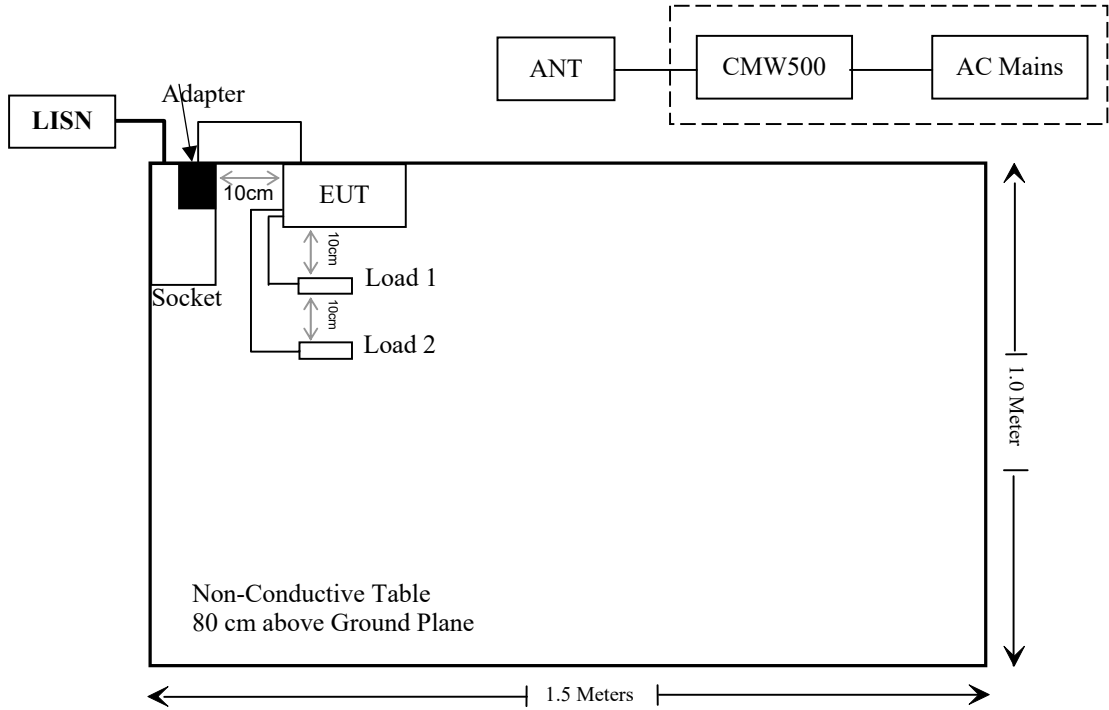

SUMMARY OF TEST RESULTS

FCC Rules	ISED Rules	Description of Test	Result
§15.247 (i), §2.1091	RSS-102 § 2.5.2	Maximum Permissible Exposure(MPE) & Exemption Limits for Routine Evaluation – RF Exposure Evaluation	Compliance
§15.203	RSS-Gen §6.8	Antenna Requirement	Compliance
§15.207(a)	RSS-Gen §8.8	AC Line Conducted Emissions	Compliance
§15.205, §15.209 & §15.247(d)	RSS-247 § 5.5	Radiated Emissions	Compliance
§15.247(a)(1)	RSS- Gen§6.7, RSS-247 § 5.1 (a)	99% Occupied Bandwidth & 20 dB Emission Bandwidth	Compliance
§15.247(a)(1)	RSS-247 § 5.1 (b)	Channel Separation Test	Compliance
§15.247(a)(1)(iii)	RSS-247 § 5.1 (d)	Time of Occupancy (Dwell Time)	Compliance
§15.247(a)(1)(iii)	RSS-247 § 5.1 (d)	Quantity of hopping channel Test	Compliance
§15.247(b)(1)	RSS-247 § 5.1(b) & § 5.4(b)	Peak Output Power Measurement	Compliance
§15.247(d)	RSS-247 § 5.5	Band edges	Compliance

TEST EQUIPMENT LIST

Manufacturer	Description	Model	Serial Number	Calibration Date	Calibration Due Date
Conducted Emissions Test					
Rohde & Schwarz	EMI Test Receiver	ESCI	101120	2021/07/07	2022/07/06
Rohde & Schwarz	LISN	ENV216	101613	2021/07/07	2022/07/06
Rohde & Schwarz	Transient Limiter	ESH3Z2	DE25985	2020/11/29	2021/11/28
Unknown	CE Cable	CE Cable	UF A210B-1-0720-504504	2020/11/29	2021/11/28
Rohde & Schwarz	CE Test software	EMC 32	V8.53.0	NCR	NCR
Radiated Emission Test					
R&S	EMI Test Receiver	ESR3	102455	2021/07/06	2022/07/05
Sonoma instrument	Pre-amplifier	310 N	186238	2020/08/04	2021/08/03
Sunol Sciences	Broadband Antenna	JB1	A040904-2	2020/12/22	2023/12/21
Unknown	Cable 2	RF Cable 2	F-03-EM197	2020/11/29	2021/11/28
Unknown	Cable	Chamber Cable 1	F-03-EM236	2020/11/29	2021/11/28
Rohde & Schwarz	Auto test software	EMC 32	V9.10	NCR	NCR
Rohde & Schwarz	Spectrum Analyzer	FSV40-N	102259	2021/07/06	2022/07/05
COM-POWER	Pre-amplifier	PA-122	181919	2020/11/29	2021/11/28
Quinstar	Amplifier	QLW-18405536-J0	15964001002	2020/11/28	2021/11/27
Sunol Sciences	Horn Antenna	3115	9107-3694	2021/01/15	2024/01/14
Insulated Wire Inc.	RF Cable	SPS-2503-3150	02222010	2020/11/29	2021/11/28
Unknown	RF Cable	W1101-EQ1 OUT	F-19-EM005	2020/11/29	2021/11/28
SNSD	Band Reject filter	BSF2402-2480MN-0898-001	2.4G filter	2021/04/20	2022/04/20
Ducommun Technologies	Horn antenna	ARH-4223-02	1007726-021304	2020/12/06	2023/12/05
RF Conducted Test					
Tonscend Corporation	RF control Unit	JS0806-2	19D8060154	2021/07/06	2022/07/05
Rohde & Schwarz	Signal and Spectrum Analyzer	FSV40	101473	2021/07/06	2022/07/05
Unknown	Cable 2	RF Cable 2	F-03-EM197	2020/11/29	2021/11/28

* **Statement of Traceability:** Bay Area Compliance Laboratories Corp. (Shenzhen) attests that all calibrations have been performed in accordance to requirements that traceable to National Primary Standards and International System of Units (SI).

FCC §15.247 (i) & §2.1091- MAXIMUM PERMISSIBLE EXPOSURE (MPE)

Applicable Standard

According to subpart 15.247 (i) and subpart 2.1091 systems operating under the provisions of this section shall be operated in a manner that ensures the public is not exposed to RF energy level in excess of the communication guidelines.

Limits for General Population/Uncontrolled Exposure

Limits for General Population/Uncontrolled Exposure				
Frequency Range (MHz)	Electric Field Strength (V/m)	Magnetic Field Strength (A/m)	Power Density (mW/cm ²)	Averaging Time (Minutes)
0.3-1.34	614	1.63	*(100)	30
1.34-30	824/f	2.19/f	*(180/f ²)	30
30-300	27.5	0.073	0.2	30
300-1500	/	/	f/1500	30
1500-100,000	/	/	1.0	30

f = frequency in MHz

* = Plane-wave equivalent power density

Result

Calculated Formulary:

Predication of MPE limit at a given distance

$$S = \frac{PG}{4\pi R^2}$$

S = power density (in appropriate units, e.g. mW/cm²)

P = power input to the antenna (in appropriate units, e.g., mW).

G = power gain of the antenna in the direction of interest relative to an isotropic radiator, the power gain factor, is normally numeric gain.

R = distance to the center of radiation of the antenna (appropriate units, e.g., cm)

Frequency (MHz)	Antenna Gain		Tune up conducted power		Evaluation Distance (cm)	Power Density (mW/cm ²)	MPE Limit (mW/cm ²)
	(dBi)	(numeric)	(dBm)	(mW)			
2402-2480	0	1.0	0.5	1.12	20	0.0002	1

Note: To maintain compliance with the FCC’s RF exposure guidelines, place the equipment at least 20cm from nearby persons.

Result: Compliance

RSS-102 § 2.5.2 –EXEMPTION LIMITS FOR ROUTINE EVALUATION-RF EXPOSURE EVALUATION

Applicable Standard

According to RSS-102 § (2.5.2):

RF exposure evaluation is required if the separation distance between the user and/or bystander and the device's radiating element is greater than 20 cm, except when the device operates as follows:

- below 20 MHz and the source-based, time-averaged maximum e.i.r.p. of the device is equal to or less than 1 W (adjusted for tune-up tolerance);
- at or above 20 MHz and below 48 MHz and the source-based, time-averaged maximum e.i.r.p. of the device is equal to or less than $4.49/f^{0.5}$ W (adjusted for tune-up tolerance), where f is in MHz;
- at or above 48 MHz and below 300 MHz and the source-based, time-averaged maximum e.i.r.p. of the device is equal to or less than 0.6 W (adjusted for tune-up tolerance);
- at or above 300 MHz and below 6 GHz and the source-based, time-averaged maximum e.i.r.p. of the device is equal to or less than $1.31 \times 10^{-2} f^{0.6834}$ W (adjusted for tune-up tolerance), where f is in MHz;
- at or above 6 GHz and the source-based, time-averaged maximum e.i.r.p. of the device is equal to or less than 5 W (adjusted for tune-up tolerance). In these cases, the information contained in the RF exposure technical brief may be limited to information that demonstrates how the e.i.r.p. was derived.

Calculated Data:

The maximum tune-up conducted output power is 0.5 dBm, antenna gain is 0dBi.

So the maximum e.i.r.p. of the device is $0.5\text{dBm} + 0\text{dBi} = 0.5\text{dBm} = 0.0012\text{W}$

The worst case is $f = 2402$ MHz:

The limit is $1.31 \times 10^{-2} f^{0.6834} \text{W} = 2.68\text{W}$

$0.0012\text{W} < 2.68\text{W}$

So the RF Exposure evaluation can be exempted.

FCC §15.203 & RSS-GEN §6.8– ANTENNA REQUIREMENT

Applicable Standard

According to FCC § 15.203, an intentional radiator shall be designed to ensure that no antenna other than that furnished by the responsible party shall be used with the device. The use of a permanently attached antenna or of an antenna that uses a unique coupling to the intentional radiator shall be considered sufficient to comply with the provisions of this Section. The manufacturer may design the unit so that a broken antenna can be replaced by the user, but the use of a standard antenna jack or electrical connector is prohibited.

The applicant for equipment certification shall provide a list of all antenna types that may be used with the transmitter, where applicable (i.e. for transmitters with detachable antenna), indicating the maximum permissible antenna gain (in dBi) and the required impedance for each antenna. The test report shall demonstrate the compliance of the transmitter with the limit for maximum equivalent isotropically radiated power (e.i.r.p.) specified in the applicable RSS, when the transmitter is equipped with any antenna type, selected from this list.

For expediting the testing, measurements may be performed using only the antenna with highest gain of each combination of transmitter and antenna type, with the transmitter output power set at the maximum level. However, the transmitter shall comply with the applicable requirements under all operational conditions and when in combination with any type of antenna from the list provided in the test report (and in the notice to be included in the user manual, provided below).

When measurements at the antenna port are used to determine the RF output power, the effective gain of the device's antenna shall be stated, based on a measurement or on data from the antenna's manufacturer.

The test report shall state the RF power, output power setting and spurious emission measurements with each antenna type that is used with the transmitter being tested.

For licence-exempt equipment with detachable antennas, the user manual shall also contain the following notice in a conspicuous location:

This radio transmitter [enter the device's ISED certification number] has been approved by Innovation, Science and Economic Development Canada to operate with the antenna types listed below, with the maximum permissible gain indicated. Antenna types not included in this list that have a gain greater than the maximum gain indicated for any type listed are strictly prohibited for use with this device. Immediately following the above notice, the manufacturer shall provide a list of all antenna types which can be used with the transmitter, indicating the maximum permissible antenna gain (in dBi) and the required impedance for each antenna type.

Antenna Connector Construction

The EUT has one internal antenna arrangement, which was permanently attached and the antenna gain is 0 dBi, fulfill the requirement of this section. Please refer to the EUT photos.

Type	Antenna Gain	Impedance
PCB	0dBi	50 Ω

Result: Compliance.

FCC §15.207 (a) & RSS-GEN §8.8– AC LINE CONDUCTED EMISSIONS

Applicable Standard

FCC §15.207(a)

Unless stated otherwise in the applicable RSS, for radio apparatus that are designed to be connected to the public utility AC power network, the radio frequency voltage that is conducted back onto the AC power line on any frequency or frequencies within the range 150 kHz to 30 MHz shall not exceed the limits in table 4, as measured using a 50 μ H / 50 Ω line impedance stabilization network. This requirement applies for the radio frequency voltage measured between each power line and the ground terminal of each AC power-line mains cable of the EUT.

For an EUT that connects to the AC power lines indirectly, through another device, the requirement for compliance with the limits in table 4 shall apply at the terminals of the AC power-line mains cable of a representative support device, while it provides power to the EUT. The lower limit applies at the boundary between the frequency ranges. The device used to power the EUT shall be representative of typical applications.

Table 4 - AC Power Lines Conducted Emission Limits		
Frequency range (MHz)	Conducted limit (dBμV)	
	Quasi-Peak	Average
0.15 – 0.5	66 to 56 ¹	56 to 46 ¹
0.5 – 5	56	46
5 – 30	60	50

Note 1: The level decreases linearly with the logarithm of the frequency.

For an EUT with a permanent or detachable antenna operating between 150 kHz and 30 MHz, the AC power-line conducted emissions must be measured using the following configurations:

- (a) Perform the AC power-line conducted emissions test with the antenna connected to determine compliance with the limits of table 4 outside the transmitter's fundamental emission band.
- (b) Retest with a dummy load instead of the antenna to determine compliance with the limits of table 4 within the transmitter's fundamental emission band. For a detachable antenna, remove the antenna and connect a suitable dummy load to the antenna connector. For a permanent antenna, remove the antenna and terminate the RF output with a dummy load or network that simulates the antenna in the fundamental frequency band.

EUT Setup

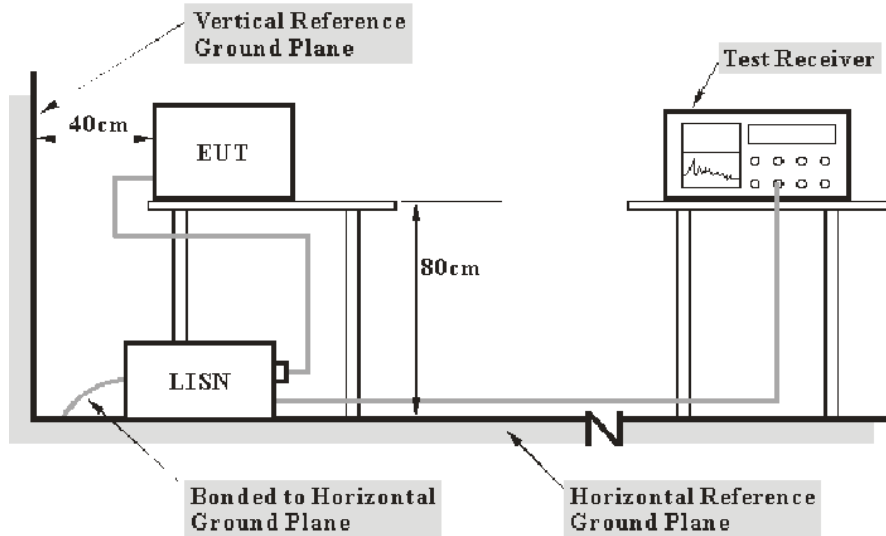

- Note: 1. Support units were connected to second LISN.
 2. Both of LISNs (AMN) 80 cm from EUT and at the least 80 cm from other units and other metal planes support units.

The measurement procedure of EUT setup is according with ANSI C63.10-2013. The related limit was specified in FCC Part 15.207 and RSS-Gen limits.

The external I/O cables were draped along the test table and formed a bundle 30 to 40 cm long in the middle.

The spacing between the peripherals was 10 cm.

EMI Test Receiver Setup

The EMI test receiver was set to investigate the spectrum from 150 kHz to 30 MHz.

During the conducted emission test, the EMI test receiver was set with the following configurations:

Frequency Range	IF B/W
150 kHz – 30 MHz	9 kHz

Test Procedure

During the conducted emission test, the adapter was connected to the outlet of the LISN.

Maximizing procedure was performed on the six (6) highest emissions of the EUT.

All final data was recorded in the Quasi-peak and average detection mode.

Corrected Factor & Margin Calculation

The Corrected factor is calculated by adding LISN VDF (Voltage Division Factor), Cable Loss and Transient Limiter Attenuation. The basic equation is as follows:

$$\text{Correction Factor} = \text{LISN VDF} + \text{Cable Loss} + \text{Transient Limiter Attenuation}$$

The “**Margin**” column of the following data tables indicates the degree of compliance with the applicable limit. For example, a margin of 7 dB means the emission is 7 dB below the limit. The equation for margin calculation is as follows:

$$\text{Margin} = \text{Limit} - \text{Corrected Amplitude}$$

Test Data

Environmental Conditions

Temperature:	26 °C
Relative Humidity:	70 %
ATM Pressure:	101.0 kPa

The testing was performed by Haiguo Li on 2021-07-20.

EUT operation mode: Transmitting

AC 120V/60 Hz, Line

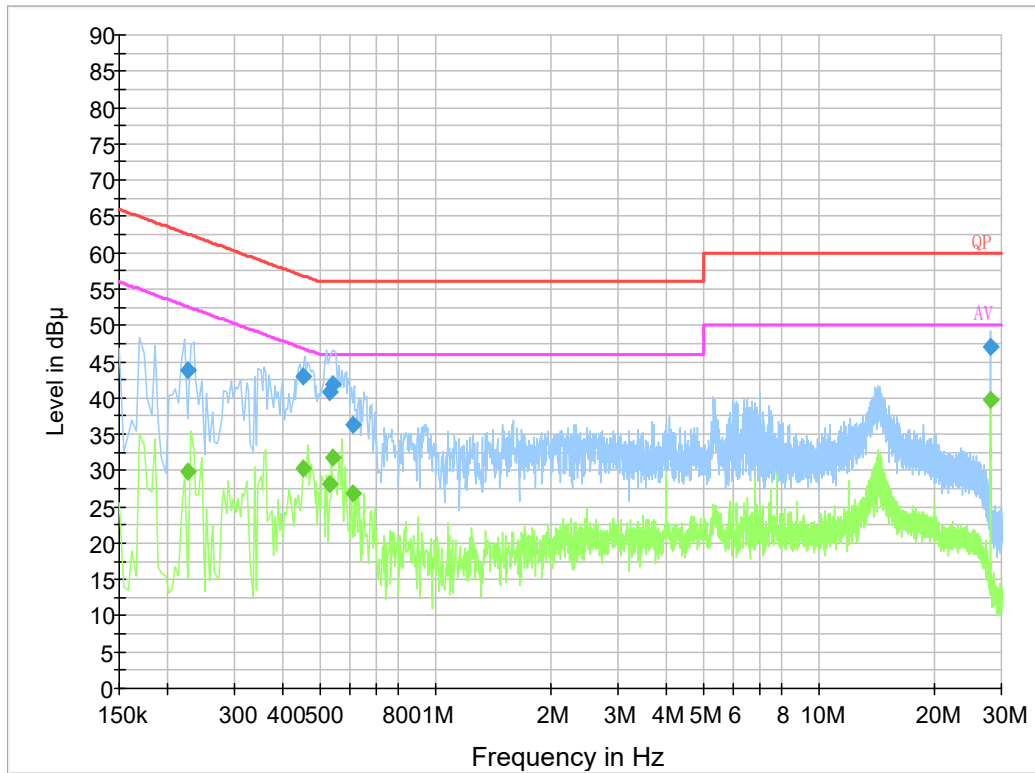

Final Result 1

Frequency (MHz)	QuasiPeak (dB µV)	Bandwidth (kHz)	Line	Corr. (dB)	Margin (dB)	Limit (dB µV)
0.226500	43.8	9.000	L1	19.8	18.8	62.6
0.451130	42.9	9.000	L1	19.8	14.0	56.9
0.529830	40.8	9.000	L1	19.8	15.2	56.0
0.541870	41.8	9.000	L1	19.8	14.2	56.0
0.612790	36.3	9.000	L1	19.8	19.7	56.0
28.061010	46.9	9.000	L1	20.2	13.1	60.0

Final Result 2

Frequency (MHz)	Average (dB µV)	Bandwidth (kHz)	Line	Corr. (dB)	Margin (dB)	Limit (dB µV)
0.226500	29.8	9.000	L1	19.8	22.8	52.6
0.451130	30.4	9.000	L1	19.8	16.5	46.9
0.529830	28.1	9.000	L1	19.8	17.9	46.0
0.541870	31.8	9.000	L1	19.8	14.2	46.0
0.612790	26.9	9.000	L1	19.8	19.1	46.0
28.061010	39.7	9.000	L1	20.2	10.3	50.0

AC 120V/60 Hz, Neutral

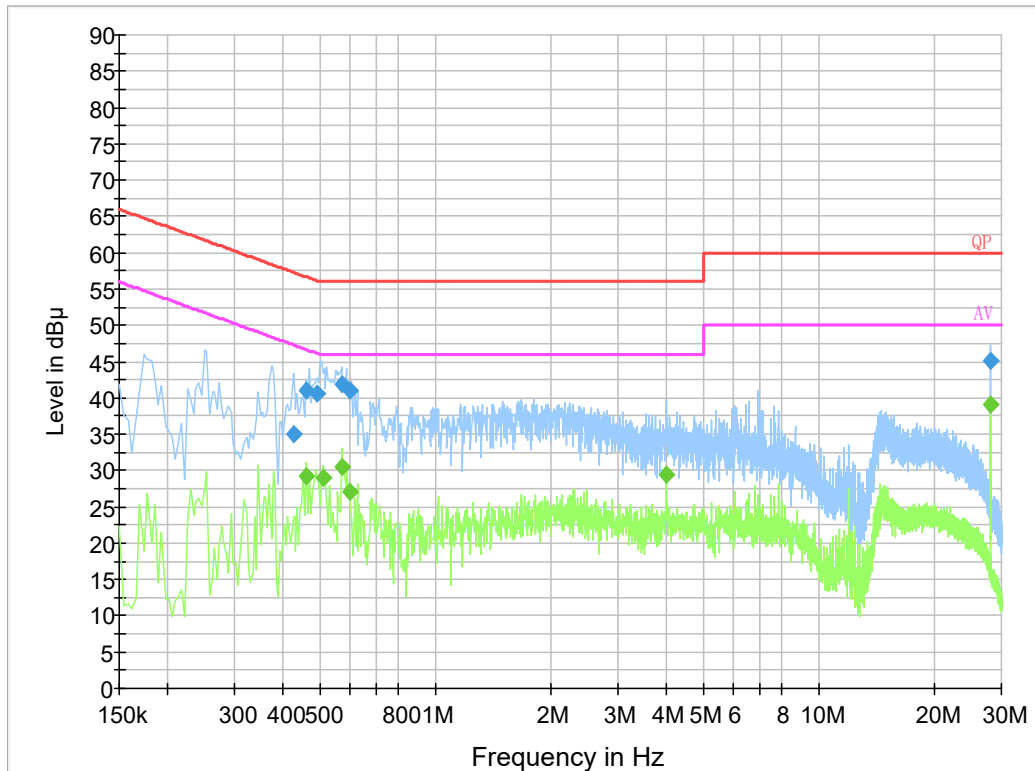

Final Result 1

Frequency (MHz)	QuasiPeak (dB μV)	Bandwidth (kHz)	Line	Corr. (dB)	Margin (dB)	Limit (dB μV)
0.427610	35.1	9.000	N	19.8	22.2	57.3
0.462950	41.0	9.000	N	19.8	15.6	56.6
0.494470	40.5	9.000	N	19.8	15.6	56.1
0.569450	41.9	9.000	N	19.8	14.1	56.0
0.596910	41.1	9.000	N	19.8	14.9	56.0
28.061070	45.2	9.000	N	20.2	14.8	60.0

Final Result 2

Frequency (MHz)	Average (dB μV)	Bandwidth (kHz)	Line	Corr. (dB)	Margin (dB)	Limit (dB μV)
0.462000	29.3	9.000	N	19.8	17.4	46.7
0.510000	29.0	9.000	N	19.8	17.0	46.0
0.570000	30.4	9.000	N	19.8	15.6	46.0
0.598000	27.0	9.000	N	19.8	19.0	46.0
4.010000	29.4	9.000	N	19.9	16.6	46.0
28.062000	39.1	9.000	N	20.2	10.9	50.0

FCC §15.205, §15.209 & §15.247(d) & RSS-247§ 5.5 – RADIATED EMISSIONS

Applicable Standard

FCC §15.205; §15.209; §15.247(d) and RSS-247 §5.5

In any 100 kHz bandwidth outside the frequency band in which the spread spectrum or digitally modulated device is operating, the RF power that is produced shall be at least 20 dB below that in the 100 kHz bandwidth within the band that contains the highest level of the desired power, based on either an RF conducted or a radiated measurement, provided that the transmitter demonstrates compliance with the peak conducted power limits. If the transmitter complies with the conducted power limits based on the use of root-mean-square averaging over a time interval, as permitted under Section 5.4(d), the attenuation required shall be 30 dB instead of 20 dB. Attenuation below the general field strength limits specified in RSS-Gen is not required.

EUT Setup

Below 1 GHz:

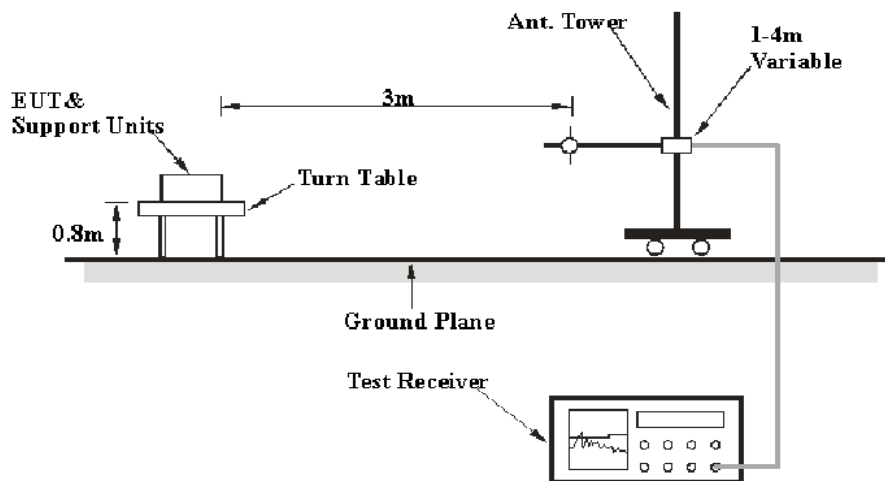

Above 1GHz:

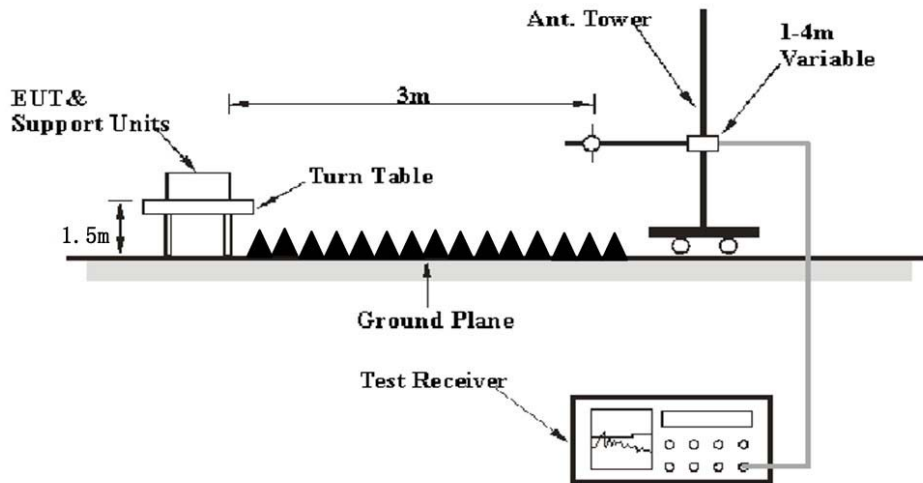

The radiated emission tests were performed in the 3 meters, using the setup accordance with the ANSI C63.10-2013. The specification used was the FCC 15.209, FCC 15.247 limits and RSS-247/RSS-Gen limits.

EMI Test Receiver & Spectrum Analyzer Setup

During the radiated emission test, the EMI test receiver & Spectrum Analyzer Setup were set with the following configurations:

Frequency Range	RBW	Video B/W	IF B/W	Measurement
30 MHz – 1000 MHz	100 kHz	300 kHz	120 kHz	QP
Above 1 GHz	1 MHz	3 MHz	/	PK
	1 MHz	10 Hz	/	Average

Test Procedure

Maximizing procedure was performed on the highest emissions to ensure that the EUT complied with all installation combinations.

All final data was recorded in Quasi-peak detection mode for frequency range of 30 MHz -1 GHz and peak and Average detection modes for frequencies above 1 GHz.

Corrected Amplitude & Margin Calculation

The Corrected Amplitude is calculated by adding the Antenna Factor and Cable Loss, and subtracting the Amplifier Gain from the Meter Reading. The basic equation is as follows:

$$\text{Corrected Amplitude} = \text{Meter Reading} + \text{Antenna Factor} + \text{Cable Loss} - \text{Amplifier Gain}$$

The “**Margin**” column of the following data tables indicates the degree of compliance with the applicable limit. For example, a margin of 7dB means the emission is 7dB below the limit. The equation for margin calculation is as follows:

$$\text{Margin} = \text{Limit} - \text{Corrected Amplitude}$$

Test Data

Environmental Conditions

Temperature:	27.8~30 °C
Relative Humidity:	51~55 %
ATM Pressure:	101.0 kPa

The testing was performed by Williarm Wang on 2021-07-16 for below 1GHz and Dio Ding on 2021-07-26 for above 1GHz.

EUT operation mode: Transmitting

30 MHz~1 GHz:

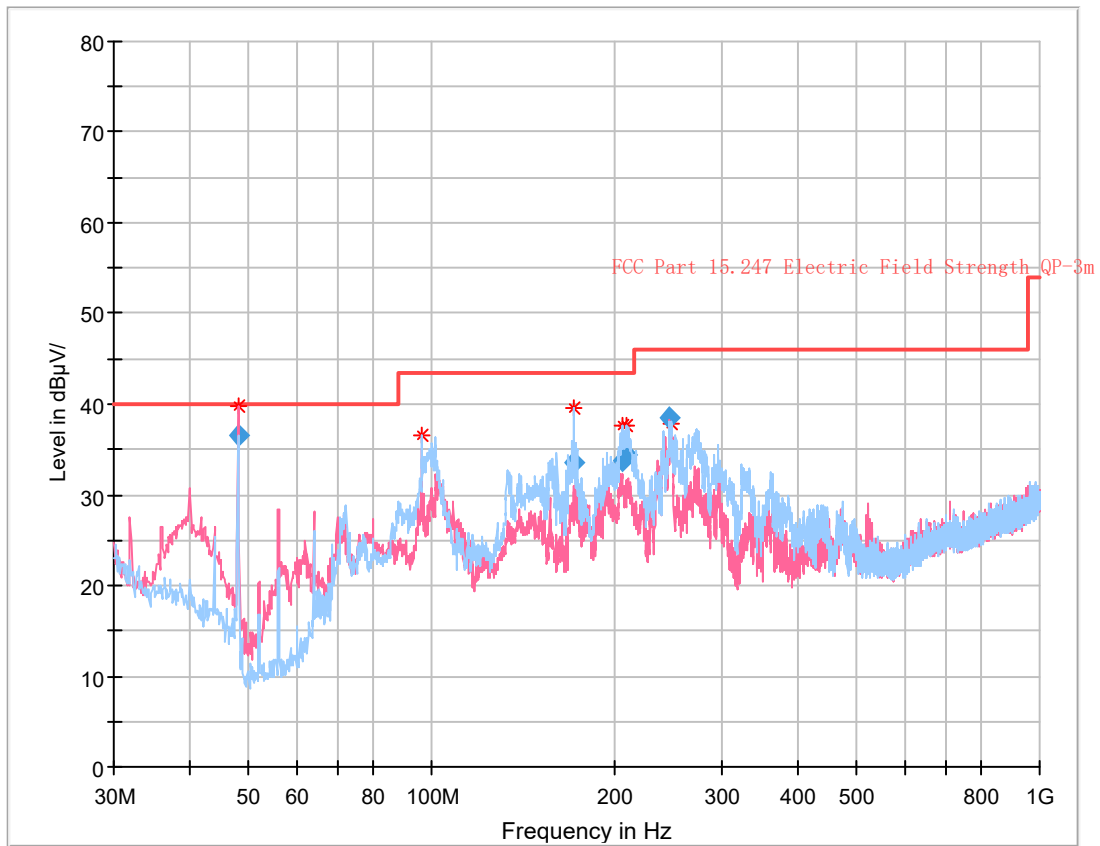

Final Result

Frequency (MHz)	QuasiPeak (dB µ V/m)	Limit (dB µ V/m)	Margin (dB)	Height (cm)	Pol	Azimuth (deg)	Corr. (dB)
48.085875	36.54	40.00	3.46	102.0	V	85.0	-15.6
171.287000	33.45	43.50	10.05	213.0	H	169.0	-12.1
205.280000	33.80	43.50	9.70	109.0	H	114.0	-11.1
209.215500	34.32	43.50	9.18	133.0	H	291.0	-11.2
246.336750	38.46	46.00	7.54	188.0	V	208.0	-11.8

Critical_Freqs

Frequency (MHz)	MaxPeak (dB µ V/m)	Limit (dB µ V/m)	Margin (dB)	Height (cm)	Pol	Azimuth (deg)	Corr. (dB)
96.081250	36.51	43.50	6.99	200.0	H	356.0	-14.8

1 GHz - 25 GHz: (Scan with GFSK, $\pi/4$ -DQPSK, 8DPSK mode, the worst case is 8DPSK Mode)

Frequency (MHz)	Receiver		Turntable Degree	Rx Antenna		Corrected Factor (dB/m)	Corrected Amplitude (dB μ V/m)	Limit (dB μ V/m)	Margin (dB)
	Reading (dB μ V)	PK/QP/Ave.		Height (m)	Polar (H/V)				
Low Channel (2402 MHz)									
2363.55	29.05	PK	208	1.3	V	31.87	60.92	74	13.08
2363.55	15.06	Ave.	208	1.3	V	31.87	46.93	54	7.07
2493.97	29.11	PK	327	2.3	V	32.13	61.24	74	12.76
2493.97	14.58	Ave.	327	2.3	V	32.13	46.71	54	7.29
4804.00	46.43	PK	346	2.1	V	6.28	52.71	74	21.29
4804.00	35.01	Ave.	346	2.1	V	6.28	41.29	54	12.71
Middle Channel (2441 MHz)									
4882.00	46.39	PK	38	1.6	V	6.76	53.15	74	20.85
4882.00	34.68	Ave.	38	1.6	V	6.76	41.44	54	12.56
High Channel (2480 MHz)									
2370.26	29.18	PK	180	1.5	V	31.87	61.05	74	12.95
2370.26	14.57	Ave.	180	1.5	V	31.87	46.44	54	7.56
2485.18	29.01	PK	184	1.5	V	32.13	61.14	74	12.86
2485.18	14.92	Ave.	184	1.5	V	32.13	47.05	54	6.95
4960.00	47.48	PK	281	1.9	V	6.80	54.28	74	19.72
4960.00	38.04	Ave.	281	1.9	V	6.80	44.84	54	9.16

Note:

Corrected Factor = Antenna factor (RX) + Cable Loss – Amplifier Factor

Corrected Amplitude = Corrected Factor + Reading

Margin = Limit - Corrected. Amplitude

The other spurious emission which is 20dB to the limit was not recorded.

Pre-scan with high channel Peak Horizontal

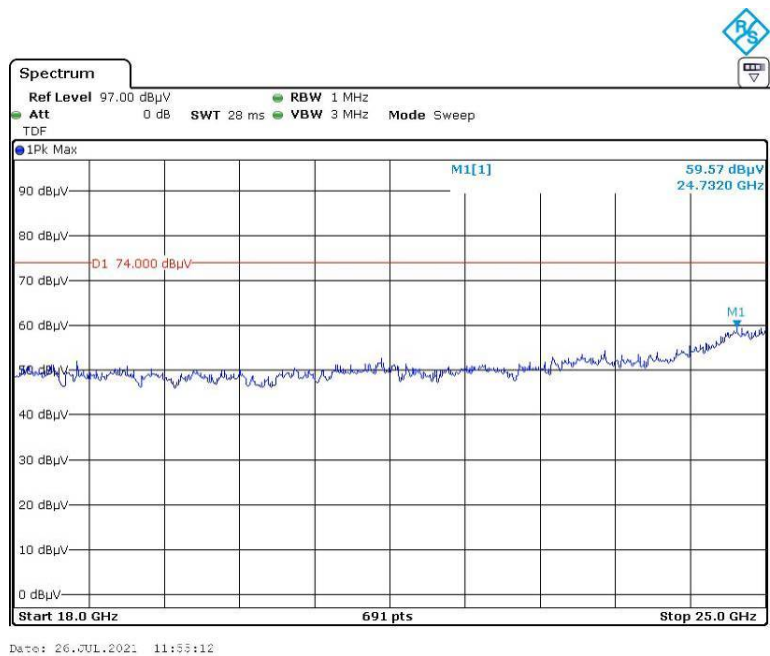
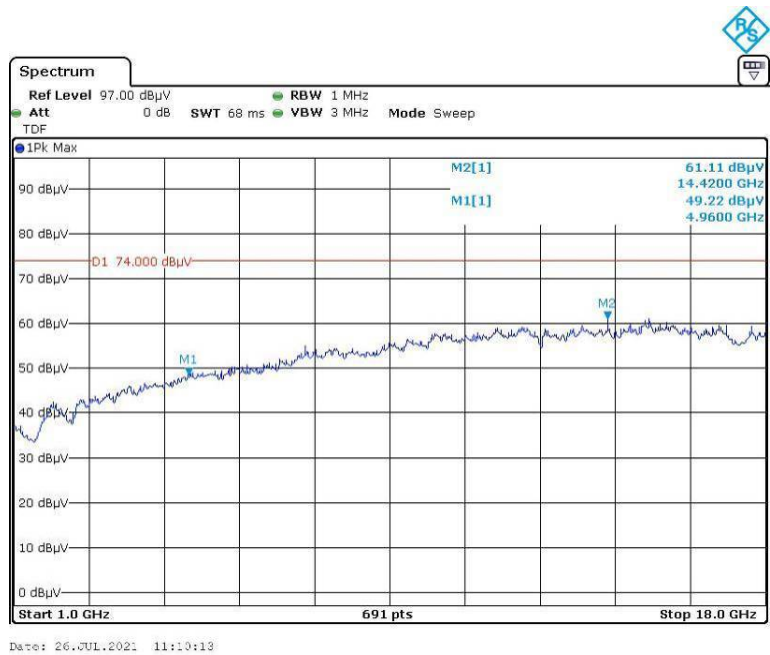

Vertical

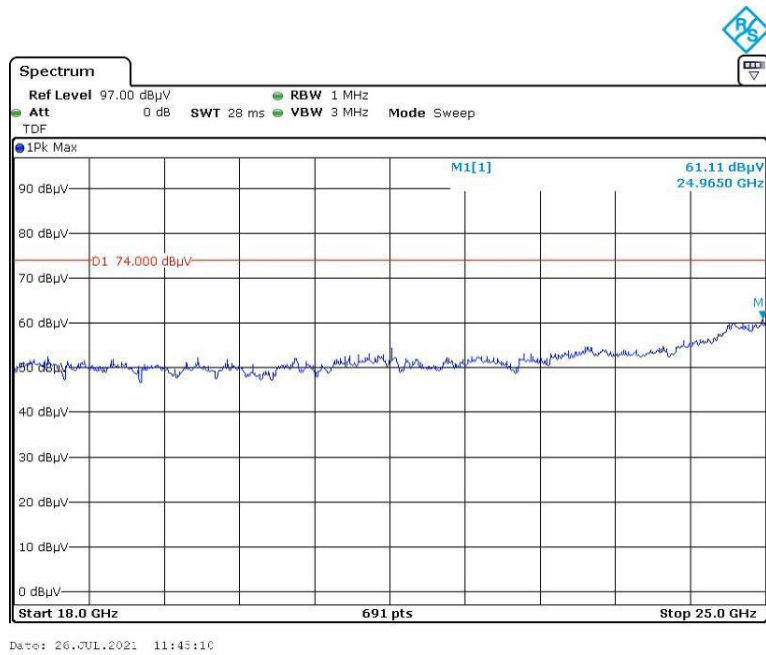
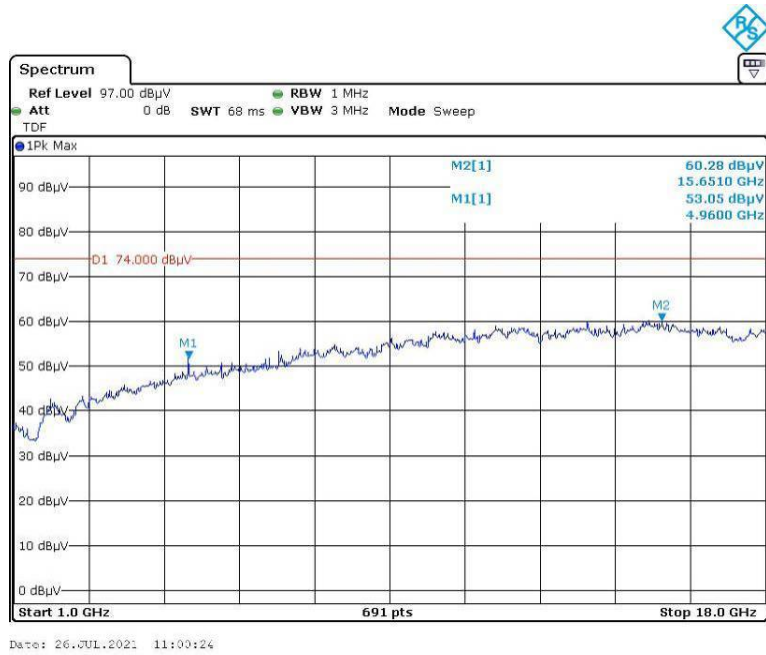

Average Horizontal

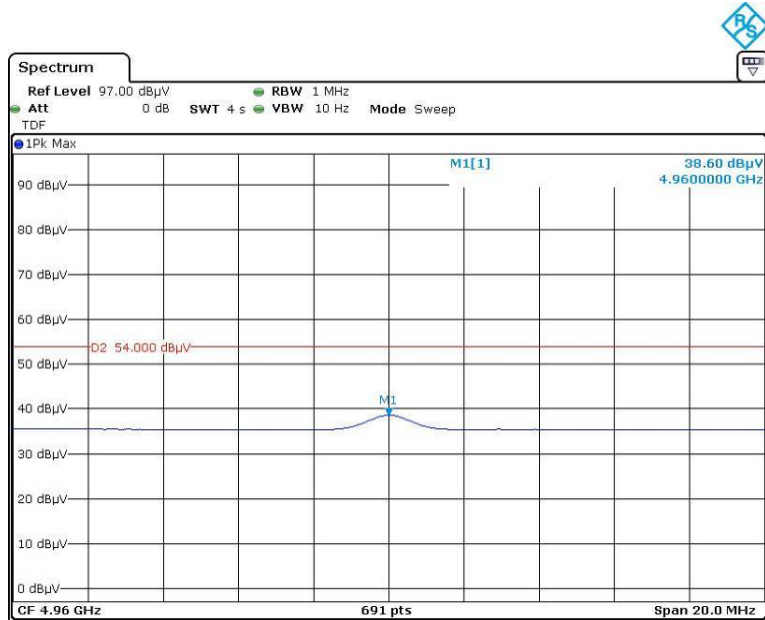

Date: 26.JUL.2021 11:18:07

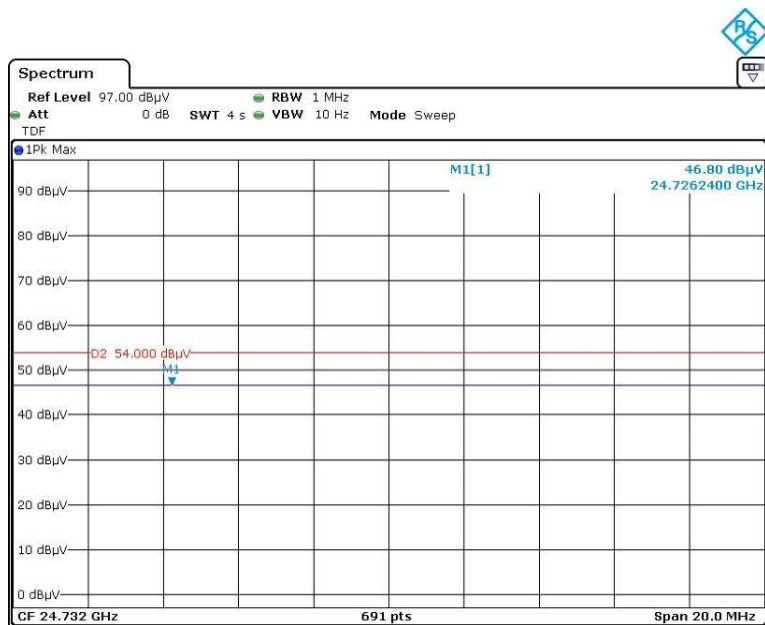

Date: 26.JUL.2021 11:59:38

Vertical

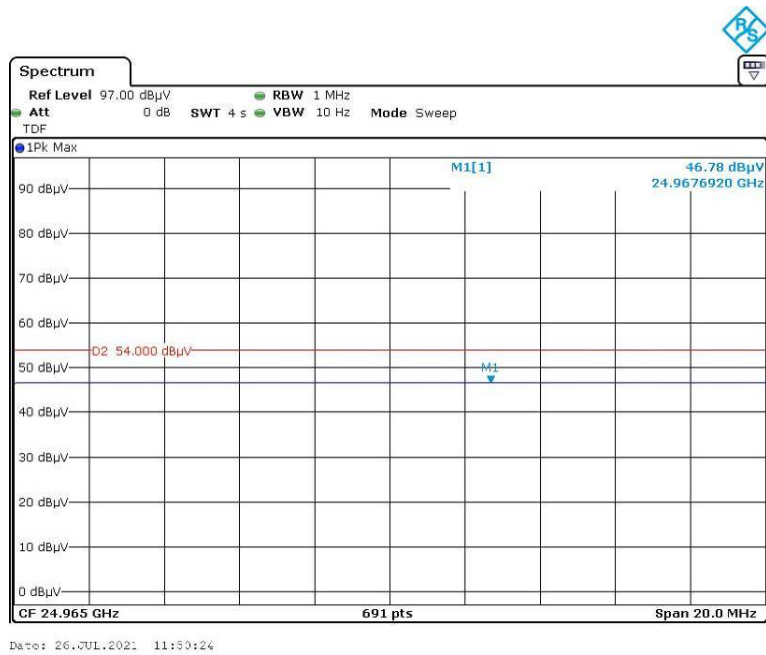
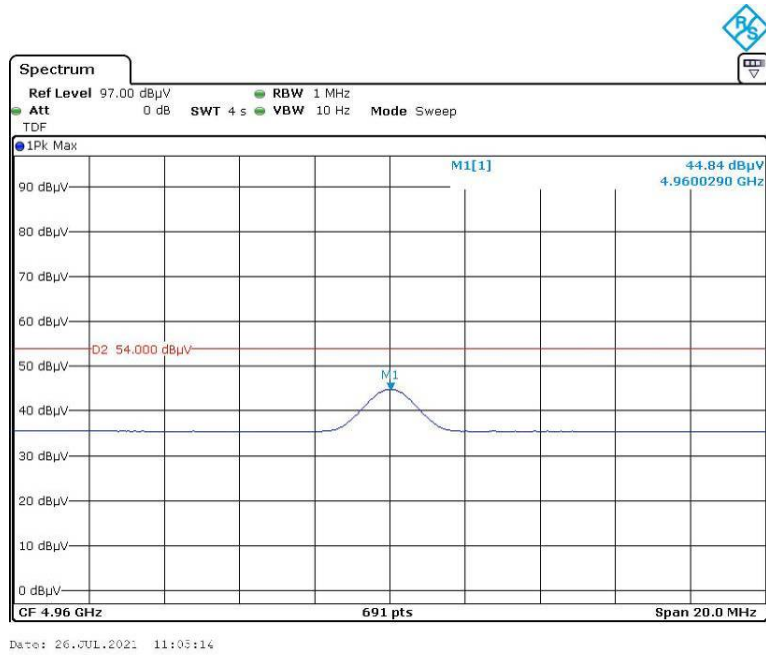

FCC §15.247(a) (1) & RSS-247 § 5.1 (b)-CHANNEL SEPARATION TEST

Applicable Standard

Frequency hopping systems (FHSs) shall have hopping channel carrier frequencies separated by a minimum of 25 kHz or the 20 dB bandwidth of the hopping channel, whichever is greater. Alternatively, frequency hopping systems operating in the 2400-2483.5 MHz band may have hopping channel carrier frequencies that are separated by 25 kHz or two-thirds of the 20 dB bandwidth of the hopping channel, whichever is greater provided the systems operate with an output power no greater than 125 mW. The system shall hop to channel frequencies that are selected at the system hopping rate from a pseudo randomly ordered list of hopping frequencies. Each frequency must be used equally on the average by each transmitter. The system receivers shall have input bandwidths that match the hopping channel bandwidths of their corresponding transmitters and shall shift frequencies in synchronization with the transmitted signals.

Test Procedure

1. Set the EUT in transmitting mode, maxhold the channel and in Operating mode, RBW was set at 30 kHz, VBW \geq 3RBW max-hold the channel.
2. Set the adjacent channel of the EUT and maxhold another trace.
3. Measure the channel separation.

Test Data

Environmental Conditions

Temperature:	28.9 °C
Relative Humidity:	54 %
ATM Pressure:	101.0 kPa

The testing was performed by Bravos Zhao on 2021-07-26.

EUT operation mode: Transmitting

Test Result: Compliant. Please refer to the Appendix.

FCC §15.247(a) (1) & RSS-GEN § 6.7 & RSS-247 § 5.1 (a)–99% OCCUPIED BANDWIDTH & 20 dB EMISSION BANDWIDTH

Applicable Standard

Alternatively, frequency hopping systems operating in the 2400–2483.5 MHz band may have hopping channel carrier frequencies that are separated by 25 kHz or two-thirds of the 20 dB bandwidth of the hopping channel, whichever is greater, provided the systems operate with an output power no greater than 125 mW.

The occupied bandwidth or the “99% emission bandwidth” is defined as the frequency range between two points, one above and the other below the carrier frequency, within which 99% of the total transmitted power of the fundamental transmitted emission is contained. The occupied bandwidth shall be reported for all equipment in addition to the specified bandwidth required in the applicable RSSs.

In some cases, the “20 dB bandwidth” is required, which is defined as the frequency range between two points, one at the lowest frequency below and one at the highest frequency above the carrier frequency, at which the maximum power level of the transmitted emission is attenuated 20 dB below the maximum in-band power level of the modulated signal, where the two points are on the outskirts of the in-band emission.

Test Procedure

1. Check the calibration of the measuring instrument using either an internal calibrator or a known signal from an external generator.
2. Position the EUT without connection to measurement instrument. Turn on the EUT and connect it to measurement instrument. Then set it to any one convenient frequency within its operating range. Set a reference level on the measuring instrument equal to the highest peak value.
3. Measure the frequency difference of two frequencies that were attenuated 20 dB from the reference level. Record the frequency difference as the emission bandwidth.
4. Repeat above procedures until all frequencies measured were complete.

The following conditions shall be observed for measuring the occupied bandwidth and 20 dB bandwidth:

- The transmitter shall be operated at its maximum carrier power measured under normal test conditions.
- The span of the spectrum analyzer shall be set large enough to capture all products of the modulation process, including the emission skirts, around the carrier frequency, but small enough to avoid having other emissions (e.g. on adjacent channels) within the span.
- The detector of the spectrum analyzer shall be set to “Sample”. However, a peak, or peak hold, may be used in place of the sampling detector since this usually produces a wider bandwidth than the actual bandwidth (worst-case measurement). Use of a peak hold (or “Max Hold”) may be necessary to determine the occupied / 20 dB bandwidth if the device is not transmitting continuously.
- The resolution bandwidth (RBW) shall be in the range of 1% to 5% of the actual occupied / 20 dB bandwidth and the video bandwidth (VBW) shall not be smaller than three times the RBW value. Video averaging is not permitted.

Note: It may be necessary to repeat the measurement a few times until the RBW and VBW are in compliance with the above requirement.

For the 99% emission bandwidth, the trace data points are recovered and directly summed in linear power level terms. The recovered amplitude data points, beginning at the lowest frequency, are placed in a running sum until 0.5% of the total is reached, and that frequency recorded. The process is repeated for the highest frequency data points (starting at the highest frequency, at the right side of the span, and going down in frequency). This frequency is then recorded. The difference between the two recorded frequencies is the occupied bandwidth (or the 99% emission bandwidth).

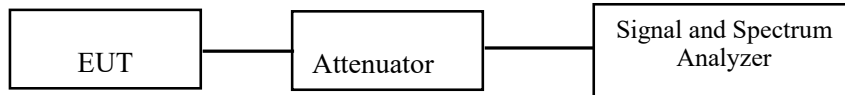

Test Data

Environmental Conditions

Temperature:	24 °C
Relative Humidity:	55 %
ATM Pressure:	101.0 kPa

The testing was performed by Bravos Zhao on 2021-07-26.

EUT operation mode: Transmitting

Test Result: Compliant. Please refer to the Appendix.

FCC §15.247(a) (1) (iii) & RSS-247 § 5.1 (d)-QUANTITY OF HOPPING CHANNEL TEST

Applicable Standard

Frequency hopping systems (FHSs) in the 2400–2483.5 MHz band shall use at least 15 channels. The average time of occupancy on any channel shall not be greater than 0.4 seconds within a period of 0.4 seconds multiplied by the number of hopping channels employed. Frequency hopping systems may avoid or suppress transmissions on a particular hopping frequency provided that a minimum of 15 channels are used.

Test Procedure

1. Check the calibration of the measuring instrument (SA) using either an internal calibrator or a known signal from an external generator.
2. Set the EUT in hopping mode from first channel to last.
3. By using the max-hold function record the quantity of the channel.

Test Data

Environmental Conditions

Temperature:	24 °C
Relative Humidity:	55 %
ATM Pressure:	101.0 kPa

The testing was performed by Bravos Zhao on 2021-07-26.

EUT operation mode: Transmitting

Test Result: Compliant. Please refer to the Appendix.

FCC §15.247(a) (1) (iii) & RSS-247 § 5.1 (d) - TIME OF OCCUPANCY (DWELL TIME)

Applicable Standard

Frequency hopping systems (FHSs) in the 2400-2483.5 MHz shall use at least 15 channels. The average time of occupancy on any channel shall not be greater than 0.4 seconds within a period of 0.4 seconds multiplied by the number of hopping channels employed. Frequency hopping systems may avoid or suppress transmissions on a particular hopping frequency provided that a minimum of 15 channels are used.

Test Procedure

1. The EUT was worked in channel hopping.
2. Set the RBW to: 1MHz.
3. Set the VBW $\geq 3 \times$ RBW.
4. Set the span to 0Hz.
5. Detector = peak.
6. Sweep time = auto couple.
7. Trace mode = max hold.
8. Allow trace to fully stabilize.
9. Recorded the time of single pulses

Test Data

Environmental Conditions

Temperature:	24 °C
Relative Humidity:	55 %
ATM Pressure:	101.0 kPa

The testing was performed by Bravos Zhao on 2021-07-26.

EUT operation mode: Transmitting

Test Result: Compliant. Please refer to the Appendix.

FCC §15.247(b) (1) & RSS-247§ 5.1(b) &§ 5.4(b) - PEAK OUTPUT POWER MEASUREMENT

Applicable Standard

According to §15.247(b) (1), for frequency hopping systems operating in the 2400–2483.5 MHz band employing at least 75 non-overlapping hopping channels, and all frequency hopping systems in the 5725–5850 MHz band: 1 watt. And for all other frequency hopping systems in the 2400–2483.5 MHz band: 0.125 watts.

For frequency hopping systems (FHSs) operating in the band 2400-2483.5 MHz, the maximum peak conducted output power shall not exceed 1.0 W if the hopset uses 75 or more hopping channels; the maximum peak conducted output power shall not exceed 0.125 W if the hopset uses less than 75 hopping channels. The e.i.r.p. shall not exceed 4 W (see Section 5.4(e) for exceptions).

Frequency hopping systems (FHSs) shall have hopping channel carrier frequencies separated by a minimum of 25 kHz or the -20 dB bandwidth of the hopping channel, whichever is greater. Alternatively, FHSs operating in the band 2400-2483.5 MHz may have hopping channel carrier frequencies that are separated by 25 kHz or two thirds of the -20 dB bandwidth of the hopping channel, whichever is greater, provided that the systems operate with an output power no greater than 0.125 W.

Test Procedure

1. Place the EUT on a bench and set in transmitting mode.
2. Remove the antenna from the EUT and then connect a low loss RF cable from the antenna port to one test equipment.
3. Add a correction factor to the display.

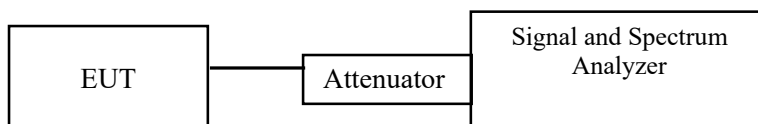

Test Data

Environmental Conditions

Temperature:	24 °C
Relative Humidity:	55 %
ATM Pressure:	101.0 kPa

The testing was performed by Bravos Zhao on 2021-07-26.

EUT operation mode: Transmitting

Test Result: Compliant. Please refer to the Appendix.

FCC §15.247(d) & RSS-247 § 5.5 - BAND EDGES TESTING

Applicable Standard

According to FCC §15.247(d) & RSS-247 § 5.5.

In any 100 kHz bandwidth outside the frequency band in which the spread spectrum or digitally modulated intentional radiator is operating, the radio frequency power that is produced by the intentional radiator shall be at least 20 dB below that in the 100 kHz bandwidth within the band that contains the highest level of the desired power, based on either an RF conducted or a radiated measurement, provided the transmitter demonstrates compliance with the peak conducted power limits. If the transmitter complies with the conducted power limits based on the use of RMS averaging over a time interval, as permitted under paragraph (b)(3) of this section, the attenuation required under this paragraph shall be 30 dB instead of 20 dB. Attenuation below the general limits specified in §15.209(a) is not required. In addition, radiated emissions which fall in the restricted bands, as defined in §15.205(a), must also comply with the radiated emission limits specified in §15.209(a) (see §15.205(c)) & RSS-Gen.

Test Procedure

1. Check the calibration of the measuring instrument using either an internal calibrator or a known signal from an external generator.
2. Remove the antenna from the EUT and then connect to a low loss RF cable from the antenna port to a EMI test receiver, then turn on the EUT and make it operate in transmitting mode. Then set it to Low Channel and High Channel within its operating range, and make sure the instrument is operated in its linear range.
3. Set RBW of spectrum analyzer to 100 kHz with a convenient frequency span including 100 kHz bandwidth from band edge.
4. Measure the highest amplitude appearing on spectral display and set it as a reference level. Plot the graph with marking the highest point and edge frequency.
5. Repeat above procedures until all measured frequencies were complete.

Test Data

Environmental Conditions

Temperature:	24 °C
Relative Humidity:	55 %
ATM Pressure:	101.0 kPa

The testing was performed by Bravos Zhao on 2021-07-26.

EUT operation mode: Transmitting

Test Result: Compliant. Please refer to the Appendix.

APPENDIX**Appendix A: 20dB Emission Bandwidth
Test Result**

TestMode	Antenna	Channel	20db EBW[MHz]	Limit[MHz]	Verdict
DH1	Ant1	2402	0.879	---	PASS
		2441	0.885	---	PASS
		2480	0.888	---	PASS
2DH1	Ant1	2402	1.260	---	PASS
		2441	1.266	---	PASS
		2480	1.251	---	PASS
3DH1	Ant1	2402	1.236	---	PASS
		2441	1.239	---	PASS
		2480	1.233	---	PASS

Test Graphs

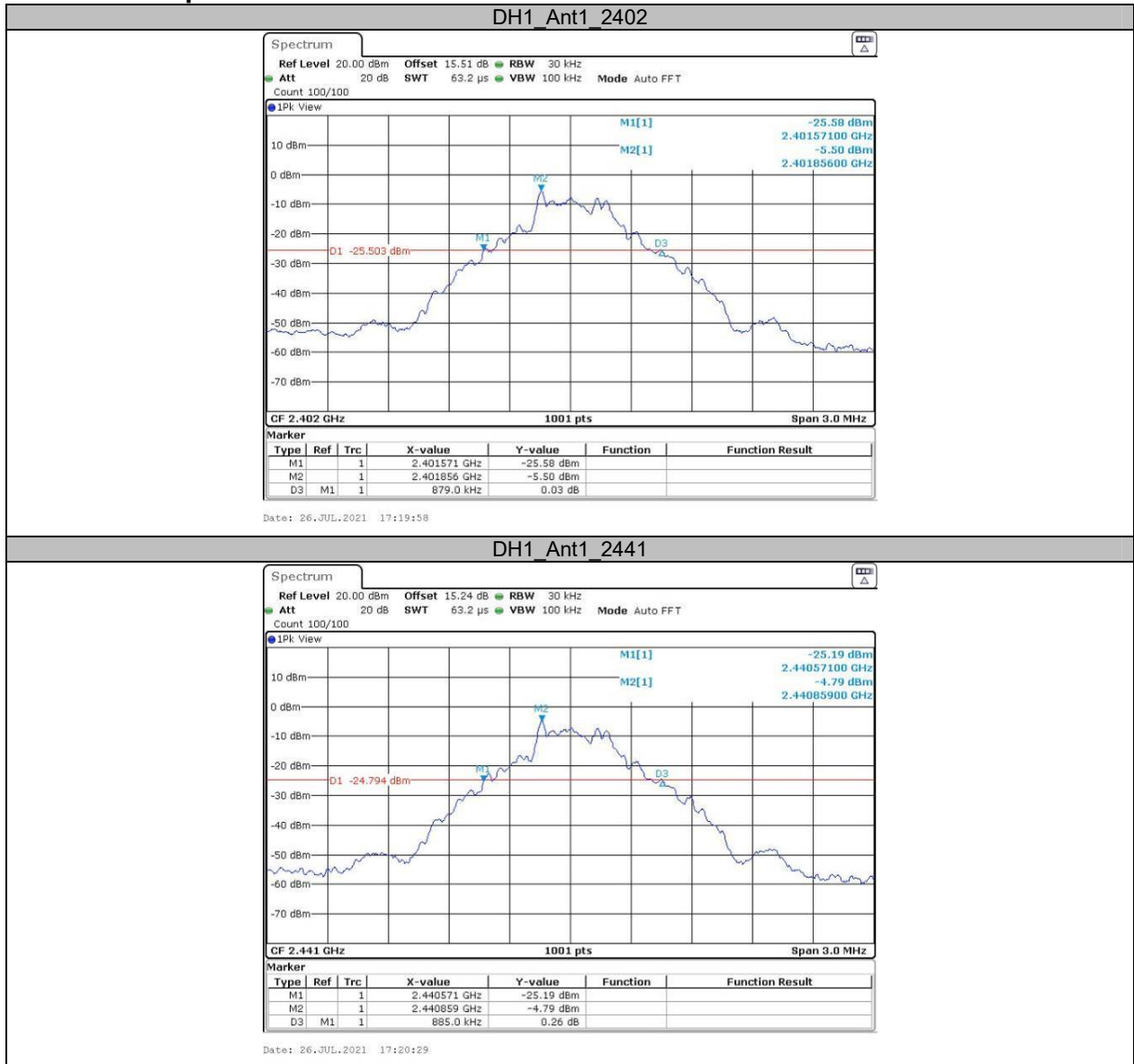

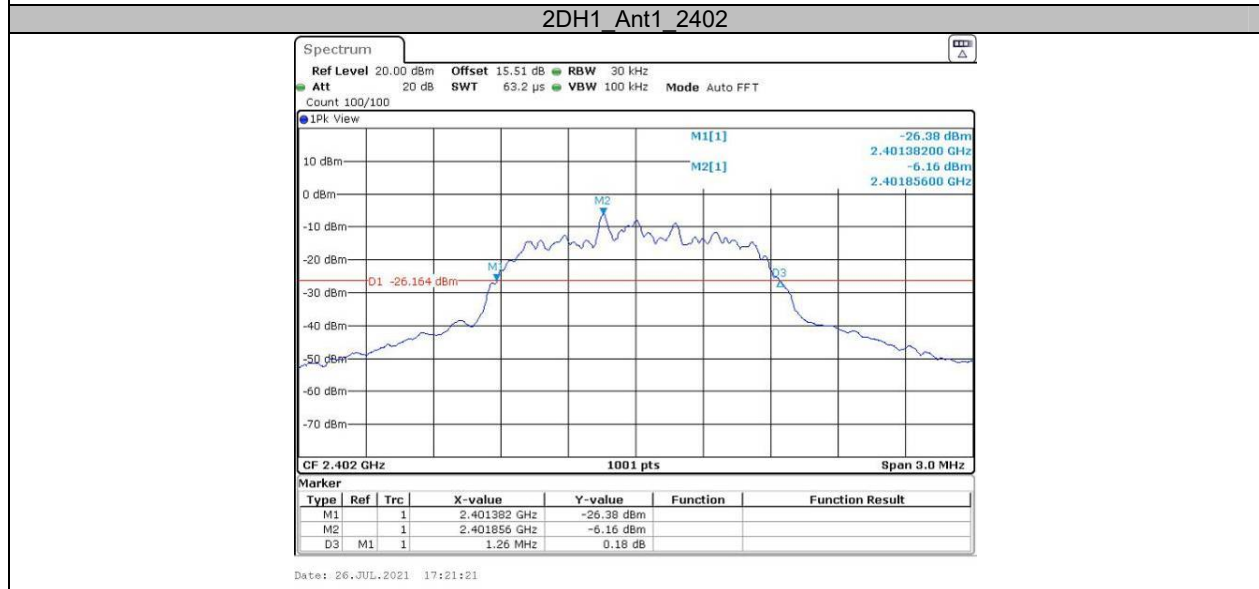
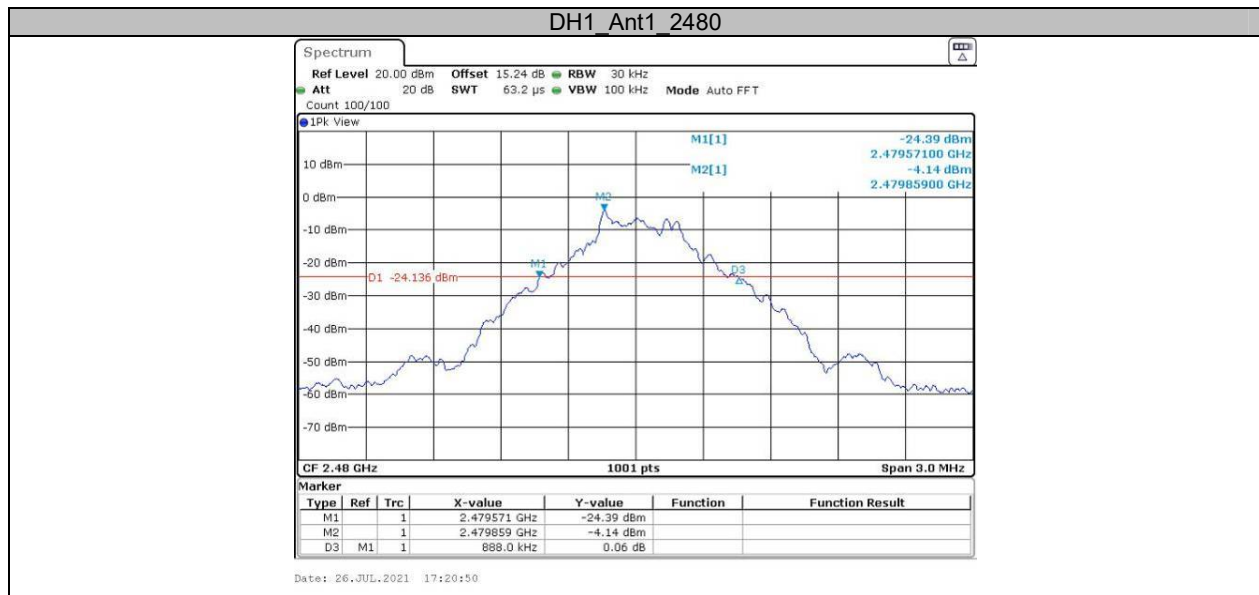

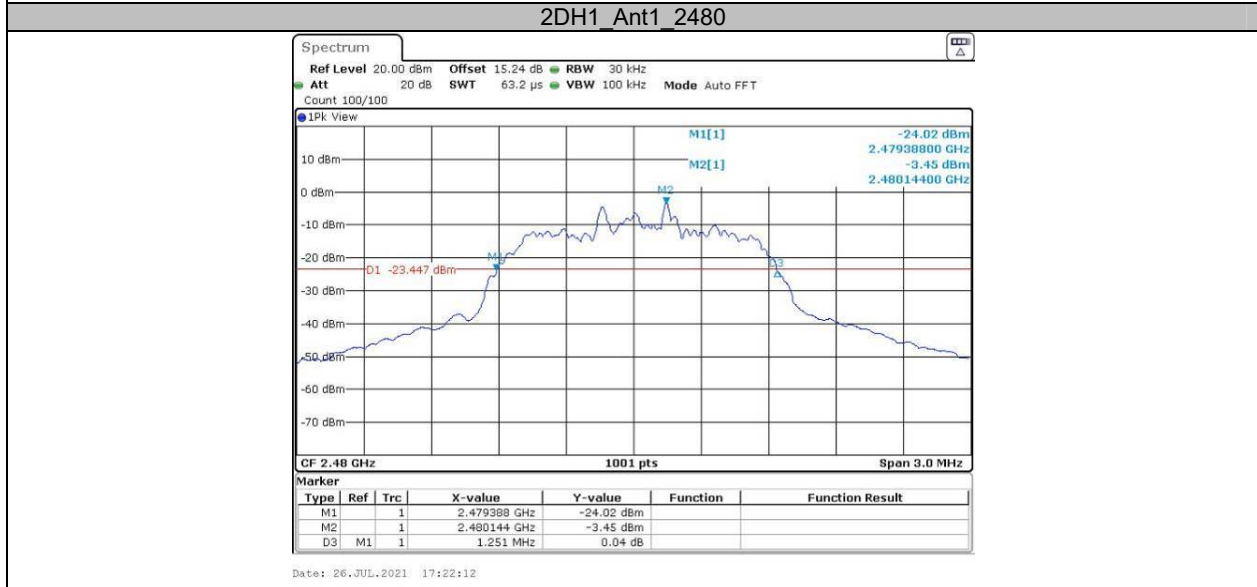
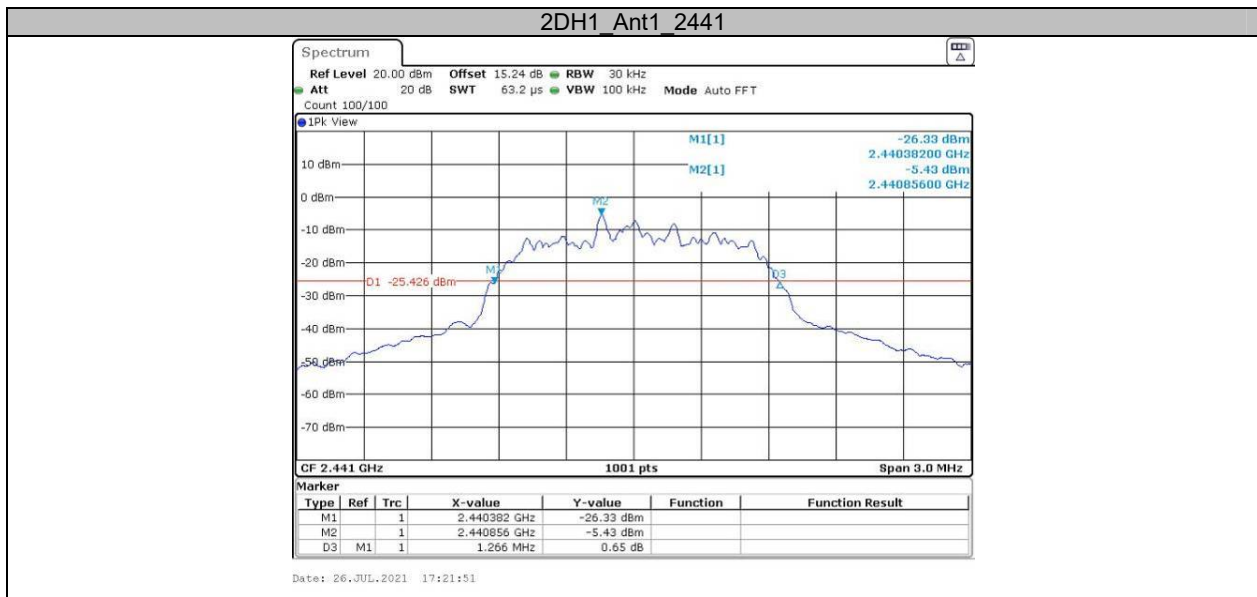

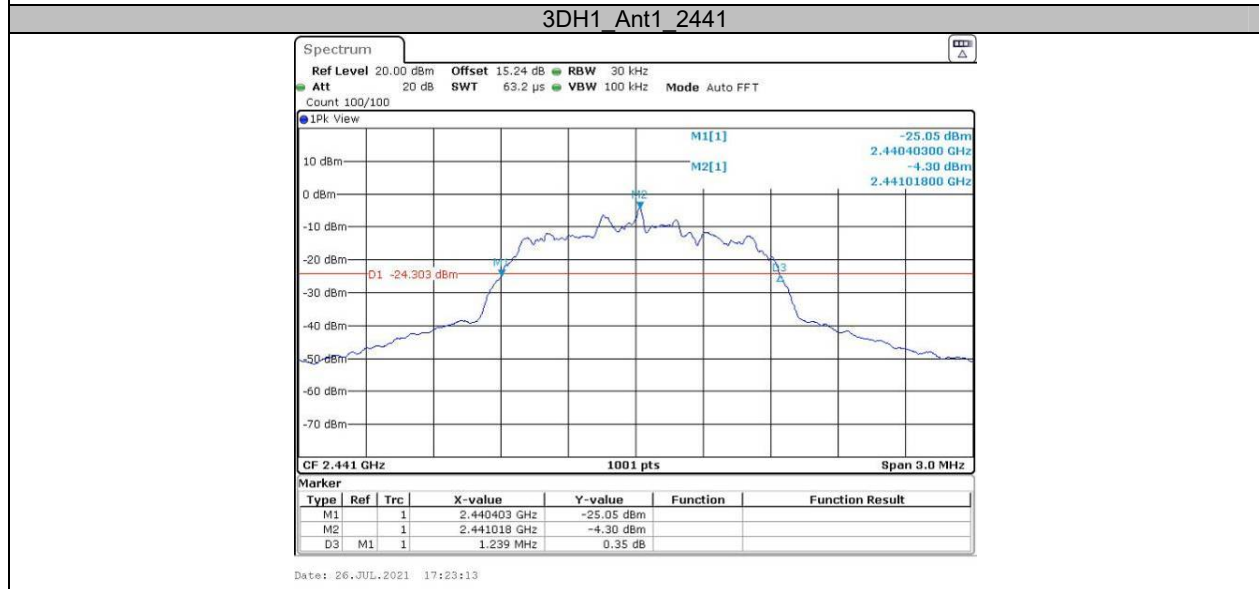
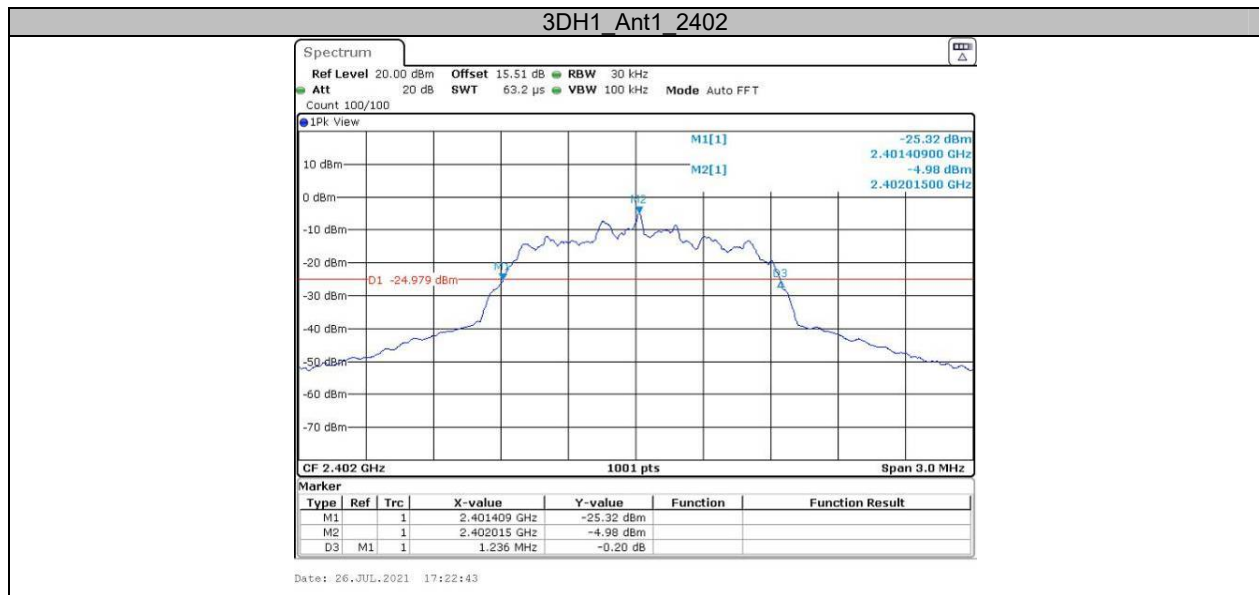

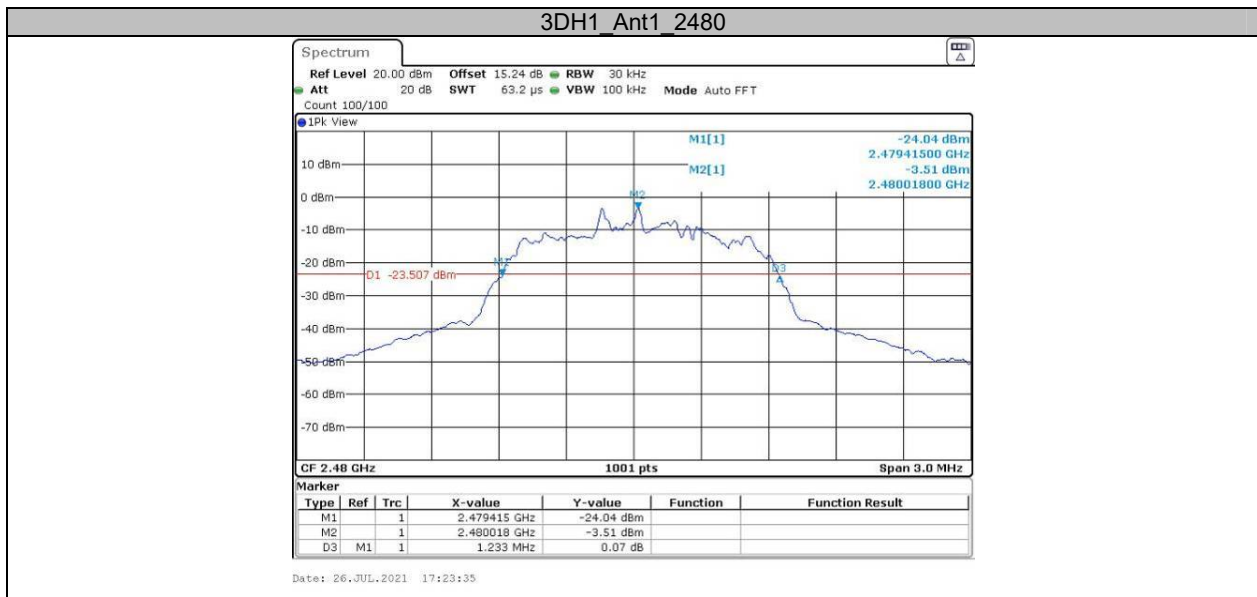

**Appendix B: Occupied Channel Bandwidth
Test Result**

TestMode	Antenna	Channel	OCB [MHz]	Limit[MHz]	Verdict
DH1	Ant1	2402	0.839	---	PASS
		2441	0.872	---	PASS
		2480	0.833	---	PASS
2DH1	Ant1	2402	1.175	---	PASS
		2441	1.160	---	PASS
		2480	1.172	---	PASS
3DH1	Ant1	2402	1.160	---	PASS
		2441	1.163	---	PASS
		2480	1.160	---	PASS

Test Graphs

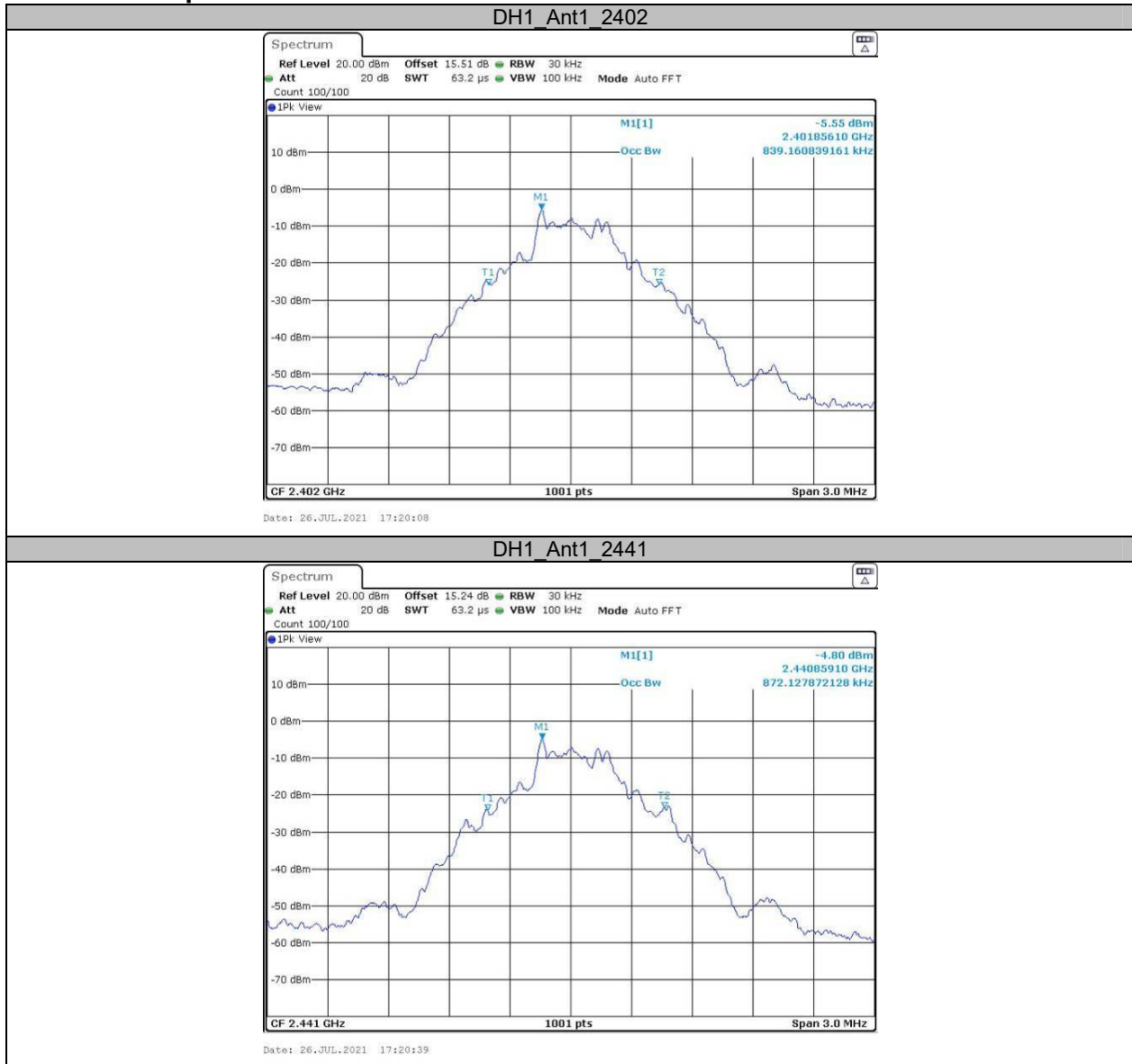

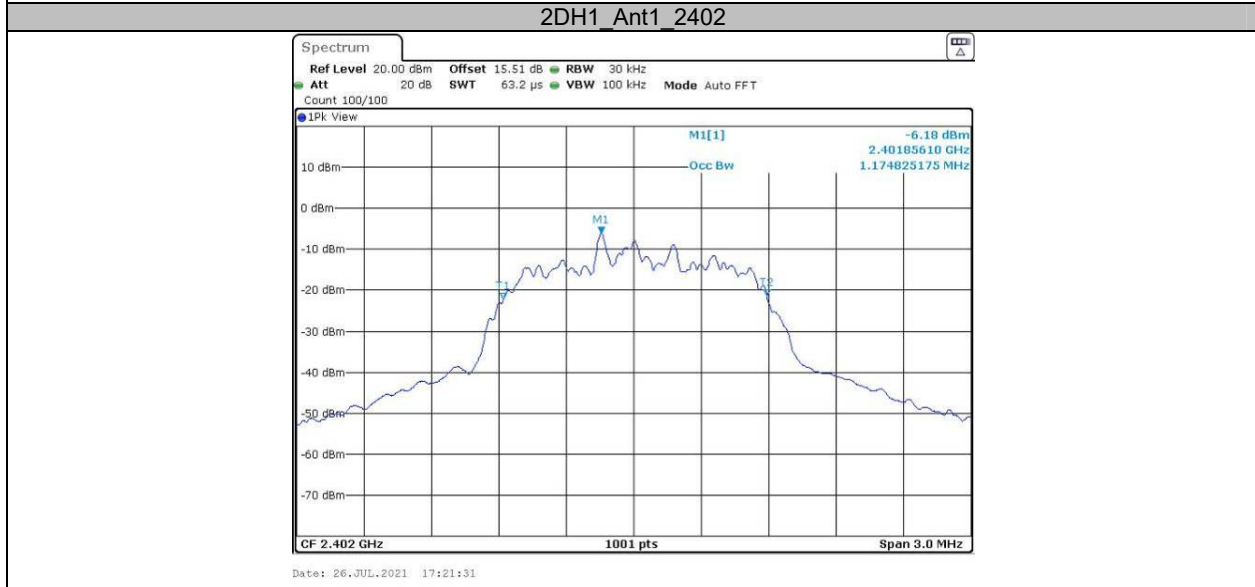
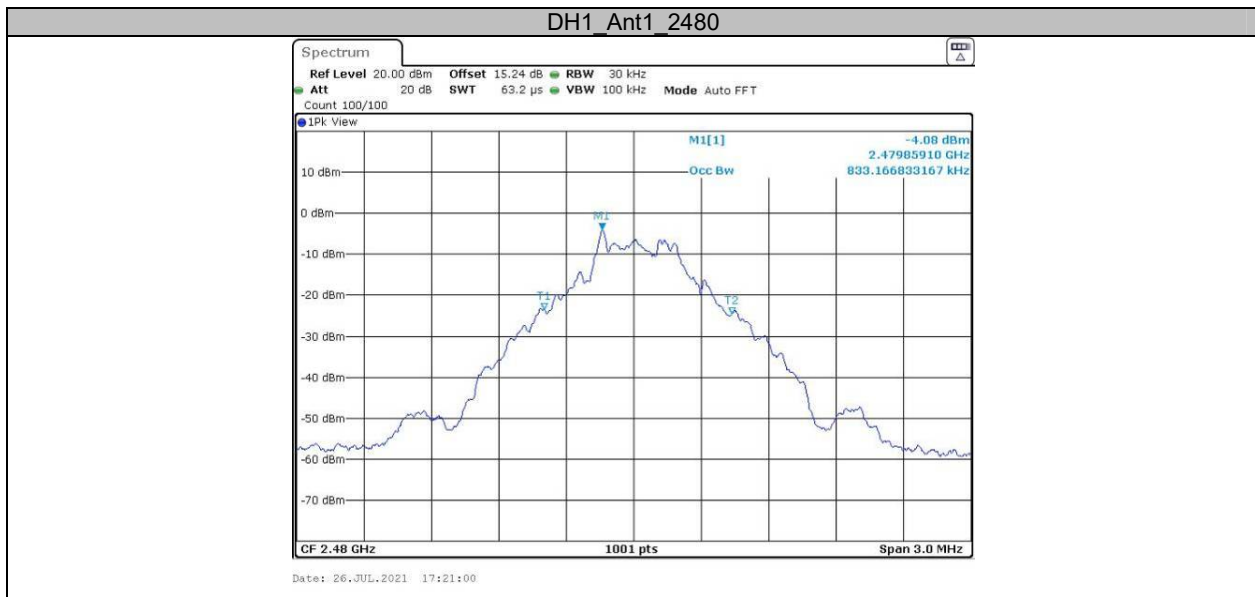



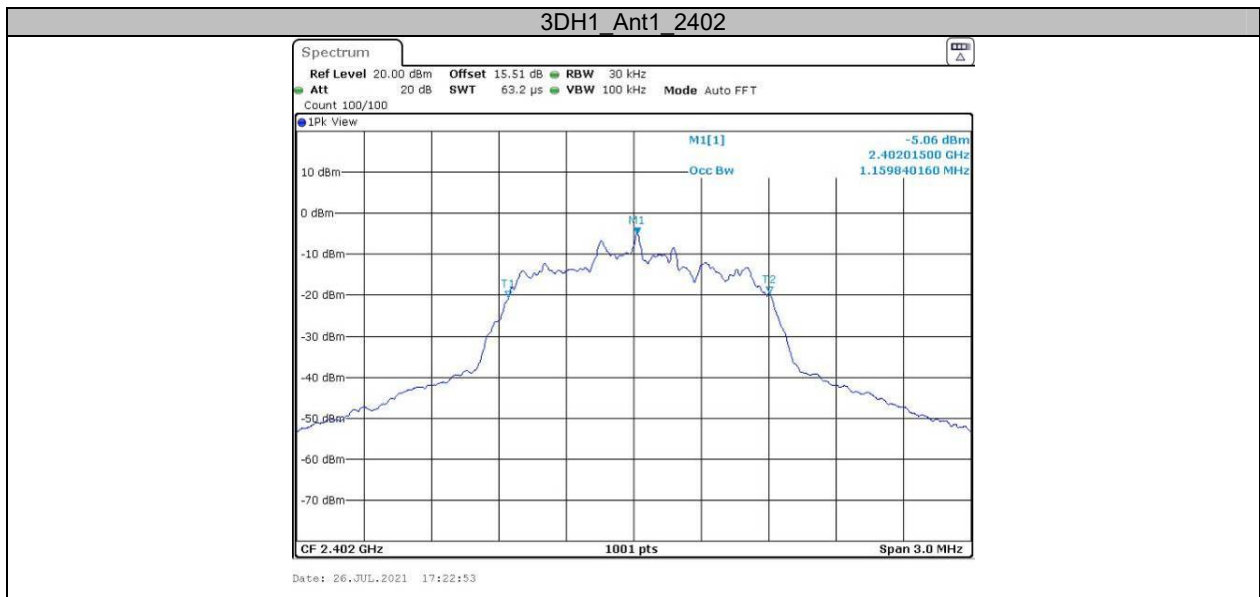

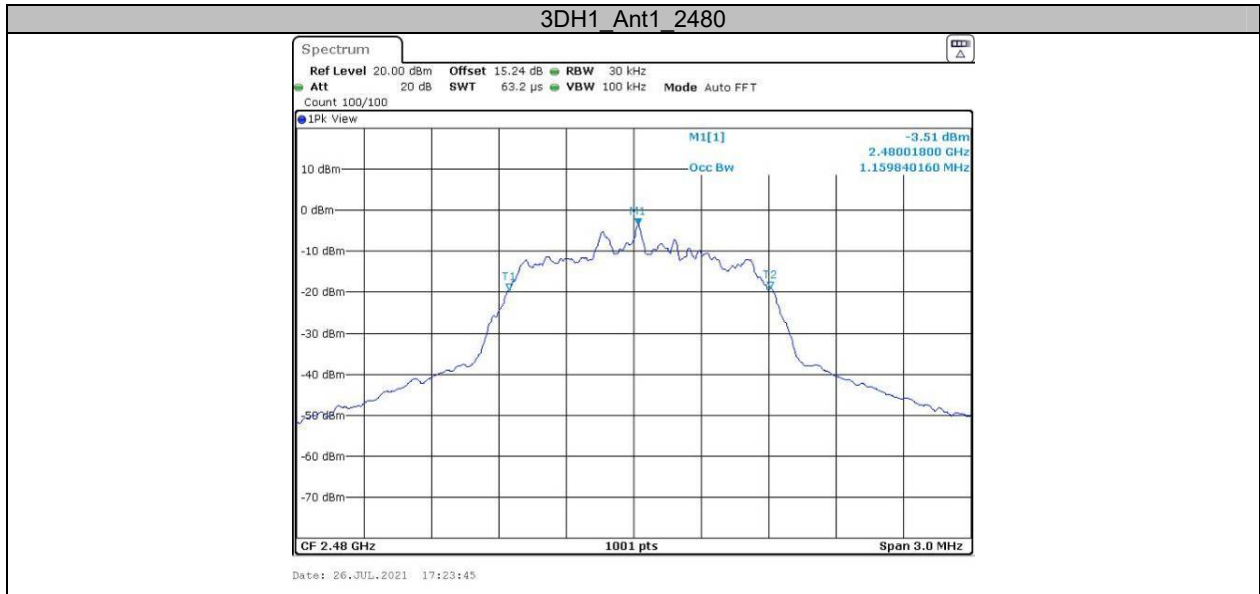

**Appendix C: Maximum conducted Peak output power
Test Result**

TestMode	Antenna	Channel	Result[dBm]	Limit[dBm]	Verdict
DH1	Ant1	2402	-4.68	≤21	PASS
		2441	-4.01	≤21	PASS
		2480	-3.29	≤21	PASS
2DH1	Ant1	2402	-1.90	≤21	PASS
		2441	-1.26	≤21	PASS
		2480	-0.44	≤21	PASS
3DH1	Ant1	2402	-1.33	≤21	PASS
		2441	-0.62	≤21	PASS
		2480	0.17	≤21	PASS

Note: the antenna gain is 0dBi, the maximum EIRP=0.17dBm+0dBi=0.17dBm<36dBm, so it's compliance with ISEDC EIRP limit.

Test Graphs

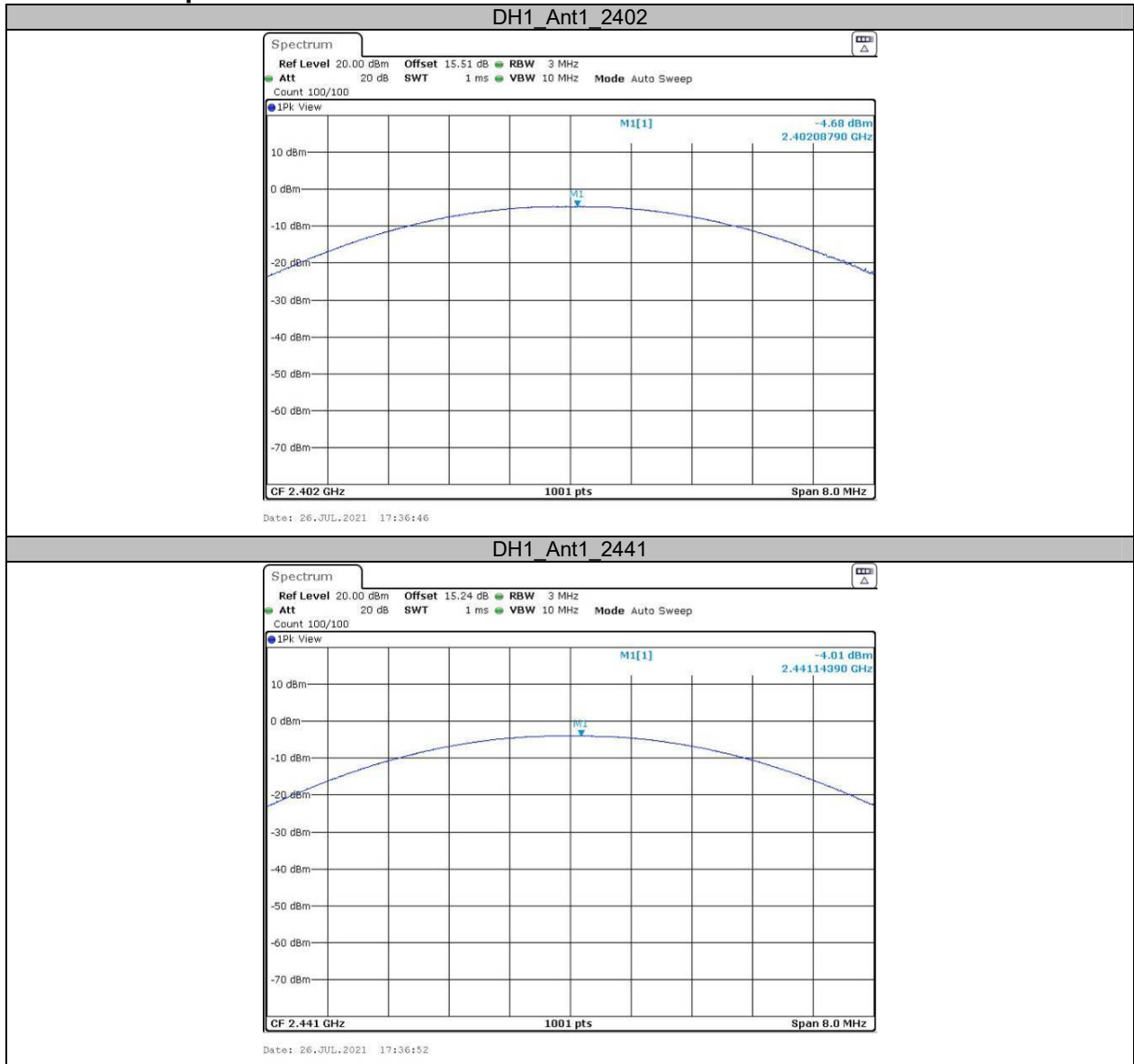

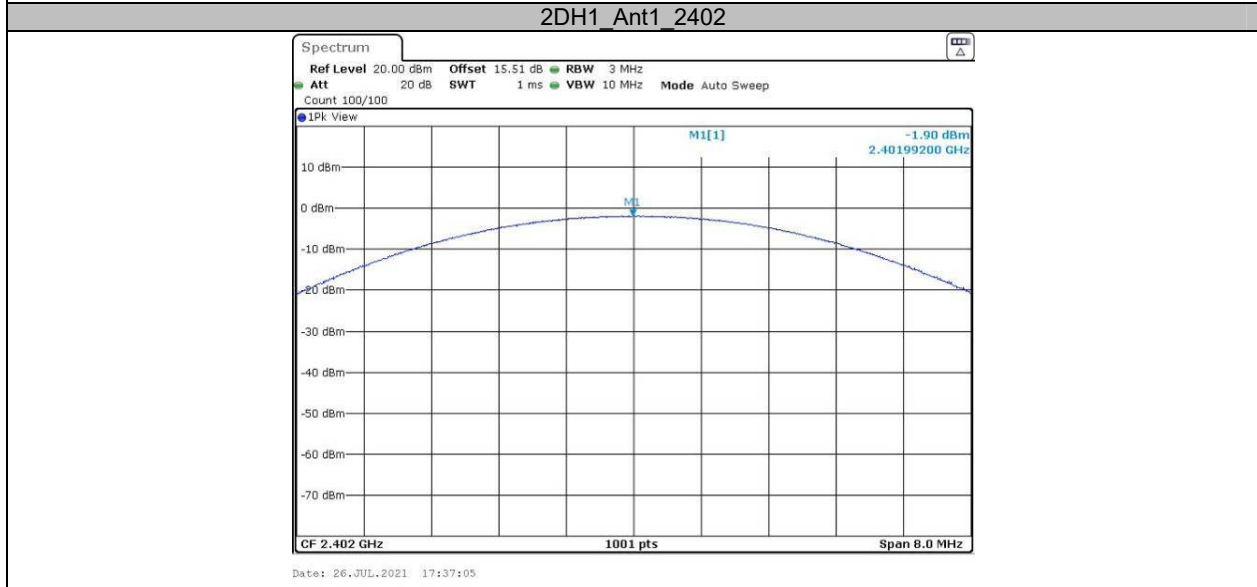
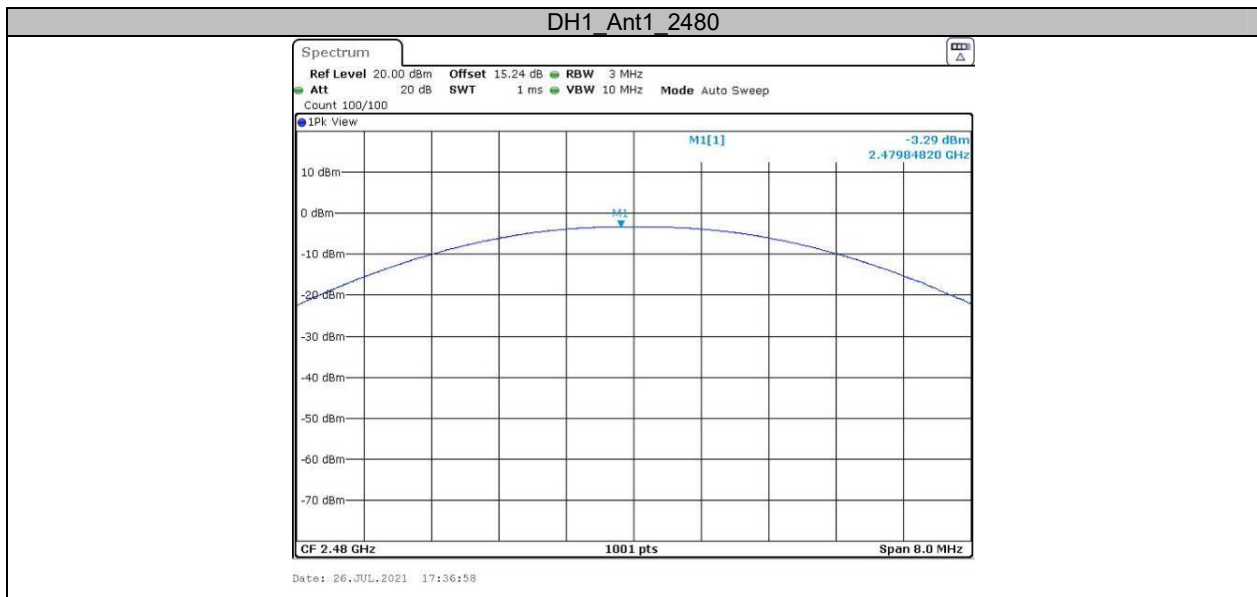

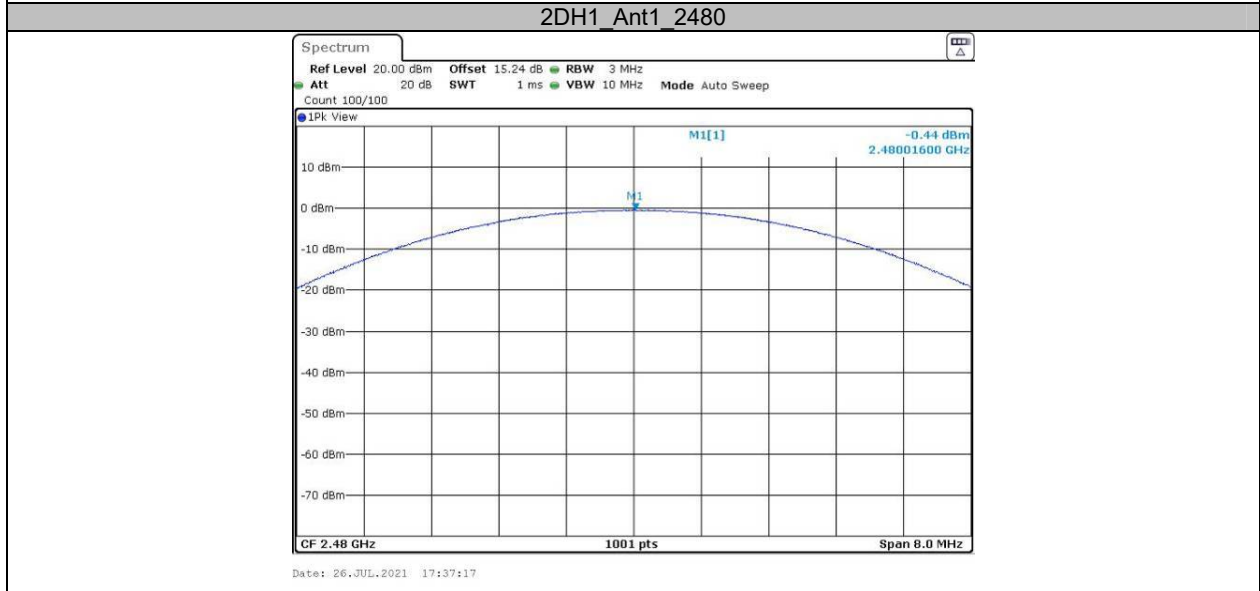
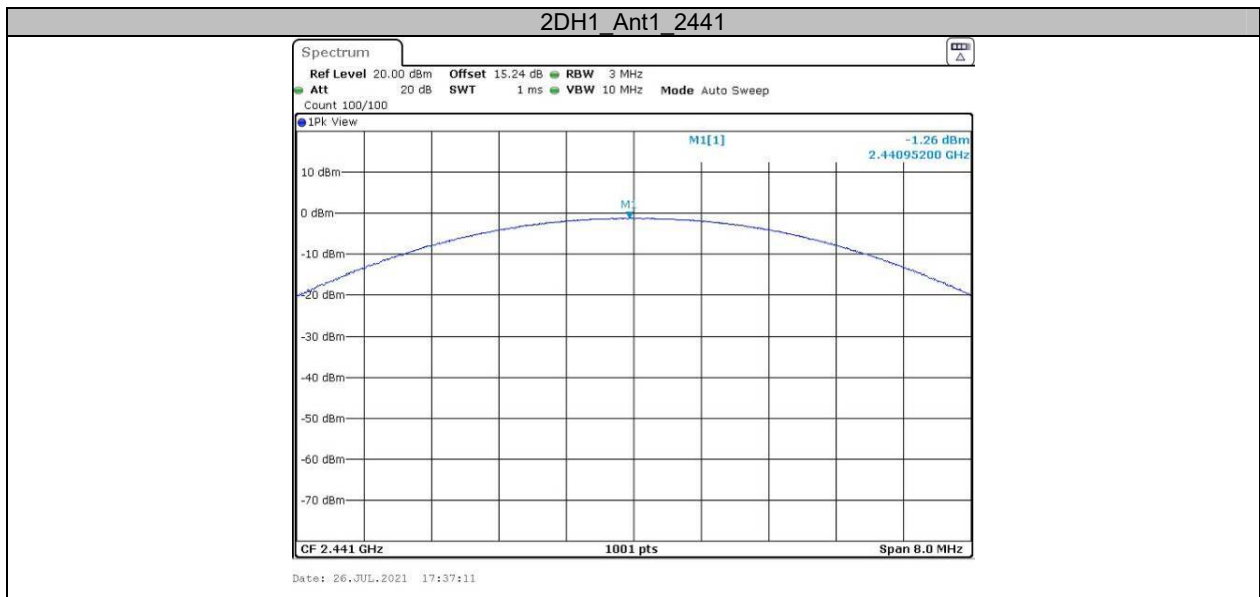

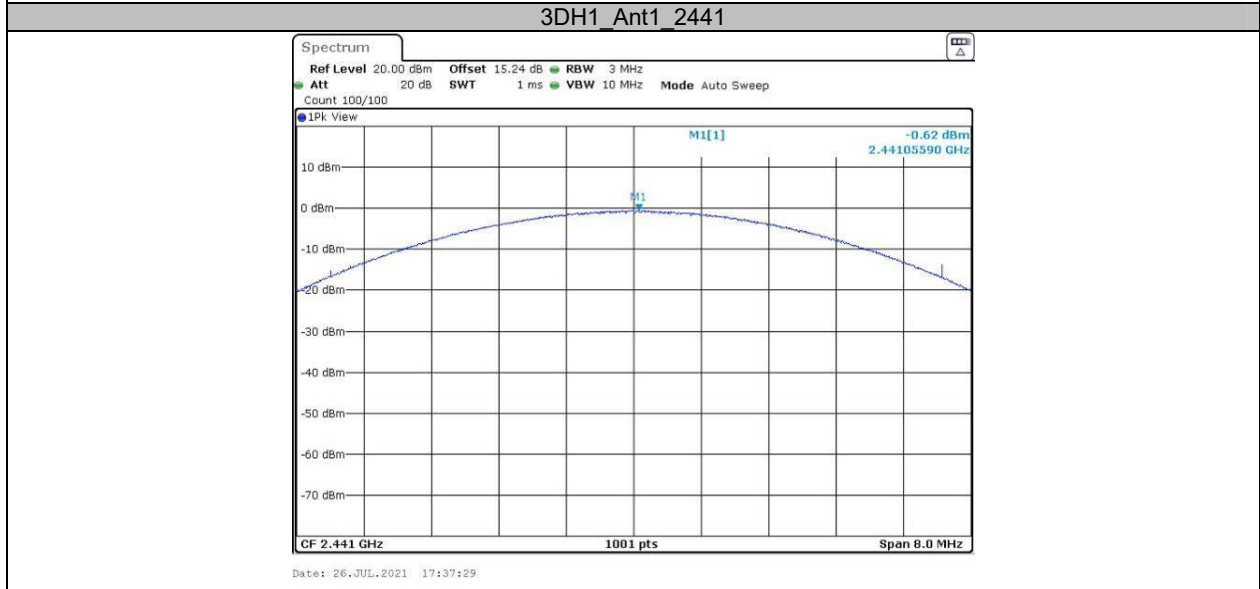
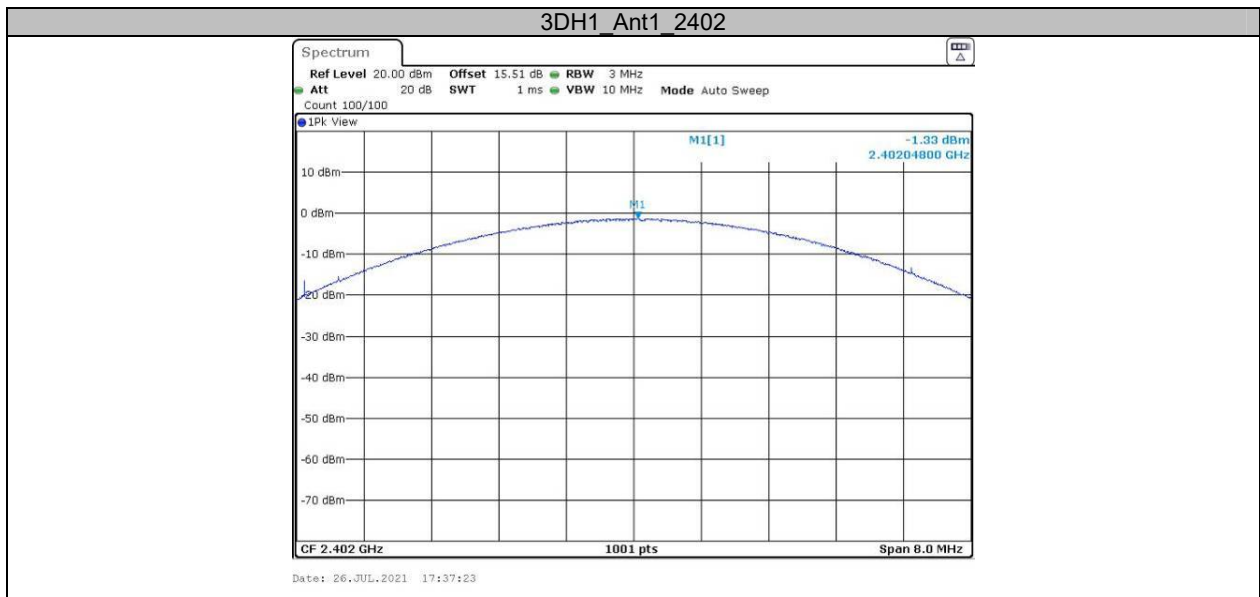

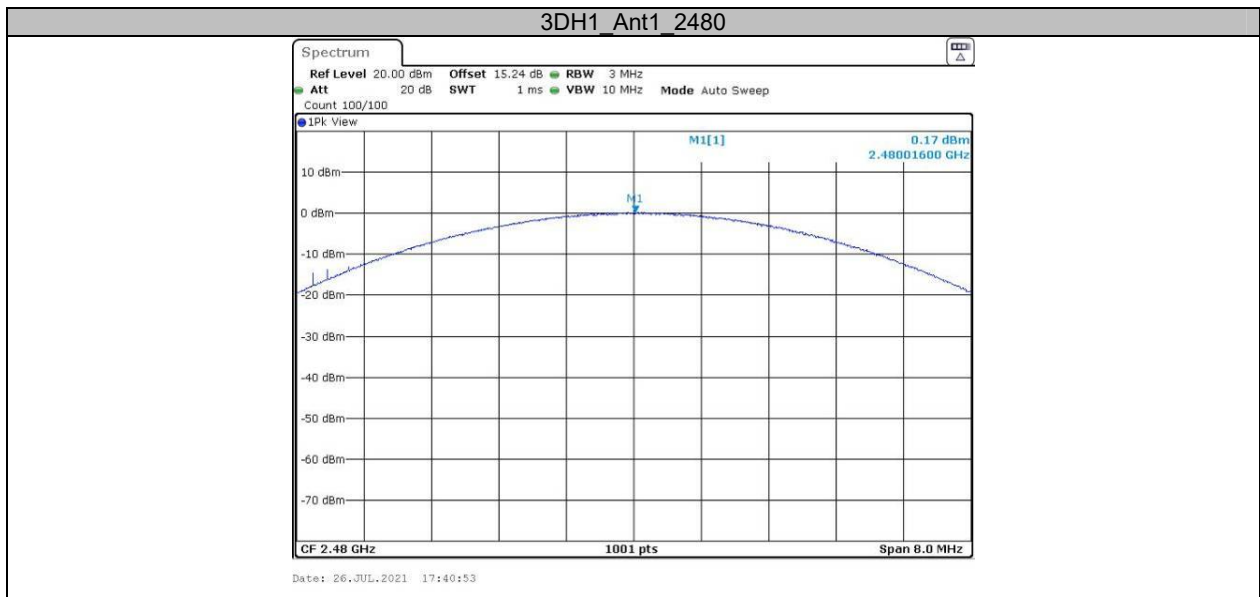

**Appendix D: Carrier frequency separation
Test Result**

TestMode	Antenna	Channel	Result[MHz]	Limit[MHz]	Verdict
DH1	Ant1	Hop	1	≥ 0.590	PASS
2DH1	Ant1	Hop	1	≥ 0.844	PASS
3DH1	Ant1	Hop	1	≥ 0.826	PASS

Test Graphs

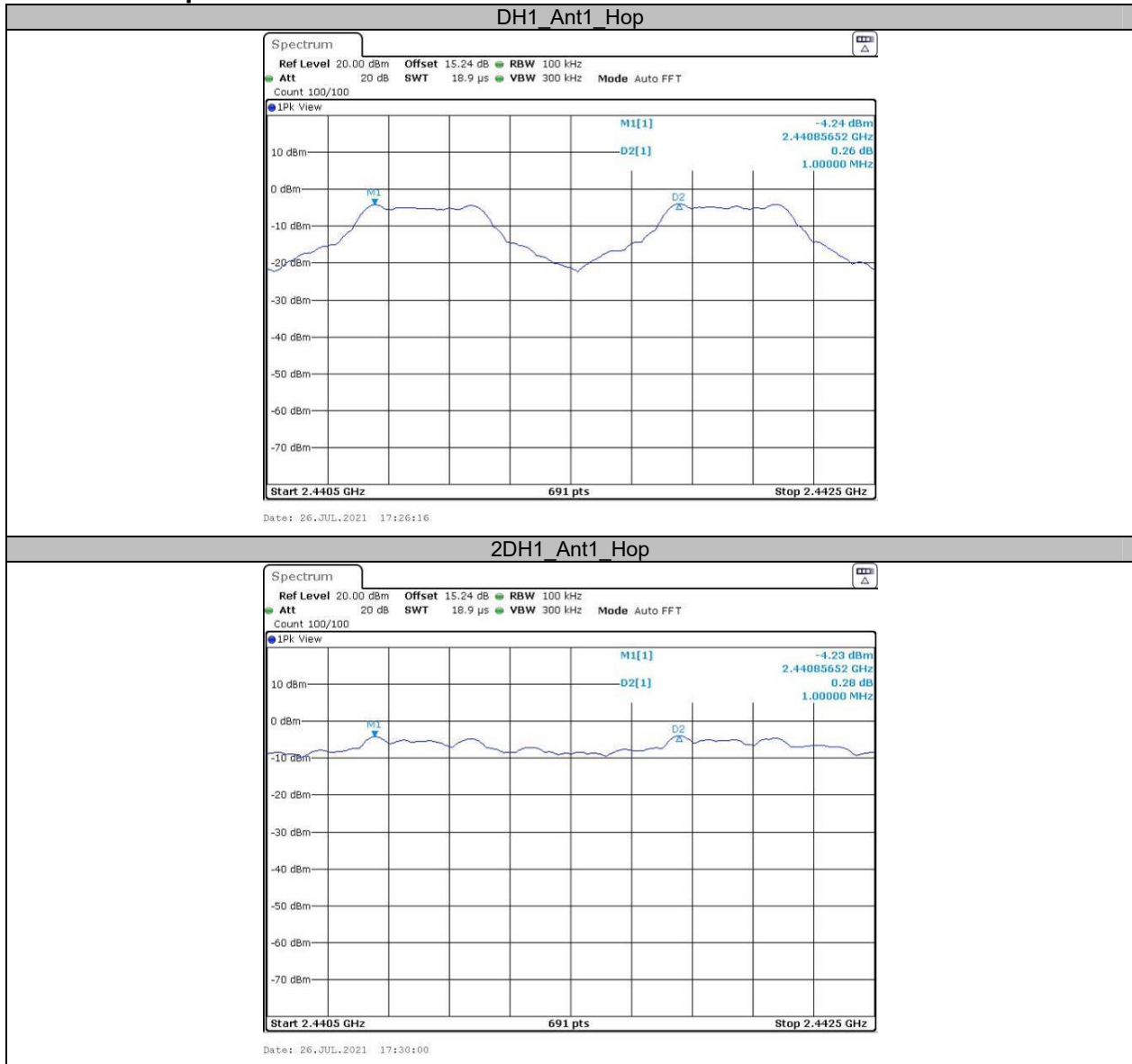

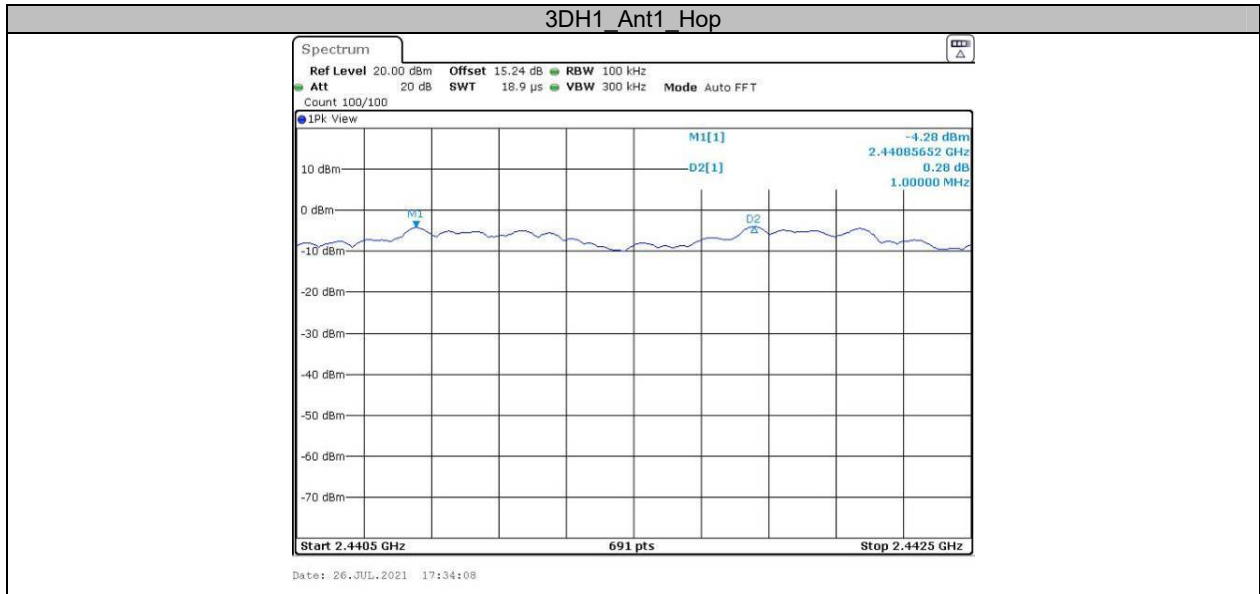

Appendix E: Time of occupancy Test Result

TestMode	Antenna	Channel	BurstWidth [ms]	TotalHops [Num]	Result[s]	Limit[s]	Verdict
DH1	Ant1	Hop	0.40	300	0.119	≤0.4	PASS
DH3	Ant1	Hop	1.65	80	0.132	≤0.4	PASS
DH5	Ant1	Hop	2.89	90	0.26	≤0.4	PASS
2DH1	Ant1	Hop	0.40	300	0.119	≤0.4	PASS
2DH3	Ant1	Hop	1.64	130	0.213	≤0.4	PASS
2DH5	Ant1	Hop	2.88	90	0.259	≤0.4	PASS
3DH1	Ant1	Hop	0.40	300	0.119	≤0.4	PASS
3DH3	Ant1	Hop	1.64	140	0.229	≤0.4	PASS
3DH5	Ant1	Hop	2.88	100	0.288	≤0.4	PASS

Note 1: A period time= $0.4 \times 79 = 31.6$ (S), Result=BurstWidth*Totalhops

Note 2: Totalhops=Hopping Number in $3.16s \times 10$

Note 3: Hopping Number in $3.16s =$ Total of highest signals in $3.16s$ (Second high signals were other channel)

Test Graphs

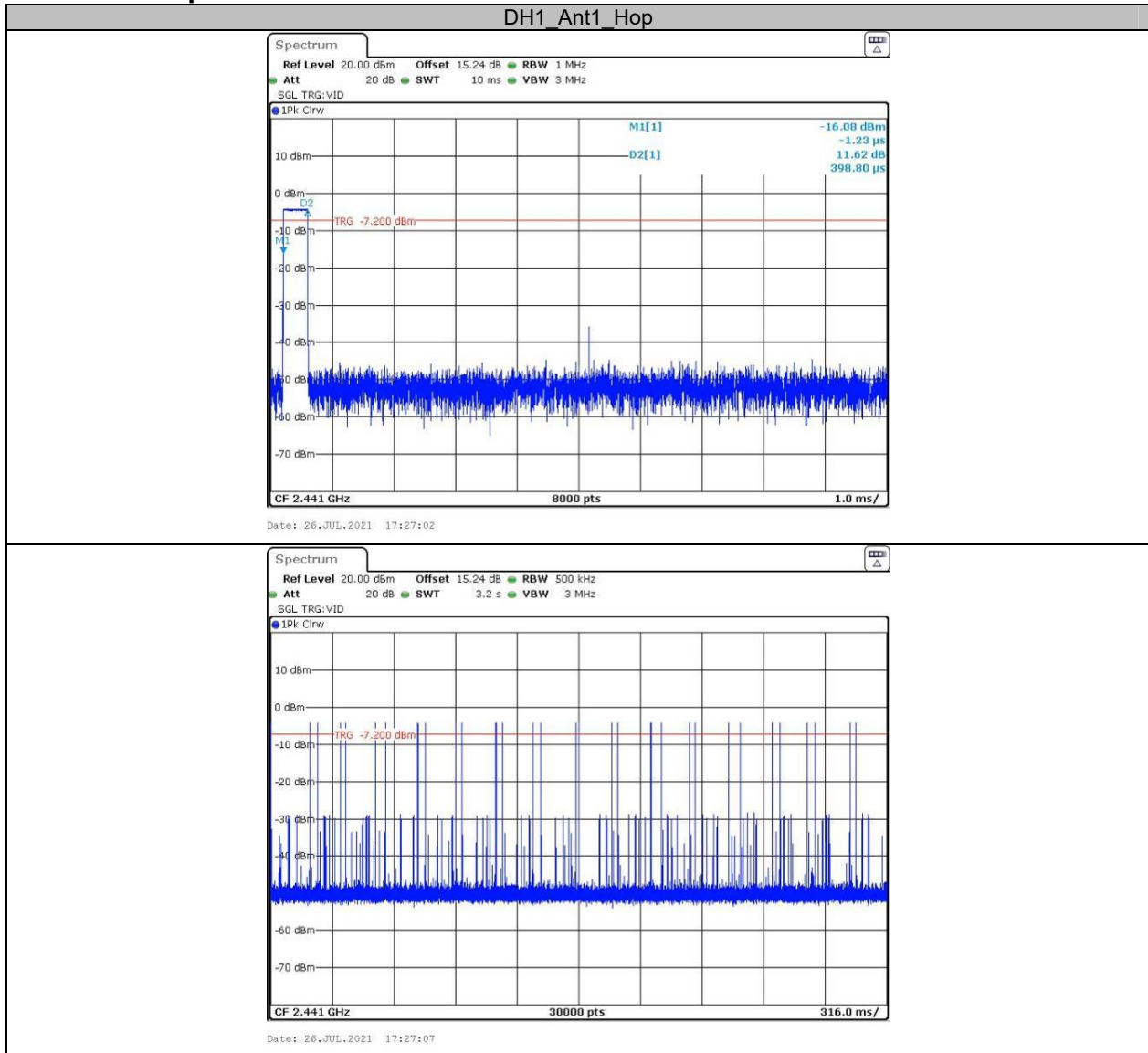

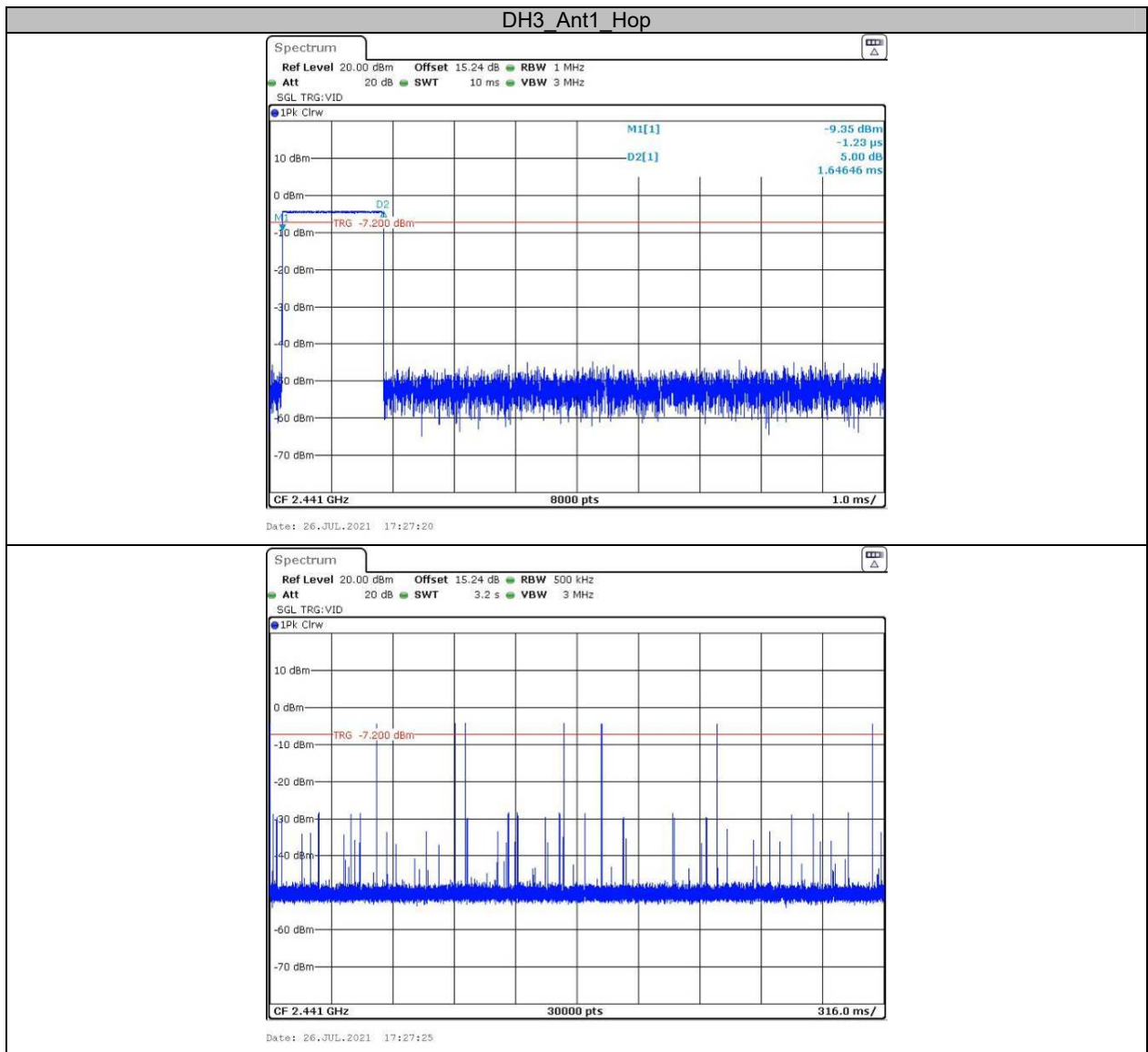

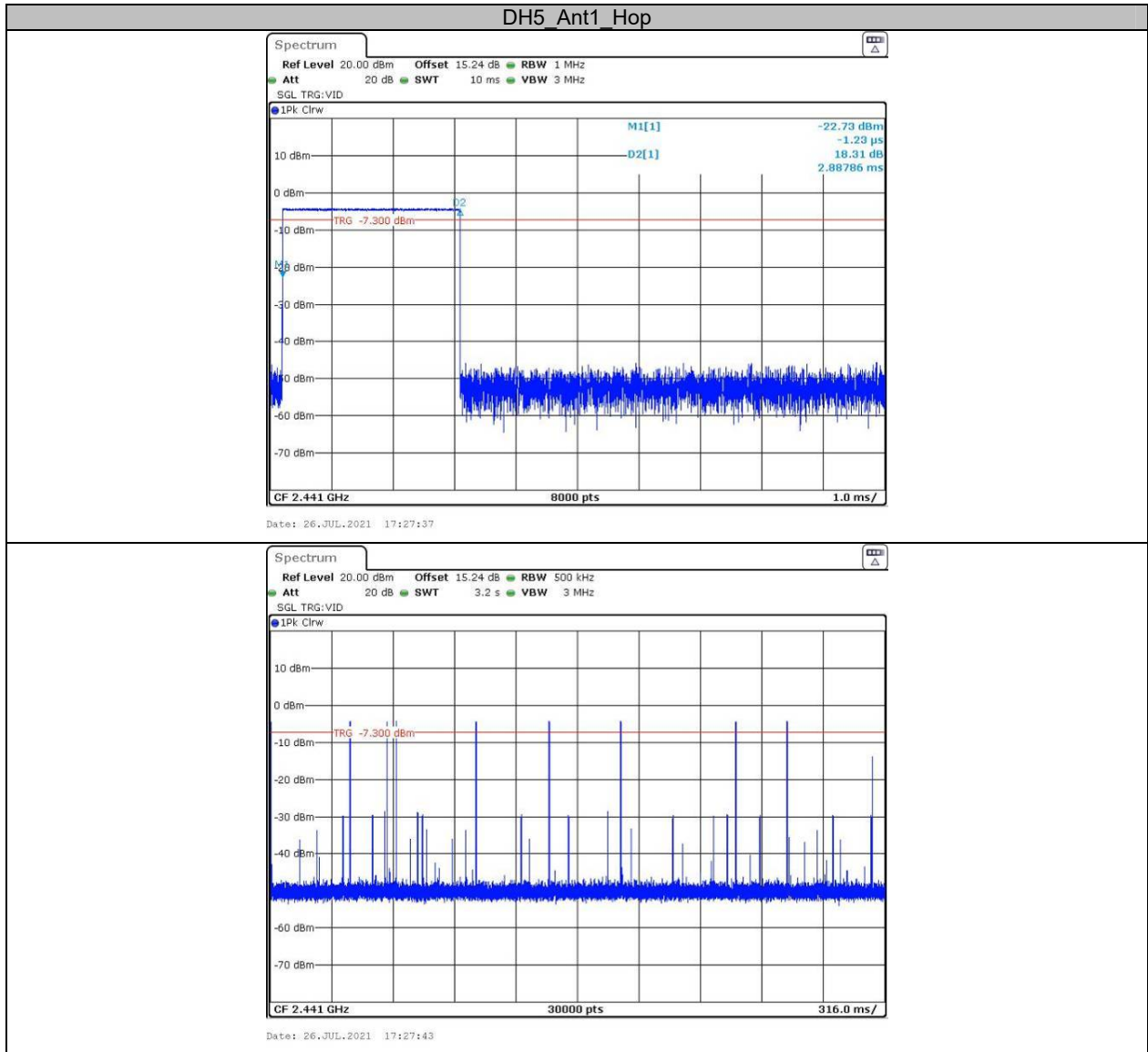

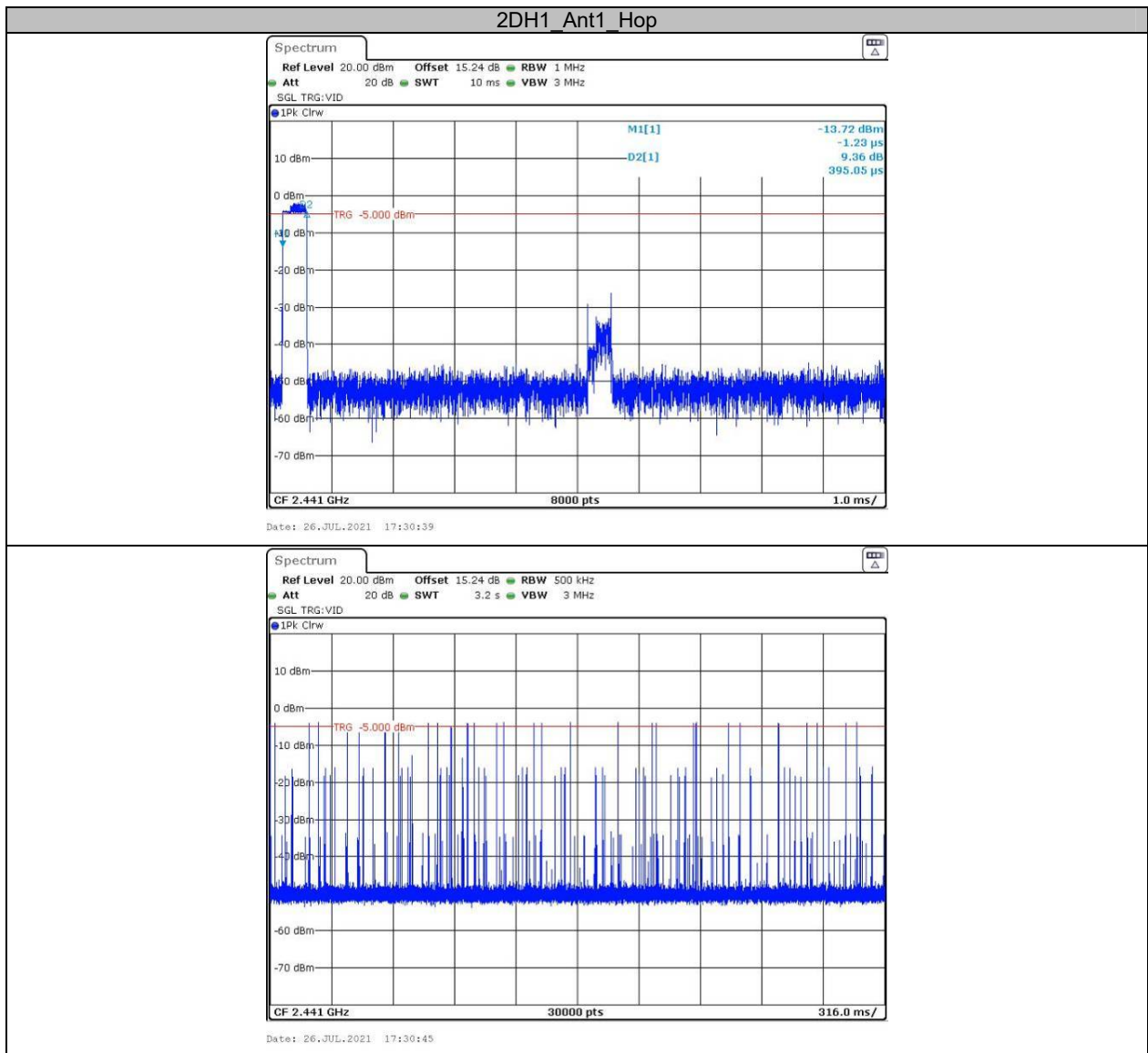

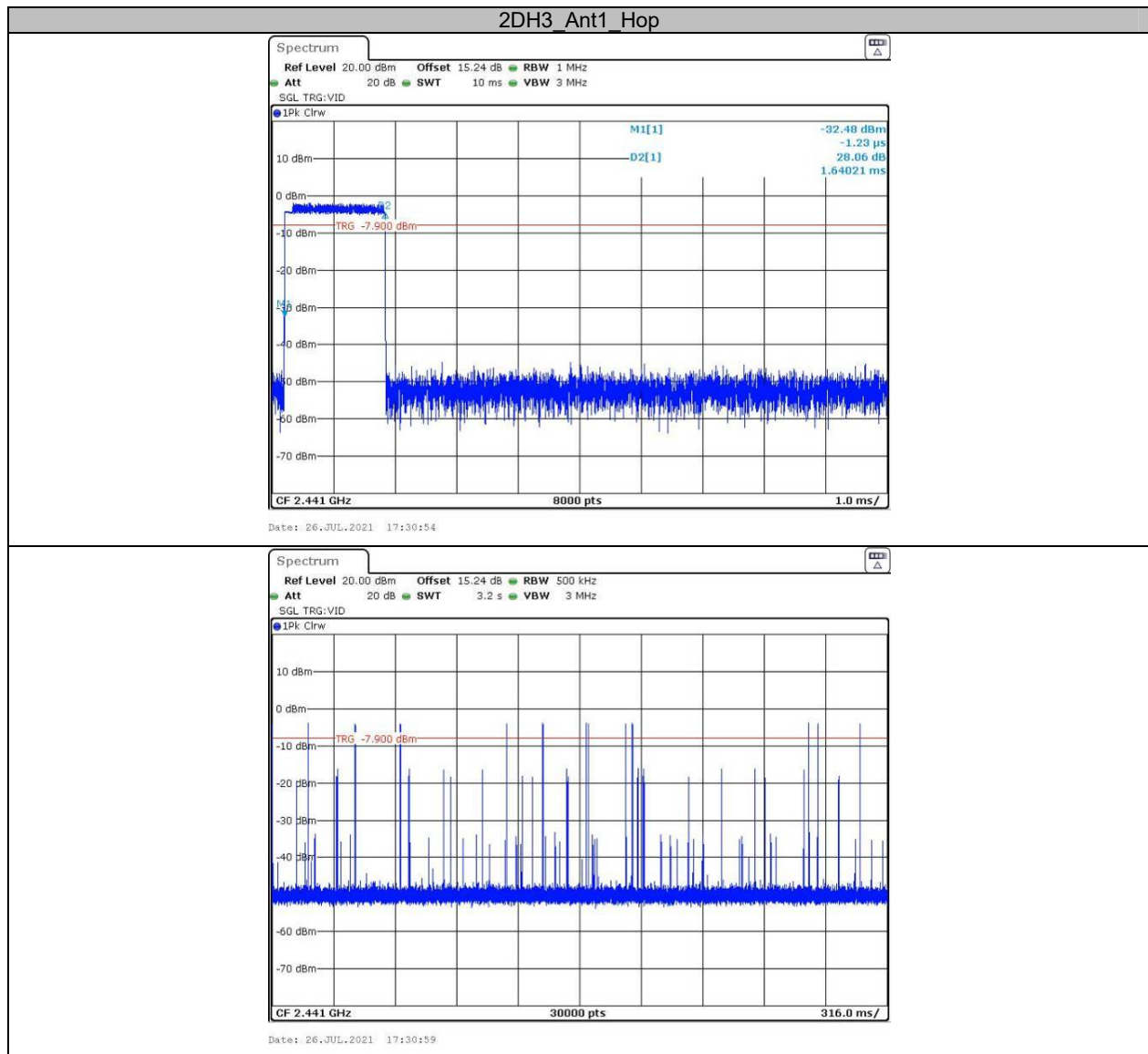

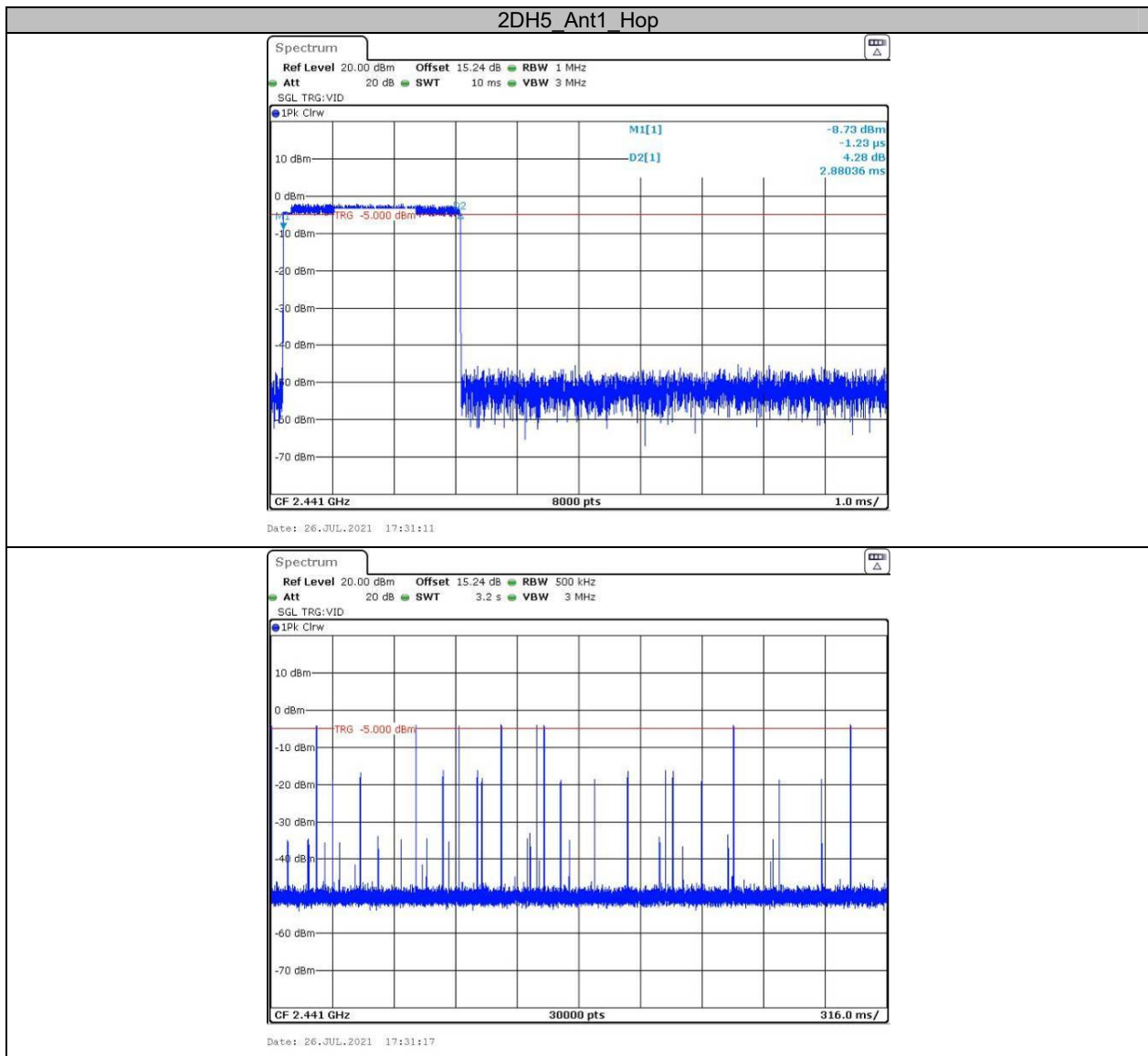

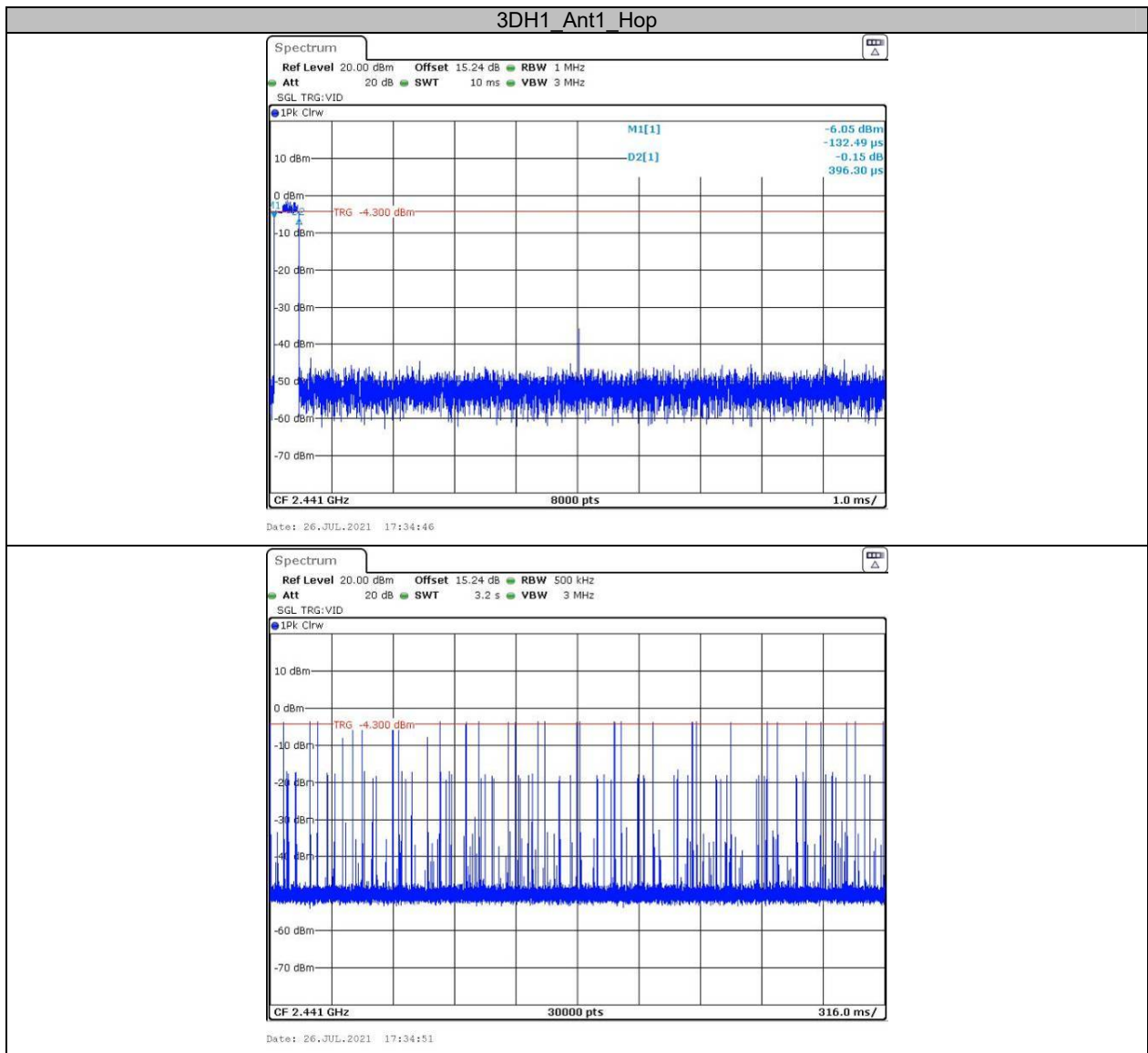

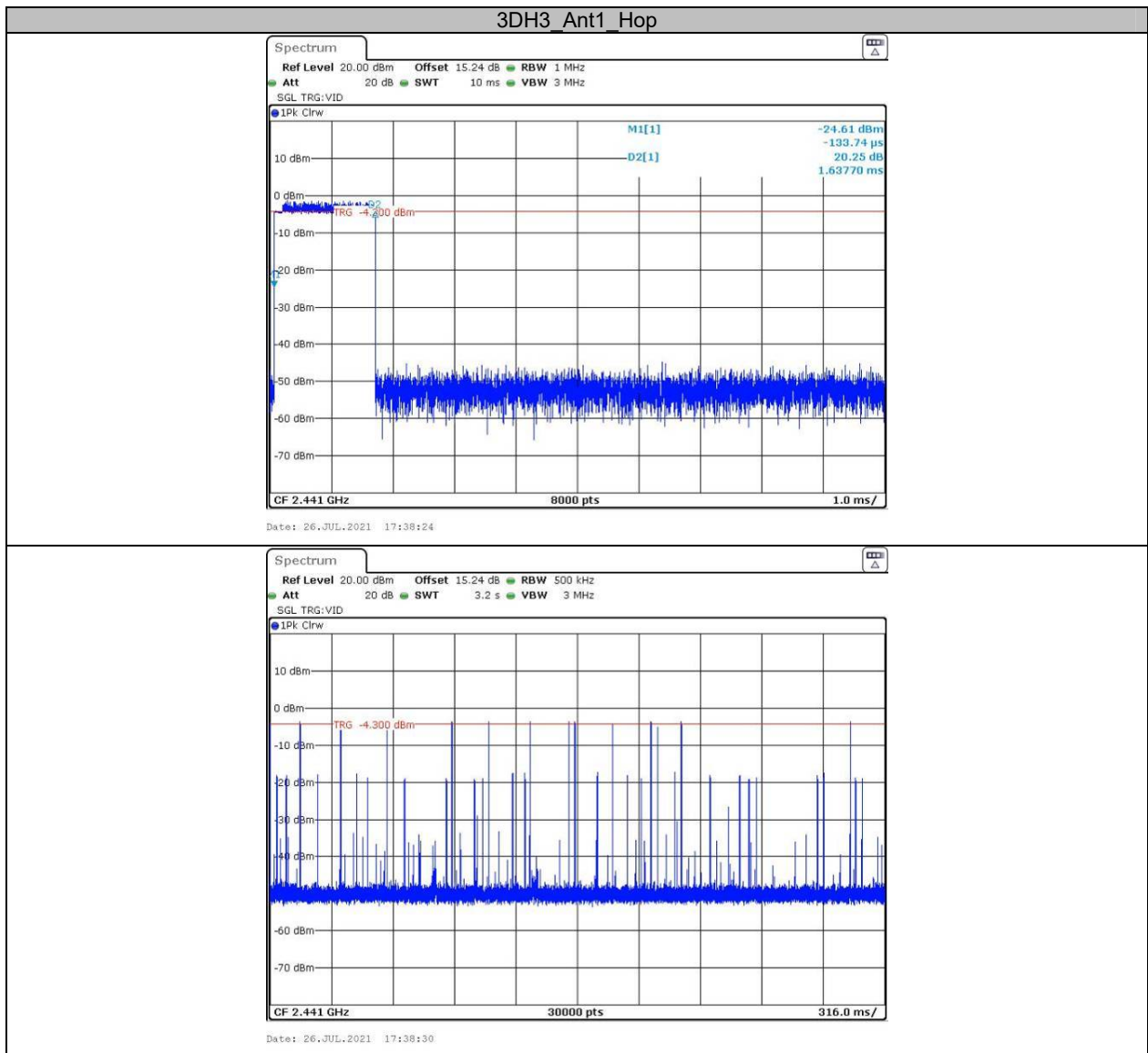

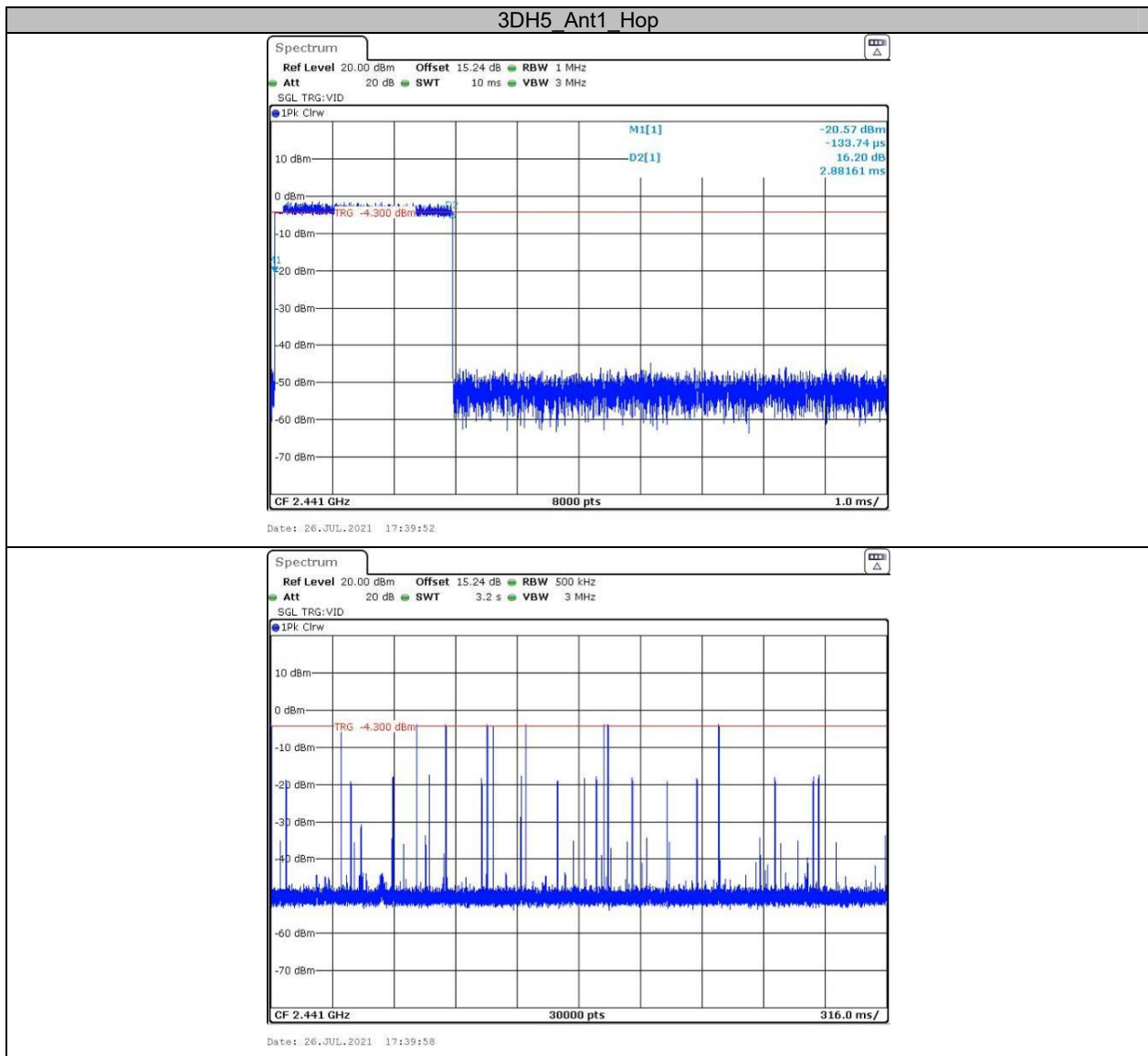

**Appendix F: Number of hopping channels
Test Result**

TestMode	Antenna	Channel	Result[Num]	Limit[Num]	Verdict
DH1	Ant1	Hop	79	≥15	PASS
2DH1	Ant1	Hop	79	≥15	PASS
3DH1	Ant1	Hop	79	≥15	PASS

Test Graphs

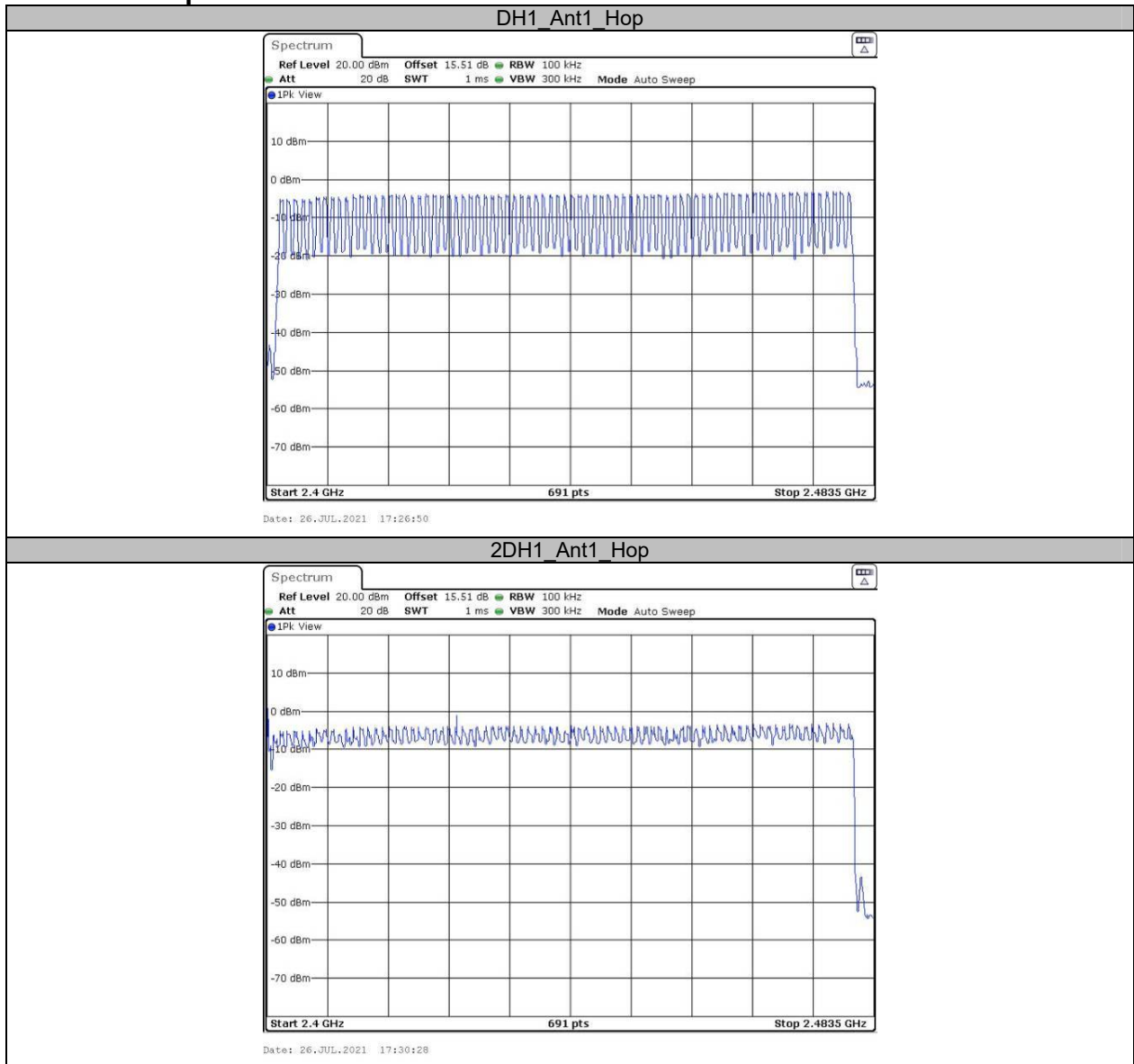

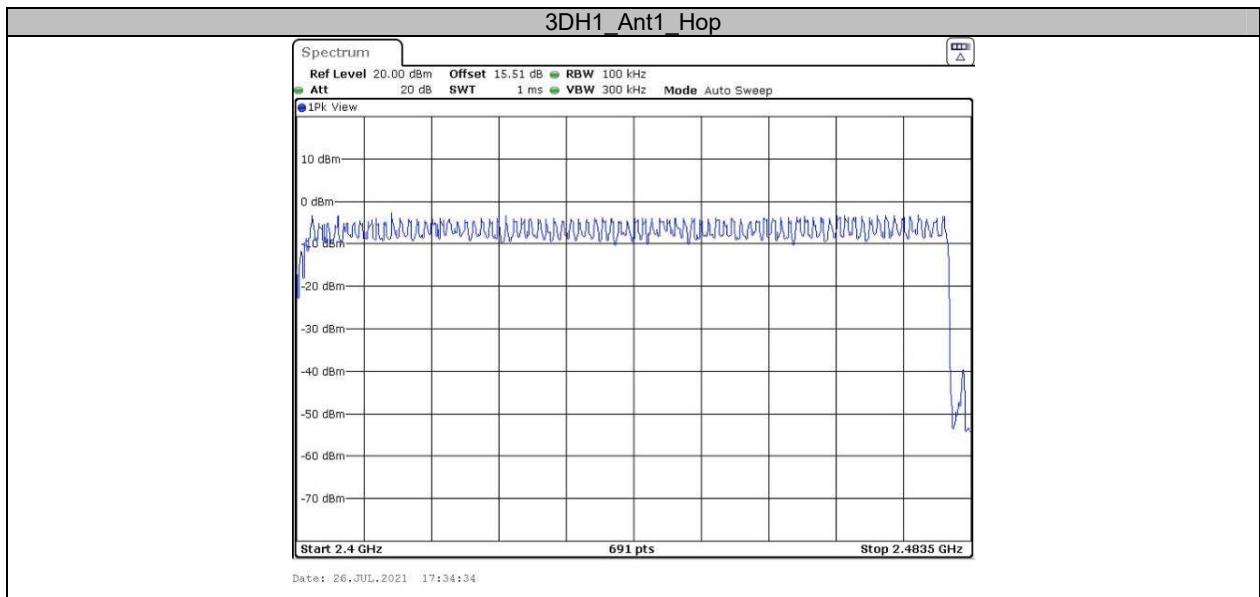

Appendix G: Band edge measurements Test Graphs



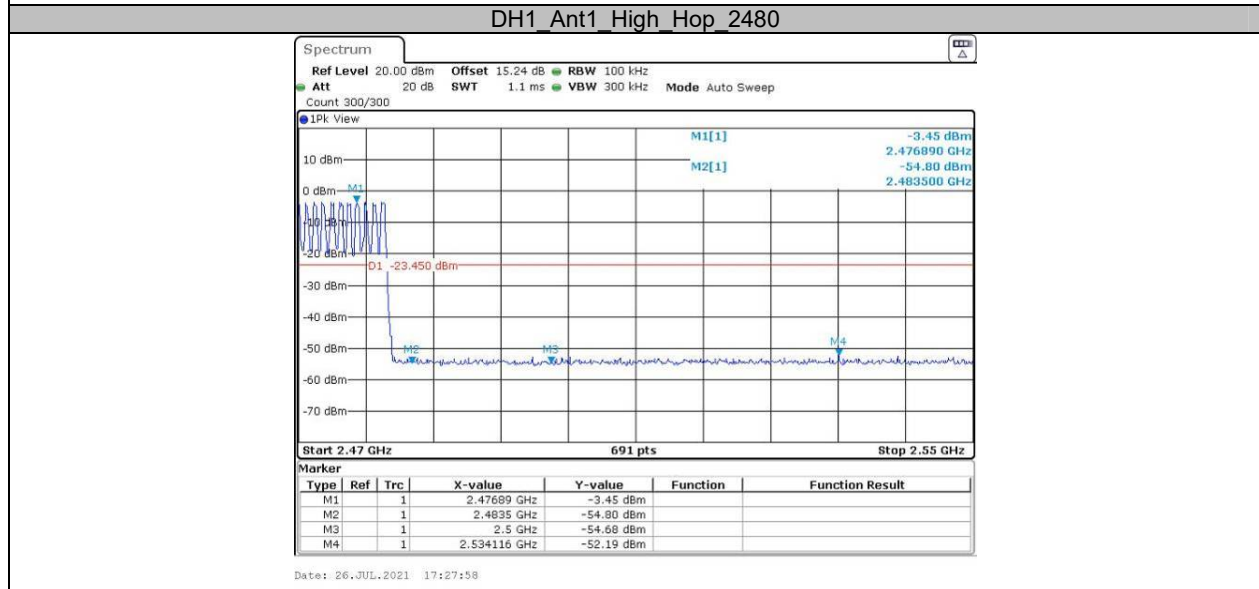
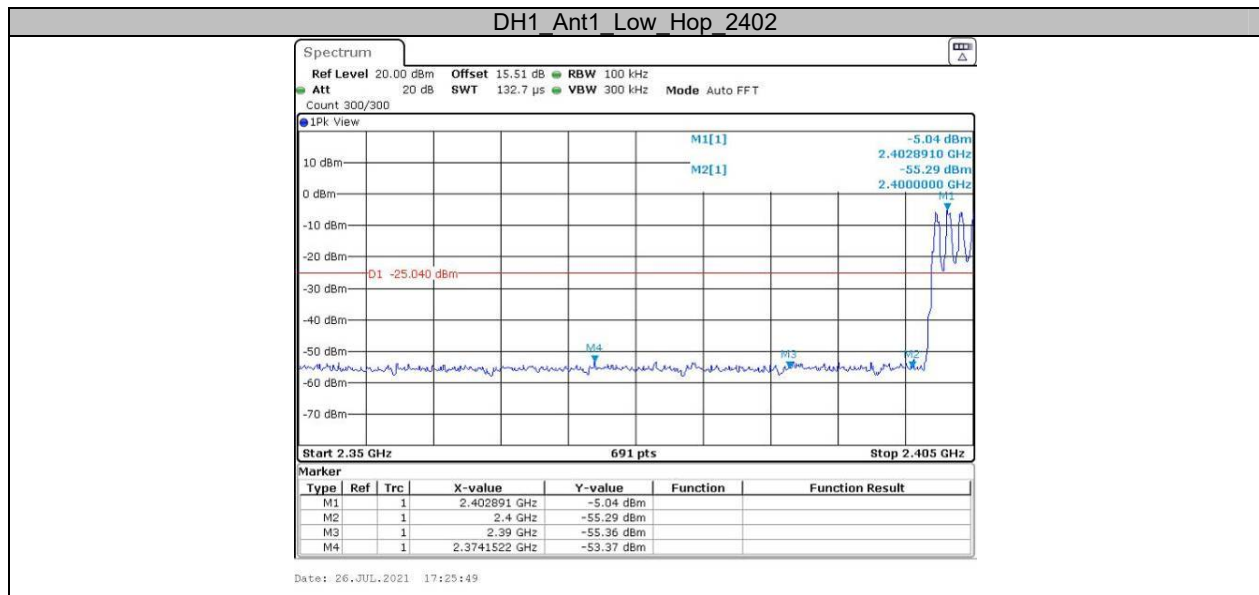

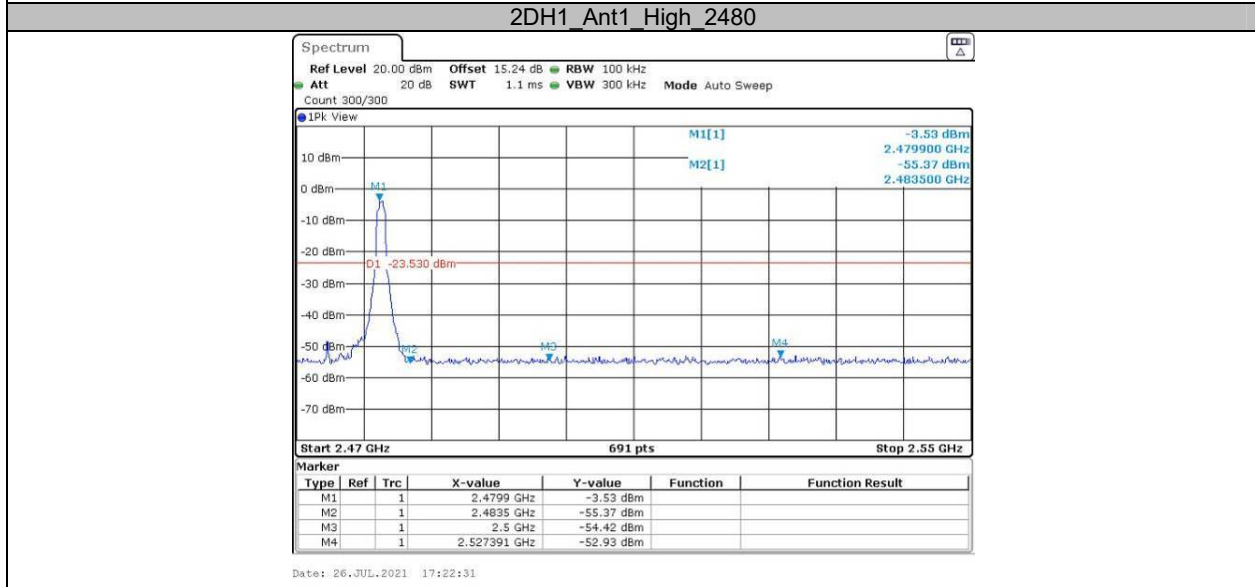
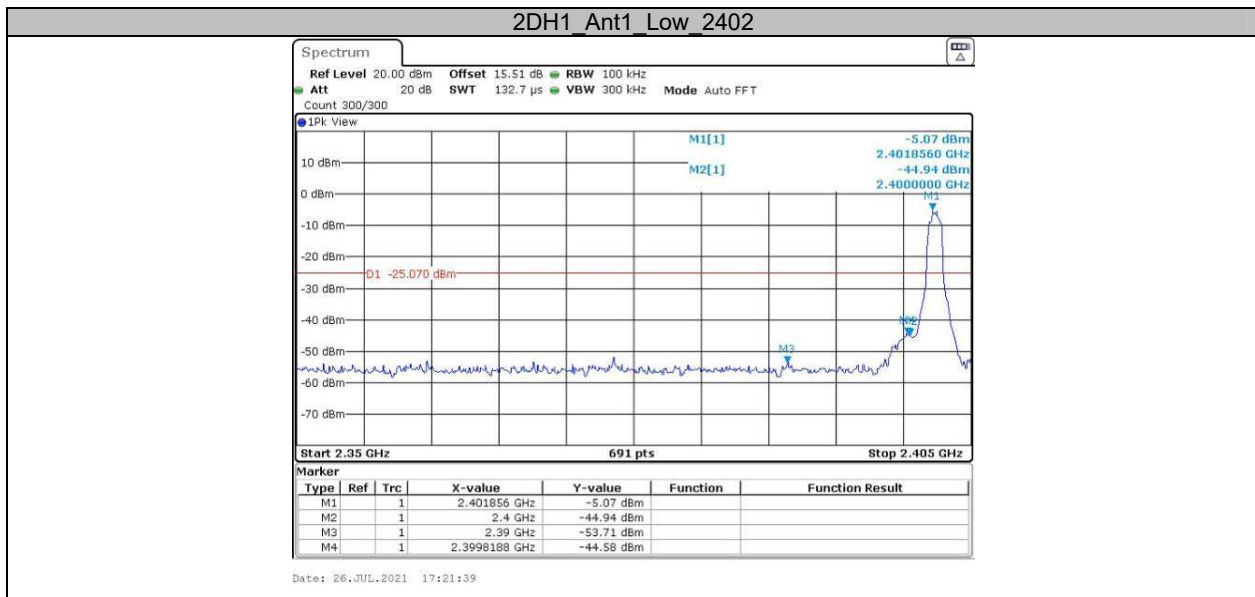

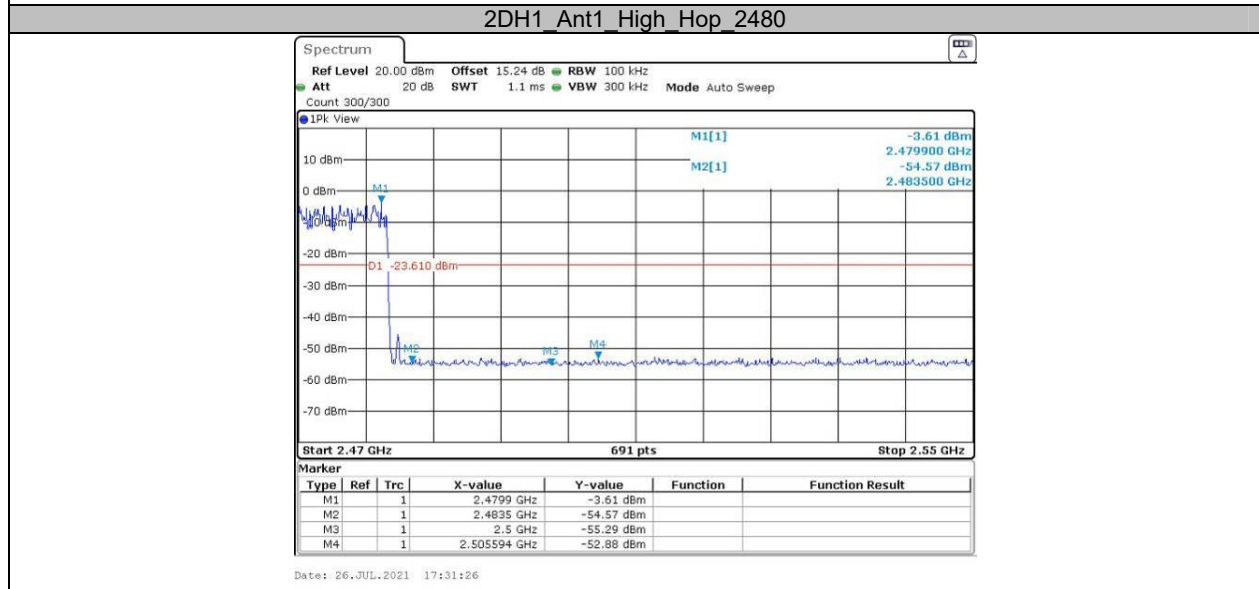
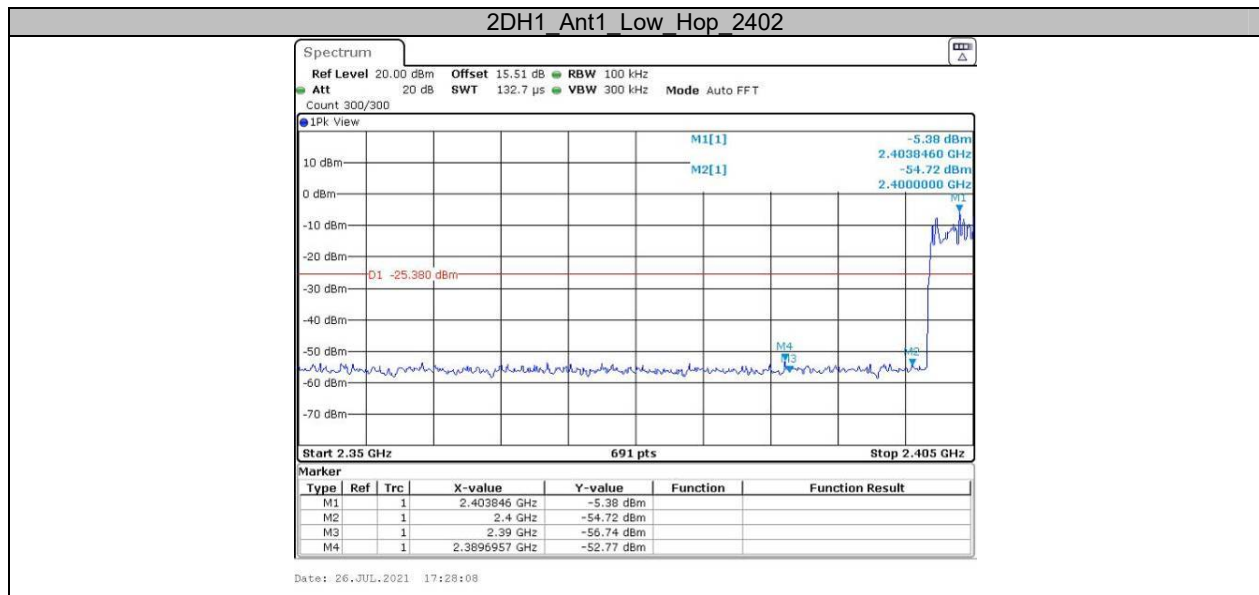

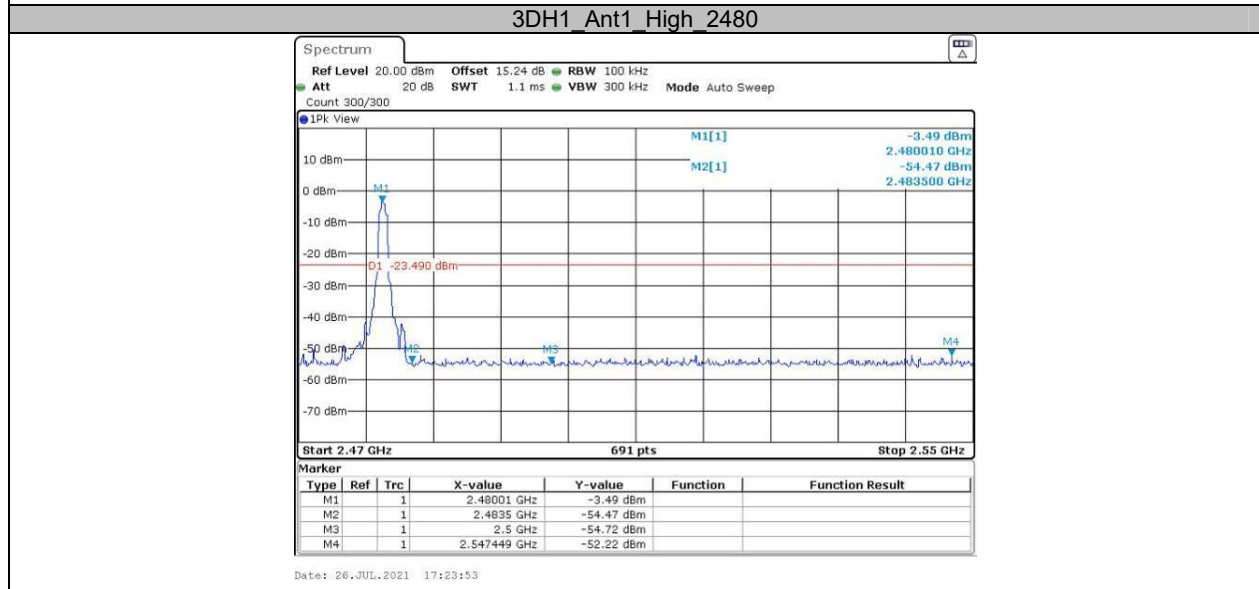
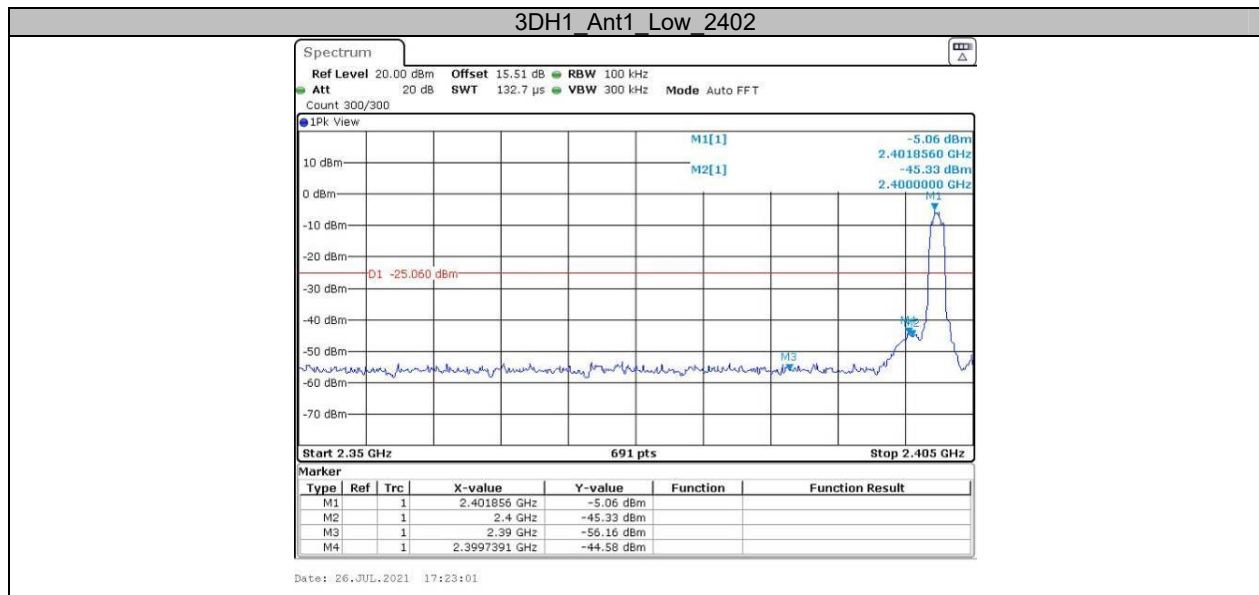

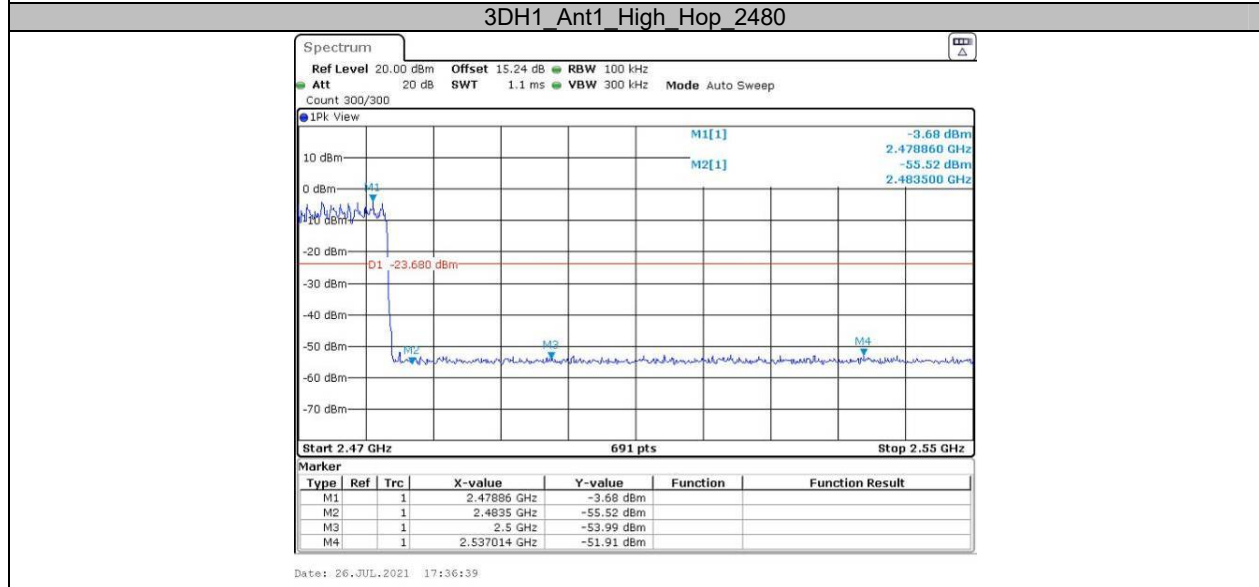
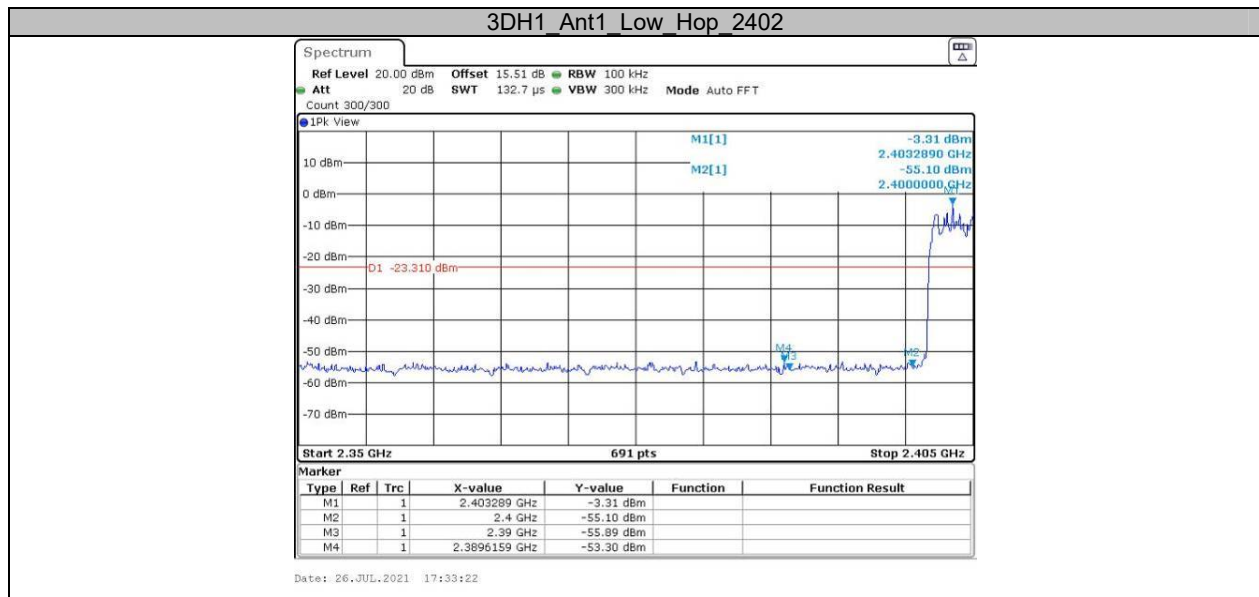

***** END OF REPORT *****