

iHome®

Model: iBTW38
**Dual Alarm Clock
Stereo Speaker System
with Qi Wireless Charging**



instruction manual

Questions? please visit: www.ihome.com/support

iBTW38

Introduction

Thank you for purchasing the iHome iBTW38. This product is designed to provide high quality wireless sound for your iPad, iPhone, iPod or other Bluetooth audio device. It will also wirelessly charge compatible devices.

This instruction booklet explains the basic operation and care of the unit. Please read it carefully and keep for future reference.

Maintenance

- Place the unit on a level surface away from sources of direct sunlight or excessive heat.
- Protect your furniture when placing your unit on a natural wood and lacquered finish. A cloth or other protective material should be placed between it and the furniture.
- Clean your unit with a soft cloth moistened only with mild soap and water. Stronger cleaning agents, such as benzene, thinner or similar materials can damage the surface of the unit.

iBTW38

Included

- iBTW38 system
- 100V-240V universal AC adapter



iBTW38

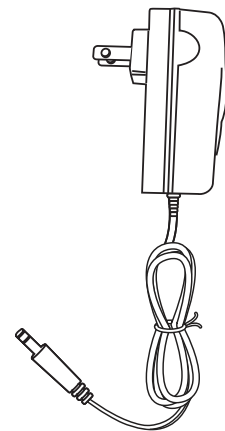

power adapter

iBTW38

Meet Your iBTW38

Top

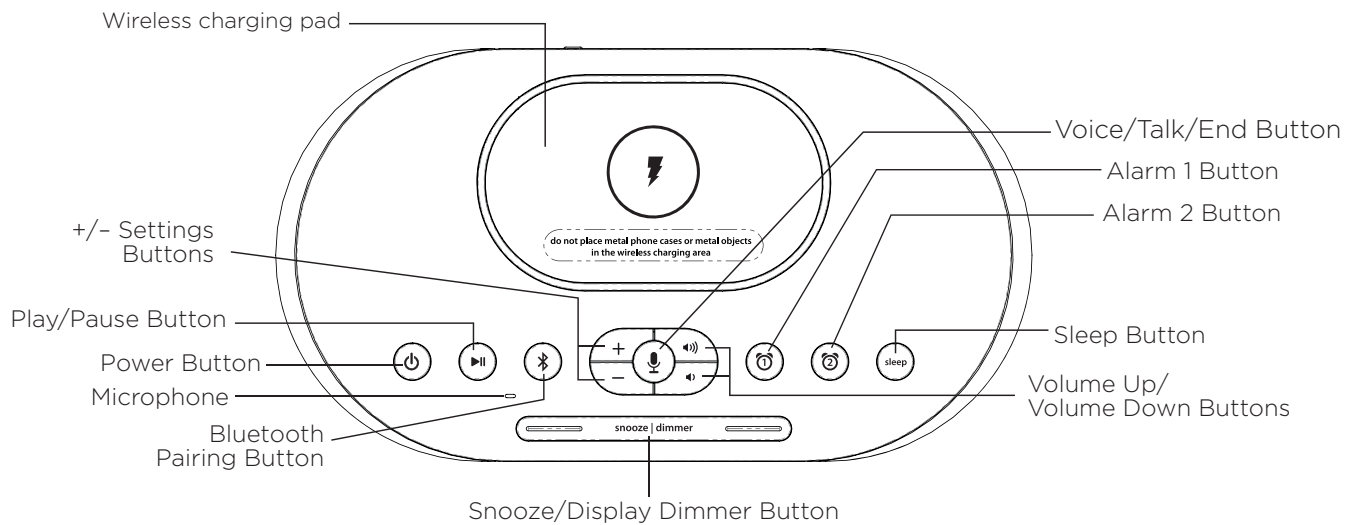

Bottom

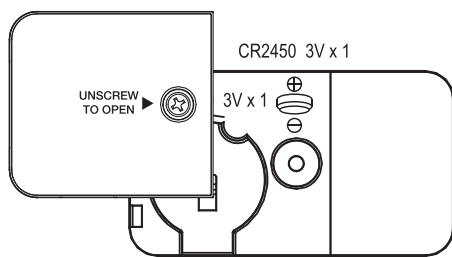

Backup Battery Compartment

Back

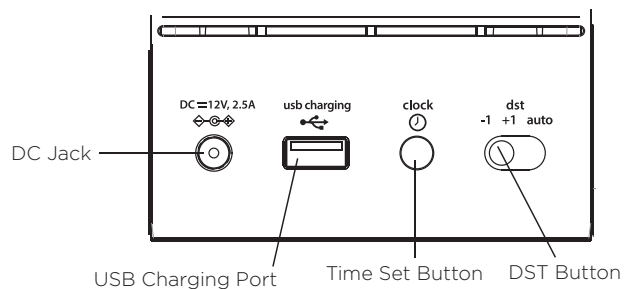

Using the iBTW38

The Display

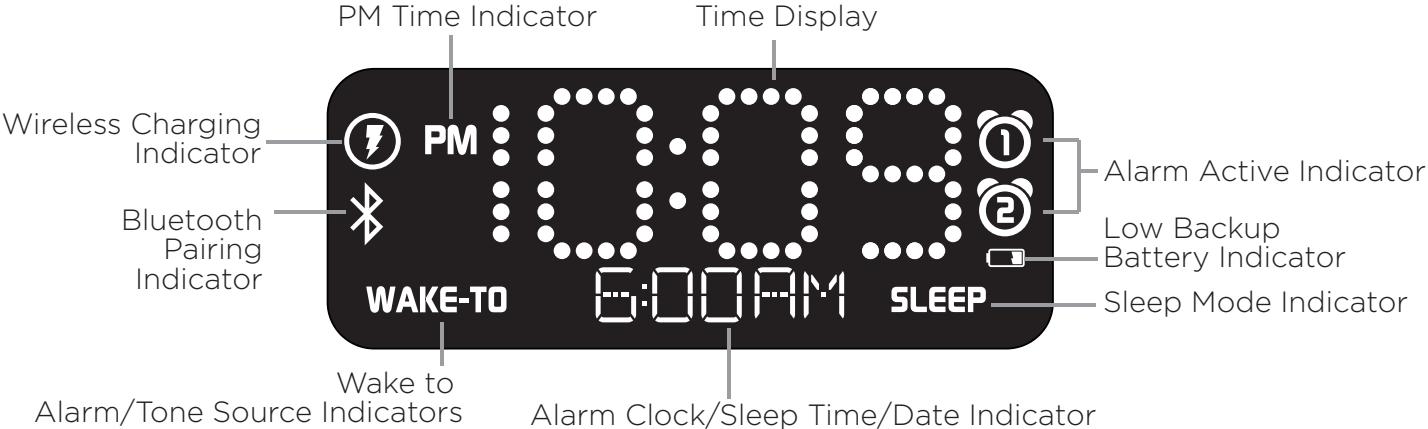

Setting Up the Unit

Connect the included AC adapter to the DC jack located on the back of the unit and connect the other end to a working wall outlet.

CR2450 3V battery is included for battery backup. Install it in the backup battery compartment located on the bottom of the unit before using the unit. See page 11 for more on installing and replacing backup batteries.

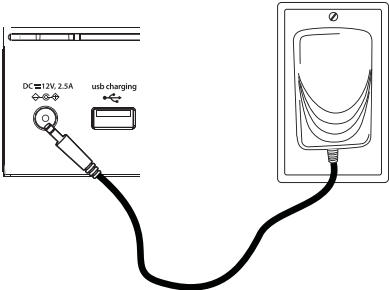

Using the iBTW38

Setting the Clock

1. Press and hold the **⌚ Time Set Button** located on the back of the unit for 2 seconds until the clock display flashes and a beep sounds.
2. Press the **-** or **+** **Buttons** to adjust the clock to the current time (hold for rapid setting). Make sure you set the correct AM/PM time. The PM indicator appears to the left of the display; there is no AM indicator.
3. To toggle the clock display between standard 12 hour time and 24 hour (“military”) time display, press the **⌚ Alarm** or **⌚ Alarm Button** while the display is flashing during time setting.
4. Press and release the **⌚ Time Set Button** to confirm the current time setting. The YEAR will flash on the display. Press the **-** or **+** **Buttons** to set the correct year.
5. Press and release the **⌚ Time Set Button** to confirm the current year setting. The Date will flash on the display. Press the **-** or **+** **Buttons** to set the correct month and day(hold for rapid adjustment).
6. Press and release the **⌚ Time Set Button** to confirm the current date setting. 2 beeps will sound to indicate time setting mode is complete.

Setting and Using the Alarm

This unit features dual alarms which can be set to different times and alarm sources. Each is set in the same way. Instructions are given as “Alarm Button”; use **⌚ Alarm Button** or **⌚ Alarm Button** to set respective alarms.

Note: Each step must be completed while display is flashing or step will time-out with any changes saved.

1. Press and hold the **Alarm Button** for 2 seconds until the alarm time display and alarm icon flash. A beep sounds.
2. Press the **-** or **+** **Buttons** to adjust the alarm time to the desired time (hold for rapid setting). Make sure you set the correct AM/PM alarm time. The AM/PM indicator appears to the right of the alarm time display.
3. Press the **Alarm Button** to confirm the alarm time setting. The wake-to schedule will flash. Press the **-** or **+** **Buttons** to set the desired alarm schedule. 7 Days (every day), 5 Days (week days only) or 2 Days (weekends only)

Setting and Using the Alarm (Cont'd)

4. Press the **Alarm Button** to confirm the alarm schedule. The wake source indicator will flash on the display. Press the **-** or **+** **Buttons** to select the desired wake to alarm source: Bluetooth or tone.

Wake to Bluetooth: You will wake to the currently linked Bluetooth device. If no device is detected, the alarm will default to current Tone.

Wake to Tone: Press the **Alarm Button** to confirm. Press the **-** or **+** **Buttons** as needed to listen to and to select one of the four built-in wake-to tones (1 - 4).

5. Press the **Alarm Button** to confirm the alarm source. The volume display will flash.
6. Press the **-** or **+** **Buttons** to adjust the alarm volume. Note that the alarm volume setting is stored separately from other volume settings.
7. Press the **Alarm Button** to confirm the alarm settings and exit alarm setting mode. 2 beeps will confirm alarm setting is complete. The alarm icon will remain on the display, indicating the alarm is armed.

Previewing the Alarm and Turning the Alarm On/Off

1. Press and release the **Alarm Button** to view the current alarm time.
2. Press and release the **Alarm Button** as needed to toggle the alarm ON and OFF, indicated by the alarm icon and a beep.

Using the iBTW38

Setting The Daylight Daving Time (dst) switch

This unit has a **DST switch** on the back of the unit to adjust the time for daylight saving time and standard time. By default, it is set to Auto and will automatically adjust the time at the start and end of daylight saving time. If you are located in an area that does not observe daylight saving time or otherwise wish to adjust manually, slide the switch to +1 to add one hour or to -1 to subtract an hour.

Snooze/Display Dimmer Button

1. To program Snooze, press and hold the **Snooze/Display Dimmer Button** during normal operation (when no alarm is sounding).
2. Press the **-** or **+** **Buttons** to select the desired snooze time (between 01 and 29 minutes).
3. Press and release the **Snooze/Display Dimmer Button** to confirm Snooze setting. 2 beeps will sound.
4. While the alarm is sounding, press and release the **Snooze/Display Dimmer Button** to temporarily silence the alarm for the set duration (9 minutes is the default). Snooze can be used several times during alarm.
5. To adjust the brightness of the display, press and release the **Snooze/Display Dimmer Button** during normal operation (when no alarm is sounding) to cycle through the brightness display settings.

Sleep Mode

This unit allows you to sleep to the current sound source for a set time before turning the unit off.

1. To set Sleep time, press and release the **Sleep Button** as needed to cycle to the desired sleep duration:120, 90, 60, 30 or 15 minutes or OFF (turns the unit off).
2. Press the **◀** or **▶** **Buttons** to adjust the sleep volume on the unit. Note that the sleep volume setting is stored separately from other volume settings.

Using the iBTW38

Pairing Your Bluetooth Device

When AC power is connected, and the **Power Button** OR or **Bluetooth Button** is pressed, the iBTW38 will announce “Looking for Bluetooth Signal” and attempt to autolink to a previously paired device.



1. Turn on your Bluetooth device and make it “discoverable” by turning on Bluetooth mode (check in Options or Settings).



2. Press the **Power Button** to turn on the iBTW38. **The first time the unit is powered on it will enter pairing mode automatically.** After this, you will need to pair using the Pairing Button after powering on (see step 3 below).



3. *Press and hold* the **Pairing Button** on top of the iBTW38 for 2 seconds. The iBTW38 will announce “Pairing” and the Bluetooth **Bluetooth icon** will flash on the display, indicating the iBTW38 is in pairing mode.

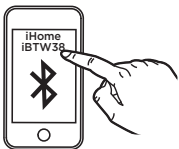







4. “iHome iBTW38” should appear in your device’s Bluetooth menu. Select “iHome iBTW38” to connect device. If prompted for a passcode, enter “1234” on your device’s keypad.

5. If pairing is successful, the iBTW38 will announce “Connected” and the Bluetooth **Bluetooth icon** will appear solid, indicating the iBTW38 is ready to play music. There should also be an indication on your device. If no device is successfully paired within 3 minutes the iBTW38 will default to previous mode. Once the iBTW38 is paired to a device, it will attempt to autolink when the device is within range (about 33 feet).



Using the iBTW38

Playing Audio Via Bluetooth

1. Press the  **Button** to turn the unit **ON**, or press the  **Button**. “BT” and the Bluetooth icon appear on the display. To turn on in play mode, press the  **Button**.
2. Press the  **Button** on the unit to play audio from your linked Bluetooth device.
4. Press the **-** or **+** **Buttons** to go to the previous or next track.
5. Press the  or  **Buttons** to adjust the volume on the unit.
6. When done listening, press the  **Button** to turn the unit off.

Using the Speakerphone feature

NOTE: The unit must be powered on and linked to a Bluetooth phone to receive a call.

1. When a call is received, playing music is muted to hear the ring tone.
“Call” will flash on the display.
Press the  **Voice/Talk/End Button** to answer the call; *press and hold* the  **Voice/Talk/ End Button** to ignore the call.
2. When a call is completed, *press and hold* the  **Talk/End Button** to end the call and resume previous function.

Using the iBTW38

Using Qi Wireless Charging

This unit will wirelessly charge Qi compatible wireless charging phones. PMA wireless charging system is not supported.

CAUTION: Remove metal protective or magnetic case from phone before charging. When charging phone, do not place magnetic-stripped or other metal objects on the charger. Doing so could damage the object or this unit. Qi compatible phones with metallic looking finishes will charge normally.

Center Qi compatible device with back side down on marked charging target circle. Check the wireless charging indicator toward the bottom left of the display.

Rapid blinking icon: Device is not charging properly. Reposition device.
Slow blinking icon: Device is charging properly.
Solid icon: Device is charged (some devices do not support this feature).

Note: The wireless charging process generates heat that may cause phones and chargers to get warm to the touch. This is natural for wireless charging devices.

Using the Voice Control feature

NOTE: The unit must be powered on and linked to an iOS or Android Bluetooth device to use Voice Control. **Press and hold** the  **Button** for 2 seconds and wait for beep to activate voice control with Siri or Google Assistant.

Voice control requires an active internet connection on connected Bluetooth device with iOS 10 and Android 4.1 and later. When activated, the speaker microphone acts as an extension of the microphone in your smartphone to make/take calls, enable you to ask Siri®/Google Assistant™ to play music and more.

Charging Devices via USB Port

1. Connect the standard size end of a USB cable (not included) to the USB Port on back of the unit and connect the other end to the charging port on your device.
2. Monitor the charging on your device. Some devices use a proprietary charging method and will not charge using the USB Port. If this happens, you must charge your device using the charger that came with it.

Replacing and Installing Clock Backup Battery

The unit comes with 1 CR2450 back-up battery installed to provide continuous alarm operation and clock settings in the event of a power failure. **Remove the battery pull tab before use.** When the Battery Low Icon located on the lower right of the display is flashing, it is time to replace the back-up battery. The battery compartment is located on the bottom of the unit.

1. Please make sure the AC adaptor is connected, otherwise all settings may be lost during battery replacement.
2. Use a Phillips screwdriver to remove the battery compartment cover located on the bottom of the unit.
3. Remove exhausted battery. Insert 1 CR2450 battery checking that the + side is facing you. Replace the compartment door. Do not over tighten.

Note: Make sure you dispose of battery properly (see your local regulations).

WARNING: Lithium batteries can explode or cause burns if disassembled, shorted, recharged, exposed to water, fire, or high temperatures. Do not place loose batteries in a pocket, purse, or other container containing metal objects, mix with used or other battery types, or store with hazardous or combustible materials. Store in cool, dry, ventilated area. Follow applicable laws and regulations for transport and disposal.



WARNING: Do not ingest the battery, Chemical Burn Hazard. This product contains a coin/button cell battery. If the coin/button cell battery is swallowed, it can cause severe internal burns in just 2 hours and can lead to death.

Keep new and used batteries away from children. If the battery compartment does not close securely, stop using the product and keep it away from children. If you think batteries might have been swallowed or placed inside any part of the body, seek immediate medical attention."

Using the iBTW38

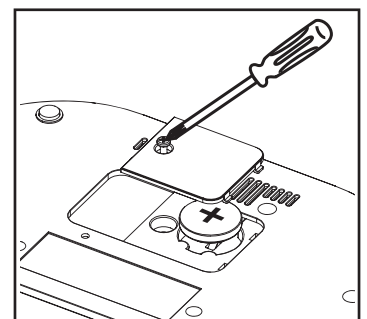
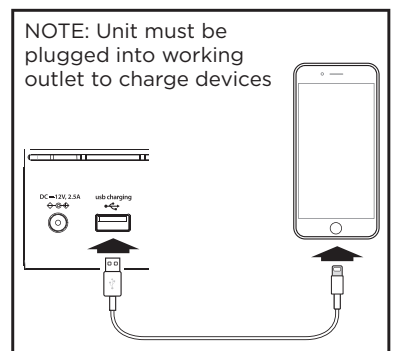

Replacing Backup Battery

Troubleshooting

Unit doesn't respond (no sound)

- Check that all connections are correct and properly plugged in.
- Make sure your device is properly paired with the iBTW38.
- Make sure the Power is ON.
- Make sure volume is up on your Bluetooth device and on unit.

Unit doesn't respond (locked up or frozen)

- The unit may need to be reset. To do so, unplug the unit from power source and remove the backup battery. Let unit stand for 2 minutes. Re-install backup battery and connect unit to power source. You will need to reset the clock, Bluetooth and any other settings.

Trouble pairing device/computer with iBTW38

Bluetooth implementation varies depending on your device's hardware and operating system. Please see our website for updates on pairing.

- When you power ON the unit, it will automatically link with the last previously paired Bluetooth device if the device is still within range (about 33 feet).
- Make sure your device is working properly. Check your device's manual for details on Bluetooth pairing and linking.
- To clear all Bluetooth devices, press and hold the **Bluetooth Button** for 10 seconds when unit is not in pairing mode. A tone will sound and "BT CLR" will appear on the display.

For further information and to see the latest instructions, visit www.ihome.com/support

IMPORTANT SAFETY INSTRUCTIONS

When used in the directed manner, this unit has been designed and manufactured to ensure your personal safety. However, improper use can result in potential electrical shock or fire hazards. Please read and follow all safety and operating instructions carefully before installation and use, and keep these instructions handy for future reference. Take special note of all warnings listed in these instructions and on the unit.

1. **Water and Moisture** - The unit should not be used near water. For example: near a bathtub, washbowl, kitchen sink, laundry tub, swimming pool or in a wet basement.
2. **Ventilation** - Do not block any ventilation openings. Install in accordance with the manufacturer's instructions.
3. **Heat** - The unit should be situated away from heat sources such as radiators, heat registers, stoves or other appliances (including amplifiers) that produce heat.
4. **Power Sources** - The unit should be connected to a power supply only of the type described in the operating instructions or as marked on the appliance. Only use the AC adapter that came with the unit.
5. **Power-Cable Protection** - Power supply cables should be routed so that they are not likely to be walked on or pinched by items placed upon or against them. It is always best to have a clear area from where the cable exits the unit to where it is plugged into an AC socket.
6. **Cleaning** - Unplug unit and clean only with damp cloth. Stronger cleaning agents, such as Benzene, thinner or similar materials can damage the surface of the unit.
7. **Objects and Liquid Entry** - Care should be taken so that objects do not fall and liquids are not spilled into any openings or vents located on the product.
8. **Attachments** - Only use attachments/accessories specified by the manufacturer.
9. **Lightning and Power Surge Protection** - Unplug the unit from the wall socket and disconnect the antenna or cable system during a lightning storm or when it is left unattended and unused for long periods of time. This will prevent damage to the product due to lightning and power-line surges.
10. **Overloading** - Do not overload wall sockets, extension cords, or integral convenience receptacles as this can result in a risk of fire or electric shock.
11. **Damage Requiring Service** - The unit should be serviced by qualified service personnel when:
 - A. the power supply cable or plug has been damaged.
 - B. objects have fallen into or liquid has been spilled into the enclosure.
 - C. the unit has been exposed to rain.
 - D. the unit has been dropped or the enclosure damaged.
 - E. the unit exhibits a marked change in performance or does not operate normally.
12. **Periods of Nonuse** - If the unit is to be left unused for an extended period of time, such as a month or longer, the backup battery should be removed from the unit to prevent damage or corrosion.
13. **Servicing** - The user should not attempt to service the unit beyond those methods described in the user's operating instructions. Service methods not covered in the operating instructions should be referred to qualified service personnel.
14. This product is suitable for use in tropical and/or moderate climates, No naked flame sources, such as lighted candles, should be placed on this product
15. Attention should be drawn to the environmental aspects of battery disposal. Many electronics retailers now recycle batteries and other electronic components at no charge. To find a drop-off location near you, visit www.call2recycle.com

WARNING:

- To reduce the risk of fire or electric shock, do not expose this product to rain or moisture.
- The mains plug of power adaptor is used as the disconnect device, it shall remain readily operable.
- CAUTION - Danger of explosion if battery is incorrectly replaced. Replace only with the same or equivalent type and Do not dispose of batteries in the household trash or fire.

iBTW38

FCC Information

This equipment complies with FCC RF radiation exposure limits set forth for an uncontrolled environment.

This device complies with Part 15 of the FCC Rules, operation is subject to the following two conditions:

(1) This device may not cause harmful interference, and (2) this device must accept any interference received, including interference that may cause undesired operation.

- Warning: Changes or modifications to this unit not expressly approved by the party responsible for compliance could void the user's authority to operate the equipment.
- NOTE: This equipment has been tested and found to comply with the limits for a Class B digital device, pursuant to Part 15 of the FCC Rules. These limits are designed to provide reasonable protection against harmful interference in a residential installation. This equipment generates, uses and can radiate radio frequency energy and, if not installed and used in accordance with the instructions, may cause harmful interference to radio communications.

However, there is no guarantee that interference will not occur in a particular installation. If this equipment does cause harmful interference to radio or television reception, which can be determined by turning the equipment off and on, the user is encouraged to try to correct the interference by one or more of the following measures:

- Reorient or relocate the receiving antenna.
- Increase the separation between the equipment and receiver.
- Connect the equipment into an outlet on a circuit different from that to which the receiver is connected.
- Consult the dealer or an experienced radio/TV technician for help.

This equipment should be installed and operated with minimum distance 20cm between the radiator & your body.

ISED information

This equipment complies with IC RSS-102 radiation exposure limits set forth for an uncontrolled environment.

This device contains licence-exempt transmitter(s)/receiver(s) that comply with Innovation, Science and Economic Development Canada's licence-exempt RSS(s). Operation is subject to the following two conditions:

(1) This device may not cause interference.

(2) This device must accept any interference, including interference that may cause undesired operation of the device.

The device comply with ISED RF exposure requirement, users can obtain Canadian information on RF exposure and compliance.

This equipment should be installed and operated with a minimum distance of 20 cm between the radiator and your body.

Any Changes or modifications not expressly approved by the party responsible for compliance could void the user's authority to operate the equipment.

Cet équipement est conforme aux limites d'exposition aux radiations IC CNR-102 établies pour un environnement non contrôlé.

L'émetteur/récepteur exempt de licence contenu dans le présent appareil est conforme aux CNR d'Innovation, Sciences et Développement économique Canada applicables aux appareils radio exempts de licence. L'exploitation est autorisée aux deux conditions suivantes :

(1) L'appareil ne doit pas produire de brouillage;

(2) L'appareil doit accepter tout brouillage radioélectrique subi, même si le brouillage est susceptible d'en compromettre le fonctionnement.

L'appareil est conforme aux exigences d'exposition RF ISED, les utilisateurs peuvent obtenir des informations canadiennes sur l'exposition aux RF et la conformité.

Cet équipement doit être installé et utilisé avec une distance minimale de 20 cm entre le radiateur et votre corps.

Tout changement ou modification non expressément approuvé par la partie responsable de la conformité peut annuler l'autorité de l'utilisateur à utiliser l'équipement.



For product support information and warranty please visit:
www.ihome.com/support

© 2021 SDI Technologies, Inc. All rights reserved

iBTW38 Eng IB
Size: 153mm x 120mm
Printing color: Black
April 20, 2021



P1

iHome®

Model: iBTW38
**Dual Alarm Clock
Stereo Speaker System
with Qi Wireless Charging**



instruction manual

Questions? please visit: www.ihome.com/support