

**ELECTROMAGNETIC EMISSIONS COMPLIANCE REPORT
INTENTIONAL RADIATOR CERTIFICATION TO
FCC PART 15 SUBPART C REQUIREMENT**

OF

Dual Alarm Clock Stereo Speaker System with Qi Wireless Charging

Model No.: iBTW38, iBTW38X (X means A-Z, denote as color of cabinet)

Trademark: iHome

FCC ID: EMOIBTW38

Report No.: ES180123028E1

Issue Date: February 06, 2018

Prepared for

**SDI Technologies Inc.
1299, Main Street, Rahway, NJ 07065, U.S.A.**

Prepared by

EMTEK(SHENZHEN) CO., LTD.

**Bldg 69, Majialong Industry Zone, Nanshan District, Shenzhen,
Guangdong, China.**

TEL: 86-755-26954280

FAX: 86-755-26954282

**This report shall not be reproduced, except in full, without the written approval of
EMTEK(SHENZHEN) CO., LTD.**

VERIFICATION OF COMPLIANCE

Applicant:	SDI Technologies Inc. 1299, Main Street, Rahway, NJ 07065, U.S.A.
Manufacturer:	SDI Technologies Inc. 1299, Main Street, Rahway, NJ 07065, U.S.A.
Factory :	DongGuan Synst Electronics Co., Ltd. The Science &Technology Industrial Park, Houjie Town, DongGuan, China.
Product Description:	Dual Alarm Clock Stereo Speaker System with Qi Wireless Charging
Trade Mark:	iHome
Model Number:	iBTW38, iBTW38X (X means A-Z, denote as color of cabinet) (Note: The samples are the same except difference color of appearance and model number, Here iBTW38 was selected for full test.)

We hereby certify that:

The above equipment was tested by EMTEK(SHENZHEN) CO., LTD. The test data, data evaluation, test procedures, and equipment configurations shown in this report were made in accordance with the procedures given in ANSI C63.10-2013 and the energy emitted by the sample EUT tested as described in this report is in compliance with conducted and radiated emission limits of FCC Rules Part 15.247(2018).

Date of Test : January 23, 2018 to February 02, 2018

Yaping Shen

Prepared/Tested by : _____

Yaping Shen/Editor

Joe Xia

Reviewer : _____

Joe Xia/Supervisor

Approved & Authorized
Signer :

Lisa Wang

Lisa Wang/Manager

Modified Information

Version	Summary	Revision Date	Report No.
Ver.1.0	Original Report	/	ES180123028E1

Table of Contents

1. GENERAL INFORMATION	6
1.1 PRODUCT DESCRIPTION	6
1.2 TEST METHODOLOGY	7
1.3 TEST FACILITY	7
2. SYSTEM TEST CONFIGURATION.....	8
2.1 EUT CONFIGURATION	8
2.2 EUT EXERCISE	8
2.3 TEST PROCEDURE	8
2.4 CONFIGURATION OF TESTED SYSTEM	9
3. SUMMARY OF TEST RESULTS.....	10
4. DESCRIPTION OF TEST MODES	11
5. TEST SYSTEM UNCERTAINTY.....	12
6. CONDUCTED EMISSIONS TEST	13
6.1 MEASUREMENT PROCEDURE:	13
6.2 TEST SET-UP (BLOCK DIAGRAM OF CONFIGURATION)	13
6.3 MEASUREMENT EQUIPMENT USED:	13
6.4 MEASUREMENT RESULT:	14
6.5 CONDUCTED MEASUREMENT PHOTOS:	19
7. RADIATED EMISSION TEST	20
7.1 MEASUREMENT PROCEDURE	20
7.2 TEST SET-UP (BLOCK DIAGRAM OF CONFIGURATION)	22
7.3 MEASUREMENT EQUIPMENT USED:	23
7.4 RADIATED EMISSION LIMIT	24
7.5 MEASUREMENT RESULT	25
7.6 RADIATED MEASUREMENT PHOTOS:	35
8. CHANNEL SEPARATION TEST	36
8.1 MEASUREMENT PROCEDURE	36
8.2 TEST SET-UP (BLOCK DIAGRAM OF CONFIGURATION)	36
8.3 MEASUREMENT EQUIPMENT USED:	36
8.4 MEASUREMENT RESULTS:	36
9. 20DB BANDWIDTH TEST	43
9.1 MEASUREMENT PROCEDURE	43
9.2 TEST SET-UP (BLOCK DIAGRAM OF CONFIGURATION)	43
9.3 MEASUREMENT EQUIPMENT USED:	43
9.4 MEASUREMENT RESULTS:	43
10. QUANTITY OF HOPPING CHANNEL TEST	50

10.1 MEASUREMENT PROCEDURE 50

10.2 TEST SET-UP (BLOCK DIAGRAM OF CONFIGURATION)..... 50

10.3 MEASUREMENT EQUIPMENT USED:..... 50

10.4 MEASUREMENT RESULTS: 50

11. TIME OF OCCUPANCY (DWELL TIME) TEST 51

11.1 TEST DESCRIPTION..... 51

11.2 TEST SET-UP (BLOCK DIAGRAM OF CONFIGURATION)..... 51

11.3 MEASUREMENT EQUIPMENT USED:..... 51

11.4 TEST REQUIREMENTS / LIMITS..... 51

11.5 TEST RESULT 52

12. MAXIMUM PEAK OUTPUT POWER TEST 54

12.1 MEASUREMENT PROCEDURE 54

12.2 TEST SET-UP (BLOCK DIAGRAM OF CONFIGURATION)..... 54

12.3 MEASUREMENT EQUIPMENT USED:..... 54

12.4 MEASUREMENT RESULTS: 55

13. BAND EDGE TEST..... 61

13.1 MEASUREMENT PROCEDURE 61

13.2 TEST SET-UP (BLOCK DIAGRAM OF CONFIGURATION)..... 62

13.3 MEASUREMENT EQUIPMENT USED:..... 62

13.4 MEASUREMENT RESULTS: 63

14. ANTENNA APPLICATION 78

14.1 ANTENNA REQUIREMENT 78

14.2 RESULT..... 78

15. PHOTOS OF EUT 78

1. GENERAL INFORMATION

1.1 Product Description

Characteristics	Description
Product Name	Dual Alarm Clock Stereo Speaker System with Qi Wireless Charging
Model number	iBTW38
Input Rating	DC 12V from adapter
Power Supply	AC120V/60Hz for adapter
Adapter1	Manufacturer: Dongguan City Gangqi Electronic Co., Ltd. Model number:GQ24-120250-AU Input rating: 100-240V~, 50/60Hz, 1.0A Max. Output rating: DC 12V, 2.5A
Adapter2	Manufacturer: Dongguan Becky Electronic Co., Ltd. Model number:S030A1202500U Input rating: 100-240V~, 50/60Hz, Max.800mA Output rating: DC 12V, 2500mA
Kind of Device	Bluetooth Ver.4.2+EDR
Modulation	GFSK, $\pi/4$ -DQPSK, 8DPSK
Operating Frequency Range	2402-2480MHz
Number of Channels	79
Transmit Power Max(PK)	2.95dBm(0.001972W)
Antenna Type	Internal PCB antenna
Antenna Gain	2dBi
Product Software Version	V004
Product Hardware version	V015
Radio Software Version	V004
Radio Hardware version	V015

1.2 Test Methodology

Both conducted and radiated testing was performed according to the procedures in ANSI C63.10-2013. Radiated testing was performed at an antenna to EUT distance 3 meters.

1.3 Test Facility

Site Description

EMC Lab. : Accredited by CNAS, 2016.10.24
The certificate is valid until 2022.10.28
The Laboratory has been assessed and proved to be in compliance with CNAS-CL01:2006 (identical to ISO/IEC 17025:2005)
The Certificate Registration Number is L2291.

Accredited by TUV Rheinland Shenzhen 2016.5.19
The Laboratory has been assessed according to the requirements ISO/IEC 17025.

Accredited by FCC, August 03, 2017
Designation Number: CN1204
Test Firm Registration Number: 882943

Accredited by Industry Canada, November 24, 2015
The Certificate Registration Number is 4480A.

Accredited by A2LA, July 31, 2017
The Certificate Number is 4321.01.

Name of Firm : EMTEK(SHENZHEN) CO., LTD.
Site Location : Bldg 69, Majialong Industry Zone, Nanshan District, Shenzhen, Guangdong, China.

2. System Test Configuration

2.1 EUT Configuration

The EUT configuration for testing is installed on RF field strength measurement to meet the Commissions requirement and operating in a manner which intends to maximize its emission characteristics in a continuous normal application.

2.2 EUT Exercise

The Transmitter was operated in the normal operating mode. The Tx frequency was fixed which was for the purpose of the measurements.

2.3 Test Procedure

2.3.1 Conducted Emissions

The EUT is a placed on as turn table which is 0.8 m above ground plane. According to the requirements in Section 13.1.4.1 of ANSI C63.10-2013. Conducted emissions from the EUT measured in the frequency range between 0.15 MHz and 30MHz using CISPR Quasi-Peak and average detector mode.

2.3.2 Radiated Emissions

Below 1000MHz, The EUT was placed on a turn table which is 0.8m above ground plane. And above 1000MHz, The EUT was placed on a styrofoam table which is 1.5m above ground plane. The turn table shall rotate 360 degrees to determine the position of maximum emission level. EUT is set 3m away from the receiving antenna which varied from 1m to 4m to find out the highest emission. And also, each emission was to be maximized by changing the polarization of receiving antenna both horizontal and vertical. In order to find out the max. emission, the relative positions of EUT was fixed in a particular direction according to the requirements in Section 13.1.4.1 of ANSI C63.10-2013.

2.4 Configuration of Tested System

Fig. 2-1 Configuration of Tested System

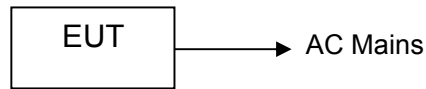

Table 2-1 Equipment Used in Tested System

Item	Equipment	Trademark	Model No.	FCC ID	Note
1.	Dual Alarm Clock Stereo Speaker System with Qi Wireless Charging	iHome	iBTW38	EMOIBTW38	<i>EUT</i>
2.	Adapter1	N/A	GQ24-120250-AU	N/A	<i>Support EUT</i>
3.	Adapter2	N/A	S030A1202500U	N/A	<i>Support EUT</i>

Note:

- (1) Unless otherwise denoted as EUT in 『Remark』 column , device(s) used in tested system is a support equipment.

3. Summary of Test Results

FCC Rules	Description Of Test	Result
§15.207	AC Power Conducted Emission	Compliant
§15.247(d),§15.209	Radiated Emission	Compliant
§15.247(a)(1)	Channel Separation test	Compliant
§15.247(a)(1)	20dB Bandwidth	Compliant
§15.247(a)(1)(iii)	Quantity of Hopping Channel	Compliant
§15.247(a)(1)(iii)	Time of Occupancy(Dwell Time)	Compliant
§15.247(b)	Max Peak output Power test	Compliant
§15.247(d)	Band edge test	Compliant
§15.203	Antenna Requirement	Compliant

4. Description of test modes

The EUT has been tested under its typical operating condition. Pre-defined engineering program for regulatory testing used to control the EUT for staying in continuous transmitting. Only the worst case data were reported.

The EUT has been associated with peripherals pursuant to ANSI C63.10-2013 and configuration operated in a manner tended to maximize its emission characteristics in a typical application. Frequency range investigated: radiation (9 KHz to the 10th harmonics of the highest fundamental frequency or to 40 GHz, whichever is lower).

The EUT has been tested under TX operating condition. This EUT is a FHSS system, were conducted to determine the final configuration from all possible combinations. We use software control the EUT, Let EUT hopping on and transmit with highest power, all the modes GFSK, $\pi/4$ -DQPSK, 8DPSK have been tested. 79 Channels are provided by EUT. The 3 channels of lower, medium and higher were chosen for test.

Channel	Frequency(MHz)
1	2402
40	2441
79	2480

5. TEST SYSTEM UNCERTAINTY

The following measurement uncertainty levels have been estimated for tests performed on the apparatus:

Parameter	Uncertainty
Radio Frequency	$\pm 1 \times 10^{-5}$
Maximum Peak Output Power Test	$\pm 1.0\text{dB}$
Conducted Emissions Test	$\pm 2.0\text{dB}$
Radiated Emission Test	$\pm 2.0\text{dB}$
Power Density	$\pm 2.0\text{dB}$
Occupied Bandwidth Test	$\pm 1.0\text{dB}$
Band Edge Test	$\pm 3\text{dB}$
All emission, radiated	$\pm 3\text{dB}$
Antenna Port Emission	$\pm 3\text{dB}$
Temperature	$\pm 0.5^\circ\text{C}$
Humidity	$\pm 3\%$

Remark: The coverage Factor (k=2), and measurement Uncertainty for a level of Confidence of 95%

6. Conducted Emissions Test

6.1 Measurement Procedure:

1. The EUT was placed on a table, which is 0.8m above ground plane.
2. Maximum procedure was performed on the six highest emissions to ensure EUT compliance.
3. Repeat above procedures until all frequency measured was complete.

6.2 Test SET-UP (Block Diagram of Configuration)

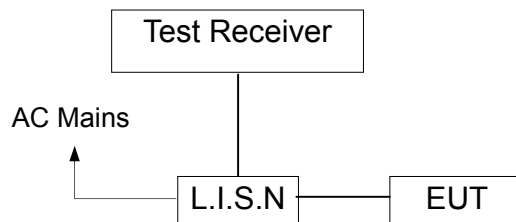

6.3 Measurement Equipment Used:

Conducted Emission Test Site						
EQUIPMENT TYPE	MFR	MODEL NUMBER	SERIAL NUMBER	Characteristics	Last Cal.	Due date
Test Receiver	Rohde & Schwarz	ESCS30	100018	9kHz~3GHz	05/16/2017	05/15/2018
L.I.S.N	Rohde & Schwarz	ENV216	100017	9KHz-300MHz	05/16/2017	05/15/2018
RF Switching Unit	CDS	RSU-M2	38401	9KHz-300MHz	05/16/2017	05/15/2018
Coaxial Cable	CDS	79254	46107086	9kHz~3GHz	05/16/2017	05/15/2018

6.4 Measurement Result:

Operation Mode:	TX	Test Date :	February 02, 2018
Frequency Range:	0.15MHz~30MHz	Temperature :	28℃
Test Result:	PASS	Humidity :	65 %
Test By:	Yaping Shen		

Pass.

All the modulation modes were tested the data of the worst mode (GFSK TX 2402MHz) are recorded in the following pages and the others modulation methods do not exceed the limits.

Please refer to the following data.

Adapter2:S030A1202500U

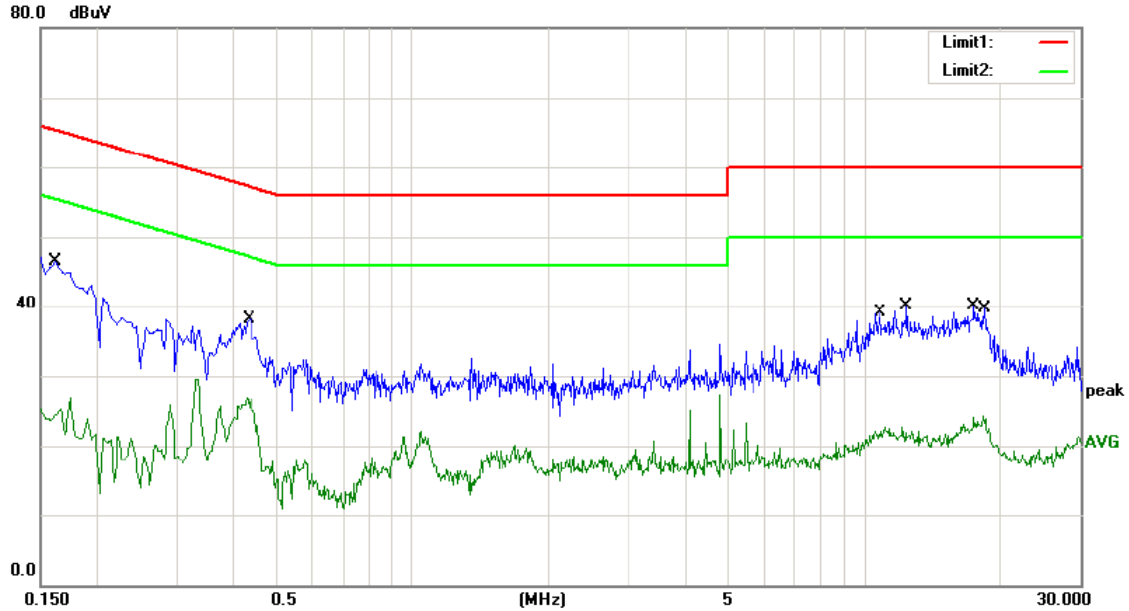

Site site #1	Phase: L1	Temperature: 25
Limit: (CE)FCC PART 15 C_QP	Power: AC 120V/60Hz	Humidity: 55 %
Mode: DSS (TX2402)		
Note:		

No.	Mk.	Freq. MHz	Reading Level dBuV	Correct Factor dB	Measure- ment dBuV	Limit dBuV	Over dB	Detector	Comment
1		0.1620	33.42	9.78	43.20	65.36	-22.16	QP	
2		0.1620	14.78	9.78	24.56	55.36	-30.80	AVG	
3		0.4340	25.47	9.83	35.30	57.18	-21.88	QP	
4	*	0.4340	16.85	9.83	26.68	47.18	-20.50	AVG	
5		10.8260	26.20	10.00	36.20	60.00	-23.80	QP	
6		10.8260	11.15	10.00	21.15	50.00	-28.85	AVG	
7		12.4460	27.26	10.04	37.30	60.00	-22.70	QP	
8		12.4460	10.85	10.04	20.89	50.00	-29.11	AVG	
9		17.4660	26.73	10.17	36.90	60.00	-23.10	QP	
10		17.4660	13.84	10.17	24.01	50.00	-25.99	AVG	
11		18.3460	25.70	10.20	35.90	60.00	-24.10	QP	
12		18.3460	12.39	10.20	22.59	50.00	-27.41	AVG	

*:Maximum data x:Over limit !:over margin Comment: Factor build in receiver. Operator: Yaping shen

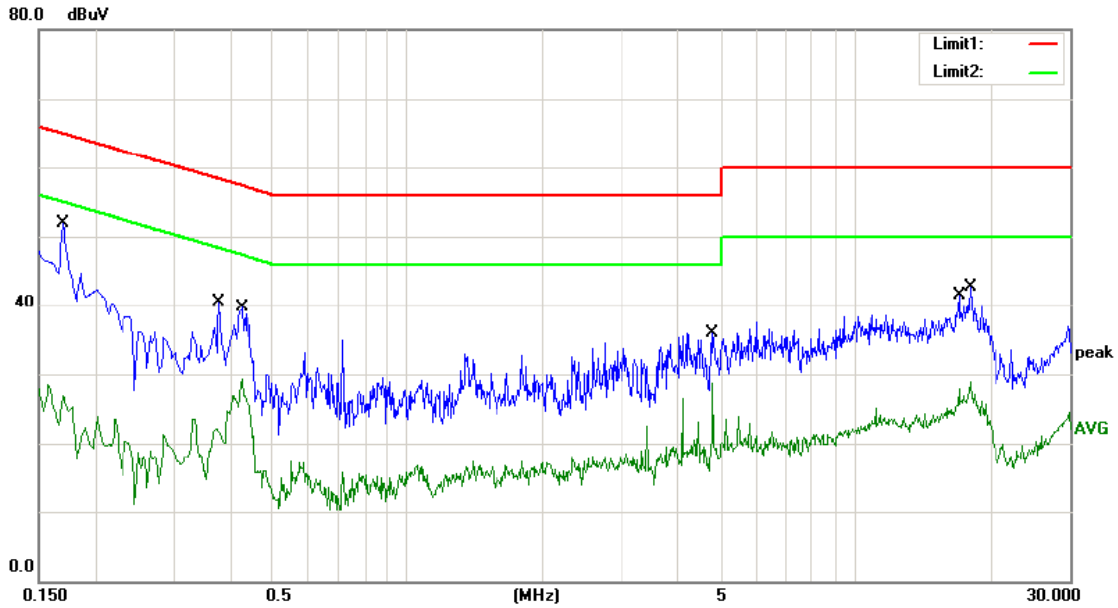

Site: site #1 Phase: **N** Temperature: 25
 Limit: (CE)FCC PART 15 C_QP Power: AC 120V/60Hz Humidity: 55 %
 Mode: DSS (TX2402)
 Note:

No.	Mk.	Freq. MHz	Reading Level dBuV	Correct Factor dB	Measure- ment dBuV	Limit dBuV	Over dB	Detector	Comment
1	*	0.1700	38.92	9.78	48.70	64.96	-16.26	QP	
2		0.1700	15.89	9.78	25.67	54.96	-29.29	AVG	
3		0.3780	27.98	9.82	37.80	58.32	-20.52	QP	
4		0.3780	11.79	9.82	21.61	48.32	-26.71	AVG	
5		0.4260	26.97	9.83	36.80	57.33	-20.53	QP	
6		0.4260	19.06	9.83	28.89	47.33	-18.44	AVG	
7		4.7900	23.35	9.85	33.20	56.00	-22.80	QP	
8		4.7900	9.29	9.85	19.14	46.00	-26.86	AVG	
9		16.9820	28.44	10.16	38.60	60.00	-21.40	QP	
10		16.9820	15.98	10.16	26.14	50.00	-23.86	AVG	
11		18.0220	29.41	10.19	39.60	60.00	-20.40	QP	
12		18.0220	17.26	10.19	27.45	50.00	-22.55	AVG	

*:Maximum data x:Over limit !:over margin Comment: Factor build in receiver. Operator: Yaping shen

6.5 Conducted Measurement Photos:



7. Radiated Emission Test

7.1 Measurement Procedure

1. The testing follows the guidelines in Spurious Radiated Emissions of ANSI C63.10-2013.
2. Below 1000MHz, The EUT was placed on a turn table which is 0.8m above ground plane. And above 1000MHz, The EUT was placed on a styrofoam table which is 1.5m above ground plane.
3. The EUT was set 3 meters from the interference receiving antenna, which was mounted on the top of a variable height antenna tower.
4. For each suspected emission, the EUT was arranged to its worst case and then tune the Antenna tower (From 1m to 4m) and turntable (from 0 degree to 360 degree) to find the maximum reading. A pre-amp and a high pass filter are used for the test in order to get better signal level to comply with the guidelines.
5. Set to the maximum power setting and enable the EUT transmit continuously.
6. Final measurement (Above 1GHz): The frequency range will be divided into different sub ranges depending of the frequency range of the used horn antenna. The EMI Receiver set to peak and average mode and a resolution bandwidth of 1MHz. The measurement will be performed in horizontal and vertical polarization of the measuring antenna and while rotating the EUT in its vertical axis in the range of 0 degree to 360 degree in order to have the antenna inside the cone of radiation.
7. Test Procedure of measurement (For Above 1GHz):
 - 1) Monitor the frequency range at horizontal polarization and move the antenna over all sides of the EUT(if necessary move the EUT to another orthogonal axis).
 - 2) Change the antenna polarization and repeat 1) with vertical polarization.
 - 3) Make a hardcopy of the spectrum.
 - 4) Measure the frequency of the detected emissions with a lower span and resolution bandwidth to increase the accuracy and note the frequency value.
 - 5) Change the analyser mode to Clear/ Write and found the cone of emission.
 - 6) Rotate and move the EUT, so that the measuring distance can be enlarged to 3m and the antenna will be still inside the cone of emission.
 - 7) Measure the level of the detected frequency with the correct resolution bandwidth, with the antenna polarization and azimuth and the peak and average detector, which causes the maximum emission.
 - 8) Repeat steps 1) to 7) for the next antenna spot if the EUT is larger than the antenna beamwidth.

Use the following spectrum analyzer settings:

When spectrum scanned from 30MHz to 1GHz setting resolution bandwidth 120KHz and video bandwidth 300KHz:

EMI Test Receiver	Setting
Attenuation	Auto
RB	120KHz
VB	300KHz
Detector	QP
Trace	Max hold

When spectrum scanned above 1GHz setting resolution bandwidth 1MHz, video bandwidth 3MHz:

EMI Test Receiver	Setting
Attenuation	Auto
RB	1MHz
VB	3MHz
Detector	Peak
Trace	Max hold

When spectrum scanned above 1GHz setting resolution bandwidth 1MHz, video bandwidth 10Hz:

EMI Test Receiver	Setting
Attenuation	Auto
RB	1MHz
VB	10Hz
Detector	Peak
Trace	Max hold

7.2 Test SET-UP (Block Diagram of Configuration)

(A) Radiated Emission Test Set-Up, Frequency Below 30MHz

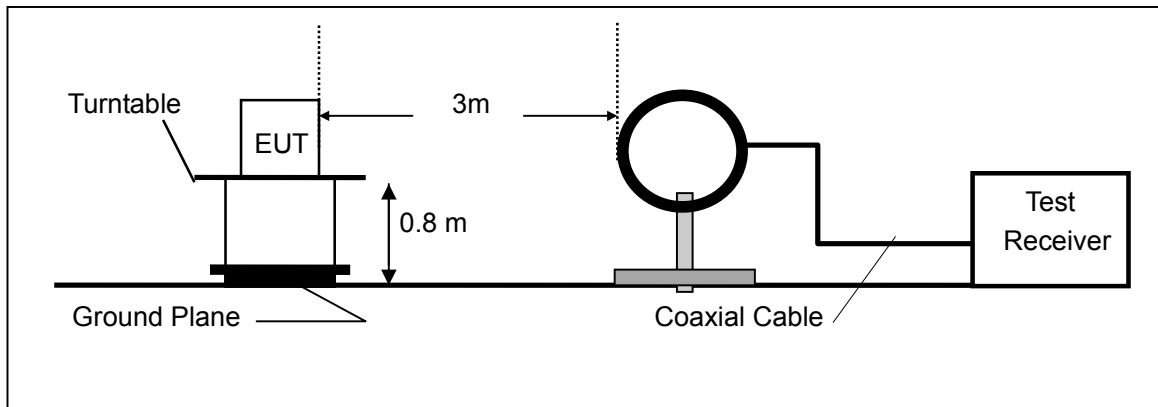

(B) Radiated Emission Test Set-Up, Frequency Below 1000MHz

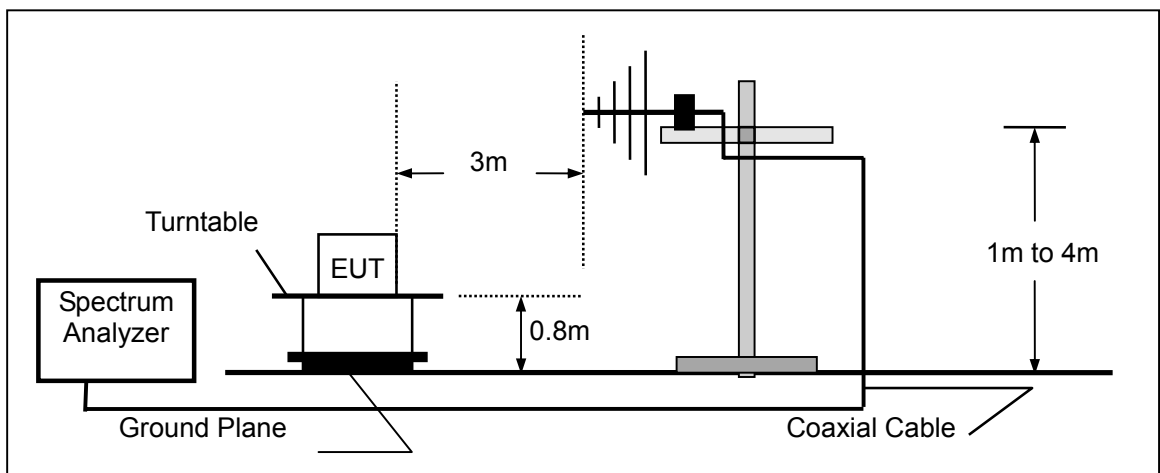

(C) Radiated Emission Test Set-Up, Frequency above 1000MHz

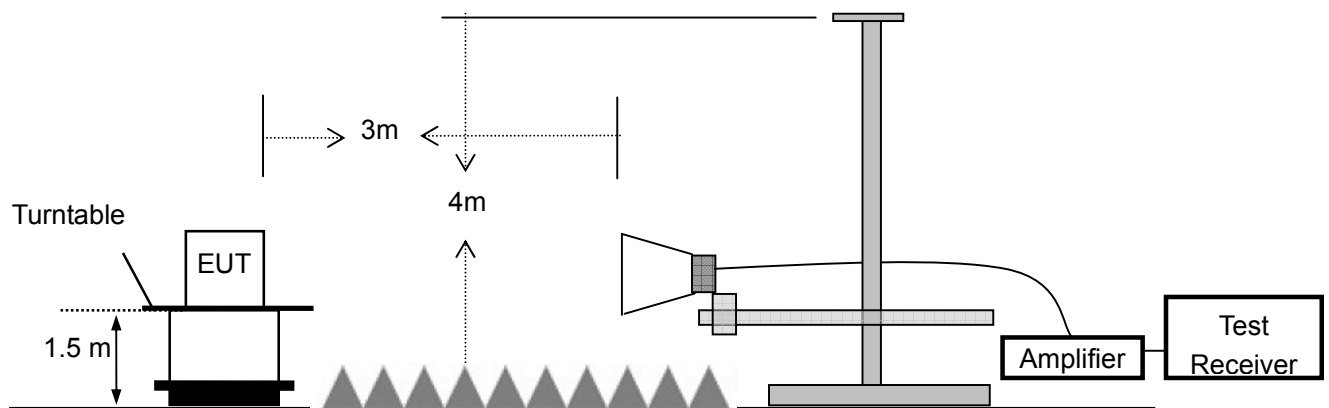

7.3 Measurement Equipment Used:

Item	Equipment	Manufacturer	Model No.	Serial No.	Characteristics	Last Cal.	Cal. Interval
1.	Test Receiver	Rohde & Schwarz	ESCI	1166.5950.03	9KHz-3GHz	05/16/2017	1 Year
2.	Loop Antenna	Schwarzbeck	FMZB 1519	012	9 KHz -30MHz	05/16/2017	1 Year
3.	Bilog Antenna	Schwarzbeck	VULB9163	000141	25MHz-2GHz	05/16/2017	1 Year
4.	Power Amplifier	CDS	RSU-M352	818	1MHz-1GHz	05/16/2017	1 Year
5.	Power Amplifier	HP	8447F	OPT H64	1GHz-26.5GHz	05/16/2017	1 Year
6.	Color Monitor	SUNSPO	SP-140A	N/A	--	05/16/2017	1 Year
7.	Single Line Filter	JIANLI	XL-3	N/A	--	05/16/2017	1 Year
8.	Single Phase Power Line Filter	JIANLI	DL-2X100B	N/A	--	05/16/2017	1 Year
9.	3 Phase Power Line Filter	JIANLI	DL-4X100B	N/A	--	05/16/2017	1 Year
10.	DC Power Filter	JIANLI	DL-2X50B	N/A	--	05/16/2017	1 Year
11.	Cable	Schwarzbeck	PLF-100	549489	9KHz-3GHz	05/16/2017	1 Year
12.	Cable	Rosenberger	CIL02	A0783566	9KHz-3GHz	05/16/2017	1 Year
13.	Cable	Rosenberger	RG 233/U	525178	9KHz-3GHz	05/16/2017	1 Year
14.	Signal Analyzer	Rohde & Schwarz	FSV30	103040	9KHz-40GHz	05/16/2017	1 Year
15.	Horn Antenna	Schwarzbeck	BBHA9120D	9120D-1272	1GHz-18GHz	05/16/2017	1 Year
16.	Horn Antenna	Schwarzbeck	BBHA 9170	BBHA9170399	14GHz -26.5GHz	05/16/2017	1 Year
17.	Power Amplifier	LUNAR EM	LNA1G18-40	J10100000081	1GHz-26.5GHz	05/16/2017	1 Year
18.	Cable	H+S	CBL-26	N/A	1GHz-26.5GHz	05/16/2017	1 Year
19.	Cable	H+S	CBL-26	N/A	1GHz-26.5GHz	05/16/2017	1 Year
20.	Cable	H+S	CBL-26	N/A	1GHz-26.5GHz	05/16/2017	1 Year

7.4 Radiated Emission Limit

The emissions from an intentional radiator shall not exceed the field strength levels specified in the following table 15.209(a):

Frequencies (MHz)	Field Strength (microrvolts/meter)	Measurement Distance (meters)
0.009~0.490	2400/F(KHz)	300
0.490~1.705	24000/F(KHz)	30
1.705~30.0	30	30
30~88	100	3
88~216	150	3
216~960	200	3
Above 960	500	3

15.205 Restricted bands of operation

MHz	MHz	MHz	GHz
0.090 - 0.110	16.42 - 16.423	399.9 - 410	4.5 - 5.15
¹ 0.495 - 0.505	16.69475 - 16.69525	608 - 614	5.35 - 5.46
2.1735 - 2.1905	16.80425 - 16.80475	960 - 1240	7.25 - 7.75
4.125 - 4.128	25.5 - 25.67	1300 - 1427	8.025 - 8.5
4.17725 - 4.17775	37.5 - 38.25	1435 - 1626.5	9.0 - 9.2
4.20725 - 4.20775	73 - 74.6	1645.5 - 1646.5	9.3 - 9.5
6.215 - 6.218	74.8 - 75.2	1660 - 1710	10.6 - 12.7
6.26775 - 6.26825	108 - 121.94	1718.8 - 1722.2	13.25 - 13.4
6.31175 - 6.31225	123 - 138	2200 - 2300	14.47 - 14.5
8.291 - 8.294	149.9 - 150.05	2310 - 2390	15.35 - 16.2
8.362 - 8.366	156.52475 - 156.52525	2483.5 - 2500	17.7 - 21.4
8.37625 - 8.38675	156.7 - 156.9	2690 - 2900	22.01 - 23.12
8.41425 - 8.41475	162.0125 - 167.17	3260 - 3267	23.6 - 24.0
12.29 - 12.293	167.72 - 173.2	3332 - 3339	31.2 - 31.8
12.51975 - 12.52025	240 - 285	3345.8 - 3358	36.43 - 36.5
12.57675 - 12.57725	322 - 335.4	3600 - 4400	(²)

- Remark 1. Emission level in dBuV/m=20 log (uV/m)
 : 2. Measurement was performed at an antenna to the closed point of EUT distance of meters.
 3. Only spurious frequency is permitted to locate within the Restricted Bands specified in provision of § 15.205, and the emissions located in restricted bands also comply with 15.209 limit.

7.5 Measurement Result

Below 30MHz:

Operation Mode:	TX	Test Date :	February 02, 2018
Frequency Range:	9KHz~30MHz	Temperature :	28°C
Test Result:	PASS	Humidity :	65 %
Measured Distance:	3m	Test By:	Yaping Shen

Freq. (MHz)	Ant.Pol. H/V	Emission Level (dBuV/m)	Limit 3m (dBuV/m)	Over (dB)
--	--	--	--	--

Note: The low frequency, which started from 9KHz-30MHz, was pre-scanned and the result which was 20dB lower than the limit line per 15.31(o) was not reported.

Below 1000MHz:

Pass.

All the modulation modes were tested the data of the worst mode (GFSK 2402MHz) and scanned by peak detector and QP value is recorded in the following pages and the others modulation methods do not exceed the limits.

Please refer to the following data.

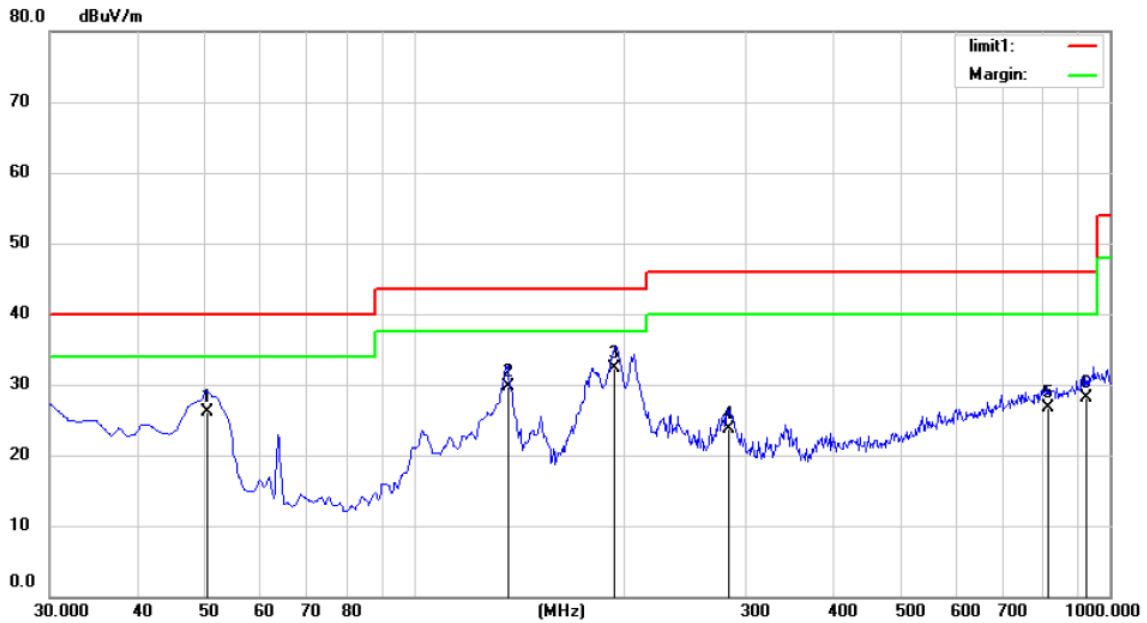

Site Chamber #1 Polarization: **Vertical** Temperature: 25
 Limit: (RE)FCC PART 15 C 3m Power: AC 120V/60Hz Humidity: 55 %
 Mode:DSS(TX2402)
 Note:

No.	Mk.	Freq.	Reading Level	Correct Factor	Measurement	Limit	Over	Antenna Height	Table Degree	Comment
		MHz	dBuV	dB	dBuV/m	dBuV/m	dB	cm	degree	
1		50.3700	41.80	-15.61	26.19	40.00	-13.81	QP		
2		136.7000	49.24	-19.62	29.62	43.50	-13.88	QP		
3	*	193.9300	50.20	-17.82	32.38	43.50	-11.12	QP		
4		282.2000	39.32	-15.62	23.70	46.00	-22.30	QP		
5		815.7000	30.79	-4.09	26.70	46.00	-19.30	QP		
6		923.3700	30.60	-2.44	28.16	46.00	-17.84	QP		

*:Maximum data x:Over limit !:over margin Comment: Factor build in receiver. Operator: Yaping shen

Above 1000MHz~10th Harmonics:

Operation Mode: GFSK (CH1: 2402MHz) Test Date : February 02, 2018

Freq. (MHz)	Ant. Pol. H/V	Emission Level(dBuV/m)		Limit 3m(dBuV/m)		Margin(dB)	
		PK	AV	PK	AV	PK	AV
4804	V	65.92	45.21	74	54	-8.08	-8.79
7206	V	63.44	43.28	74	54	-10.56	-10.72
9608	V	62.14	42.91	74	54	-11.86	-11.09
12010	V	61.29	41.27	74	54	-12.71	-12.73
14412	V	60.48	40.21	74	54	-13.52	-13.79
16814	V	59.25	39.28	74	54	-14.75	-14.72
4804	H	64.28	43.65	74	54	-9.72	-10.35
7206	H	62.94	42.17	74	54	-11.06	-11.83
9608	H	61.28	41.29	74	54	-12.72	-12.71
12010	H	60.48	40.29	74	54	-13.52	-13.71
14412	H	59.27	39.28	74	54	-14.73	-14.72
16814	H	58.67	38.67	74	54	-15.33	-15.33

Operation Mode: GFSK (CH40: 2441MHz) Test Date : February 02, 2018

Freq. (MHz)	Ant. Pol. H/V	Emission Level(dBuV/m)		Limit 3m(dBuV/m)		Margin(dB)	
		PK	AV	PK	AV	PK	AV
4882	V	64.09	44.39	74	54	-9.91	-9.61
7323	V	63.24	43.27	74	54	-10.76	-10.73
9764	V	60.18	40.14	74	54	-13.82	-13.86
12205	V	59.27	39.28	74	54	-14.73	-14.72
14646	V	58.63	38.62	74	54	-15.37	-15.38
17087	V	57.62	37.63	74	54	-16.38	-16.37
4882	H	63.29	43.19	74	54	-10.71	-10.81
7323	H	62.41	42.51	74	54	-11.59	-11.49
9764	H	61.29	41.29	74	54	-12.71	-12.71
12205	H	60.24	40.34	74	54	-13.76	-13.66
14646	H	59.63	39.28	74	54	-14.37	-14.72
17087	H	58.64	38.67	74	54	-15.36	-15.33

Operation Mode: GFSK (CH79: 2480MHz) Test Date : February 02, 2018

Freq. (MHz)	Ant. Pol. H/V	Emission Level(dBuV/m)		Limit 3m(dBuV/m)		Margin(dB)	
		PK	AV	PK	AV	PK	AV
4960	V	64.85	44.29	74	54	-9.15	-9.71
7440	V	61.29	41.36	74	54	-12.71	-12.64
9920	V	60.48	40.27	74	54	-13.52	-13.73
12400	V	59.28	39.2	74	54	-14.72	-14.8
14880	V	58.67	38.65	74	54	-15.33	-15.35
17360	V	57.54	37.54	74	54	-16.46	-16.46
4960	H	56.29	36.2	74	54	-17.71	-17.8
7440	H	63.24	43.95	74	54	-10.76	-10.05
9920	H	62.18	42.14	74	54	-11.82	-11.86
12400	H	61.39	41.27	74	54	-12.61	-12.73
14880	H	60.47	40.32	74	54	-13.53	-13.68
17360	H	59.58	39.28	74	54	-14.42	-14.72

Operation Mode: Pi/4-DQPSK (CH1: 2402MHz) Test Date : February 02, 2018

Freq. (MHz)	Ant. Pol. H/V	Emission Level(dBuV/m)		Limit 3m(dBuV/m)		Over(dB)	
		PK	AV	PK	AV	PK	AV
4804	V	64.09	44.23	74	54	-9.91	-9.77
7206	V	62.58	42.31	74	54	-11.42	-11.69
9608	V	62.41	42.09	74	54	-11.59	-11.91
12010	V	61.27	41.27	74	54	-12.73	-12.73
14412	V	60.48	40.39	74	54	-13.52	-13.61
16814	V	59.28	39.24	74	54	-14.72	-14.76
4804	H	63.79	43.24	74	54	-10.21	-10.76
7206	H	62.45	42.54	74	54	-11.55	-11.46
9608	H	61.39	41.28	74	54	-12.61	-12.72
12010	H	60.48	40.39	74	54	-13.52	-13.61
14412	H	59.25	39.88	74	54	-14.75	-14.12
16814	H	58.67	38.67	74	54	-15.33	-15.33

Operation Mode: Pi/4-DQPSK (CH40: 2441MHz) Test Date : February 02, 2018

Freq. (MHz)	Ant. Pol. H/V	Emission Level(dBuV/m)		Limit 3m(dBuV/m)		Over(dB)	
		PK	AV	PK	AV	PK	AV
4882	V	61.09	41.28	74	54	-12.91	-12.72
7323	V	58.74	38.62	74	54	-15.26	-15.38
9764	V	57.29	37.24	74	54	-16.71	-16.76
12205	V	56.66	36.21	74	54	-17.34	-17.79
14646	V	55.79	35.92	74	54	-18.21	-18.08
17087	V	62.48	42.51	74	54	-11.52	-11.49
4882	H	61.29	41.26	74	54	-12.71	-12.74
7323	H	59.44	39.24	74	54	-14.56	-14.76
9764	H	58.67	38.62	74	54	-15.33	-15.38
12205	H	57.61	37.18	74	54	-16.39	-16.82
14646	H	56.25	36.29	74	54	-17.75	-17.71
17087	H	55.69	35.38	74	54	-18.31	-18.62

Operation Mode: Pi/4-DQPSK (CH79: 2480MHz) Test Date : February 02, 2018

Freq. (MHz)	Ant. Pol. H/V	Emission Level(dBuV/m)		Limit 3m(dBuV/m)		Over(dB)	
		PK	AV	PK	AV	PK	AV
4960	V	63.44	43.28	74	54	-10.56	-10.72
7440	V	62.19	42.08	74	54	-11.81	-11.92
9920	V	61.28	41.39	74	54	-12.72	-12.61
12400	V	60.57	40.27	74	54	-13.43	-13.73
14880	V	59.58	39.28	74	54	-14.42	-14.72
17360	V	58.62	38.64	74	54	-15.38	-15.36
4960	H	62.95	42.17	74	54	-11.05	-11.83
7440	H	61.42	41.28	74	54	-12.58	-12.72
9920	H	60.28	40.29	74	54	-13.72	-13.71
12400	H	59.25	39.28	74	54	-14.75	-14.72
14880	H	58.63	38.62	74	54	-15.37	-15.38
17360	H	57.64	37.49	74	54	-16.36	-16.51

Operation Mode: 8DPSK (CH1: 2402MHz) Test Date : February 02, 2018

Freq. (MHz)	Ant. Pol. H/V	Emission Level(dBuV/m)		Limit 3m(dBuV/m)		Over(dB)	
		PK	AV	PK	AV	PK	AV
4804	V	62.08	42.39	74	54	-11.92	-11.61
7206	V	60.28	40.27	74	54	-13.72	-13.73
9608	V	59.25	39.58	74	54	-14.75	-14.42
12010	V	58.65	38.69	74	54	-15.35	-15.31
14412	V	57.24	37.54	74	54	-16.76	-16.46
16814	V	56.25	36.25	74	54	-17.75	-17.75
4804	H	63.94	43.28	74	54	-10.06	-10.72
7206	H	62.17	42.14	74	54	-11.83	-11.86
9608	H	61.28	41.49	74	54	-12.72	-12.51
12010	H	60.29	40.28	74	54	-13.71	-13.72
14412	H	59.58	39.58	74	54	-14.42	-14.42
16814	H	58.67	38.75	74	54	-15.33	-15.25

Operation Mode: 8DPSK (CH40: 2441MHz) Test Date : February 02, 2018

Freq. (MHz)	Ant. Pol. H/V	Emission Level(dBuV/m)		Limit 3m(dBuV/m)		Over(dB)	
		PK	AV	PK	AV	PK	AV
4882	V	60.92	40.25	74	54	-13.08	-13.75
7323	V	59.25	39.25	74	54	-14.75	-14.75
9764	V	58.64	38.64	74	54	-15.36	-15.36
12205	V	57.36	37.24	74	54	-16.64	-16.76
14646	V	56.25	36.65	74	54	-17.75	-17.35
17087	V	55.94	35.69	74	54	-18.06	-18.31
4882	H	61.94	41.46	74	54	-12.06	-12.54
7323	H	60.25	40.29	74	54	-13.75	-13.71
9764	H	59.38	39.28	74	54	-14.62	-14.72
12205	H	58.67	38.67	74	54	-15.33	-15.33
14646	H	59.27	39.28	74	54	-14.73	-14.72
17087	H	57.24	37.65	74	54	-16.76	-16.35

Operation Mode: 8DPSK (CH79: 2480MHz) Test Date : February 02, 2018

Freq. (MHz)	Ant. Pol. H/V	Emission Level(dBuV/m)		Limit 3m(dBuV/m)		Over(dB)	
		PK	AV	PK	AV	PK	AV
4960	V	63.91	43.29	74	54	-10.09	-10.71
7440	V	62.14	42.14	74	54	-11.86	-11.86
9920	V	61.28	41.93	74	54	-12.72	-12.07
12400	V	60.28	40.34	74	54	-13.72	-13.66
14880	V	59.25	39.58	74	54	-14.75	-14.42
17360	V	64.24	44.22	74	54	-9.76	-9.78
4960	H	63.12	43.65	74	54	-10.88	-10.35
7440	H	60.29	40.15	74	54	-13.71	-13.85
9920	H	59.25	39.65	74	54	-14.75	-14.35
12400	H	58.63	38.25	74	54	-15.37	-15.75
14880	H	57.58	37.25	74	54	-16.42	-16.75
17360	H	56.28	36.94	74	54	-17.72	-17.06

Other harmonics emissions are lower than 20dB below the allowable limit.

- Note:**
- (1) All Readings are Peak Value and AV.
 - (2) Emission Level= Reading Level+ Probe Factor +Cable Loss.
 - (3) The average measurement was not performed when the peak measured data under the limit of average detection.
 - (4) Measuring frequencies from 1GHz to 25GHz.
 - (5) This measurement used by GQ24-120250-AU.

7.6 Radiated Measurement Photos:

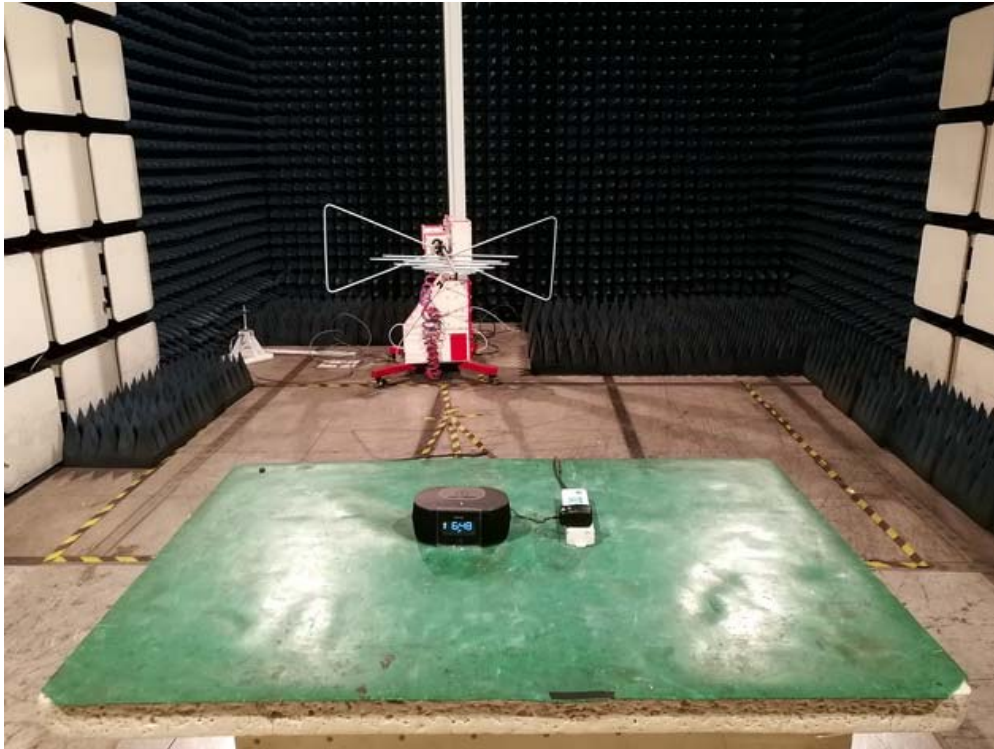

8. Channel Separation test

8.1 Measurement Procedure

The EUT was operating in hopping mode or could be controlled its channel. Printed out the test result from the spectrum by hard copy function.

8.2 Test SET-UP (Block Diagram of Configuration)

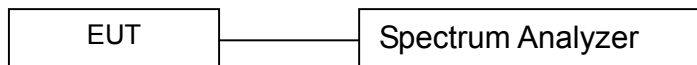

8.3 Measurement Equipment Used:

EQUIPMENT TYPE	MFR	MODEL NUMBER	SERIAL NUMBER	Characteristics	LAST CAL.	CAL DUE.
Spectrum Analyzer	Rohde & Schwarz	FSV30	1321.3008K	10Hz-30GHz	05/16/2017	05/15/2018
Coaxial Cable	CDS	79254	46107086	10Hz-30GHz	05/16/2017	05/15/2018
Antenna Connector	ARTHUR-YANG	2244-N1TG1	N/A	10Hz-30GHz	05/16/2017	05/15/2018

Remark: The temporary antenna connector is soldered on the PCB board in order to perform conducted tests and this temporary antenna connector is listed in the equipment list.

8.4 Measurement Results:

Refer to attached data chart.

Spectrum Detector: PK Test Date : February 01, 2018
 Test By: Yaping Shen Temperature : 24°C
 Test Result: PASS Humidity : 53 %
 Modulation: GFSK

Channel number	Channel frequency (MHz)	Separation Read Value (kHz)	Separation Limit 2/3 20dB Down BW(kHz)
1	2402	999	>755
40	2441	1003	>753
79	2480	999	>750



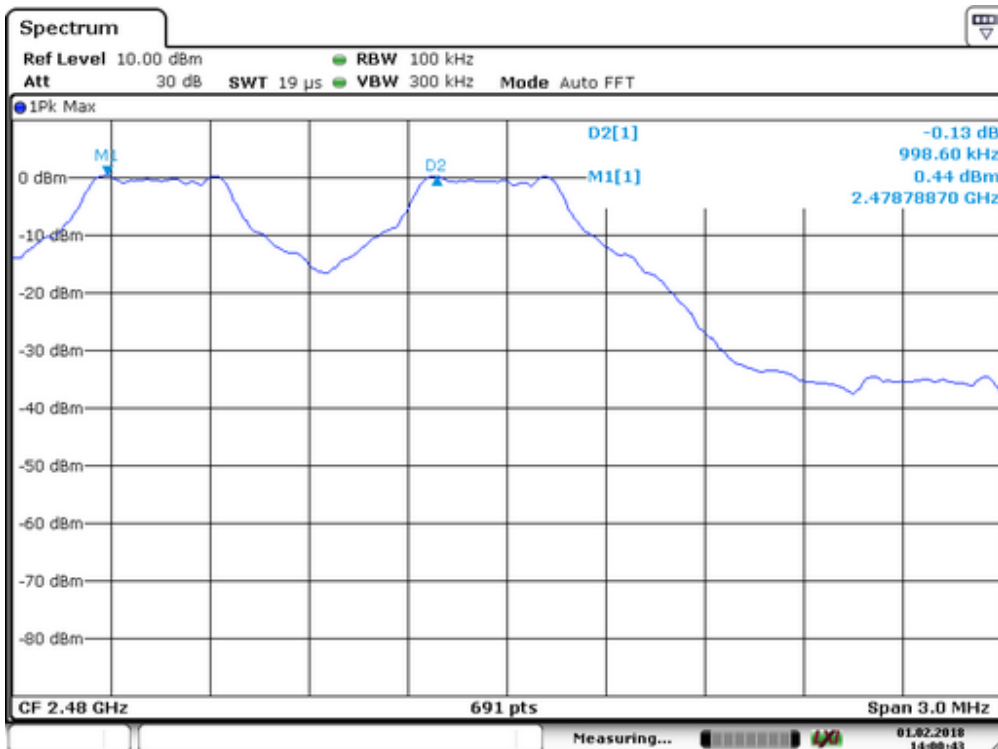
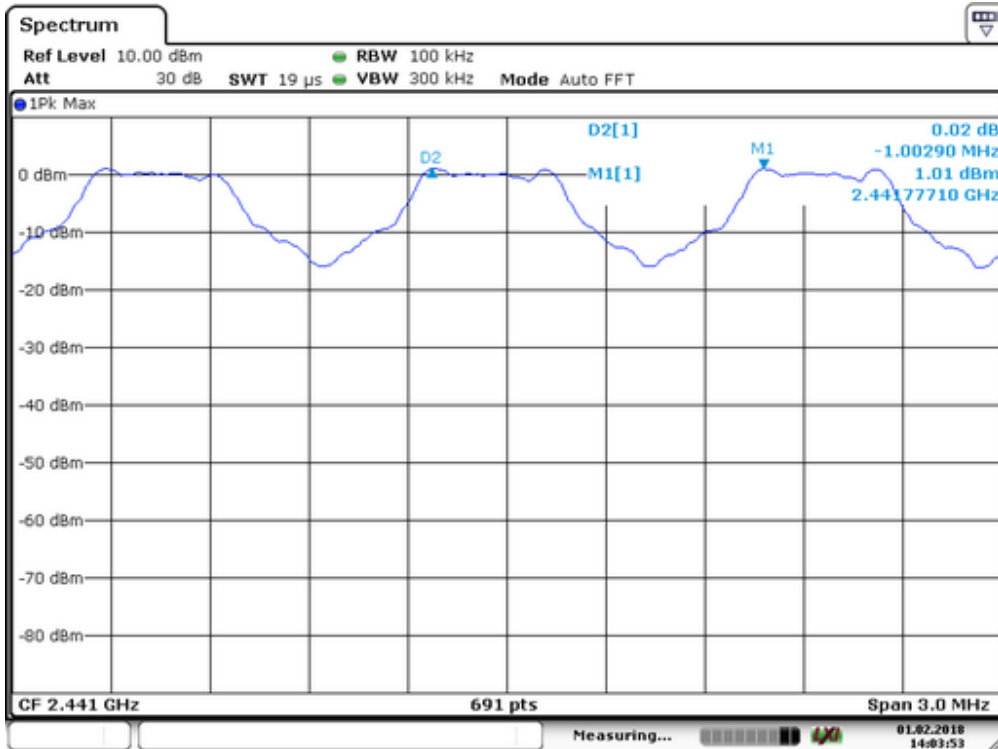

Spectrum Detector: PK	Test Date : February 01, 2018
Test By: Yaping Shen	Temperature : 24°C
Test Result: PASS	Humidity : 53 %
Modulation: Π/4-DQPSK	

Channel number	Channel frequency (MHz)	Separation Read Value (kHz)	Separation Limit 2/3 20dB Down BW(kHz)
1	2402	999	>923
40	2441	1003	>926
79	2480	1003	>926

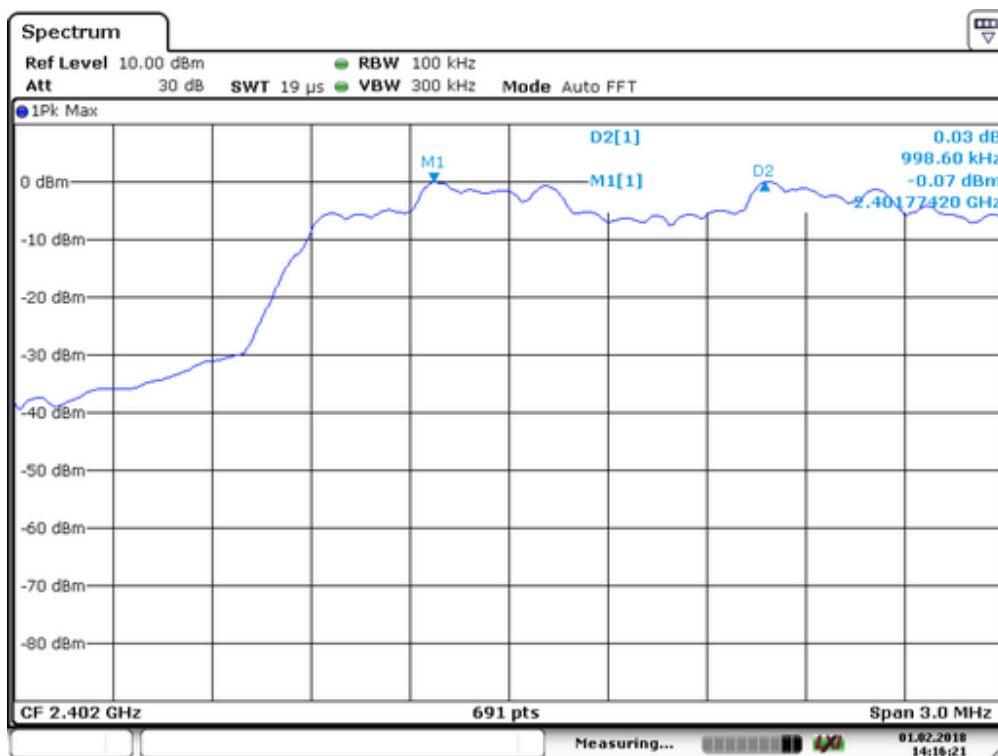

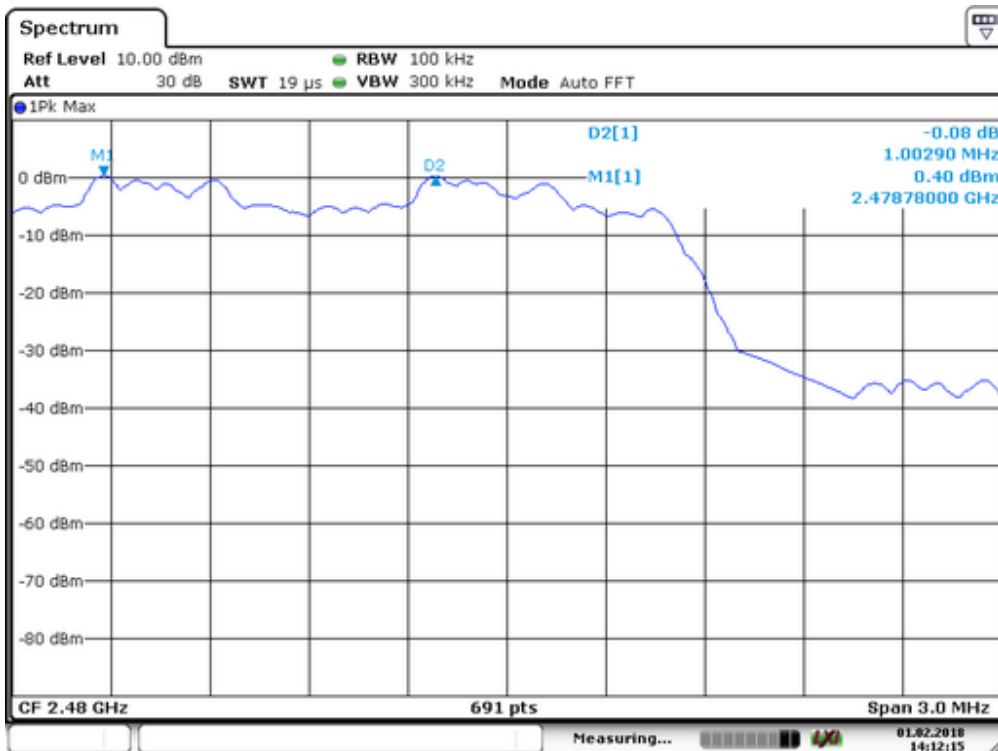
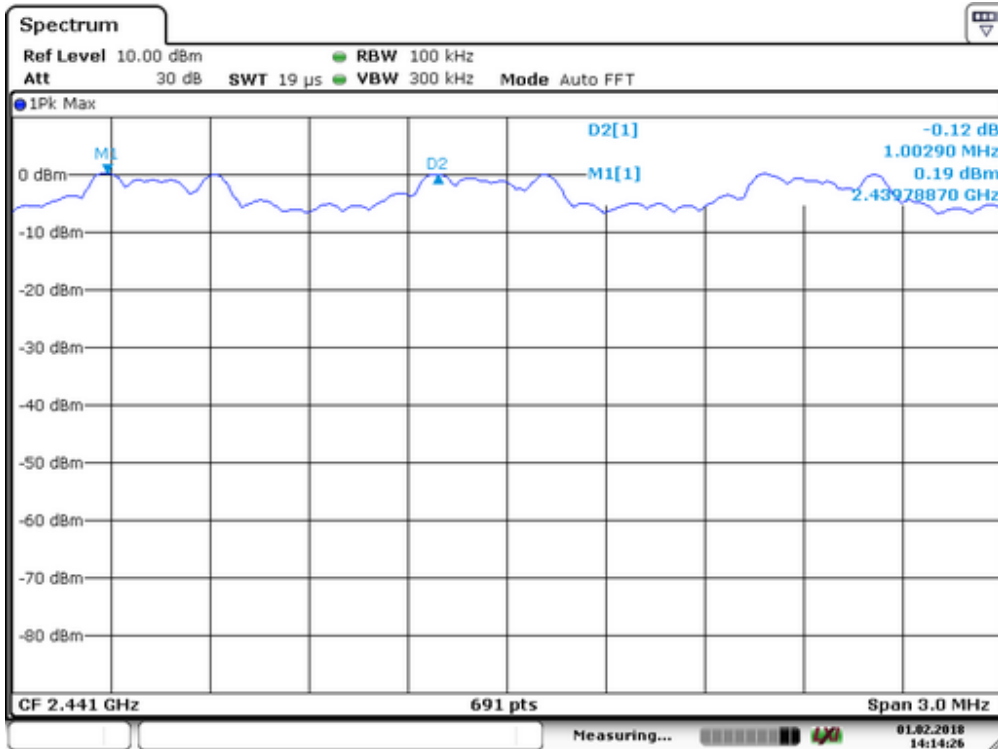

Spectrum Detector: PK	Test Date : February 01, 2018
Test By: Yaping Shen	Temperature : 24°C
Test Result: PASS	Humidity : 53 %
Modulation: 8DPSK	

Channel number	Channel frequency (MHz)	Separation Read Value (kHz)	Separation Limit 2/3 20dB Down BW(kHz)
1	2402	999	>947
40	2441	999	>949
79	2480	999	>947

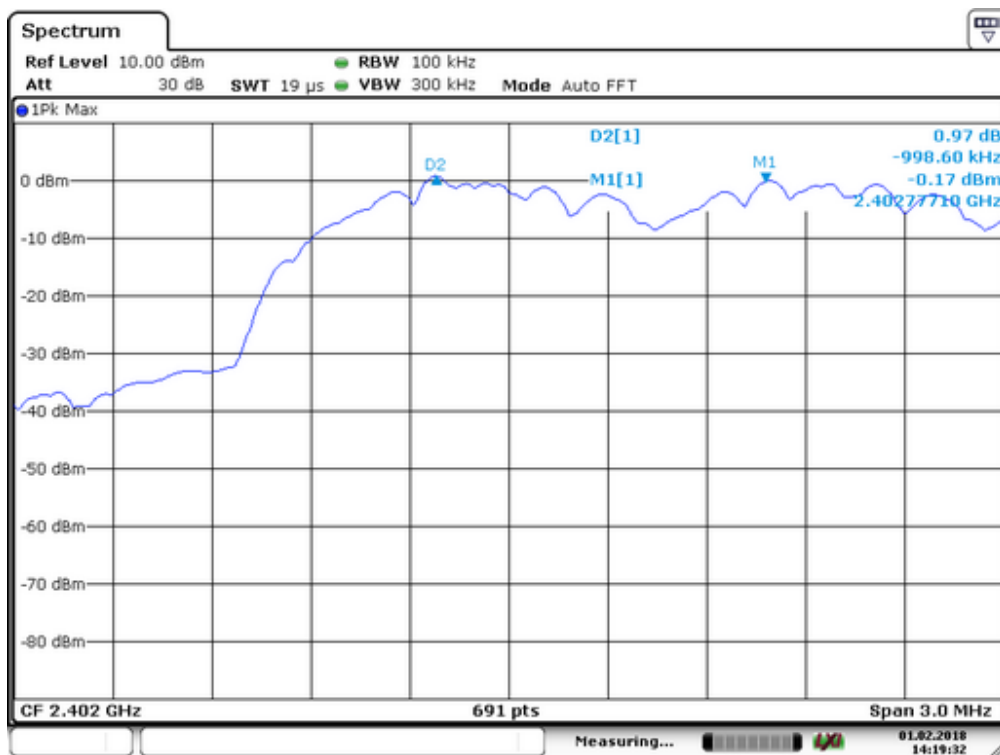

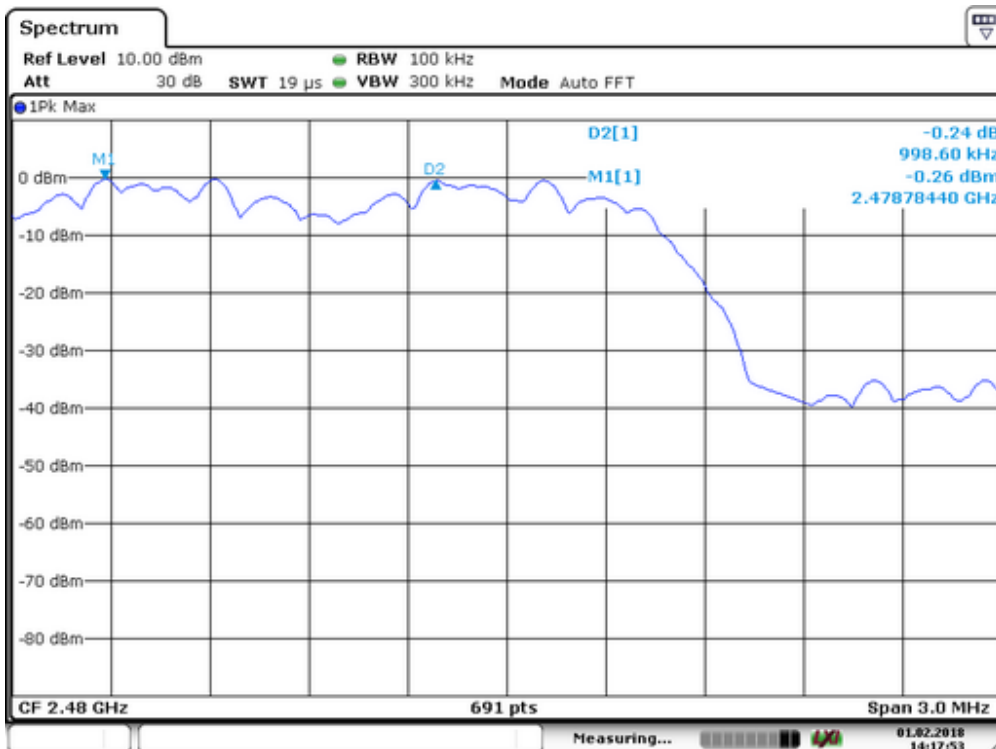
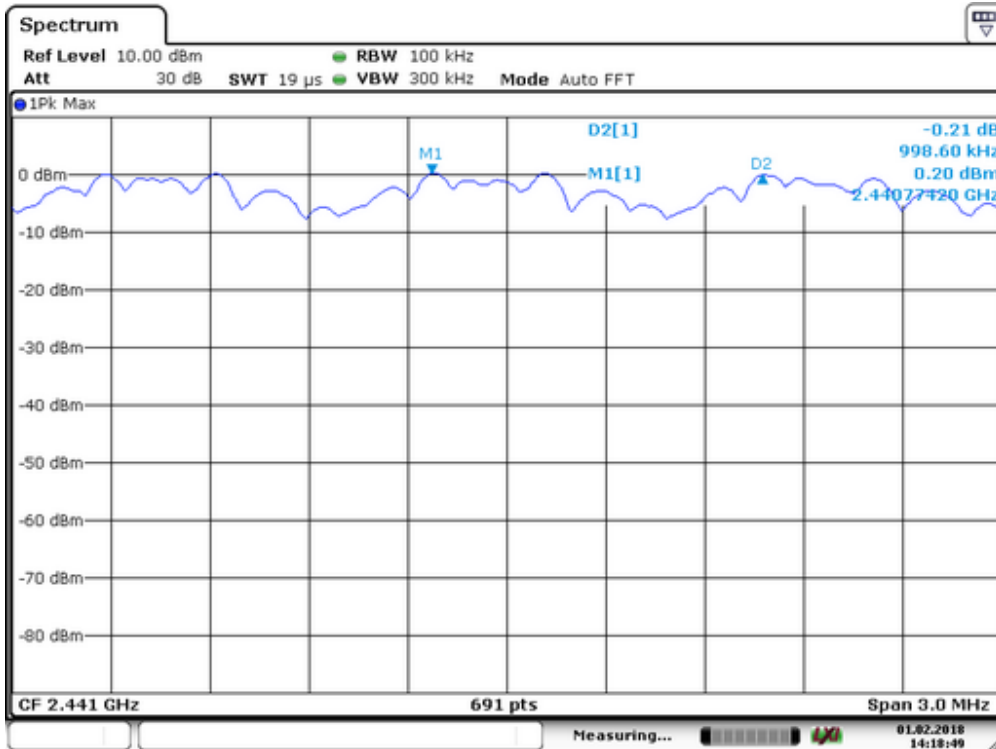

9. 20dB Bandwidth test

9.1 Measurement Procedure

The EUT was operating in hopping mode or could be controlled its channel. Printed out the test result from the spectrum by hard copy function.

9.2 Test SET-UP (Block Diagram of Configuration)

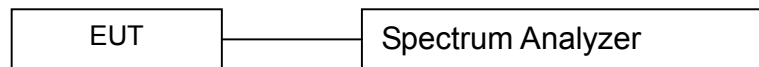

9.3 Measurement Equipment Used:

EQUIPMENT TYPE	MFR	MODEL NUMBER	SERIAL NUMBER	Characteristics	LAST CAL.	CAL DUE.
Spectrum Analyzer	Rohde & Schwarz	FSV30	1321.3008K	10Hz-30GHz	05/16/2017	05/15/2018
Coaxial Cable	CDS	79254	46107086	10Hz-30GHz	05/16/2017	05/15/2018
Antenna Connector	ARTHUR-YANG	2244-N1TG1	N/A	10Hz-30GHz	05/16/2017	05/15/2018

Remark: The temporary antenna connector is soldered on the PCB board in order to perform conducted tests and this temporary antenna connector is listed in the equipment list.

9.4 Measurement Results:

Refer to attached data chart.

Spectrum Detector: PK Test Date : February 01, 2018
 Test By: Yaping Shen Temperature : 24°C
 Test Result: PASS Humidity : 53 %
 Modulation: GFSK

Channel number	Channel frequency (MHz)	20dB Down BW(kHz)
1	2402	1133
40	2441	1129
79	2480	1125

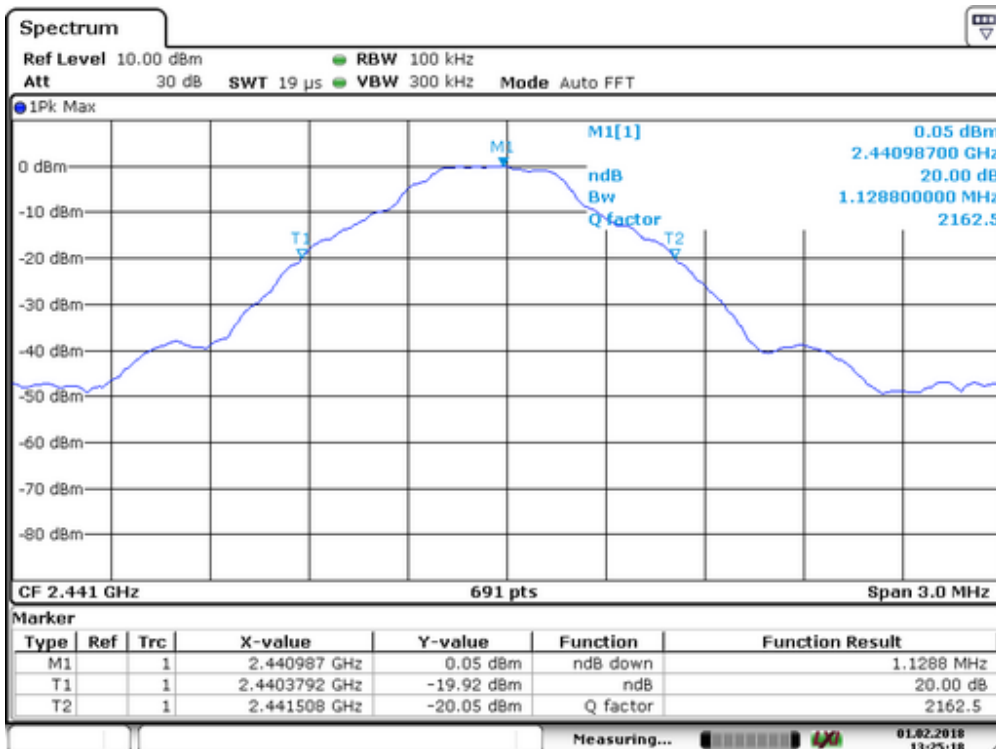
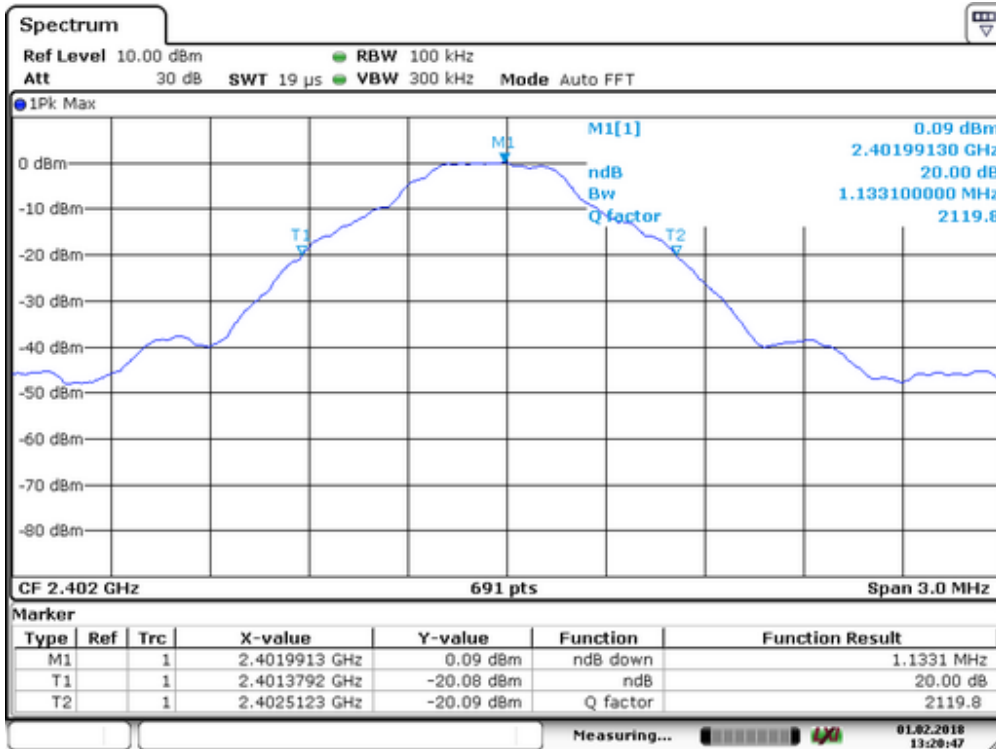

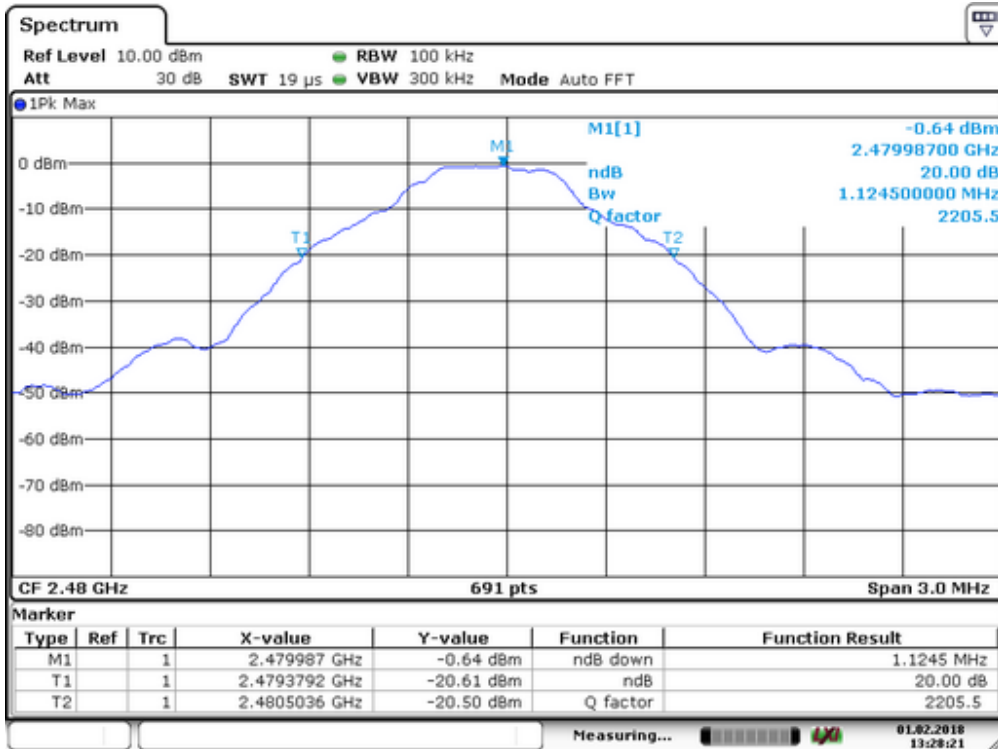

Spectrum Detector: PK Test Date : February 01, 2018
 Test By: Yaping Shen Temperature : 24°C
 Test Result: PASS Humidity : 53 %
 Modulation: Π/4-DQPSK

Channel number	Channel frequency (MHz)	20dB Down BW(kHz)
1	2402	1385
40	2441	1389
79	2480	1389

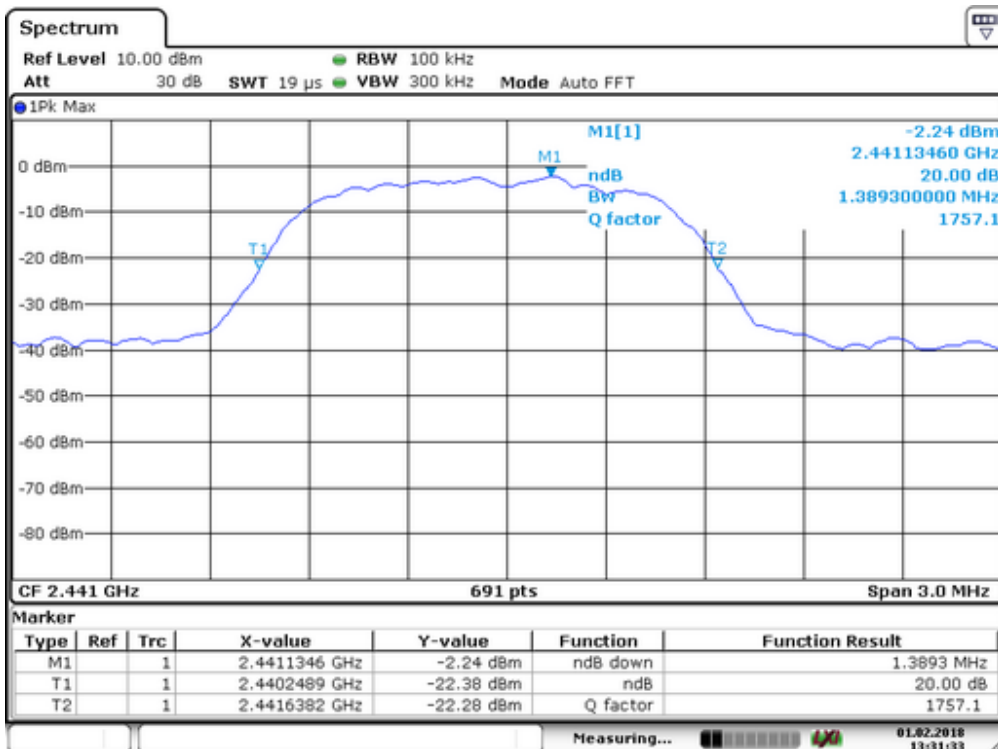
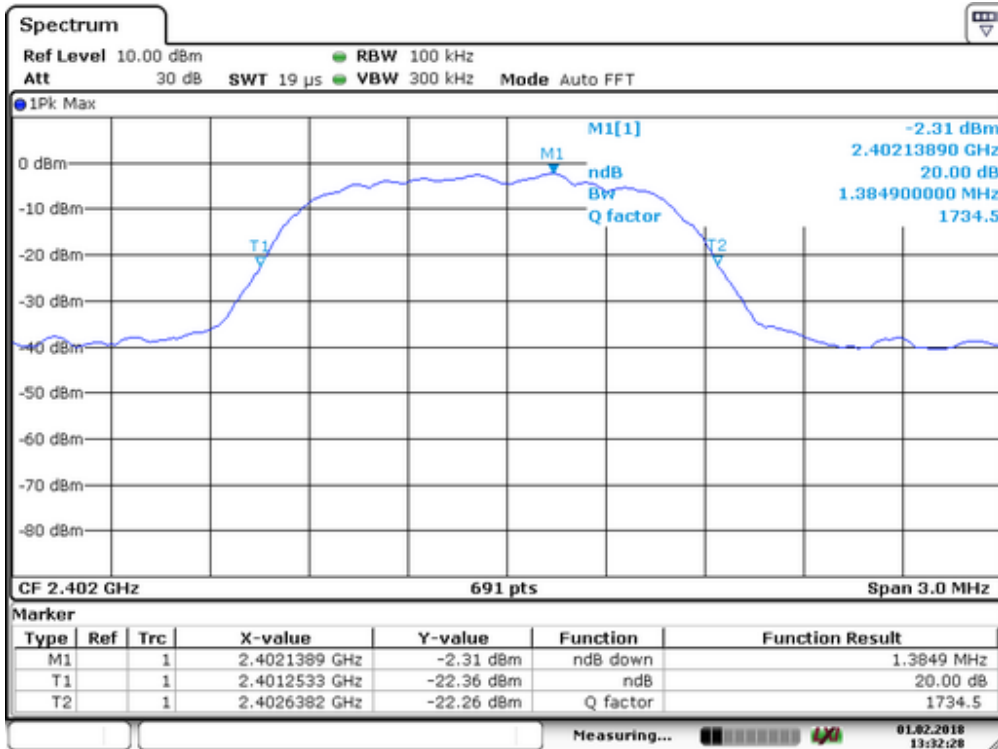

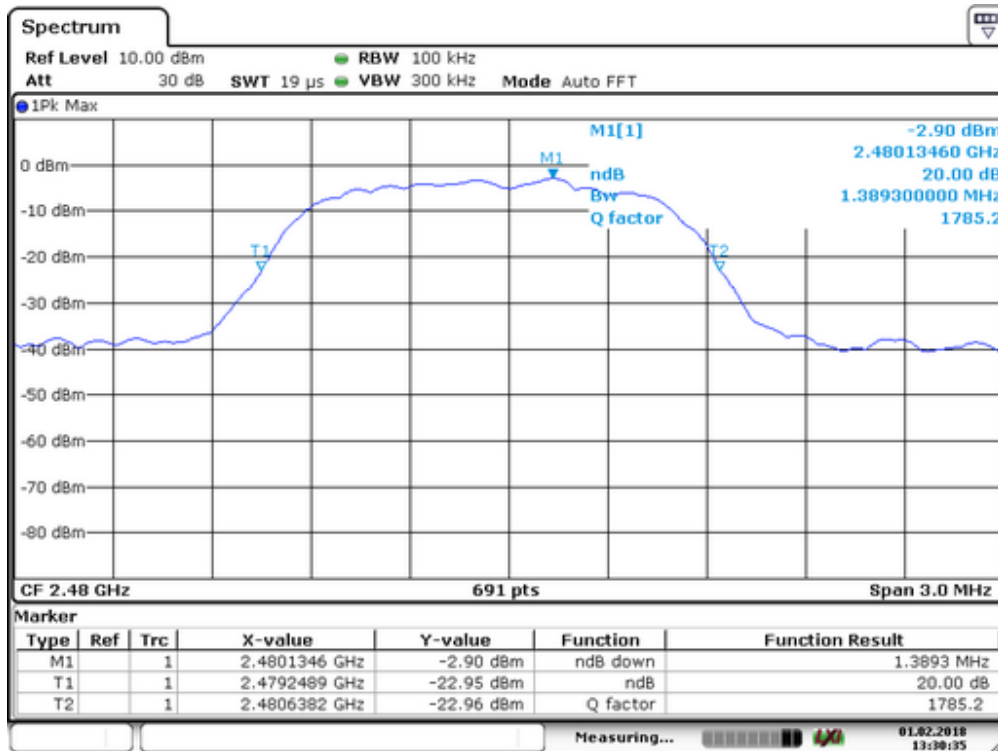

Spectrum Detector: PK Test Date : February 01, 2018
 Test By: Yaping Shen Temperature : 24°C
 Test Result: PASS Humidity : 53 %
 Modulation: 8DPSK

Channel number	Channel frequency (MHz)	20dB Down BW(kHz)
1	2402	1420
40	2441	1424
79	2480	1420

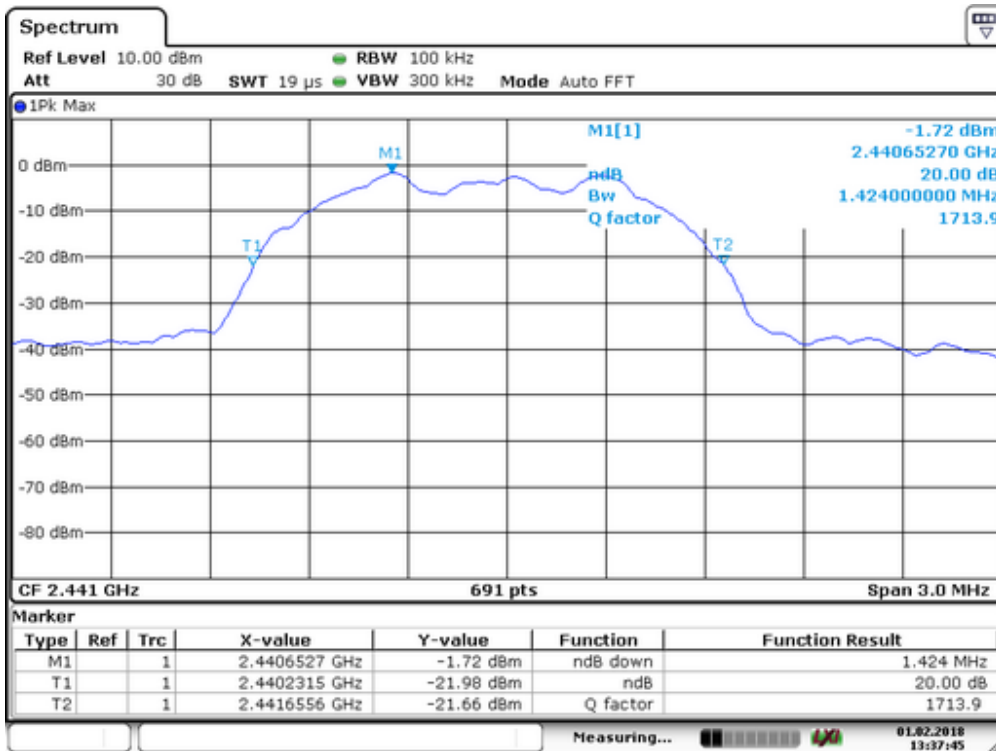
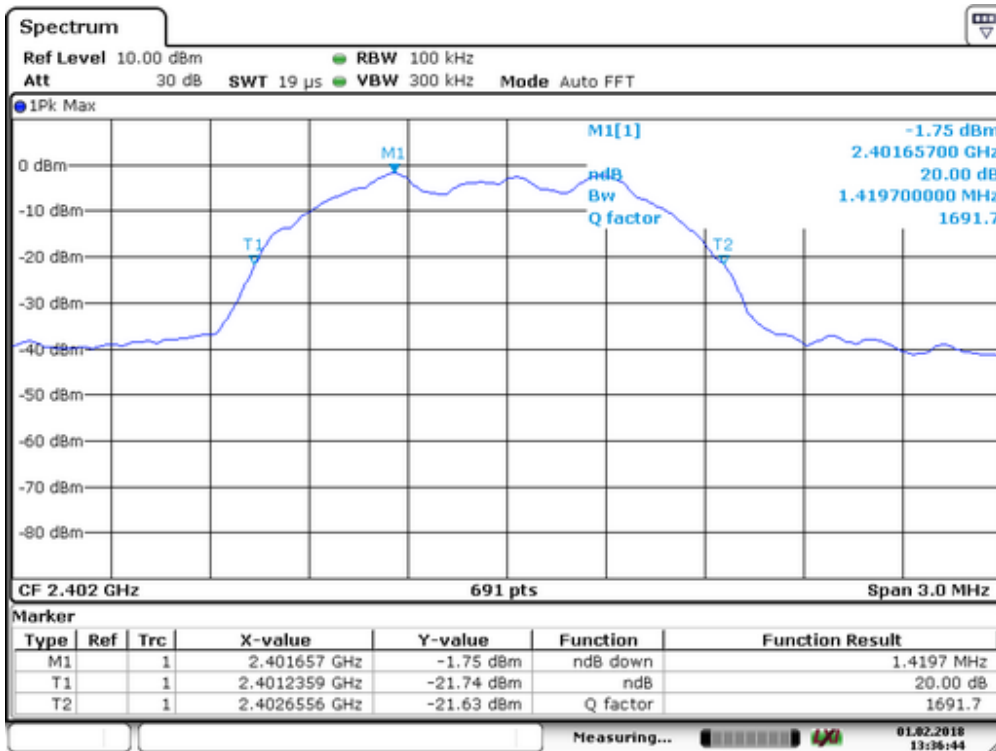

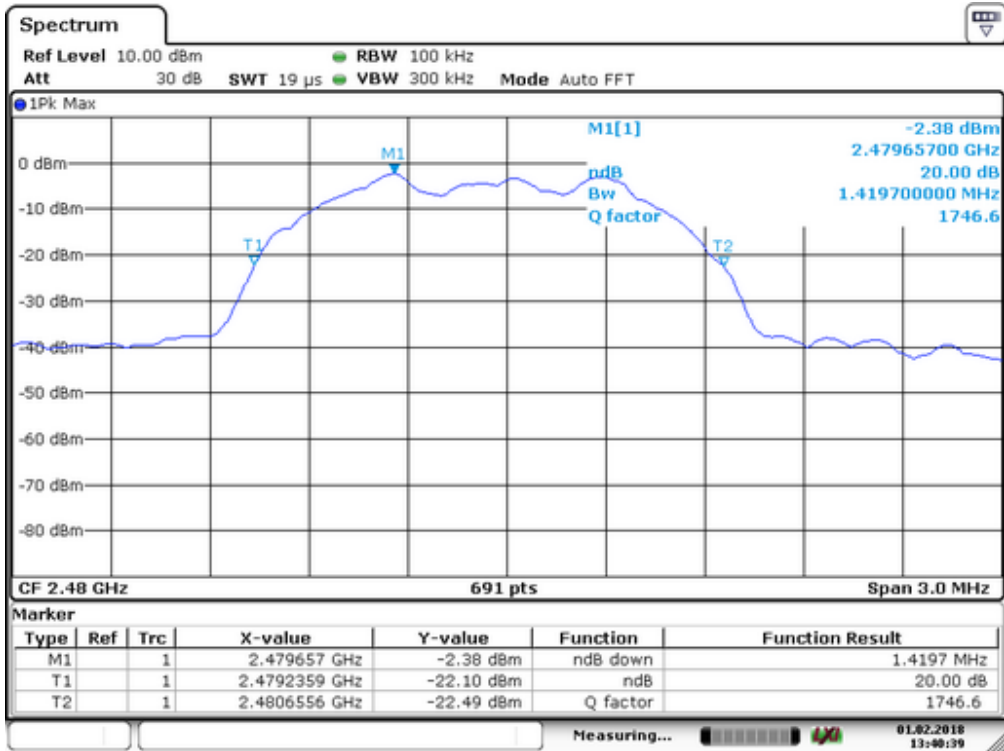

10. Quantity of Hopping Channel Test

10.1 Measurement Procedure

The EUT was operating in hopping mode or could be controlled its channel. Printed out the test result from the spectrum by hard copy function.

10.2 Test SET-UP (Block Diagram of Configuration)

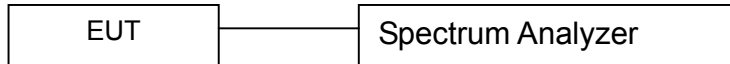

10.3 Measurement Equipment Used:

EQUIPMENT TYPE	MFR	MODEL NUMBER	SERIAL NUMBER	Characteristics	LAST CAL.	CAL DUE.
Spectrum Analyzer	Rohde & Schwarz	FSV30	1321.3008K	10Hz-30GHz	05/16/2017	05/15/2018
Coaxial Cable	CDS	79254	46107086	10Hz-30GHz	05/16/2017	05/15/2018
Antenna Connector	ARTHUR-YANG	2244-N1TG1	N/A	10Hz-30GHz	05/16/2017	05/15/2018

Remark: The temporary antenna connector is soldered on the PCB board in order to perform conducted tests and this temporary antenna connector is listed in the equipment list.

10.4 Measurement Results:

Refer to attached data chart.

Worst Test Mode	GFSK	Test Date :	February 01, 2018
Test By:	Yaping Shen	Temperature :	25 °C
Test Result:	PASS	Humidity :	50 %

Hopping Channel Frequency Range	Quantity of Hopping Channel	Quantity of Hopping Channel
2402-2480	79	> 15

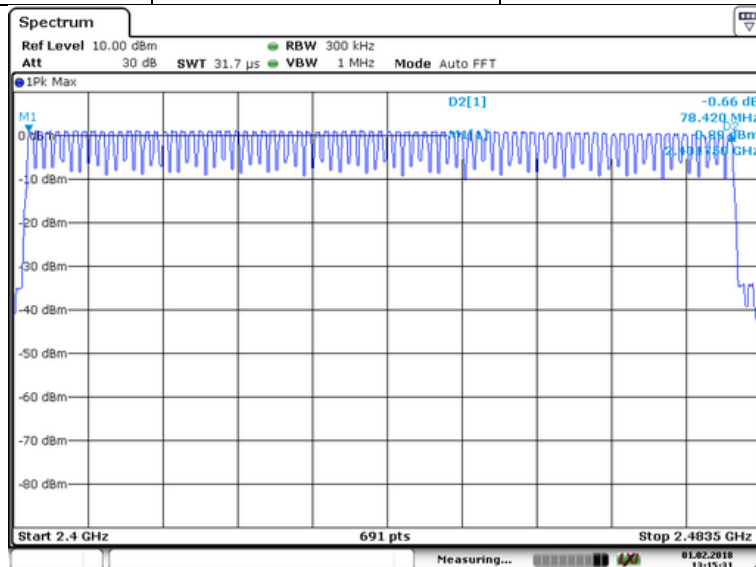

11. Time of Occupancy (Dwell Time) test

11.1 Test Description

The Equipment Under Test (EUT) was set up to perform the dwell time measurements. The EUT was connected to the spectrum analyzer via a short coax cable. The dwell time is calculated by:

$$\text{Dwell time} = \text{time slot length} * \text{hop rate} / \text{number of hopping channels} * 31.6\text{s}$$

with:

- hop rate = $1600 * 1/\text{s}$ for DH1 packets = 1600 s^{-1}
- hop rate = $1600/3 * 1/\text{s}$ for DH3 packets = 533.33 s^{-1}
- number of hopping channels = 79
- $31.6 \text{ s} = 0.4 \text{ seconds}$ multiplied by the number of hopping channels = $0.4 \text{ s} * 79$

The highest value of the dwell time is reported.

11.2 Test SET-UP (Block Diagram of Configuration)

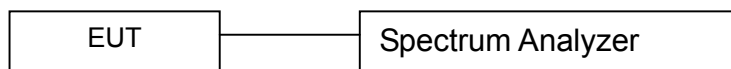

11.3 Measurement Equipment Used:

EQUIPMENT TYPE	MFR	MODEL NUMBER	SERIAL NUMBER	Characteristics	LAST CAL.	CAL DUE.
Spectrum Analyzer	Rohde & Schwarz	FSV30	1321.3008K	10Hz-30GHz	05/16/2017	05/15/2018
Coaxial Cable	CDS	79254	46107086	10Hz-30GHz	05/16/2017	05/15/2018
Antenna Connector	ARTHUR-YANG	2244-N1TG1	N/A	10Hz-30GHz	05/16/2017	05/15/2018

Remark: The temporary antenna connector is soldered on the PCB board in order to perform conducted tests and this temporary antenna connector is listed in the equipment list.

11.4 Test Requirements / Limits

FCC Part 15, Subpart C, §15.247 (a) (1) (iii)

Frequency hopping systems in the 2400-2483.5 MHz band shall use at least 15 channels. The average time of occupancy on any channel shall not be greater than 0.4 seconds within a period of 0.4 seconds multiplied by the number of hopping channels employed. Since the Bluetooth technology uses 79 channels this period is calculated to be 31.6seconds. Refer to attached data chart.

11.5 Test result

Modulation: GFSK Test Date : January 11, 2018
 Test By: Yaping Shen Temperature : 25 °C
 Test Result: PASS Humidity : 50 %

Mode	Number of transmission in a 31.6(79 Hopping*0.4)	Length of transmissions time(msec)	Result (msec)	Limit (msec)
DH1	$1600/(2*79) \times 31.6 = 320$	0.370	118.4	400
DH3	$1600/(4*79) \times 31.6 = 160$	1.635	261.6	400
DH5	$1600/(6*79) \times 31.6 = 106.67$	2.891	308.38	400

Remark: The results of worst cased was recorded.

DH1:

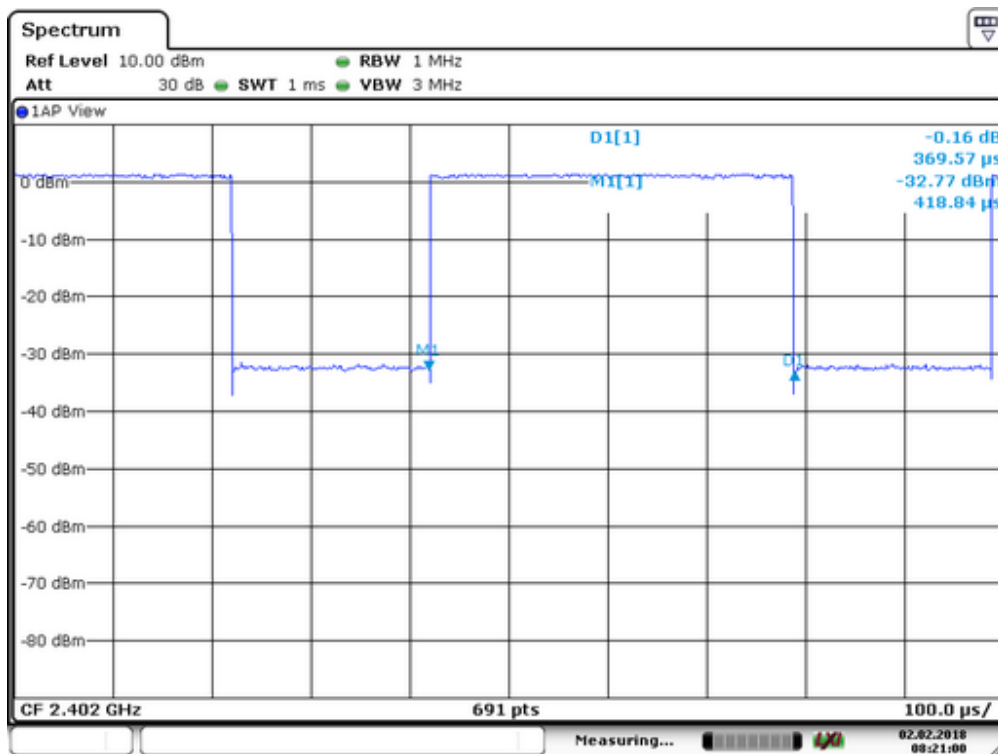

DH3:

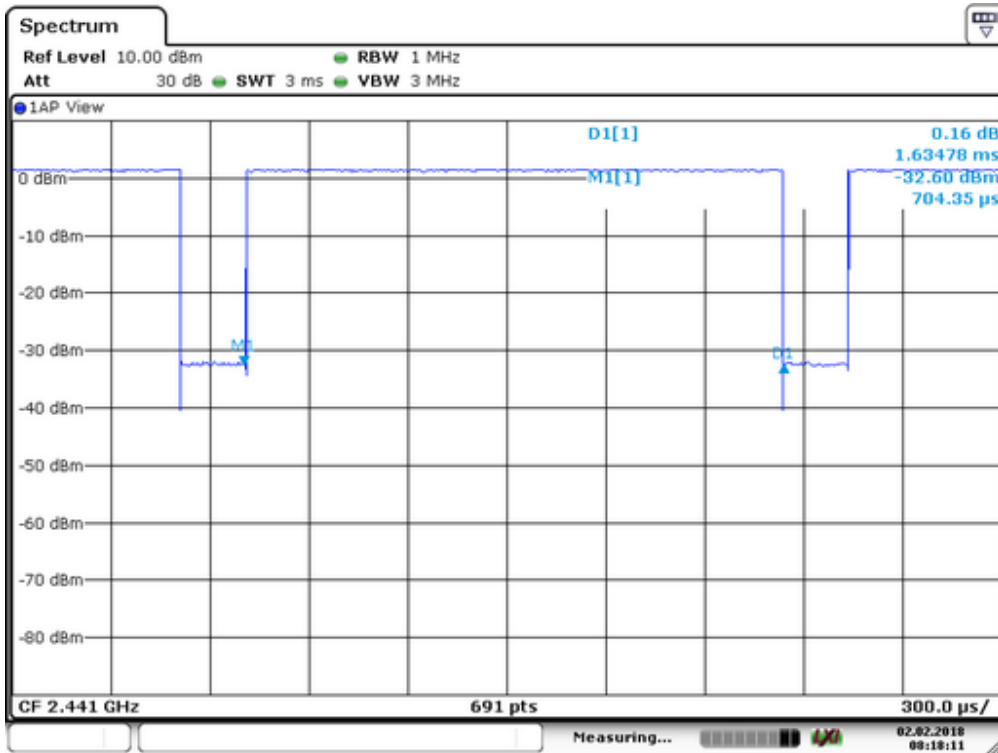

DH5:

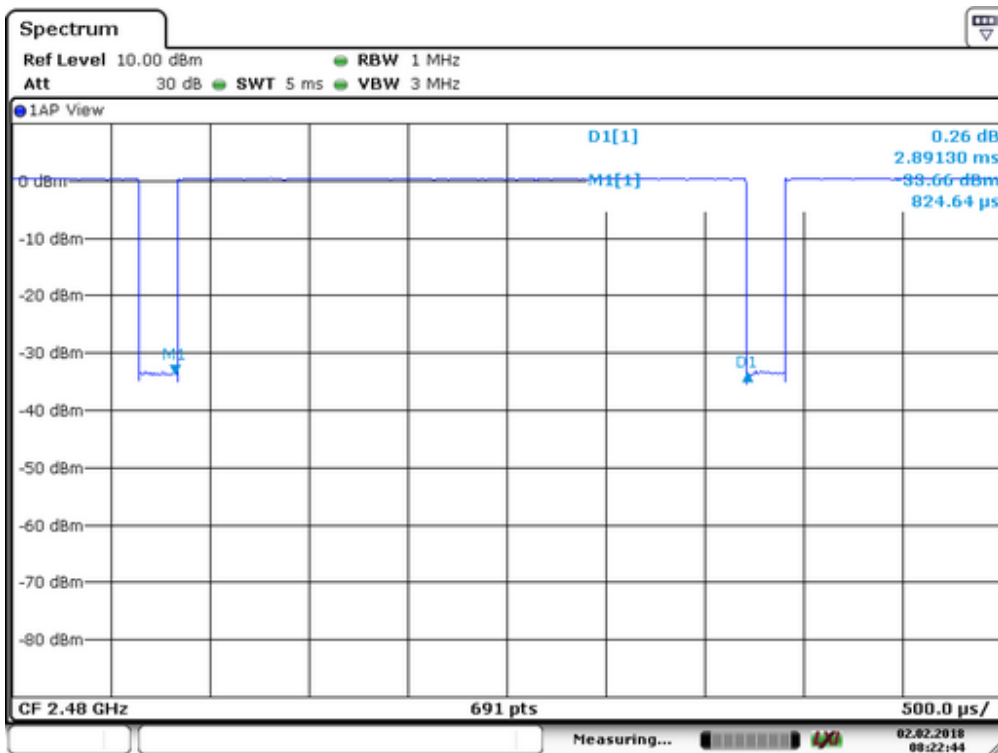

12. MAXIMUM PEAK OUTPUT POWER TEST

12.1 Measurement Procedure

- a. Check the calibration of the measuring instrument(SA) using either an internal calibrator or a known signal from an external generator.
- b. Turn on the EUT and connect it to measurement instrument. Then set it to any one convenient frequency within its operating range. Set a reference level on the measuring instrument equal to the highest peak value.
- c. The center frequency of the spectrum analyzer is set to the fundamental frequency and using proper RBW and VBW setting.
- d. Measure the captured power within the band and recording the plot.
- e. Repeat above procedures until all frequencies required were complete.

12.2 Test SET-UP (Block Diagram of Configuration)

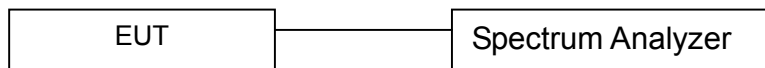

12.3 Measurement Equipment Used:

EQUIPMENT TYPE	MFR	MODEL NUMBER	SERIAL NUMBER	Characteristics	LAST CAL.	CAL DUE.
Spectrum Analyzer	Rohde & Schwarz	FSV30	1321.3008K	10Hz-30GHz	05/16/2017	05/15/2018
Coaxial Cable	CDS	79254	46107086	10Hz-30GHz	05/16/2017	05/15/2018
Antenna Connector	ARTHUR-YANG	2244-N1TG1	N/A	10Hz-30GHz	05/16/2017	05/15/2018

Remark: The temporary antenna connector is soldered on the PCB board in order to perform conducted tests and this temporary antenna connector is listed in the equipment list.

12.4 Measurement Results:

Refer to attached data chart.

Spectrum Detector:	PK	Test Date :	February 02, 2018
Test By:	Yaping Shen	Temperature :	25 °C
Test Result:	PASS	Humidity :	50 %
Modulation:	GFSK		

Channel number	Channel Frequency (MHz)	Peak Power output(dBm)	Peak Power output(mW)	Peak Power Limit(mW)	Pass/Fail
01	2402	2.95	1.972	1000	PASS
40	2441	2.85	1.928	1000	PASS
79	2480	2.09	1.618	1000	PASS

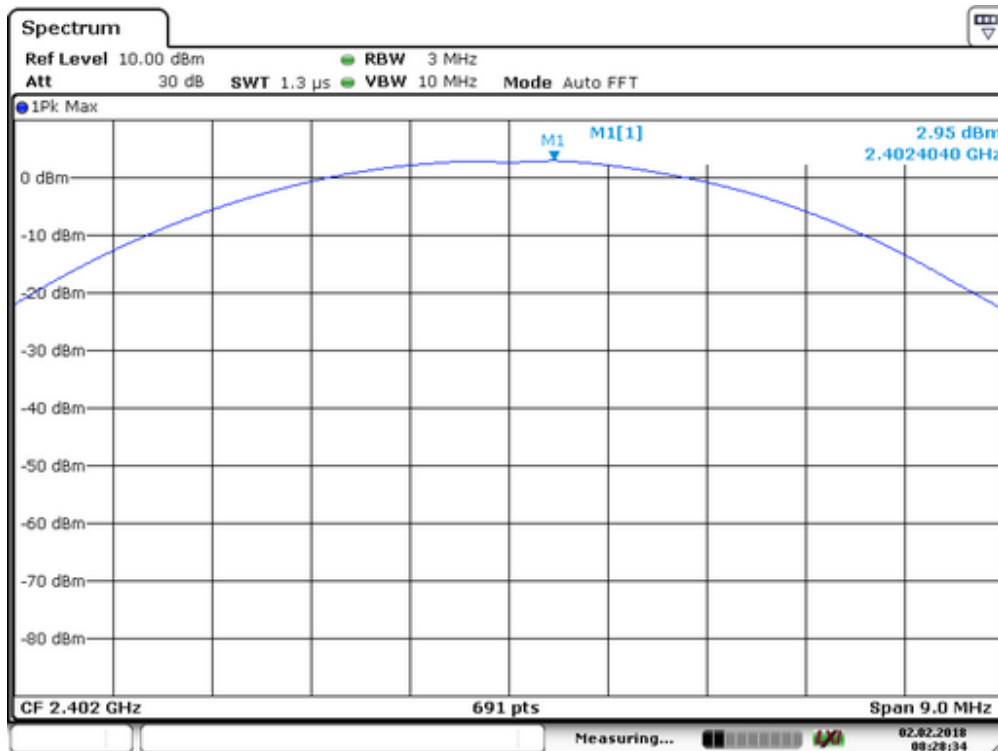

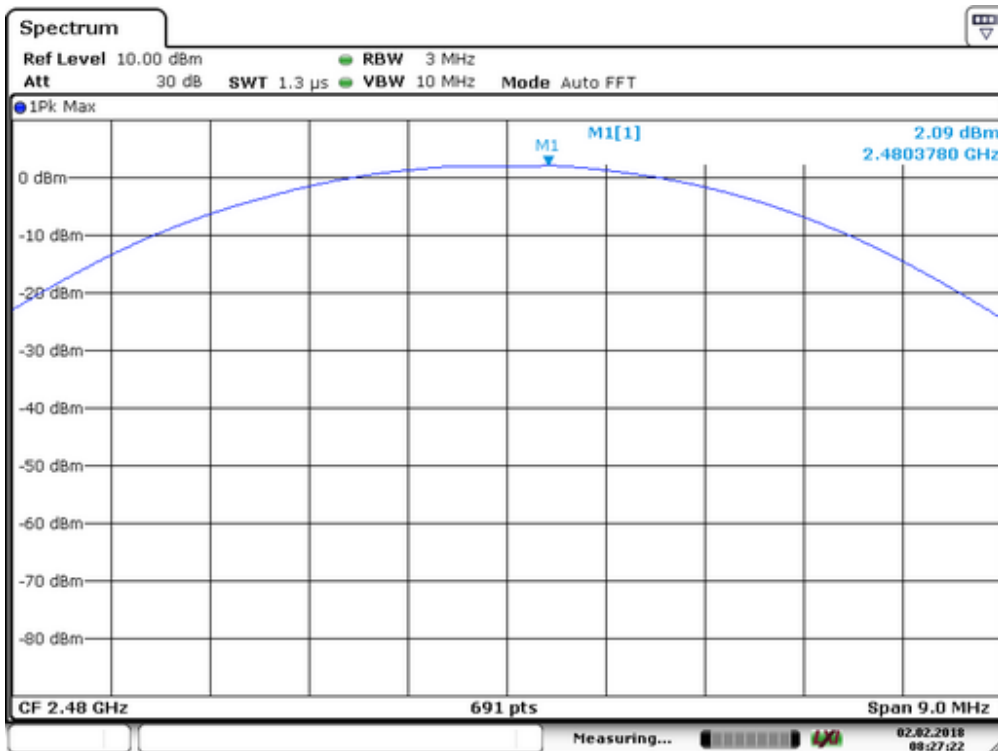
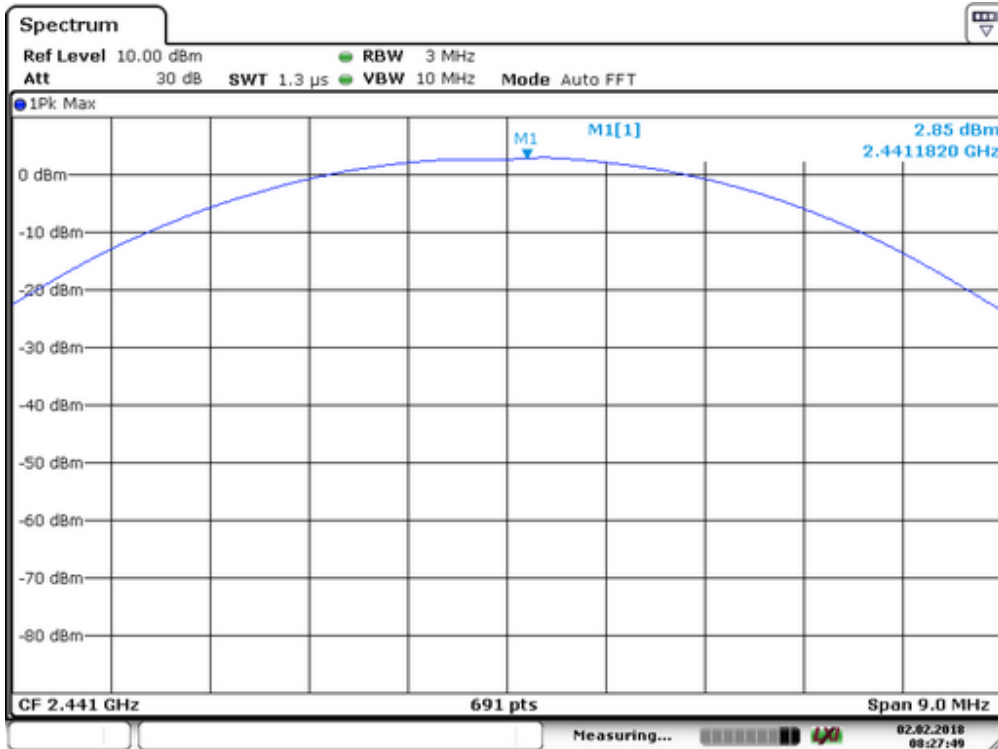

Spectrum Detector: PK Test Date : February 02, 2018
 Test By: Yaping Shen Temperature : 25 °C
 Test Result: PASS Humidity : 50 %
 Modulation: Π/4-DQPSK

Channel number	Channel Frequency (MHz)	Peak Power output(dBm)	Peak Power output(mW)	Peak Power Limit(mW)	Pass/Fail
01	2402	2.72	1.871	125	PASS
40	2441	2.79	1.901	125	PASS
79	2480	1.79	1.510	125	PASS

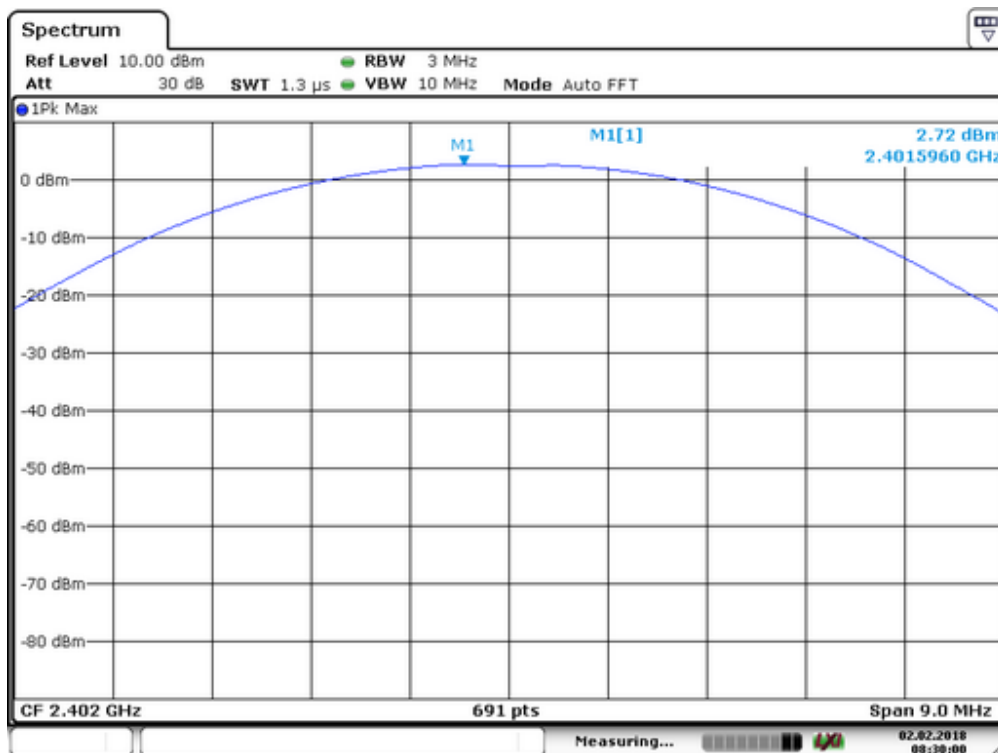

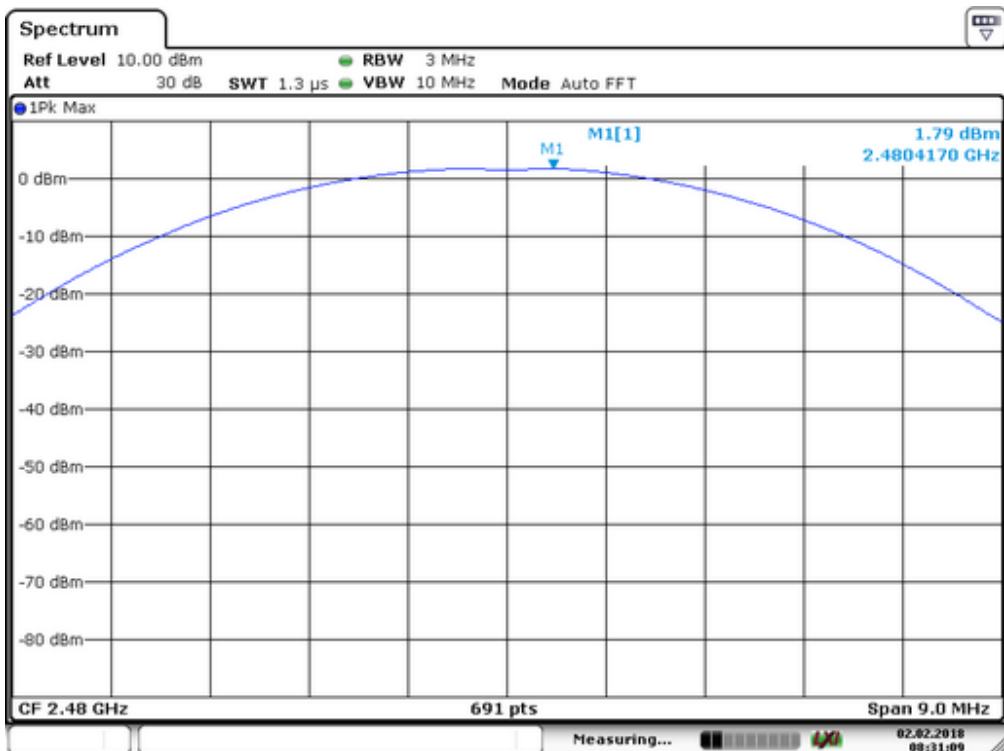
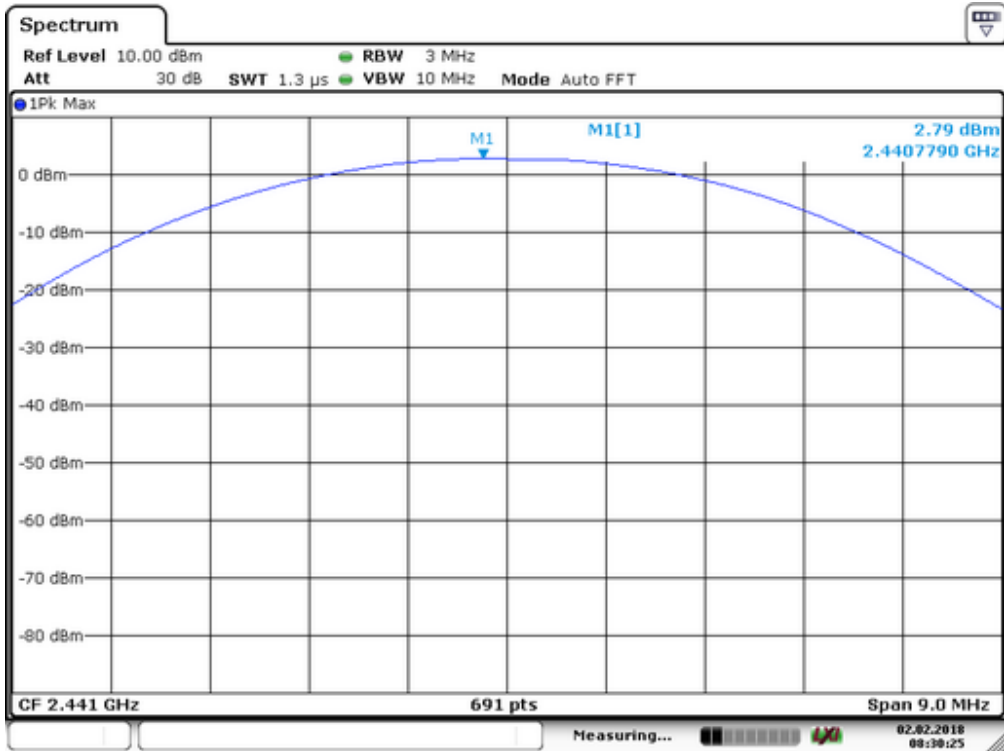

Spectrum Detector: PK Test Date : February 02, 2018
 Test By: Yaping Shen Temperature : 25 °C
 Test Result: PASS Humidity : 50 %
 Modulation: 8DPSK

Channel number	Channel Frequency (MHz)	Peak Power output(dBm)	Peak Power output(mW)	Peak Power Limit(mW)	Pass/Fail
01	2402	1.38	1.374	125	PASS
40	2441	1.37	1.371	125	PASS
79	2480	0.46	1.112	125	PASS

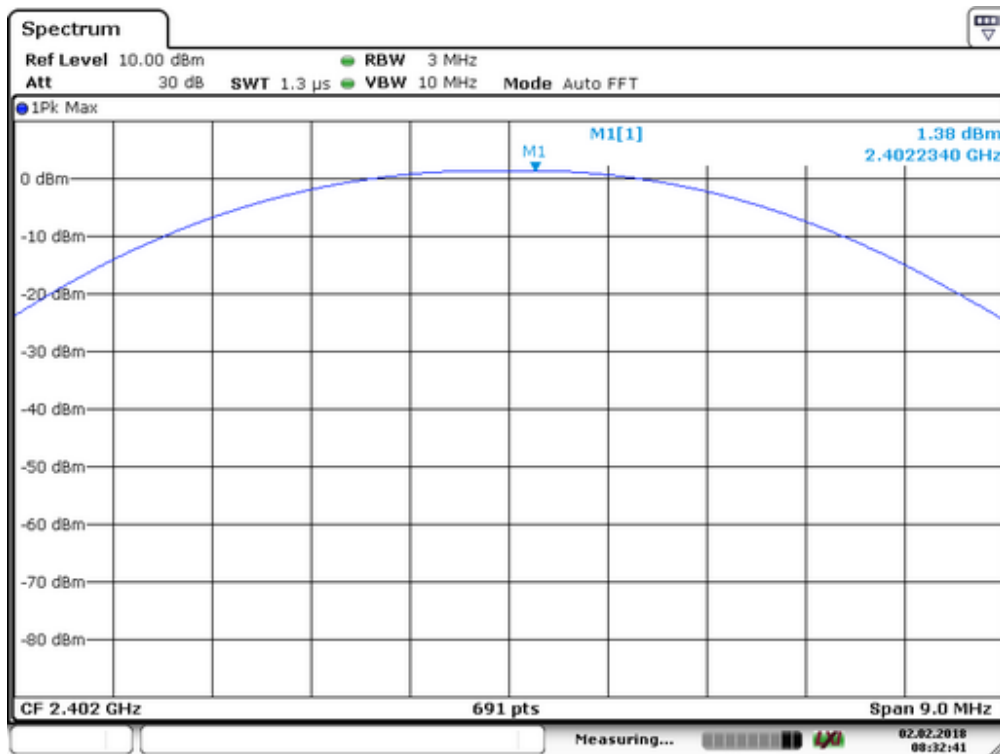

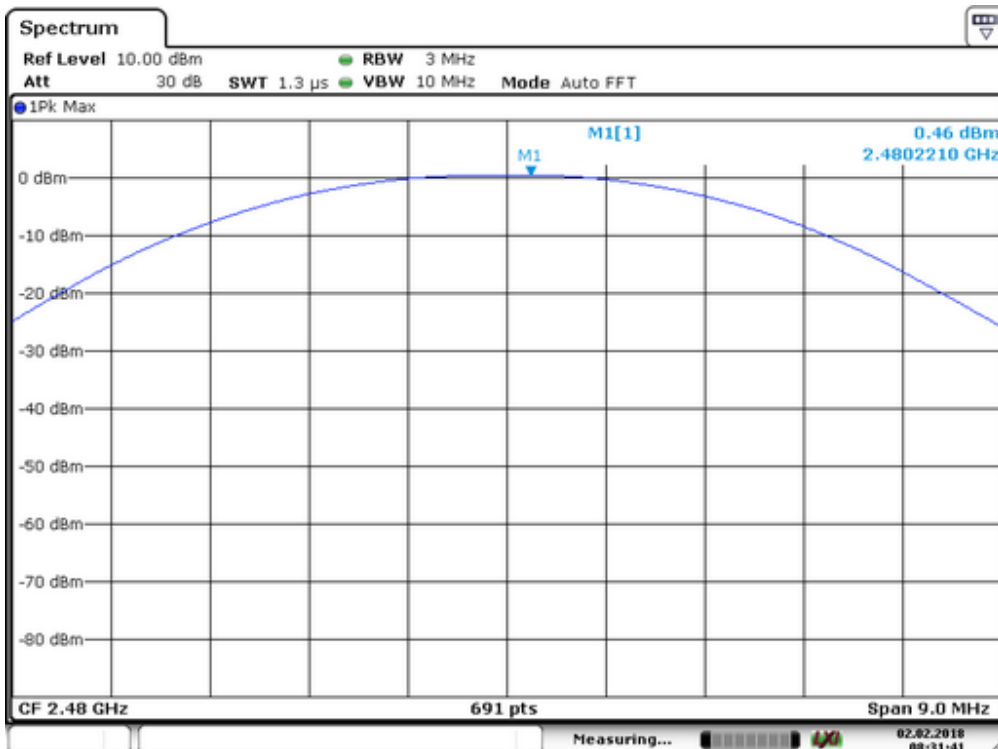
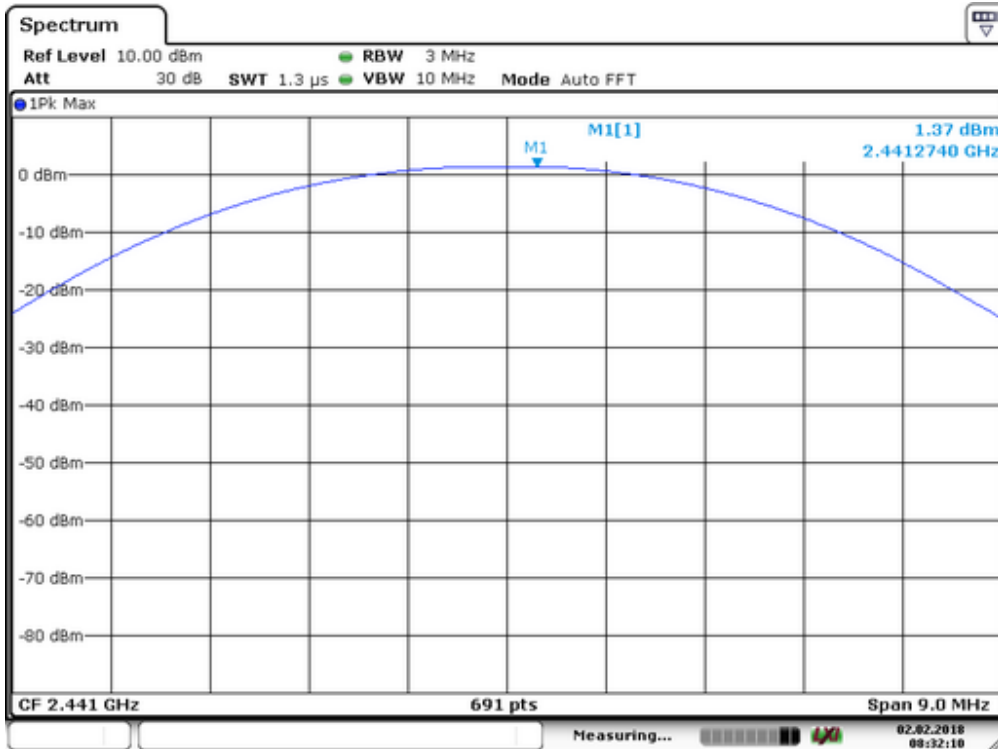

13. Band EDGE test

13.1 Measurement Procedure

For Conducted Test

1. The transmitter output is connected to a spectrum analyzer. The resolution bandwidth is set to 100KHz. The video bandwidth is set to 300KHz.
2. The spectrum from 30MHz to 26 GHz is investigated with the transmitter set to the lowest, middle, and highest channels.

EMI Test Receiver	Setting
Attenuation	Auto
RBW	100KHz
VBW	300KHz
Detector	Peak
Trace	Max hold

For Radiated emission Test

The EUT was placed on a styrofoam table which is 1.5m above ground plane.

The measurement procedure at the ban edges was simplified by performing the measurement in just one plot. Both, the in-band-emission and the unwanted emission were be encompassed by the span. After trace stabilization, the maximum peak was be determined by a peak detector and the value was marked by an appropriate limit line. The second limit line, which is 20dB below the first, marks the limit for the emissions in the unrestricted band. A maximum-peak-detector marks the highest emission in the unrestricted band next to the band edge.

The measurements were performed at the lower end of the 2.4GHz band.

Use the following spectrum analyzer settings:

For Restricted Band, When spectrum scanned above 1GHz setting resolution bandwidth 1MHz, video bandwidth 3MHz:

EMI Test Receiver	Setting
Attenuation	Auto
RBW	1MHz
VBW	3MHz
Detector	Peak
Trace	Max hold

For Non-Restricted Band, When spectrum scanned above 1GHz setting resolution bandwidth 100KHz, video bandwidth 300KHz:

EMI Test Receiver	Setting
Attenuation	Auto
RBW	100KHz
VBW	300KHz
Detector	Peak
Trace	Max hold

13.2 Test SET-UP (Block Diagram of Configuration)

For Conducted Test

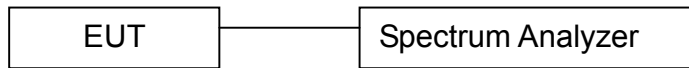

For Radiated emission Test

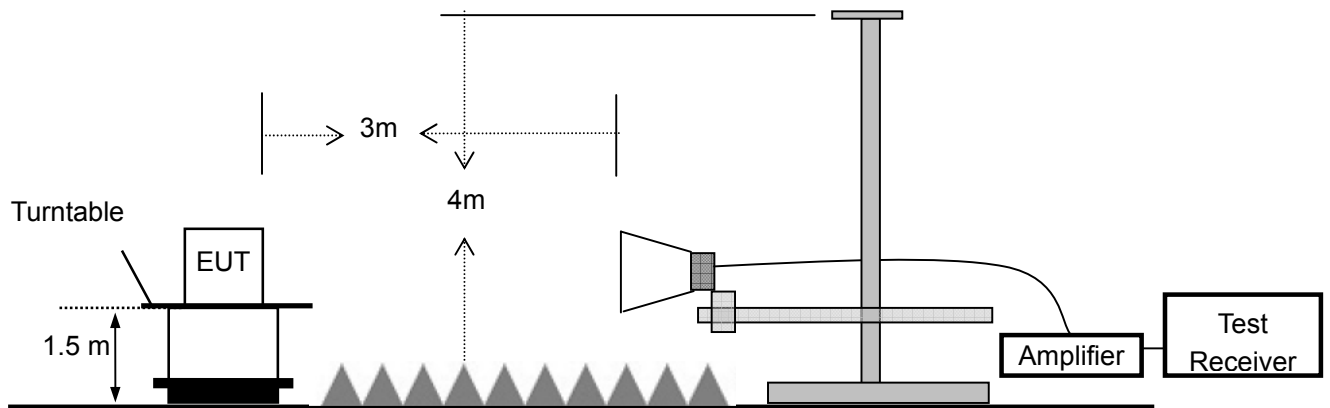

13.3 Measurement Equipment Used:

For Conducted Test

EQUIPMENT TYPE	MFR	MODEL NUMBER	SERIAL NUMBER	Characteristics	LAST CAL.	CAL DUE.
Spectrum Analyzer	Rohde & Schwarz	FSV30	1321.3008K	10Hz-30GHz	05/16/2017	05/15/2018
Coaxial Cable	CDS	79254	46107086	10Hz-30GHz	05/16/2017	05/15/2018
Antenna Connector	ARTHUR-YANG	2244-N1TG1	N/A	10Hz-30GHz	05/16/2017	05/15/2018

Remark: The temporary antenna connector is soldered on the PCB board in order to perform conducted tests and this temporary antenna connector is listed in the equipment list.

For Radiated emission Test

Item	Equipment	Manufacturer	Model No.	Serial No.	Characteristics	Last Cal.	Cal. Interval
1	Signal Analyzer	Rohde & Schwarz	FSV30	103040	9KHz-40GHz	05/16/2017	1 Year
2	Horn Antenna	Schwarzbeck	BBHA9120D	9120D-1272	1GHz-18GHz	05/16/2017	1 Year
3	Power Amplifier	LUNAR EM	LNA1G18-40	J10100000081	1GHz-26.5GHz	05/16/2017	1 Year
4	Cable	H+S	CBL-26	N/A	1GHz-26.5GHz	05/16/2017	1 Year
5	Cable	H+S	CBL-26	N/A	1GHz-26.5GHz	05/16/2017	1 Year
6	Cable	H+S	CBL-26	N/A	1GHz-26.5GHz	05/16/2017	1 Year

13.4 Measurement Results:

Refer to attached data chart.

Spectrum Detector: PK Test Date : February 02, 2018
 Test By: Yaping Shen Temperature : 25 °C
 Test Result: PASS Humidity : 50 %

1. Conducted Test

For Non-Hopping Mode:

Frequency (MHz)	Modulation	Peak Power Output(dBm)	Result of Band edge(dBc)	Band edge Limit(dBc)
2399.49	GFSK	0.41	34.94	>20dBc
2399.8	pi/4-DQPSK	-2.83	34.98	>20dBc
2399.32	8DPSK	-2.49	34.82	>20dBc
2484.63	GFSK	-0.47	38.71	>20dBc
2484.79	pi/4-DQPSK	-3.55	38.65	>20dBc
2484.33	8DPSK	-3.18	38.53	>20dBc

Test plots of GFSK

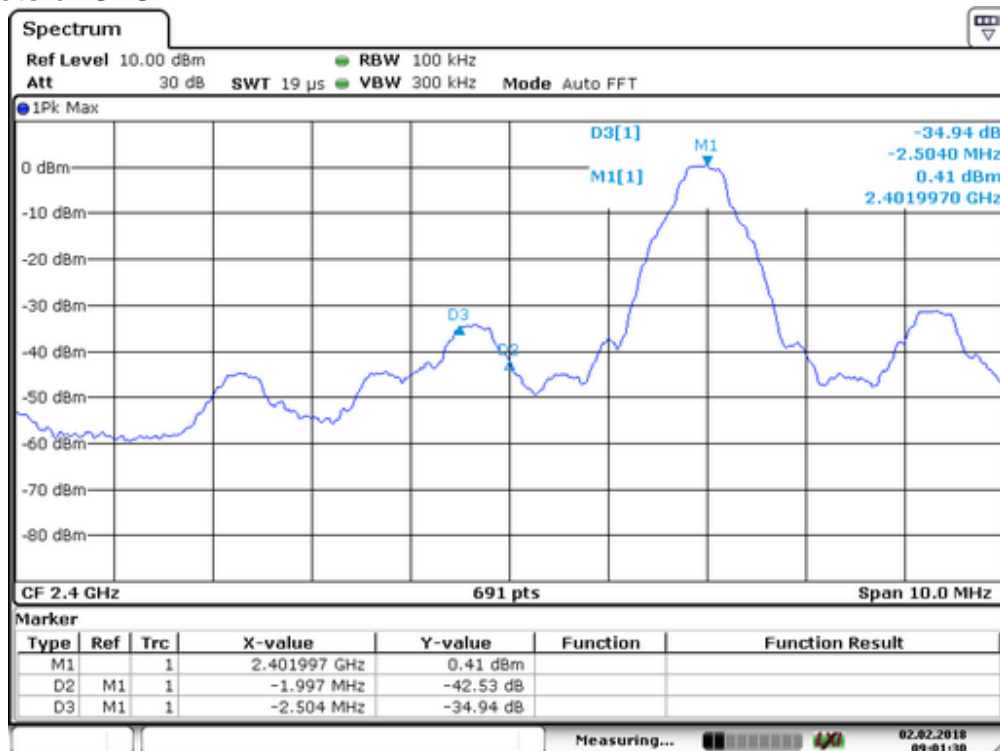

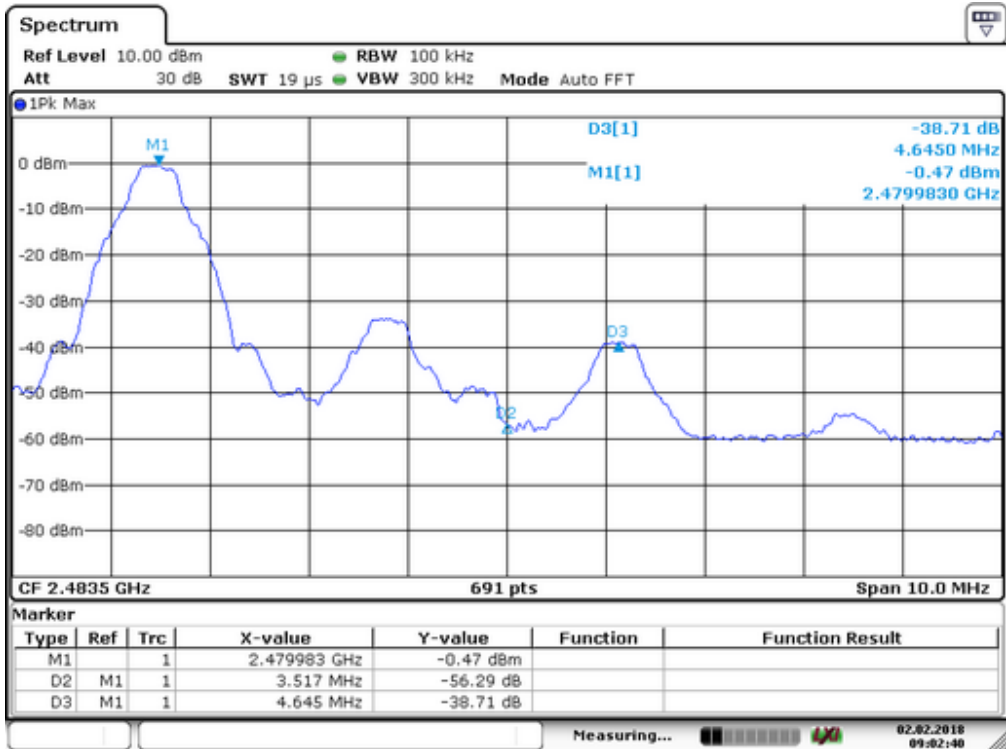

Test plots of pi/4-DQPSK

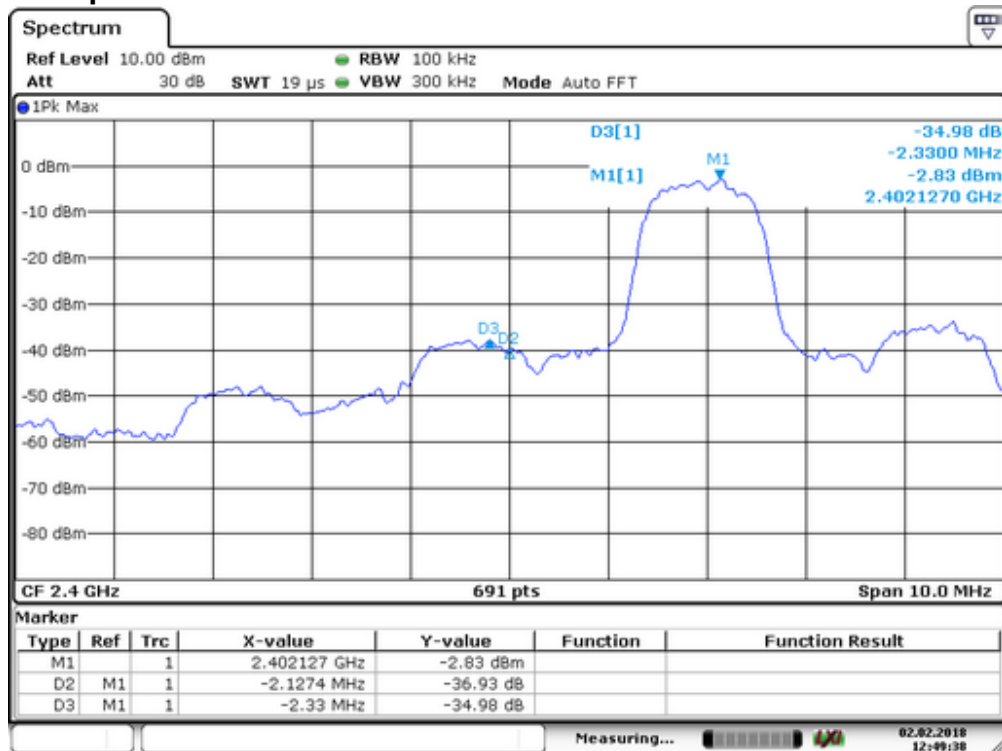

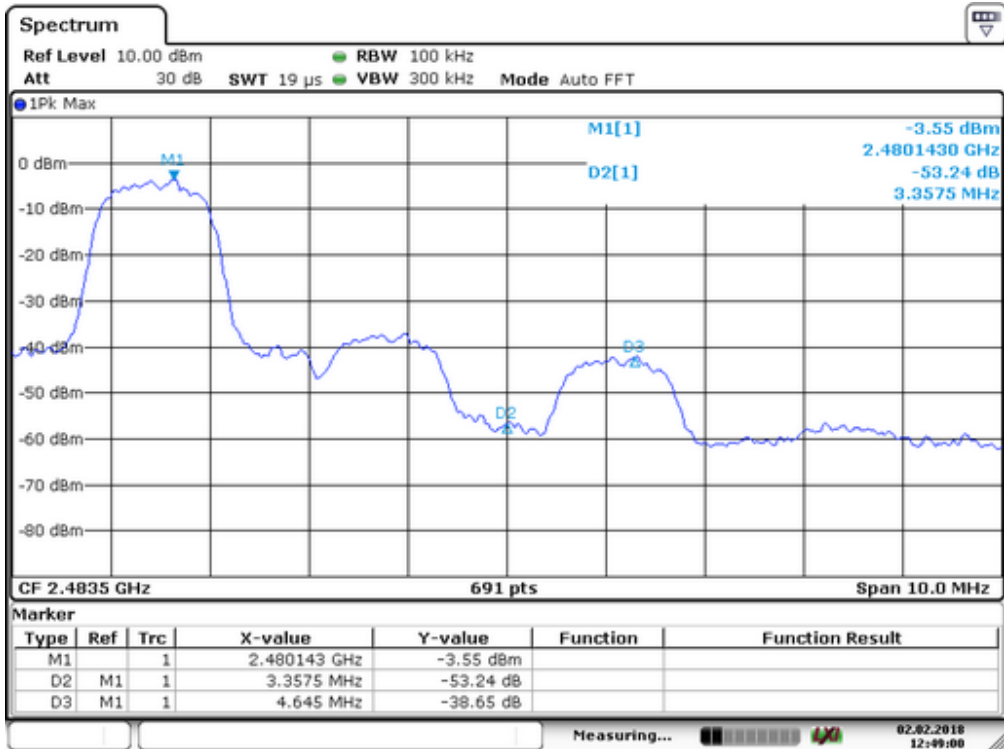

Test plots of 8DPSK

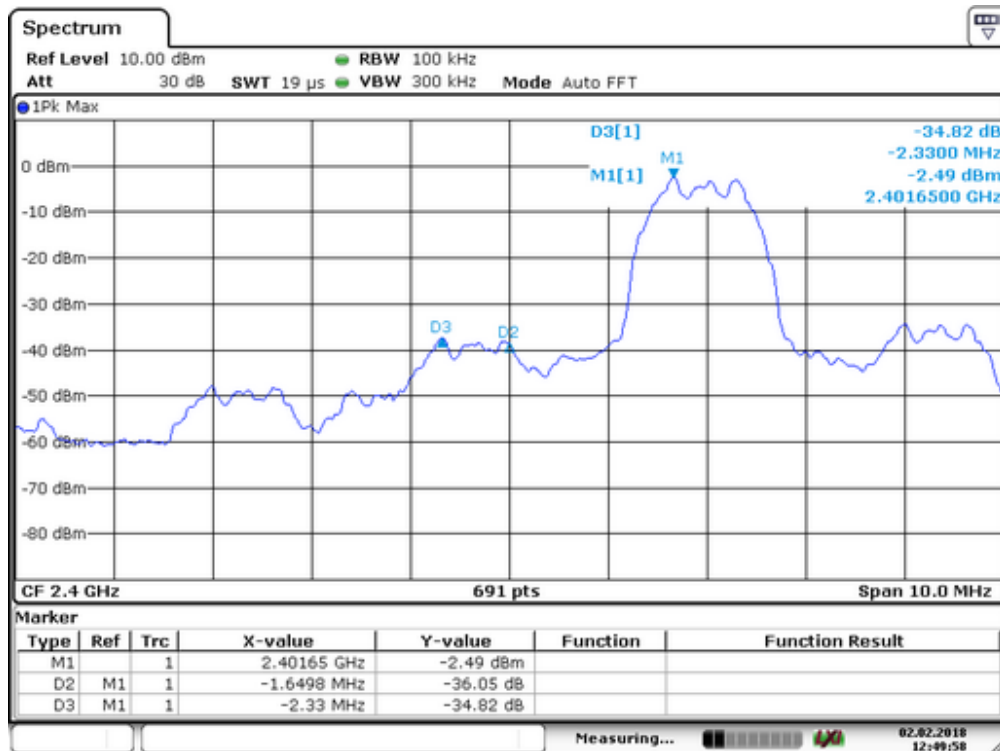



For Hopping Mode:

Frequency (MHz)	Modulation	Peak Power Output(dBm)	Result of Band edge(dBc)	Band edge Limit(dBc)
2399.45	GFSK	1.13	36.82	>20dBc
2399.44	pi/4-DQPSK	0.9	36.93	>20dBc
2398.85	8DPSK	0.81	36.62	>20dBc
2484.44	GFSK	0.36	38.84	>20dBc
2483.64	pi/4-DQPSK	-0.23	39.72	>20dBc
2484.46	8DPSK	-0.24	38.57	>20dBc

Test plots of GFSK

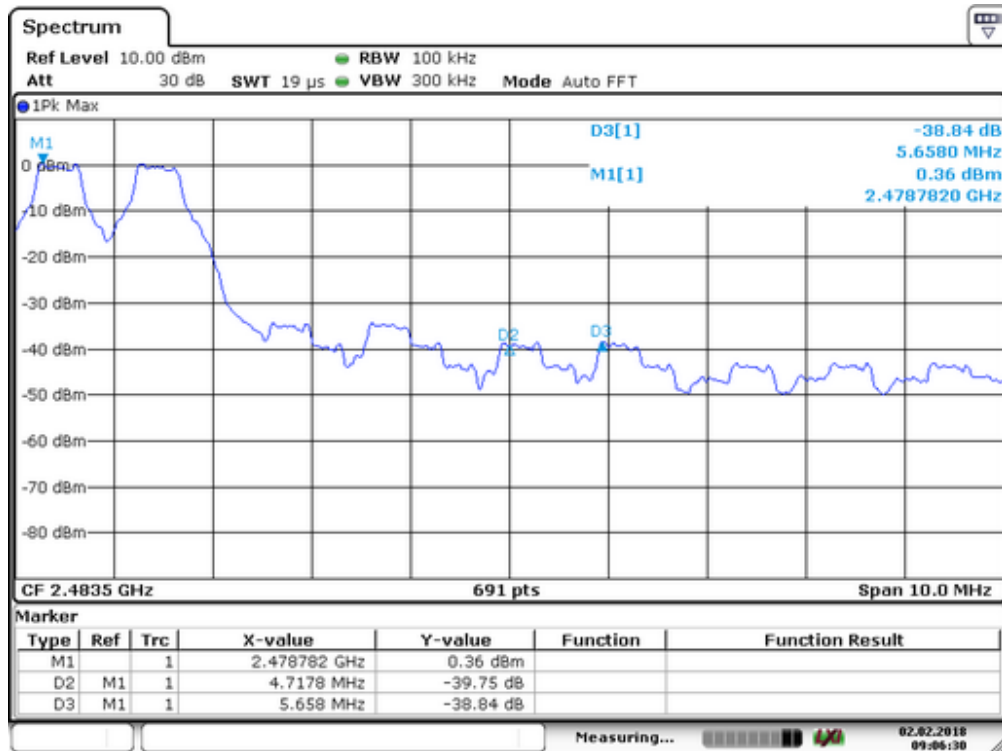
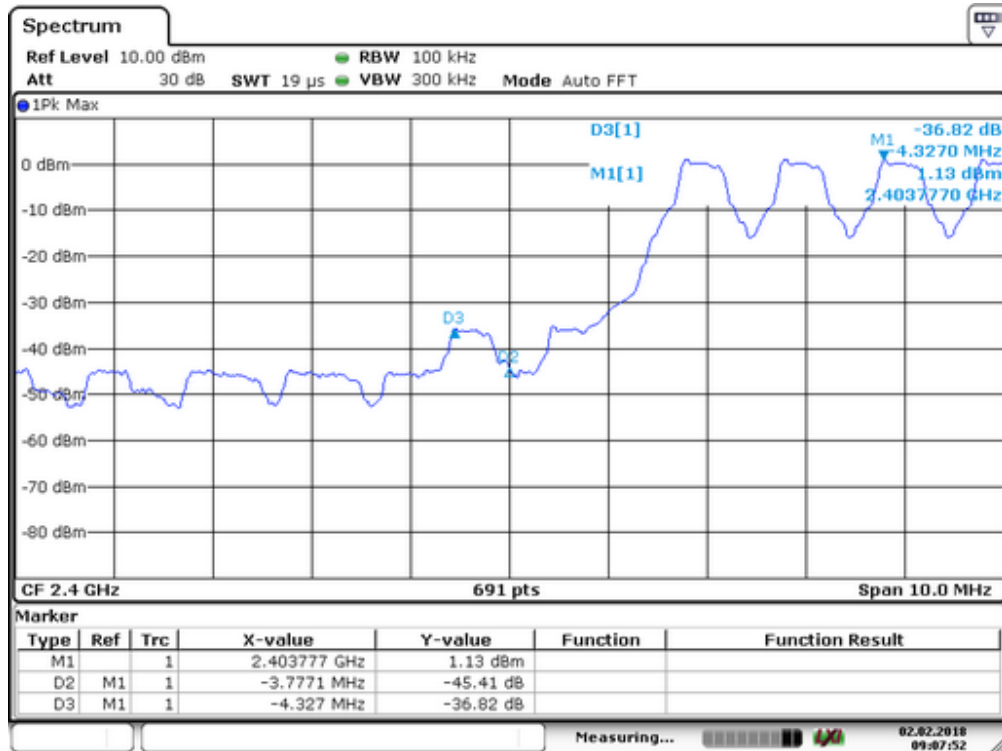

Test plots of pi/4-DQPSK

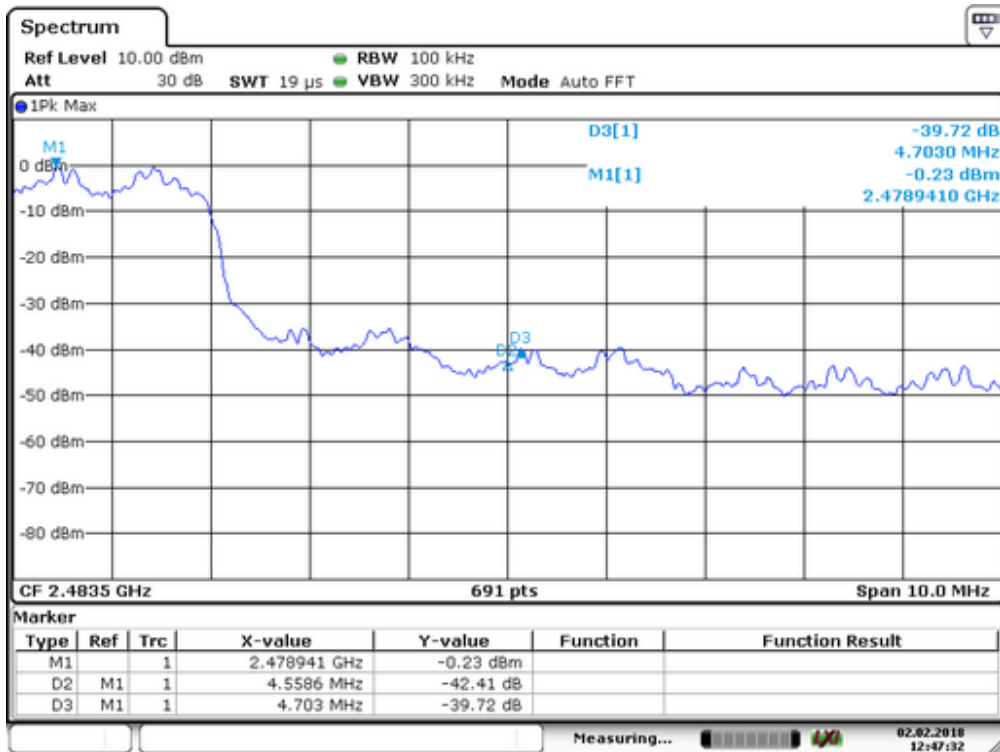
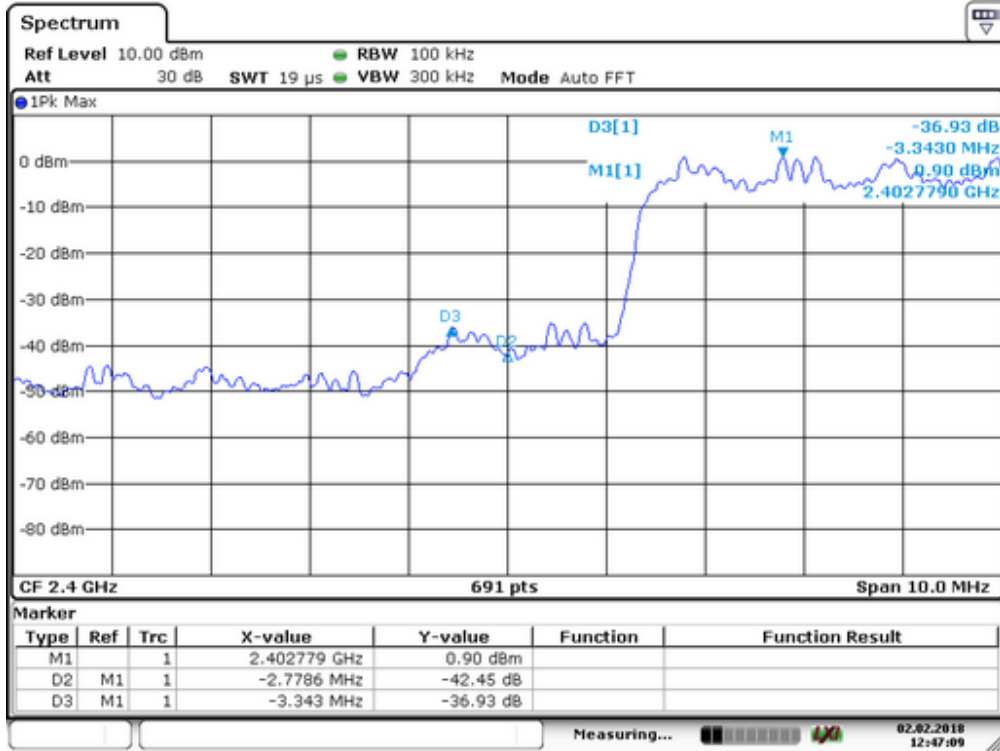

Test plots of 8DPSK

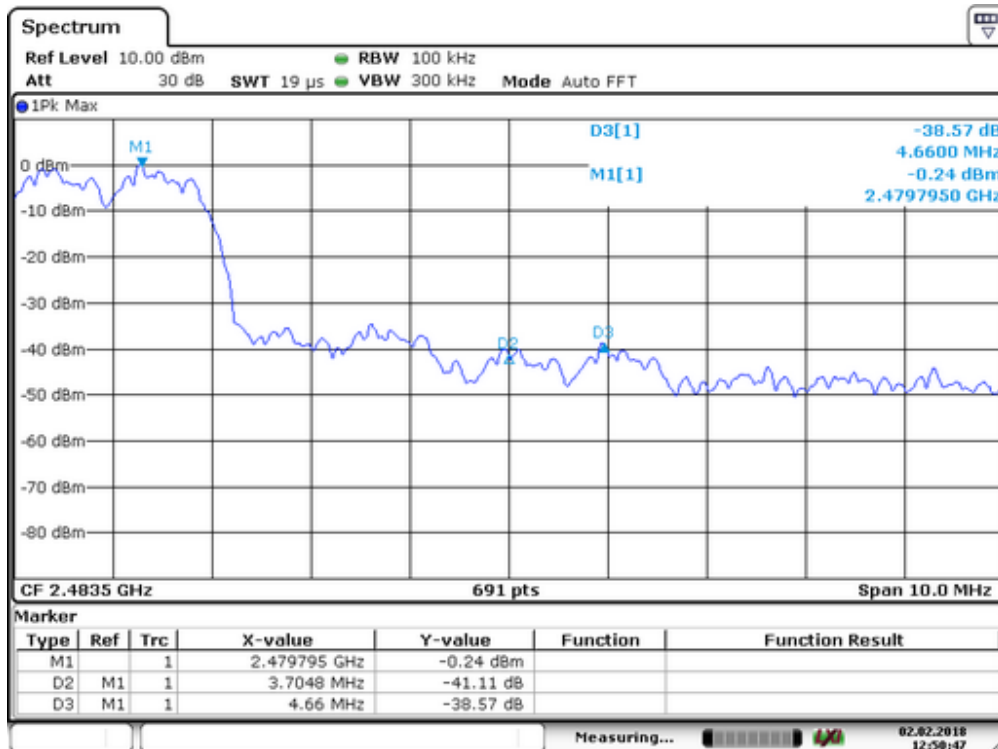
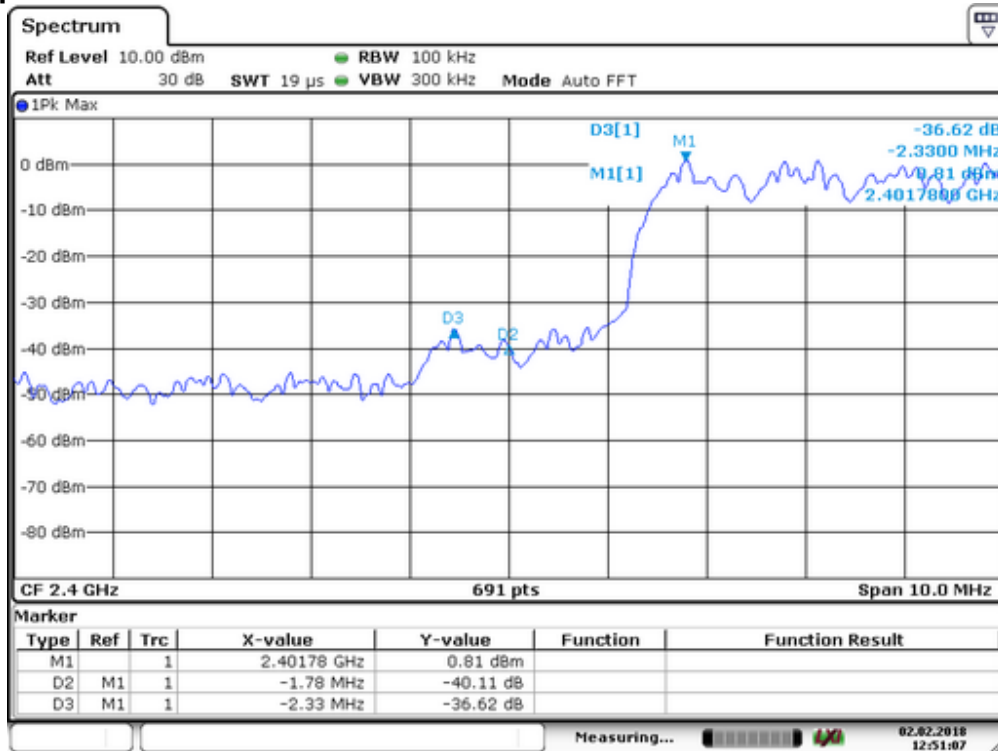

2. Radiated emission Test
Worst test modulation GFSK
For Non-Hopping Mode:

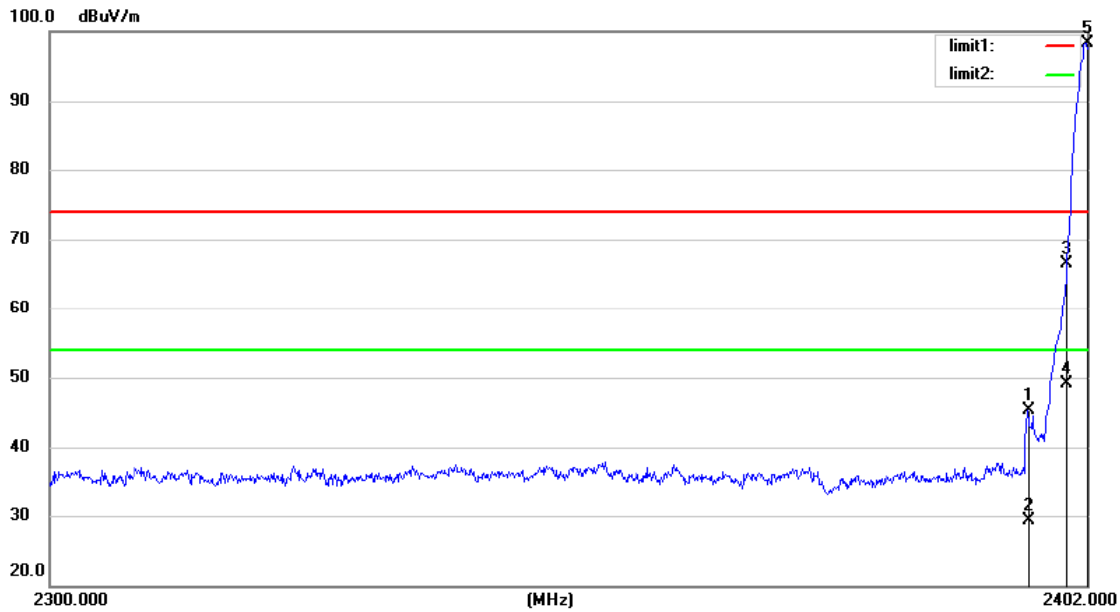

Site Chamber #1 Polarization: **Horizontal** Temperature: 26
 Limit: (RE)FCC PART 15 C 3m_PEAK Power: AC 120V/60Hz Humidity: 55 %
 Mode: DSS (TX2402)
 Note:

No.	Mk.	Freq.	Reading Level	Correct Factor	Measurement	Limit	Over	Antenna Height	Table Degree	Comment
		MHz	dBuV	dB	dBuV/m	dBuV/m	dB	cm	degree	
1		2396.084	66.15	-20.95	45.20	74.00	-28.80	peak	0	
2		2396.084	50.25	-20.95	29.30	54.00	-24.70	AVG	0	
3		2400.000	87.37	-20.93	66.44	74.00	-7.56	peak	0	
4		2400.000	70.02	-20.93	49.09	54.00	-4.91	AVG	0	
5	*	2401.898	119.21	-20.93	98.28	74.00	24.28	peak	0	

*:Maximum data x:Over limit !:over margin Comment: Factor build in receiver. Operator: Yaping shen

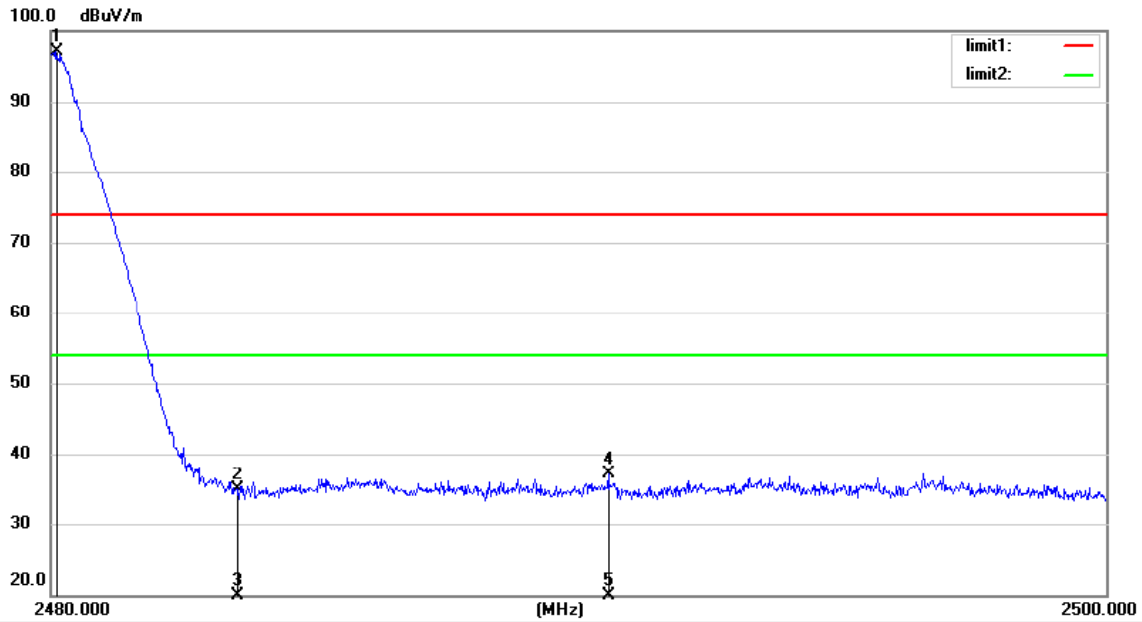

Site: Chamber #1 Polarization: **Horizontal** Temperature: 26
 Limit: (RE)FCC PART 15 C 3m_PEAK Power: AC 120V/60Hz Humidity: 55 %
 Mode: DSS (TX2480)
 Note:

No.	Mk.	Freq. MHz	Reading Level dBuV	Correct Factor dB	Measure- ment dBuV/m	Limit dBuV/m	Over dB	Detector	Antenna Height cm	Table Degree	Comment
1	*	2480.100	117.84	-20.71	97.13	74.00	23.13	peak		0	
2		2483.500	55.55	-20.72	34.83	74.00	-39.17	peak		0	
3		2483.500	37.15	-20.72	16.43	54.00	-37.57	AVG		0	
4		2490.540	57.78	-20.69	37.09	74.00	-36.91	peak		0	
5		2490.540	40.15	-20.69	19.46	54.00	-34.54	AVG		0	

*:Maximum data x:Over limit !:over margin Comment: Factor build in receiver. Operator: Yaping shen

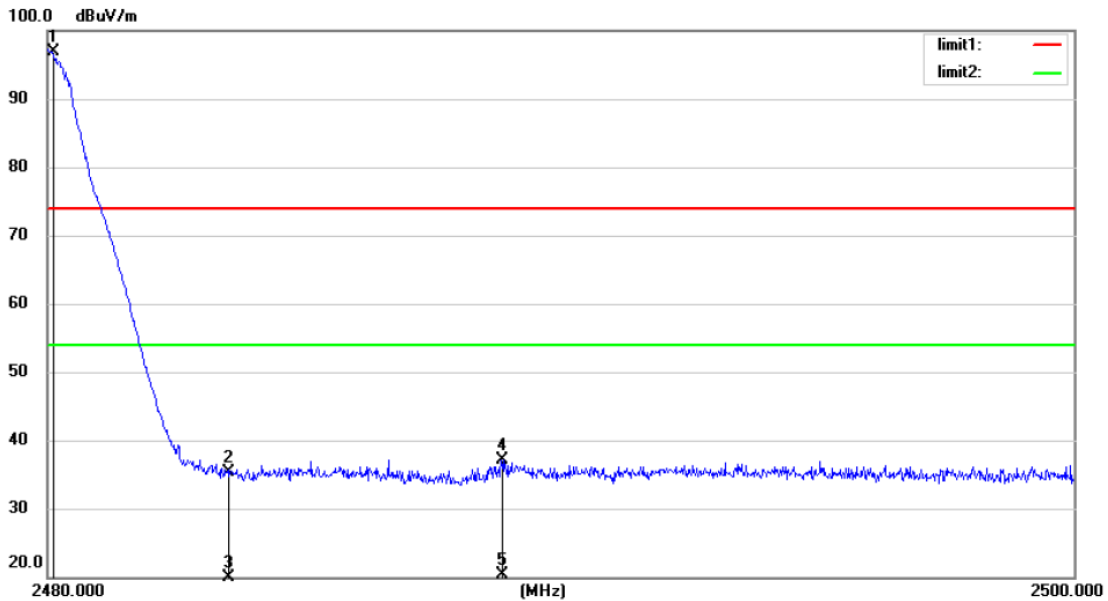

Site Chamber #1 Polarization: *Vertical* Temperature: 26
 Limit: (RE)FCC PART 15 C 3m_PEAK Power: AC 120V/60Hz Humidity: 55 %
 Mode: DSS (TX2480)
 Note:

No.	Mk.	Freq.	Reading Level	Correct Factor	Measurement	Limit	Over	Antenna Height	Table Degree	
		MHz	dBuV	dB	dBuV/m	dBuV/m	dB	cm	degree	Comment
1	*	2480.100	116.15	-19.28	96.87	74.00	22.87	peak	0	
2		2483.500	54.62	-19.27	35.35	74.00	-38.65	peak	0	
3		2483.500	37.15	-19.27	17.88	54.00	-36.12	AVG	0	
4		2488.840	56.28	-19.23	37.05	74.00	-36.95	peak	0	
5		2488.840	39.55	-19.23	20.32	54.00	-33.68	AVG	0	

*:Maximum data x:Over limit !:over margin Comment: Factor build in receiver. Operator: Yaping shen

For Hopping Mode:

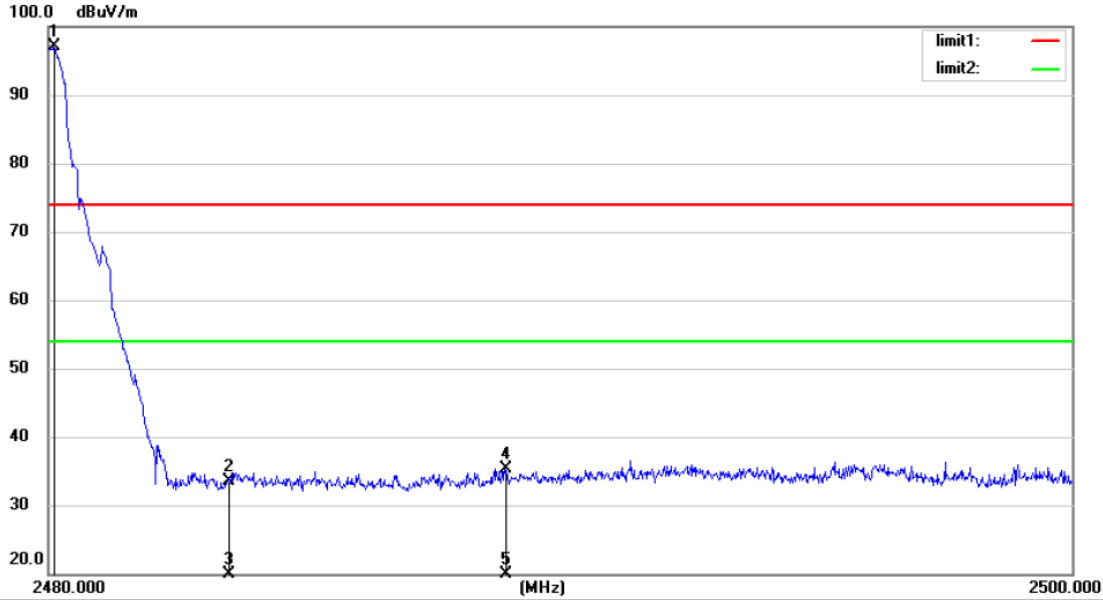

Site Chamber #1 Polarization: *Horizontal* Temperature: 26
 Limit: (RE)FCC PART 15 C 3m_PEAK Power: AC 120V/60Hz Humidity: 55 %
 Mode:Hopping
 Note:

No.	Mk.	Freq.	Reading Level	Correct Factor	Measurement	Limit	Over	Antenna Height	Table Degree	Comment
		MHz	dBuV	dB	dBuV/m	dBuV/m	dB	cm	degree	
1	*	2480.100	117.87	-20.71	97.16	74.00	23.16	peak	0	
2		2483.500	54.27	-20.72	33.55	74.00	-40.45	peak	0	
3		2483.500	37.14	-20.72	16.42	54.00	-37.58	AVG	0	
4		2488.920	56.01	-20.69	35.32	74.00	-38.68	peak	0	
5		2488.920	38.15	-20.69	17.46	54.00	-36.54	AVG	0	

*:Maximum data x:Over limit !:over margin Comment: Factor build in receiver. Operator: Yaping shen

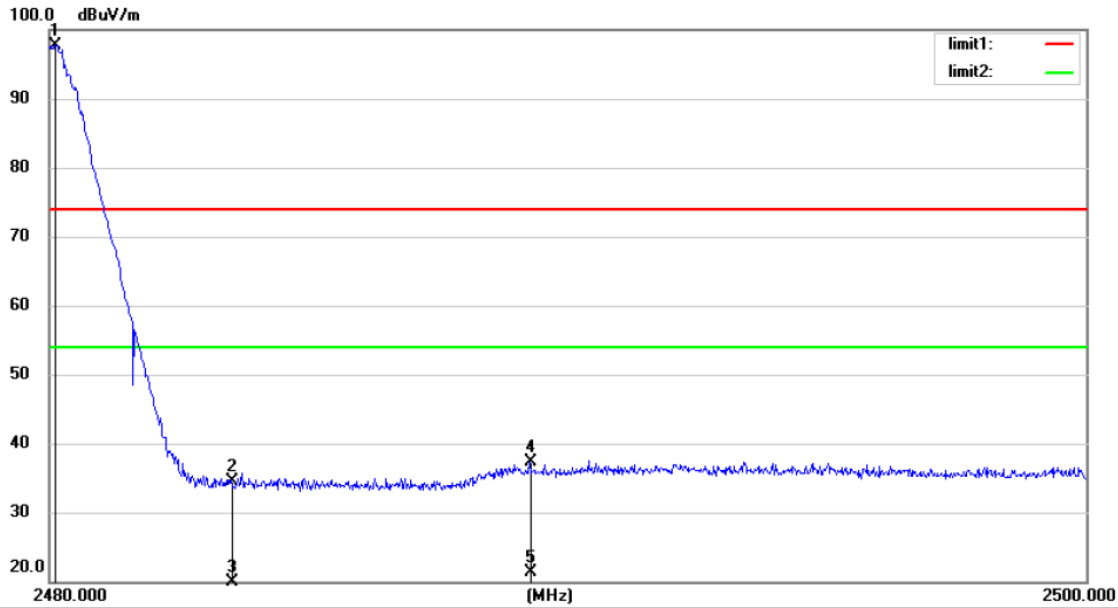

Site Chamber #1 Polarization: **Vertical** Temperature: 26
 Limit: (RE)FCC PART 15 C 3m_PEAK Power: Battery 3.7V Humidity: 55 %
 Mode: Hopping
 Note:

No.	Mk.	Freq. MHz	Reading Level dBuV	Correct Factor dB	Measure- ment dBuV/m	Limit dBuV/m	Over dB	Detector	Antenna Height cm	Table Degree	Comment
1	*	2480.100	117.04	-19.28	97.76	74.00	23.76	peak		0	
2		2483.500	53.87	-19.27	34.60	74.00	-39.40	peak		0	
3		2483.500	37.14	-19.27	17.87	54.00	-36.13	AVG		0	
4		2489.260	56.46	-19.23	37.23	74.00	-36.77	peak		0	
5		2489.260	40.55	-19.23	21.32	54.00	-32.68	AVG		0	

*:Maximum data x:Over limit !:over margin Comment: Factor build in receiver. Operator: Yaping shen

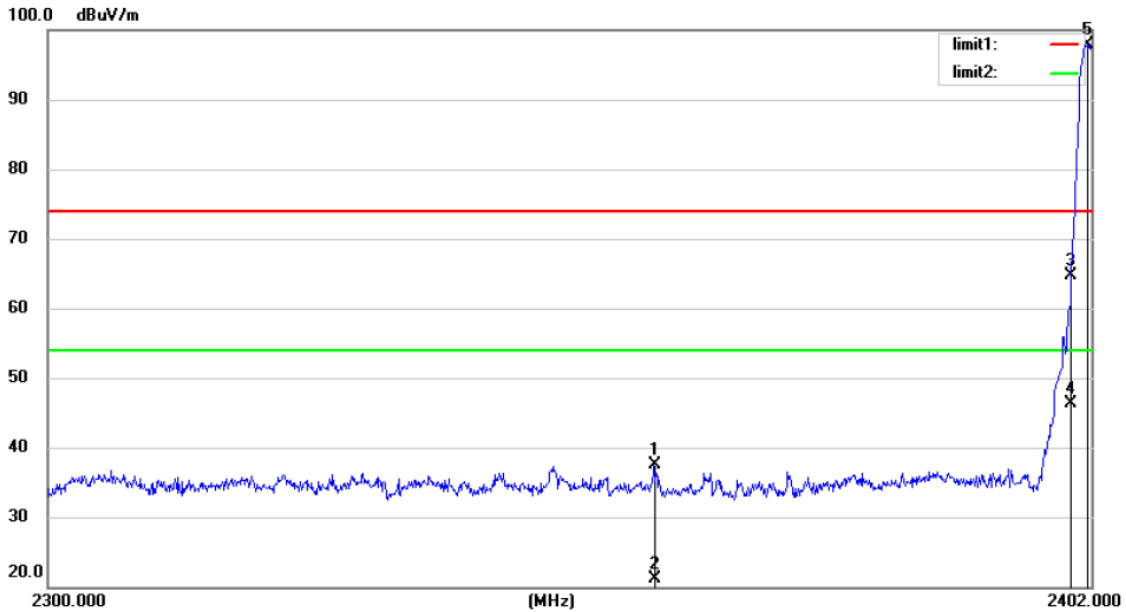

Site Chamber #1 Polarization: **Horizontal** Temperature: 26
 Limit: (RE)FCC PART 15 C 3m_PEAK Power: AC 120V/60Hz Humidity: 55 %
 Mode:Hopping
 Note:

No.	Mk.	Freq.	Reading Level	Correct Factor	Measurement	Limit	Over	Antenna Height	Table Degree
		MHz	dBuV	dB	dBuV/m	dBuV/m	dB	cm	degree
1		2358.752	58.51	-21.04	37.47	74.00	-36.53	peak	0
2		2358.752	42.12	-21.04	21.08	54.00	-32.92	AVG	0
3		2400.000	85.57	-20.93	64.64	74.00	-9.36	peak	0
4		2400.000	67.15	-20.93	46.22	54.00	-7.78	AVG	0
5	*	2401.592	118.84	-20.93	97.91	74.00	23.91	peak	0

*:Maximum data x:Over limit !:over margin Comment: Factor build in receiver. Operator: Yaping shen

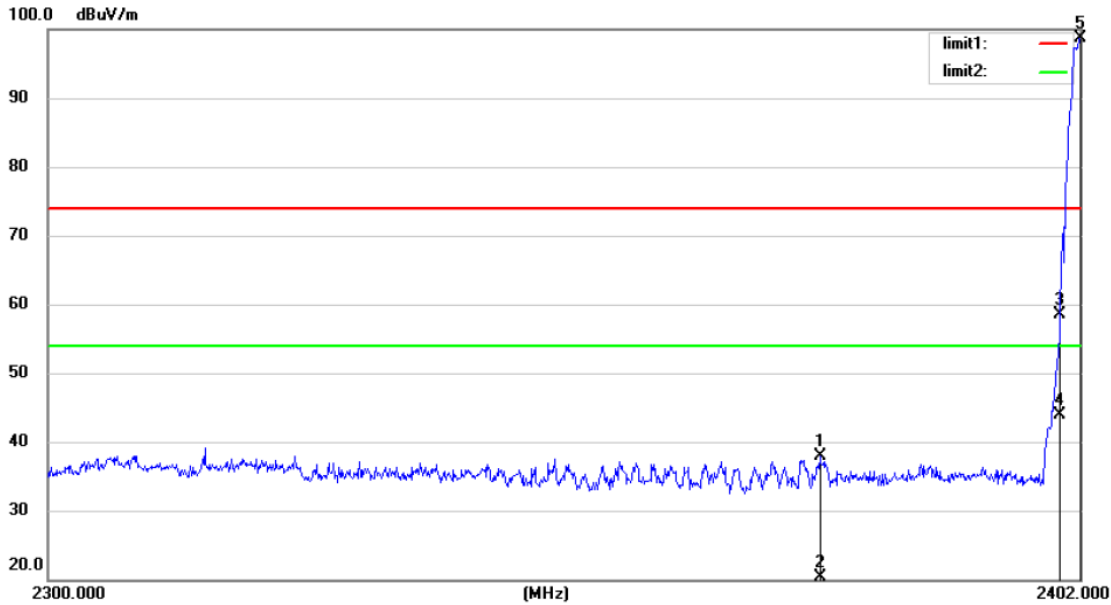

Site Chamber #1 Polarization: *Vertical* Temperature: 26
 Limit: (RE)FCC PART 15 C 3m_PEAK Power: AC 120V/60Hz Humidity: 55 %
 Mode:Hopping
 Note:

No.	Mk.	Freq.	Reading Level	Correct Factor	Measurement	Limit	Over	Antenna Height	Table Degree	
		MHz	dBuV	dB	dBuV/m	dBuV/m	dB	cm	degree	Comment
1		2375.888	57.78	-19.92	37.86	74.00	-36.14	peak	0	
2		2375.888	40.25	-19.92	20.33	54.00	-33.67	AVG	0	
3		2400.000	78.22	-19.77	58.45	74.00	-15.55	peak	0	
4		2400.000	63.58	-19.77	43.81	54.00	-10.19	AVG	0	
5	*	2402.000	118.43	-19.76	98.67	74.00	24.67	peak	0	

*:Maximum data x:Over limit !:over margin Comment: Factor build in receiver. Operator: Yaping shen

14. Antenna Application

14.1 Antenna requirement

The EUT'S antenna is met the requirement of FCC part 15C section 15.203 and 15.247.

FCC part 15C section 15.247 requirements:

Systems operating in the 2402-2480MHz band that are used exclusively for fixed, point-to-point operations may employ transmitting antennas with directional gain greater than 6dBi provided the maximum peak output power of the intentional radiator is reduced by 1dB for every 3dB that the directional gain of the antenna exceeds 6dBi.

14.2 Result

The EUT's antenna, permanent attached antenna, used a PCB antenna and integrated on PCB, The antenna's gain is 2dBi and meets the requirement.

15. Photos of EUT

Please refer to external photos and internal photos.