

<b>iHome</b>	
Title:	GAW
Version:	V5
Model #:	iBT10
Designer:	Sunki Jeon
Date:	12.03.16
<small>CONFIDENTIAL and PROPRIETARY: The information contained herein including, but not limited to the products, renderings, concepts and designs comprise intellectual property of SDI Technologies Inc. and shall be kept confidential and shall not be used or disclosed by the recipient without the written authority of SDI Technologies Inc.</small>	

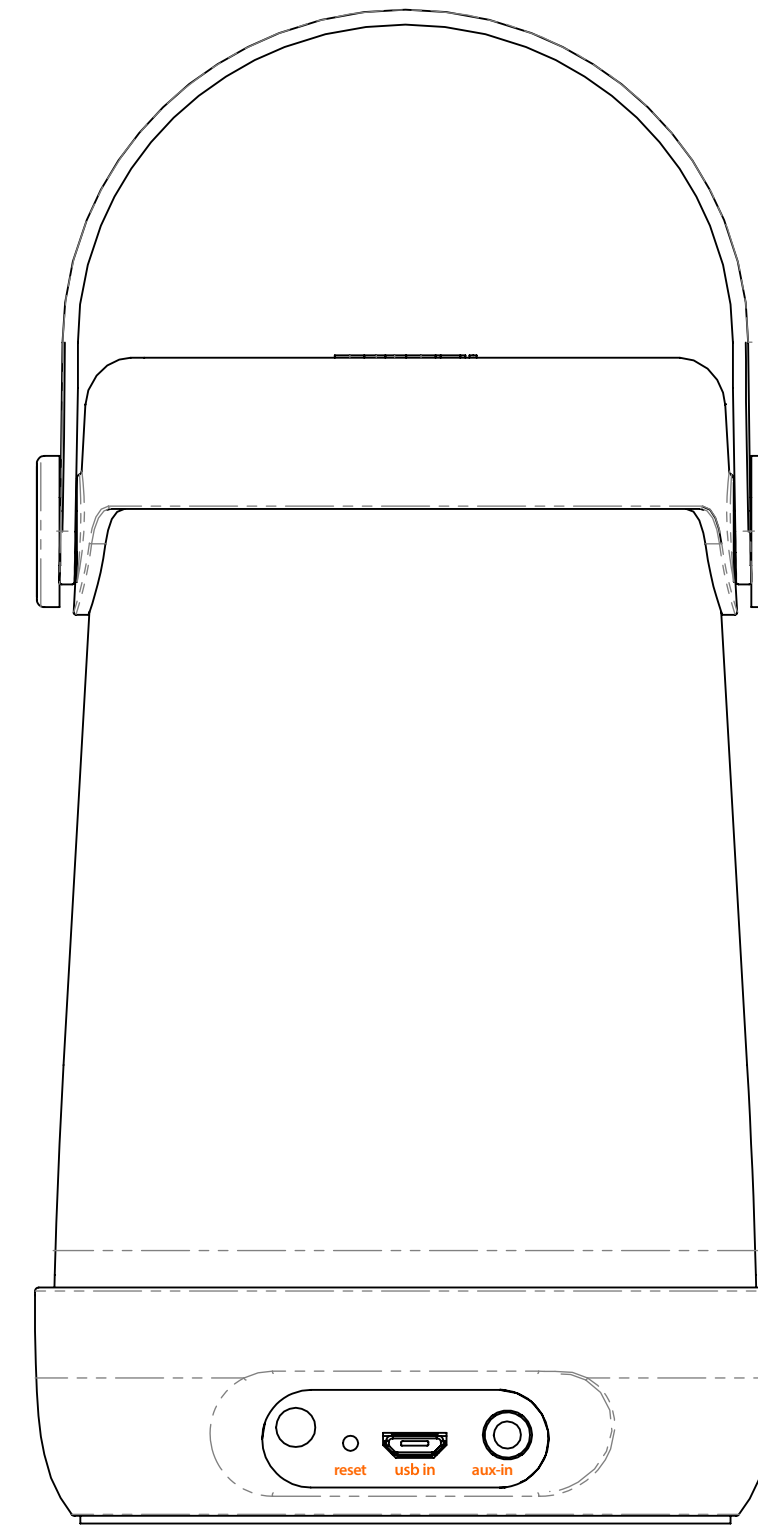
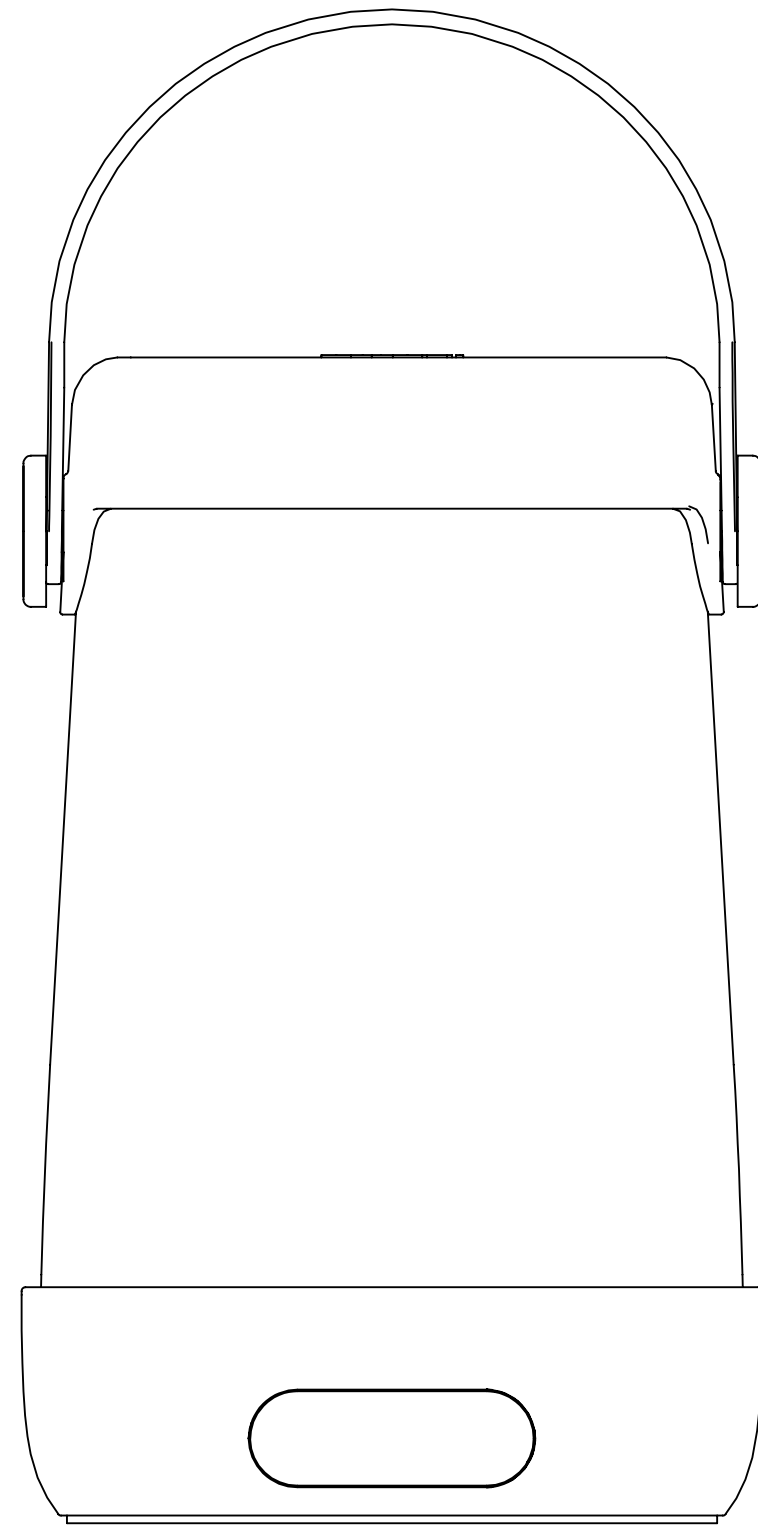
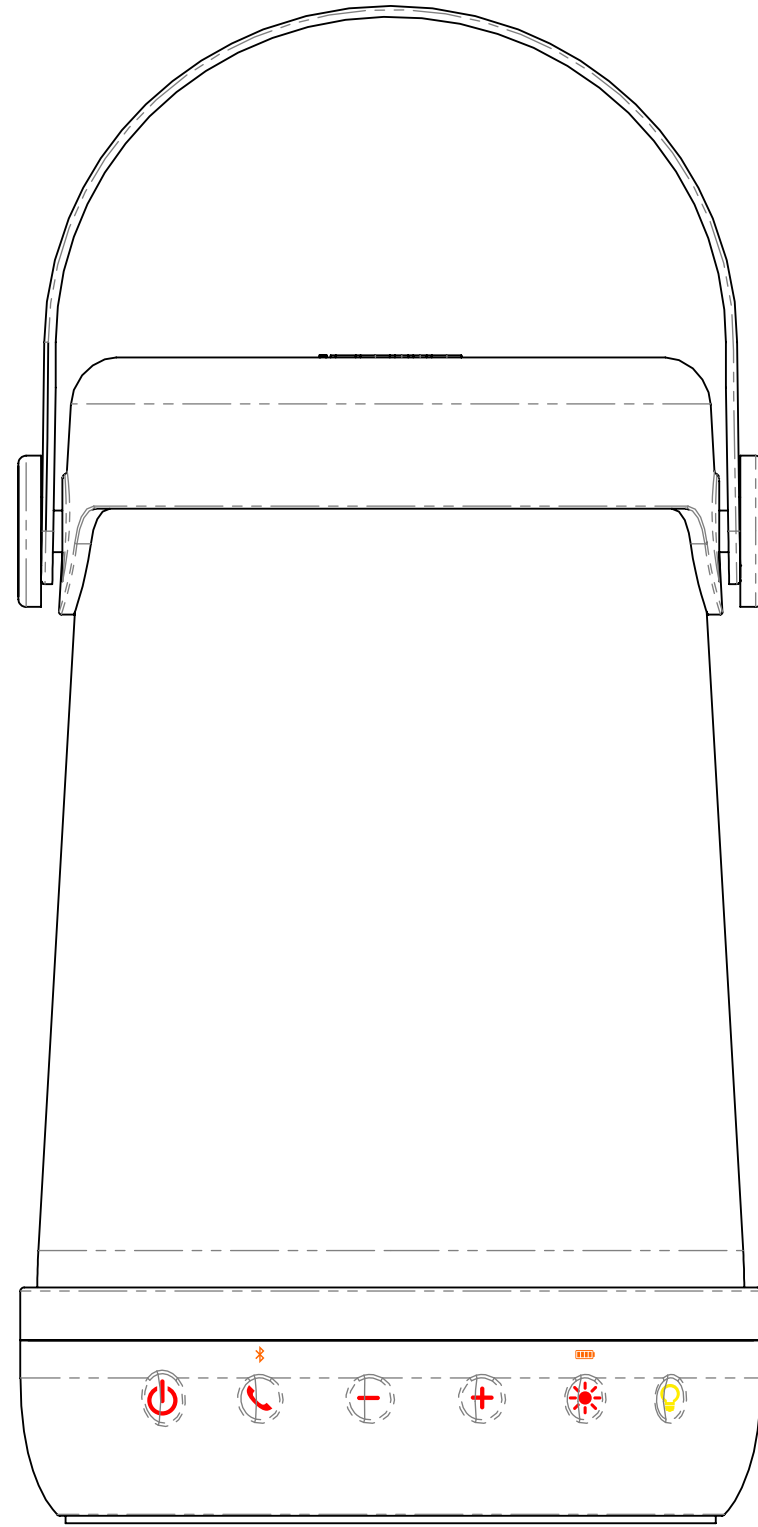
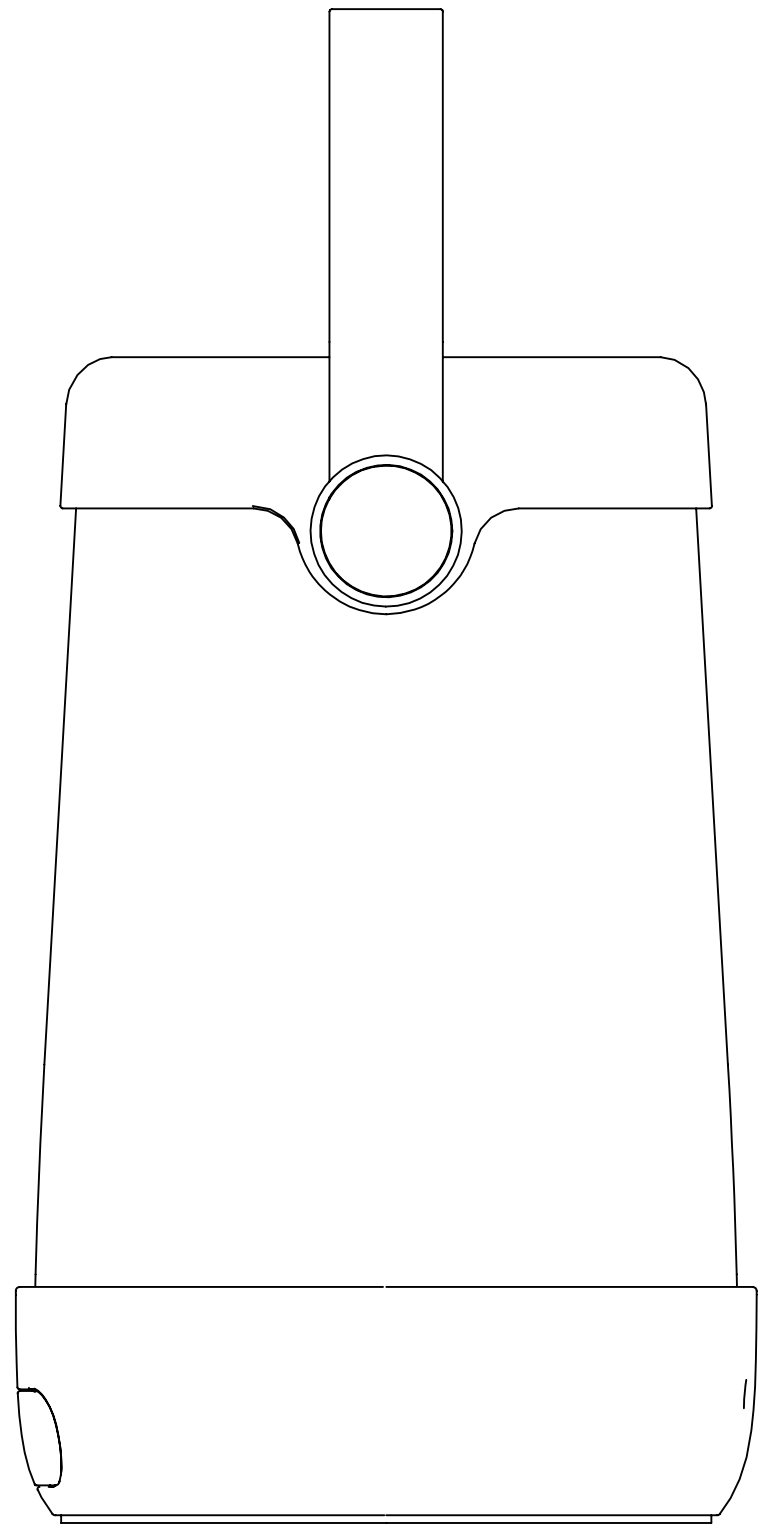
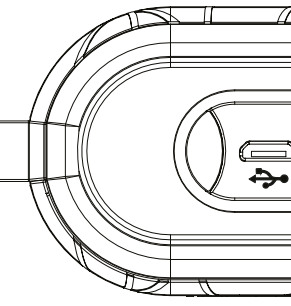
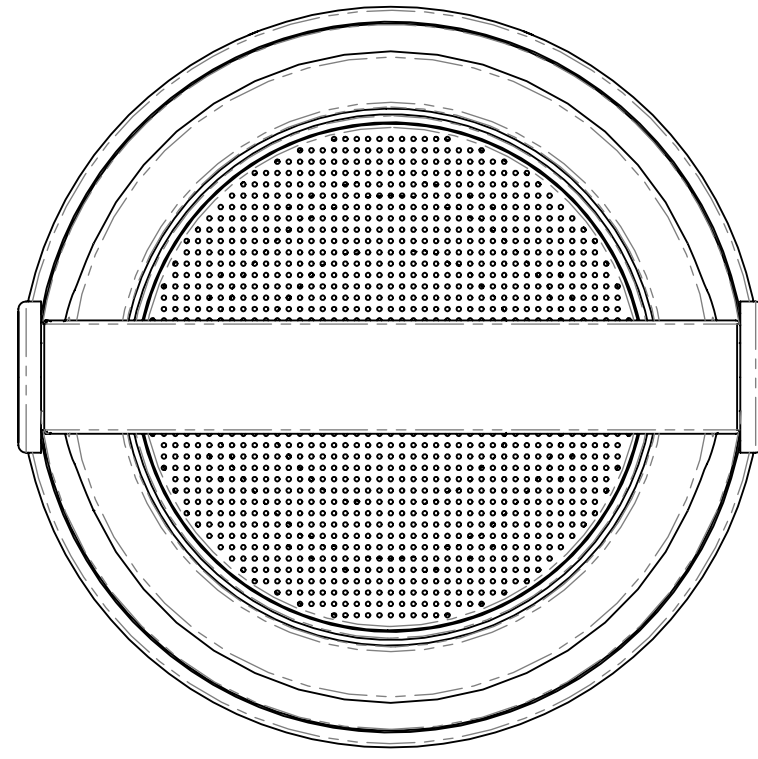

- All Graphics in RED are EMBOSSED with pad printing PMS Cool Grey 11C. embossed: 0.3mm
- All Graphics in YELLOW are EMBOSSED with pad printing PMS Yellow C. embossed: 0.3mm
- All Graphics in ORANGE are DEBOSSSED with glossy finish debossed: 0.3mm

Dec 3, 2016 moved down below the ports to read better

- All Graphics in ORANGE are DEBOSSSED with glossy finish debossed: 0.3mm

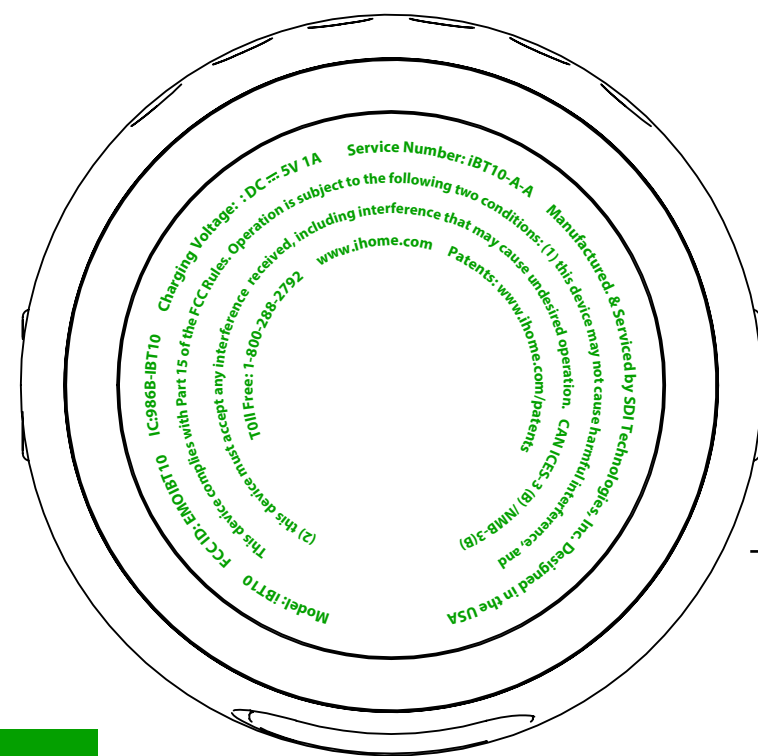

iBT10  
~~Aug 29, 2016~~  
 Nov 30, 2016  
 Both type

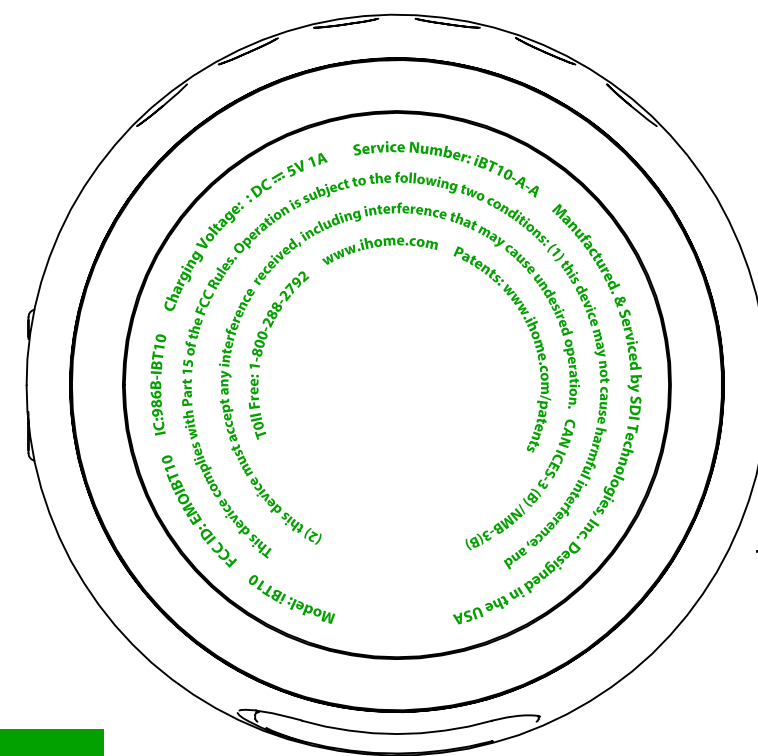

iBT10  
~~Aug 29, 2016~~  
 Nov 30, 2016  
 Both type

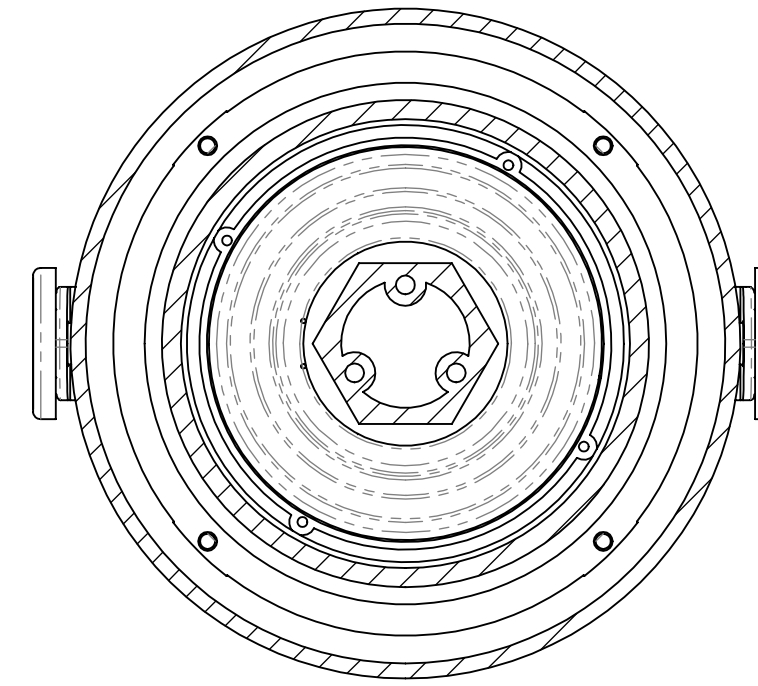

■ All Graphics in GREEN are glossy finish reference: iBT82

■ All Graphics in GREEN are glossy finish reference: iBT82