

**ELECTROMAGNETIC EMISSIONS COMPLIANCE REPORT
INTENTIONAL RADIATOR CERTIFICATION TO
FCC PART 15 SUBPART C REQUIREMENT**

OF

Wireless Charging Clock Speaker with Dual USB Charging

**Model No.: HWL83, HWL83N, HWL83X (X means A-Z, denote as color
of cabinet)**

Trademark: iHome

FCC ID: EMOHWL83N

Report No.: ES180820024E2

Issue Date: September 21, 2018

Prepared for

**SDI TECHNOLOGIES INC.
1299, Main Street, Rahway, NJ 07065, U.S.A.**

Prepared by

EMTEK(SHENZHEN) CO., LTD.

**Bldg 69, Majialong Industry Zone, Nanshan District, Shenzhen,
Guangdong, China.**

TEL: 86-755-26954280

FAX: 86-755-26954282

**This report shall not be reproduced, except in full, without the written approval of
EMTEK(SHENZHEN) CO., LTD.**

VERIFICATION OF COMPLIANCE

Applicant:	SDI Technologies Inc. 1299, Main Street, Rahway, NJ 07065, U.S.A.
Manufacturer:	Hotel Technologies Inc. 1299, Main Street, Rahway, NJ 07065, U.S.A.
Factory:	Wing Hing Luen Electronics (Shenzhen) Co. Ltd. Feng Huang Road, Egongling, PingHu, Longgang, Shenzhen, China.
Product Description:	Wireless Charging Clock Speaker with Dual USB Charging
Trade Mark:	iHome
Model Number:	HWL83, HWL83N, HWL83X (X means A-Z, denote as color of cabinet)(Note: The samples are the same except difference color of appearance and model number, Here HWL83 was selected for full test.)

We hereby certify that:

The above equipment was tested by EMTEK(SHENZHEN) CO., LTD. The test data, data evaluation, test procedures, and equipment configurations shown in this report were made in accordance with the procedures given in ANSI C63.10-2013 and the energy emitted by the sample EUT tested as described in this report is in compliance with conducted and radiated emission limits of FCC Rules Part 15C.

Date of Test : August 20, 2018 to September 20, 2018

Yaping Shen

Prepared/Tested by : Yaping Shen/Editor

Joe Xia

Reviewer : Joe Xia/Supervisor

Lisa Wang

Approved & Authorized Signer : Lisa Wang/Manager

Modified Information

Version	Summary	Revision Date	Report No.
Ver.1.0	Original Report	/	ES180820024E2

Table of Contents

1	GENERAL INFORMATION.....	5
1.1	PRODUCT DESCRIPTION.....	5
1.2	RELATED SUBMITTAL(S) / GRANT(S).....	6
1.3	TEST METHODOLOGY.....	6
1.4	SPECIAL ACCESSORIES.....	6
1.5	EQUIPMENT MODIFICATIONS.....	6
1.6	TEST FACILITY.....	6
2	SYSTEM TEST CONFIGURATION.....	7
2.1	EUT CONFIGURATION.....	7
2.2	EUT EXERCISE.....	7
2.3	TEST PROCEDURE.....	7
2.4	CONFIGURATION OF TESTED SYSTEM.....	8
3	SUMMARY OF TEST RESULTS.....	8
4	DESCRIPTION OF TEST MODES.....	9
4.1	MEASUREMENT PROCEDURE.....	10
4.2	TEST SET-UP (BLOCK DIAGRAM OF CONFIGURATION).....	10
4.3	MEASUREMENT EQUIPMENT USED.....	10
4.4	CONDUCTED EMISSION LIMIT.....	10
4.5	MEASUREMENT RESULT.....	11
4.6	CONDUCTED MEASUREMENT PHOTO.....	14
5	RADIATED EMISSION TEST.....	15
5.1	MEASUREMENT PROCEDURE.....	15
5.2	TEST SET-UP (BLOCK DIAGRAM OF CONFIGURATION).....	15
5.3	MEASUREMENT EQUIPMENT USED.....	16
5.4	RADIATED EMISSION LIMIT.....	16
5.5	MEASUREMENT RESULT.....	18
5.6	RADIATED MEASUREMENT PHOTOS.....	21
6	20DB BANDWIDTH.....	22
6.1	20DB BANDWIDTH LIMIT.....	22
6.2	TEST INSTRUMENTS.....	22
6.3	TEST PROCEDURE.....	22
6.4	TEST SETUP.....	22
6.5	TEST RESULT.....	22
7	ANTENNA APPLICATION.....	24
7.1	ANTENNA REQUIREMENT.....	24
7.2	RESULT.....	24
8	PHOTOS OF EUT.....	24

1 General Information

1.1 Product Description

Characteristics	Description
Product Name	Wireless Charging Clock Speaker with Dual USB Charging
Model number	HWL83
Operation Mode	Qi-5W Wireless Charging
Input Rating	DC 9V from adapter
Power Supply	AC120V/60Hz for adapter
Adapter	M/N: WHDOE-09035 Input: 100-240V~ 50/60Hz 0.65A Max Output: DC 9V 3.5A
Operating Frequency	110-148KHz
Modulation Technique	Induction
Antenna Type	Induction coil
Product Software Version	HWL-83BT MAIN REV-3
Product Hardware version	U23
Radio Software Version	BT_BK6988V2.3P40.8M,WPT_V1.8.3.9
Radio Hardware version	BT_V2.3,WPT_REV-00

1.2 Related Submittal(s) / Grant(s)

This submittal(s) (test report) is intended for FCC ID: EMOHWL83N filing to comply with the FCC Part 15, Subpart C Rules.

1.3 Test Methodology

Both conducted and radiated testing was performed according to the procedures in ANSI C63.10 (2013). Radiated testing was performed at an antenna to EUT distance 3 meters.

1.4 Special Accessories

Not available for this EUT intended for grant.

1.5 Equipment Modifications

Not available for this EUT intended for grant.

1.6 Test Facility

Site Description
EMC Lab. : Accredited by CNAS, 2016.10.24
The certificate is valid until 2022.10.28
The Laboratory has been assessed and proved to be in compliance with
CNAS-CL01:2006 (identical to ISO/IEC 17025:2005)
The Certificate Registration Number is L2291.

Accredited by TUV Rheinland Shenzhen 2016.5.19
The Laboratory has been assessed according to the requirements ISO/IEC
17025.

Accredited by FCC, August 03, 2017
Designation Number: CN1204
Test Firm Registration Number: 882943

Accredited by Industry Canada, November 24, 2015
The Certificate Registration Number is 4480A.

Accredited by A2LA, July 31, 2017
The Certificate Number is 4321.01.

Name of Firm : EMTEK(SHENZHEN) CO., LTD.
Site Location : Bldg 69, Majialong Industry Zone, Nanshan District, Shenzhen,
Guangdong, China.

2 System Test Configuration

2.1 EUT Configuration

The EUT configuration for testing is installed on RF field strength measurement to meet the Commissions requirement and operating in a manner which intends to maximize its emission characteristics in a continuous normal application.

2.2 EUT Exercise

The Transmitter was operated in the normal operating mode. The TX frequency was fixed which was for the purpose of the measurements.

2.3 Test Procedure

2.3.1 Conducted Emissions

The EUT is placed on a turn table which is 0.8 m above ground plane. According to the requirements in Section 13.1.4.1 of ANSI C63.10-2013 Conducted emissions from the EUT measured in the frequency range between 0.15 MHz and 30 MHz using CISPR Quasi-Peak and average detector mode.

2.3.2 Radiated Emissions

The EUT is placed on a turn table which is 0.8 m above ground plane. The turn table shall rotate 360 degrees to determine the position of maximum emission level. EUT is set 3m away from the receiving antenna which varied from 1m to 4m to find out the highest emission. And also, each emission was to be maximized by changing the polarization of receiving antenna both horizontal and vertical. In order to find out the max. emission, the fixed in a particular direction according to the requirements in Section 13.1.4.1 of ANSI C63.10-2013.

2.4 Configuration of Tested System

Fig. 2-1 Configuration of Tested System

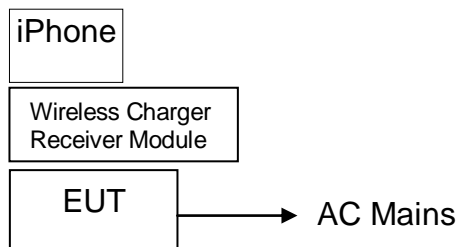

Table 2-1 Equipment Used in Tested System

Item	Equipment	Trade Mark	Model No.	FCC ID	Note
1.	Wireless Charging Clock Speaker with Dual USB Charging	iHome	HWL83	EMOHWL83N	<i>EUT</i>
2.	Adapter	N/A	WHDOE-09035	N/A	<i>Support EUT</i>
3.	iPhone	Apple	A1524	N/A	<i>Support Equipment</i>
4.	Wireless Charger Receiver Module	Universal	N/A	N/A	<i>Support Equipment</i>

Note:

- (1) Unless otherwise denoted as EUT in 『Remark』 column, device(s) used in tested system is a support equipment.

3 Summary of Test Results

FCC Rules	Description Of Test	Result
§15.207	AC Power Conducted Emission	Compliant
§15.209	Radiated Emission	Compliant
§2.1049	20dB Bandwidth	Compliant
§15.203	Antenna Requirement	Compliant

4 Description of test modes

Channel	Frequency(KHz)
Low frequency	110
Mid frequency	125
High frequency	148

Conducted Emissions Test

4.1 Measurement Procedure

1. The EUT was placed on a table which is 0.8m above ground plane.
2. Maximum procedure was performed on the six highest emissions to ensure EUT compliance.
3. Repeat above procedures until all frequency measured was complete.

4.2 Test SET-UP (Block Diagram of Configuration)

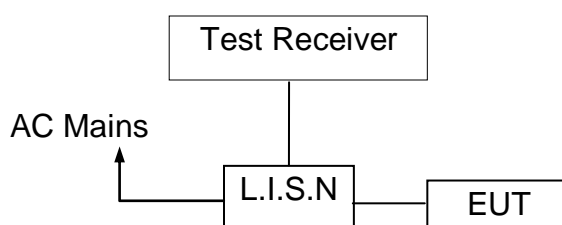

4.3 Measurement Equipment Used

Conducted Emission Test Site					
EQUIPMENT TYPE	MFR	MODEL NUMBER	SERIAL NUMBER	Last Cal.	Due date
Test Receiver	Rohde & Schwarz	ESCS30	100018	05/16/2018	05/15/2019
L.I.S.N	Rohde & Schwarz	ENV216	100017	05/16/2018	05/15/2019
RF Switching Unit	CDS	RSU-M2	38401	05/16/2018	05/15/2019
Coaxial Cable	CDS	79254	46107086	05/16/2018	05/15/2019

4.4 Conducted Emission Limit

Conducted Emission Frequency(MHz)	Quasi-peak	Average
0.15-0.5	66-56	56-46
0.5-5.0	56	46
5.0-30.0	60	50

- Note:** 1. The lower limit shall apply at the transition frequencies
 2. The limit decreases in line with the logarithm of the frequency in the range of 0.15 to 0.50MHz.

4.5 Measurement Result

Operation Mode:	TX	Test Date :	September 18, 2018
Frequency Range:	0.15MHz~30MHz	Temperature :	28°C
Test Result:	PASS	Humidity :	65 %
Test By:	Yaping Shen		

Pass

We pretested three modes (max load, mid load, min load) for EUT. The worst mode (max load) test data see follow the table.

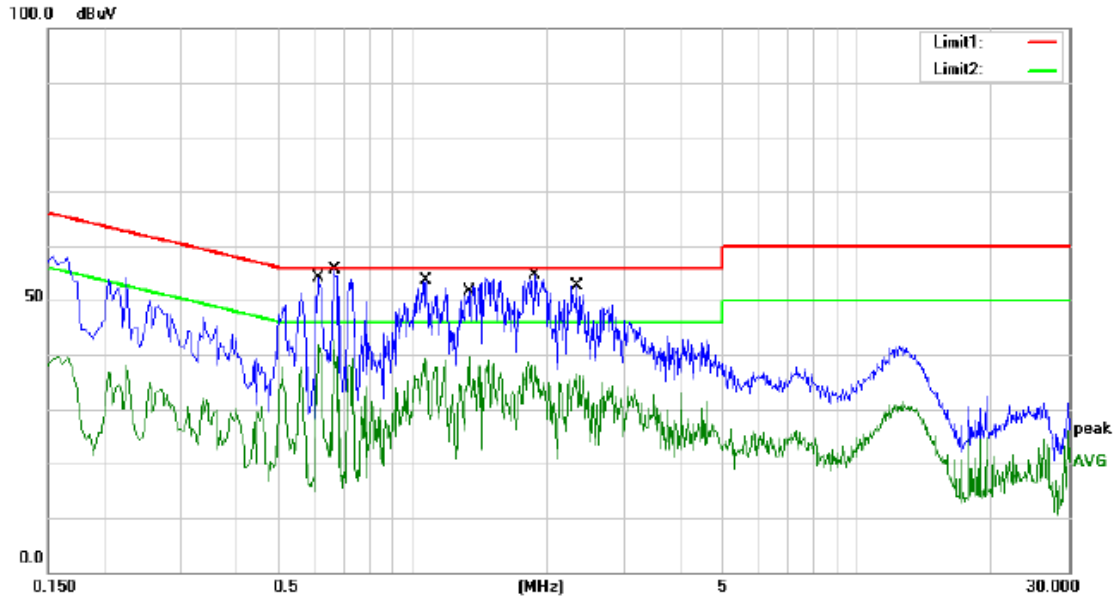

Site site #1 Phase: **N** Temperature: 25
 Limit: (CE)FCC PART 15 C QP Power: AC 120V/60Hz Humidity: 55 %
 Mode: Wireless charging(5W)
 Note:

No.	Mk.	Freq.	Reading Level	Correct Factor	Measurement	Limit	Over	Detector	Comment
		MHz	dBuV	dB	dBuV	dBuV	dB		
1		0.6100	41.36	9.84	51.20	56.00	-4.80	QP	
2		0.6100	32.15	9.84	41.99	46.00	-4.01	AVG	
3		0.6620	42.26	9.84	52.10	56.00	-3.90	QP	
4	*	0.6620	32.67	9.84	42.51	46.00	-3.49	AVG	
5		1.0700	39.56	9.84	49.40	56.00	-6.60	QP	
6		1.0700	29.54	9.84	39.38	46.00	-6.62	AVG	
7		1.3340	37.76	9.84	47.60	56.00	-8.40	QP	
8		1.3340	29.87	9.84	39.71	46.00	-6.29	AVG	
9		1.8780	40.26	9.84	50.10	56.00	-5.90	QP	
10		1.8780	28.74	9.84	38.58	46.00	-7.42	AVG	
11		2.3380	36.16	9.84	46.00	56.00	-10.00	QP	
12		2.3380	26.54	9.84	36.38	46.00	-9.62	AVG	

*:Maximum data x:Over limit l:over margin Comment: Factor build in receiver. Operator: Yaping shen

4.6 Conducted Measurement Photo



5 Radiated Emission Test

5.1 Measurement Procedure

1. The EUT was placed on a turn table which is 0.8m above ground plane.
2. Maximum procedure was performed on the six highest emissions to ensure EUT compliance.
3. And also, each emission was to be maximized by changing the polarization of receiving antenna both horizontal and vertical.
4. Repeat above procedures until all frequency measured were complete.

5.2 Test SET-UP (Block Diagram of Configuration)

(A) Radiated Emission Test Set-Up, Frequency Below 30MHz

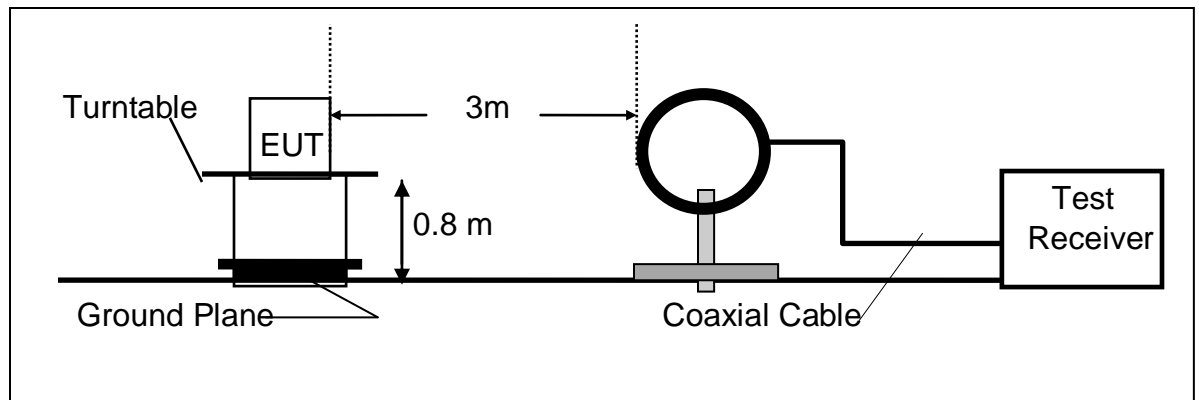

(B) Radiated Emission Test Set-Up, Frequency Below 1000MHz

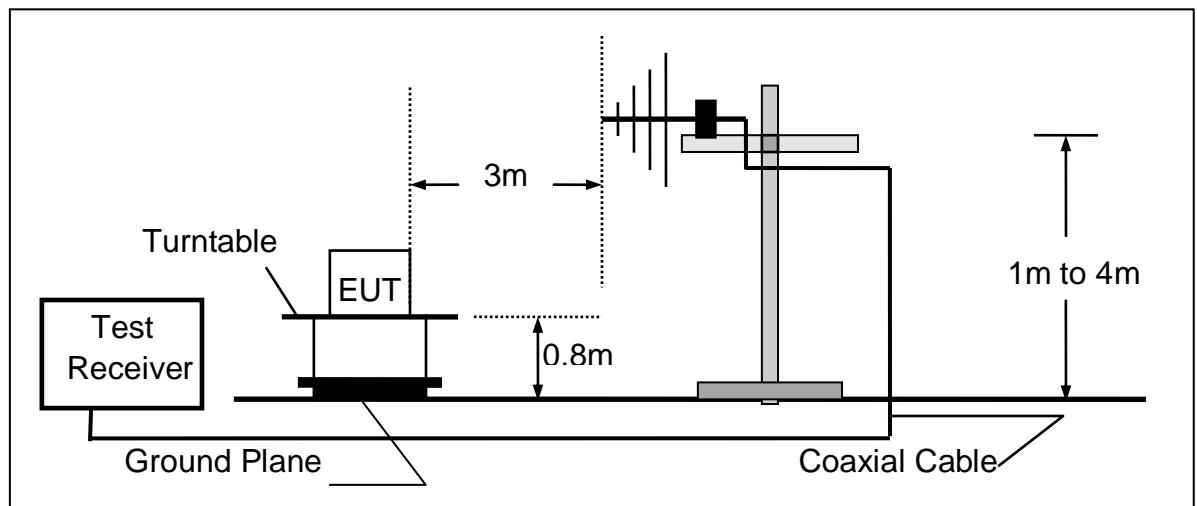

5.3 Measurement Equipment Used

Equipment	Manufacturer	Model No.	Serial No.	Last Cal.	Due date
Test Receiver	Rohde & Schwarz	ESCI	1166.5950.03	05/16/2018	05/15/2019
Signal Analyzer	Rohde & Schwarz	FSV30	103040	05/16/2018	05/15/2019
Loop Antenna	Schwarzbeck	FMZB 1519	012	05/16/2018	05/15/2019
Bilog Antenna	Schwarzbeck	VULB9163	000141	05/16/2018	05/15/2019
Power Amplifier	CDS	RSU-M352	818	05/16/2018	05/15/2019
Power Amplifier	HP	8447F	OPT H64	05/16/2018	05/15/2019
Color Monitor	SUNSP0	SP-140A	N/A	05/16/2018	05/15/2019
Single Line Filter	JIANLI	XL-3	N/A	05/16/2018	05/15/2019
Single Phase Power Line Filter	JIANLI	DL-2X100B	N/A	05/16/2018	05/15/2019
3 Phase Power Line Filter	JIANLI	DL-4X100B	N/A	05/16/2018	05/15/2019
DC Power Filter	JIANLI	DL-2X50B	N/A	05/16/2018	05/15/2019
Cable	Schwarzbeck	PLF-100	549489	05/16/2018	05/15/2019
Cable	Rosenberger	CIL02	A0783566	05/16/2018	05/15/2019
Cable	Rosenberger	RG 233/U	525178	05/16/2018	05/15/2019

5.4 Radiated Emission Limit

The emissions from an intentional radiator shall not exceed the field strength levels specified in the following table 15.209(a):

FCC Part 15.209				
Frequency (MHz)	Field Strength Limitation		Field Strength Limitation Frequency tion at 3m Measurement Dist	
	(uV/m)	Dist	(uV/m)	(dBuV/m)
0.009 – 0.490	2400 / F(KHz)	300m	10000 * 2400/F(KHz)	20log 2400/F(KHz) + 80
0.490 – 1.705	24000 / F(KHz)	30m	100 * 24000/F(KHz)	20log 24000/F(KHz) + 40
1.705 – 30.00	30	30m	100* 30	20log 30 + 40
30.0 – 88.0	100	3m	100	20log 100
88.0 – 216.0	150	3m	150	20log 150
216.0 – 960.0	200	3m	200	20log 200
Above 960.0	500	3m	500	20log 500

15.205 Restricted bands of operation

MHz	MHz	MHz	GHz
0.090 - 0.110	16.42 - 16.423	399.9 - 410	4.5 - 5.15
¹ 0.495 - 0.505	16.69475 - 16.69525	608 - 614	5.35 - 5.46
2.1735 - 2.1905	16.80425 - 16.80475	960 - 1240	7.25 - 7.75
4.125 - 4.128	25.5 - 25.67	1300 - 1427	8.025 - 8.5
4.17725 - 4.17775	37.5 - 38.25	1435 - 1626.5	9.0 - 9.2
4.20725 - 4.20775	73 - 74.6	1645.5 - 1646.5	9.3 - 9.5
6.215 - 6.218	74.8 - 75.2	1660 - 1710	10.6 - 12.7
6.26775 - 6.26825	108 - 121.94	1718.8 - 1722.2	13.25 - 13.4
6.31175 - 6.31225	123 - 138	2200 - 2300	14.47 - 14.5
8.291 - 8.294	149.9 - 150.05	2310 - 2390	15.35 - 16.2
8.362 - 8.366	156.52475 - 156.52525	2483.5 - 2500	17.7 - 21.4
8.37625 - 8.38675	156.7 - 156.9	2690 - 2900	22.01 - 23.12
8.41425 - 8.41475	162.0125 - 167.17	3260 - 3267	23.6 - 24.0
12.29 - 12.293	167.72 - 173.2	3332 - 3339	31.2 - 31.8
12.51975 - 12.52025	240 - 285	3345.8 - 3358	36.43 - 36.5
12.57675 - 12.57725	322 - 335.4	3600 - 4400	(²)

- Remark:
1. Emission level in dBuV/m=20 log (uV/m)
 2. Measurement was performed at an antenna to the closed point of EUT distance of meters.
 3. Only spurious frequency is permitted to locate within the Restricted Bands specified in provision of ξ 15.205, and the emissions located in restricted bands also comply with 15.209 limit.

5.5 Measurement Result

We three modes (max load, mid load, min load) for EUT. The worst mode (max load) and worst test frequency(High frequency: 146KHz)test data see follow the table.

Operation Mode:	Low frequency	Test Date :	September 18, 2018
Frequency Range:	9KHz~30MHz	Temperature :	20°C
Test Result:	PASS	Humidity :	55 %
Measured Distance:	3m	Test By:	Yaping Shen

Freq. (MHz)	Ant.Pol. H/V	Emission Level (dBuV/m)	Limit 3m (dBuV/m)	Over (dB)	Note
0.14635(F)	H	75.63	104.30	-28.67	PK
0.2927	H	63.42	98.28	-34.86	PK
0.43905	H	63.15	94.75	-31.60	PK
0.5854	H	62.77	72.26	-9.49	PK
0.73175	H	61.65	70.32	-8.67	PK
0.14635(F)	V	75.78	104.30	-28.52	PK
0.2927	V	64.26	98.28	-34.02	PK
0.43905	V	64.16	94.75	-30.59	PK
0.5854	V	64.53	72.26	-7.73	PK
0.73175	V	62.36	70.32	-7.96	PK

- Note:**
- (1) All Readings are Peak Value.
 - (2) Emission Level= Reading Level+Probe Factor +Cable Loss.
 - (3) The average measurement was not performed when the peak measured data under the limit of average detection.
 - (4) EUT lying on the table position is the worst case result in the report.

We pretested three modes (max load, mid load, min load) for EUT. The worst mode (max load) and worst test frequency(High frequency: 146KHz)test data see follow the page.



Site Chamber #1 Polarization: *Horizontal* Temperature: 26
 Limit: (RE)FCC PART 15 C 3m Power: AC 120V/60Hz Humidity: 55 %
 Mode: Wireless Charging
 Note:

No.	Mk.	Freq.	Reading Level	Correct Factor	Measurement	Limit	Over	Antenna Height	Table Degree
		MHz	dBuV	dB	dBuV/m	dBuV/m	dB	cm	degree
1		47.4600	39.16	-15.69	23.47	40.00	-16.53	QP	
2	*	79.4700	51.24	-21.55	29.69	40.00	-10.31	QP	
3		150.5378	51.77	-21.49	30.28	43.50	-13.22	QP	
4		171.6200	47.59	-20.11	27.48	43.50	-16.02	QP	
5		265.7100	47.68	-14.81	32.87	46.00	-13.13	QP	
6		397.6300	38.12	-11.13	26.99	46.00	-19.01	QP	

*:Maximum data x:Over limit !:over margin Comment: Factor build in receiver. Operator: Yaping shen

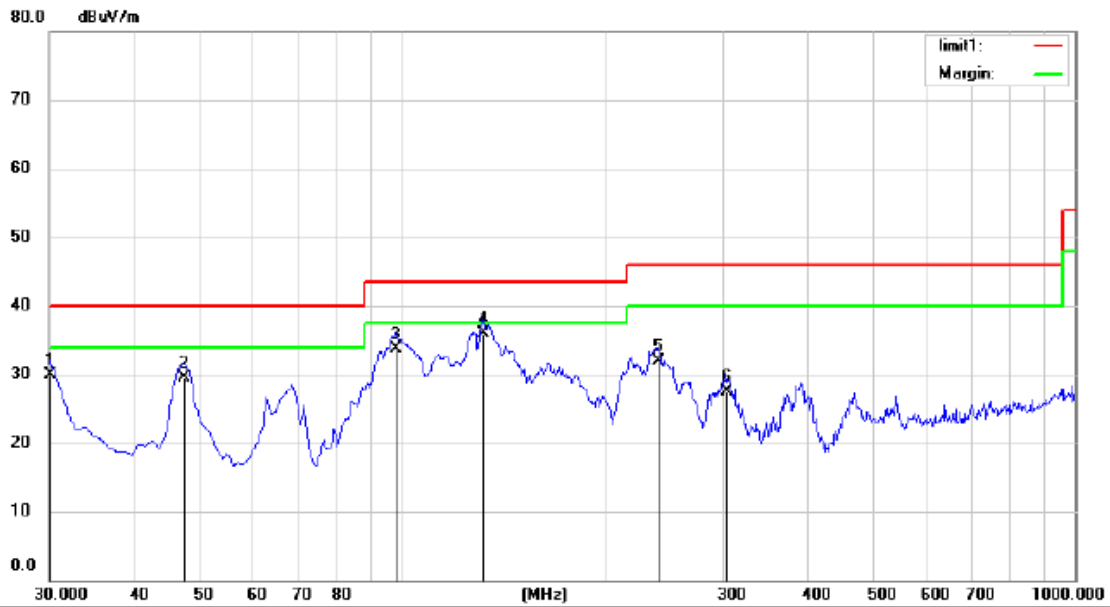

Site Chamber #1 Polarization: *Vertical* Temperature: 26
 Limit: (RE)FCC PART 15 C 3m Power: AC 120V/60Hz Humidity: 55 %
 Mode: Wireless Charging
 Note:

No.	Mk.	Freq.	Reading Level	Correct Factor	Measurement	Limit	Over	Antenna Height	Table Degree
		MHz	dBuV	dB	dBuV/m	dBuV/m	dB	cm	degree
1		30.0000	48.75	-18.76	29.99	40.00	-10.01	QP	
2		47.4600	45.21	-15.69	29.52	40.00	-10.48	QP	
3		97.9000	54.32	-20.55	33.77	43.50	-9.73	QP	
4	*	131.8500	55.11	-19.19	35.92	43.50	-7.58	QP	
5		240.4900	47.69	-15.81	31.88	46.00	-14.12	QP	
6		303.5400	42.35	-14.79	27.56	46.00	-18.44	QP	

*:Maximum data x:Over limit !:over margin Comment: Factor build in receiver. Operator: Yaping shen

5.6 Radiated Measurement Photos

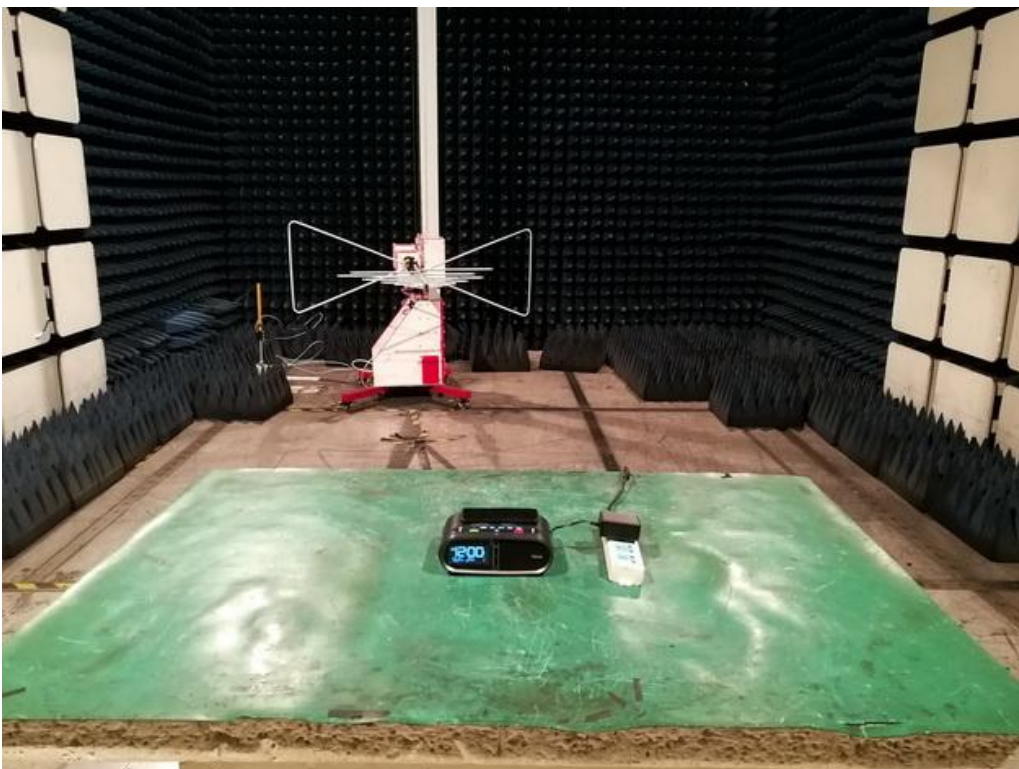
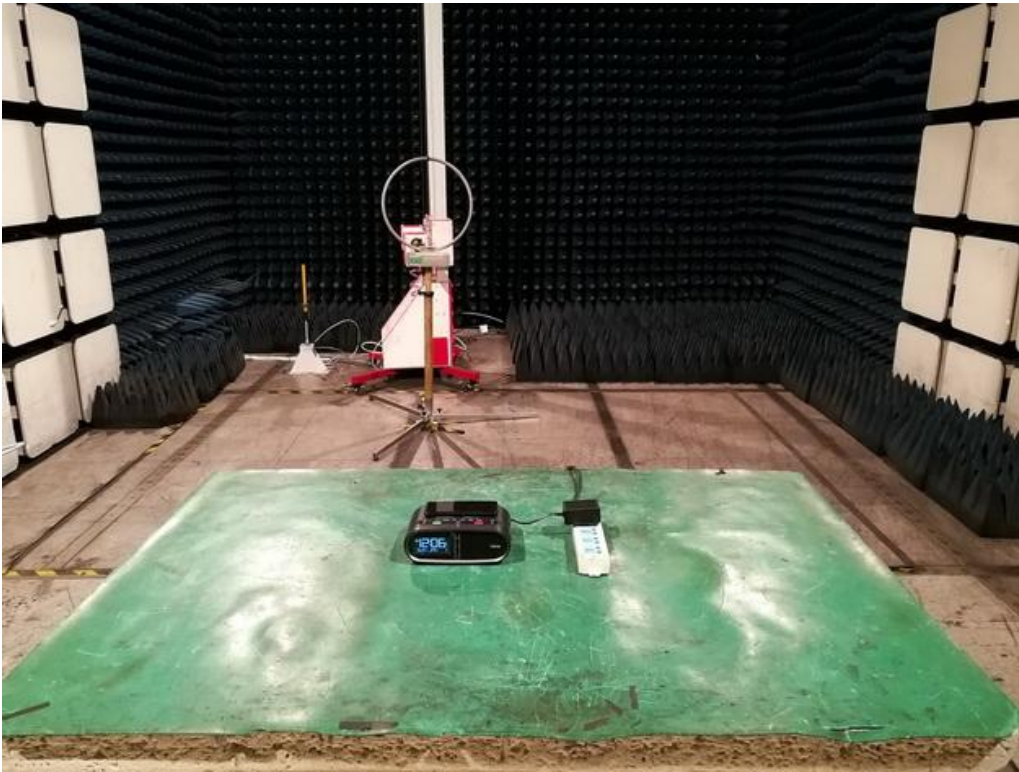

6 20db Bandwidth

6.1 20dB Bandwidth Limit

None: for reporting purposed only.

6.2 Test Instruments

Refer a test equipment and calibration data table in this test report.

6.3 Test Procedure

The bandwidth of the fundamental frequency was measured by spectrum analyzer with 10Hz RBW and 30Hz VBW. The 20dB bandwidth is defined as the total spectrum the power of which is higher than peak power minus 20dB.

6.4 Test Setup

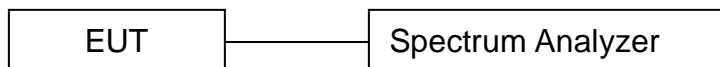

6.5 Test Result

Frequency (KHz)	20dB Bandwidth (Hz)	Results
146.35	73.93	PASS

20 dB Bandwidth Test plot

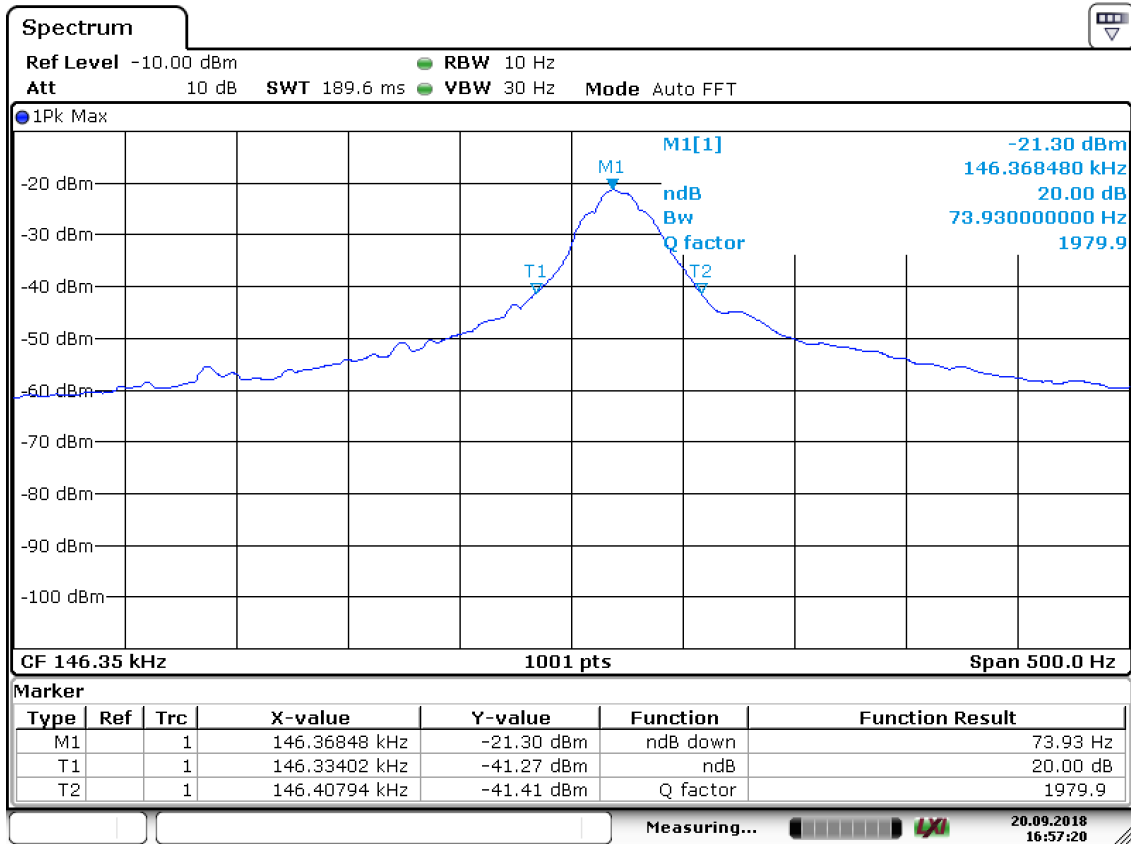

7 Antenna Application

7.1 Antenna requirement

For intentional device, according to FCC 47 CFR Section 15.203, an intentional radiator shall be designed to ensure that no antenna other than that furnished by the responsible party shall be used with the device.

7.2 Result

The EUT's antenna, permanent attached antenna, used an Induction coil and integrated on PCB, The antenna's gain meets the requirement.

8 Photos of EUT

Please refer to external photos.pdf and internal photos.pdf.