

**ELECTROMAGNETIC EMISSIONS COMPLIANCE REPORT
INTENTIONAL RADIATOR CERTIFICATION TO
FCC PART 15 SUBPART C REQUIREMENT**

OF

**Wireless Qi Charging Bedside Clock Stereo Speaker with Single Day
Alarm and Dual USB Charging**

**Model No.: HW5, HW5B, HW5X (X would be any alphabet denotes
different cabinet color)**

Trademark: iHome

FCC ID: EMOHW5

Report No.: ES191210026E1

Issue Date: December 21, 2019

Prepared for

**SDI TECHNOLOGIES INC.
1299, Main Street, Rahway, NJ 07065, U.S.A.**

Prepared by

EMTEK(SHENZHEN) CO., LTD.

**Bldg 69, Majialong Industry Zone, Nanshan District, Shenzhen,
Guangdong, China.**

**TEL: 86-769-22807078
FAX: 86-769-22807079**

**This report shall not be reproduced, except in full, without the written approval of
EMTEK(SHENZHEN) CO., LTD.**

VERIFICATION OF COMPLIANCE

Applicant:	SDI Technologies Inc. 1299, Main Street, Rahway, NJ 07065, U.S.A.
Manufacturer:	Hotel Technologies, Inc 1299 Main Street, Rahway, NJ 07065, U.S.A
Product Description:	Wireless Qi Charging Bedside Clock Stereo Speaker with Single Day Alarm and Dual USB Charging
Trade Mark:	iHome
Model Number:	HW5, HW5B, HW5X (X would be any alphabet denotes different cabinet color) (Note: The samples are the same except difference color of appearance and model number, Here HW5 was selected for full test.)

We hereby certify that:

The above equipment was tested by EMTEK(SHENZHEN) CO., LTD. The test data, data evaluation, test procedures, and equipment configurations shown in this report were made in accordance with the procedures given in ANSI C63.10-2013 and the energy emitted by the sample EUT tested as described in this report is in compliance with conducted and radiated emission limits of FCC Rules Part 15C.

Date of Test : December 10, 2019 to December 21, 2019

Prepared by : 
Loren Luo /Editor

Reviewer : 
Tim Dong /Supervisor

Approved & Authorized Signer : 
Lisa Wang /Manager



Modified Information

Version	Summary	Revision Date	Report No.
Ver.1.0	Original Report	/	ES191210026E1



Table of Contents

1	GENERAL INFORMATION.....	5
1.1	PRODUCT DESCRIPTION.....	5
1.2	RELATED SUBMITTAL(S) / GRANT(S).....	6
1.3	TEST METHODOLOGY.....	6
1.4	SPECIAL ACCESSORIES.....	6
1.5	EQUIPMENT MODIFICATIONS.....	6
1.6	TEST FACILITY.....	6
2	SYSTEM TEST CONFIGURATION.....	7
2.1	EUT CONFIGURATION.....	7
2.2	EUT EXERCISE.....	7
2.3	TEST PROCEDURE.....	7
2.4	CONFIGURATION OF TESTED SYSTEM.....	8
3	SUMMARY OF TEST RESULTS.....	8
4	DESCRIPTION OF TEST MODES.....	9
5	CONDUCTED EMISSIONS TEST.....	10
5.1	MEASUREMENT PROCEDURE.....	10
5.2	TEST SET-UP (BLOCK DIAGRAM OF CONFIGURATION).....	10
5.3	MEASUREMENT EQUIPMENT USED.....	10
5.4	CONDUCTED EMISSION LIMIT.....	10
5.5	MEASUREMENT RESULT.....	11
6	RADIATED EMISSION TEST.....	14
6.1	MEASUREMENT PROCEDURE.....	14
6.2	TEST SET-UP (BLOCK DIAGRAM OF CONFIGURATION).....	14
6.3	MEASUREMENT EQUIPMENT USED.....	15
6.4	RADIATED EMISSION LIMIT.....	15
6.5	MEASUREMENT RESULT.....	17
7	20DB BANDWIDTH.....	20
7.1	20DB BANDWIDTH LIMIT.....	20
7.2	TEST INSTRUMENTS.....	20
7.3	TEST PROCEDURE.....	20
7.4	TEST SETUP.....	20
7.5	TEST RESULT.....	20
8	ANTENNA APPLICATION.....	22
8.1	ANTENNA REQUIREMENT.....	22
8.2	RESULT.....	22
9	PHOTOS OF EUT.....	22

1 General Information

1.1 Product Description

Characteristics	Description
Product Name	Wireless Qi Charging Bedside Clock Stereo Speaker with Single Day Alarm and Dual USB Charging
Model number	HW5, HW5B, HW5X (X would be any alphabet denotes different cabinet color)
Input Rating	DC 12V from adapter
Power Supply	AC120V/60Hz for adapter
Adapter	Model : BQ60A-1205000-U Input: AC 100-240V, 50/60Hz 1500mA Max Output: DC 12V, 5000mA
Operating Frequency	110-148kHz
Wireless Charing Power	9W
Product Software Version	V12
Product Hardware version	V01
Modulation Technique	Induction
Antenna Type	Induction coil

1.2 Related Submittal(s) / Grant(s)

This submittal(s) (test report) is intended for FCC ID: EMOHW5 filing to comply with the FCC Part 15, Subpart C Rules.

1.3 Test Methodology

Both conducted and radiated testing was performed according to the procedures in ANSI C63.10 (2013). Radiated testing was performed at an antenna to EUT distance 3 meters.

1.4 Special Accessories

Not available for this EUT intended for grant.

1.5 Equipment Modifications

Not available for this EUT intended for grant.

1.6 Test Facility

Site Description
EMC Lab. : Accredited by CNAS, 2016.10.24
The certificate is valid until 2022.10.28
The Laboratory has been assessed and proved to be in compliance with
CNAS-CL01:2006 (identical to ISO/IEC 17025:2005)
The Certificate Registration Number is L2291.

Accredited by TUV Rheinland Shenzhen 2016.5.19
The Laboratory has been assessed according to the requirements ISO/IEC
17025.

Accredited by FCC, August 03, 2017
Designation Number: CN1204
Test Firm Registration Number: 882943

Accredited by Industry Canada, November 24, 2015
The Certificate Registration Number is 4480A.

Accredited by A2LA, July 31, 2017
The Certificate Number is 4321.01.

Name of Firm : EMTEK(SHENZHEN) CO., LTD.
Site Location : Bldg 69, Majjalong Industry Zone, Nanshan District, Shenzhen,
Guangdong, China.

2 System Test Configuration

2.1 EUT Configuration

The EUT configuration for testing is installed on RF field strength measurement to meet the Commissions requirement and operating in a manner which intends to maximize its emission characteristics in a continuous normal application.

2.2 EUT Exercise

The Transmitter was operated in the normal operating mode. The TX frequency was fixed which was for the purpose of the measurements.

2.3 Test Procedure

2.3.1 Conducted Emissions

The EUT is a placed on as turn table which is 0.8 m above ground plane. According to the requirements in Section 13.1.4.1 of ANSI C63.10-2013 Conducted emissions from the EUT measured in the frequency range between 0.15 MHz and 30 MHz using CISPR Quasi-Peak and average detector mode.

2.3.2 Radiated Emissions

The EUT is a placed on as turn table which is 0.8 m above ground plane. The turn table shall rotate 360 degrees to determine the position of maximum emission level. EUT is set 3m away from the receiving antenna which varied from 1m to 4m to find out the highest emission. And also, each emission was to be maximized by changing the polarization of receiving antenna both horizontal and vertical. In order to find out the max. emission, the fixed in a particular direction according to the requirements in Section 13.1.4.1 of ANSI C63.10-2013.

2.4 Configuration of Tested System

Fig. 2-1 Configuration of Tested System

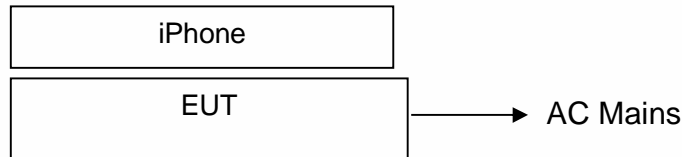

Table 2-1 Equipment Used in Tested System

Item	Equipment	Trade Mark	Model No.	FCC ID	Note
1.	Wireless Qi Charging Bedside Clock Stereo Speaker with Single Day Alarm and Dual USB Charging	iHome	HW5	EMOHW5	EUT
2.	Adapter	iHome	BQ30A-09025 00-U	N/A	Support EUT
3.	iPhone	Apple	A1524	N/A	Support Equipment

Note:

- (1) Unless otherwise denoted as EUT in 『Remark』 column, device(s) used in tested system is a support equipment.

3 Summary of Test Results

FCC Rules	Description Of Test	Result
§15.207	AC Power Conducted Emission	Compliant
§15.209	Radiated Emission	Compliant
§2.1049	20dB Bandwidth	Compliant
§15.203	Antenna Requirement	Compliant

4 Description of test modes

Channel	Frequency(KHz)
Low frequency	110
Mid frequency	129
High frequency	148



5 Conducted Emissions Test

5.1 Measurement Procedure

1. The EUT was placed on a table which is 0.8m above ground plane.
2. Maximum procedure was performed on the six highest emissions to ensure EUT compliance.
3. Repeat above procedures until all frequency measured was complete.

5.2 Test SET-UP (Block Diagram of Configuration)

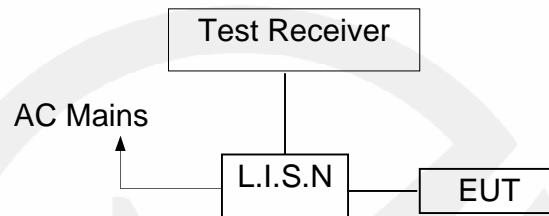

5.3 Measurement Equipment Used

Conducted Emission Test Site					
EQUIPMENT TYPE	MFR	MODEL NUMBER	SERIAL NUMBER	Last Cal.	Due date
Test Receiver	Rohde & Schwarz	ESCS30	100018	05/23/2019	05/22/2020
L.I.S.N	Rohde & Schwarz	ENV216	100017	05/23/2019	05/22/2020
RF Switching Unit	CDS	RSU-M2	38401	05/23/2019	05/22/2020
Coaxial Cable	CDS	79254	46107086	05/23/2019	05/22/2020

5.4 Conducted Emission Limit

Conducted Emission Frequency(MHz)	Quasi-peak	Average
0.15-0.5	66-56	56-46
0.5-5.0	56	46
5.0-30.0	60	50

- Note: 1. The lower limit shall apply at the transition frequencies
 2. The limit decreases in line with the logarithm of the frequency in the range of 0.15 to 0.50MHz.

5.5 Measurement Result

Operation Mode:	TX	Test Date :	December 20, 2019
Frequency Range:	0.15MHz~30MHz	Temperature :	28℃
Test Result:	PASS	Humidity :	65 %
Test By:	Loren		

Pass

We pretested three modes (max load, mid load, min load) for EUT. The worst mode (max load) test data see follow the table.



Wireless Charging

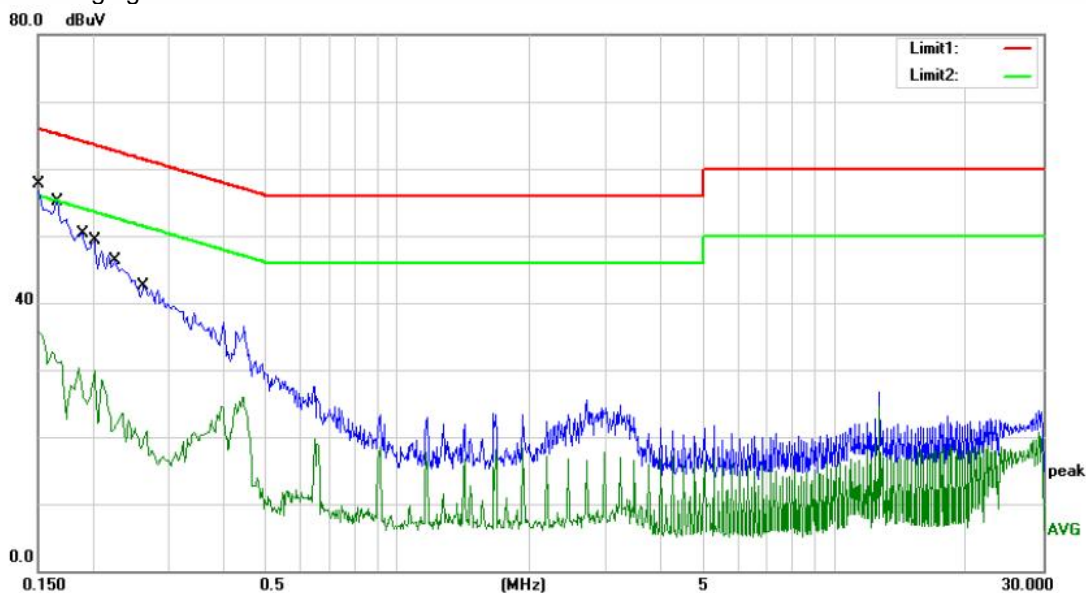

Site site #1 Phase: **N** Temperature: 25
 Limit: (CE)FCC PART 15 C_QP Power: AC 120V/60Hz Humidity: 55 %
 Mode: Wireless Charging
 Note:

No.	Mk.	Freq.	Reading Level	Correct Factor	Measurement	Limit	Over	Detector	Comment
		MHz	dBuV	dB	dBuV	dBuV	dB		
1	*	0.1500	44.62	9.78	54.40	66.00	-11.60	QP	
2		0.1500	25.96	9.78	35.74	56.00	-20.26	AVG	
3		0.1660	42.32	9.78	52.10	65.16	-13.06	QP	
4		0.1660	22.80	9.78	32.58	55.16	-22.58	AVG	
5		0.1900	37.41	9.79	47.20	64.04	-16.84	QP	
6		0.1900	15.98	9.79	25.77	54.04	-28.27	AVG	
7		0.2020	36.51	9.79	46.30	63.53	-17.23	QP	
8		0.2020	20.03	9.79	29.82	53.53	-23.71	AVG	
9		0.2260	33.41	9.79	43.20	62.60	-19.40	QP	
10		0.2260	11.88	9.79	21.67	52.60	-30.93	AVG	
11		0.2620	29.70	9.80	39.50	61.37	-21.87	QP	
12		0.2620	11.19	9.80	20.99	51.37	-30.38	AVG	

*:Maximum data x:Over limit !:over margin Comment: Factor build in receiver. Operator: HUANG

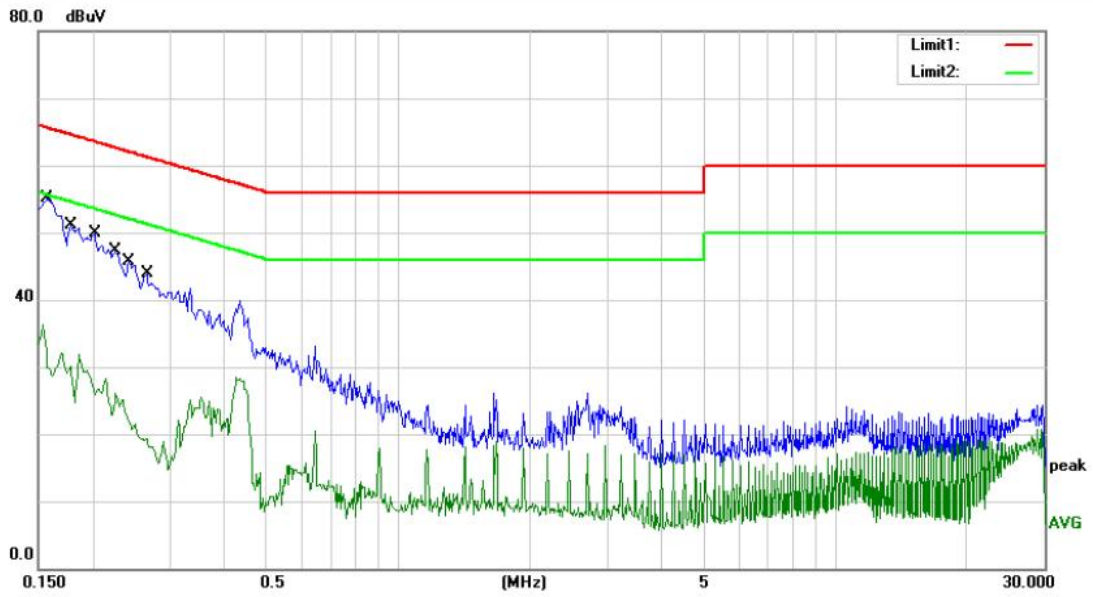

Site site #1 Phase: **L1** Temperature: 25
 Limit: (CE)FCC PART 15 C_QP Power: AC 120V/60Hz Humidity: 55 %
 Mode: Wireless Charging
 Note:

No.	Mk.	Freq. MHz	Reading Level dBuV	Correct Factor dB	Measure- ment dBuV	Limit dBuV	Over dB	Detector	Comment
1	*	0.1580	42.34	9.78	52.12	65.57	-13.45	QP	
2		0.1580	26.55	9.78	36.33	55.57	-19.24	AVG	
3		0.1780	38.41	9.78	48.19	64.58	-16.39	QP	
4		0.1780	20.68	9.78	30.46	54.58	-24.12	AVG	
5		0.2020	37.11	9.79	46.90	63.53	-16.63	QP	
6		0.2020	19.50	9.79	29.29	53.53	-24.24	AVG	
7		0.2260	34.59	9.79	44.38	62.60	-18.22	QP	
8		0.2260	18.53	9.79	28.32	52.60	-24.28	AVG	
9		0.2420	32.84	9.80	42.64	62.03	-19.39	QP	
10		0.2420	12.61	9.80	22.41	52.03	-29.62	AVG	
11		0.2660	31.04	9.80	40.84	61.24	-20.40	QP	
12		0.2660	9.51	9.80	19.31	51.24	-31.93	AVG	

*:Maximum data x:Over limit !:over margin Comment: Factor build in receiver. Operator: HUANG

6 Radiated Emission Test

6.1 Measurement Procedure

1. The EUT was placed on a turn table which is 0.8m above ground plane.
2. Maximum procedure was performed on the six highest emissions to ensure EUT compliance.
3. And also, each emission was to be maximized by changing the polarization of receiving antenna both horizontal and vertical.
4. Repeat above procedures until all frequency measured were complete.

6.2 Test SET-UP (Block Diagram of Configuration)

(A) Radiated Emission Test Set-Up, Frequency Below 30MHz

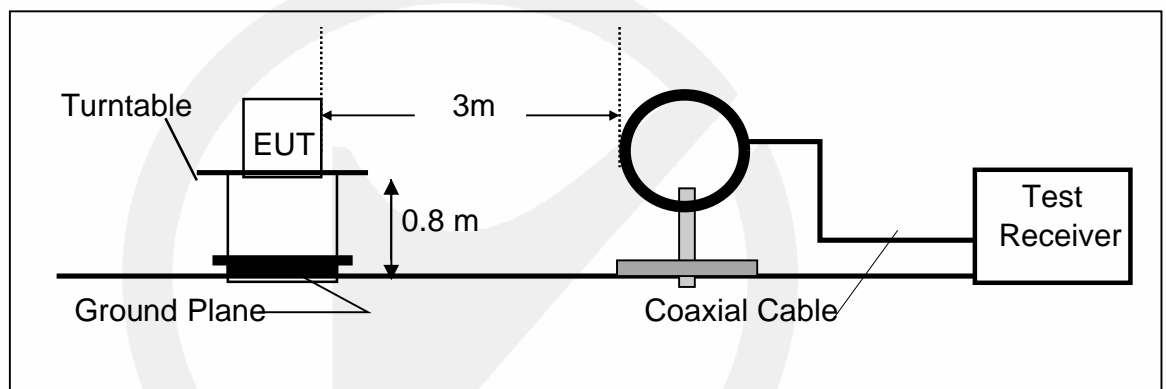

(B) Radiated Emission Test Set-Up, Frequency Below 1000MHz

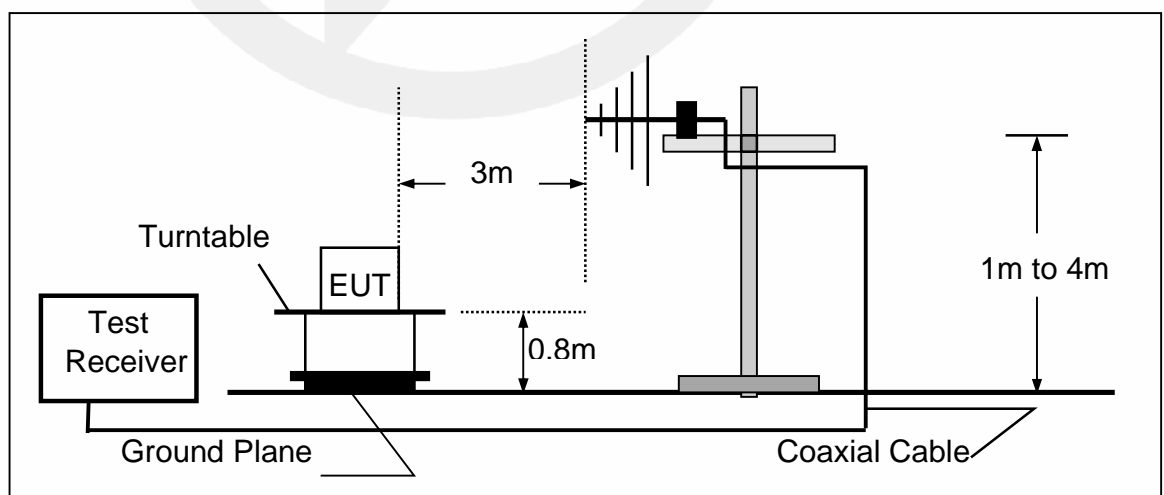

6.3 Measurement Equipment Used

Equipment	Manufacturer	Model No.	Serial No.	Last Cal.	Due date
Test Receiver	Rohde & Schwarz	ESCI	1166.5950.03	05/23/2019	05/22/2020
Signal Analyzer	Rohde & Schwarz	FSV30	103040	05/23/2019	05/22/2020
Loop Antenna	Schwarzbeck	FMZB 1519	012	05/23/2019	05/22/2020
Bilog Antenna	Schwarzbeck	VULB9163	000141	05/23/2019	05/22/2020
Power Amplifier	CDS	RSU-M352	818	05/23/2019	05/22/2020
Power Amplifier	HP	8447F	OPT H64	05/23/2019	05/22/2020
Color Monitor	SUNSP0	SP-140A	N/A	05/23/2019	05/22/2020
Single Line Filter	JIANLI	XL-3	N/A	05/23/2019	05/22/2020
Single Phase Power Line Filter	JIANLI	DL-2X100B	N/A	05/23/2019	05/22/2020
3 Phase Power Line Filter	JIANLI	DL-4X100B	N/A	05/23/2019	05/22/2020
DC Power Filter	JIANLI	DL-2X50B	N/A	05/23/2019	05/22/2020
Cable	Schwarzbeck	PLF-100	549489	05/23/2019	05/22/2020
Cable	Rosenberger	CIL02	A0783566	05/23/2019	05/22/2020
Cable	Rosenberger	RG 233/U	525178	05/23/2019	05/22/2020

6.4 Radiated Emission Limit

The emissions from an intentional radiator shall not exceed the field strength levels specified in the following table 15.209(a):

FCC Part 15.209				
Frequency (MHz)	Field Strength Limitation		Field Strength Limitation Frequency tion at 3m Measurement Dist	
	(uV/m)	Dist	(uV/m)	(dBuV/m)
0.009 – 0.490	2400 / F(KHz)	300m	10000 * 2400/F(KHz)	20log 2400/F(KHz) + 80
0.490 – 1.705	24000 / F(KHz)	30m	100 * 24000/F(KHz)	20log 24000/F(KHz) + 40
1.705 – 30.00	30	30m	100* 30	20log 30 + 40
30.0 – 88.0	100	3m	100	20log 100
88.0 – 216.0	150	3m	150	20log 150
216.0 – 960.0	200	3m	200	20log 200
Above 960.0	500	3m	500	20log 500

15.205 Restricted bands of operation

MHz	MHz	MHz	GHz
0.090 - 0.110	16.42 - 16.423	399.9 - 410	4.5 - 5.15
¹ 0.495 - 0.505	16.69475 - 16.69525	608 - 614	5.35 - 5.46
2.1735 - 2.1905	16.80425 - 16.80475	960 - 1240	7.25 - 7.75
4.125 - 4.128	25.5 - 25.67	1300 - 1427	8.025 - 8.5
4.17725 - 4.17775	37.5 - 38.25	1435 - 1626.5	9.0 - 9.2
4.20725 - 4.20775	73 - 74.6	1645.5 - 1646.5	9.3 - 9.5
6.215 - 6.218	74.8 - 75.2	1660 - 1710	10.6 - 12.7
6.26775 - 6.26825	108 - 121.94	1718.8 - 1722.2	13.25 - 13.4
6.31175 - 6.31225	123 - 138	2200 - 2300	14.47 - 14.5
8.291 - 8.294	149.9 - 150.05	2310 - 2390	15.35 - 16.2
8.362 - 8.366	156.52475 - 156.52525	2483.5 - 2500	17.7 - 21.4
8.37625 - 8.38675	156.7 - 156.9	2690 - 2900	22.01 - 23.12
8.41425 - 8.41475	162.0125 - 167.17	3260 - 3267	23.6 - 24.0
12.29 - 12.293	167.72 - 173.2	3332 - 3339	31.2 - 31.8
12.51975 - 12.52025	240 - 285	3345.8 - 3358	36.43 - 36.5
12.57675 - 12.57725	322 - 335.4	3600 - 4400	(²)

- Remark:
1. Emission level in dBuV/m=20 log (uV/m)
 2. Measurement was performed at an antenna to the closed point of EUT distance of meters.
 3. Only spurious frequency is permitted to locate within the Restricted Bands specified in provision of x 15.205, and the emissions located in restricted bands also comply with 15.209 limit.

6.5 Measurement Result

We pretested three modes (max load, mid load, min load) for EUT. The worst mode (max load) and worst test frequency(frequency: 127KHz)test data see follow the table.

Operation Mode:	Low frequency	Test Date :	December 20, 2019
Frequency Range:	9KHz~30MHz	Temperature :	20°C
Test Result:	PASS	Humidity :	55 %
Measured Distance:	3m	Test By:	Loren

Wireless Charging

Freq. (MHz)	Ant.Pol. H/V	Emission Level (dBuV/m)	Limit 3m (dBuV/m)	Over (dB)	Note
0.12722(F)	H	75.12	105.49	-30.37	PK
0.160	H	63.29	103.48	-40.19	PK
0.258	H	63.24	99.35	-36.11	PK
0.406	H	65.49	95.43	-29.94	PK
0.542	H	63.58	72.92	-9.34	PK
0.12722(F)	V	72.34	105.49	-33.15	PK
0.215	V	65.48	100.95	-35.47	PK
0.346	V	64.19	96.81	-32.62	PK
0.466	V	63.38	94.23	-30.85	PK
0.626	V	64.47	71.68	-7.21	PK

- Note:**
- (1) All Readings are Peak Value.
 - (2) Emission Level= Reading Level+Probe Factor +Cable Loss.
 - (3) The average measurement was not performed when the peak measured data under the limit of average detection.
 - (4) EUT lying on the table position is the worst case result in the report.

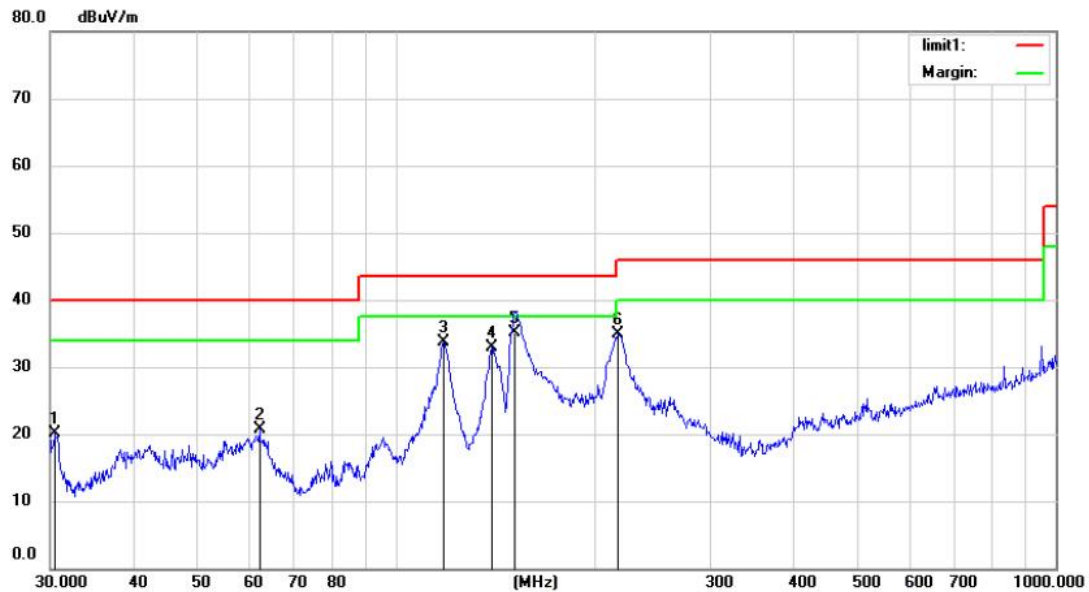

Site Chamber #1 Polarization: **Horizontal** Temperature: 26
 Limit: (RE)FCC PART 15 C 3m Power: AC 120V/60Hz Humidity: 55 %
 Mode: Wireless Charging
 Note:

No.	Mk.	Freq. MHz	Reading Level dBuV	Correct Factor dB	Measure- ment dBuV/m	Limit dBuV/m	Over dB	Antenna Height cm	Table Degree degree	Comment
1		30.4238	38.87	-18.81	20.06	40.00	-19.94	QP		
2		62.2128	38.08	-17.37	20.71	40.00	-19.29	QP		
3		118.1862	53.45	-19.66	33.79	43.50	-9.71	QP		
4		139.8508	54.44	-21.49	32.95	43.50	-10.55	QP		
5	*	151.5972	56.54	-21.36	35.18	43.50	-8.32	QP		
6		216.7828	51.90	-17.04	34.86	46.00	-11.14	QP		

*:Maximum data x:Over limit !:over margin

Operator: Lian



Site Chamber #1 Polarization: **Vertical** Temperature: 26
 Limit: (RE)FCC PART 15 C 3m Power: AC 120V/60Hz Humidity: 55 %
 Mode: Wireless Charging
 Note:

No.	Mk.	Freq.	Reading Level	Correct Factor	Measurement	Limit	Over	Antenna Height	Table Degree	
		MHz	dBuV	dB	dBuV/m	dBuV/m	dB	cm	degree	Comment
1	*	35.6240	49.55	-18.33	31.22	40.00	-8.78	QP		
2		118.1862	46.84	-19.66	27.18	43.50	-16.32	QP		
3		151.0666	54.08	-21.42	32.66	43.50	-10.84	QP		
4		199.9856	48.92	-17.25	31.67	43.50	-11.83	QP		
5		216.0240	48.16	-17.11	31.05	46.00	-14.95	QP		
6		952.0937	37.41	-0.47	36.94	46.00	-9.06	QP		

*:Maximum data x:Over limit !:over margin

Operator: Lian

7 20db Bandwidth

7.1 20dB Bandwidth Limit

None: for reporting purposed only.

7.2 Test Instruments

Refer a test equipment and calibration data table in this test report.

7.3 Test Procedure

The bandwidth of the fundamental frequency was measured by spectrum analyzer with 10Hz RBW and 30Hz VBW. The 20dB bandwidth is defined as the total spectrum the power of which is higher than peak power minus 20dB. The working mode (9W wireless charging)

7.4 Test Setup

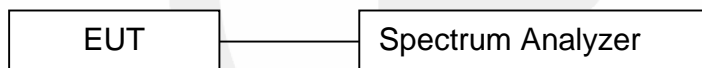

7.5 Test Result

Sumsung 9W Wireless Charging

Lowest frequency (KHz)	20dB Bandwidth (Hz)	Results
110.12	26.05	PASS

20 dB Bandwidth Test plot

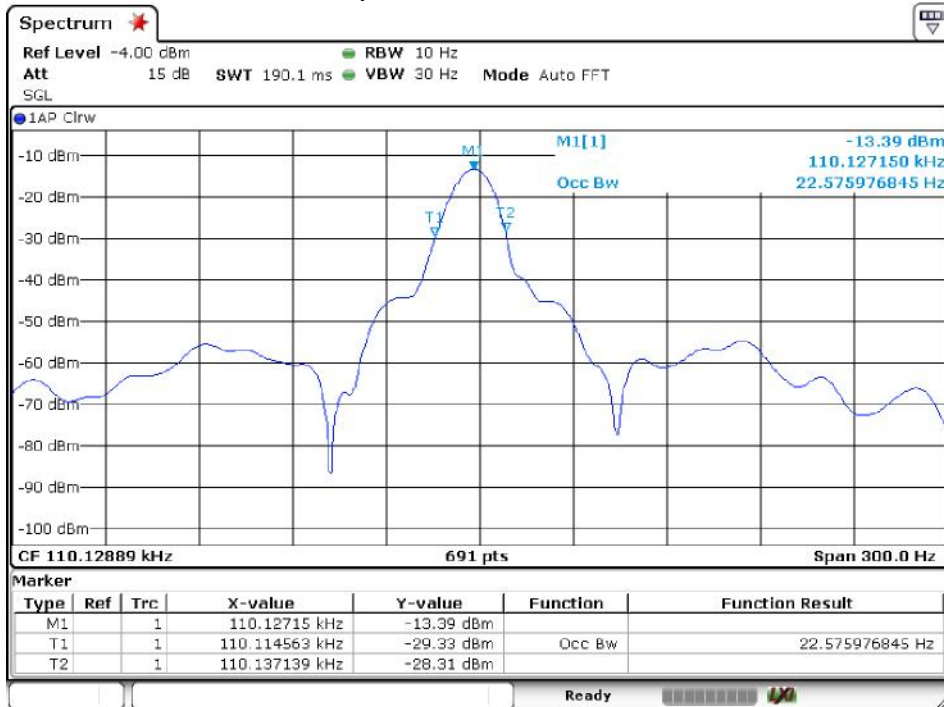

8 Antenna Application

8.1 Antenna requirement

For intentional device, according to FCC 47 CFR Section 15.203, an intentional radiator shall be designed to ensure that no antenna other than that furnished by the responsible party shall be used with the device.

8.2 Result

The EUT's antenna, permanent attached antenna, used an Induction coil and integrated on PCB, The antenna's gain meets the requirement.

9 Photos of EUT

Please refer to external photos and internal photos.

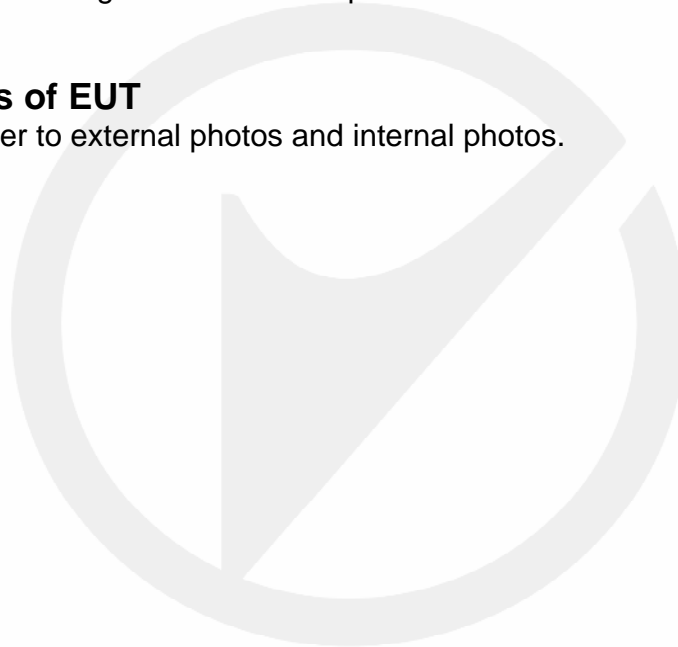

声明 Statement

1. 本报告无授权批准人签字及“检验报告专用章”无效；
This report will be void without authorized signature or special seal for testing report.
2. 未经许可本报告不得部分复制；
This report shall not be copied partly without authorization.
3. 本报告的检测结果仅对送测样品有效，委托方对样品的代表性和资料的真实性负责；
The test results or observations are applicable only to tested sample. Client shall be responsible for representativeness of the sample and authenticity of the material.
4. 本检测报告中检测项目标注有特殊符号则该项目不在资质认定范围内，仅作为客户委托、科研、教学或内部质量控制等目的使用；
The observations or tests with special mark fall outside the scope of accreditation, and are only used for purpose of commission, research, training, internal quality control etc.
5. 本检测报告以实测值进行符合性判定，未考虑不确定度所带来的风险，本实验室不承担相关责任，特别约定、标准或规范中有明确规定的除外；
The test results or observations are provided in accordance with measured value, without taking risks caused by uncertainty into account. Without explicit stipulation in special agreements, standards or regulations, EMTEK shall not assume any responsibility.
6. 对本检验报告若有异议，请于收到报告之日起 20 日内提出；
Objections shall be raised within 20 days from the date receiving the report.